



Fire Safety for Texans

Fire and Burn Prevention
Curriculum Guide Developed by
Texas State Fire Marshal's Office
Texas Department of Insurance

Kindergarten

Fire Safe Together

Fire Safety for Texans

The complete series from the State Fire Marshal's Office

Kindergarten

Fire Safe Together

First Grade

Fire Safety: Any Time, Any Place

Second Grade

Making Me Fire Safe

Third Grade

Positively Fire Safe

Fourth Grade

Fire Safety: Stop the Heat

Fifth Grade

Charged Up For Fire Safety

Sixth Grade

Fire Safety Power

Seventh Grade

Responsible For Fire Safety

Eighth Grade

Fire Safety's My Job

Health (High School)

A Lifetime For Fire Safety

Economics (High School)

Fire Safety For Consumers

Published Dec. 1993, revised August 2011. Texas State Fire Marshal's Office, Paul Maldonado, State Fire Marshal. PO Box 149221, Austin, TX 78714-9221, 512-305-7900. The State Fire Marshal's Office and the Texas Department of Insurance do not discriminate on the basis of race, color, national origin, sex, religion, age or disability in employment or activities. For additional fire prevention information, contact the State Fire Marshal's Office. This publication may be reproduced in its entirety. Such reproduction must include credit to the original producer, specifically the State Fire Marshal's Office. Copies of this publication have been distributed in compliance with the State Depository Law and are available for public use through the Texas State Publications Depository Program at the Texas State Library and other state depository libraries.

Introduction

Introduction

Why teach fire and burn prevention?

Each year during the past decade, about 150 Texans have died in fires. The State Fire Marshal's Office is committed to reducing this alarming statistic. Analysis of fire statistics shows that the vast majority of fires — and the resulting fire deaths — could have been prevented. Regretfully, most people do not know or practice even simple actions that can prevent fires and burns.

The State Fire Marshal's Office believes the key to reducing fires and fire deaths is education. Fire safety education has traditionally been concentrated in elementary school observances of Fire Prevention Week. While these observances can produce effective results, thoughtful analysis of the fire problem and fire safety educational programs shows that a more comprehensive, age-appropriate approach to fire safety education can multiply its benefits.

Recognizing the limits of classroom instruction time, the State Fire Marshal's Office has examined the Texas essential elements of instruction to determine the most appropriate topics with which to integrate fire prevention and fire safety. Teachers from across the state have provided feedback on topics appropriate for each grade level, kindergarten through high school.

The result of this extensive research is "Fire Safety for Texans," a series of curriculum guides teaching fire and burn prevention. Each grade-level program has been coordinated with essential elements in that grade and with the unique specific fire safety needs of that age group. The lesson plans have been field tested in classrooms across the state. On average, students who have been taught using these materials score 26 percent higher than students in control groups.

As you use this guide, you and teachers in other grade levels will be part of a continuum of fire safety education spanning all grades. The State Fire Marshal's Office believes this continuum will help create a generation of Texans who will be fire-safety aware. In turn, all Texans can benefit from a decrease in the number of needless fire deaths and an increase in safer homes and worksites — a benefit we all deserve.

This Booklet

This booklet, "Fire Safe Together," is specifically designed for kindergarten students. The following sections give specific information on the essential elements applicable to fire and burn prevention and on the age-

specific needs of kindergarten students related to fires and burns. You will also find additional information on the format and materials found in this booklet.

This booklet has three sections:

- Lesson Plans, which include all steps in the lesson cycle.
- Teacher Materials, which includes all teaching aids and tests.
- Student Materials — Duplicating Masters, which includes master copies of materials to be used by students.



General Objectives: To develop basic awareness of fire and burn dangers

To develop simple actions to reduce injury

To encourage parent involvement

Essential Elements: The student will be provided opportunities to:

§75.25 (a) 1A. use comparators: ... heat/cold.

§75.25 (a) 3A. classify objects by comparing similarities and differences.

§75.25 (a) 3C. arrange events in sequential order.

§75.26 (a) 1C. recognize hazards in the environment and acquire knowledge and skills needed to avoid injuries and to prevent accidents.

§75.26 (a) 1D. recognize negative effects of ... tobacco.

§75.29 (a) 1A. identify examples of right and wrong behavior.

§75.29 (a) 1B. discuss ways people can help each other.

§75.29 (a) 1D. practice rules of safety.

§75.29 (a) 1E. recognize safety symbols.

Background: Age Profile

Stage of initiative vs. guilt, which means that the child is struggling between wanting to do things on his own and accepting punishments or reprimands as feelings of guilt for those actions he initiates. The child needs a variety of experience to develop a sense of accomplishment.

Pre-operational thought, which means the child needs concrete objects and experiences to understand concepts and frequently will not be able to understand operations such as adding or sequencing.

Operates under a morality of constraint, which means the child views rules as absolute, created by an authority figure. She focuses only on consequences, not intent or reason. This means there may be a great variability in understanding and obeying the rules.

The kindergartner generally admires and emulates his parents. He also imitates the actions of others. The child is active and curious, but still dependent on the adults in his life. Language skills are growing, but still limited.

Fire And Burn Hazards

Curiosity about fire — playing with matches or lighters, candles, fireplace, heaters, other locations where the child can observe a flame.

Electricity — pulling or damaging electrical plugs or wires, inserting objects in electrical outlets, pulling electrical appliances.

Appliances — pulling electrical cords, especially appliances such as frying pans, irons and curling irons; climbing on stoves; pulling pans from stoves; being too close to portable heaters; touching electrical appliances.

Scalds — adults spilling hot liquids, splashed hot liquids, hot tap water, hot bath water, hot foods (especially heated sweet foods).

Clothing ignition — playing with matches; standing, walking or sleeping too close to heater or other open flame; knowing how to reduce injury.

Other — Flammable liquids, cleaning agents or other poisons; injury from smoke and fire gases; parents' cigarettes; knowing how to escape from fire.

Teacher's Note On Materials: Illustrations and activity sheets in this booklet are intended to serve as masters. Photocopy, then use the photocopy as directed.

Pre-Test and Post-Test: Conduct the pre-test prior to presenting the first lesson and the post-test following the fifth lesson.

Teacher's Note on Closure Activities: Some activities included in the closure phase of the lesson cycle may be effectively used in the next lesson's focus activity.

Key To Icons: The following icons can be used to easily identify activities in the lesson plans:



Lesson objectives



Focus and closure



Creative group activity, including role playing



Lecture



Demonstration



Group problem-solving activity



Answering questions



Guest presenter



Investigation or research



Creative writing activity



Cut-and-paste activity



Group discussion



Drawing, artwork or illustration

Lesson Plans

LESSON ONE:

Hot Is Not Safe

Goal: To focus on awareness of heat and burn hazards



Objectives: The student will:

- classify hot and cold objects, including cigarettes and appliances *25(a)1A,3A, 26(a)1C
- identify "hot" and "cold" symbols on faucets *26(a)1C, 29(a)1E
- state rule to stay away from hot objects *26(a)1C, 29(a)1A

Materials: Pre-tests (test p. 10-11, questions p. 9); "H" and "C" letter cards (p. 12); bulletin board and tacks, or flannel board; hot and cold object cards (p. 13-14); "What's Hot? What's Not?" activity sheet (p. 24); red and blue crayons. (If using flannel board, glue small pieces of felt to the back of all letter and object cards.)
Enrichment: magazines, safety scissors, glue, poster.



FOCUS: Administer pre-test before beginning lesson.

Play "hot and cold" children's game to introduce general concepts and purpose of unit on fire safety.

Teacher: "Let's play the game of "hot and cold. " (Select a student and play game, saying "hot" and "cold" to direct student to the object.) In this game, it's fun to look for the "hot" item, like the one that John just found. But in our everyday world, hot objects can hurt us and it is important for us to learn about staying safe. During this unit, we are going to learn about the kinds of things that hurt us by burning or causing fires. We'll learn about how to stay safe, and we'll talk about how our family can work together to stay safe."

Presentation Of Content: Show the blue C and red H cards, and have students identify the letters and colors. Relate to previous lessons on letter and/or symbol recognition.



Teacher: "Usually when we see the color red used in a sign or as a label, it means danger. Think of the red stop light and the stop sign. The red warns us that there is danger if the car doesn't stop. Red is used in another way: to warn of fire dangers. The letter H is also a warning sign. It means "hot" when you see it on a water faucet.

"Today we are going to use the red H letter to mean a hot object, something that we must not touch because

that object can burn. Here's a rule to help remember to stay away from hot objects: 'Red hot — Stay away!'"

Repeat rule "Red hot, stay away" several times.



Guided Practice: Attach C and H letters to

bulletin or flannel board. Using picture cards of hot and cold objects, have students name each object then classify as hot or cold. Attach cards to board beneath the proper letter. Restate "Red hot, stay away" after each object classified as hot.



Independent Practice: Distribute "What's Hot?

What's Not?" activity sheet, red and blue crayons. Instruct the students to circle all cold objects with the blue crayon and to X all hot objects with the red crayon.



Reteaching: To help students who may not be able

to apply the rule "Red hot, stay away," show the object cards again and have them role play appropriate actions (to be allowed to touch or hold cold objects, but to stay away from hot objects).



Enrichment: Have students create a collage

illustrating hot and cold objects. Clip magazine pictures and group on paper divided into two sections labelled "H" and "C." Option: To reinforce recognition of letter H, clip pictures of objects that start with H sound.



Closure: Apply hot and cold classification skills to objects in the classroom and restate "Red hot, stay away" rule. Restate value of staying safe throughout one's lifetime.

Teacher: "Today, we have learned about hot and cold objects. Let's name some of the hot and cold objects in this room. (Have students identify. Most classrooms do not have many, if any, hot objects. Be aware of hot water faucets, heating units, overhead projectors.) What's the rule for how we should act near a hot object? ("Red hot, stay away!") In our next lesson, we will learn more about how to stay safe."

LESSON TWO:

Stopping Fires

Goal: To build awareness of how students can avoid hazards



Objectives: The student will:

- classify "good" and "bad" fires and heat sources *25(a)3A, 26(a)1C
- identify smoking cigarettes as a hazard to cause burns and to start fires *26(a)1D
- demonstrate telling an adult if he/she sees matches *26(a)1C, 29(a)1A

Materials: "Red Hot Flame" and "Safety Kid" cutouts (p. 15); "A Trip Through Safety Kid's House" (p. 16) reproduced on transparency; overhead projector; "Watch Out! It's Hot!" activity sheet (p. 25); pencils, yellow crayons. Enrichment: drawing paper, crayons.



Focus: Introduce Red Hot Flame and Safety Kid puppets. Review last lesson on recognizing "hot" and "cold."

Teacher: "These two puppets — Red Hot Flame and Safety Kid — will help us look for things in our homes that are not safe, things that we must stay away from because they are hot. In our last lesson, we talked about recognizing hot and cold objects. Today, we'll learn more about that and how we can be safer."



Presentation Of Content: Place the transparency of the house on the overhead projector.

Teacher: "This house shows us all the rooms we find in most houses — the living room, kitchen, bathrooms, bedrooms and garage. We can also see many things in this house that might cause burns or start a fire. Some of these things are very useful, but because they are hot, they can hurt us. For example, the toaster in the kitchen is useful because it helps make toast. But if you touch it with your finger — without a hot pad — you can get a bad burn. Can you name another hot object in this house?"



Accept two examples and discuss how the objects might be helpful or useful but also harmful.

Teacher: "Some things are so dangerous that you should tell an adult right away if you see it. Finding matches is

one of those times you should tell an adult right away."

Repeat question "What do you do if you see matches?" and ask for response "Don't touch; tell an adult right away."



Guided Practice: Allow students to move the two puppets through the house on the screen as described.

Teacher: "Let's take Safety Kid through the house and see what problems we can find. Whenever we find a problem, let's put up the Red Hot Flame so that we know it's 'red hot, stay away.' Let's look for special problems that we should tell an adult about."

Hand the puppets to two students and begin the tour in the living room. Place the Red Hot Flame on all objects that are or could be hot. Keep Safety Kid away from those objects:

Living room: fireplace, book of matches, cigarettes.

Kitchen: cup of coffee, stove, toaster, hot water faucet.

Bathroom: hot bath water, electric curlers, wall heater.

Bedroom: portable heater, adult smoking cigarettes.

Garage: bare light bulb, iron, water heater.

Teacher (whenever matches are found): "What should you do right away if you see matches?" (Tell an adult.)



Independent Practice: Distribute Safety Kid/Red Hot Flame activity sheet, pencils and yellow crayons. Instruct the students to draw lines from Safety Kid to safe objects and to draw lines from Red Hot Flame to hot objects. Color useful hot objects yellow.



Reteaching: Focus on common hazards in the kitchen and bathroom, cigarettes and matches. Using the overhead transparency, have students identify those items and state rules to stay away from hot objects or to warn an adult.



Enrichment: Draw picture of a room at home, using a red crayon to draw hot objects.



Closure: Review completed activity sheet. Have students review general rules about hazardous items, especially cigarettes and matches.

Teacher: "Being able to recognize objects that are hot is very important in staying safe. Although some of those hot objects — like a stove or a fire place — have very

useful purposes, you should always stay away. You must always be very careful if you see matches; tell an adult about them right away so they can be stored safely. So far, we've learned a lot about being safe. In our next lesson, we'll learn how to be safer by being prepared in case of a fire."

LESSON THREE:

Getting Out

Goal: *To build awareness of how to evacuate in case of fire*



Objectives: The student will:

- identify EXIT signs in schools and public buildings *29(a)1E
- demonstrate actions in school exit drills *26(a)1C, 29(a)1D
- demonstrate telling an adult about smoke or fires *25(a)3C, 26(a)1C

Materials: Sample EXIT sign (p. 17); chalkboard; "Getting Out!" activity sheet (p. 26); safety scissors; glue; one poster board; markers. Enrichment: drawing paper; crayons.



Focus: Prepare students for a short walk in the building. Have them stand up quietly and line up.

Teacher: "In our first lesson on fire safety, we talked about how red is used as a warning sign. An important warning sign is the EXIT sign. Here's what an EXIT sign looks like. (Show sample EXIT sign.) Most EXIT signs are red. Being able to find EXIT signs — and following EXIT signs — is an important skill that you will use all your life. Let's go look for an EXIT sign near our room"

When the EXIT sign is located, have the students describe it. Then return to the classroom.



Presentation Of Content: This discussion includes several actions that students can learn to be prepared for a fire emergency.

Teacher: "Even though we may work very hard to prevent fire, fires still occur. It is very important to know what to do in case there is a fire. By thinking about what we will do and by practicing what we will do, we can act more safely if there is a fire. At our school, we plan and practice fire exit drills. The principal sounds the fire alarm, and everyone in the school goes safely outside,

just as if it were a real fire. This means that we will know what to do because we have practiced."

Discuss specific guidelines for fire exit drills in the classroom and school. Write the steps on the chalkboard.

Teacher: "There are two other things that we should know to help be prepared for a fire. First, wherever you go, look for EXIT signs. They will show you the way out. You usually won't find an exit sign in a house, but you'll probably see them in every other kind of building. The second thing to remember is that you should tell an adult right away if you see smoke or a fire. Don't wait — Tell an adult right away."



Guided Practice: Have students act out reactions to situations presented in this lesson. Describe the situation and ask the group or individuals to show their reaction.

- "You walk in the kitchen at home and see smoke coming from a pan on the stove. What should you do?" (Tell an adult right away).
- "We're sitting in the classroom and the fire alarm starts ringing. What should you do?" (Stand up quietly and line up at the door to exit.)
- (Still in line at door) "We're walking down the hall during a fire drill. Other classes are talking and running. What should you do?" (Walk quietly in place, hands at side.)
- (Still in line at door) "After we've reached our assigned place outside, we heard one bell (or school's signal to return to classroom) What should we do?" (Turn around and walk quietly back to desks).
- "You're playing outside and see grass on fire down the street. What do you do?" (Tell an adult right away.)



Independent Practice: Distribute sequencing activity sheet, scissors and glue. Review the pictures. Instruct the students to cut the pictures apart, put them in proper order and glue in proper boxes.



Reteaching: To reteach school exit procedures, practice in-class evacuation as often as necessary. Some practices may be unannounced.



Enrichment: Have students draw pictures showing EXIT signs in other buildings students have visited. Suggestions: movie theaters, stores, malls.



Closure: Review the completed activity sheet. With students' participation, write fire drill procedures on a large poster (even if you already have a small evacuation information card).

Teacher: "We've made this poster to help us remember how to leave safely in case of a fire. This is one important way we can be prepared for a fire. In our next lesson, we'll learn more about how to be prepared for a fire."

LESSON FOUR:

Good Actions

Goal: *To show and provide reinforcement for appropriate actions in case of fire*



Objectives: The student will:

- demonstrate and practice rolling on ground in case of clothing fire *25(a)3C, 26(a)1C, 29(a)1D
- demonstrate and practice crawling on ground in smoke or fire situations *25(a)3C, 26(a)1D
- demonstrate or illustrate staying away from campfire, trash burning, etc. *26(a)1C

Materials: Red Hot Flame puppet (p. 15); "Smokey Ghost" (p. 18) cutout mounted on sticks to make puppet; "Good Actions" sequencing activity sheet (p. 27); scissors; glue.



Focus: Reintroduce Red Hot Flame puppet and explain that today it will represent actual fires and flames. Introduce Smokey Ghost and explain that it represents the smoke and invisible gases that come from fires.

Teacher: "We have been studying fires and other things that can burn you. We've also learned about ways to be prepared for fires. (Have students repeat several items covered.) Today, we'll practice three important things that can help us stay safe from fire."



Presentation Of Content: Use the puppets to show how fire and smoke are related and how knowing about fire and smoke can help us react safely in case of fire.

Teacher: "A fire can start very small, without anyone even knowing that it's started. (Hold Red Hot Flame low and still). But once it is started, a fire begins to give off smoke and dangerous gases, sometimes so small that we can't even see it. But it's there. (Hold Smokey

Ghost above Red Hot Flame. Raise Smoke Ghost high and wave.)

"The smoke and gases are very dangerous. They can block the light so we can't see the way out, and they can make us sick very quickly. Here's the important thing to know, the smoke and dangerous gases go up as high as they can, up near the ceiling. To stay away from the smoke, we can crawl under the smoke to get out safely. So, if you see smoke or if you hear your smoke alarm, get on your hands and knees and crawl out quickly. To warn other people, yell "FIRE" as loudly as you can. This also helps them know where you are. Let's practice that."



Hold Smokey Ghost up and tell the students to imagine there is smoke in the room. Have them show what they would do. (Crawl and yell "FIRE.") Put Smokey Ghost aside.

Teacher: "A fire might start large or so fast that you didn't know what was happening. This might happen in an explosion or if you were standing too close to a heater or a campfire. Many times, when this happens your clothes catch on fire (Place Red Hot Flame on your clothes), and you need to do something right away. Here's what you should do. Stop right away, drop to the ground and roll over and over. This is the best way to try to put the fire out. (Take Red Hot Flame off clothes) Yell for help, but don't run! Let's practice that."

Place Red Hot Flame next to a student and tell the students to imagine that their clothes are suddenly on fire. Have them show what they would do. (Drop and roll on ground, and yell for help.)

Teacher: "Most times, clothes catch on fire because the person was standing too close to a useful fire, like a heater, stove or campfire. Stay away from any kind of fire, even if it is a useful, helpful fire. Sometimes, clothes catch on fire because the person was playing with matches or a lighter. Remember, never touch matches. Tell an adult right away if you see matches."



Guided Practice: Use the puppets to describe situations requiring student reactions. Position the puppet, describe the situation and have the students show the proper reaction. Tell them to cross their arms to show they would stay away.

- (Hold Smokey Ghost high.) "You wake up at night, hear the smoke alarm and smell smoke. What do you do?" (Crawl low and yell "FIRE.")

- (Hold Red Hot Flame near the ground.) "You are outdoors where an adult is burning trash. What do you do?" (Stay away.)
- (Hold Red Hot Flame near your clothes or a student's clothes.) "You walk too close to a heater, and your clothes catch fire. What do you do?" (Drop and roll.)
- Repeat using similar examples.



Independent Practice: Distribute "Good

Actions" activity sheets, scissors and glue. Instruct the students to cut the pictures apart, put them in sequence and glue in proper boxes.



Reteaching: Repeat role-playing activity to practice crawling in smoke situation and rolling to put out a clothes fire (see Guided Practice above).



Enrichment: Have students use Smokey Ghost and Red Hot Flame puppets to create their own stories or plays.



Closure: Have students use Smokey Ghost and Red Hot Flame puppets to show situations for others to react to. Question students on what they have learned during the unit.

Teacher: "We have learned many things about being safe from fire and burns. All of these things will still be important as you grow up and have your own homes later. In the next lesson, we'll learn more about how adults help children like you stay safe."

LESSON FIVE:

Adults Who Can Help

Goal: *To involve parents and to show how adults are involved in fire safety*



Objectives: The student will:

- identify fire fighters and other fire service workers as friends *29(a)1B
- tell parents, "Keep me safe" *29(a)1B
- tell parents to give fire safety rules to baby-sitter *26(a)1C

Materials: Fire fighter, hat, coat and boot cutouts (p. 19); "Keep Me Safe" activity sheet (p. 29); fire fighter, hat, coat and boot activity sheets (p.28); crayons; scissors; construction paper; glue or stapler; "Fire Safety Rules for Baby-Sitters" sheet (p. 30); post-test (p. 20-21, questions on p. 9).



Focus: Introduce Fire Fighter in uniform. Note: Most students will label this cutout a police officer because of the uniform.

Teacher: "This person wearing a uniform is a fire fighter. He wears this uniform when he is not involved in fighting a fire or helping with a rescue. Even when he is not fighting fires, a fire fighter and other people who work for the fire department are important friends. Let's talk about some ways that fire fighters are friends."



Presentation Of Content: Lead the students in a discussion including areas covered during the unit to explain how fire fighters are friends and helpers in the community.

Teacher: "During this unit on fire safety, we have talked about knowing what objects are hot. Hot objects can burn or start a fire. One of the most important jobs of the fire department is to help people look for things that might start a fire at their homes or jobs. This is called inspecting. What kinds of items might we inspect for? (Cigarettes, matches, hot water, etc. Accept all reasonable answers.)"

Show fire fighter cutout.



Teacher: "A fire fighter usually wears his uniform when he is inspecting. He might also wear this uniform

when he talks to adults and children, like you, about how to keep fires from starting. Fire fighters are very concerned about children. They know that parents have an important job in keeping their children safe. You can help the fire fighters do their job by telling your parents how important it is to stay safe from fires."

Attach hat, coat and boots to fire fighter cutout. Have the students describe the new items.

Teacher: "This is what we usually think a fire fighter wears, and it is usually what he wears while fighting a fire and helping with a rescue. This special hat, coat and boots help protect the fire fighter because putting out a fire can be very dangerous. What are some things that you think a fire fighter might do while wearing these special clothes?"

Accept all reasonable answers.



Guided Practice: Distribute "Keep Me Safe"

activity sheets and crayons. Help the students write their parents' or guardians' names and their own names in the appropriate spaces. Then read each guideline as the students color the matching picture. Have the students repeat the message "Keep me safe" as they color the message.



Independent Practice: Distribute the fire

fighter activity sheets, crayons, scissors and construction paper. Fold the construction paper in half, and staple or glue to make envelopes. Have the students color and cut the character and pieces, then store in the envelopes.



On the outside of the envelope, have students draw pictures of what the fire fighter might do while wearing each of the two uniforms.



Reteaching: Review the types of hazardous items and actions discussed during the unit. Have the students discuss why it is important to avoid these items and actions. (To keep from being hurt or starting a fire.) Have the students discuss how they can talk to their parents/guardians about keeping their homes safe from fire.



Enrichment: Invite a fire fighter to visit the classroom with gear normally worn during rescue (turnout gear). Ask the fire fighter to describe in a simple, non-frightening way how a rescue operation is conducted.

After the visit, have the students write a thank-you letter to the fire department.



Closure: Distribute "Fire Safety Rules for Baby-

sitters" for the students to take to parents. Review guidelines in sheet. As guidelines are read, have the students explain why each is important. Ask students to describe other things they have learned during the unit.

Teacher: "We have learned about many things that are dangerous because they can cause fire and burns. We have also learned some things that even children like you can do to keep from being hurt when there is a fire. And we have learned some ways to get grown-ups involved in being fire safe. Let's remember what we have learned and try to use them every day."

Administer post-test, using same questions used in pre-test.

Teacher Supplemental Materials

Questions for Pre-Test and Post-Test

Use with Lesson One, Page 3, and Lesson Five, Page 7. Read each question aloud and instruct the students to fill in the bubble on the appropriate picture on the test sheet.

1. Hot water coming from a faucet is very dangerous. What letter do we see on a hot water faucet? Fill in the bubble on the left picture if the answer is letter H. Fill in the bubble on the right picture if the answer is letter C.
2. A cup of coffee is usually very hot. Which of these two objects can also be very hot? Fill in the bubble on the left picture if the answer is an iron. Fill in the bubble on the right picture if the answer is a book.
3. Many adults smoke cigarettes. What should you do if someone you know smokes? Fill in the bubble on the left picture if it's okay to let an adult smoke in bed. Fill in the bubble on the right picture if you should always stay away from cigarettes.
4. What should you do if you see matches? Fill in the bubble on the left picture if you should pick up the matches. Fill in the bubble on the right picture if you should just tell an adult, so she can put the matches away.
5. There's a special kind of sign that shows you the exit, or the way out in case of fire. Fill in the bubble on the left picture if it's that sign. Fill in the bubble on the right picture if that sign shows you the exit.
6. If you see smoke coming from a building, what should you do? Fill in the bubble on the left picture if you should go see what is happening. Fill in the bubble on the right picture if you should tell an adult right away.
7. What is the first thing you should do if your clothes catch fire? Fill in the bubble on the left picture if you should run for help. Fill in the bubble on the right picture if you should drop to the ground and roll over and over.
8. Pretend that you are sleeping and you wake up to hear the smoke alarm in your house. What should you do? Fill in the bubble on the left picture if you should crawl out of the house. Fill in the bubble on the right picture if you should go see if there is a fire.
9. A fire fighter helps put out fires. Does a fire fighter have any other jobs; can he or she help you in other ways? Fill in the bubble on the left picture if you think the answer is YES. Fill in the bubble on the right picture if you think the answer is NO.
10. Can adults, like parents and baby-sitters, work together with children to keep fires and burns from happening? Fill in the bubble on the left picture if you think the answer is YES. Fill in the bubble on the right picture if you think the answer is NO.

1.

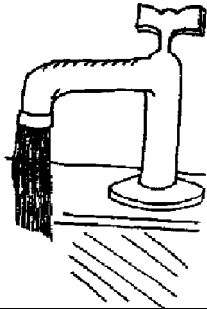

H

C

2.

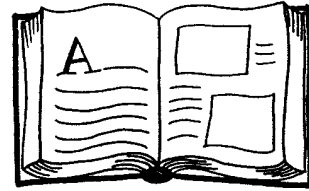
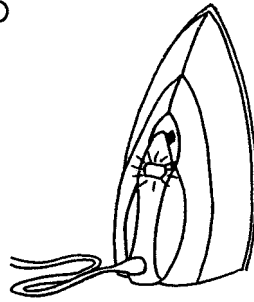

3.

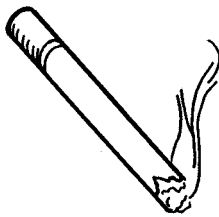

4.

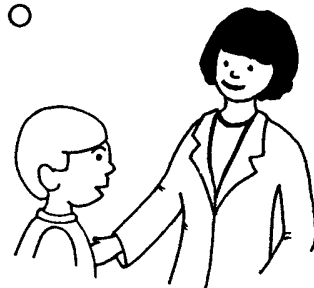
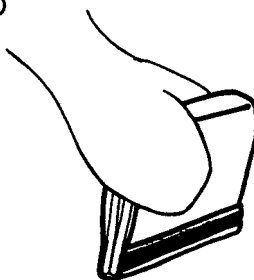
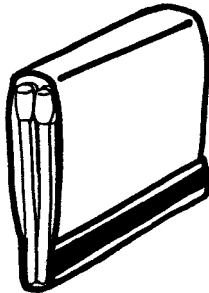

5.

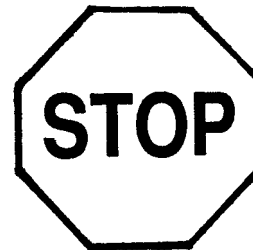

6.

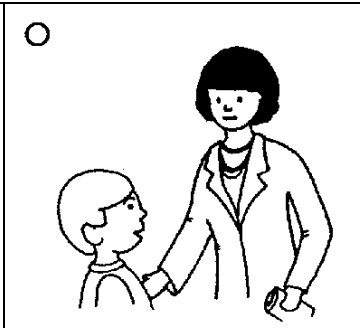
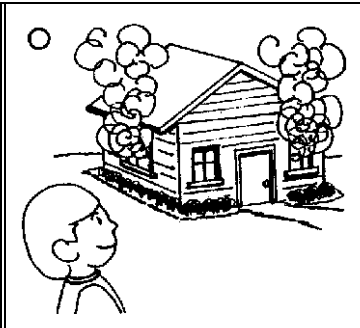
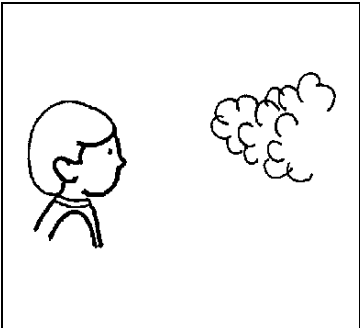

7.

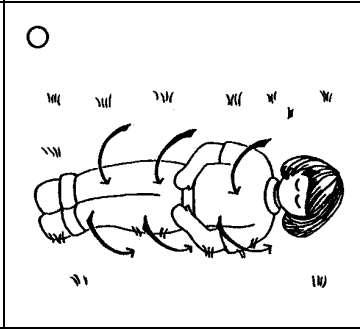
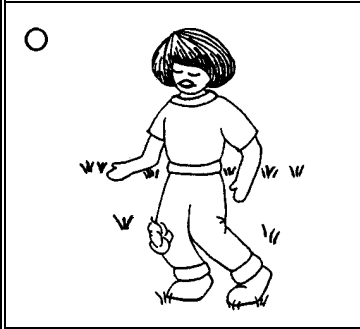
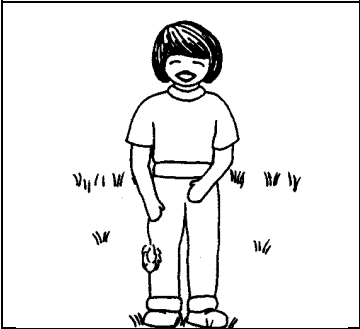

8.

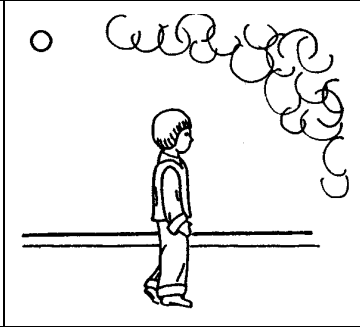
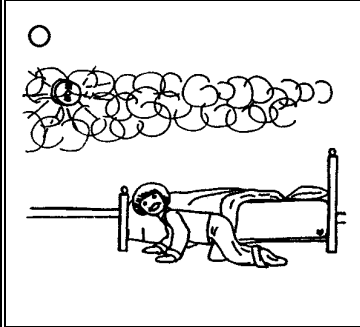
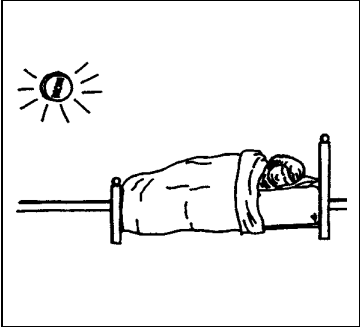

9.



YES

NO

10.

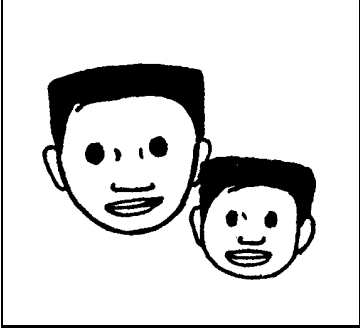

YES

NO

Teacher: Use prior to beginning Lesson One, Page 3. Duplicate for student use. Use questions on Page 9.

"H" and "C" Letter Cards

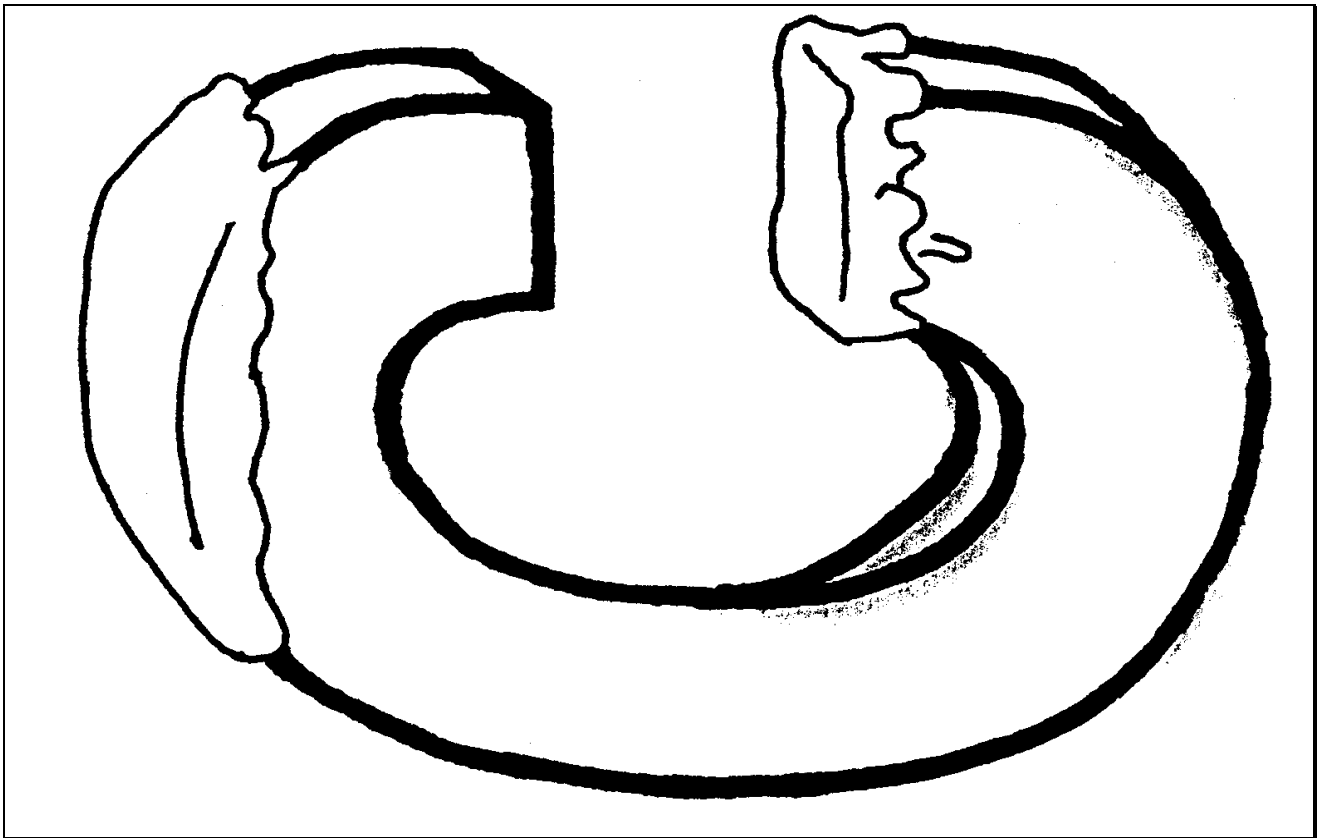
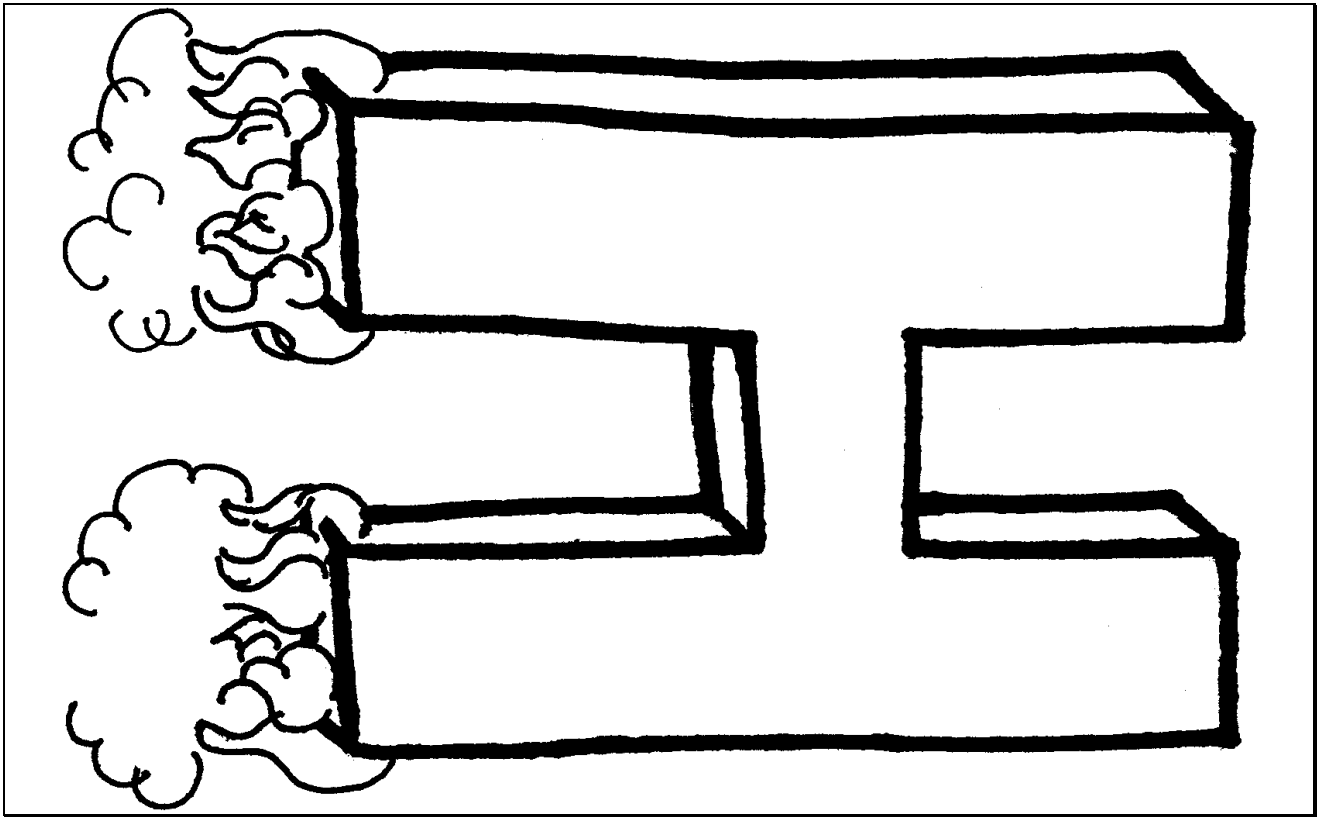

Teacher: Use with Lesson One, Page 3. Photocopy, and cut out. Color letter H red and color C blue. Mount on tag board, if desired.

Hot and Cold Object Cards

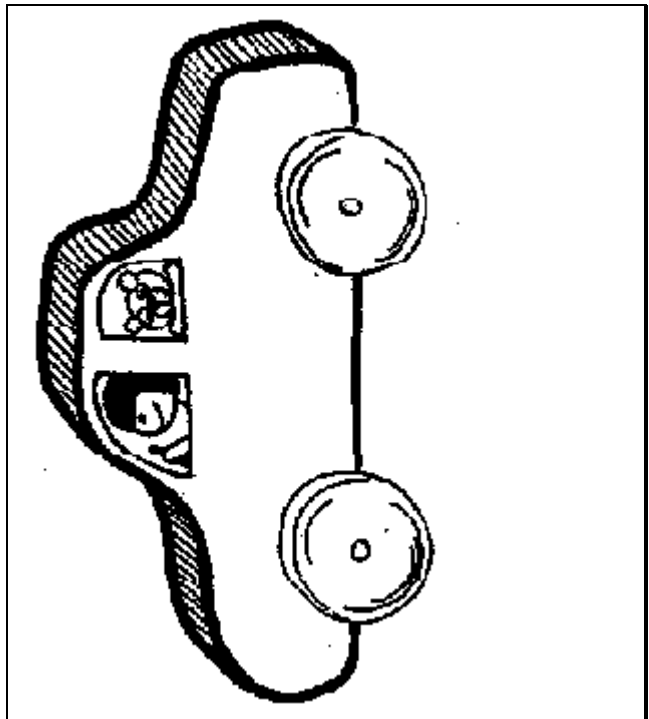
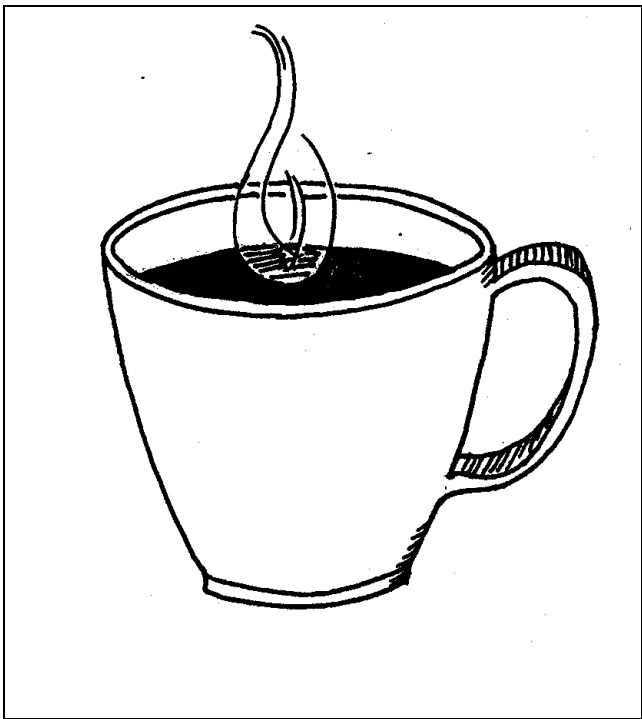
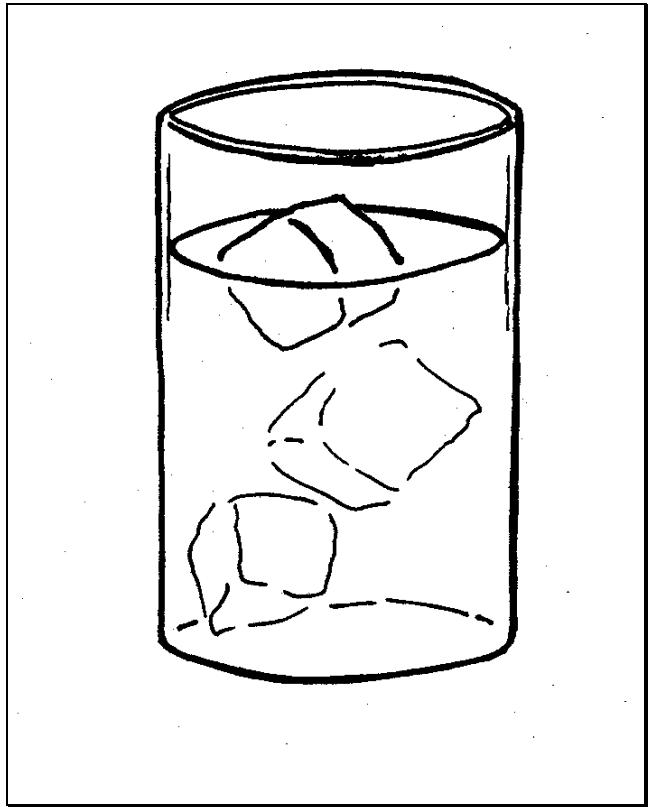
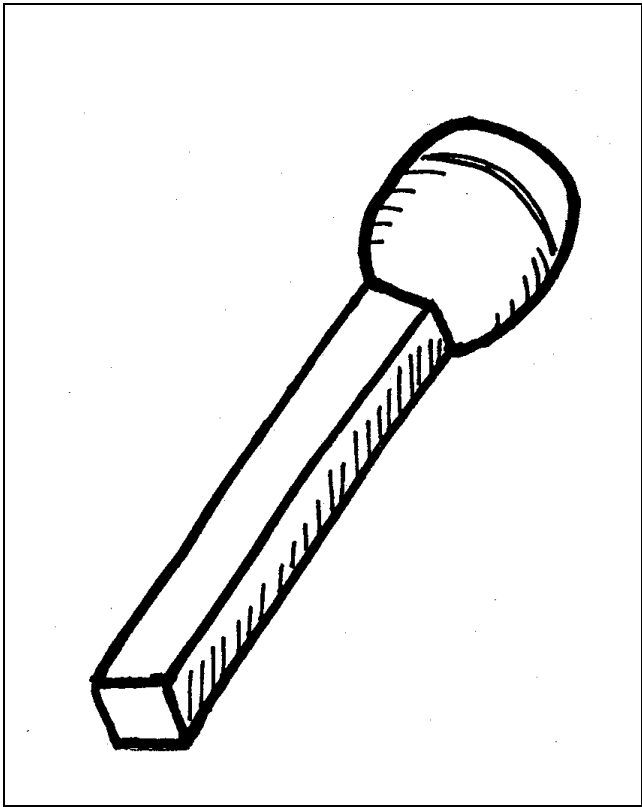

Teacher: Use with Lesson One, Page 3. Photocopy, then cut apart. Mount on tag board, if desired.

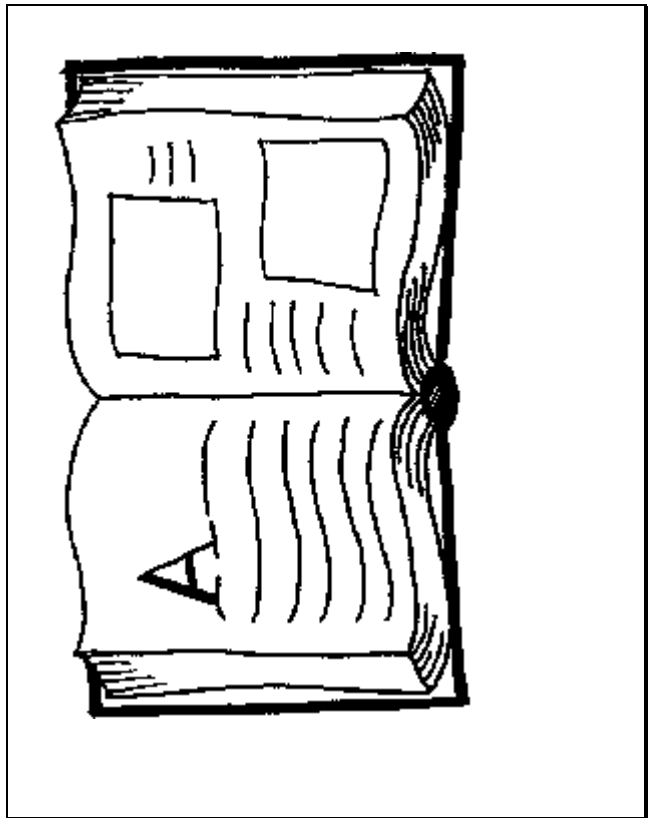
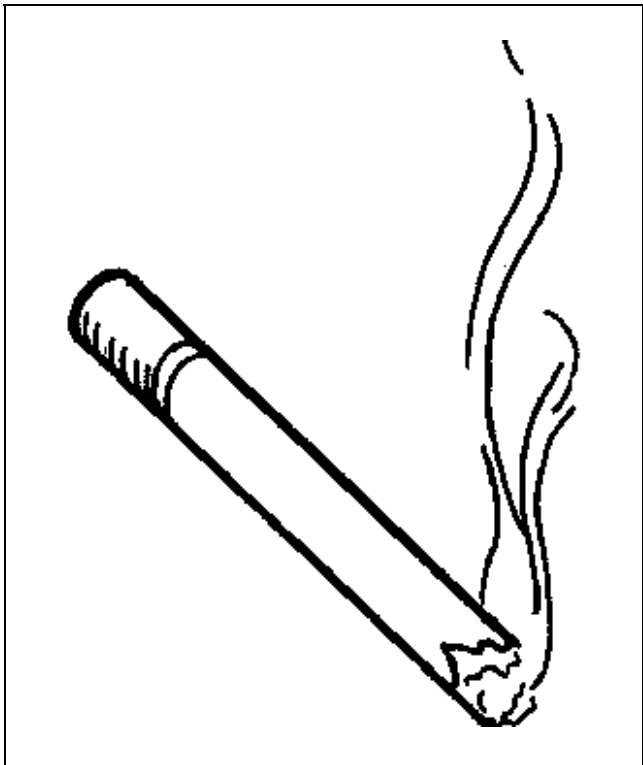
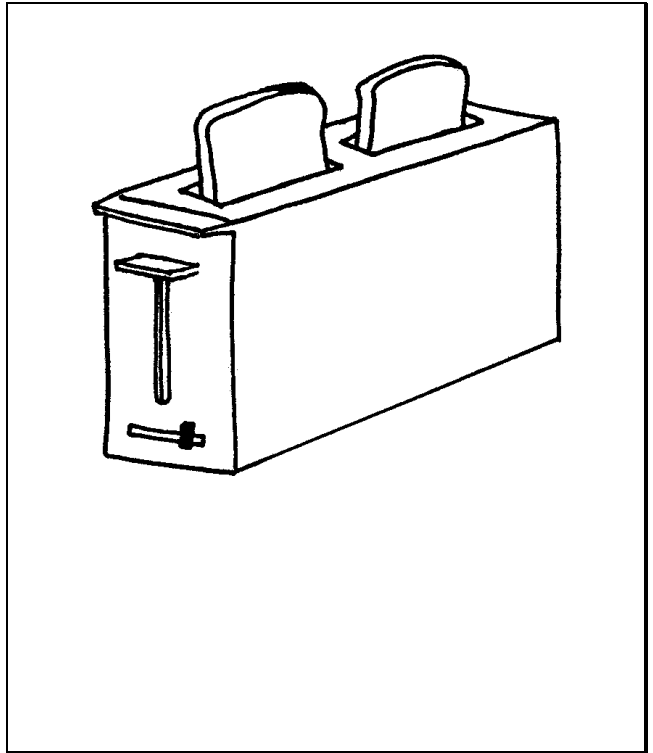
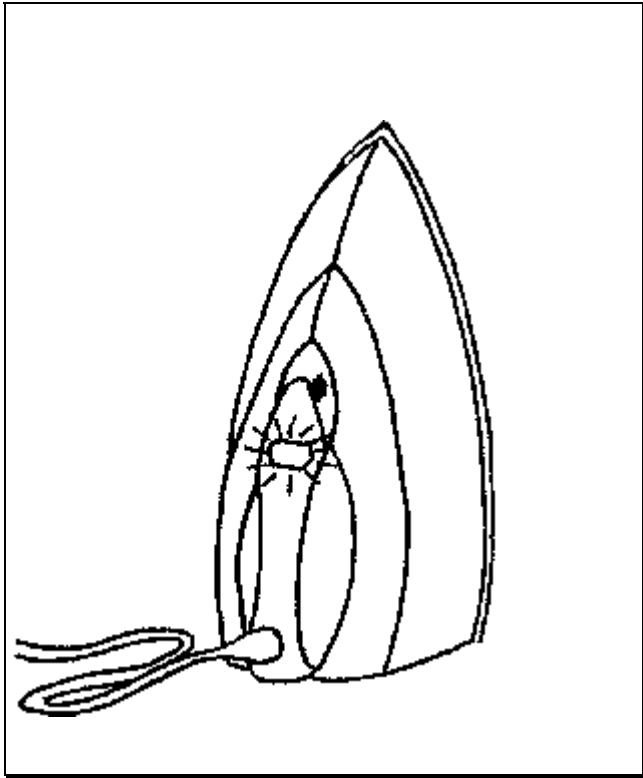

"Red Hot Flame" and "Safety Kid"

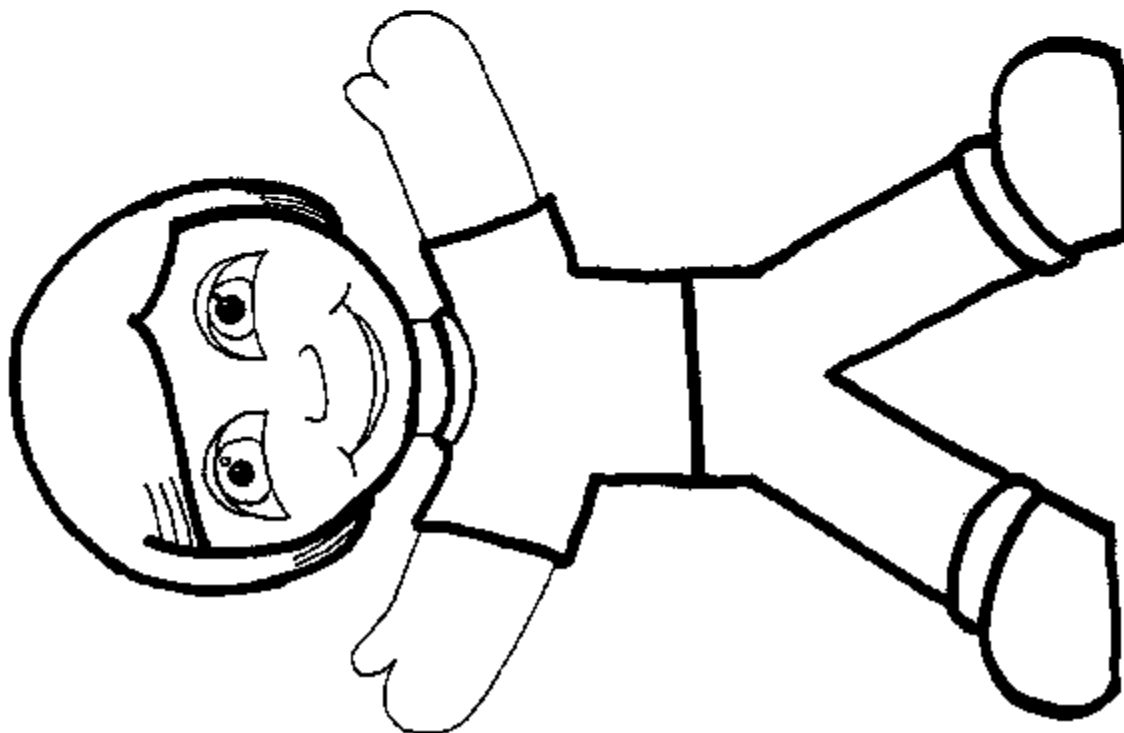
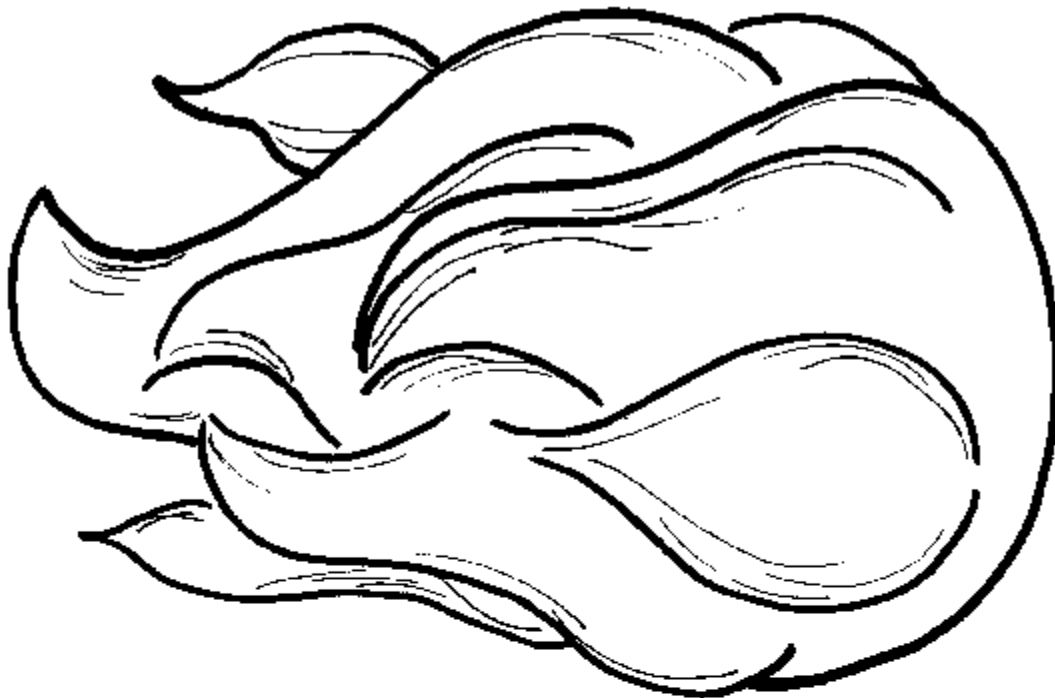

Teacher: Use both puppets with Lesson Two, Page 4, and Red Hot Flame with Lesson Four, Page 6. Copy, cut out, and mount on craft stick to make puppet. Color and mount on tag board if desired.

A Trip Through The Safety Kid's House

Help the Safety Kid find hot items in the house. Put the Red Hot Flame wherever you find a hot object.

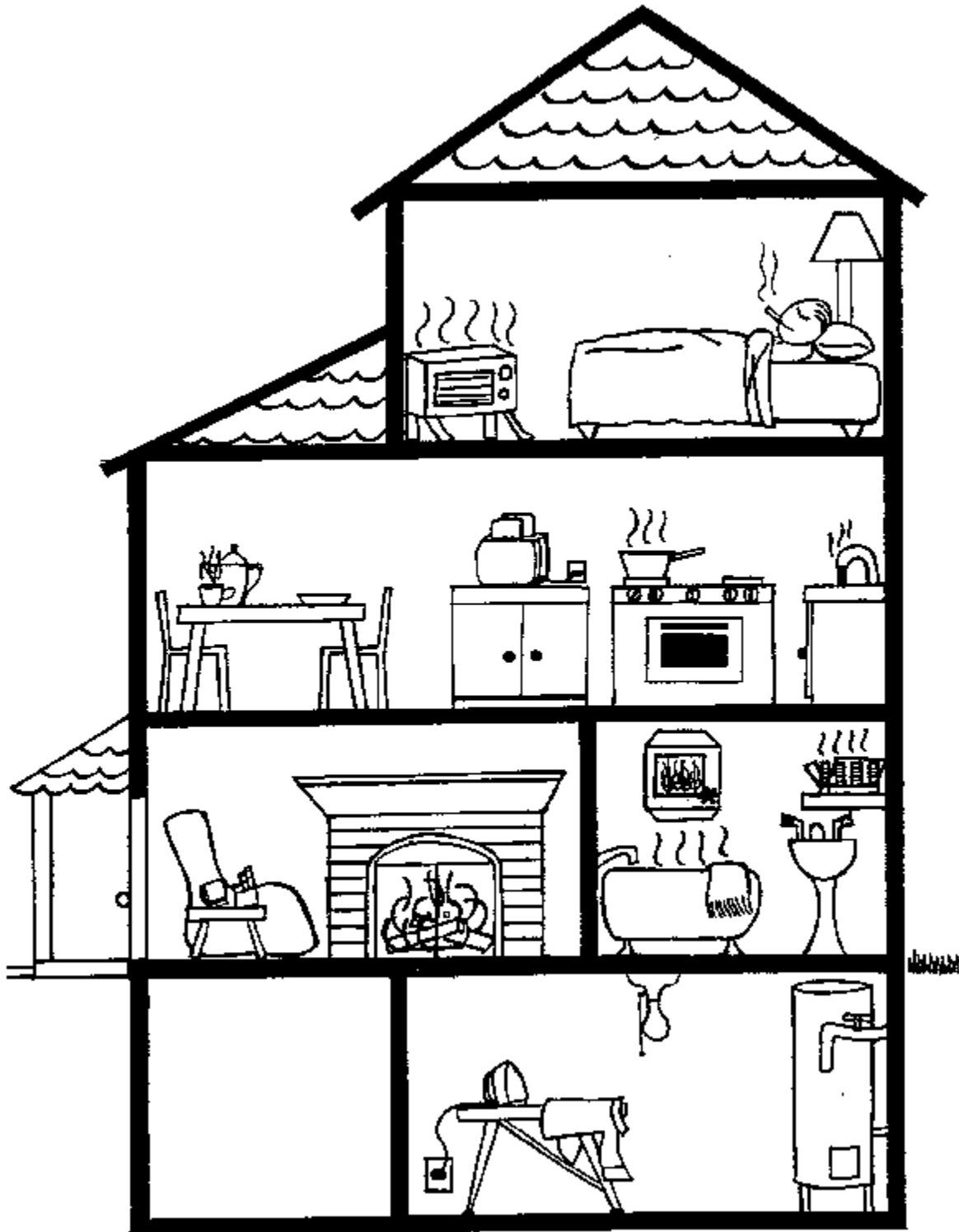

Teacher: Use with Lesson Two, Page 4. Copy onto transparency sheet or poster. Have students take Safety Kid through the house, holding up the Red Hot Flame when they find objects that can burn.

Sample EXIT Sign

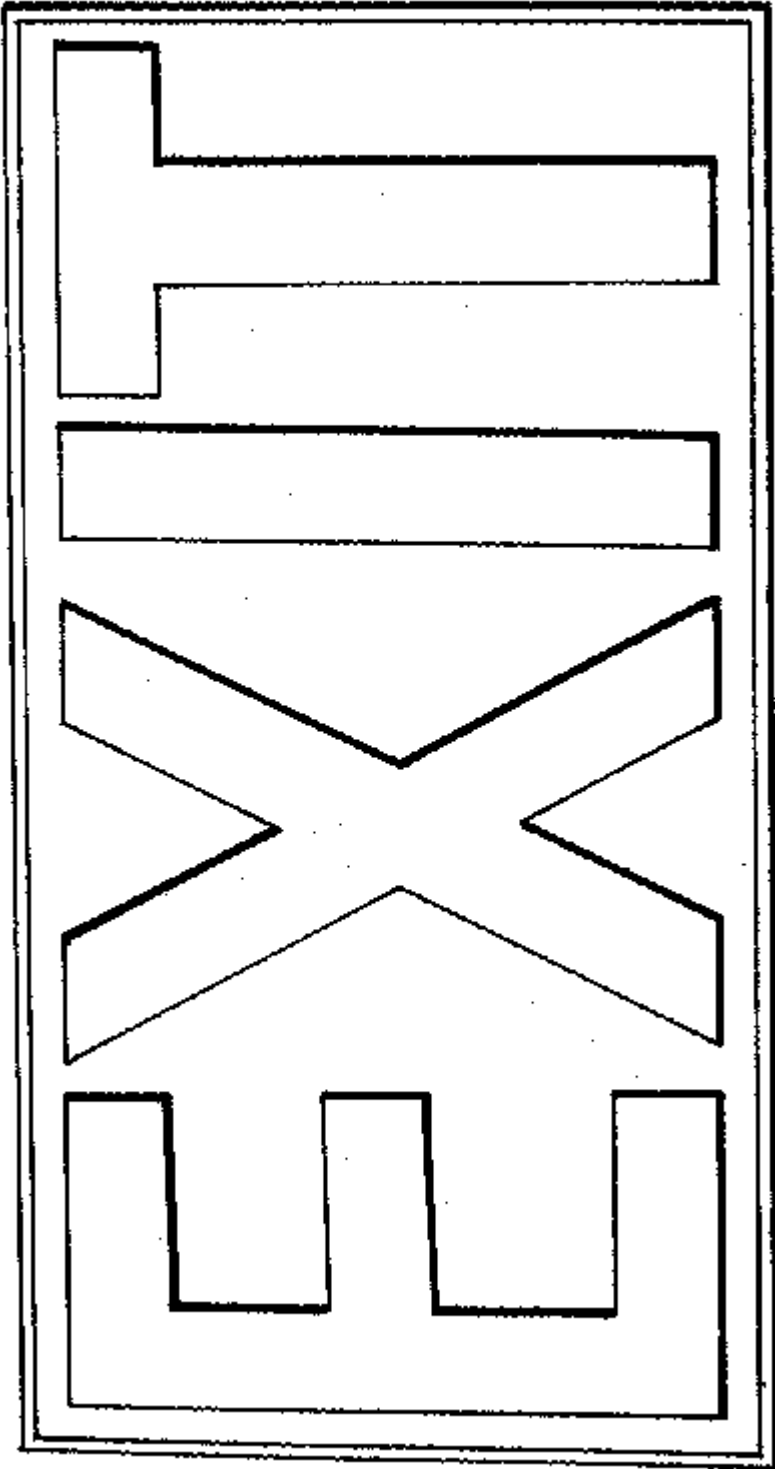

Teacher: Use with Lesson Three, Page 5. Copy, and clip out. Color background red, and mount on tag board if desired.

"Smokey Ghost" Cutout

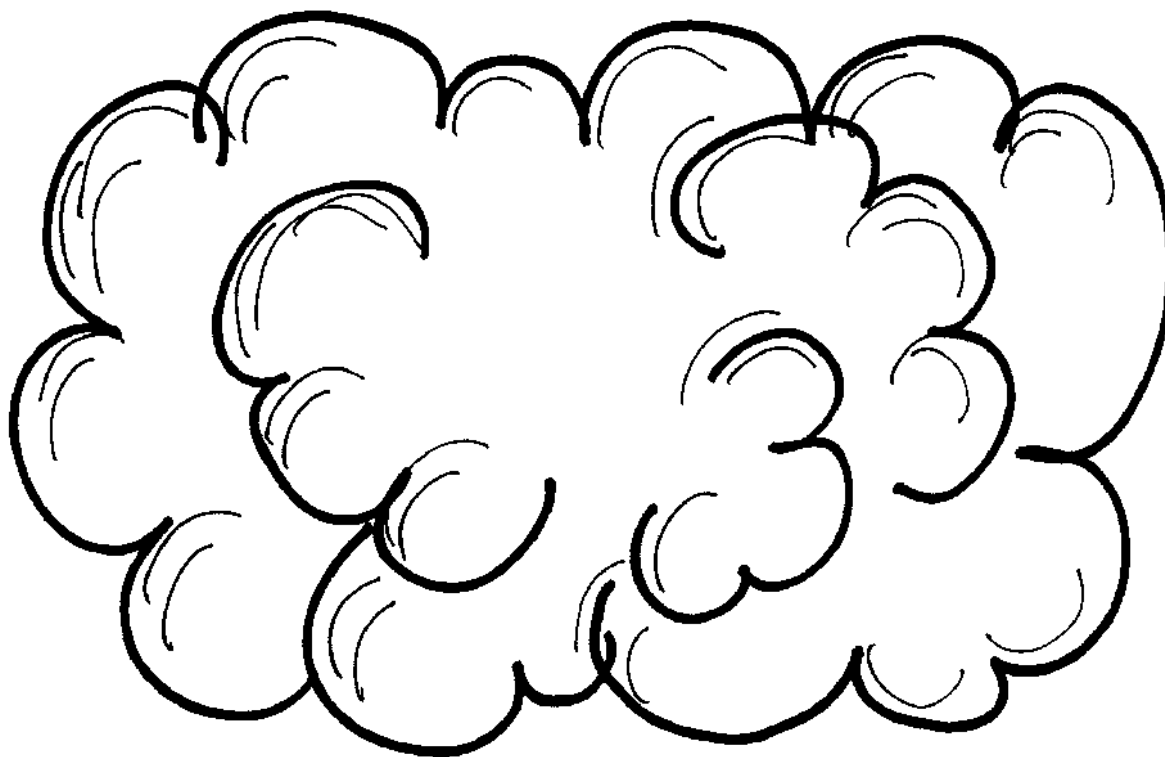

Teacher: Use with Lesson Four, Page 6. Copy, cut out, and mount on craft stick to make puppet. Color and mount on tag board if desired.

Fire Fighter, Hat, Coat and Boots Cutout

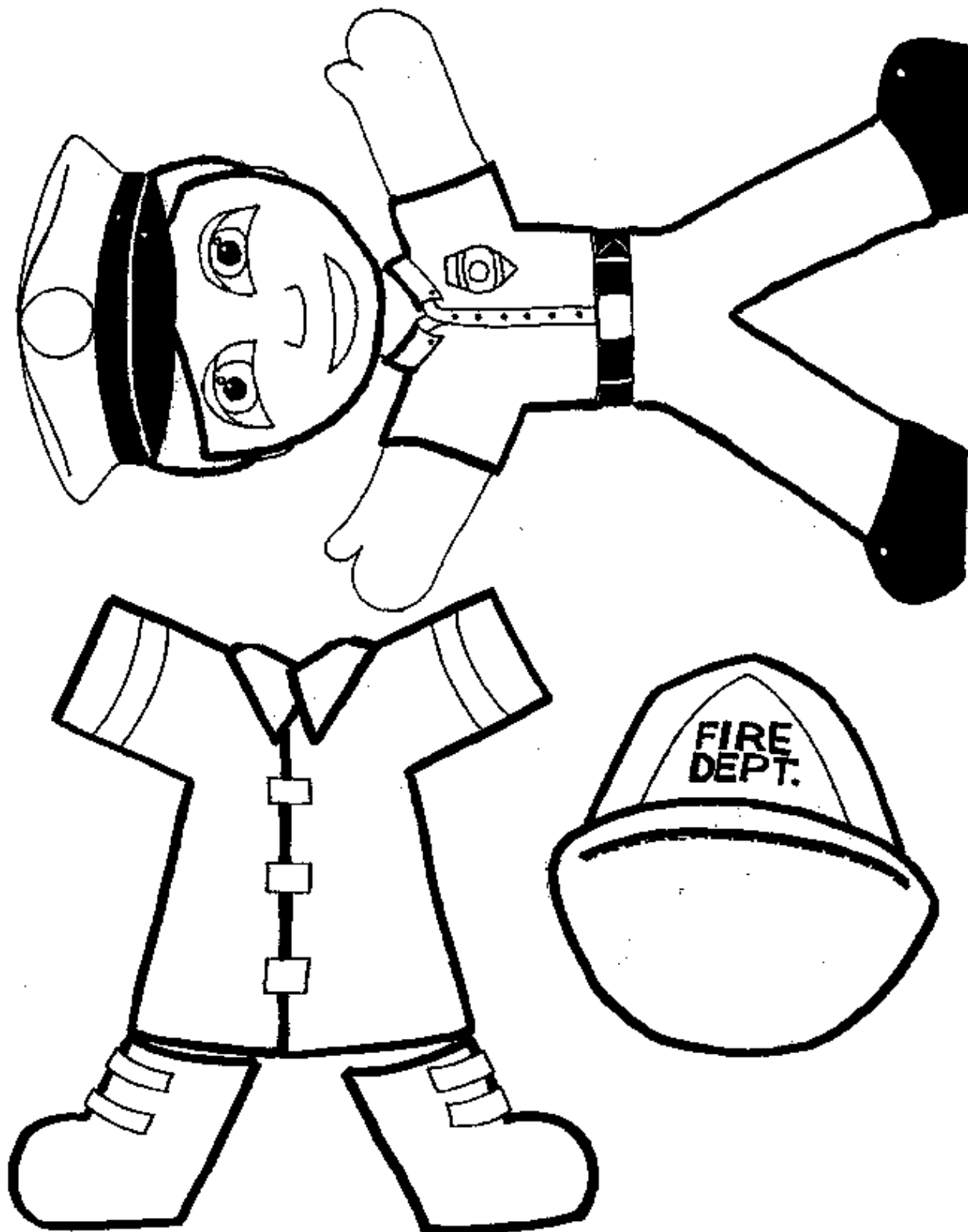

Teacher: Use with Lesson Five, Page 7. For demonstration, copy, color and cut out. For student activity, reproduce entire sheet.

Name _____

Kindergarten: Fire Safe Together

POST-TEST

1.

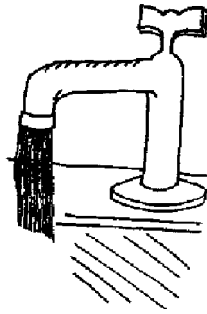

H

C

2.

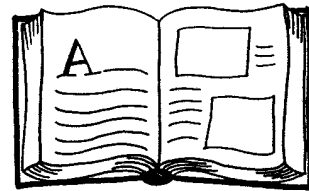
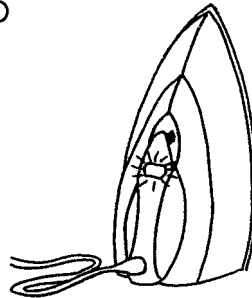

3.



4.

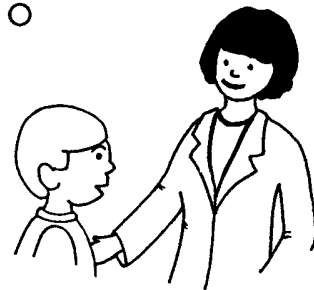
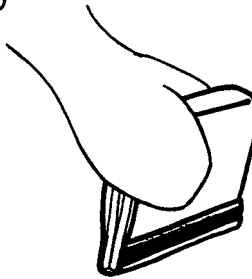
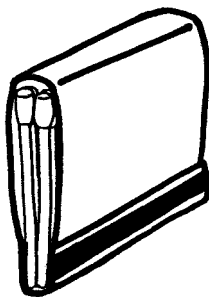

5.

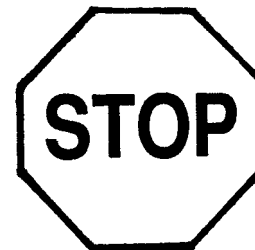

6.

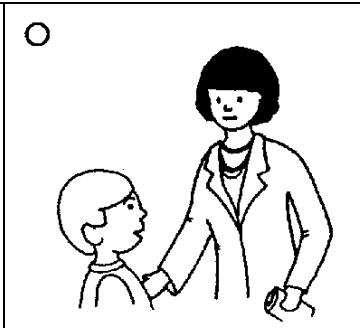
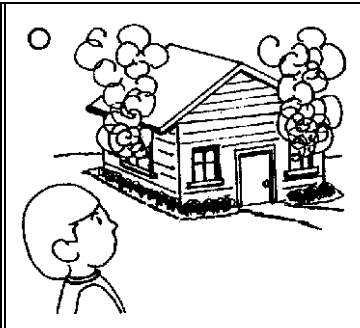
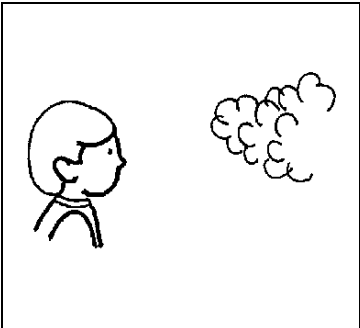

7.

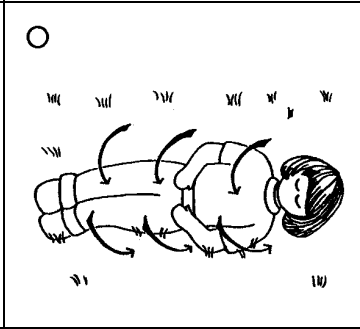
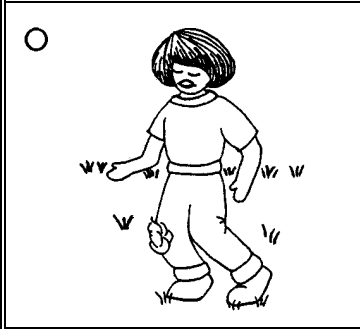
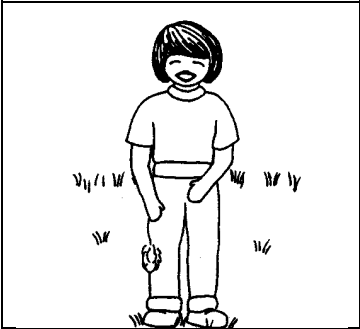

8.

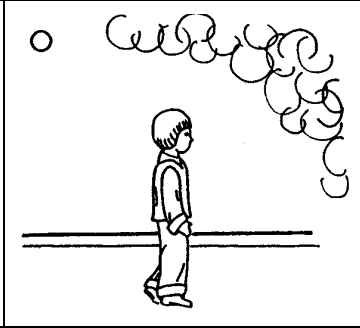
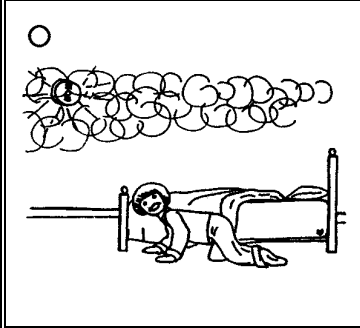
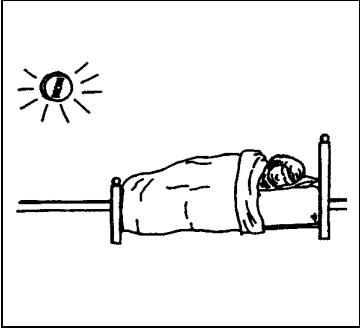

9.



YES

NO

10.

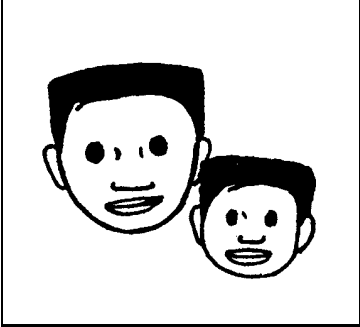

YES

NO

Teacher: Use following Lesson Five, Page 7. Duplicate for student use. Use questions on Page 9.

ANSWER KEY-1

1.		H	C
2.			
3.			
4.			
5.		EXIT	STOP

6.			
2.			
6.			
2.		YES	NO
10.		YES	NO



What's Hot? What's Not?
We end cold clothes with hot list.

Watch Out! It's Hot!
Fire hazard recognition and classification activity sheet

ANSWER KEY-2



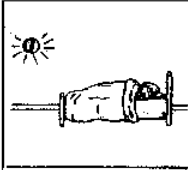
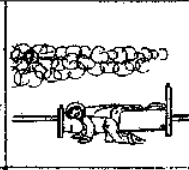
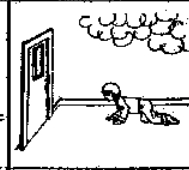
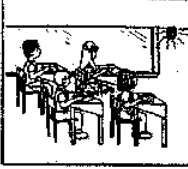
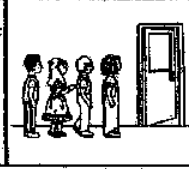

Getting Out

Emergency Response Sequencing Activity Sheet

Good Actions

Emergency Response Sequencing and Aid Activity Sheet

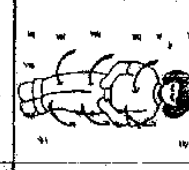
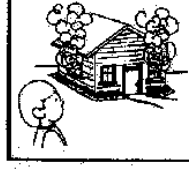

**Student Materials —
Duplicating Masters**

Name _____

What's Hot? What's Not?

Hot and cold classification activity sheet

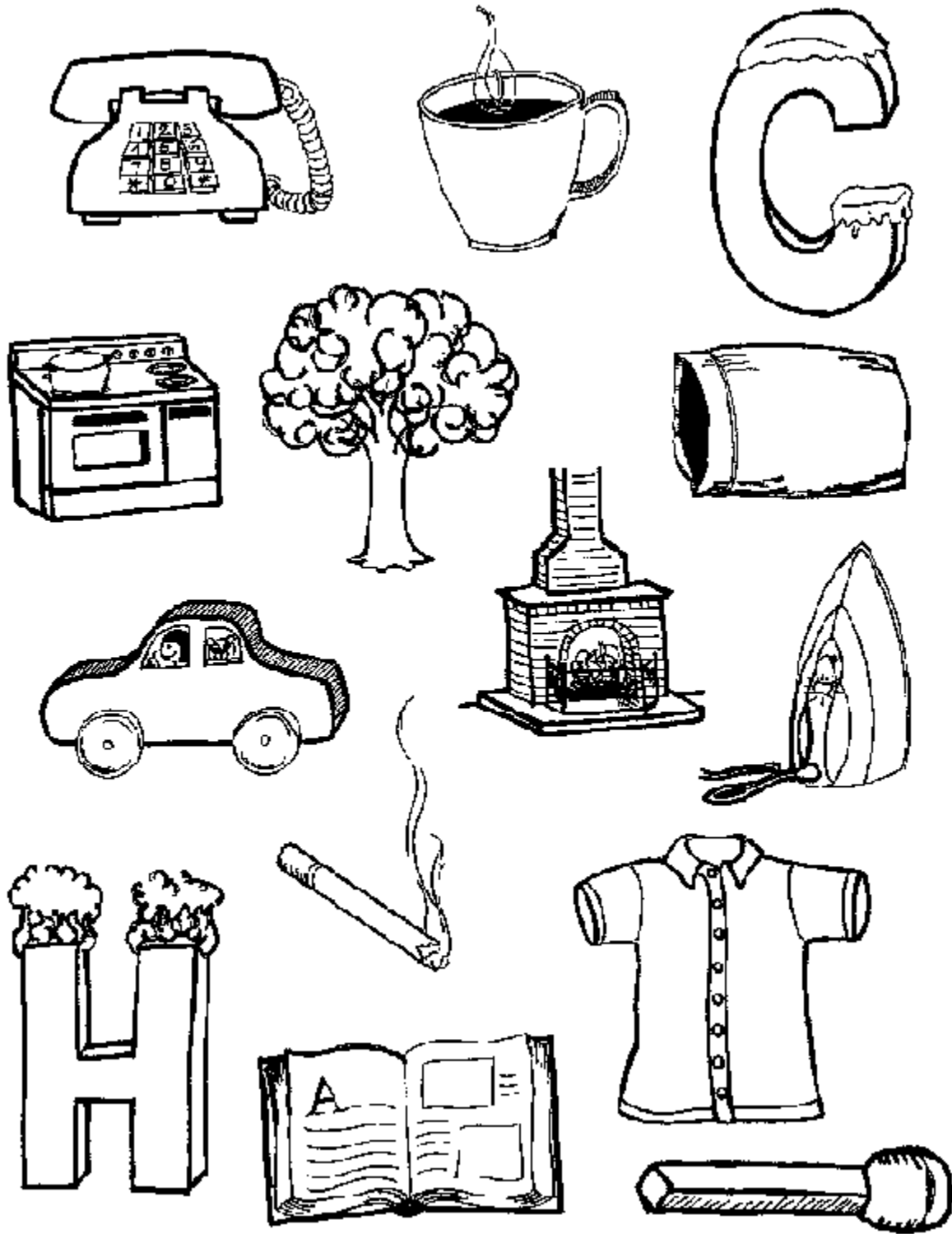

Teacher: Use with Lesson One, Page 3. Duplicate for student use. Student directions: circle all cold objects in blue and put Xs on all hot objects.

Name _____

Watch Out! It's Hot!

Fire hazard recognition and classification activity sheet

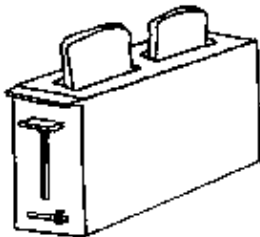
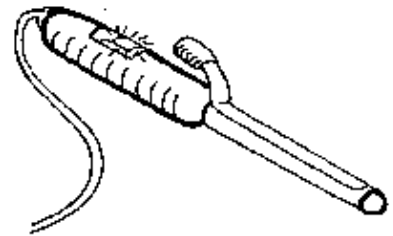
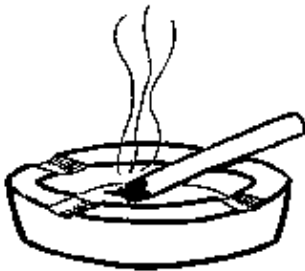
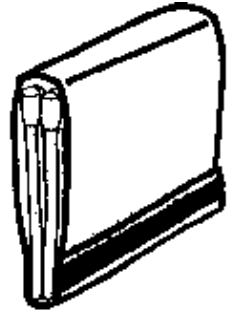

Teacher: Use with Lesson Two, Page 4. Duplicate for student use. Student directions: Draw a line from Red Hot Flame to all hot objects. Draw a line from the Safety Kid to all safe objects. Color useful hot objects yellow.

Name _____

Getting Out!

Emergency response sequencing activity sheet

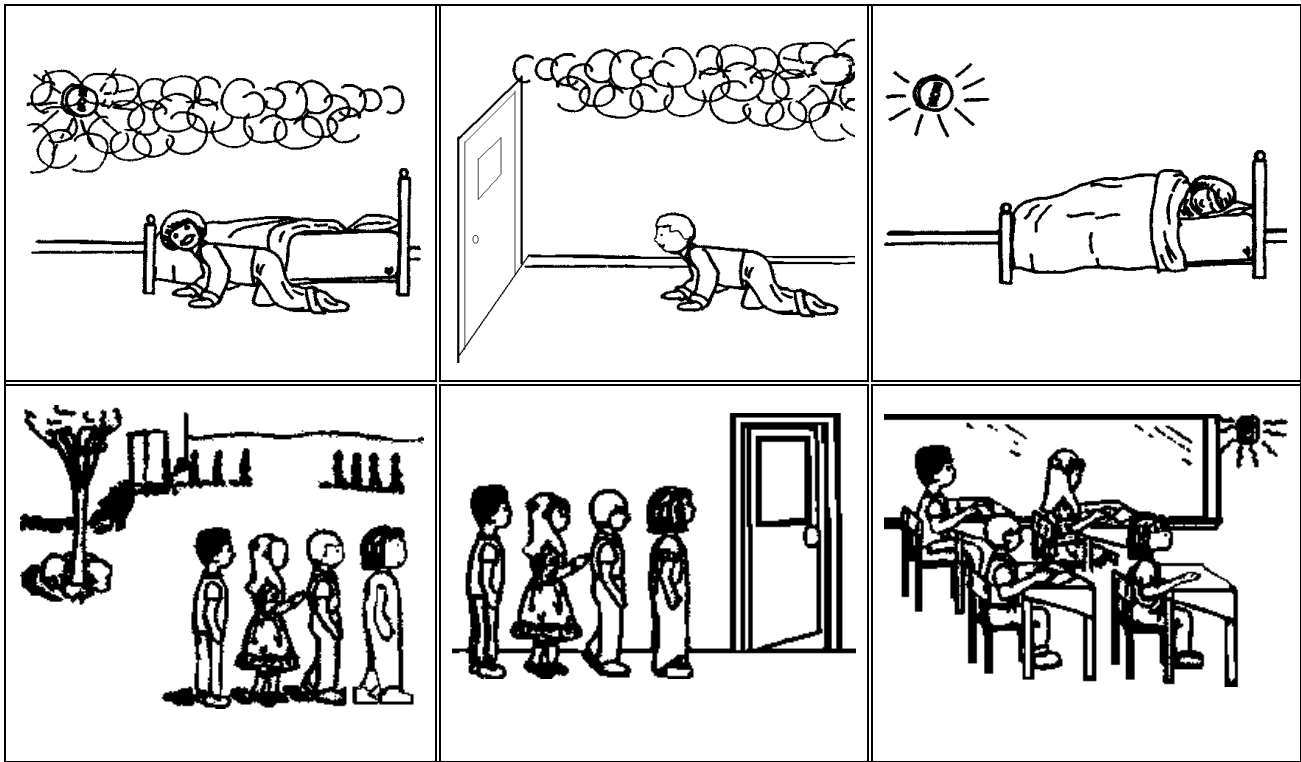

Teacher: Use with Lesson Three. Page 5. Duplicate for student use. Student directions: Cut apart pictures at the bottom of the page. Put in order to show two sequences, and glue at the top of the page.

Name _____

Good Actions

Emergency response sequencing activity sheet

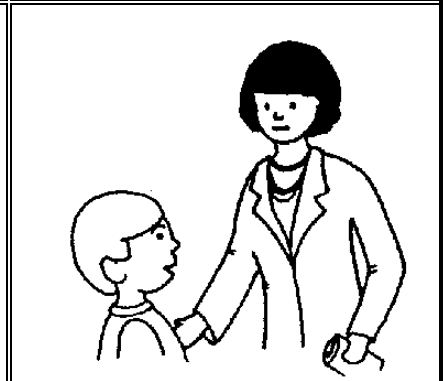
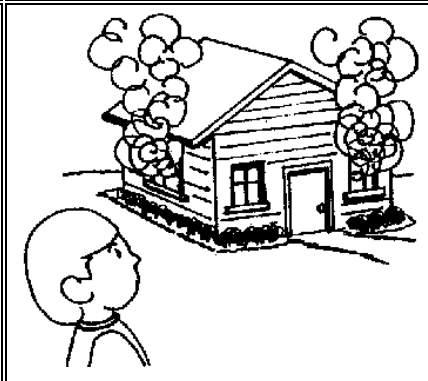
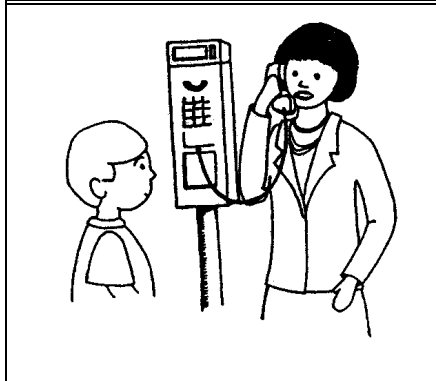
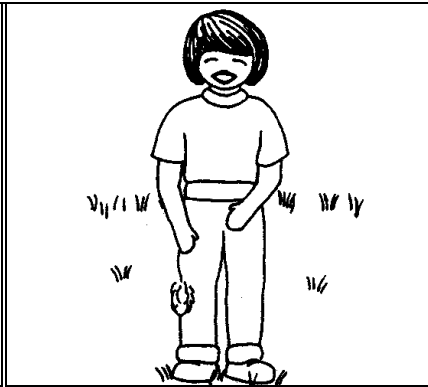
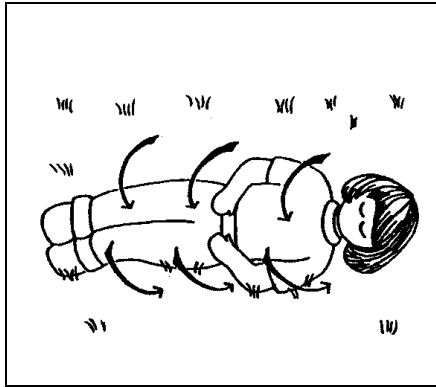

Teacher: Use with Lesson Four, Page 6. Duplicate for student use. Student directions: Cut apart pictures at the bottom of the page. Put in order to show two sequences, and glue at the top of the page.

Name _____

Fire Fighter, Hat, Coat and Boots Cutout

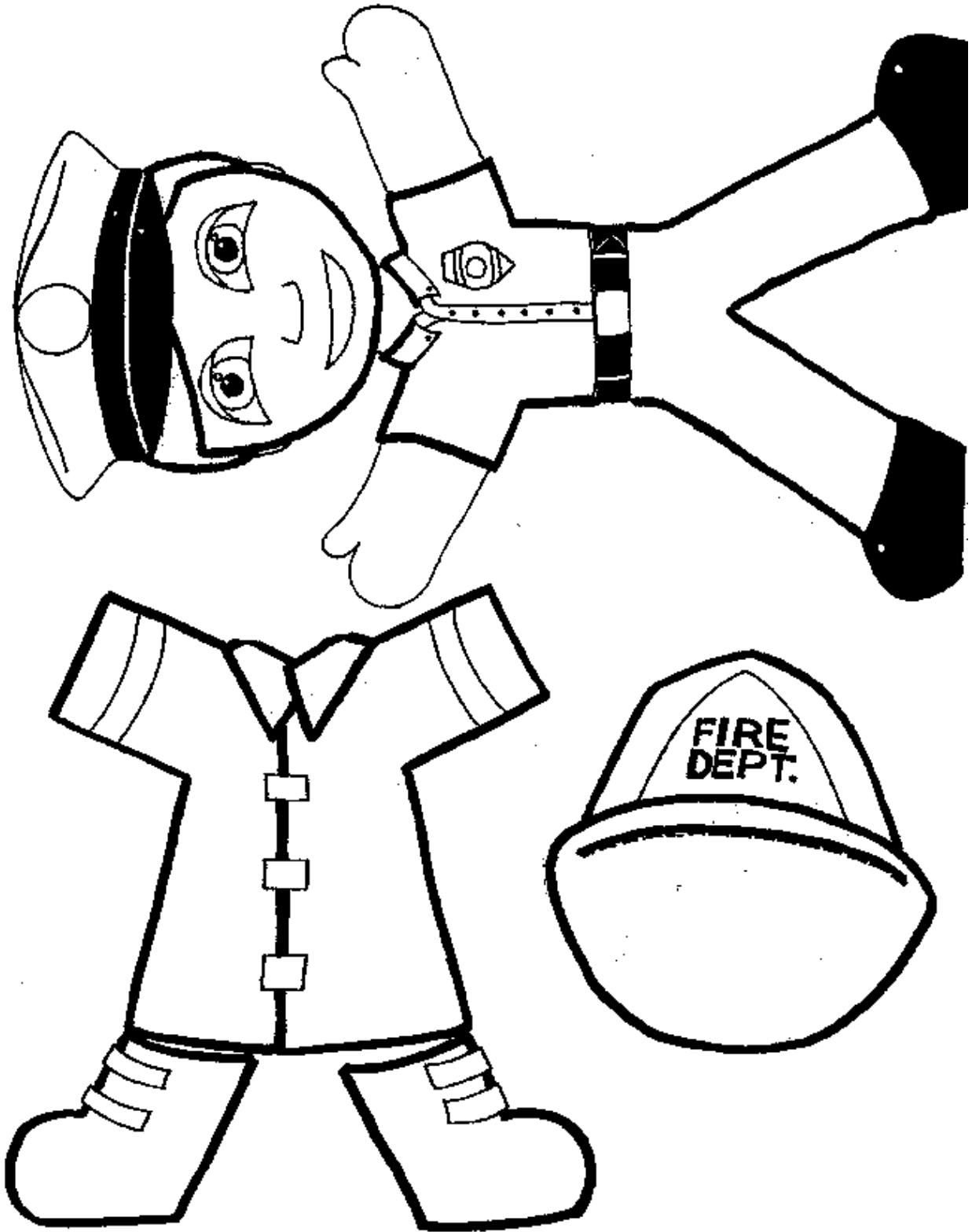

Teacher: Use with Lesson Five, Page 7. For demonstration, color and cut out. For student activity, reproduce entire sheet.

Name _____

"Keep Me Safe" Activity Sheet



Remove fire and burn hazards.

Keep matches stored safely away from children's reach.



KEEP ME SAFE



Check the smoke detector once a month.

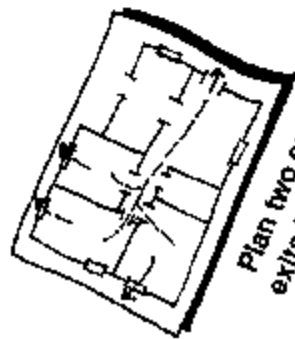

Plan two emergency exits from each room, and have exit drills.

Teacher: Use with Lesson Five, Page 7. Duplicate for student use. Student directions: Color and take to parents/guardians

Name _____

Fire Safety Rules For Baby-Sitters

Parents: To help keep your children safe from fire, review this information with your baby-sitter and your children. Then post in a prominent place to help everyone remember the rules for staying fire safe.

~ **Always watch the child(ren).** Never leave them alone in a room, especially in the kitchen or bathroom, even for "a second."

⇒ Our emergency exit routes are (tell plan for how to leave from each room) _____

Our meeting place (where to meet outdoors after emergency exit): _____

😊 Rules for cooking (check one):

- No cooking is allowed.
- Cooking is allowed with these rules: _____

| Fire extinguisher is located: _____

NO matches or lighters. NO smoking.

✓ If bathing the children, these actions help prevent scalds:

- Fill tub first. Don't let children in tub while water is running.
- Check temperature by immersing your arm up to the elbow.

☎ Emergency telephone numbers:

Where we will be: _____

Fire department: _____

Police: _____

Ambulance: _____

Neighbor/relative: _____

Teacher: Use with Lesson Five, Page 7. Duplicate, and have students take home to parents/guardians.