

IN/  
DO  
ORS

IN/  
EVOLUTION  
INNOVATION

**mobil** 

IN/  
DO  
ORS

IN/  
EVOLUTION  
INNOVATION

|||obilE



*What does it mean?*

/

# WHERE TECHNOLOGY MEETS DESIGN

DESIGN TECHNOLOGY - Innovation



/

# AMBRA

SMART LIVING

Nuove esperienze Smart e Design minimalista per un classico sempre attuale.

New smart experiences and minimalist design for a timeless classic.

Nouvelles expériences intelligentes et design minimaliste pour un classique intemporel.



# / MATT MATERIAL

DESIGN TECHNOLOGY - In progress

Un'esperienza nuova e raffinata  
che arricchisce le soluzioni di arredo

A new fine experience which  
enriches furnishing solutions

Une expérience nouvelle et raffinée  
qui enrichit les solutions d'ameublement



# / POLAR

DESIGN TECHNOLOGY - In evolution



L'eleganza e la semplicità della finitura Polar si esaltano in un interior design dedicato alla luminosità grazie al nuovo delicato pattern ed alla sua versione ortogonale.

The elegance and simplicity of Polar is intensified in a light-oriented interior design thanks to this delicate new pattern and its orthogonal version.

L'élégance et la simplicité du Polar s'intensifient dans un design intérieur orienté vers la lumière, grâce à ce nouveau motif et à sa version orthogonale.

# / WHY ?



tecnologia  
technology  
technologie



innovazione  
innovation  
innovation



design  
design  
design



funzionalità  
functionality  
fonctionnalité



adattabilità  
adaptability  
adaptabilité



high-tech  
high-tech  
high-tech



affidabilità  
reliability  
fiabilité



ricerca estetica  
aesthetic research  
recherche esthétique



ampia gamma  
broad selection  
large sélection

# Because it's design technology!



**Touch.** La texture delle nostre superfici conferisce delle proprietà tattili uniche ed esclusive al nostro prodotto.

**Touch.** The texture of our surfaces gives unique and exclusive tactile properties to our products.

**Touch.** La texture des surfaces confère à nos produits des propriétés tactiles uniques et exclusives.



**Adattabilità.** Gli avanzati processi di produzione di Mobil3 consentono di ottenere pannelli con altezze maggiorate e stipiti adattabili su più spessori di muro.

**Adaptability.** Advanced manufacturing processes allow Mobil3 to produce higher panels and jamps suitable for different wall thicknesses.

**Adaptabilité.** Le processus de fabrication avancé permet à Mobil3 de produire vantaux plus hauts et jambages adaptés à différentes épaisseurs de murs.



**Ricerca e innovazione.** Le finiture sono il fiore all'occhiello dell'azienda: la nostra ampia gamma viene costantemente rinnovata grazie ad un assiduo e attivo processo di ricerca e sviluppo.

**Research and Innovation.** Finishes are the company's crowning point: our wide selection is constantly renovated thanks to an active and regular research and development process.

**Recherche et Innovation.** Les finitions sont le couronnement de l'entreprise: notre large sélection est constamment renouvelée grâce à un processus de recherche et développement actif et régulier.



**Affidabilità.** La fiducia del cliente è il nostro obiettivo, forti della nostra esperienza e puntualità.

**Reliability.** Our goal is clients' trust, on the strength of our experience and accuracy.

**Fiabilità.** Notre objectif est la confiance des clients, grâce à notre expérience et ponctualité.



**Ambiente.** I nostri processi produttivi sono progettati nel rispetto per l'ambiente, per un impatto ecosostenibile a 360°.

**Environment.** Our manufacturing process is thought to be environmentally friendly.

**Environnement.** Notre processus de fabrication est pensé pour être écologique.



**Finiture innovative.** Materiali innovativi, design e qualità tecnologica.

**Innovative Finishes.** Design finishes made with technologically advanced, high quality materials.

**Finitions Innovatives.** Finitions fabriquées avec des matériaux de haute qualité et technologiquement avancés.



/  
COLLECTION

# INDEX



**/ 16**  
DESIGN  
COLLECTION



**/ 40**  
CONTEMPORANEO  
COLLECTION



**/ 72**  
SOLUZIONI  
DI APERTURA  
Opening solutions  
Solutions d'ouverture



**/ 86**  
VETRI  
Glasses  
Verres



**/ 96**  
MANIGLIE  
Handles  
Poignées

/  
COLLECTION

# DESIGN

/

DIVERSE FINITURE NE ESALTANO LA MATERICITÀ E L'ELEGANZA, SPRIGIONANDO TUTTA LA MAGNIFICENZA NELLE SOLUZIONI D'ARREDO CHE DEFINISCONO ED ESALTANO LO SPAZIO.

VARIOUS FINISHES INTENSIFY THE MATERIALITY AND ELEGANCE OF DOORS, RELEASING MAGNIFICENCE IN FURNISHING SOLUTIONS WHICH DEFINE AND ENHANCE SPACES.

DIFFÉRENTES FINITIONS EN FONT RESSORTIR LA TEXTURE ET L'ÉLÉGANCE, EMBELLISSANT AINSI TOUTES LES SOLUTIONS D'AMEUBLEMENT QUI DÉFINISSENT ET EXALTENT LES ESPACES.



**/ 18**  
REAL WOOD



**/ 32**  
MATERIA



**/ 38**  
COLOR

/

## HEIGHT

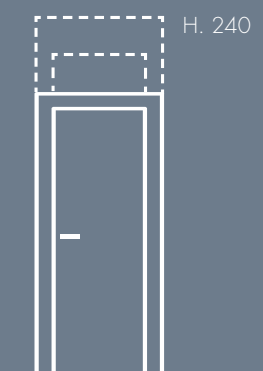

DETTAGLI **TECNICI** A PAG. 42-43 / TECHNICAL DETAILS PAGE 42-43 / DÉTAILS TECHNIQUES PAGE 42-43

# / REAL WOOD

UNA SOLUZIONE PER  
AMBIENTI AMPI E LUMINOSI

THE SOLUTION FOR WIDE  
AND BRIGHT INDOOR SPACES

UNE SOLUTION POUR ENVIRONNEMENTS  
LARGES ET LUMINEUX

## 0103

Cerniere Anuba  
Anuba hinges  
Charnières type Anuba

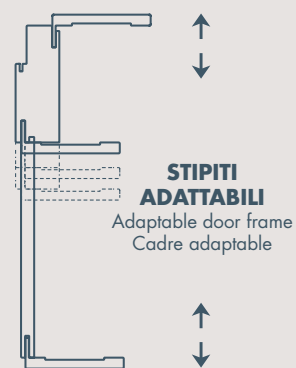

## 0104

Cerniere a scomparsa  
Concealed hinges  
Charnière invisibles

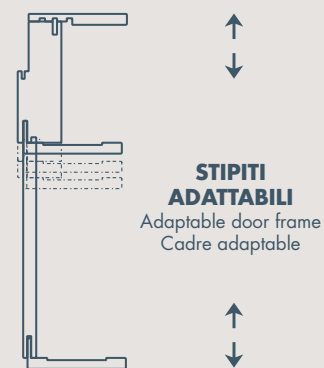

## 0105

Apertura Filo Lato Spingere  
Pushing Side Flush Door  
Vantail Fil Couloir

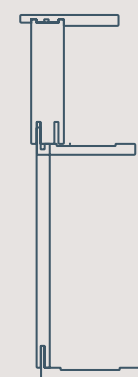

Per muro 11, 13 e 15 cm realizziamo lo stipite in pezzo unico.  
Per muri più spessi forniamo il Kit allargamento tagliato a misura.

We provide a single piece door frame for wall thicknesses of 11, 13, and 15 cm.  
We provide cut-to-size extensions for thicker walls.

Nous fournissons des cadres en pièce unique pour épaisseurs de murs de 11, 13 et 15 cm.  
Nous fournissons des élargissement sur mesure pour des murs plus épais.

## CORDA

CORDA  
CORDA



## DAKOTA

DAKOTA  
DAKOTA



## SMOKE

SMOKE  
SMOKE



## NORDIC

NORDIC  
NORDIC



## POLAR

POLAR  
POLAR

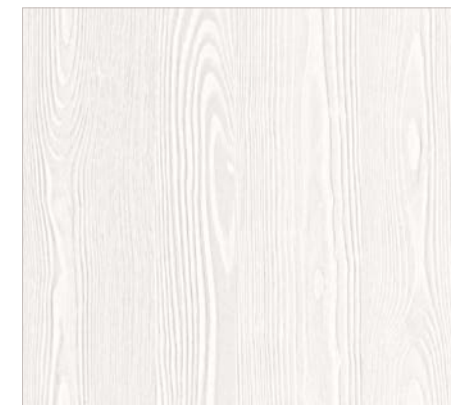

## POLAR ORTHOGONAL

POLAR ORTHOGONAL  
POLAR ORTHOGONAL





/  
REAL WOOD  
**CORDA**

MOD.  
**M3-DESIGN01**

STIPITE / JAMB / JAMBAGE  
**M3-0103**

FINITURA / FINISH / FINITION  
**CORDA**

/  
REAL WOOD  
**DAKOTA**

MOD.  
**M3-DESIGN01**

STIPITE / JAMB / JAMBAGE  
**M3-0104**

FINITURA / FINISH / FINITION  
**DAKOTA**



/  
REAL  
WOOD  
NORDIC

MOD.  
M3-DESIGN01

STIPITE / JAMB / JAMBAGE  
M3-0104

FINITURA / FINISH / FINITION  
NORDIC



/  
REAL WOOD  
NORDIC

MOD.  
M3-DESIGN01

STIPITE / JAMB / JAMBAGE  
M3-0105

FINITURA / FINISH / FINITION  
NORDIC



/  
REAL WOOD  
**SMOKE**

MOD.  
**M3-DESIGN01**

SCORREVOLE ESTERNO MURO TIPO "F"  
EXTERNAL SLIDING "F" VERSION  
COULISSANTE EXTÉRIEUR MUR VERSION "F"

FINITURA / FINISH / FINITION  
**SMOKE**



/  
REAL WOOD  
**POLAR**

MOD.  
**M3-DESIGN01**

STIPITE / JAMB / JAMBAGE  
**M3-0104**

FINITURA / FINISH / FINITION  
**POLAR**





/  
REAL WOOD  
**POLAR ORTHOGONAL**

MOD.  
**M3-DESIGN01**

STIPITE / JAMB / JAMBAGE  
**M3-0104**

FINITURA / FINISH / FINITION  
**POLAR ORTHOGONAL**



# / MATERIA

**MATERIA  
BLANC**

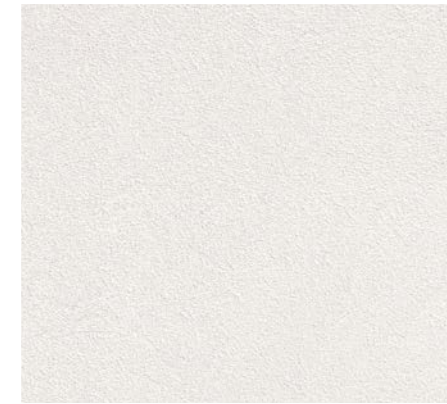

**MATERIA  
GRIS**



**MATERIA  
BEIGE**



CON LE FINITURE MATERIA  
SI APRE UN NUOVO  
CAPITOLO DEDICATO  
ALLA MATERICITÀ DELLE  
SUPERFICI;  
UN'ESPERIENZA  
NUOVA RAFFINATA  
CHE ARRICCHISCE LE  
SOLUZIONI D'ARREDO.

WE ARE STARTING A NEW  
CHAPTER DEDICATED TO  
SURFACES' MATERIALITY  
WITH MATERIA FINISHES;  
A NEW FINE EXPERIENCE  
WHICH ENRICHES  
FURNISHING SOLUTIONS.

NOUS COMMENÇONS  
UN NOUVEAU CHAPITRE  
DÉDIÉ À LA MATÉRIALITÉ  
DES SURFACES AVEC LES  
FINITIONS MATERIA. UNE  
NOUVELLE EXPÉRIENCE QUI  
ENRICHIT LES SOLUTIONS  
D'AMÉNAGEMENT.



/  
MATERIA  
**BLANC**

MOD.  
**M3-DESIGN01**

STIPITE / JAMB / JAMBAGE  
**M3-0104**

FINITURA / FINISH / FINITION  
**BLANC**

/  
MATERIA  
**BEIGE**

MOD.  
**M3-DESIGN01**

STIPITE / JAMB / JAMBAGE  
**M3-0104**

FINITURA / FINISH / FINITION  
**BEIGE**

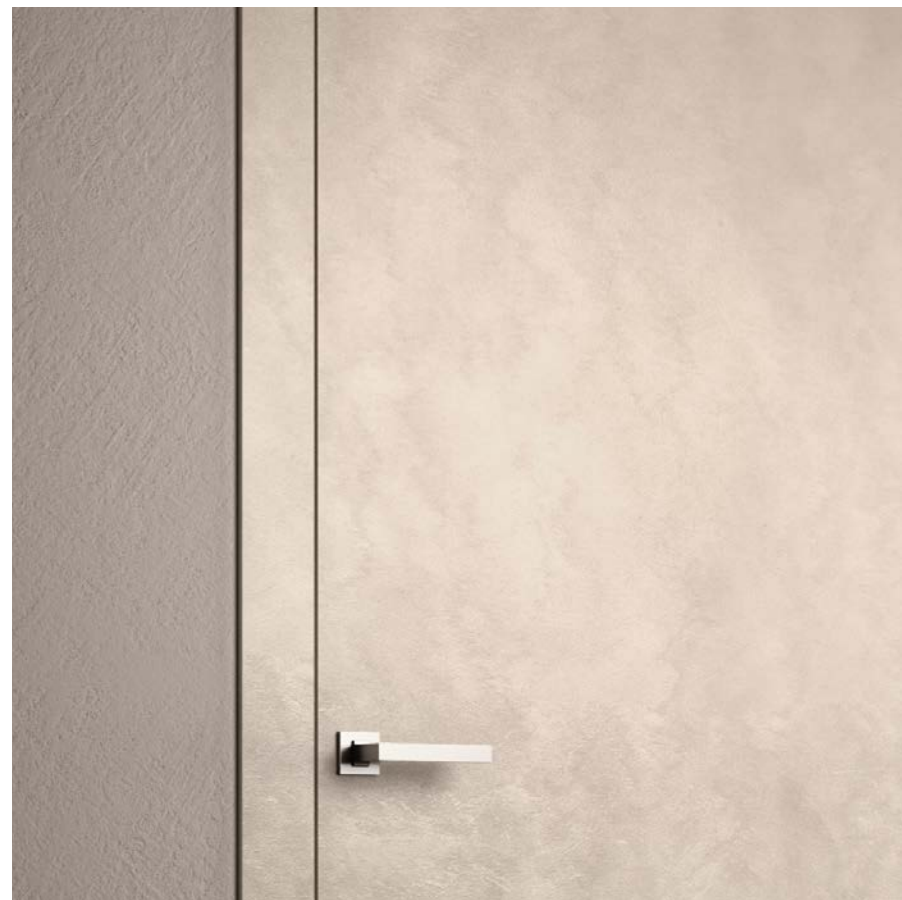

# / COLOR

## AMBRA

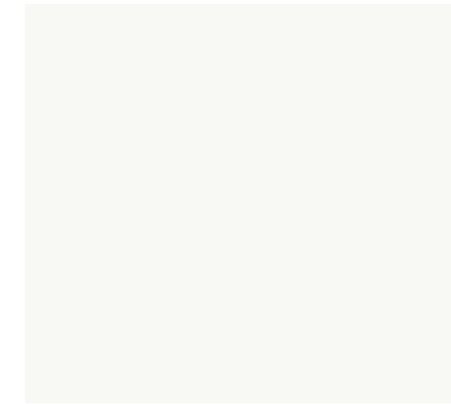

COLORI PASTELLO RIVISITATI  
IN UN DESIGN MODERNO  
E SENZA TEMPO PER LA  
NUOVA COLLEZIONE  
COLOR.

PASTEL COLOURS  
REINTERPRETED IN A  
MODERN AND TIMELESS  
DESIGN FOR THE NEW  
COLOR COLLECTION.

TONS PASTEL  
RÉINTERPRÉTÉS DANS  
UN DESIGN MODERNE  
ET INTEMPOREL POUR LA  
NOUVELLE COLLECTION  
COLOR.



/  
COLOR  
**AMBRA**

MOD.  
**M3DESIGN01**

STIPITE / JAMB / JAMBAGE  
**M3-0104**

FINITURA / FINISH / FINITION  
**AMBRA**

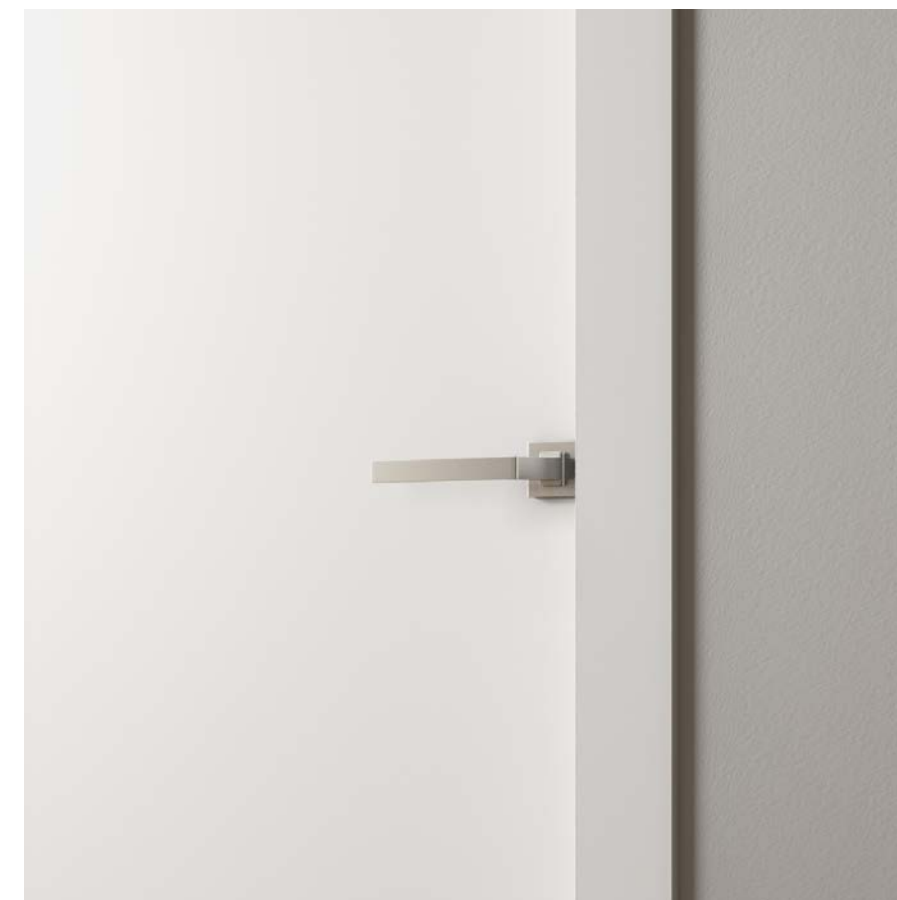

# / DETTAGLI TECNICI

TECHNICAL DETAILS  
DÉTAILS TECHNIQUES

STIPITE  
JAMB  
JAMBAGE  
**0103**

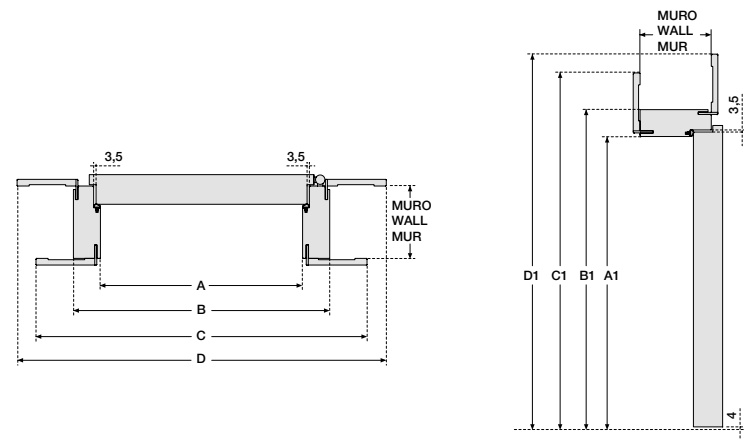

A / A1	B	C	D	B1	C1	D1
Passaggio luce Clear width Net passage	Misura esterno telaio Rough opening Dimension extérieur caisse	Misura esterno coprifilo 1 External casing 1 Dimension extérieur linteaux 1	Misura esterno coprifilo External casing Dimension extérieur linteaux	Misura esterno telaio Rough opening Dimension extérieur caisse	Misura esterno coprifilo 1 External casing 1 Dimension extérieur linteaux 1	Misura esterno coprifilo External casing Dimension extérieur caisse
-	<b>A</b> +80 mm	<b>A</b> +190 mm	<b>A</b> +248 mm	<b>A1</b> +40 mm	<b>A1</b> +95 mm	<b>A1</b> +124 mm

# / DETTAGLI TECNICI

TECHNICAL DETAILS  
DÉTAILS TECHNIQUES

STIPITE  
JAMB  
JAMBAGE  
**0105**

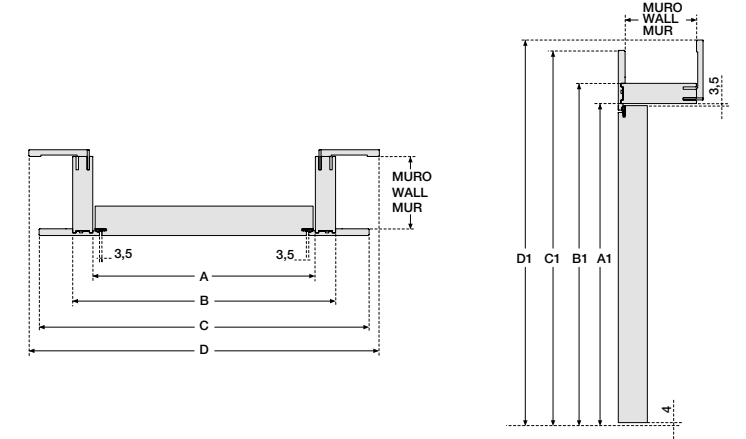
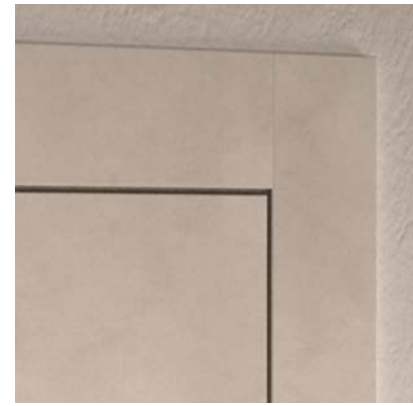

A / A1	B	C	D	B1	C1	D1
Passaggio luce Clear width Net passage	Misura esterno telaio Rough opening Dimension extérieur caisse	Misura esterno coprifilo 1 External casing 1 Dimension extérieur linteaux 1	Misura esterno coprifilo External casing Dimension extérieur linteaux	Misura esterno telaio Rough opening Dimension extérieur caisse	Misura esterno coprifilo 1 External casing 1 Dimension extérieur linteaux 1	Misura esterno coprifilo External casing Dimension extérieur caisse
-	<b>A</b> +80 mm	<b>A</b> +180 mm	<b>A</b> +190 mm	<b>A1</b> +40 mm	<b>A1</b> +90 mm	<b>A1</b> +105 mm

STIPITE  
JAMB  
JAMBAGE  
**0104**

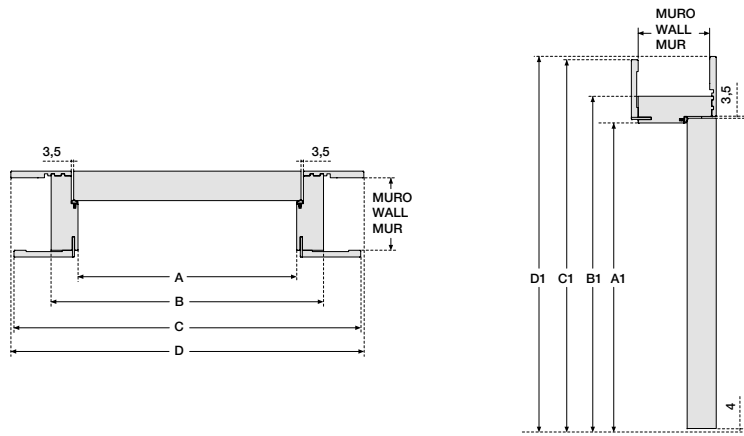

A / A1	B	C	D	B1	C1	D1
Passaggio luce Clear width Net passage	Misura esterno telaio Rough opening Dimension extérieur caisse	Misura esterno coprifilo 1 External casing 1 Dimension extérieur linteaux 1	Misura esterno coprifilo External casing Dimension extérieur linteaux	Misura esterno telaio Rough opening Dimension extérieur caisse	Misura esterno coprifilo 1 External casing 1 Dimension extérieur linteaux 1	Misura esterno coprifilo External casing Dimension extérieur linteaux
-	<b>A</b> +80 mm	<b>A</b> +190 mm	<b>A</b> +200 mm	<b>A1</b> +40 mm	<b>A1</b> +95 mm	<b>A1</b> +100 mm

**CERNIERA ANUBA**  
ANUBA HINGES  
CHARNIÈRES ANUBA



**CERNIERA A SCOMPARSA K8000**  
CONCEALED HINGES K8000  
CHARNIÈRES INVISIBLES K8000



/  
COLLECTION

# CONTEMPORANEO

Contemporary  
Contemporaine

/

PORTE CHE INCONTRANO IL GUSTO DI CHI È ALLA RICERCA DI MODERNITÀ/CONTEMPORANEITÀ. AMPIA VARIETÀ DI MODELLI IN TANTI COLORI E FINITURE.

DOORS THAT MEET THE TASTE OF THOSE LOOKING FOR MODERN AND CONTEMPORARY SOLUTIONS WITH A WIDE VARIETY OF MODELS AND COLOURS.

PORTES QUE RENCONTRENT LE GOÛT DE CEUX QUI SONT À LA RECHERCHE DE LA MODERNITÉ ET CONTEMPORANÉITÉ.

DETTAGLI **TECNICI** A PAG. 70-71 / TECHNICAL DETAILS PAGE 70-71 / DÉTAILS TECHNIQUES PAGE 70-71



# / TRAMA

## 0100

Cerniere Anuba  
Anuba hinges  
Charnières type Anuba

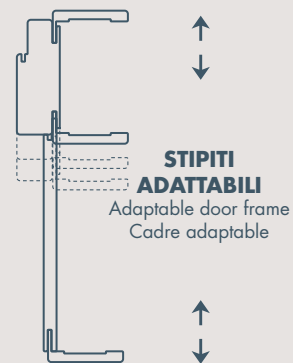

## 0102-NEW

Cerniere a scomparsa  
Concealed hinges  
Charnière invisibles

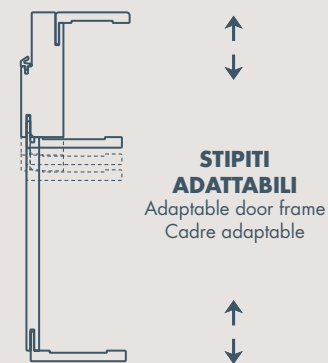

Per muro 11, 13 e 15 cm realizziamo lo stipite in pezzo unico.  
Per muri più spessi forniamo il Kit allargamento tagliato a misura.

We provide a single piece door frame for wall thicknesses of 11, 13, and 15 cm.  
We provide cut-to-size extensions for thicker walls.

Nous fournissons des cadres en pièce unique pour épaisseurs de murs de 11, 13 et 15 cm.  
Nous fournissons des élargissement sur mesure pour des murs plus épais.

**BIANCO B011**  
WHITE B011  
BLANC B011

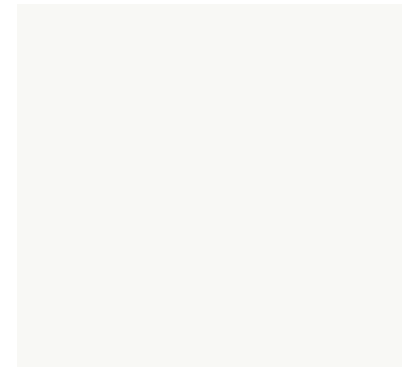

**PANNA B003**  
CREAM B003  
CRÈME B003

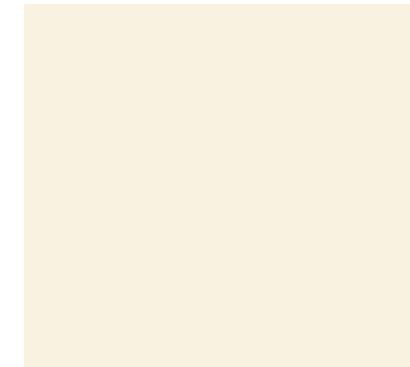

**NOCE LD57**  
WALNUT LD57  
NOYER LD57



**NOCE 840**  
WALNUT 840  
NOYER 840



**ROVERE LG23**  
OAK LG23  
CHÊNE LG23



**CILIEGIO LG69**  
CHERRY LG69  
CERISIER LG69



**MATRIX BIANCO B011**  
MATRIX WHITE B011  
MATRIX BLANC B011



**PALISSANDRO BIANCO 2302**  
WHITE ROSEWOOD 2302  
PALISSANDRE BLANC 2302



**FRASSINO B073**  
ASH B073  
CENDRE B073



**LARICE GRIGIO 1105**  
GREY LARCH 1105  
MÉLÈZE GRIS 1105



**GRANO LM36**  
WHEAT LM36  
BLÉ LM36



**PALISSANDRO GRIGIO LK55**  
GREY ROSEWOOD LK55  
PALISSANDRE GRIS LK55





/  
TRAMA  
**MATRIX**

MOD.  
**M3-1201**

STIPITE / JAMB / JAMBAGE  
**M3-0100**

FINITURA / FINISH / FINITION  
**MATRIX**



/  
TRAMA  
**LARICE**

MOD.  
**M3-1000**

STIPITE / JAMB / JAMBAGE  
**M3-0102**

FINITURA / FINISH / FINITION  
**LARICE GRIGIO / GREY LARCH / MÉLÈZE GRIS  
1105**





/  
TRAMA  
**GRANO**

MOD.  
**M3-1000**

STIPITE / JAMB / JAMBAGE  
**M3-0102**

FINITURA / FINISH / FINITION  
**GRANO / WHEAT / BLÉ**  
LM36

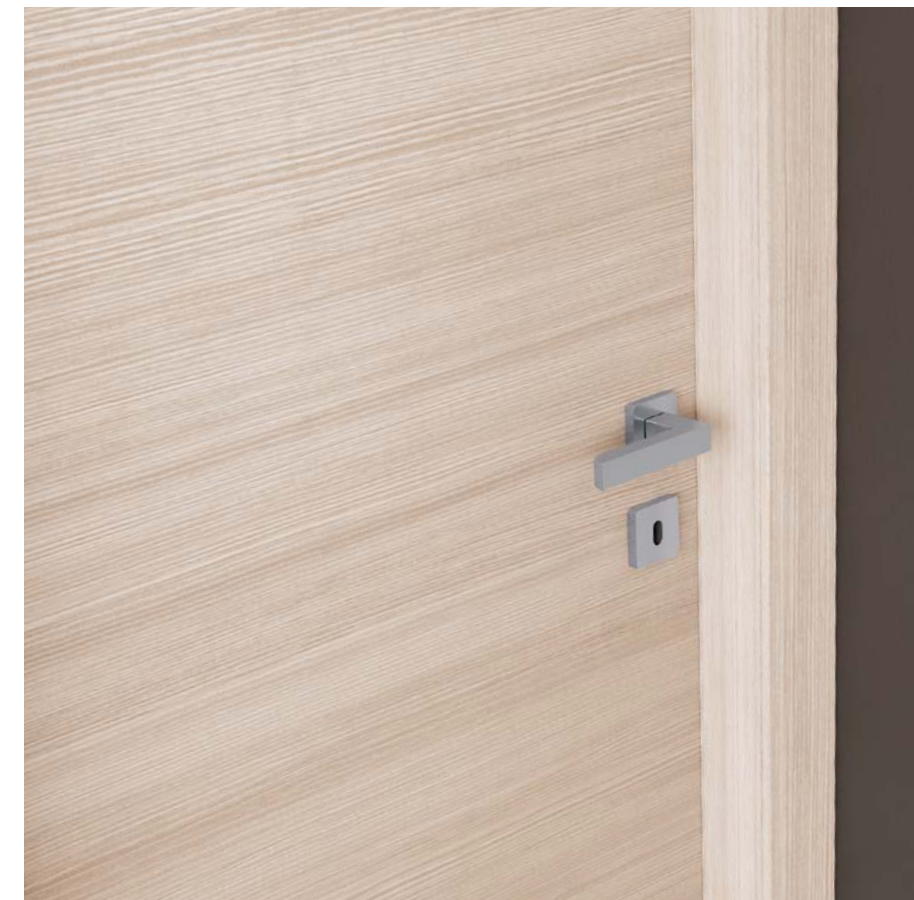

/  
TRAMA  
**MATRIX**

MOD.  
**M3-1000**

STIPITE / JAMB / JAMBAGE  
**M3-0102**

FINITURA / FINISH / FINITION  
**MATRIX**

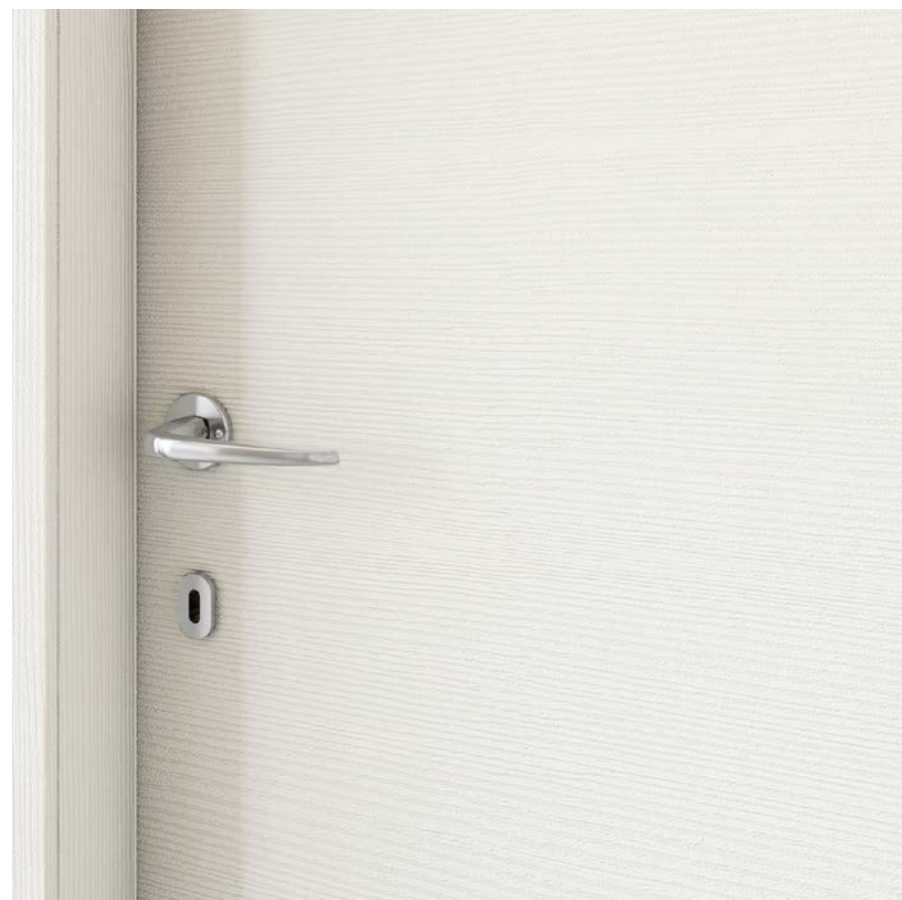



/  
TRAMA  
**FRASSINO**

MOD.  
**M3-1000**

STIPITE / JAMB / JAMBAGE  
**M3-0102**

FINITURA / FINISH / FINITION  
**FRASSINO / ASH / CENDRE  
B073**



/  
TRAMA  
**PALISSANDRO BIANCO**

MOD.  
**M3-1000**

STIPITE / JAMB / JAMBAGE  
**M3-0102**

FINITURA / FINISH / FINITION  
**PALISSANDRO BIANCO / WHITE ROSEWOOD / PALISSANDRE BLANC  
2302**





/  
TRAMA  
**PALISSANDRO GRIGIO**

MOD.  
**M3-1000**

STIPITE / JAMB / JAMBAGE  
**M3-0102**

FINITURA / FINISH / FINITION  
**PALISSANDRO GRIGIO / GREY ROSEWOOD / PALISSANDRE GRIS  
LK55**

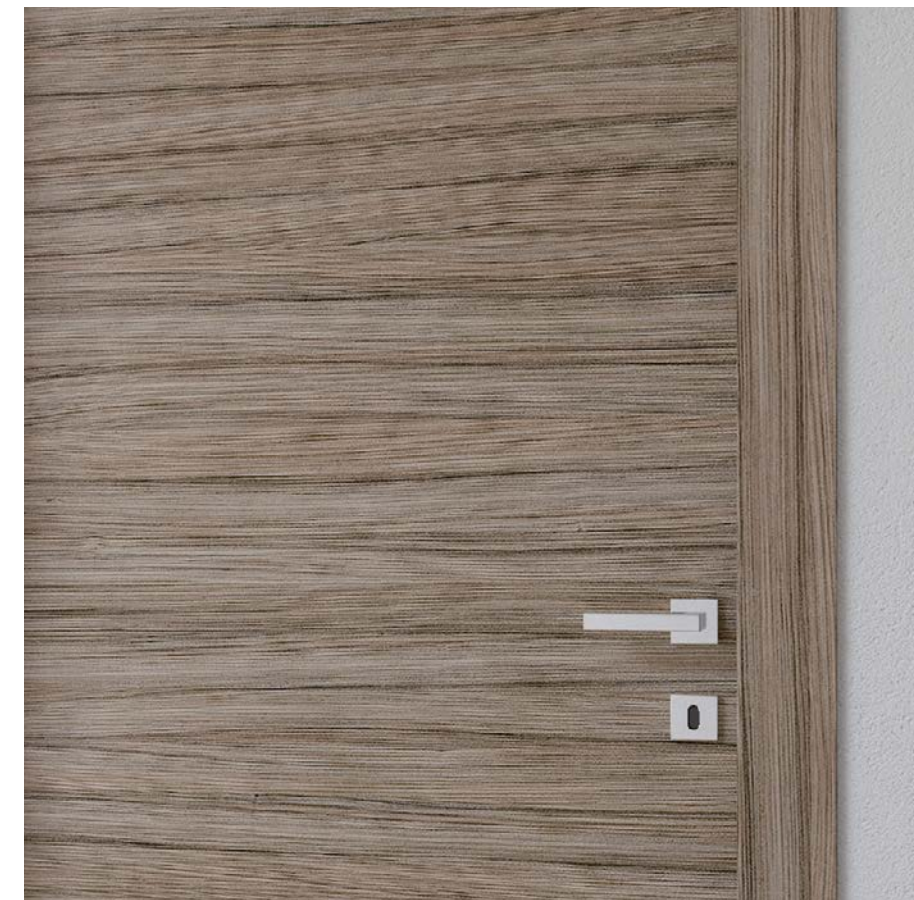



/  
TRAMA  
**ROVERE**

MOD.  
**M3-1000**

STIPITE / JAMB / JAMBAGE  
**M3-0100**

FINITURA / FINISH / FINITION  
**ROVERE / OAK / CHÊNE**  
**LG23**





/  
TRAMA  
**NOCE 840**

MOD.  
**M3-1000**

STIPITE / JAMB / JAMBAGE  
**M3-0100**

FINITURA / FINISH / FINITION  
**NOCE / WALNUT / NOYER**  
**840**

/  
TRAMA  
**NOCE 840**

MOD.  
**M3-1201**

STIPITE / JAMB / JAMBAGE  
**M3-0100**

FINITURA / FINISH / FINITION  
**NOCE / WALNUT / NOYER**  
**840**



/  
TRAMA  
**ROVERE**

MOD.  
**M3-120E**

STIPITE / JAMB / JAMBAGE  
**M3-0100**

FINITURA / FINISH / FINITION  
**ROVERE / OAK / CHÊNE**  
**LG23**

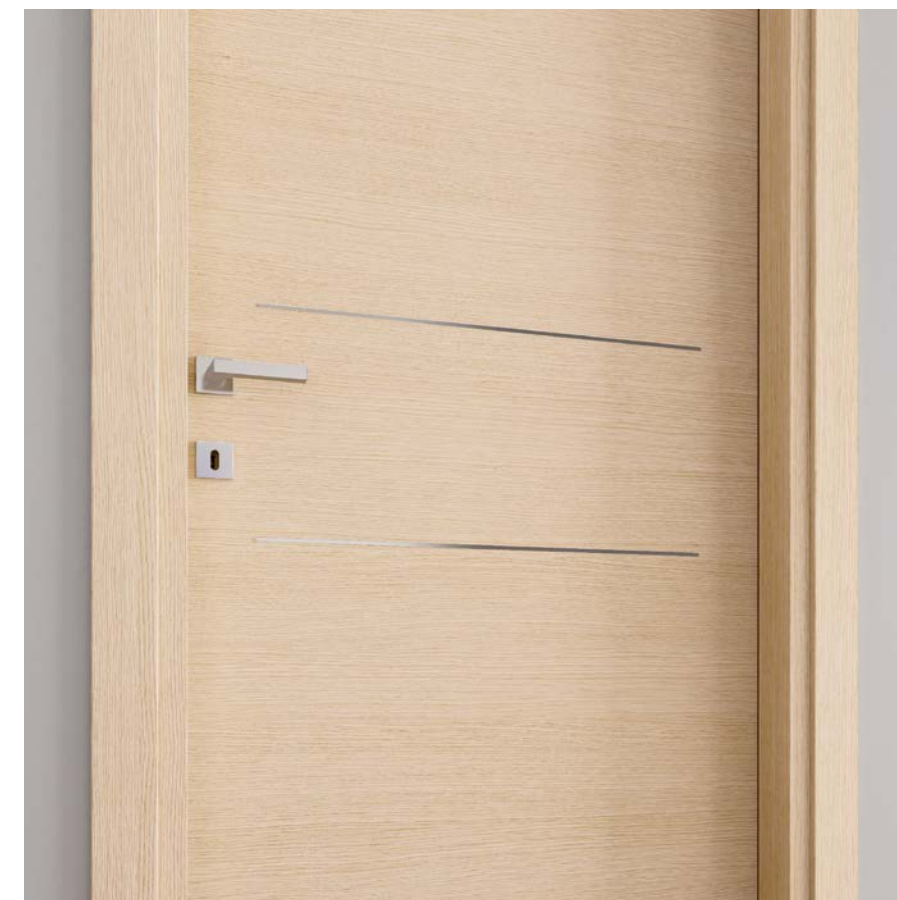

/  
TRAMA  
**NOCE LD57**

MOD.  
**M3-120E**

STIPITE / JAMB / JAMBAGE  
**M3-0100**

FINITURA / FINISH / FINITION  
**NOCE / WALNUT / NOYER  
LD57**



/  
TRAMA  
**NOCE LD57**

MOD.  
**M3-1000**

STIPITE / JAMB / JAMBAGE  
**M3-0100**

FINITURA / FINISH / FINITION  
**NOCE / WALNUT / NOYER  
LD57**





/  
TRAMA  
**BIANCO**

MOD.  
**M3-1000**

STIPITE / JAMB / JAMBAGE  
**M3-0100**

FINITURA / FINISH / FINITION  
**BIANCO / WHITE / BLANC**  
**B011**

/  
TRAMA  
**CILIEGIO**

MOD.  
**M3-1000**

STIPITE / JAMB / JAMBAGE  
**M3-0100**

FINITURA / FINISH / FINITION  
**CILIEGIO / CHERRY / CERISIER**  
**LG69**



# DETTAGLI TECNICI

TECHNICAL DETAILS  
DÉTAILS TECHNIQUES

STIPITE  
JAMB  
JAMBAGE  
**0100**

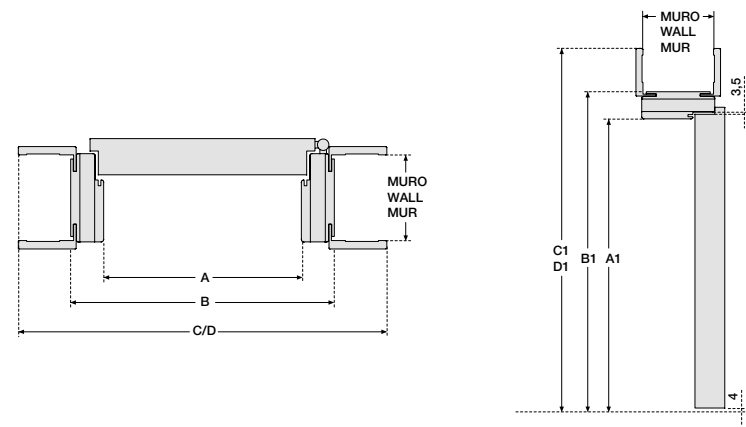

A / A1	B	C	D	B1	C1	D1
Passaggio luce Clear width Net passage	Misura esterno telaio Rough opening Dimension extérieur caisse	Misura esterno coprifilo 1 External casing 1 Dimension extérieur linteaux 1	Misura esterno coprifilo External casing Dimension extérieur linteaux	Misura esterno telaio Rough opening Dimension extérieur caisse	Misura esterno coprifilo 1 External casing 1 Dimension extérieur linteaux 1	Misura esterno coprifilo External casing Dimension extérieur linteaux
-	<b>A</b> +80 mm	<b>A</b> +180 mm	<b>A</b> +206 mm	<b>A1</b> +40 mm	<b>A1</b> +90 mm	<b>A1</b> +103 mm

# DETTAGLI TECNICI

TECHNICAL DETAILS  
DÉTAILS TECHNIQUES

STIPITE **NEW**  
JAMB  
JAMBAGE  
**0102**

a richiesta  
on request  
sur demande

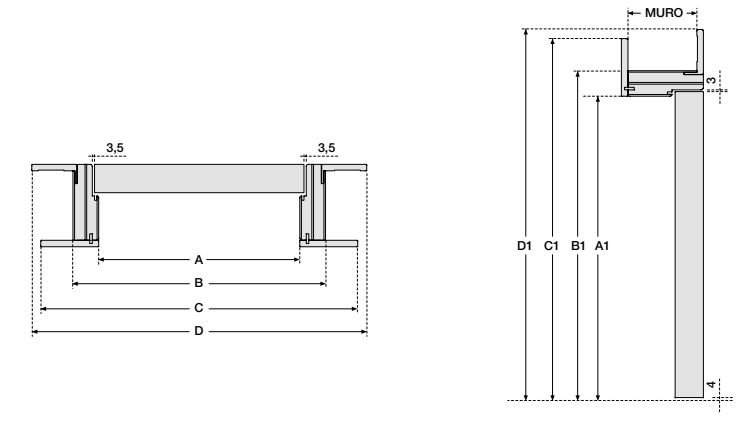

A / A1	B	C / D	B1	C1 / D1
Passaggio luce Clear width Net passage	Misura esterno telaio Rough opening Dimension extérieur caisse	Misura esterno coprifilo External casing Dimension extérieur linteaux	Misura esterno telaio Rough opening Dimension extérieur caisse	Misura esterno telaio Rough opening Dimension extérieur caisse
-	<b>A</b> +80 mm	<b>A</b> +207 mm	<b>A1</b> +80 mm	<b>A1</b> +103 mm

STIPITE **NEW**  
JAMB  
JAMBAGE  
**0102**

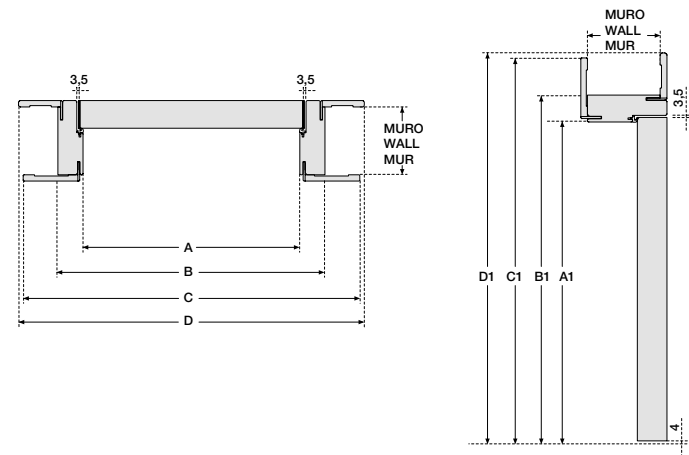

A / A1	B	C	D	B1	C1	D1
Passaggio luce Clear width Net passage	Misura esterno telaio Rough opening Dimension extérieur caisse	Misura esterno coprifilo 1 External casing 1 Dimension extérieur linteaux 1	Misura esterno coprifilo External casing Dimension extérieur linteaux	Misura esterno telaio Rough opening Dimension extérieur caisse	Misura esterno coprifilo 1 External casing 1 Dimension extérieur linteaux 1	Misura esterno coprifilo External casing Dimension extérieur linteaux
-	<b>A</b> +80 mm	<b>A</b> +191 mm	<b>A</b> +205 mm	<b>A1</b> +40 mm	<b>A1</b> +95 mm	<b>A1</b> +102 mm

**CERNIERA ANUBA**  
ANUBA HINGES  
CHARNIÈRES ANUBA



**CERNIERA A SCOMPARSA**  
CONCEALED HINGES  
CHARNIÈRES INVISIBLES



# SOLUZIONI DI APERTURA

Opening solutions  
Solutions d'ouverture

/

SOBRIA ELEGANZA E FONDAMENTALE PRATICITÀ.  
SOLUZIONI PER OGNI ESIGENZA.

SIMPLE ELEGANCE AND PRACTICALITY.  
SOLUTIONS FOR ALL TASTES.

ÉLÉGANCE DISCRÈTE ET PRAGMATISME.  
DES SOLUTIONS POUR CHAQUE BESOIN.





/  
**M3-1302**

MOD.  
M3-1302

SCORREVOLE IN LUCE 2 ANTE PARALLELE /  
BYPASS DOOR /  
COULISSANTE PLACARD À 2 VANTAUX

FINITURA / FINISH / FINITION  
LAMINATO BIANCO / WHITE LAMINATE / LAMINÉ BLANC  
B011

# / M3-1000

MOD.  
M3-1000

SCORREVOLE INTERNO MURO /  
POCKET DOOR /  
PORTE COULISSANTE À GALANDAGE

FINITURA / FINISH / FINITION  
LAMINATO BIANCO / WHITE LAMINATE / LAMINÉ BLANC  
B011





## / M3-1000

MOD.  
M3-1000

SCORREVOLE ESTERNO MURO TIPO "A" /  
WALL-MOUNT SLIDING DOOR - VERSION "A" /  
PORTE COULISSANTE - VERSION "A"

FINITURA / FINISH / FINITION  
LAMINATO BIANCO / WHITE LAMINATE / LAMINÉ BLANC  
B011

# / M3-1000

MOD.  
M3-1000

PORTA A LIBRO 1/3 + 2/3  
FOLDING DOOR 1/3 + 2/3  
PORTE PLIANTE 1/3 + 2/3

FINITURA / FINISH / FINITION  
LAMINATO GRANO / LAMINATE WHEAT / LAMINÉ BLÉ  
LM36





/  
**M3-1000**

MOD.  
**M3-1000**

**ROTOTRASLANTE /  
PIVOT DOOR /  
PORTE PIVOTANTE-COULISSANTE**

/  
**M3-1000**

MOD.  
**M3-1000**

**PORTA A LIBRO /  
FOLDING DOOR /  
PORTE PLIANTE**

FINITURA / FINISH / FINITION  
**LAMINATO BIANCO / WHITE LAMINATE / LAMINÉ BLANC  
B011**



# I VETRI

Glasses  
Verres



M3-01

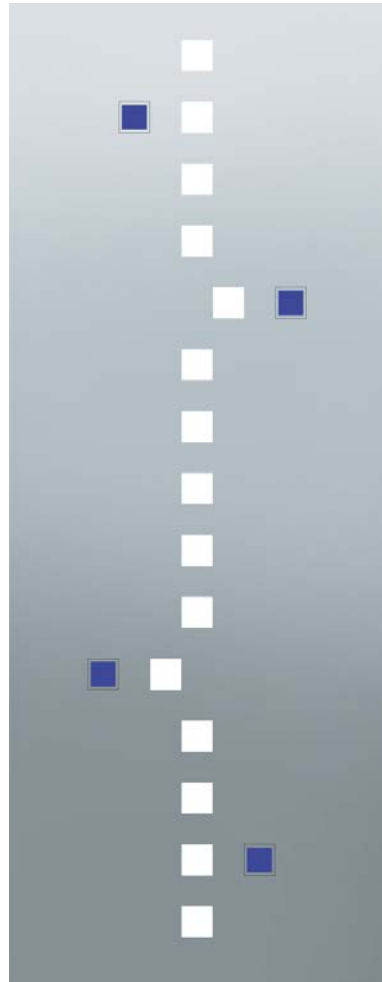

M3-02



M3-03

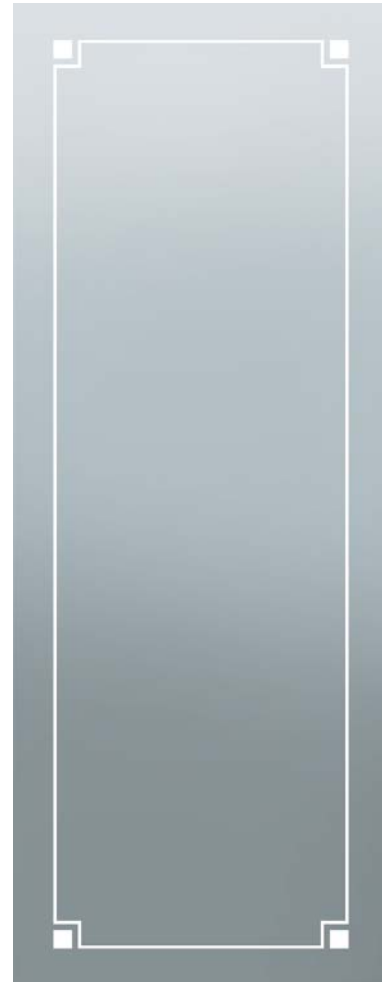

M3-04

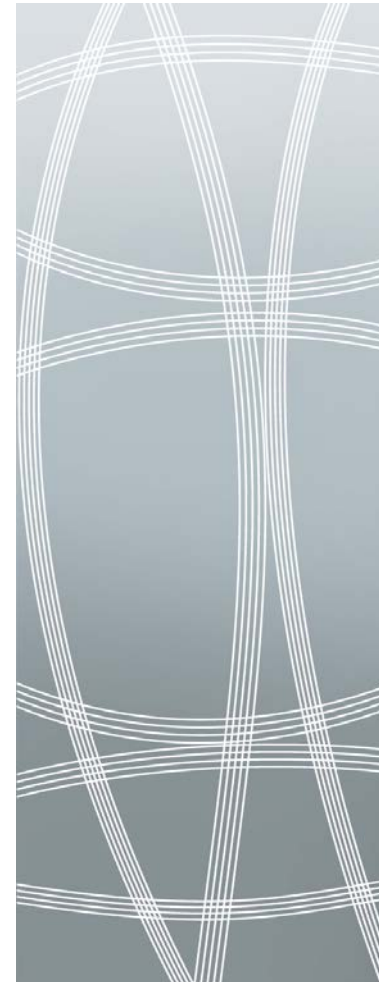

M3-05



M3-06





**M3-07**



**M3-08**



**M3-09**



**M3-10**

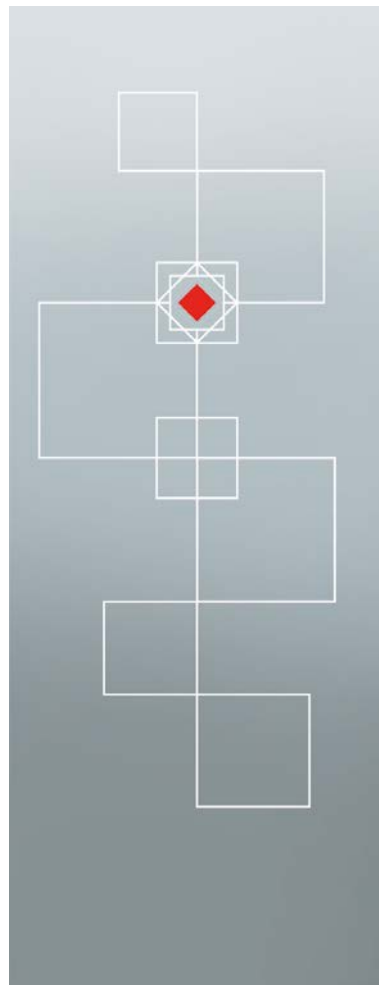

**S-305**



**S-401**

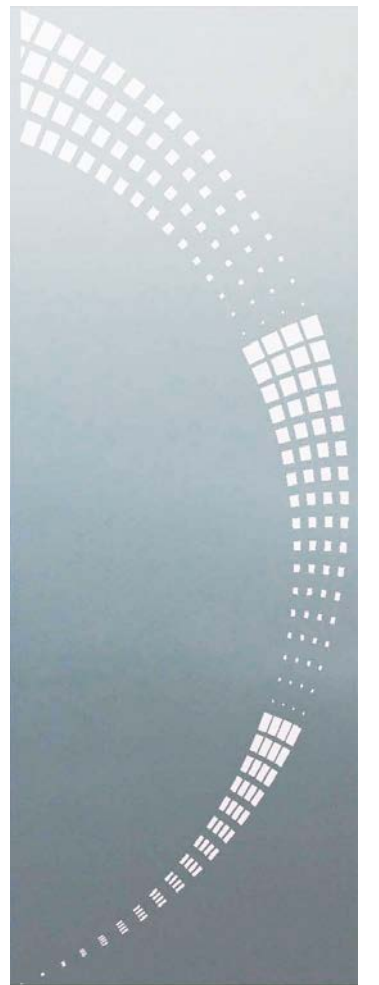

**S-403**



**SR-001**

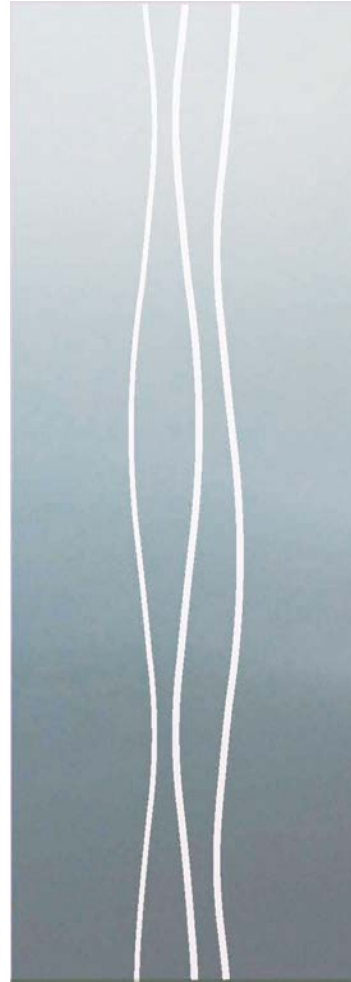

**SF-103**



**SR-008**



**SR-righe**  
SR-lines  
SR-lignes

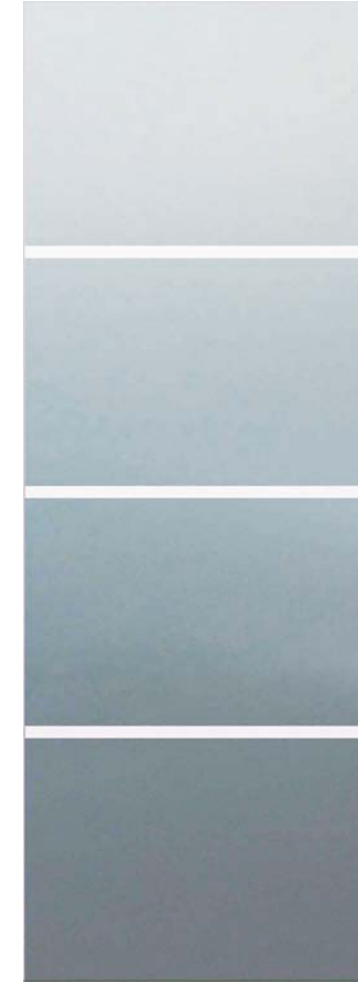

**Satinato bianco**  
White frosted  
Dépoli blanc



**D014**

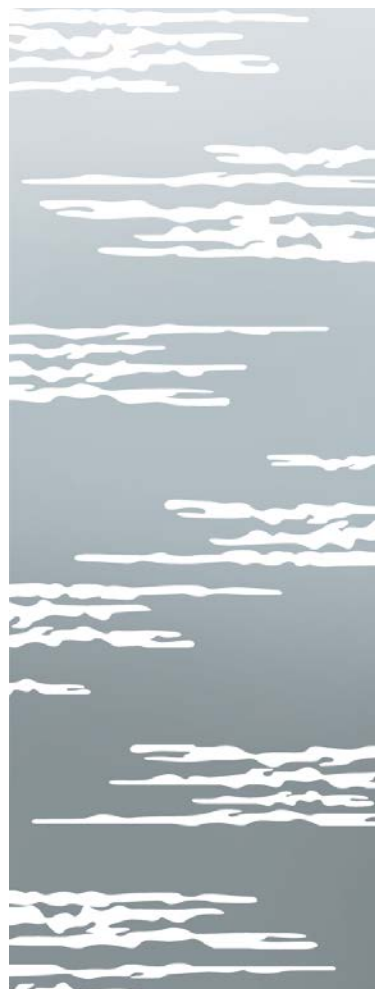

**D015**



**D087**



**D020**



**D163**



# MANIGLIE

Handles  
Poignées



/  
**MANIGLIE**  
HANDLES  
POIGNÉES

**MANIGLIA CON ROSETTE QUADRE**  
HANDLES WITH SQUARED ROSETTES  
POIGNÉES AVEC ROSETTES CARRÉES

**MANIGLIA IXIA**  
IXIA HANDLE  
POIGNÉ IXIA



**MANIGLIA ACAPULCO**  
ACAPULCO HANDLE  
POIGNÉ ACAPULCO



**MANIGLIA B-LINE**  
B-LINE HANDLE  
POIGNÉ B-LINE



/  
**MANIGLIE**  
HANDLES  
POIGNÉES

**MANIGLIA Q-PLUS**  
Q-PLUS HANDLE  
POIGNÉ Q-PLUS



**MANIGLIA SPRING**  
SPRING HANDLE  
POIGNÉ SPRING



**MANIGLIA ATENE**  
ATENE HANDLE  
POIGNÉ ATENE



**MANIGLIA B-MINI**  
B-MINI HANDLE  
POIGNÉ B-MINI



**MANIGLIA Q-LINE**  
Q-LINE HANDLE  
POIGNÉ Q-LINE



**MANIGLIA Q-MINI**  
Q-MINI HANDLE  
POIGNÉ Q-MINI



**MANIGLIA GENEVE**  
GENEVE HANDLE  
POIGNÉ GENEVE



# / MANIGLIE

HANDLES  
POIGNÉES

## MANIGLIE CON ROSETTE TONDE

HANDLES WITH ROUND ROSETTES  
POIGNÉES AVEC ROSETTES RONDES

**MANIGLIA HAITI**  
HAITI HANDLE  
POIGNÉ HAITI



**MANIGLIA ALISÈ**  
ALISÈ HANDLE  
POIGNÉ ALISÈ



**MANIGLIA ARJA**  
ARJA HANDLE  
POIGNÉ ARJA



**MANIGLIA SASHA**  
SASHA HANDLE  
POIGNÉ SASHA



**MANIGLIA OSLO**  
OSLO HANDLE  
POIGNÉ OSLO



**MANIGLIA SABINA**  
SABINA HANDLE  
POIGNÉ SABINA



# / MANIGLIE

HANDLES  
POIGNÉES

## MANIGLIONI

BAR  
BARRES

**MANIGLIONE FRANKFURT**  
FRANKFURT BAR  
BARRE FRANKFURT



**MANIGLIONE TORONTO**  
TORONTO BAR  
BARRE TORONTO



## MANIGLIETTE PER PORTE SCORREVOLI

HANDLES FOR SLIDING DOORS  
POIGNÉES POUR PORTES COULISSANTES

**MD - MANIGLIETTE CIECHE TONDE**  
MD - ROUND BLIND HANDLES  
MD - POIGNÉES CUVETTES RONDES



**SMD - MANIGLIETTE TONDE POMOLO/BOTTONE**  
SMD - ROUND CATCHES  
SMD - SERRURES À CROCHET RONDES



**MD - MANIGLIETTE CIECHE QUADRE**  
MD - SQUARED BLIND HANDLES  
MD - POIGNÉES CUVETTES CADRES



**SMD - MANIGLIETTE QUADRE POMOLO/BOTTONE**  
SMD - SQUARED CATCHES  
SMD - SERRURES À CROCHET CADRES



**project & graphic design**  
www.lithos.it

**3d rendered images**  
www.linkfoto.it

**print**  
grafiche Italprint

edition 2021



**MOBIL3 S.R.L.**  
Via G. Galilei, 3  
30020 Torre di Mosto, VE, ITALY  
T. +39 0421 461833 - F. +39 0421 314207  
info@mobil3srl.com  
[www.mobil3srl.com](http://www.mobil3srl.com)

TUTTI I DIRITTI DI RIPRODUZIONE E  
RIELABORAZIONE SONO RISERVATI.  
MOBIL3 SRL SI RISERVA DI APPORTARE  
MODIFICHE, ANCHE SENZA PREAV-  
VISO ED IN QUALSIASI MOMENTO,  
ALLE CARATTERISTICHE DEI PRODOTTI  
RIPORTATI NEL PRESENTE CATALOGO.  
I COLORI DELLE PORTE RIPRODOTTE  
NEL PRESENTE CATALOGO SONO  
PURAMENTE INDICATIVI.

All rights reserved, including reprint and  
rework. Mobil3 Ltd reserves the right to  
modify the characteristics of products  
listed in this catalogue without prior noti-  
ce. The image is intended for illustration  
purposes only and be different from the  
actual colours due to the limitations of  
print technology.







**MOBIL3 S.R.L.**

Via G. Galilei, 3

30020 Torre di Mosto, VE, ITALY

T. +39 0421 461833 - F. +39 0421 314207

[www.mobil3srl.com](http://www.mobil3srl.com) - [info@mobil3srl.com](mailto:info@mobil3srl.com)