

HARCOLOOR
DESIGN
DESIGN
HARCOLOOR

2017 – 2018

Harco Loor Design has been founded in the early 80's as a result of growing interest and significance of design in the international field of interior lighting.

Each design is hand crafted and carries the personal signature of the designer Harco Loor.

All our lighting are designed and manufactured in our own factory in Haarlem, The Netherlands.

Only high quality materials, such as stainless steel and crystal are used. Now, innovative energy saving solutions are integrated into our designs.

On request modifications or other measurements are possible.

HARCOLOOR.COM



HEADQUARTERS/SHOWROOM

HARCO LOOR DESIGN BV

Emrikweg 48
2031 BT Haarlem
The Netherlands

P.O. Box 6145
2001 HC Haarlem
The Netherlands

Phone +31 (0)23 538 81 17
Fax +31 (0)23 538 81 18
KvK Haarlem 34048597

info@harcoloor.com
www.harcoloor.com

OX 8



BALLOON 12



STARDUST 16



BIG BUBBLES – RIDDLE SIX 20



BUBBLES 28

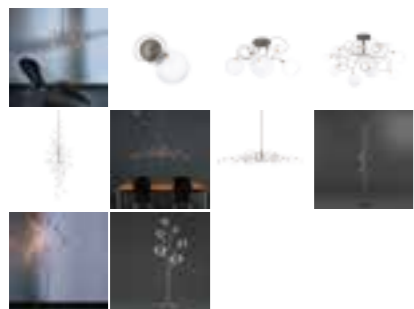

FLAG 36



FLOWER (LARGE) 38

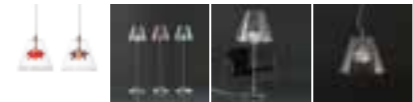

ROCK 42



STRAWBERRY 46



SWEET 50



JEWEL 52

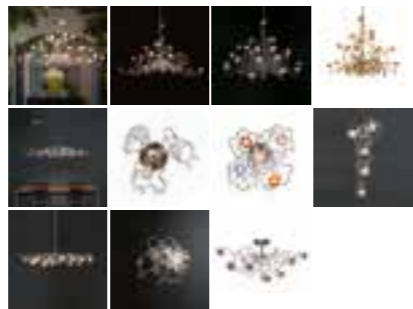

CRYSTAL 66



CLUSTER 68

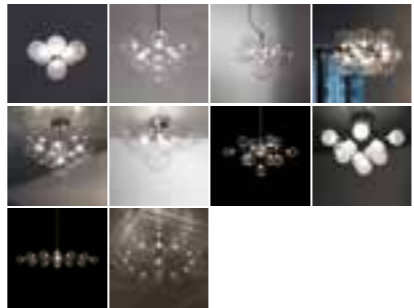

METEOR 78



CROSSFIRE 82

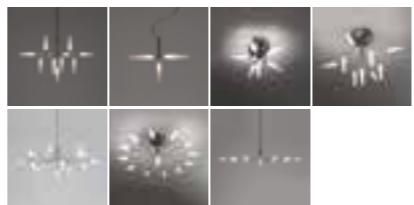

TARGET 88



TIARA 58/90

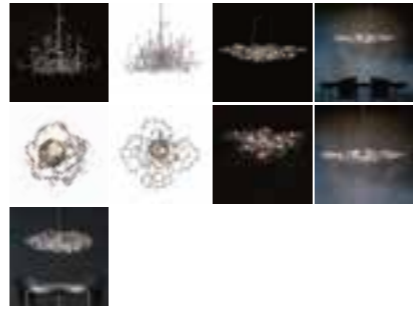

ZEPPELIN 97



BARET 98



CARRE 100



BALL 101



CARROT 102



REFLEXION 104

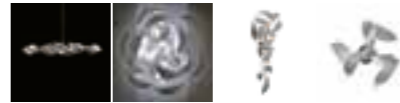

MURRINI 108

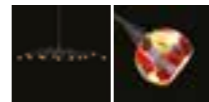

SNOWBALL 110



BREEZE 116

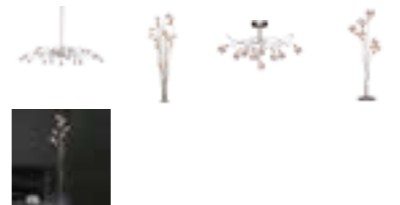

JELLY 118



PAPILLON IRI 120



SUSPENSION

101	BALL HL Ø 60
12	BALLOON CABLE HL 6
14	BALLOON HL 13
20	BIG BUBBLES HL 35
22	BIG BUBBLES KITE HL 14
23	BIG BUBBLES OVAL HL 14
28	BUBBLES HL 12
31	BUBBLES KITE HL 14
30	BUBBLES LONG HL 24
32	BUBBLES OVAL HL 12
114	BREEZE OVAL HL 20
102	CARROT HL 14
71	CLUSTER HL 11
73	CLUSTER HL 16
68	CLUSTER CABLE HL 6
70	CLUSTER CABLE HL 6
74	CLUSTER CROWN HL 13
76	CLUSTER OVAL HL 13
82	CROSSFIRE HL 13
83	CROSSFIRE CABLE HL 6
85	CROSSFIRE LARGE HL 16
87	CROSSFIRE WHEEL HL 13
66	CRYSTAL HL 12
67	CRYSTAL DIAMOND HL 12
36	FLAG HL 35
37	FLAG OVAL HL 14
38	FLOWER HL 1
41	FLOWER LARGE HL 1
118	JELLY HL 1L
56	JEWEL CHANDELIER HL 15
52	JEWEL CHANDELIER HL 27
54	JEWEL CHANDELIER OVAL HL 27
55	JEWEL DIAMOND CHANDELIER HL 24
63	JEWEL DIAMOND OVAL HL 15
60	JEWEL KITE HL 18
78	METEOR HL 9
81	METEOR LARGE HL 13
108	MURRINI OVAL HL 12
8	OX HL2
10	OX HL3
104	REFLEXION LONG HL 12
21	RIDDLE SIX LONG HL 20
24	RIDDLE SIX OVAL HL 10
44	ROCK LARGE HL 13
110	SNOWBALL OVAL HL 12
18	STARDUST HL Ø 24
19	STARDUST HL Ø 38
46	STRAWBERRY HL 12
50	SWEET LONG HL 12
58	TIARA DIAMOND CHANDELIER HL 15
59	TIARA DIAMOND CHANDELIER HL 24
90	TIARA KITE HL 18
92	TIARA KITE HL 12
96	TIARA HL 15
95	TIARA OVAL HL 15
97	ZEPELIN OVAL HL 15

CEILING/WALL

13	BALLOON PL6
99	BARET PL/WL 50
98	BARET PL/WL 150
29	BUBBLES PL/WL 1
29	BUBBLES PL/WL 5
29	BUBBLES PL 12
116	BREEZE PL 9
100	CARRÉ PL/WL 5
73	CLUSTER PL 6
72	CLUSTER PL 11
75	CLUSTER PL 11
77	CLUSTER WHEEL PL 13
84	CROSSFIRE PL 6
84	CROSSFIRE PL 9
86	CROSSFIRE WHEEL PL 13
61	JEWEL PL/WL 3
61	JEWEL PL/WL 5
64	JEWEL DIAMOND PL/WL 1
65	JEWEL DIAMOND AMETHYST PL 9
62	JEWEL LONG WL 5
79	METEOR PL 9
80	METEOR PL/WL 5
120	PAPPILON IRI PL 7
107	REFLEXION PL/WL 3

FLOOR

105	REFLEXION PL/WL 12
106	REFLEXION LONG WL 7
25	RIDDLE PL/WL 1
25	RIDDLE PL/WL 3
25	RIDDLE BASIC PL/WL 1
43	ROCK PL/WL 5
112	SNOWBALL PL 9
111	SNOWBALL PL/WL 1
111	SNOWBALL PL/WL 3
111	SNOWBALL PL/WL 5
16	STARDUST PL/WL Ø 29
47	STRAWBERRY PL 9
49	STRAWBERRY PL/WL 1
49	STRAWBERRY PL/WL 3
49	STRAWBERRY PL/WL 5
51	SWEET LONG WL 5
89	TARGET PL/WL 1
89	TARGET PL/WL 2
88	TARGET PL/WL 3
89	TARGET PL/WL 5
94	TIARA PL 12
93	TIARA DIAMOND PL/WL 1
93	TIARA DIAMOND PL/WL 5

TABLE

35	BUBBLES SP TL 6
117	BREEZE TL 6
103	CARROT TL 6
39	FLOWER TL 1
40	FLOWER LARGE TL 1
119	JELLY TL 1L
11	OX TL 1
121	PAPPILON IRI FL 7
113	SNOWBALL FL 9
115	TREE BREEZE FL 15
35	BUBBLES SP TL 6
117	BREEZE TL 6
103	CARROT TL 6
39	FLOWER TL 1
40	FLOWER LARGE TL 1
119	JELLY TL 1L
11	OX TL 1
127	PAPPILON IRI TL 5
42	ROCK TL 1
111	SNOWBALL TL 1
111	SNOWBALL TL 3
17	STARDUST OBJECT TL Ø 38
48	STRAWBERRY TL 1
48	STRAWBERRY TL 3

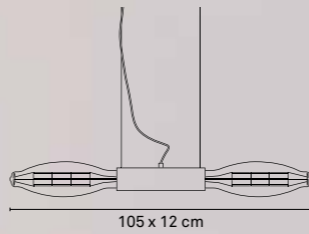
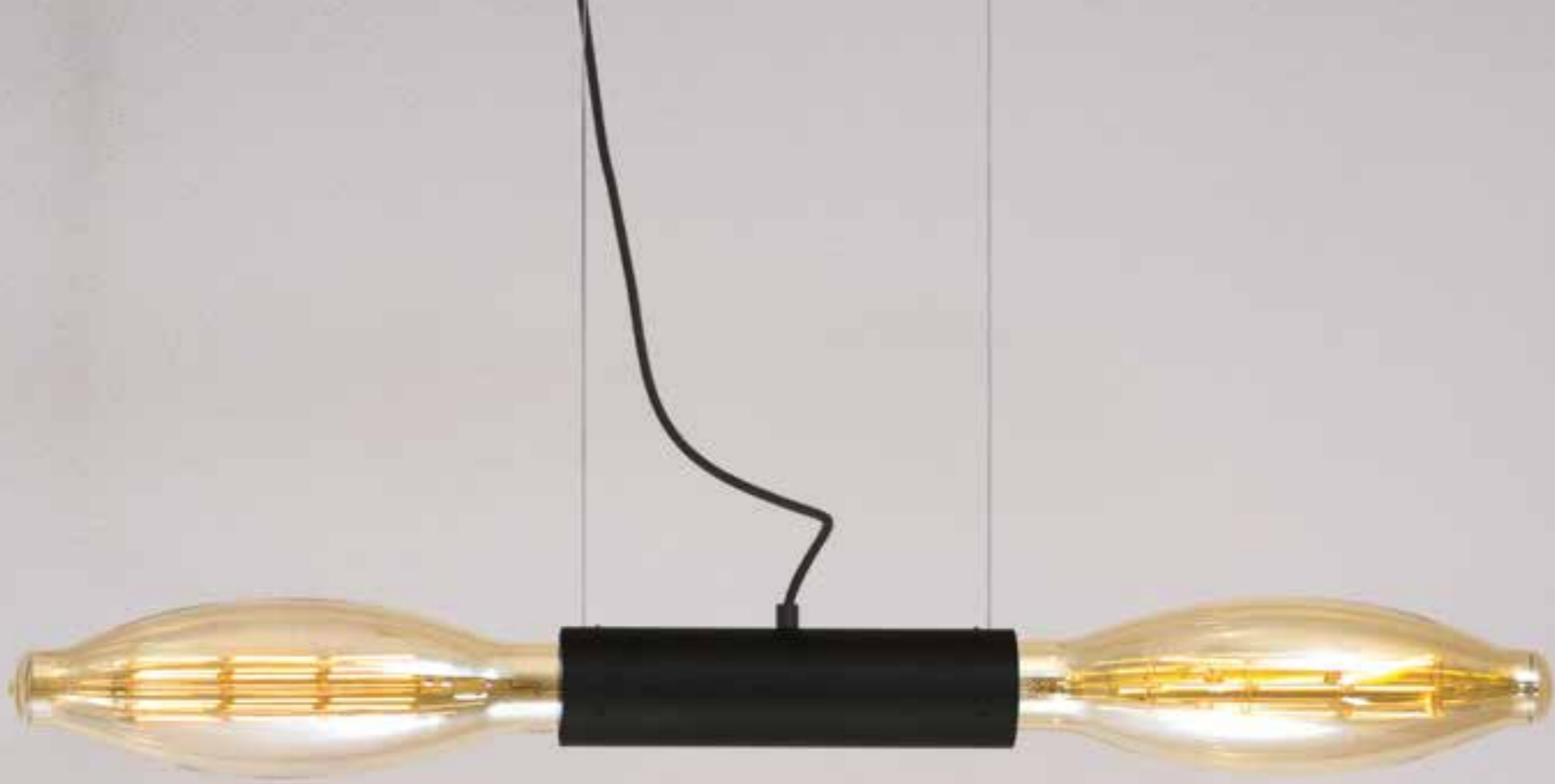

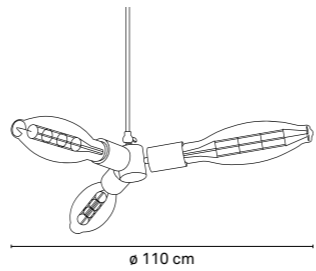

ø 110 cm

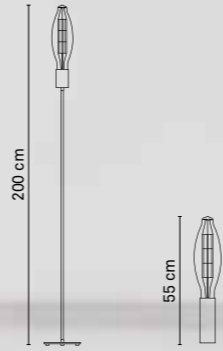

200 cm

55 cm





12

HL 6

BALLOON CABLE

Technical data page 122 – 157

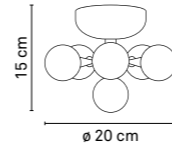
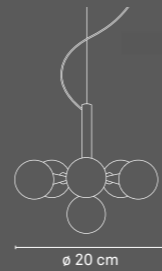

13

PL/WL 6

BALLOON

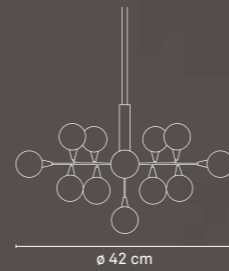

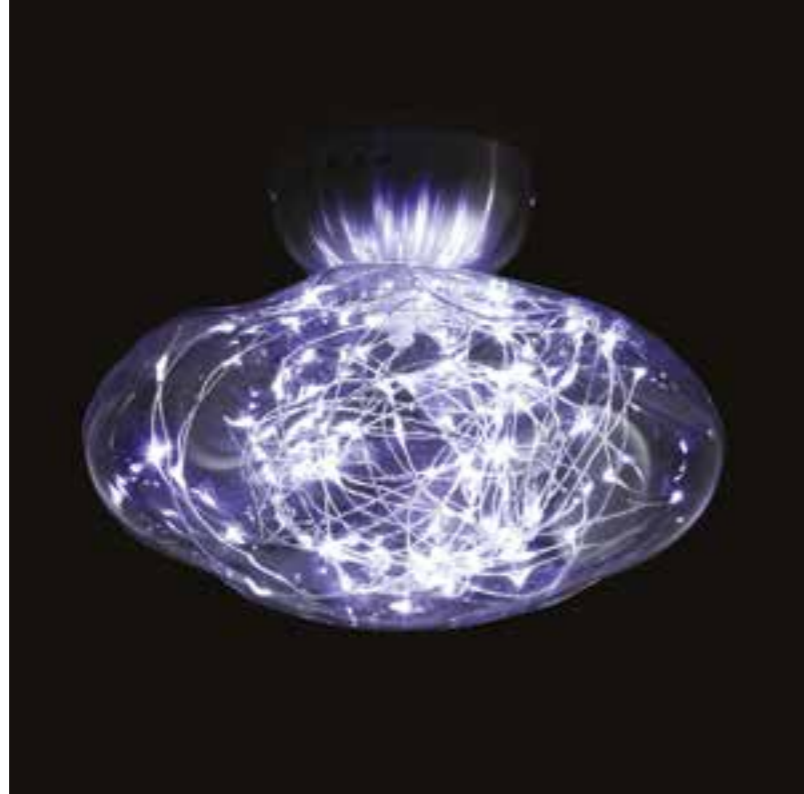

STARDUST

Technical data page 122 - 157

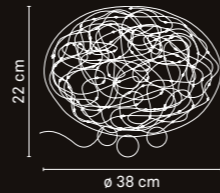
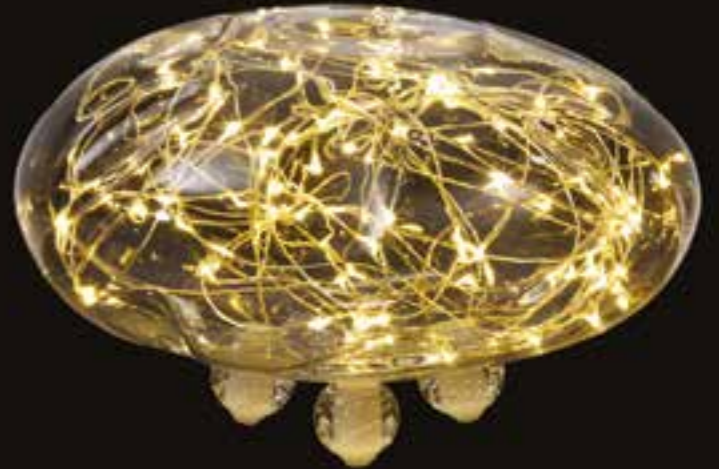
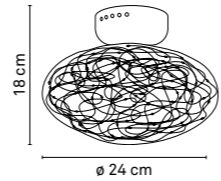

STARDUST OBJECT



HL Ø 24

STARDUST

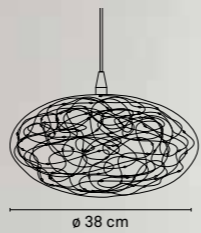
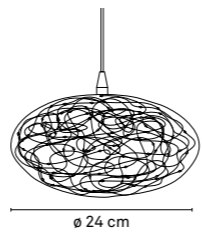

HL Ø 38

STARDUST

BIG BUBBLES

Technical data page 122 - 157

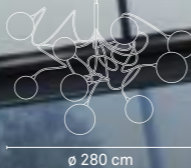

RIDDLE SIX LONG

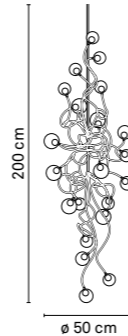



HL 14

BIG BUBBLES KITE

Technical data page 122 – 157

160 x 45 cm

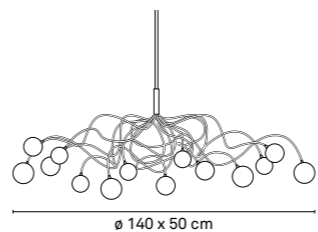

ø 140 x 50 cm

HL 14

BIG BUBBLES OVAL



RIDDLE SIX OVAL

Technical data page 122 – 157

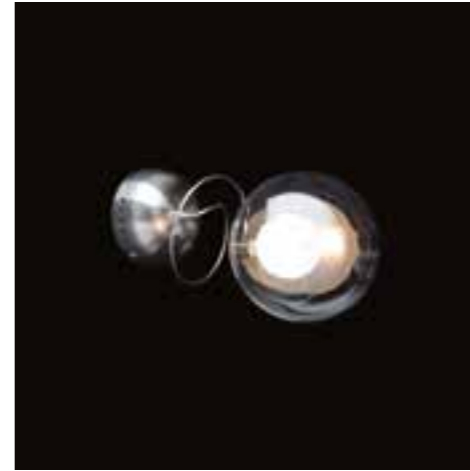
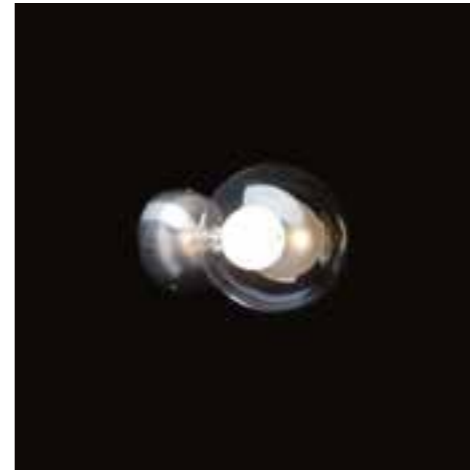
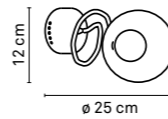
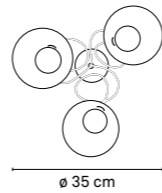
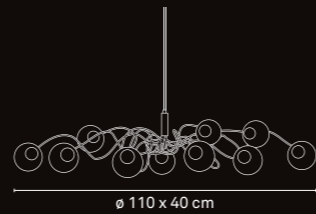

BIG BUBBLES

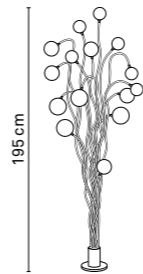

BIG BUBBLES



BUBBLES

Technical data page 122 – 157

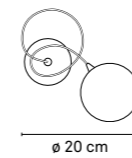
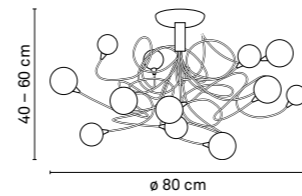

BUBBLES



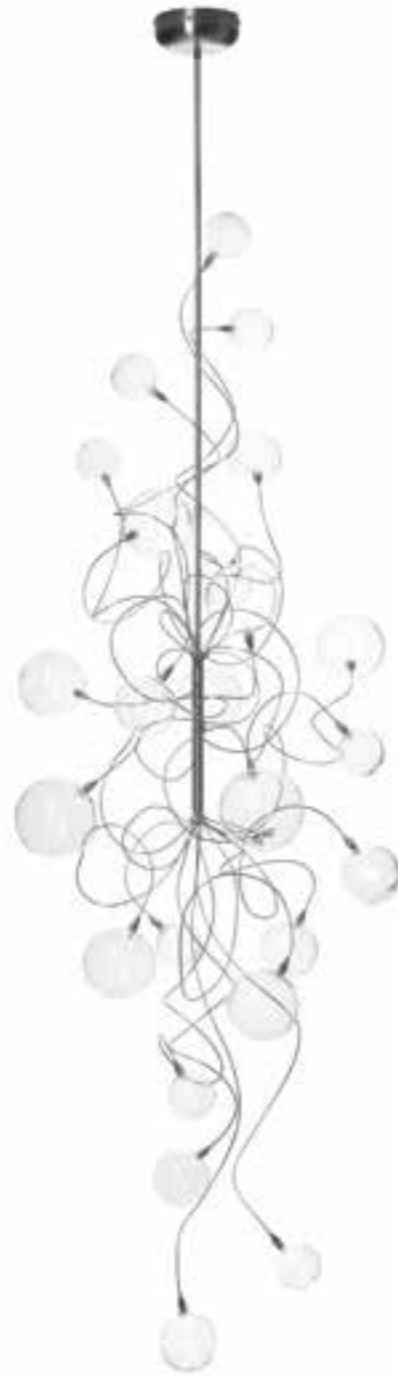

BUBBLES LONG

Technical data page 122 - 157

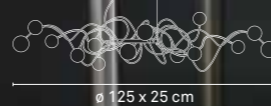

BUBBLES KITE



BUBBLES OVAL

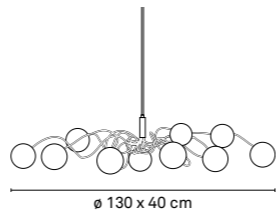

BUBBLES LONG

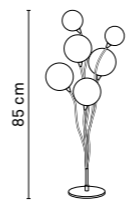

FLAG



FLAG OVAL

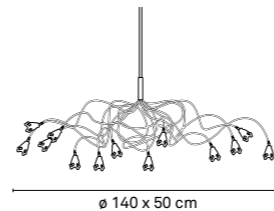



FLOWER

Technical data page 122 - 157

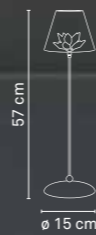
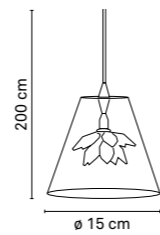

FLOWER



40

TL 1

FLOWER LARGE

Technical data page 122 - 157

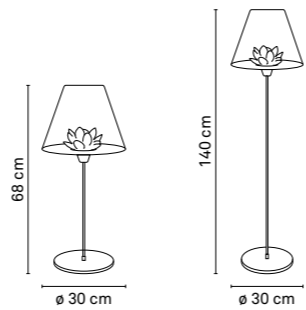

41

HL 1

FLOWER LARGE





TL 1

ROCK

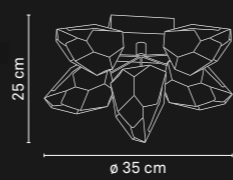
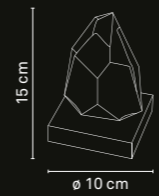

PL/WL 5

ROCK

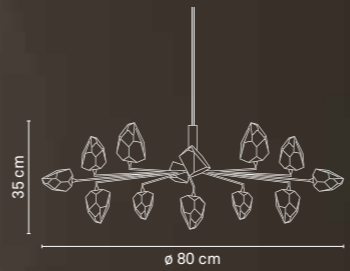



STRAWBERRY

Technical data page 122 - 157

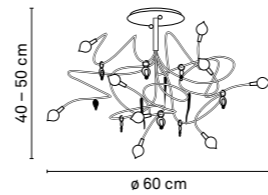
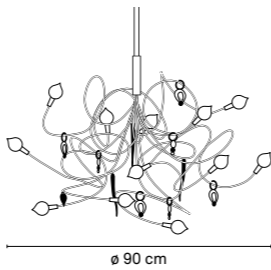

STRAWBERRY

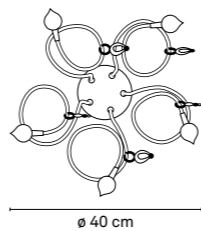
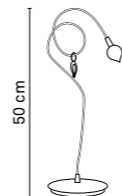



SWEET LONG

Technical data page 122 - 157

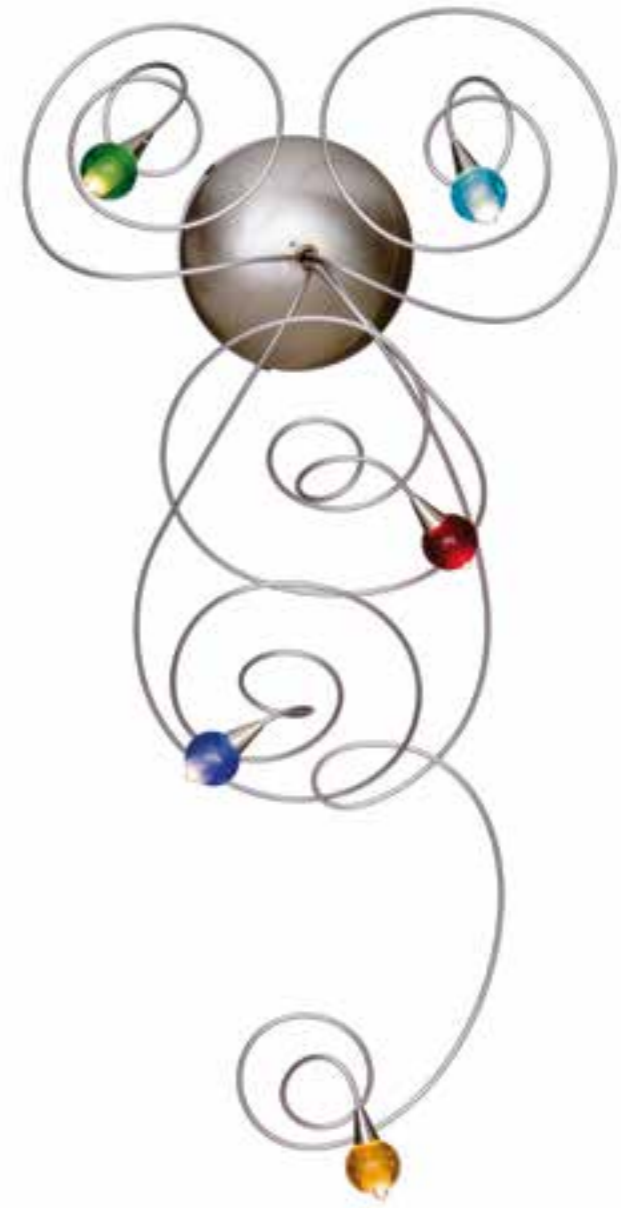
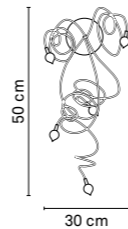
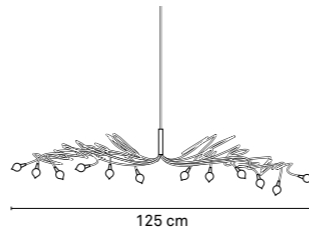

SWEET LONG



JEWEL CHANDELIER

Technical data page 122 - 157



JEWEL CHANDELIER OVAL



JEWEL DIAMOND CHANDELIER

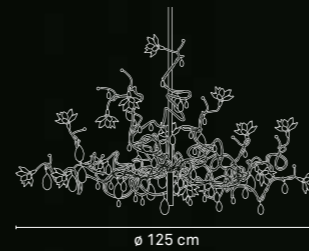



Impression Heyroth & Kürbitz freie Architekten, Hamburg

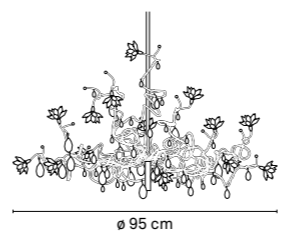

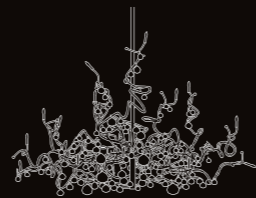

ø 95 cm

TIARA DIAMOND CHANDELIER

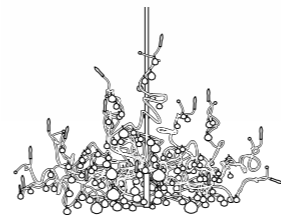

ø 125 cm

TIARA DIAMOND CHANDELIER



JEWEL KITE



140 x 40 cm

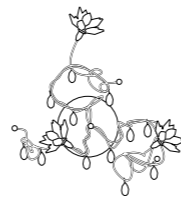
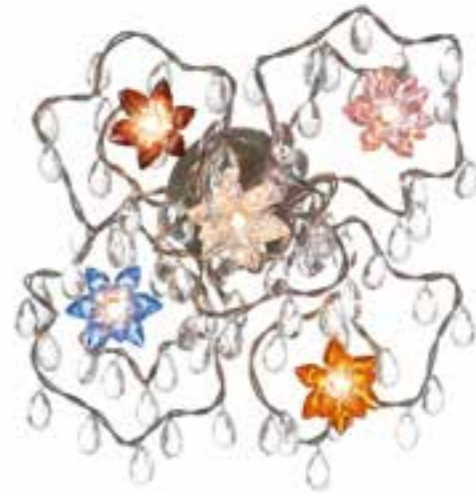

ø 30 cm

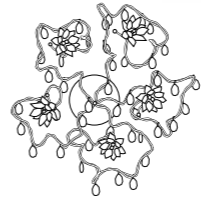

ø 45 cm

JEWEL



JEWEL LONG



JEWEL DIAMOND OVAL

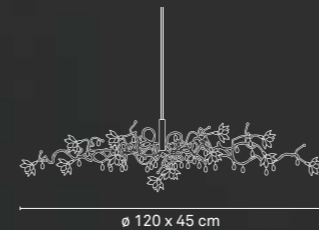



JEWEL DIAMOND



ø 20 cm

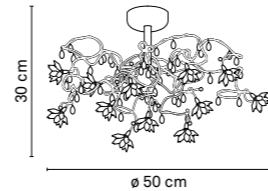

30 cm

ø 50 cm



JEWEL DIAMOND

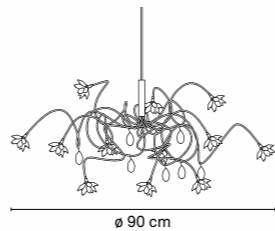

CRYSTAL

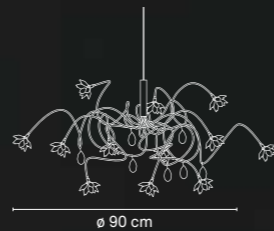

CRYSTAL DIAMOND



CLUSTER CABLE

Technical data page 122 – 157

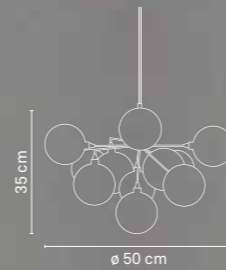

CLUSTER



70

HL 6

CLUSTER CABLE

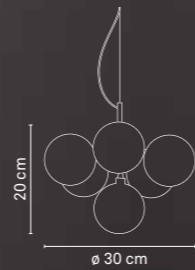

71

HL 16

CLUSTER

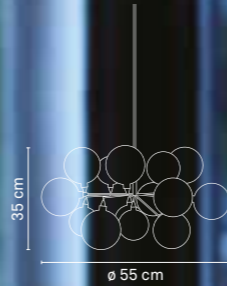



CLUSTER

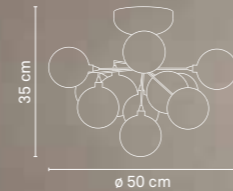

CLUSTER

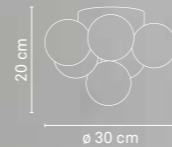



CLUSTER CROWN

Technical data page 122 – 157



CLUSTER

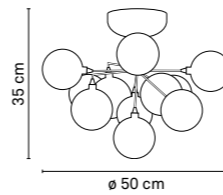

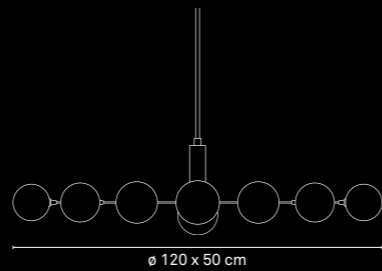

CLUSTER OVAL

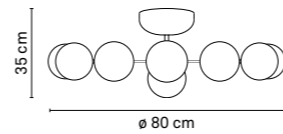

CLUSTER WHEEL

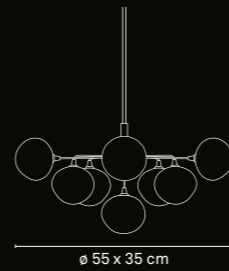

METEOR

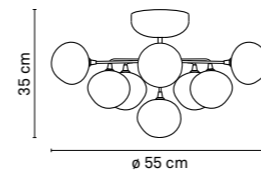

METEOR



METEOR

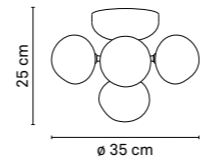

METEOR LARGE

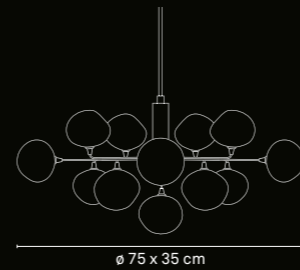

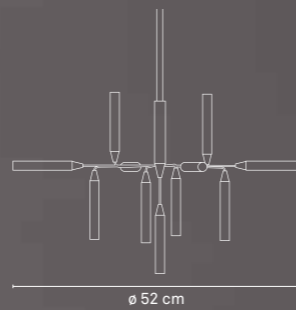

CROSSFIRE

Technical data page 122 – 157

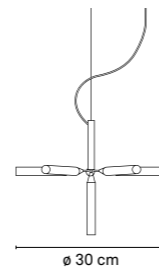

CROSSFIRE CABLE



CROSSFIRE

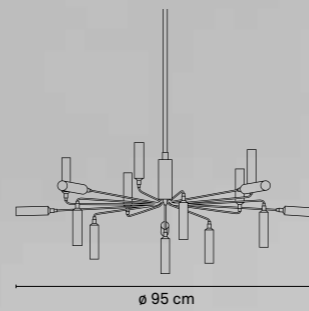
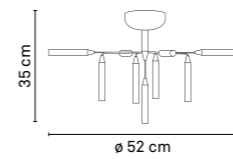
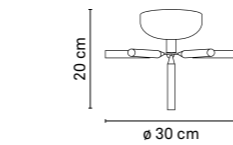

CROSSFIRE LARGE

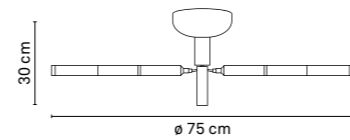

CROSSFIRE WHEEL LARGE

Technical data page 122 - 157



CROSSFIRE OVAL LARGE

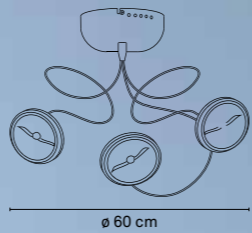

TARGET

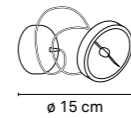
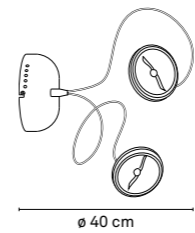
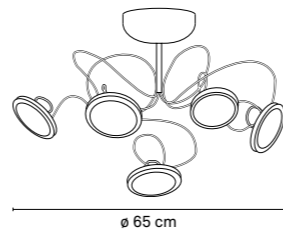

TARGET





90

HL 18

TIARA KITE

Technical data page 122 - 157

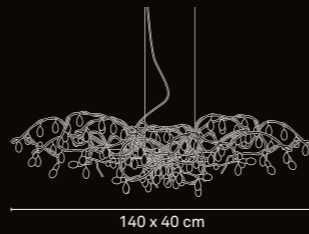



TIARA KITE

Technical data page 122 – 157

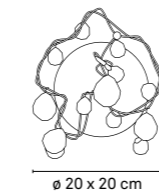
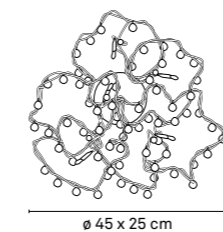

TIARA DIAMOND



94

PL 12

TIARA

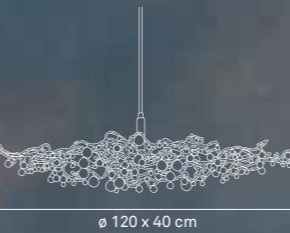
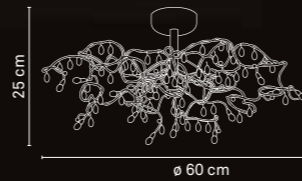

95

HL 15

TIARA OVAL



96



HL 15

TIARA

Technical data page 122 – 157

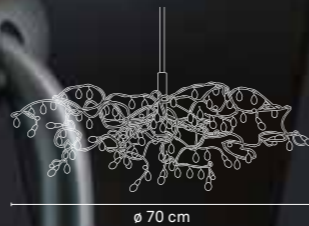

ø 70 cm



97

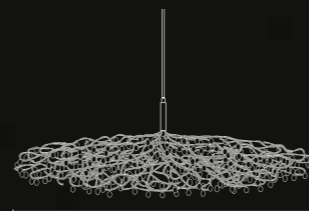

ø 145 x 45 cm

HL 15

ZEPPELIN OVAL



BARET

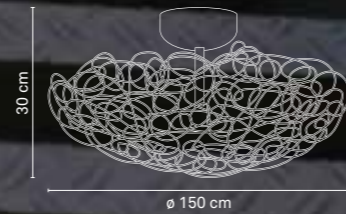

BARET

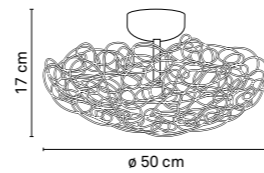

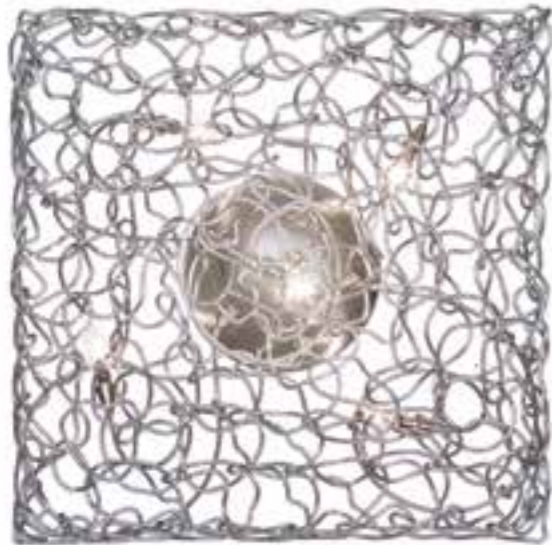

CARRÉ

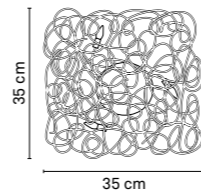

BALL



CARROT

Technical data page 122 - 157

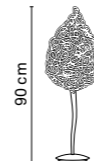
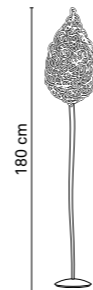

CARROT

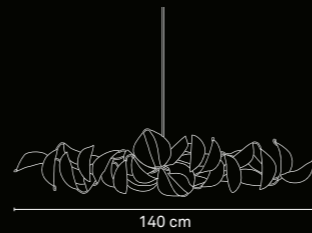

REFLEXION LONG

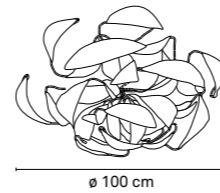

REFLEXION

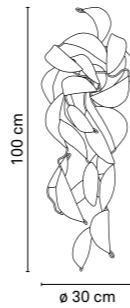

ø 30 cm

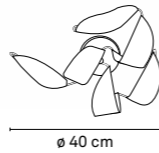

ø 40 cm





MURRINI OVAL

Technical data page 122 - 157

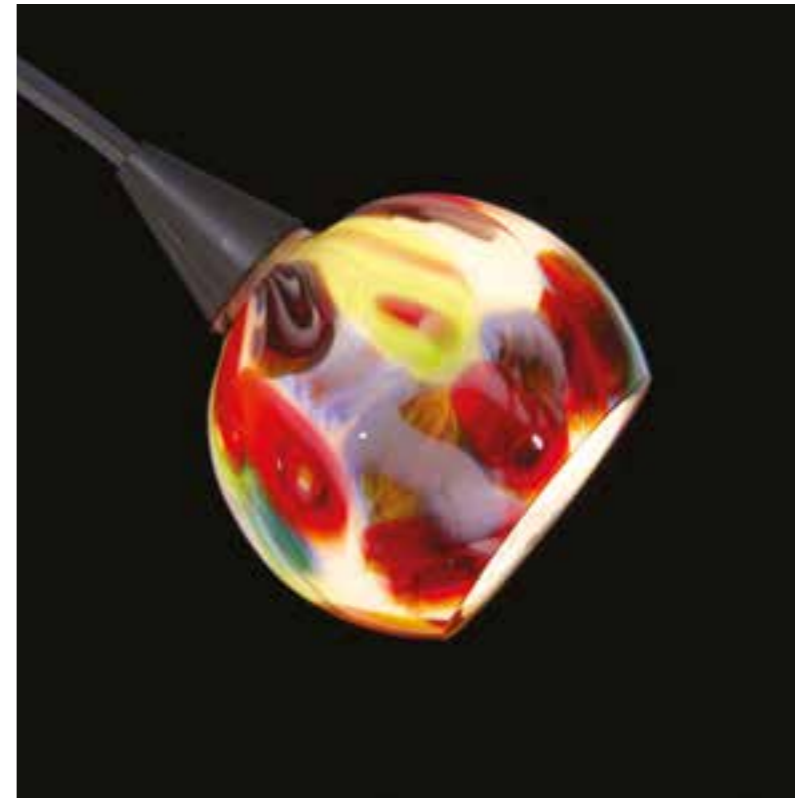

MURRINI OVAL



SNOWBALL OVAL

Technical data page 122 – 157

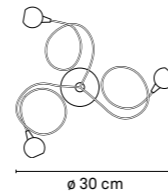
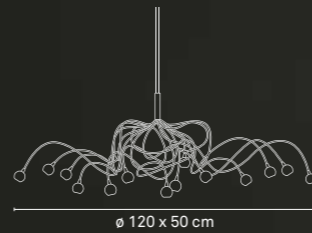

PL/WL 1 ø 20 x 20 cm – PL/WL 5 ø 30 x 20 cm – TL 3 † 50cm

SNOWBALL

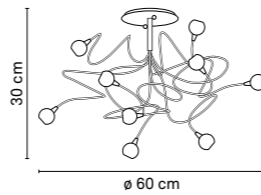

170 cm

114



115



HL 20

BREEZE OVAL

Technical data page 122 - 157

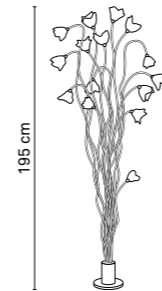
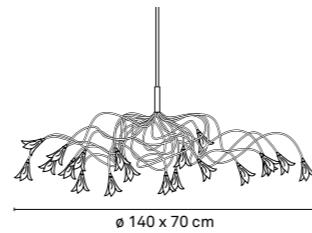

FL 15

TREE BREEZE

116



PL 9

BREEZE

Technical data page 122 - 157

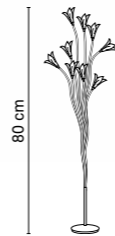
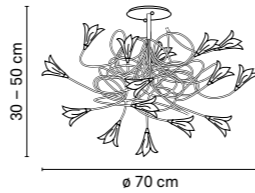

117

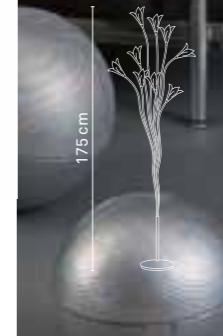

BREEZE

TL 6 - FL 9



JELLY

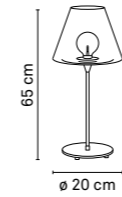
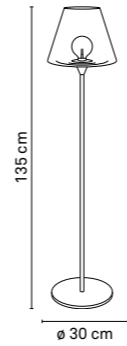
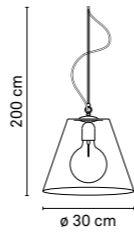



120

PL 7

PAPILLON IRI

Technical data page 122 - 157



ø 50 cm

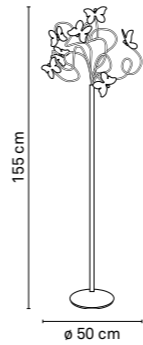

155 cm

ø 50 cm

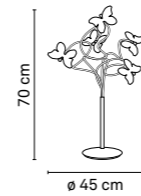

70 cm

ø 45 cm



121

FL 7 - TL 5

TOELICHTING / EXPLANATION / ERKLÄRUNG / EXPLICATION

- HL Hanglamp / Hanging lamp / Pendelleuchte / Suspension
- PL Plafondlamp / Ceiling lamp / Deckenleuchte / Plafonnier
- TL Tafellamp / Table lamp / Tischleuchte / Lampe à poser
- FL Vloerlamp / Floor lamp / Stehleuchte / Lampadaire
- WL Wandlamp / Wall lamp / Wandleuchte / Applique
- ☒ Gaaskapje / Shade of mesh / Netzschirm / Résille inox
- ☒ Geperforeerde kap / Perforated shade / Perforierter Schirm / Abat-jour perforé

- ∅ Max. doorsnede / Max. diameter / Max. Durchmesser / Max. diamètre
- ⌘ Hoogte Corpus / Corpus Height / Korpus-Höhe / Hauteur du corps
- ↔ Breedte / Width / Breite / Largeur
- Afstand van muur/plafond / Distance from wall/ceiling / Distanz vom Wand/Decke / Distance de mur/plafond
- ⌋ (Maximum) hoogte / (Maximum) height / (Maximal-) Höhe / Hauteur (maximum)

↑**CM St. totale hoogte met pendel HL = 110cm, andere hoogte bij bestelling opgeven.

↑**CM St. total height with rod HL = 110cm, other desired heights to be stated by ordering.

↑**CM St. Gesamtlänge mit Rohr HL=110cm , andere Höhe beim Auftrag angeben.

↑**CM Hauteur st. avec tige HL = 110cm, autre indiquer à commande.

⌘ var. st. 200 cm kabel wordt meegeleverd / var. st. 200 cable is included / var. st. 200 cm Kabel inbegriffen / var. st. 200 cm câble est inclus.

HALO. Lamp in halogeen uitvoering, dimbaar/Halogen version, dimmable/Halogenausführung, Dimbar/Version halogène, dimmable

LED Lamp in LED uitvoering / LED version / LED Ausführung / Version LED

122

LED SPECIFICATION

Voltage	12V/AC/DC	Intensity	100 Lumen
Power	1 WATT	Durability	> 30.000h
Beam angle	360°	Color temperature	2700K (warm white)
Fitting	G4 LED		D10*31mm

COLORS / KLEUREN / FARBEN / COULEURS

1 Wit / White / Weiss / Blanc	10 Groen / Green / Grün / Vert
2 Transparant / Transparent / Transparent / Transparent	14 Geel / Yellow / Gelb / Jaune
3 Rook / Smoke / Rauch / Fumée	15 Amber / Amber / Amber / Ambre
4 Roze / Pink / Rosa / Rose	18 Zwart / Black / Schwarz / Noir
5 Rood / Red / Rot / Rouge	22 Amethyst / Amethyst / Amethyst / AméthysteDoré
7 Lichtblauw / Light blue / Hellblau / Bleu clair	23 Lila / Lilac / Lila / Lilas
8 Donkerblauw / Dark blue / Dunkelblau / Blue foncé	29 Iriserend / Irisdescent / Irisierend / Irisé
9 Turquoise / Turquoise / Tuerkis / Turquoise	

JEWEL – GCY



JEWEL / TIARA DT / KRISTALHANGERS / TRIMMINGS / KRISTALLHÄNGER / PAMPILLES



JEWEL DIAMOND / TIARA DIAMOND



SWEET / STRAWBERRY – GSW



SNOWBALL – GSN



BALLOON – GBA



METEOR



CROSSFIRE – GCR



CROSSFIRE LARGE – GCR-L



MURRINI – GMU



METALBALL – PMB



PAPILLON /PAPILLON IRI – GPP



BREEZE – BRM



TREE – TRM



123

BUBBLES – GBU-2



L Ø 12 CM, M Ø 10 CM, S Ø 8 CM, XS Ø 6 CM

RIDDLE – GRI



Ø 12-6 CM

ROCK – GRO



GUIRLANDE –GGU-2



2

FLAG – GFL



2

PENNE /BLADE CALYPSO – GPE-1



FLOWER LARGE – GBF



HOOD – GH0







1

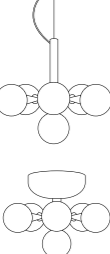
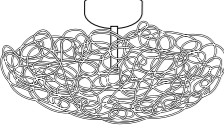

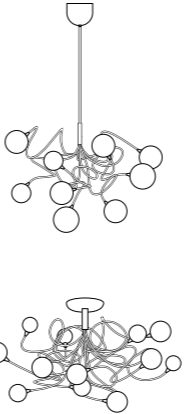
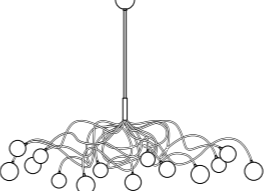
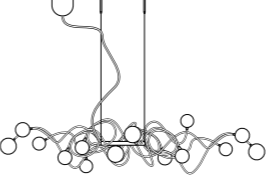

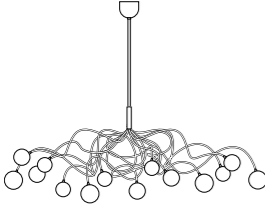

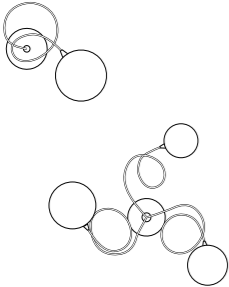
NL / ENG / D / F





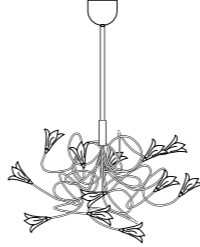



LAMP SHADES

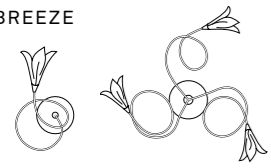

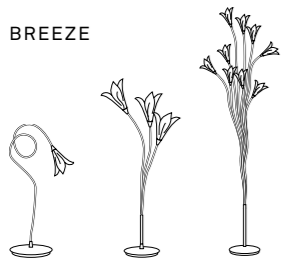

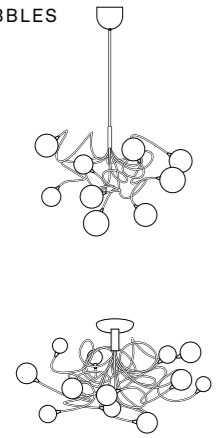

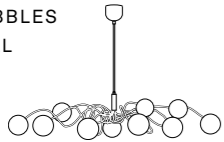
DESIGNS	TYPE	TECHN.	DIM. & FRAME	COLOR	HALO.	LED
	HL Ø 30	7 x 12 V 10 W G 4	↓ ** cm			
	HL Ø 40	9 x 12 V 10 W G 4	↓ ** cm			
	HL Ø 50	12 x 12 V 10 W G 4	↓ ** cm			
	HL Ø 60	15 x 12 V 10 W G 4	↓ ** cm			
			3 mm - alu			
	HL Ø 70	14 x 12 V 10 W G 4	↓ ** cm			
	HL Ø 100	20 x 12 V 10 W G 4	↓ ** cm			
	HL Ø 150	30 x 12 V 5 W G 4	↓ ** cm			
	HL Ø 180	35 x 12 V 5 W G 4	↓ ** cm			
			5 mm - alu			
	HL 6	6 x 12 V 10 W G 4	↓ ** cm			
	HL 13	13 x 12 V 10 W G 4	↓ ** cm			
			cable ↓ var. st. 200 cm			
	PL 6	6 x 12 V 10 W G 4	↓ 20 cm			
	PL 9	9 x 12 V 10 W G 4	↓ 42 cm			
		3 mm - inox		GBA		
	PL/WL Ø 25	3 x 12 V 20 W G 4	↓ 12 cm			
	PL/WL Ø 35	5 x 12 V 10 W G 4	↓ 15 cm			
	PL/WL Ø 50	7 x 12 V 10 W G 4	↓ 17 cm			
	PL/WL Ø 60	9 x 12 V 10 W G 4	↓ 20 cm			
			3 mm - alu			
	PL/WL Ø 70	12 x 12 V 10 W G 4	↓ 20 cm			
	PL/WL Ø 80	12 x 12 V 10 W G 4	↓ 20 cm			
	PL/WL Ø 100	15 x 12 V 10 W G 4	↓ 25 cm			
	PL/WL Ø 125	20 x 12 V 10 W G 4	↓ 30 cm			
	PL/WL Ø 150	20 x 12 V 10 W G 4	↓ 30 cm			
	PL/WL Ø 250	20 x 12 V 10 W G 4	↓ 40 cm			
			5 mm - alu			



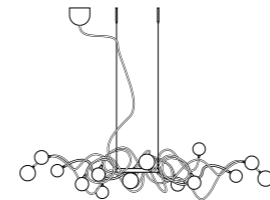

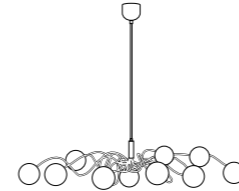

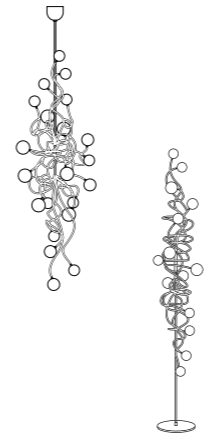
DESIGNS	TYPE	TECHN.	DIM. & FRAME	COLOR	HALO.	LED	
	HL 10	10 x 12 V 10 W G 4	Ø 100 ↓ ** cm				
	HL 14	14 x 12 V 10 W G 4	Ø 110 ↓ ** cm				
	HL 20	20 x 12 V 10 W G 4	Ø 150 ↓ ** cm				
	HL 24	24 x 12 V 10 W G 4	Ø 190 ↓ ** cm				
	HL 30	30 x 12 V 5 W G 4	Ø 250 ↓ ** cm				
	HL 35	35 x 12 V 5 W G 4	Ø 280 ↓ ** cm				
	PL 10	10 x 12 V 10 W G 4	Ø 100 ↓ 30 cm				
	PL 14	14 x 12 V 10 W G 4	Ø 110 ↓ 40 cm				
	PL 20	20 x 12 V 10 W G 4	Ø 150 ↓ 50 cm				
	PL 24	24 x 12 V 10 W G 4	Ø 190 ↓ 50 cm				
	PL 30	30 x 12 V 5 W G 4	Ø 250 ↓ 50 cm				
	PL 35	35 x 12 V 5 W G 4	Ø 280 ↓ 50 cm				
			6 mm - inox		GBU-2		
		HL 10	10 x 12 V 10 W G 4	Ø 110 x 50 cm			
HL 14		14 x 12 V 10 W G 4	Ø 140 x 50 cm				
HL 20		20 x 12 V 10 W G 4	Ø 170 x 70 cm				
HL 24		24 x 12 V 10 W G 4	Ø 180 x 70 cm				
HL 30		30 x 12 V 5 W G 4	Ø 200 x 70 cm				
HL 35		35 x 12 V 5 W G 4	Ø 250 x 100 cm				
			↓ ** cm				
			6 mm - inox		GBU-2		
		HL 10	10 x 12 V 10 W G 4	↔ 130 x 40 cm			
		HL 14	14 x 12 V 10 W G 4	↔ 160 x 45 cm			
	HL 18	18 x 12 V 10 W G 4	↔ 180 x 45 cm				
			↓ var. st. 200 cm				
			6 mm - inox		GBU-2		



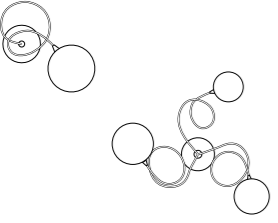

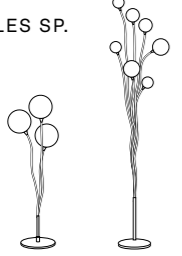

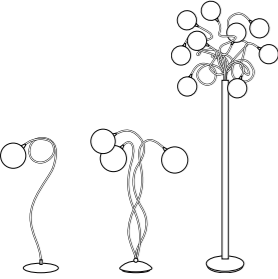

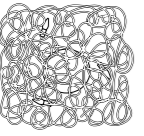

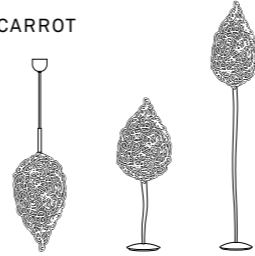
DESIGNS	TYPE	TECHN.	DIM. & FRAME	COLOR	HALO.	LED
BIG BUBBLES SPRING 	HL 10	10 x 12 V 10 W G 4	Ø 110 x 50 cm			
	HL 14	14 x 12 V 10 W G 4	Ø 140 x 50 cm			
	HL 20	20 x 12 V 10 W G 4	Ø 170 x 70 cm			
			‡ ** cm			
			6 mm - inox	GBU-2		
BIG BUBBLES LONG 	HL 20	20 x 12 V 10 W G 4	Ø 50 ‡ 200 cm			
			‡ on order			
			6 mm - inox	GBU-2		
BIG BUBBLES 	PL/WL 1 - M	1 x 12 V 20 W G 4	Ø 30 ‡ 25 cm			
	PL/WL 3	3 x 12 V 20 W G 4	Ø 40 ‡ 25 cm			
	PL/WL 5	5 x 12 V 10 W G 4	Ø 50 ‡ 25 cm			
			3 mm - inox	GBU-2		

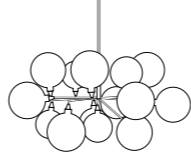

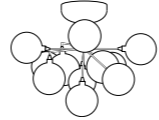

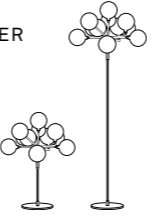

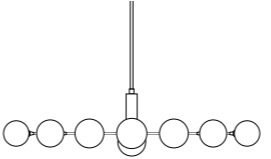

DESIGNS	TYPE	TECHN.	DIM. & FRAME	COLOR	HALO.	LED
BIG BUBBLES 	FL 7	7 x 12 V 10 W G 4	‡ 170 cm			
	FL 10	10 x 12 V 10 W G 4	‡ 175 cm			
	FL 15	15 x 12 V 10 W G 4	‡ 195 cm			
			6 mm - inox	GBU-2		
BREEZE  	HL 7	7 x 12 V 10 W G 4	Ø 70 ‡ ** cm			
	HL 9	9 x 12 V 10 W G 4	Ø 80 ‡ ** cm			
	HL 12	12 x 12 V 10 W G 4	Ø 90 ‡ ** cm			
	HL 15	15 x 12 V 10 W G 4	Ø 120 ‡ ** cm			
	HL 20	20 x 12 V 10 W G 4	Ø 140 ‡ ** cm			
	HL 30	30 x 12 V 5 W G 4	Ø 160 ‡ ** cm			
	HL 40	40 x 12 V 5 W G 4	Ø 160 ‡ ** cm			
	PL 7	7 x 12 V 10 W G 4	Ø 60 ‡ 30 cm			
	PL 9	9 x 12 V 10 W G 4	Ø 70 ‡ 30 cm			
	PL 12	12 x 12 V 10 W G 4	Ø 80 ‡ 30 cm			
	PL 15	15 x 12 V 10 W G 4	Ø 120 ‡ 40 cm			
	PL 20	20 x 12 V 10 W G 4	Ø 140 ‡ 40 cm			
	PL 30	30 x 12 V 5 W G 4	Ø 160 ‡ 45 cm			
	PL 40	40 x 12 V 5 W G 4	Ø 160 ‡ 50 cm			
			3 mm - inox	BRM		
BREEZE OVAL 	HL 12	12 x 12 V 10 W G 4	Ø 120 x 50 cm			
	HL 15	15 x 12 V 10 W G 4	Ø 130 x 60 cm			
	HL 20	20 x 12 V 10 W G 4	Ø 140 x 70 cm			
			‡ ** cm			
			3 mm - inox	BRM		

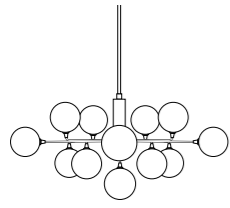

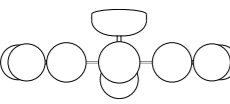
DESIGNS	TYPE	TECHN.	DIM. & FRAME	COLOR	HALO.	LED				
BREEZE 	WL/PL 1	1 x 12V 20W G4	∅ 20 → 20 cm							
	WL/PL 3	3 x 12V 20W G4	∅ 30 → 20 cm							
	WL/PL 5	5 x 12V 10W G4	∅ 40 → 25 cm	3 mm - inox						
BREEZE 	TL 1	1 x 12V 20W G4	‡ 45 cm							
	TL 3	3 x 12V 20W G4	‡ 60 cm							
	TL 6	6 x 12V 10W G4	‡ 80 cm							
	FL 9	9 x 12V 10W G4	‡ 175 cm							
	FL 12	12 x 12V 10W G4	‡ 195 cm							
			3 mm - inox	BRM						
BUBBLES 	HL 7	7 x 12V 10W G4	∅ 65 † ** cm							
	HL 9	9 x 12V 10W G4	∅ 70 † ** cm							
	HL 12	12 x 12V 10W G4	∅ 80 † ** cm							
	HL 15	15 x 12V 10W G4	∅ 100 † ** cm							
	HL 20	20 x 12V 10W G4	∅ 120 † ** cm							
	HL 30	30 x 12V 5W G4	∅ 130 † ** cm							
	HL 40	40 x 12V 5W G4	∅ 140 † ** cm							
	HL 50	50 x 12V 5W G4	∅ 150 † ** cm							
	PL 7	7 x 12V 10W G4	∅ 65 † 30 cm							
	PL 9	9 x 12V 10W G4	∅ 70 † 30 cm							
	PL 12	12 x 12V 10W G4	∅ 80 † 30 cm							
	PL 15	15 x 12V 10W G4	∅ 100 † 40 cm							
	PL 20	20 x 12V 10W G4	∅ 120 † 40 cm							
	PL 30	30 x 12V 5W G4	∅ 130 † 45 cm							
	PL 40	40 x 12V 5W G4	∅ 140 † 50 cm							
	PL 50	50 x 12V 5W G4	∅ 150 † 50 cm							
							3 mm - inox	GBU-2		
	BUBBLES OVAL 	HL 12	12 x 12V 10W G4				∅ 130 x 40 cm			
		HL 15	15 x 12V 10W G4				∅ 160 x 70 cm ‡ ** cm			
			3 mm - inox	GBU-2						

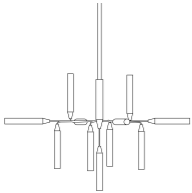

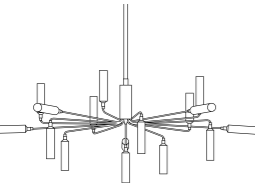

DESIGNS	TYPE	TECHN.	DIM. & FRAME	COLOR	HALO.	LED
BUBBLES KITE 	HL 10	10 x 12V 10W G4	↔ 100 x 20 cm			
	HL 14	14 x 12V 10W G4	↔ 125 x 25 cm			
	HL 18	18 x 12V 10W G4	↔ 150 x 30 cm	‡ var. st. 200 cm		
	FL 14	14 x 12V 10W G4	‡ 160 cm ‡ var			
			3 mm - inox	GBU-2		
BUBBLES SPRING 	HL 9	9 x 12V 10W G4	∅ 95 x 20 cm			
	HL 12	12 x 12V 10W G4	∅ 130 x 40 cm			
	HL 15	15 x 12V 10W G4	∅ 160 x 70 cm			
			‡ ** cm			
			3 mm - inox	GBU-2		
BUBBLES LONG 	HL 14	14 x 12V 10W G4	∅ 30 ‡ 125 cm			
	HL 18	18 x 12V 10W G4	∅ 35 ‡ 150 cm			
	HL 24	24 x 12V 5W G4	∅ 50 ‡ 200 cm			
			‡ on order			
	FL 14	14 x 12V 10W G4	‡ 150 ‡ 125 cm			
			3 mm - inox	GBU-2		

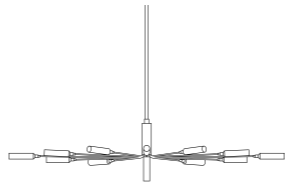
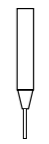
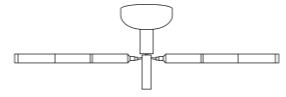
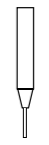
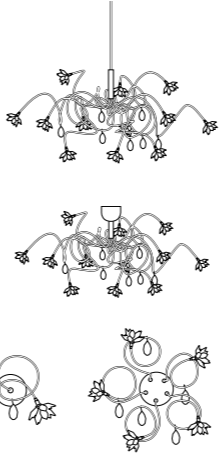



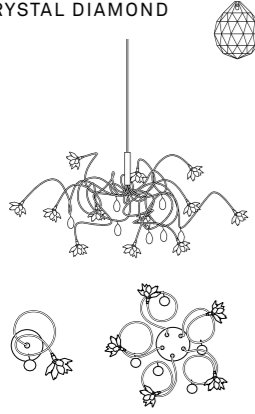

DESIGNS	TYPE	TECHN.	DIM. & FRAME	COLOR	HALO.	LED
BUBBLES 	WL/PL 1 - S	1 x 12 V 20 W G 4	∅ 20 → 25 cm			
	WL/PL 1 - M	1 x 12 V 20 W G 4	∅ 20 → 25 cm			
	WL/PL 1 - L	1 x 12 V 20 W G 4	∅ 20 → 25 cm			
	WL/PL 3	3 x 12 V 20 W G 4	∅ 40 → 25 cm			
	WL/PL 5	5 x 12 V 10 W G 4	∅ 50 → 35-50 cm			
			3 mm - inox	GBU-2		
BUBBLES SP. 	TL 3	3 x 12 V 20 W G 4	↑ 65 cm			
	TL 6	6 x 12 V 10 W G 4	↑ 85 cm			
	FL 7	7 x 12 V 10 W G 4	↑ 170 cm			
			3 mm - inox	GBU-2		
BUBBLES 	TL 1 - M	1 x 12 V 20 W G 4	↑ 55 cm			
	TL 3	3 x 12 V 20 W G 4	↑ 70 cm			
	TL 5	5 x 12 V 10 W G 4	↑ 75 cm			
	FL 7	7 x 12 V 10 W G 4	↑ 170 cm			
	FL 9	9 x 12 V 10 W G 4	↑ 175 cm			
			3 mm - inox	GBU-2		
CARRÉ 	WL/PL 3	3 x 12 V 20 W G 4	↑ 25 cm			
	WL/PL 5	5 x 12 V 10 W G 4	↑ 35 cm			
	WL/PL 7	7 x 12 V 10 W G 4	↑ 50 cm			
			↓ 15 cm			
			3 mm - alu			

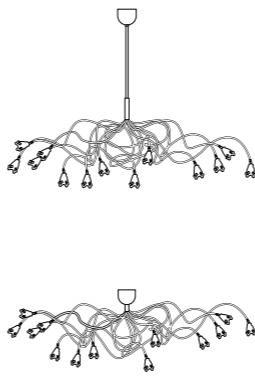

DESIGNS	TYPE	TECHN.	DIM. & FRAME	COLOR	HALO.	LED
CARROT 	HL 14	14 x 12 V 10 W G 4	↑ 75 cm ↓ ** cm			
	TL 6	6 x 12 V 10 W G 4	↑ 90 cm			
	FL 10	10 x 12 V 10 W G 4	↑ 180 cm			
			5 mm - alu			
CLUSTER / CLUSTER CABLE 	HL 4	4 x 12 V 10 W G 4	∅ 30 ↑ ** cm			
	HL 6	6 x 12 V 10 W G 4	∅ 30 ↑ ** cm			
	HL 11	11 x 12 V 10 W G 4	∅ 50 ↑ ** cm			
	HL 16	16 x 12 V 10 W G 4	∅ 55 ↑ ** cm			
			cable ↑ var. st. 200 cm			
			3 mm - inox	GBU		
CLUSTER 	WL/PL 4	4 x 12 V 10 W G 4	∅ 30 ↑ 20 cm			
	WL/PL 6	6 x 12 V 10 W G 4	∅ 30 ↑ 20 cm			
	PL 11	11 x 12 V 10 W G 4	∅ 50 ↑ 35 cm			
			3 mm - inox	GBU		
CLUSTER 	TL 11	11 x 12 V 10 W G 4	∅ 40 ↑ 60 cm			
	FL 11	11 x 12 V 10 W G 4	∅ 45 ↑ 160 cm			
			3 mm - inox	GBU		
CLUSTER OVAL 	HL 13	13 x 12 V 10 W G 4	∅ 120 x 50 cm			
	HL 17	17 x 12 V 10 W G 4	∅ 155 x 55 cm			
			↑ ** cm			
	PL 13	13 x 12 V 10 W G 4	∅ 120 x 50 cm			
	PL 17	17 x 12 V 10 W G 4	∅ 155 x 55 cm			
			↓ 35 cm			
			6 mm - inox	GBU		

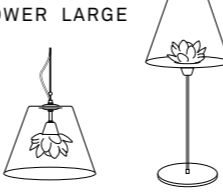



DESIGNS	TYPE	TECHN.	DIM. & FRAME	COLOR	HALO.	LED
CLUSTER CROWN 	HL 9	9 x 12 V 10 W G 4	Ø 70 ± 40 cm			
	HL 13	13 x 12 V 10 W G 4	Ø 80 ± 45 cm			
	HL 16	16 x 12 V 10 W G 4	Ø 95 ± 45 cm			
	HL 33 LED	33 x 12 V 1 W G 4	Ø 140 ± 45 cm ↓ ** cm			
	PL 9	9 x 12 V 10 W G 4	Ø 70 ↓ 40 cm 6 mm - inox	GBU		
CLUSTER WHEEL 	HL 9	9 x 12 V 10 W G 4	Ø 70 ± 25 cm			
	HL 13	13 x 12 V 10 W G 4	Ø 80 ± 30 cm			
	HL 16	16 x 12 V 10 W G 4	Ø 95 ± 30 cm ↓ ** cm			
	PL 9	9 x 12 V 10 W G 4	Ø 70 ↓ 30 cm			
	PL 13	13 x 12 V 10 W G 4	Ø 80 ↓ 35 cm			
	PL 16	16 x 12 V 10 W G 4	Ø 95 ↓ 35 cm 6 mm - inox	GBU		
CROSSFIRE / CROSSFIRE CABLE 	HL 6	6 x 12 V 10 W G 4	Ø 30 ↓ ** cm			
	HL 13	13 x 12 V 10 W G 4	Ø 52 ↓ ** cm cable ↓ var. st. 200 cm			
	PL 6	6 x 12 V 10 W G 4	Ø 30 ↓ 20 cm			
	PL 9	9 x 12 V 10 W G 4	Ø 52 ↓ 35 cm 3 mm - inox	GCR		
CROSSFIRE LARGE 	HL 13	13 x 12 V 10 W G 4	Ø 75 ± 45 cm			
	HL 16	16 x 12 V 10 W G 4	Ø 95 ± 45 cm			
	HL 33 LED	33 x 12 V 1 W G 4	Ø 136 ± 45 cm ↓ ** cm			
	PL 9	9 x 12 V 10 W G 4	Ø 65 ± 35 cm 6 mm - inox	GCR-L		

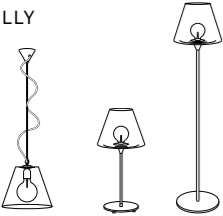
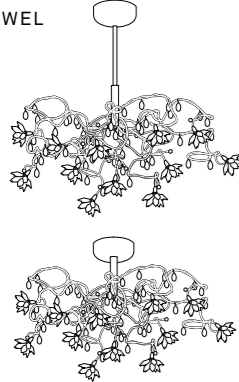

DESIGNS	TYPE	TECHN.	DIM. & FRAME	COLOR	HALO.	LED
CROSSFIRE OVAL LARGE 	HL 13	13 x 12 V 10 W G 4	Ø 120 x 46 cm			
	HL 17	17 x 12 V 10 W G 4	Ø 150 x 51 cm ↓ ** cm			
	PL 13	13 x 12 V 10 W G 4	Ø 120 x 46 cm			
	PL 17	17 x 12 V 10 W G 4	Ø 150 x 51 cm ↓ 30 cm 6 mm - inox	GCR-L		
CROSSFIRE WHEEL LARGE 	HL 13	13 x 12 V 10 W G 4	Ø 75 ± 30 cm			
	HL 16	16 x 12 V 10 W G 4	Ø 95 ± 30 cm ↓ ** cm			
	PL 13	13 x 12 V 10 W G 4	Ø 75 ↓ 30 cm			
	PL 16	16 x 12 V 10 W G 4	Ø 95 ↓ 30 cm 6 mm - inox	GCR-L		
CRYSTAL 	HL 9	9 x 12 V 10 W G 4	Ø 80 ↓ ** cm			
	HL 12	12 x 12 V 10 W G 4	Ø 90 ↓ ** cm			
	HL 14	14 x 12 V 10 W G 4	Ø 110 ↓ ** cm			
	PL 9	9 x 12 V 10 W G 4	Ø 80 ↓ 55 cm			
	PL 12	12 x 12 V 10 W G 4	Ø 90 ↓ 70 cm			
	PL 14	14 x 12 V 10 W G 4	Ø 110 ↓ 85 cm 4 mm - inox	GCY		
	WL/PL 1	1 x 12 V 10 W G 4	Ø 20 → 20 cm			
	WL/PL 3	3 x 12 V 10 W G 4	Ø 30 → 20 cm			
	WL/PL 5	5 x 12 V 10 W G 4	Ø 40 → 25 cm 3 mm - inox	GCY 2 3 4 5 7 10 15 18 22		
CRYSTAL OVAL	HL 23 LED	23 x 12 V 1 W G 4	Ø 140 x 60 cm 4 mm - inox	GCY 2 3 4 5 7 10 15 18 22		

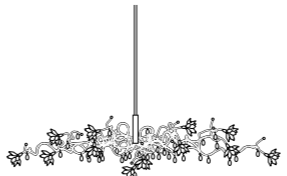

DESIGNS	TYPE	TECHN.	DIM. & FRAME	COLOR	HALO.	LED
CRYSTAL DIAMOND 	HL 9	9 x 12 V 10 W G 4	Ø 80 † ** cm	 GCY 2 3 4 5 7 10 15 18 22		
	HL 12	12 x 12 V 10 W G 4	Ø 90 † ** cm			
	HL 14	14 x 12 V 10 W G 4	Ø 110 † ** cm			
	PL 9	9 x 12 V 10 W G 4	Ø 80 † 55 cm			
	PL 12	12 x 12 V 10 W G 4	Ø 90 † 70 cm			
	PL 14	14 x 12 V 10 W G 4	Ø 110 † 85 cm			
			4 mm - inox			
	WL/PL 1	1 x 12 V 20 W G 4	Ø 20 † 20 cm			
	WL/PL 3	3 x 12 V 20 W G 4	Ø 30 † 20 cm			
	WL/PL 5	5 x 12 V 10 W G 4	Ø 40 † 25 cm			
		3 mm - inox				
CRYSTAL DIAMOND OVAL	HL 23 LED	23 x 12 V 1 W G 4	Ø 140 x 60 cm	GCY 2 3 4 5 7 10 15 18 22		
			4 mm - inox			
FLAG 	HL 10	10 x 12 V 10 W G 4	Ø 90 † ** cm	 GFL-2		
	HL 14	14 x 12 V 10 W G 4	Ø 100 † ** cm			
	HL 20	20 x 12 V 10 W G 4	Ø 170 † ** cm			
	HL 24	24 x 12 V 5 W G 4	Ø 180 † ** cm			
	HL 30	30 x 12 V 5 W G 4	Ø 200 † ** cm			
	HL 35	35 x 12 V 5 W G 4	Ø 280 † ** cm			
			6 mm - inox			
	PL 10	10 x 12 V 10 W G 4	Ø 90 † 30 cm			
	PL 14	14 x 12 V 10 W G 4	Ø 100 † 40 cm			
	PL 20	20 x 12 V 10 W G 4	Ø 170 † 50 cm			
	PL 24	24 x 12 V 10 W G 4	Ø 180 † 50 cm			
	PL 30	30 x 12 V 5 W G 4	Ø 200 † 50 cm			
	PL 35	35 x 12 V 5 W G 4	Ø 250 † 50 cm			
			6 mm - inox			

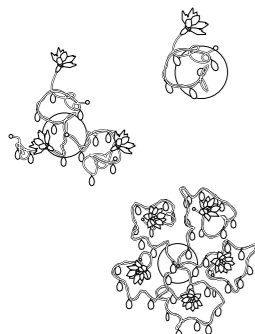

DESIGNS	TYPE	TECHN.	DIM. & FRAME	COLOR	HALO.	LED
FLAG OVAL 	HL 10	10 x 12 V 10 W G 4	Ø 110 x 50 cm	 GFL-2		
	HL 14	14 x 12 V 10 W G 4	Ø 140 x 50 cm			
	HL 20	20 x 12 V 10 W G 4	Ø 170 x 60 cm			
	HL 24	24 x 12 V 10 W G 4	Ø 180 x 70 cm			
	HL 30	30 x 12 V 5 W G 4	Ø 200 x 70 cm			
	HL 35	35 x 12 V 5 W G 4	Ø 250 x 80 cm			
			† ** cm			
	PL 10	10 x 12 V 10 W G 4	Ø 110 x 50 cm			
	PL 14	14 x 12 V 10 W G 4	Ø 145 x 65 cm			
	PL 20	20 x 12 V 10 W G 4	Ø 170 x 70 cm			
PL 24	24 x 12 V 10 W G 4	Ø 180 x 70 cm				
PL 30	30 x 12 V 5 W G 4	Ø 200 x 70 cm				
PL 35	35 x 12 V 5 W G 4	Ø 250 x 80 cm				
		† min.40cm				
		6 mm - inox				
FLOWER	HL 1	1 x G4 20 W	Ø 15 † var. st. 200 cm	 GCY 2 3 4 5 7 10 15 18 22		
	TL 1	1 x G4 20 W	Ø 15 † 57 cm			
	FL 1	1 x G4 20 W	Ø 15 † 127 cm			
			inox			
FLOWER LARGE 	HL 1	1 x E14 60 W	Ø 30 † var. st. 200 cm	 GBF 2 5 15 18 22		
	TL 1	1 x E14 60 W	Ø 30 † 68 cm			
	FL 1	1 x E14 60 W	Ø 30 † 140 cm			
			inox			
HOOD 	TL 1	1 x 12 V 20 W	Ø 11 † 52 cm	 GH0-1		
			3 mm - inox			



DESIGNS	TYPE	TECHN.	DIM. & FRAME	COLOR	HALO.	LED	
	JELLY						
	HL 1 - L	1 x E27 60 W	∅ 30 † var. st. 200 cm				
	TL 1 - L	1 x E27 60 W	∅ 30 † 65 cm				
	FL 1 - L	1 x E27 60 W	∅ 30 † 135 cm				
				inox			
	HL 9	9 x 12 V 10 W G 4	∅ 50 † ** cm				
	HL 12	12 x 12 V 10 W G 4	∅ 60 † ** cm				
	HL 15	15 x 12 V 10 W G 4	∅ 80 † ** cm				
	HL 24	24 x 12 V 10 W G 4	∅ 120 † ** cm				
	PL 9	9 x 12 V 10 W G 4	∅ 50 † 30 cm				
	PL 12	12 x 12 V 10 W G 4	∅ 60 † 30 cm				
	PL 15	15 x 12 V 10 W G 4	∅ 80 † 35 cm				
	PL 24	24 x 12 V 10 W G 4	∅ 120 † 35 cm				
					GCY		
				2 x 3 mm - inox	2 3 4 5 7		10 15 18 22
	HL 12	12 x 12 V 10 W G 4	∅ 75 † ** cm				
	HL 15	15 x 12 V 10 W G 4	∅ 95 † ** cm				
	HL 24	24 x 12 V 10 W G 4	∅ 115 † ** cm				
	HL 27	27 x 12 V 10 W G 4	∅ 130 † ** cm				
					GCY		
			2 x 3 mm - inox	2 3 4 5 7		10 15 18 22	
	HL 12	12 x 12 V 10 W G 4	∅ 125 x 40 cm				
	HL 15	15 x 12 V 10 W G 4	∅ 135 x 55 cm				
	HL 24	24 x 12 V 10 W G 4	∅ 145 x 65 cm				
	HL 27	27 x 12 V 10 W G 4	∅ 150 x 75 cm				
				† ** cm	GCY		
			2 x 3 mm - inox	2 3 4 5 7		10 15 18 22	



DESIGNS	TYPE	TECHN.	DIM. & FRAME	COLOR	HALO.	LED
	JEWEL DOUBLE					
	HL 30	30 x 12 V 5 W G 4	∅ 90 † 105 cm			
	HL 48	48 x 12 V 5 W G 4	∅ 120 † 120 cm			
			† ** cm	GCY		
			2 x 3 mm - inox	2 3 4 5 7		10 15 18 22
	JEWEL LONG					
	PL 9	9 x 12 V 10 W G 4	† 70 cm			
				GCY		
			2 x 3 mm - inox	2 3 4 5 7		10 15 18 22
	JEWEL OVAL					
	HL 9	9 x 12 V 10 W G 4	∅ 90 x 35 cm			
	HL 12	12 x 12 V 10 W G 4	∅ 100 x 40 cm			
	HL 15	15 x 12 V 10 W G 4	∅ 120 x 45 cm			
	HL 24	24 x 12 V 10 W G 4	∅ 145 x 45 cm			
			† ** cm	GCY		
			2 x 3 mm - inox	2 3 4 5 7		10 15 18 22
	JEWEL KITE					
	HL 12	12 x 12 V 10 W G 4	↔ 110 x 30 cm			
	HL 18	18 x 12 V 10 W G 4	↔ 140 x 40 cm			
	HL 30	30 x 12 V 5 W G 4	↔ 180 x 40 cm			
			† var. st. 200 cm	GCY		
			2 x 3 mm - inox	2 3 4 5 7		10 15 18 22

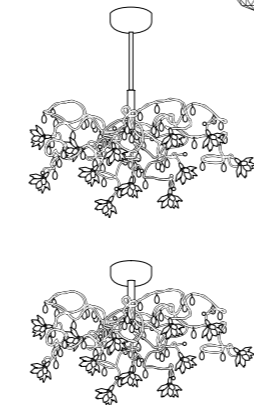

DESIGNS	TYPE	TECHN.	DIM. & FRAME	COLOR	HALO.	LED
	WL/PL 1	1 x 12 V 20 W G 4	∅ 20 → 15 cm	 GCY 2 3 4 5 7 10 15 18 22		
	WL/PL 3	3 x 12 V 20 W G 4	∅ 30 → 15 cm			
	WL/PL 5	5 x 12 V 10 W G 4	∅ 45 → 20 cm			







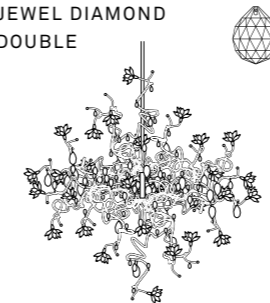

	WL 5	5 x 12 V 10 W G 4	↑ 70 ↔ 30 cm → 20 cm	 GCY 2 3 4 5 7 10 15 18 22		
	WL 9	9 x 12 V 10 W G 4	↑ 110 ↔ 35 cm → 20 cm			

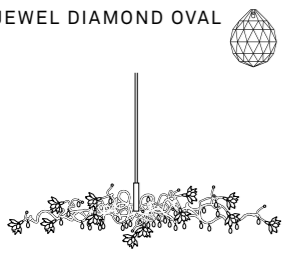
	TL 1	1 x 12 V 20 W G 4	↑ 50 cm	 GCY 2 3 4 5 7 10 15 18 22		
	TL 3	3 x 12 V 20 W G 4	↑ 60 cm			



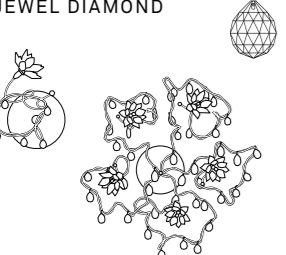

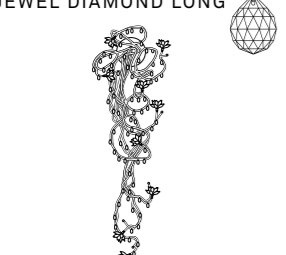

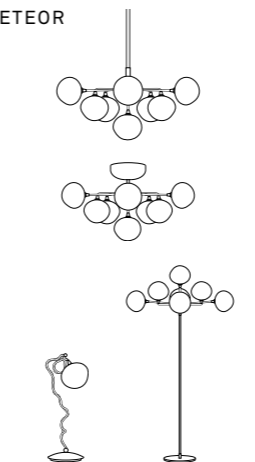

DESIGNS	TYPE	TECHN.	DIM. & FRAME	COLOR	HALO.	LED
	HL 9	9 x 12 V 10 W G 4	∅ 50 ↓ ** cm	 GCY 2 3 4 5 7 10 15 18 22		
	HL 12	12 x 12 V 10 W G 4	∅ 60 ↓ ** cm			
	HL 15	15 x 12 V 10 W G 4	∅ 80 ↓ ** cm			
	HL 24	24 x 12 V 10 W G 4	∅ 120 ↓ ** cm			
	PL 9	9 x 12 V 10 W G 4	∅ 50 ↓ 30 cm			
	PL 12	12 x 12 V 10 W G 4	∅ 60 ↓ 30 cm			
	PL 15	15 x 12 V 10 W G 4	∅ 80 ↓ 35 cm			
	PL 24	24 x 12 V 10 W G 4	∅ 120 ↓ 35 cm			

	HL 12	12 x 12 V 10 W G 4	∅ 75 ↓ ** cm	 GCY 2 3 4 5 7 10 15 18 22		
	HL 15	15 x 12 V 10 W G 4	∅ 85 ↓ ** cm			
	HL 24	24 x 12 V 10 W G 4	∅ 125 ↓ ** cm			

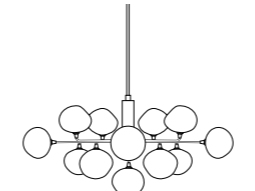

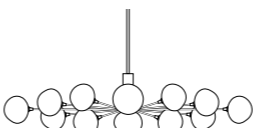

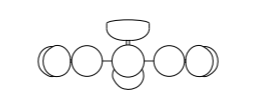





	HL 30	30 x 12 V 5 W G 4	∓ 90 x 105 cm	 GCY 2 3 4 5 7 10 15 18 22		
	HL 48	48 x 12 V 5 W G 4	∓ 120 x 120 cm ↑ on order			



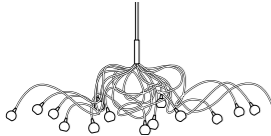

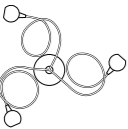



DESIGNS	TYPE	TECHN.	DIM. & FRAME	COLOR	HALO.	LED
<p>JEWEL DIAMOND OVAL</p> 	HL 9	9 x 12 V 10 W G 4	∅ 90 x 35 cm	 GCY 2 3 4 5 7 10 15 18 22		
	HL 12	12 x 12 V 10 W G 4	∅ 100 x 40 cm			
	HL 15	15 x 12 V 10 W G 4	∅ 120 x 45 cm			
	HL 24	24 x 12 V 10 W G 4	∅ 145 x 45 cm			
			‡ ** cm			
			2 x 3 mm - inox			
<p>JEWEL DIAMOND KITE</p> 	HL 12	12 x 12 V 10 W G 4	↔ 110 x 30 cm	 GCY 2 3 4 5 7 10 15 18 22		
	HL 18	18 x 12 V 10 W G 4	↔ 140 x 40 cm			
	HL 30	30 x 12 V 5 W G 4	↔ 180 x 40 cm			
			‡ var. st. 200 cm			
			2 x 3 mm - inox			
<p>JEWEL DIAMOND</p> 	WL/PL 1	1 x 12 V 20 W G 4	∅ 20 ↔ 15 cm	 GCY 2 3 4 5 7 10 15 18 22		
	WL/PL 3	3 x 12 V 20 W G 4	∅ 30 ↔ 15 cm			
	WL/PL 5	5 x 12 V 10 W G 4	∅ 45 ↔ 20 cm			
			2 x 3 mm - inox			
<p>JEWEL DIAMOND LONG</p> 	WL 5	5 x 12 V 10 W G 4	‡ 70 ↔ 30 cm ↔ 20 cm	 GCY 2 3 4 5 7 10 15 18 22		
	WL 9	9 x 12 V 10 W G 4	‡ 110 ↔ 35 cm ↔ 20 cm			
			2 x 3 mm - inox			

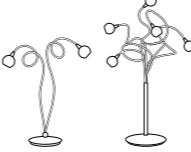

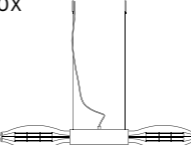

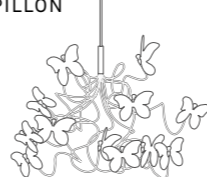
140



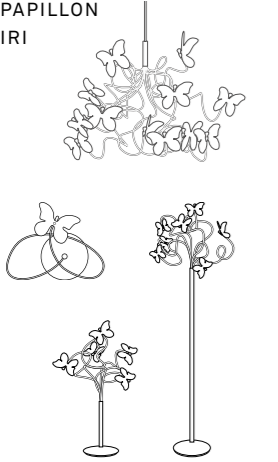

DESIGNS	TYPE	TECHN.	DIM. & FRAME	COLOR	HALO.	LED
<p>METEOR</p> 	HL 1	1 x 12 V 20 W G 4	∅ 8 ‡ 10 cm	 GME-2		
	HL 5	5 x 12 V 10 W G 4	∅ 35 ‡ 25 cm			
	HL 9	9 x 12 V 10 W G 4	∅ 55 ‡ 35 cm			
	HL 13	13 x 12 V 10 W G 4	∅ 55 ‡ 35 cm ‡ ** cm			
	WL/PL 1	1 x 12 V 20 W G 4	∅ 10 ‡ 10 cm			
	WL/PL 5	5 x 12 V 10 W G 4	∅ 35 ‡ 25 cm			
	WL/PL 9	9 x 12 V 10 W G 4	∅ 55 ‡ 35 cm			
			3 mm - inox			
<p>METEOR LARGE</p> 	HL 9	9 x 12 V 10 W G 4	∅ 65 ‡ 30 cm	 GME-2		
	HL 13	13 x 12 V 10 W G 4	∅ 75 ‡ 35 cm ‡ ** cm			
	PL 9	9 x 12 V 10 W G 4	∅ 65 ‡ 35 cm			
			6 mm - inox			
<p>METEOR LARGE OVAL</p> 	HL 13	13 x 12 V 10 W G 4	∅ 115 x 45 cm ‡ 25 cm ‡ ** cm	 GME-2		
			6 mm - inox			
<p>METEOR WHEEL</p> 	HL 13	13 x 12 V 10 W G 4	∅ 75 ‡ 25 cm ‡ ** cm	 GME-2		
	PL 13	13 x 12 V 10 W G 4	∅ 75 ‡ 30 cm			
			6 mm - inox			



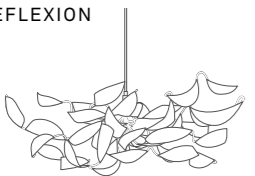
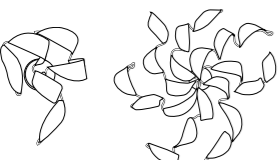

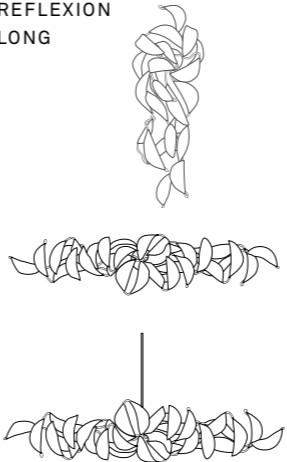
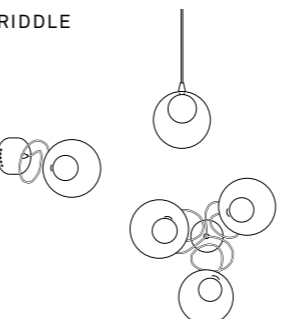

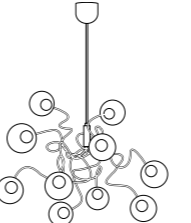

141

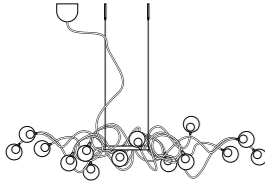

DESIGNS	TYPE	TECHN.	DIM. & FRAME	COLOR	HALO.	LED	
MURRINI   	HL 7	7 x 12V 10W G4	∅ 70 † ** cm				
	HL 9	9 x 12V 10W G4	∅ 80 † ** cm				
	HL 12	12 x 12V 10W G4	∅ 90 † ** cm				
	HL 15	15 x 12V 10W G4	∅ 120 † ** cm				
	HL 20	20 x 12V 10W G4	∅ 140 † ** cm				
	PL 7	7 x 12V 10W G4	∅ 60 † 30 cm				
	PL 9	9 x 12V 10W G4	∅ 60 † 30 cm				
	PL 12	12 x 12V 10W G4	∅ 80 † 30 cm				
	PL 15	15 x 12V 10W G4	∅ 120 † 40 cm				
	PL 20	20 x 12V 10W G4	∅ 140 † 40 cm				
				3 mm - inox	GMU		
	MURRINI OVAL 	HL 12	12 x 12V 10W G4	∅ 120 x 50 cm			
		HL 15	15 x 12V 10W G4	∅ 130 x 60 cm			
		HL 20	20 x 12V 10W G4	∅ 140 x 70 cm			
			† ** cm				
			3 mm - inox	GMU			
MURRINI 	WL/PL 1	1 x 12V 20W G4	∅ 20 → 20 cm				
	WL/PL 3	3 x 12V 20W G4	∅ 30 → 20 cm				
	WL/PL 5	5 x 12V 10W G4	∅ 30 → 25 cm				
				3 mm - inox	GMU		
MURRINI LONG 	WL 5	5 x 12V 10W G4	† 50 → 25 cm				
	WL 7	7 x 12V 10W G4	† 70 → 30 cm				
	WL 9	9 x 12V 10W G4	† 120 → 30 cm				
	WL 12	12 x 12V 10W G4	† 120 → 30 cm				
				3 mm - inox	GMU		

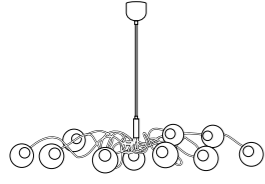

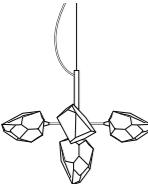

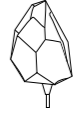
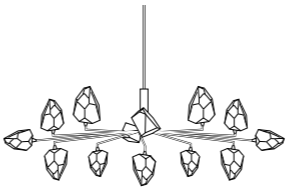
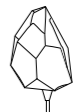
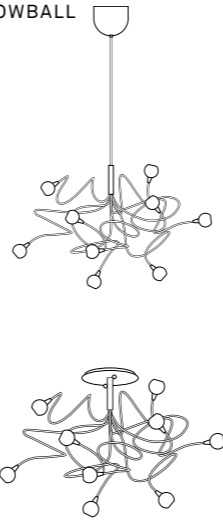

DESIGNS	TYPE	TECHN.	DIM. & FRAME	COLOR	HALO.	LED	
MURRINI  	TL 1	1 x 12V 20W G4	† 50 cm				
	TL 2	2 x 12V 20W G4	† 50 cm				
	TL 3	3 x 12V 20W G4	† 50 cm				
	TL 5	5 x 12V 10W G4	† 70 cm				
	FL 7	7 x 12V 10W G4	† 160 cm				
	FL 9	9 x 12V 10W G4	† 170 cm				
			3 mm - inox	GMU			
OX  	HL 2	2 x E40 11W LED	∅ 105 x 12 cm				
	HL 3	3 x E40 11W LED	∅ 110 † ** cm				
	TL 1	1 x E40 11W LED	† 55 cm				
FL 1	1 x E40 11W LED	† 200 cm					
PAPILLON   	HL 7	7 x 12V 10W G4	∅ 50 † ** cm				
	HL12	12 x 12V 10W G4	∅ 70 † ** cm				
	PL 7	7 x 12V 10W G4	∅ 50 † 35 cm				
	PL12	12 x 12V 10W G4	∅ 70 † 45 cm				
	WL 1	1 x 12V 20W G4	∅ 20 → 20 cm				
	WL 3	3 x 12V 20W G4	∅ 40 → 25 cm				
	TL 5	5 x 12V 10W G4	∅ 45 † 70 cm				
	FL 7	7 x 12V 10W G4	∅ 50 † 155 cm				
				3 mm - inox			
	TL 1	1 x 12V 20W G4	∅ 14 † 60 cm				
			2 x 3 mm - inox	GPP-2			

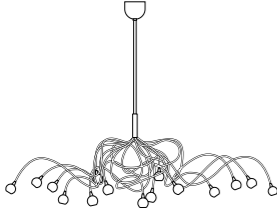

DESIGNS	TYPE	TECHN.	DIM. & FRAME	COLOR	HALO.	LED	
PAPHILON IRI 	HL 7	7 x 12 V 10 W G 4	∅ 50 ↓ ** cm				
	HL12	12 x 12 V 10 W G 4	∅ 70 ↓ ** cm				
	PL 7	7 x 12 V 10 W G 4	∅ 50 ↓ 35 cm				
	PL12	12 x 12 V 10 W G 4	∅ 70 ↓ 45 cm				
	WL 1	1 x 12 V 20 W G 4	∅ 20 → 20 cm				
	WL 3	3 x 12 V 20 W G 4	∅ 40 → 25 cm				
	TL 5	5 x 12 V 10 W G 4	∅ 45 ↓ 70 cm				
	FL 7	7 x 12 V 10 W G 4	∅ 50 ↓ 155 cm				
	TL 1	1 x 12 V 20 W G 4	G 4	3 mm - inox			
				∅ 14 ↓ 60 cm			
PENNE		FL 5	5 x 12 V 20 W G 4	↓ 185 cm			
		FL 7	7 x 12 V 20 W G 4	↓ 195 cm			
				6 mm - inox		GPE-1	
REFLEXION		HL 12	12 x 12 V 10 W G 4	∅ 110 ↓ ** cm			
		HL 15	15 x 12 V 10 W G 4	∅ 130 ↓ ** cm			
		PL 12	12 x 12 V 10 W G 4	∅ 110 ↓ 50 cm			
		PL 15	15 x 12 V 10 W G 4	∅ 130 ↓ 55 cm			
				3 mm inox-alu			
REFLEXION		WL/PL 3	3 x 12 V 20 W G 4	∅ 40 → 25 cm			
		WL/PL 5	5 x 12 V 10 W G 4	∅ 50 → 30 cm			
		PL 7	7 x 12 V 10 W G 4	∅ 65 → 35 cm			
		PL 9	9 x 12 V 10 W G 4	∅ 80 → 35 cm			
		PL 12	12 x 12 V 10 W G 4	∅ 100 → 35 cm			
				3 mm inox-alu			

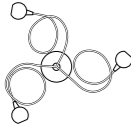

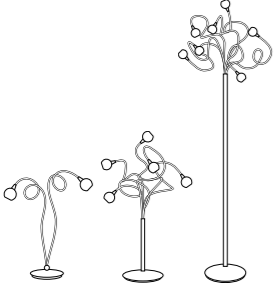

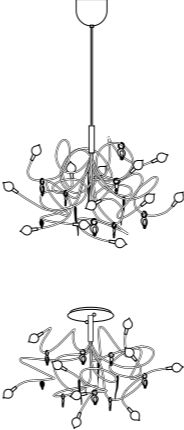

DESIGNS	TYPE	TECHN.	DIM. & FRAME	COLOR	HALO.	LED	
REFLEXION LONG		WL 5	5 x 12 V 10 W G 4	↓ 90 → 25 cm			
		WL 7	7 x 12 V 10 W G 4	↓ 100 → 30 cm			
		WL 9	9 x 12 V 10 W G 4	↓ 130 → 35 cm			
		WL 12	12 x 12 V 10 W G 4	↓ 140 → 35 cm			
					→ 45 cm		
		PL 12	12 x 12 V 10 W G 4	→ 35 ↓ 160 cm			
			→ 35 cm				
RIDDLE		HL 1	1 x 12 V 20 W G 4	∅ 12 ↓ ** cm			
		PL/WL 1	1 x 12 V 20 W G 4	∅ 12 → 25 cm			
		PL/WL 3	3 x 12 V 20 W G 4	∅ 35 → 25 cm			
							
			3 mm - inox	GRI	∅ 12/6 CM		
RIDDLE SIX		HL 10	10 x 12 V	G 4	∅ 100 ↓ ** cm		
		HL 14	14 x 12 V	G 4	∅ 110 ↓ ** cm		
		HL 20	20 x 12 V	G 4	∅ 180 ↓ ** cm		
		HL 24	24 x 12 V	G 4	∅ 190 ↓ ** cm		
		HL 30	30 x 12 V	G 4	∅ 250 ↓ ** cm		
		HL 35	35 x 12 V	G 4	∅ 250 ↓ ** cm		
							
			6 mm - inox	GRI	∅ 12/6 CM		

DESIGNS	TYPE	TECHN.	DIM. & FRAME	COLOR	HALO.	LED
RIDDLE SIX KITE 	HL 10	10 x 12 V 10 W G 4	↔ 110 x 35 cm			
	HL 14	14 x 12 V 10 W G 4	↔ 140 x 45 cm			
	HL 18	18 x 12 V 10 W G 4	↔ 160 x 45 cm			
			‡ var. st. 200 cm			
			6 mm - inox	GRI Ø 12/6 CM		
RIDDLE SIX LONG 	HL 14	14 x 12 V 10 W G 4	Ø 40 ‡ 170 cm			
	HL 20	20 x 12 V 10 W G 4	Ø 50 ‡ 200 cm			
			‡ on order			
			6 mm - inox	GRI Ø 12/6 CM		
RIDDLE SIX OVAL 	HL 10	10 x 12 V 10 W G 4	Ø 110 x 40 cm			
	HL 14	14 x 12 V 10 W G 4	Ø 140 x 50 cm			
	HL 20	20 x 12 V 10 W G 4	Ø 170 x 70 cm			
	HL 24	24 x 12 V 10 W G 4	Ø 180 x 70 cm			
	HL 30	30 x 12 V 5 W G 4	Ø 200 x 70 cm			
			‡ ** cm			
			6 mm - inox	GRI Ø 12/6 CM		
ROCK 	HL 1	1 x 12 V 10 W G 4	Ø 8 ‡ 10 cm			
	HL 5	5 x 12 V 10 W G 4	Ø 35 ‡ 25 cm			
	HL 9	9 x 12 V 10 W G 4	Ø 55 ‡ 35 cm			
	HL 13	13 x 12 V 10 W G 4	Ø 55 ‡ 35 cm			
			3 mm - inox	GRO		

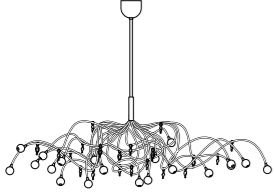



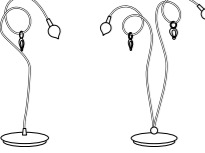
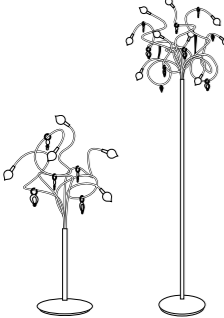

DESIGNS	TYPE	TECHN.	DIM. & FRAME	COLOR	HALO.	LED	
ROCK 	WL/PL 1	1 x 12 V 10 W G 4	Ø 10 ‡ 10 cm				
	WL/PL 5	5 x 12 V 10 W G 4	Ø 35 ‡ 25 cm				
	WL/PL 9	9 x 12 V 10 W G 4	Ø 55 ‡ 35 cm				
	TL 1	1 x 12 V 10 W G 4	Ø 10 ‡ 10 cm				
	TL 5	5 x 12 V 10 W G 4	Ø 30 ‡ 65 cm				
	FL 9	9 x 12 V 10 W G 4	Ø 35 ‡ 165 cm				
			3 mm - inox	GRO			
ROCK LARGE 	HL 13	13 x 12 V 10 W G 4	Ø 80 ‡ ** cm				
			6 mm - inox	GRO			
SNOWBALL 	HL 7	7 x 12 V 10 W G 4	Ø 70 ‡ ** cm				
	HL 9	9 x 12 V 10 W G 4	Ø 80 ‡ ** cm				
	HL 12	12 x 12 V 10 W G 4	Ø 90 ‡ ** cm				
	HL 15	15 x 12 V 10 W G 4	Ø 120 ‡ ** cm				
	HL 20	20 x 12 V 10 W G 4	Ø 140 ‡ ** cm				
		PL 7	7 x 12 V 10 W G 4				Ø 60 ‡ 30 cm
		PL 9	9 x 12 V 10 W G 4				Ø 60 ‡ 30 cm
		PL 12	12 x 12 V 10 W G 4				Ø 80 ‡ 30 cm
		PL 15	15 x 12 V 10 W G 4				Ø 120 ‡ 40 cm
		PL 20	20 x 12 V 10 W G 4				Ø 140 ‡ 40 cm
			3 mm - inox	GSN-1			

DESIGNS	TYPE	TECHN.	DIM. & FRAME	COLOR	HALO.	LED
SNOWBALL OVAL 	HL 12	12 x 12 V 10 W G 4	Ø 120 x 50 cm			
	HL 15	15 x 12 V 10 W G 4	Ø 130 x 60 cm			
	HL 20	20 x 12 V 10 W G 4	Ø 140 x 70 cm			
			‡ ** cm			
			3 mm - inox	GSN-1		
SNOWBALL 	WL/PL 1	1 x 12 V 20 W G 4	Ø 20 → 20 cm			
	WL/PL 3	3 x 12 V 20 W G 4	Ø 30 → 20 cm			
	WL/PL 5	5 x 12 V 10 W G 4	Ø 30 → 25 cm			
			3 mm - inox	GSN-1		
148 SNOWBALL 	TL 1	1 x 12 V 20 W G 4	‡ 50 cm			
	TL 2	2 x 12 V 20 W G 4	‡ 50 cm			
	TL 3	3 x 12 V 20 W G 4	‡ 50 cm			
	TL 5	5 x 12 V 10 W G 4	‡ 70 cm			
	FL 7	7 x 12 V 20 W G 4	‡ 160 cm			
	FL 9	9 x 12 V 10 W G 4	‡ 170 cm			
			3 mm - inox	GSN-1		
STARDUST 	HL Ø 14	3W / 50 X MINI-LED	Ø 14 ‡ var. st. 200 cm			
	HL Ø 24	6W / 100 X MINI-LED	Ø 24 ‡ var. st. 200 cm			
	HL Ø 29	6W / 100 X MINI-LED	Ø 29 ‡ var. st. 200 cm			
	HL Ø 38	12W / 200 X MINI-LED	Ø 38 ‡ var. st. 200 cm			

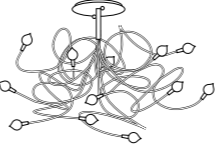

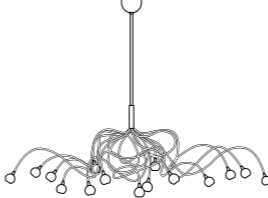

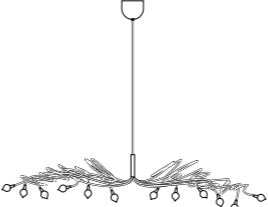
DESIGNS	TYPE	TECHN.	DIM. & FRAME	COLOR	HALO.	LED
STARDUST 	PL/WL Ø 14	3W / 50 X MINI-LED	Ø 14 ‡ 20 cm	white, warm white		
	PL/WL Ø 24	6W / 100 X MINI-LED	Ø 24 ‡ 18 cm			
	PL/WL Ø 29	6W / 100 X MINI-LED	Ø 29 ‡ 20 cm			
	PL/WL Ø 38	12W / 200 X MINI-LED	Ø 39 ‡ 24 cm			
STARDUST OBJECT 	TL Ø 14	3W / 50 X MINI-LED	Ø 14 ‡ 16 cm	white, warm white		
TL Ø 24	6W / 100 X MINI-LED	Ø 24 ‡ 14 cm				
TL Ø 29	6W / 100 X MINI-LED	Ø 29 ‡ 17 cm				
TL Ø 38	12W / 200 X MINI-LED	Ø 38 ‡ 22 cm				
149 STRAWBERRY 	HL 7	7 x 12 V 10 G 4	Ø 70 ‡ ** cm	3 mm - inox		
	HL 9	9 x 12 V 10 G 4	Ø 80 ‡ ** cm			
	HL 12	12 x 12 V 10 G 4	Ø 90 ‡ ** cm			
	HL 15	15 x 12 V 10 G 4	Ø 120 ‡ ** cm			
	HL 20	20 x 12 V 10 G 4	Ø 140 ‡ ** cm			
	PL 7	7 x 12 V 10 G 4	Ø 50 ‡ 30 cm			
	PL 9	9 x 12 V 10 G 4	Ø 60 ‡ 30 cm			
	PL 12	12 x 12 V 10 G 4	Ø 80 ‡ 30 cm			
	PL 15	15 x 12 V 10 G 4	Ø 120 ‡ 40 cm			
	PL 20	20 x 12 V 10 G 4	Ø 140 ‡ 40 cm			
			3 mm - inox	GSW multicol. 2 4 5 7 8 9 10 15		





DESIGNS	TYPE	TECHN.	DIM. & FRAME	COLOR	HALO.	LED
STRAWBERRY OVAL 	HL 12	12 x 12 V 10 W G 4	∅ 120 x 50 cm	 GSW multicol. 2 4 5 7 8 3 mm - inox 9 10 15		
	HL 15	15 x 12 V 10 W G 4	∅ 130 x 60 cm			
	HL 20	20 x 12 V 10 W G 4	∅ 140 x 70 cm			
STRAWBERRY 	WL/PL 1	1 x 12 V 20 W G 4	∅ 20 → 20 cm	 GSW multicol. 2 4 5 7 8 9 10 15		
	WL/PL 3	3 x 12 V 20 W G 4	∅ 30 → 20 cm			
	WL/PL 5	5 x 12 V 10 W G 4	∅ 40 → 25 cm			
STRAWBERRY  	TL 1	1 x 12 V 20 W G 4	↑ 50 cm	 GSW multicol. 2 4 5 7 8 3 mm - inox 9 10 15		
	TL 2	2 x 12 V 20 W G 4	↑ 50 cm			
	TL 3	3 x 12 V 20 W G 4	↑ 50 cm			
	TL 5	5 x 12 V 10 W G 4	↑ 70 cm			
	FL 7	7 x 12 V 20 W G 4	↑ 160 cm			
	FL 9	9 x 12 V 10 W G 4	↑ 170 cm			

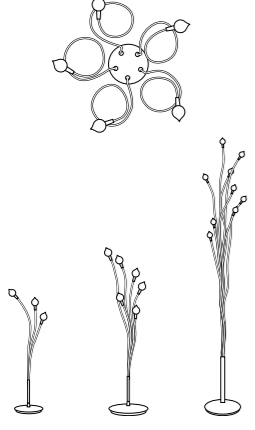

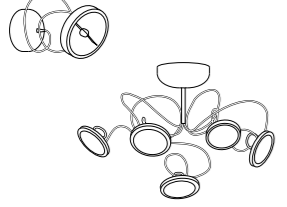
150

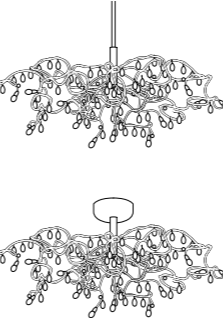

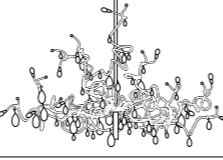
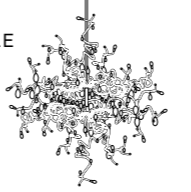
DESIGNS	TYPE	TECHN.	DIM. & FRAME	COLOR	HALO.	LED
SWEET  	HL 7	7 x 12 V 10 W G 4	∅ 70 ↓ ** cm	 GSW multicol. 2 4 5 7 8 3 mm - inox 9 10 15		
	HL 9	9 x 12 V 10 W G 4	∅ 80 ↓ ** cm			
	HL 12	12 x 12 V 10 W G 4	∅ 90 ↓ ** cm			
	HL 15	15 x 12 V 10 W G 4	∅ 120 ↓ ** cm			
	HL 20	20 x 12 V 10 W G 4	∅ 140 ↓ ** cm			
	PL 7	7 x 12 V 10 W G 4	∅ 60 ↓ 30 cm			
	PL 9	9 x 12 V 10 W G 4	∅ 70 ↓ 30 cm			
	PL 12	12 x 12 V 10 W G 4	∅ 80 ↓ 30 cm			
	PL 15	15 x 12 V 10 W G 4	∅ 120 ↓ 40 cm			
	PL 20	20 x 12 V 10 W G 4	∅ 140 ↓ 40 cm			
	SWEET OVAL 	HL 12	12 x 12 V 10 W G 4		∅ 120 x 50 cm	 GSW multicol. 2 4 5 7 8 3 mm - inox 9 10 15
HL 15		15 x 12 V 10 W G 4	∅ 130 x 60 cm			
HL 20		20 x 12 V 10 W G 4	∅ 140 x 70 cm			
			↑ ** cm			
SWEET LONG 	HL 12	12 x 12 V 10 W G 4	↔ 125 ↓ ** cm	 GSW multicol. 2 4 5 7 8 3 mm - inox 9 10 15		
	HL 15	15 x 12 V 10 W G 4	↔ 140 ↓ ** cm			

151

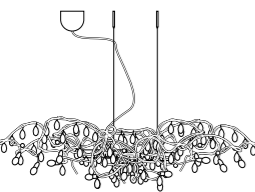
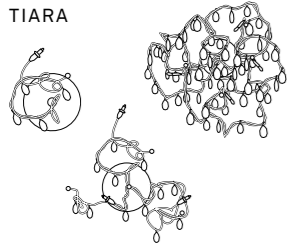
DESIGNS	TYPE	TECHN.	DIM. & FRAME	COLOR	HALO.	LED
	WL 5	5 x 12 V 10 W G 4	↑ 50 ↔ 30 cm	 GSW multicol. 2 4 5 7 8 9 10 15		
	WL 7	7 x 12 V 10 W G 4	↑ 70 ↔ 35 cm			
	WL 9	9 x 12 V 10 W G 4	↑ 120 ↔ 40 cm			
	WL 12	12 x 12 V 10 W G 4	↑ 120 ↔ 40 cm			
			↔ 25 cm			
			3 mm - inox			
	WL/PL 1	1 x 12 V 20 W G 4	∅ 20 ↔ 20 cm	 GSW multicol. 2 4 5 7 8 9 10 15		
	WL/PL 3	3 x 12 V 20 W G 4	∅ 30 ↔ 20 cm			
	WL/PL 5	5 x 12 V 10 W G 4	∅ 40 ↔ 25 cm			
	TL 3	3 x 12 V 20 W G 4	↑ 60 cm			
	TL 6	6 x 12 V 10 W G 4	↑ 80 cm			
	FL 9	9 x 12 V 10 W G 4	↑ 175 cm			
			3 mm - inox			
	WL/PL 1	1 x 12 V 35 W 111	∅ 15 cm			
	WL/PL 2	2 x 12 V 35 W 111	∅ 40 cm			
	WL/PL 3	3 x 12 V 35 W 111	∅ 60 cm			
	WL/PL 5	5 x 12 V 35 W 111	∅ 65 cm			

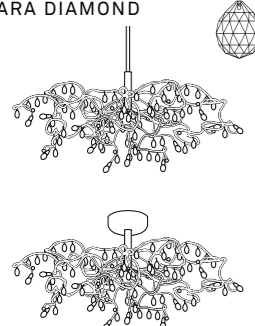
DESIGNS	TYPE	TECHN.	DIM. & FRAME	COLOR	HALO.	LED	
	HL 9	9 x 12 V 10 W G 4	∅ 50 ↓ ** cm	 GSW multicol. 2 4 5 7 8 9 10 15			
	HL 12	12 x 12 V 10 W G 4	∅ 60 ↓ ** cm				
	HL 15	15 x 12 V 10 W G 4	∅ 70 ↓ ** cm				
	HL 24	24 x 12 V 10 W G 4	∅ 120 ↓ ** cm				
	PL 9	9 x 12 V 10 W G 4	∅ 50 ↓ 20 cm				
	PL 12	12 x 12 V 10 W G 4	∅ 60 ↓ 25 cm				
	PL 15	15 x 12 V 10 W G 4	∅ 70 ↓ 35 cm				
	PL 24	24 x 12 V 10 W G 4	∅ 120 ↓ 35 cm				
							2 x 3 mm - inox
							multicol. transp.
	HL 12	12 x 12 V 10 W G 4	∅ 75 ↓ ** cm				
	HL 15	15 x 12 V 10 W G 4	∅ 85 ↓ ** cm				
	HL 24	24 x 12 V 10 W G 4	∅ 115 ↓ ** cm				
							2 x 3 mm - inox
			multicol. transp.				
	HL 30	30 x 12 V 5 W G 4	∅ 80 ↓ ** cm				
	HL 48	48 x 12 V 5 W G 4	∅ 95 ↓ ** cm				
							2 x 3 mm - inox
			multicol. transp.				
	HL 9	9 x 12 V 10 W G 4	∅ 80 x 35 cm				
	HL 12	12 x 12 V 10 W G 4	∅ 90 x 35 cm				
	HL 15	15 x 12 V 10 W G 4	∅ 120 x 40 cm				
	HL 24	24 x 12 V 10 W G 4	∅ 145 x 45 cm				
			↑ ** cm				
	PL 12	12 x 12 V 10 W G 4	∅ 90 X 35 cm				
	PL 15	15 x 12 V 10 W G 4	∅ 120 X 40 cm				
			↓ 35 cm				
			2 x 3 mm - inox				
			multicol. transp.				

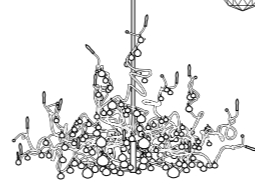
DESIGNS	TYPE	TECHN.	DIM. & FRAME	COLOR	HALO.	LED
TIARA KITE 	HL 12	12 x 12 V 10 W G 4	↔ 110 x 30 cm	multicol. transp.		
	HL 18	18 x 12 V 10 W G 4	↔ 140 x 40 cm			
	HL 30	30 x 12 V 5 W G 4	↔ 180 x 40 cm			
			‡ var. st. 200 cm			
			2 x 3 mm - inox			
TIARA 	WL/PL 1	1 x 12 V 20 W G 4	∅ 20 ↔ 20 cm	multicol. transp.		
	WL/PL 3	3 x 12 V 20 W G 4	∅ 30 ↔ 25 cm			
	WL/PL 5	5 x 12 V 10 W G 4	∅ 45 ↔ 25 cm			
			2 x 3 mm - inox			
TIARA LONG 	WL 5	5 x 12 V 10 W G 4	‡ 70 ↔ 35 cm	multicol. transp.		
	WL 9	9 x 12 V 10 W G 4	‡ 110 ↔ 35 cm			
			↔ 25 cm			
			2 x 3 mm - inox			
TIARA DIAMOND 	HL 9	9 x 12 V 10 W G 4	∅ 50 ‡ ** cm	transp.		
	HL 12	12 x 12 V 10 W G 4	∅ 60 ‡ ** cm			
	HL 15	15 x 12 V 10 W G 4	∅ 70 ‡ ** cm			
	HL 24	24 x 12 V 10 W G 4	∅ 120 ‡ ** cm			
	PL 9	9 x 12 V 10 W G 4	∅ 50 ‡ 20 cm			
	PL 12	12 x 12 V 10 W G 4	∅ 60 ‡ 25 cm			
	PL 15	15 x 12 V 10 W G 4	∅ 70 ‡ 35 cm			
	PL 24	24 x 12 V 10 W G 4	∅ 120 ‡ 35 cm			
			2 x 3 mm - inox			

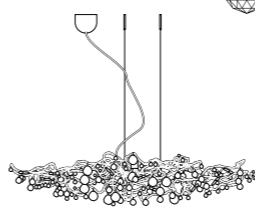
DESIGNS	TYPE	TECHN.	DIM. & FRAME	COLOR	HALO.	LED
TIARA DIAMOND CHANDELIER 	HL 12	12 x 12 V 10 W G 4	∅ 75 ‡ ** cm	transp.		
	HL 15	15 x 12 V 10 W G 4	∅ 95 ‡ ** cm			
	HL 24	24 x 12 V 10 W G 4	∅ 125 ‡ ** cm			
			2 x 3 mm - inox			
TIARA DIAMOND DOUBLE 	HL 30	30 x 12 V 5 W G 4	∅ 80 ‡ 105 cm	transp.		
	HL 48	48 x 12 V 5 W G 4	∅ 95 ‡ 120 cm			
			‡ ** cm			
			2 x 3 mm - inox			
TIARA DIAMOND OVAL 	HL 9	9 x 12 V 10 W G 4	∅ 80 x 35 cm	transp.		
	HL 12	12 x 12 V 10 W G 4	∅ 90 x 35 cm			
	HL 15	15 x 12 V 10 W G 4	∅ 120 x 40 cm			
	HL 24	24 x 12 V 10 W G 4	∅ 145 x 45 cm			
			‡ ** cm			
			2 x 3 mm - inox			
TIARA DIAMOND KITE 	HL 12	12 x 12 V 10 W G 4	↔ 110 x 30 cm	transp.		
	HL 18	18 x 12 V 10 W G 4	↔ 140 x 40 cm			
	HL 30	30 x 12 V 5 W G 4	↔ 180 x 40 cm			
			‡ var. st. 200 cm			
			2 x 3 mm - inox			

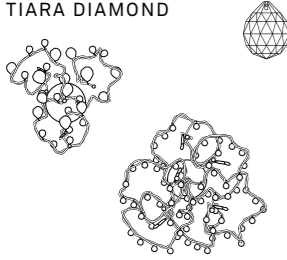
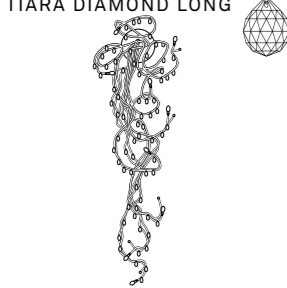
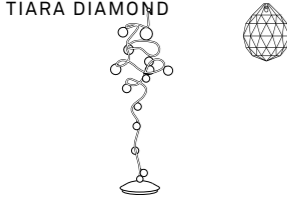
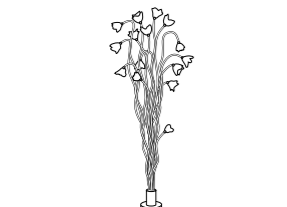
DESIGNS	TYPE	TECHN.	DIM. & FRAME	COLOR	HALO.	LED
TIARA DIAMOND 	WL/PL 1 WL/PL 3 WL/PL 5	1 x 12V 20 W G4 3 x 12V 20 W G4 5 x 12V 10 W G4	Ø 20 → 20 cm Ø 30 → 25 cm Ø 45 → 25 cm			
			2 x 3 mm - inox	transp.		
TIARA DIAMOND LONG 	WL 5 WL 9	5 x 12V 10 W G4 9 x 12V 10 W G4	† 70 ↔ 35 cm † 110 ↔ 35 cm → 25 cm			
			2 x 3 mm - inox	transp.		
TIARA DIAMOND 	TL 1	1 x 12V 20 W G4	† 55 cm			
			2 x 3 mm - inox	transp.		
TREE BREEZE 	FL 10 FL 15	10 x 12V 10 W G4 15 x 12V 10 W G4	† 175 cm † 195 cm			
			6 mm - inox	TRM		

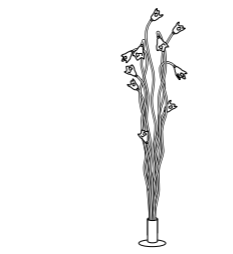
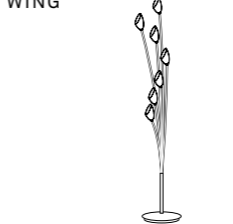
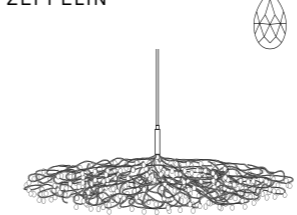
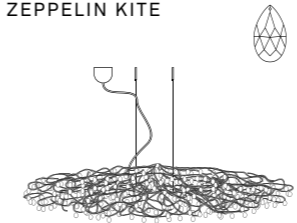
DESIGNS	TYPE	TECHN.	DIM. & FRAME	COLOR	HALO.	LED
TREE FLAG 	FL 10 FL 15	10 x 12V 10 W G4 15 x 12V 10 W G4	† 175 cm † 195 cm			
			6 mm - inox	GFL-2		
WING 	FL 7	7 x 12V 20 W G4	† 180 cm			
			6 mm - inox	GWI-1		
ZEPPELIN 	HL 12 HL 15	12 x 12V 10 W G4 15 x 12V 10 W G4	Ø 120 x 30 cm Ø 145 x 45 cm			
			2 x 3 mm - inox	multicol. transp.		
ZEPPELIN KITE 	HL 12 HL 18 HL 30 LED	12 x 12V 10 W G4 18 x 12V 10 W G4 30 x 12V 1 W G4	Ø 120 x 30 cm Ø 150 x 40 cm Ø 170 x 45 cm † var. st. 200 cm			
			2 x 3 mm - inox	multicol. transp.		

De in deze catalogus afgebeelde kleuren kunnen iets afwijken van de werkelijke kleuren van de verlichtingsarmaturen. Harco Loor Design B.V. behoudt zich het recht voor om haar eigen modellen zonder voorafgaande kennisgeving te wijzigen.

We reserve the right to technical or aesthetic modifications. Please allow for color discrepancies between the illustrations in this catalogue and the actual products. Harco Loor Design B.V. reserves the right to introduce any changes to its own models, without prior notice.

Technische und formale Änderungen vorbehalten. Die in diesem Katalog gedruckten Farben können von den tatsächlichen Farben der Lampen abweichen. Harco Loor Design B.V. behält sich das Recht vor Änderungen vorzunehmen, ohne sofortige Benachrichtigung.

Sous réserve de modifications techniques et de forme. Les couleurs imprimées dans ce catalogue peuvent varier des couleurs réelles des lampes. Harco Loor Design B.V. se réserve le droit d'apporter aux propres modèles, sans aucun préavis, n'importe quel modification qu'il retienne nécessaire.

Al onze designs worden in onze fabriek in Haarlem ontworpen en geproduceerd. Er worden uitsluitend kwalitatief hoogwaardige materialen als roestvaststaal en kristal gebruikt.

All our lighting fixtures are designed and manufactured in our own factory in Haarlem, the Netherlands. Only high quality materials, such as stainless steel and crystals are used.

Alle unsere Beleuchtungskörper werden in unserer Fabrik in Haarlem, Niederlande entworfen und hergestellt. Es wird ausschließlich hochwertiges Material, wie Edelstahl und Kristal, verwendet.

Tous nos appareils sont conçus et fabriqués dans notre usine à Haarlem aux Pays-Bas. Nous utilisons exclusivement des matériaux de grande qualité, comme inox et cristal.

Photography Pieter E. Kamp
Art Direction Pascal Hogerheijde

Edition May 2017
All rights reserved



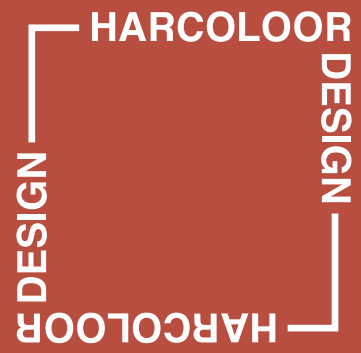

HARCOLOOR.COM