



# 1953-55 Ford F-100

Gen 5 Evaporator Kit  
(751633)



18865 Goll St. San Antonio, TX 78266  
Phone: 800-862-6658  
Sales: [sales@vintageair.com](mailto:sales@vintageair.com)  
Tech Support: [tech@vintageair.com](mailto:tech@vintageair.com)  
[www.vintageair.com](http://www.vintageair.com)



www.vintageair.com

# Table of Contents

|  |        |
|--|--------|
| Cover.....   | 1      |
| Table of Contents.....   | 2      |
| Packing List/Parts Disclaimer.....   | 3      |
| Information Page.....  | 4      |
| Wiring Notice.....   | 5      |
| Engine Compartment Disassembly, Condenser Assembly and Installation, Compressor and Brackets.....  | 6      |
| Passenger Compartment Disassembly, Defrost Duct Adapter Installation.....                          | 7      |
| Firewall Modification and Insulation.....  | 8-9    |
| Lubricating O-rings, Evaporator Preparation.....   | 10     |
| Evaporator Preparation (Cont.).....  | 11     |
| Evaporator Installation (Passenger Compartment), Evaporator Installation (Engine Compartment)..... | 12     |
| Evaporator Installation (Engine Compartment) (Cont.), Wiring.....                                  | 13     |
| Heater Hose & Heater Control Valve Installation.....   | 14 -15 |
| A/C Hose Installation, Passenger Compartment Wiring.....   | 16     |
| Engine Compartment Wiring.....   | 17     |
| Louver Housing Installation.....   | 18     |
| Control Panel Installation.....  | 19     |
| Control Panel & Duct Hose Routing.....   | 20     |
| Drain Hose Installation.....   | 21     |
| Final Steps: Installation Check.....   | 22     |
| Glove Box Installation.....  | 23     |
| Final Steps: Completing the Install.....   | 24     |
| Quality Crimp Guideline.....   | 25-26  |
| Gen 5 Wiring Diagram, Gen 5 Wiring Connection Instruction.....                                     | 27     |
| Operation of Controls.....   | 28-29  |
| Troubleshooting Guide, Advanced Diagnostics and Troubleshooting Guide.....                         | 30     |
| Packing List.....  | 31     |

## Additional Parts & Accessories

- For proper fit and finish of the under dash louvers, Vintage Air recommends the installation of kick panels. In case of damaged or missing kick panels, Vintage Air offers the SureFit powder-coated replacement panels below.

**644197**

Passenger-Side Kick Panel

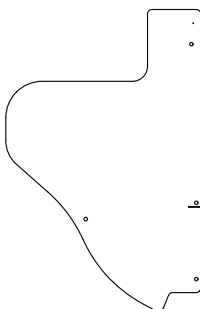

**644198**

Driver-Side Kick Panel

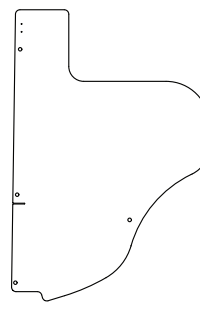



www.vintageair.com

## Packing List: Evaporator Kit (751633)

| No. | Qty. | Part No. | Description                                 |
|-----|------|----------|---|
| 1.  | 1    | 765125   | Gen 5 Magnum Evaporator Module with 444 ECU |
| 2.  | 1    | 791633   | Accessory Kit                               |

**\*\* Before beginning installation, open all packages and check contents of shipment. Please report any shortages directly to Vintage Air within 15 days. After 15 days, Vintage Air will not be responsible for missing or damaged items.**

1

Gen 5 Magnum Evaporator  
Module with 444 ECU  
765125



2

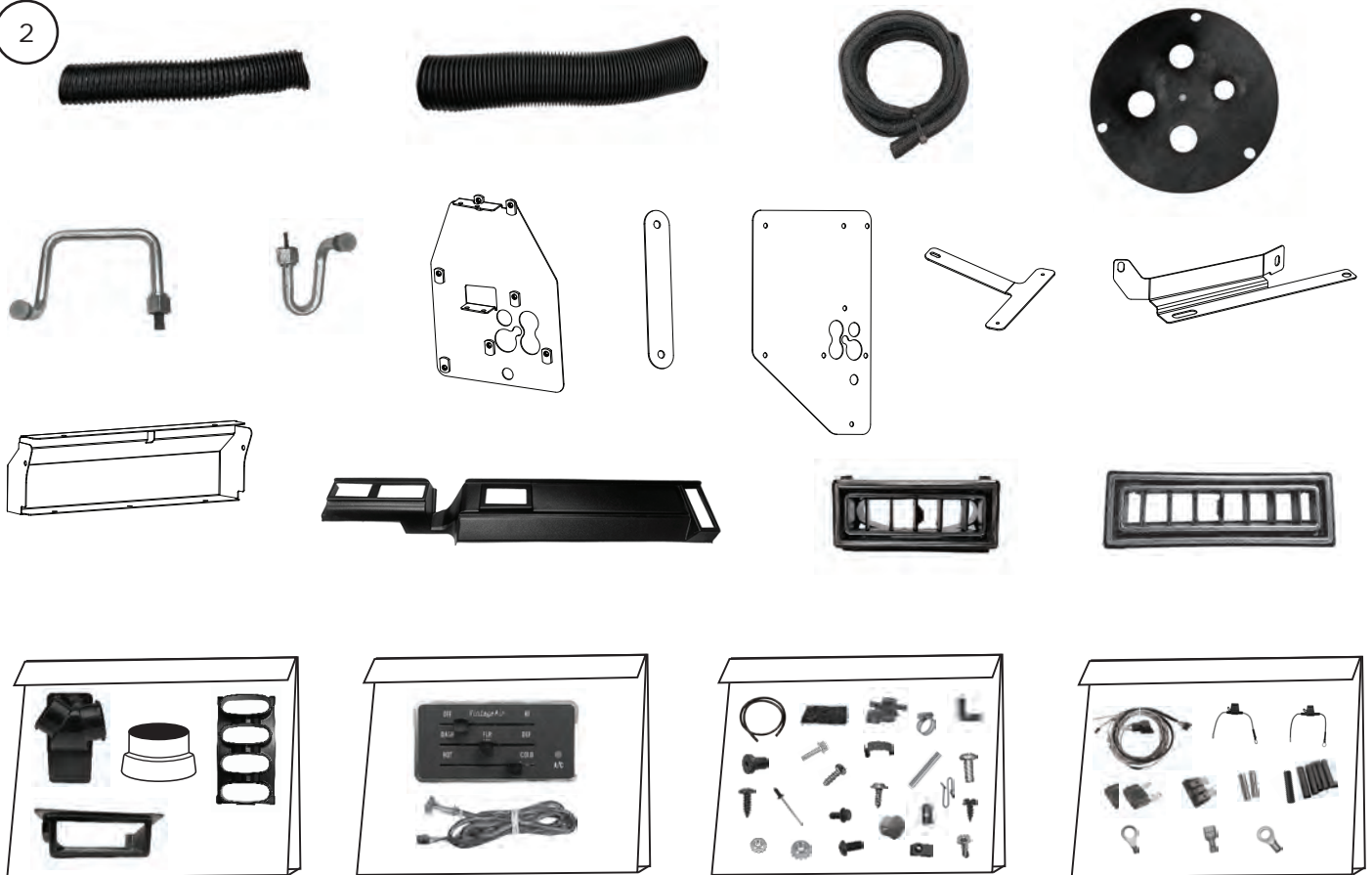

Accessory Kit  
791633

**NOTE: Images may not depict actual parts and quantities. Refer to packing list for actual parts and quantities.**



www.vintageair.com

## Important Notice—Please Read

*For Maximum System Performance, Vintage Air Recommends the Following:*

**NOTE:** Vintage Air systems are designed to operate with R134a refrigerant only. Use of any other refrigerant could damage your A/C system and/or vehicle, and possibly cause a fire, in addition to potentially voiding the warranties of the A/C system and its components.

### Refrigerant Capacities:

**Vintage Air System:** 1.8 lbs. (28.8 oz.) or 816 grams of **R134a**, charged by weight with a quality charging station or scale. **NOTE: Use of the proper type and amount of refrigerant is critical to system operation and performance.**

**Other Systems:** Consult manufacturer's guidelines.

### Lubricant Capacities:

**New Vintage Air-Supplied Sanden Compressor:** No additional oil needed (Compressor is shipped with proper oil charge).

**All Other Compressors:** Consult manufacturer (Some compressors are shipped dry and will need oil added).

### Safety Switches

Your Vintage Air system is equipped with a binary pressure safety switch. A binary switch disengages the compressor clutch in cases of extreme low pressure conditions (refrigerant loss) or excessively high head pressure (406 PSI) to prevent compressor damage or hose rupture. A trinary switch combines Hi/Lo pressure protection with an electric fan operation signal at 254 PSI, and should be substituted for use with electric fans. Compressor safety switches are extremely important since an A/C system relies on refrigerant to circulate lubricant.

### Service Info:

**Protect Your Investment:** Prior to assembly, it is critical that the compressor, evaporator, A/C hoses and fittings, hardlines, condenser and receiver/drier remain capped. Removing caps prior to assembly will allow moisture, insects and debris into the components, possibly leading to reduced performance and/or premature failure of your A/C system. This is especially important with the receiver/drier.

Additionally, when caps are removed for assembly, **BE CAREFUL!** Some components are shipped under pressure with dry nitrogen.

**Evacuate the System for 35-45 Minutes:** Ensure that system components (Drier, compressor, evaporator and condenser) are at a temperature of at least 85°F. On a cool day, the components can be heated with a heat gun **or** by running the engine with the heater on before evacuating. Leak check and charge to specifications.

### Bolts Passing Through Cowl and/or Firewall:

To ensure a watertight seal between the passenger compartment and the vehicle exterior, for all bolts passing through the cowl and/or firewall, Vintage Air recommends coating the threads with silicone prior to installation.

### Heater Hose (not included with this kit):

Heater hose may be purchased from Vintage Air (Part#31800-VUD) or your local parts retailer. Routing and required length will vary based on installer preference.



www.vintageair.com

## Important Wiring Notice—Please Read

*Some vehicles may have had some or all of their radio interference capacitors removed. There should be a capacitor found at each of the following locations:*

- 1. On the positive terminal of the ignition coil.**
- 2. If there is a generator, on the armature terminal of the generator.**
- 3. If there is a generator, on the battery terminal of the voltage regulator.**

Most alternators have a capacitor installed internally to eliminate what is called “whining” as the engine is revved. If whining is heard in the radio, or just to be extra cautious, a radio interference capacitor can be added to the battery terminal of the alternator.

It is also important that the battery lead is in good shape and that the ground leads are not compromised. There should be a heavy ground from the battery to the engine block, and additional grounds to the body and chassis.

If these precautions are not observed, it is possible for voltage spikes to be present on the battery leads. These spikes come from ignition systems and charging systems, and from switching some of the vehicle’s other systems on and off. Modern computer-operated equipment can be sensitive to voltage spikes on the power leads, which can cause unexpected resets, strange behavior and/or permanent damage.

Vintage Air strives to harden our products against these types of electrical noise, but there is a point where a vehicle’s electrical system can be degraded so much that nothing can help.

Radio interference capacitors should be available at most auto and truck parts suppliers. They typically are cylindrical in shape, a little over an inch long and a little over a half-inch in diameter, and they have a single lead coming from one end of the cylinder with a terminal on the end of the wire, as well as a mounting clip which is screwed into a good ground on the vehicle. The specific value of the capacitance is not too significant in comparison to ignition capacitors that are matched with the coil to reduce pitting of the points.

- Care must be taken, when installing the compressor lead, not to short it to ground. The compressor lead must not be connected to a condenser fan or to any other auxiliary device. Shorting to ground or connecting to a condenser fan or any other auxiliary device may damage wiring or the compressor relay, and/or cause a malfunction.
- When installing ground leads on Gen 5 systems, the blower control ground and ECU ground must be connected directly to the negative battery post.
- For proper system operation, the heater control valve must be connected to the ECU.



www.vintageair.com

## Engine Compartment Disassembly

**NOTE:** Before starting the installation, check the function of the vehicle (horn, lights, etc.) for proper operation, and study the instructions, illustrations, photos & diagrams.

### Perform the Following:

1. Disconnect the battery.
2. Drain the radiator.
3. Remove OEM heater hoses.
4. Remove the (2) screws that hold the horn relay to the firewall (if equipped) (See Photo 1, below), and secure the wires out of the way.
5. Remove all factory heater components.
6. If equipped, remove any dealer or aftermarket A/C systems.

Remove (2) screws that hold horn relay to firewall

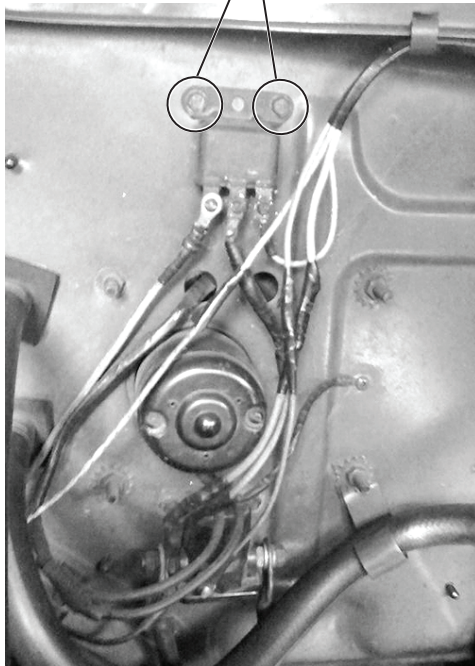

Photo 1

## Condenser Assembly and Installation

1. Refer to separate instructions included with the condenser kit to install the condenser.
2. Binary switch installation (Refer to condenser instructions).

## Compressor and Brackets

1. Refer to separate instructions included with the bracket kit to install the compressor bracket.



www.vintageair.com

## Passenger Compartment Disassembly

### Perform the Following:

1. Remove the OEM glove box by removing the screws (See Photo 1, below).
2. Remove the glove box door by removing the (4) OEM screws from the door (See Photo 1, below).
3. Remove the glove box hinges (retain springs for hinges).
4. Remove the OEM heater box (if equipped).
5. Locate the small hole under the glove box door, approximately 10" from the large hole (See Photo 2, below). Drill the small hole out to 5/16".

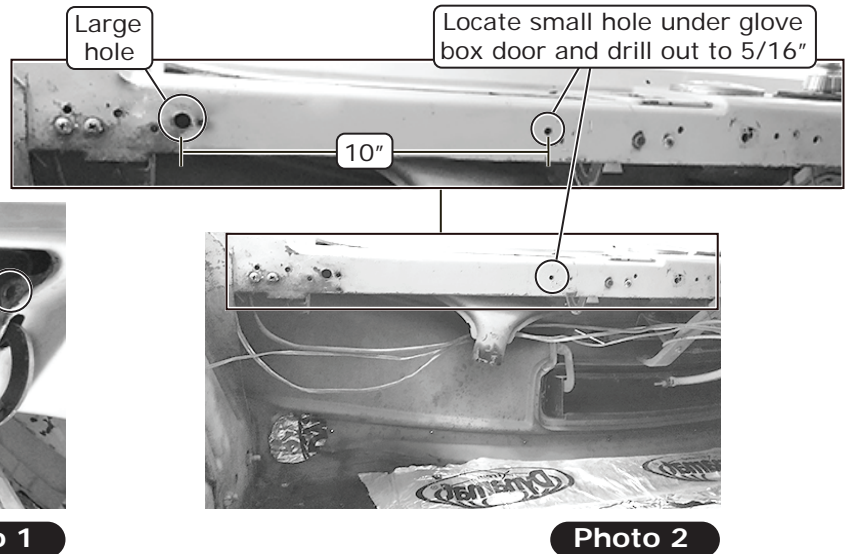
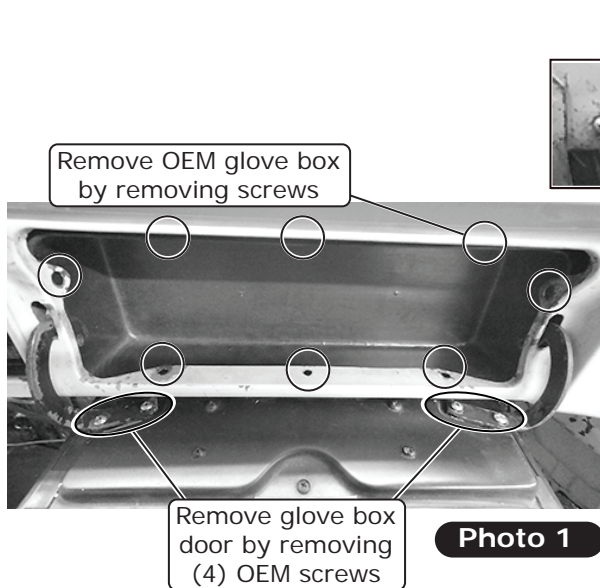

## Defrost Duct Adapter Installation

1. Install (6) S-clips ((3) per adapter) onto the defrost duct adapters.
2. Install the defrost duct adapters onto the OEM defrost ducts (See Figure 1, below).

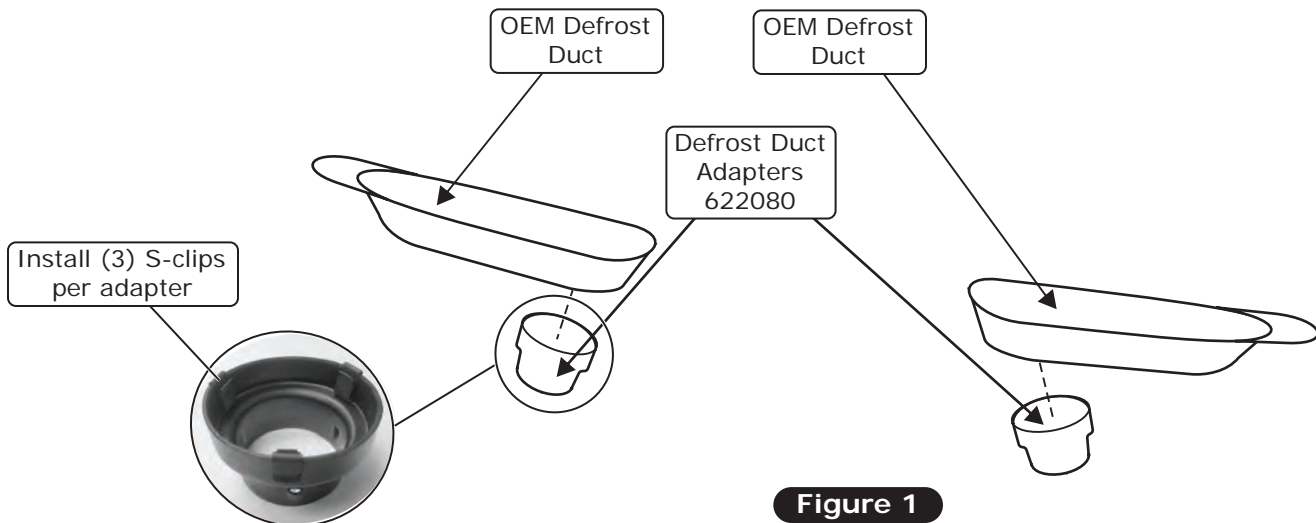



www.vintageair.com

## Firewall Modification and Insulation

**NOTE:** The firewall requires modification for the drain hose to be installed. For proper system operation, Vintage Air recommends using Dynaliner #461500-VIP heat-blocking insulation in the area around the evaporator module (firewall, kick panel, inner cowl, firewall covers). Due to tight clearance for the evaporator module between the firewall and dash, Vintage Air recommends an insulation thickness of no more than 1/8".

Perform the following:

1. Drill out the (2) top-right holes on firewall to 9/32" (See Photo 1, below).
2. Mount the firewall cover plate onto the firewall using (2) 1/4-20 x 1/2" flange head bolts and (2) 1/4-20 nuts with star washers into the (2) top-right firewall holes (See Photo 2, below). **NOTE: Ensure the holes for the hoses are centered on the existing 3 1/2" hole.**
3. Match drill (6) 9/32" firewall cover mounting holes (See Photo 3, below).
4. Drill the 5/8" drain hole through the firewall (See Photo 3, below). **NOTE: To ensure a tight fit, do not enlarge the hole to more than 5/8".**

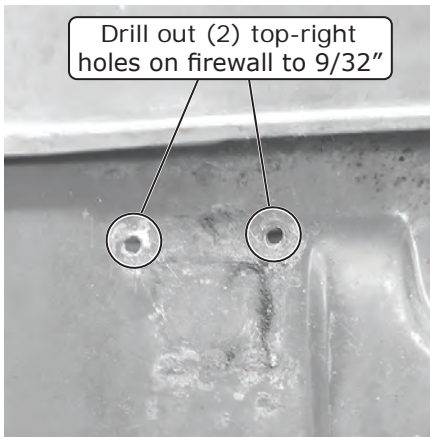

Photo 1

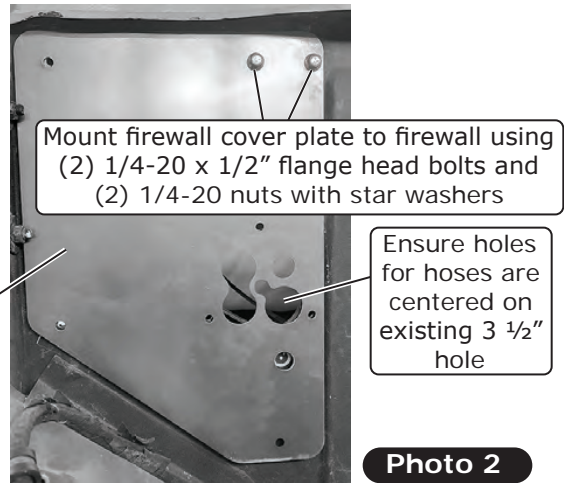

Photo 2

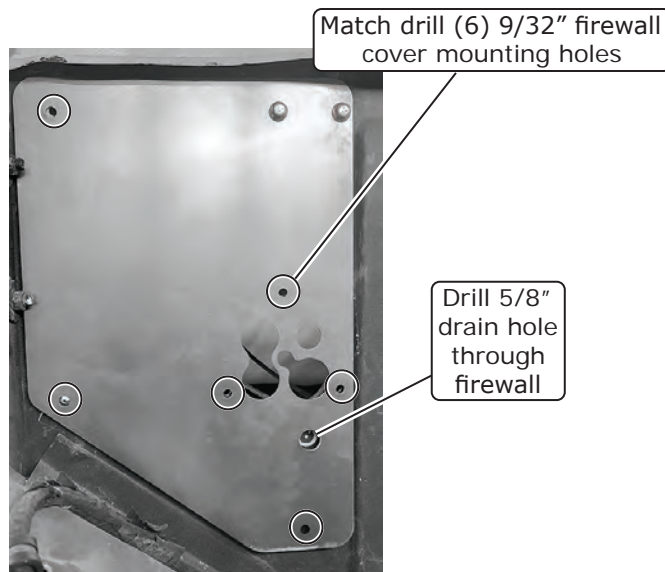

Photo 3



www.vintageair.com

## Firewall Modification and Insulation (Cont.)

5. Remove the firewall cover plate, and install (3) 1/4-20 x 1/2" hex flange head bolts onto it using 1/4" pushnut bolt retainers as shown in Photo 4, below.
6. Apply silicone to the mating surface of the firewall cover plate, and install (See Photo 5, below).
7. Secure the firewall cover plate using (3) 1/4-20 nuts with star washers from inside the passenger compartment as shown in Photo 6, below.

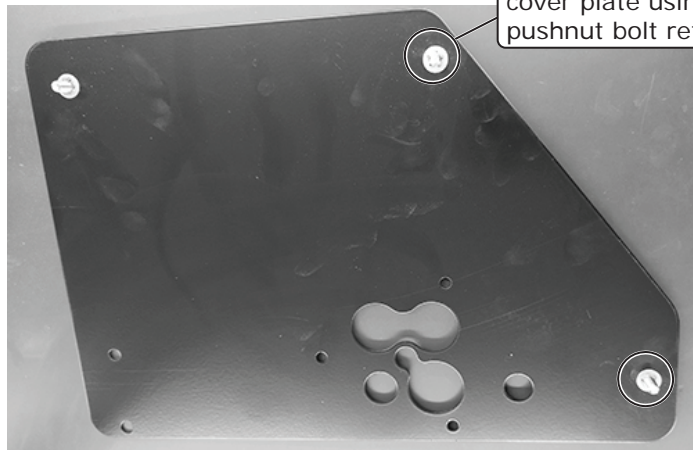

Photo 4



Photo 5

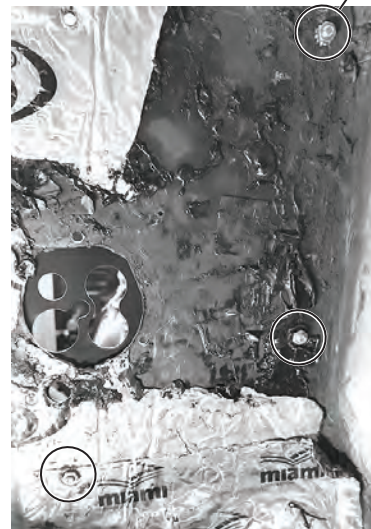
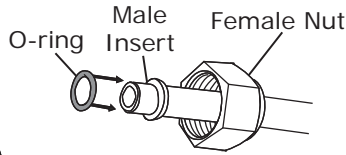
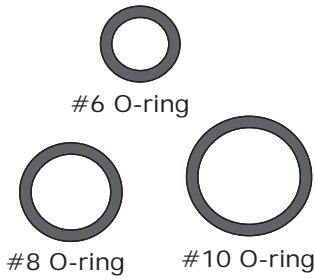

Photo 6



www.vintageair.com

## Lubricating O-rings



For a proper seal of fittings: Install supplied O-rings as shown and lubricate with refrigerant oil.

NOTE: Standard torque specifications:  
 #6: 11 to 13 ft-lb.  
 #8: 15 to 20 ft-lb.  
 #10: 21 to 27 ft-lb.

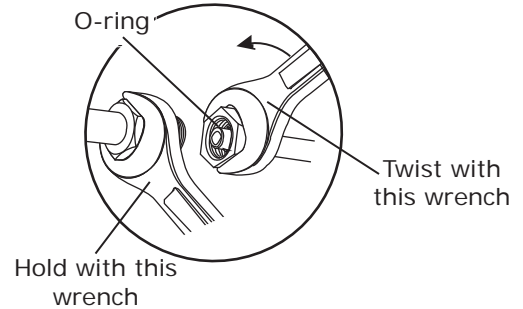
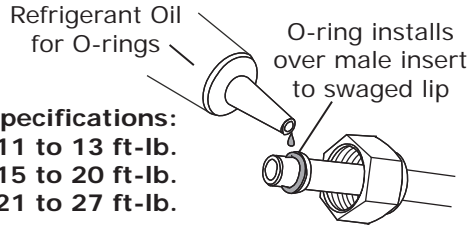

## Evaporator Preparation

Perform the following on a workbench:

1. Install (3) 1/2" plastic plugs into the back of the evaporator module (See Photo 1, below). **NOTE: These mounting provisions will not be used in this application.**
2. Using (4) spring clips, install the dash plenum as shown in Photo 2, below.
3. Using (2) spring clips, install the dual-opening plenum, pointing down, onto the front of the evaporator module for the floor mode as shown in Photo 3, below.
4. Using (2) spring clips, install the remaining dual-opening plenum, pointing up, onto the rear of the evaporator module for the defrost mode as shown in Photo 4, below.
5. Install the heater hardlines onto the evaporator module with properly lubricated O-rings as shown in Lubricating O-rings, above and in Photo 5, below. Leave hand tight.
6. Temporarily place the evaporator firewall assembly onto the evaporator module, and adjust the hardlines until centered in the holes (See Photo 6, below).

Install (3) 1/2" plastic plugs into back of evaporator module



Photo 1

Using (4) spring clips, install dash plenum

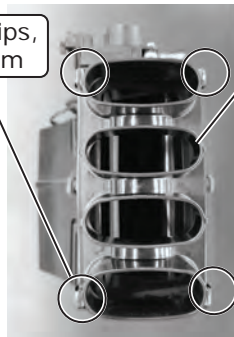

Photo 2

Dash Plenum 625330

Dual-Opening Plenum 625331

Using (2) spring clips, install plenum

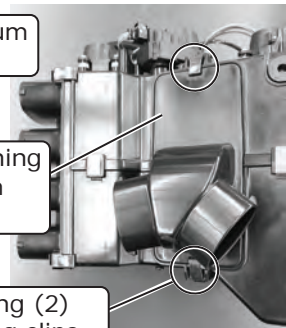

Photo 3

Using (2) spring clips, install plenum

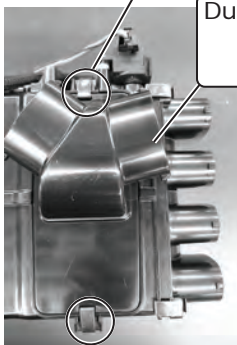

Photo 4

Dual-Opening Plenum 625331

Install heater hardlines onto evaporator module



Photo 5

Temporarily place evaporator firewall assembly (640040) onto evaporator module

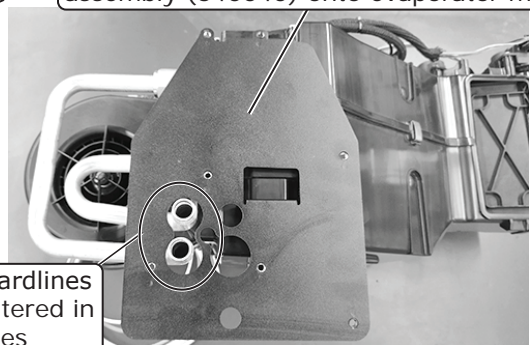

Photo 6

Adjust hardlines until centered in holes



www.vintageair.com

## Evaporator Preparation (Cont.)

7. Remove the evaporator firewall assembly and tighten the hardlines using a backup wrench (See Lubricating O-rings, Page 10).
8. Install the evaporator firewall assembly onto the module using (4) #10 x 5/8" screws (See Photos 7 and 8, below).
9. Install (2) 1/4-20 x 1 1/2" full-threaded studs into the evaporator firewall assembly as shown in Photo 9, below.
10. Install the rubber boot onto the firewall side of bracket, over the mounting studs and hardlines (See Photo 10, below).
11. Install (2) 1/4-20 well nuts into the holes on the front of the module as shown in Photo 11, below.
12. Install (2) 1/4-20 U-nuts onto the evaporator dash bracket as shown in Photo 12, below.

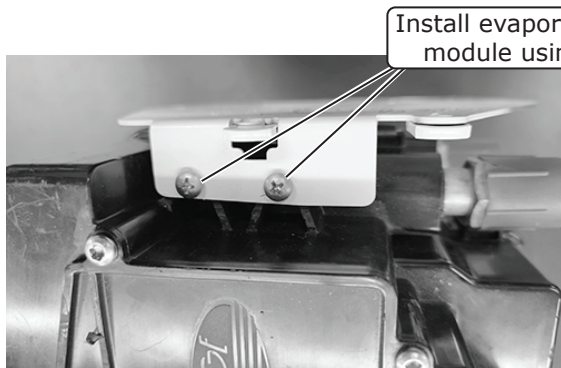

Top View

Photo 7

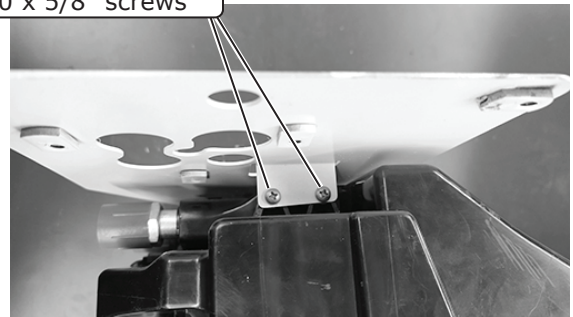

Bottom View

Photo 8

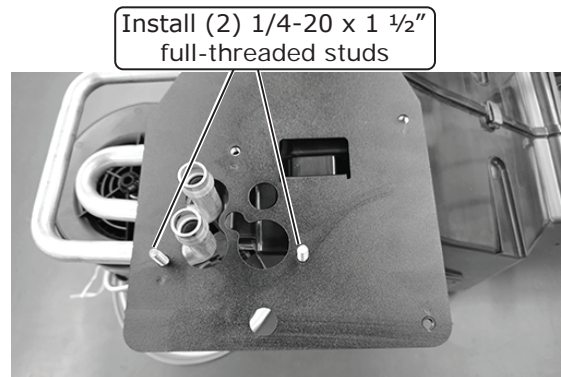

Photo 9

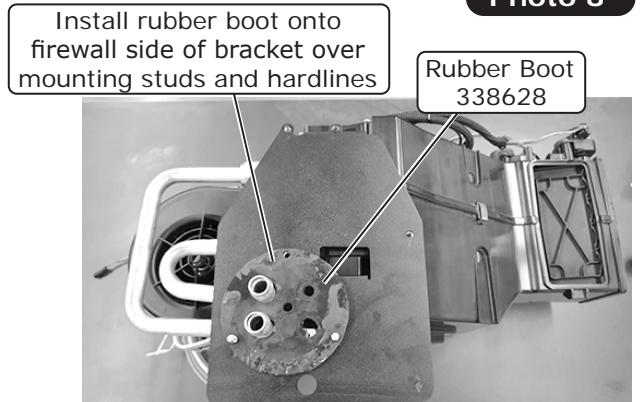

Photo 10

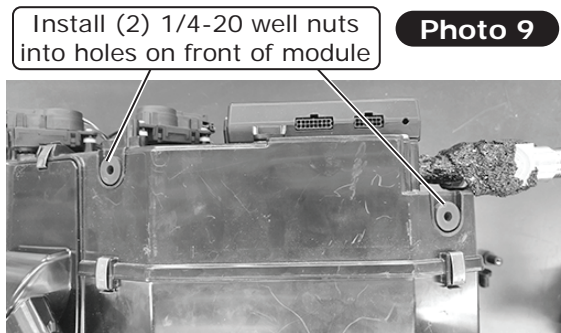
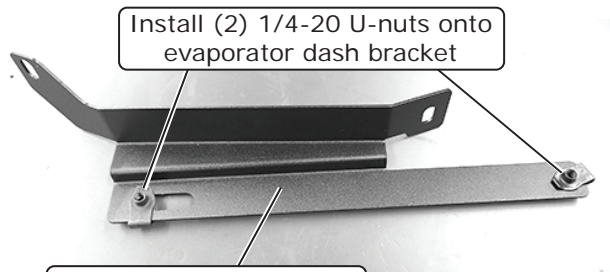

Photo 11



Evaporator Dash Bracket 640045

Photo 12



www.vintageair.com

## Evaporator Installation (Passenger Compartment)

1. Raise the evaporator module into position, then using the (2) 1/4-20 x 1 1/2" full-threaded studs, locate the mounting holes on the firewall (See Photo 1, below).
2. Place the evaporator dash bracket into the channel of the glove box rail, and secure it to the evaporator using (2) 1/4-20 x 1" serrated flange bolts as shown in Photo 2, below. Loosely install (2) 1/4-20 x 1/2" button head screws through the dash and into the evaporator dash bracket (See Photo 2, below).

Use (2) 1/4-20 x 1 1/2" full-threaded studs to locate mounting holes on firewall

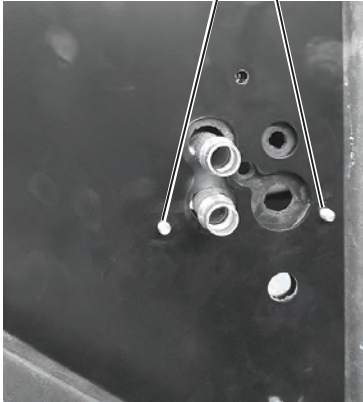
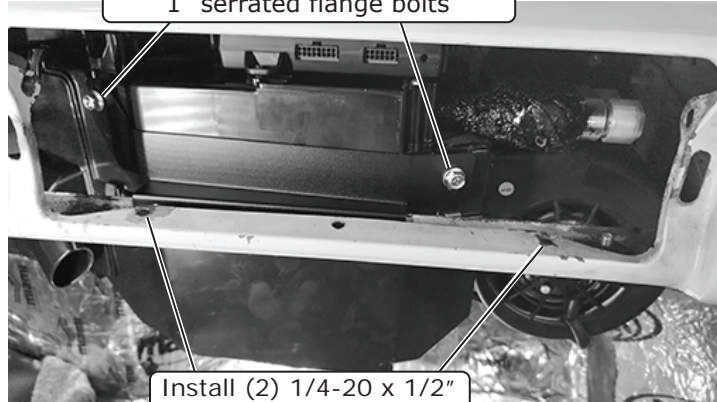

Photo 1

Secure evaporator dash bracket to evaporator using (2) 1/4-20 x 1" serrated flange bolts



Install (2) 1/4-20 x 1/2" button head screws

Photo 2

## Evaporator Installation (Engine Compartment)

1. From the engine bay, secure the top-right corner of the firewall cover plate to the evaporator firewall assembly using (2) 1/4-20 x 1/2" hex flange head bolts (See Photo 1, below). **NOTE: Reinstall the horn relay at this time using new bolts (if equipped).**
2. Install the 1/4-20 x 1/2" hex flange head bolt into the unused hole above the hose opening (See Photo 2, below).

Secure top right corner firewall cover plate using (2) 1/4-20 x 1/2" hex flange head bolts

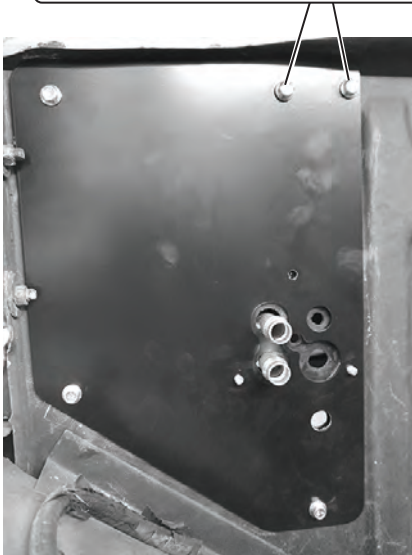

Photo 1

Install 1/4-20 x 1/2" hex flange head bolt into unused hole above hose opening

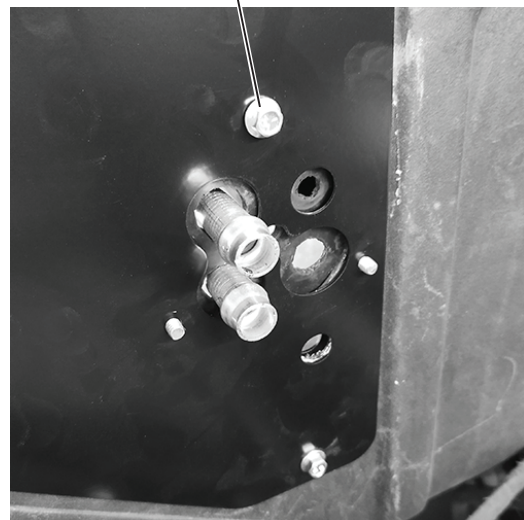

Photo 2



www.vintageair.com

## Evaporator Installation (Engine Compartment) (Cont.)

3. Remove the studs one at a time from the firewall, and replace them with 1/4-20 x 1/2" hex flange head bolts (See Photo 3, below).
4. Install the small firewall cover onto the firewall and secure it to the evaporator firewall assembly using (2) 1/4-20 x 1/2" hex flange head bolts (See Photo 4, below).
5. Tighten all (10) bolts on both the firewall cover plate and the small firewall cover.

Replace studs with 1/4-20 x 1/2" hex flange head bolts

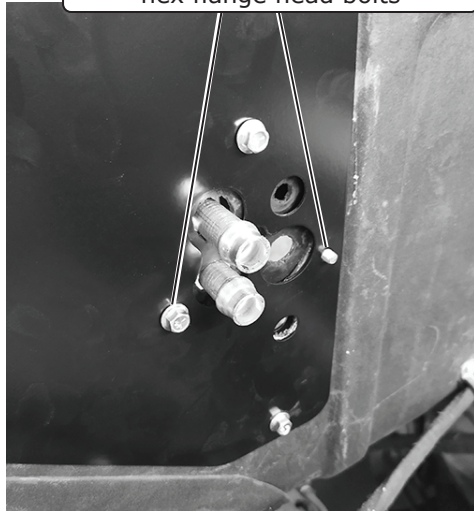
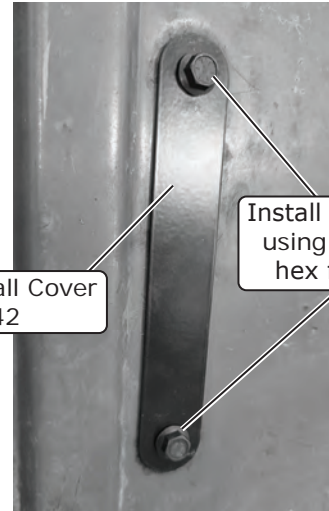

Photo 3



Small Firewall Cover  
640042

Install small firewall cover using (2) 1/4-20 x 1/2" hex flange head bolts

Photo 4

## Wiring

1. Locate the heater control valve plug on the main wiring harness (white/yellow/purple). Route it through the wiring opening on the rubber boot and into the engine compartment (See Photo 1, below).
2. Route the red, white and blue wires from the main wiring harness through the wiring opening on the rubber boot and into the engine compartment (See Photo 2, below).
3. Route the blower power and ground wires (orange/white) through the wiring opening on the rubber boot and into the engine compartment (See Photo 3, below). **NOTE: Leave enough wiring between the firewall to mount the main relay in a desired location.**

Route heater control valve plug on main wiring harness (white/yellow/purple) through wiring opening on rubber boot and into engine compartment



Photo 1

Route red, white and blue wires from main wiring harness through wiring opening on rubber boot and into engine compartment

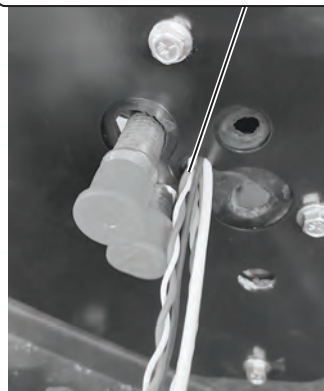

Photo 2

Route blower power and ground wires (orange/white) through wiring opening on rubber boot and into engine compartment

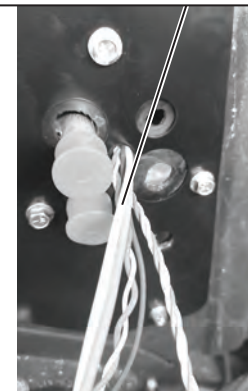

Photo 3



www.vintageair.com

# Heater Hose & Heater Control Valve Installation

**NOTE: Vintage Air systems use 5/8" heater connections. On engines equipped with 3/4" hose nipples, these will need to be removed and replaced with 5/8" nipples (not supplied). For water pumps with a cast-in 3/4" heater outlet, a 3/4" x 5/8" reducer fitting (not supplied) or molded hose will need to be installed in the heater hose.**

1. Route a length of heater hose (not included) from the lower heater hardline to the water pump fitting (See Photo 1, below). Secure it using (2) hose clamps.
2. Cut a length of heater hose (not included) approximately 9" from the firewall cover (See Photo 1, below), then install it onto the upper heater hardline. Secure it using the supplied hose clamp. **NOTE: When installing hose onto the hardline, ensure the hose penetrates the rubber boot for a proper seal.**
3. Install the heater control valve and secure it with (2) hose clamps (See Photo 1, below). **NOTE: Ensure proper flow direction through the heater control valve. The flow direction follows the molded arrow on the valve (See Figure 1, below).**
4. Install another length of heater hose (not included) from the heater control valve to the intake. Secure it with (2) hose clamps (See Photo 1, below).
5. Plug the heater control valve connector from the main harness into the heater control valve connector wiring harness (See Photo 1, below).

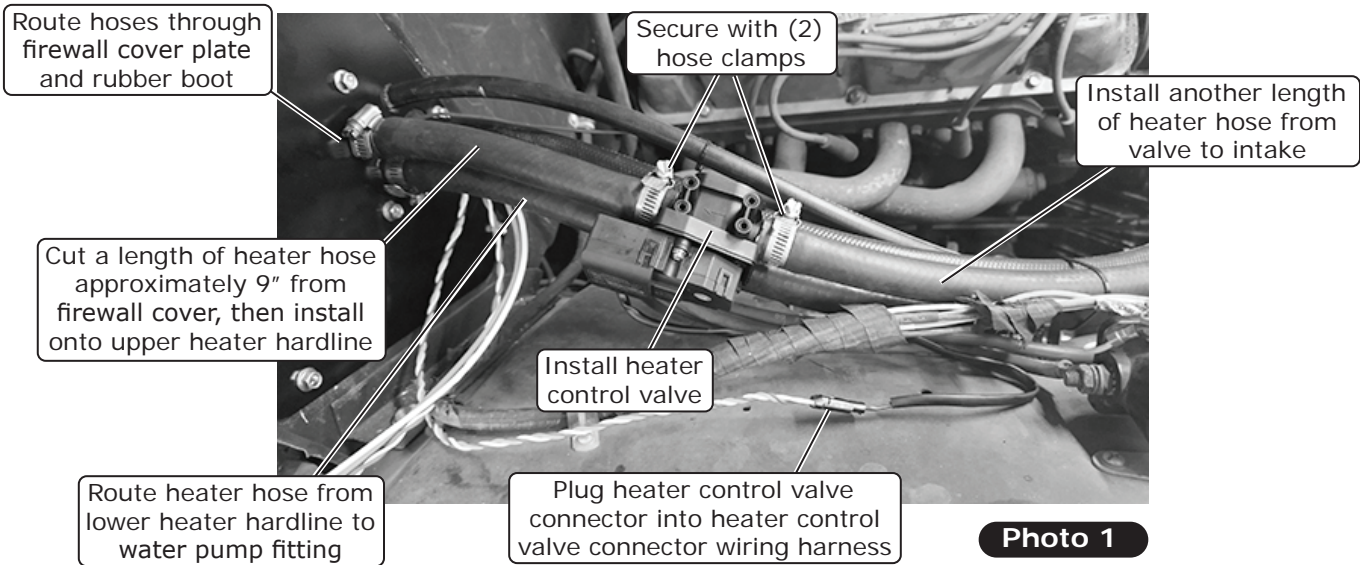

**Photo 1**

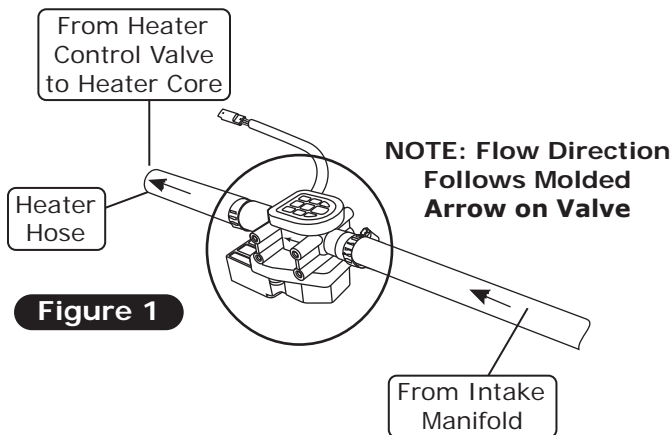

**Figure 1**



www.vintageair.com

## A/C Hose Installation

**NOTE: Use a backup wrench when tightening the A/C hose fittings. Be sure to apply oil to O-rings and threads (See Lubricating O-rings, Page 10). Reference Modified Hose Kit Installation Information for crimping instructions. When installing the A/C hose fittings to the expansion valve, do not install the fitting pointing straight down towards the blower motor, as this may cause the O-ring land of the hose to seat improperly (See Photo 1, below) and leak. To properly install the fittings, slide the A/C hose nut back to expose the O-ring land, then angle the fitting toward the firewall to fully seat it inside the expansion valve fitting (See Photo 2, below).**

1. Connect the #6 A/C hose 45° fitting onto the block valve adapter with a properly lubricated O-ring, and tighten (See Photo 3, below).
2. Route the straight fitting of the #6 A/C hose around the unit, and feed the hose through the firewall, rubber boot and into the engine compartment as shown in Photo 4, below.
3. Connect the #10 A/C hose 90° fitting onto the block valve adapter with a properly lubricated O-ring and tighten (See Photo 5, below).
4. Wrap all exposed metal at block fitting with press tape (See Photo 6, below).
5. Route the #10 A/C hose under the module as shown in Photo 7 below, and feed it through the firewall and rubber boot.
6. From the firewall, continue routing the #6 A/C hose along the heater hoses and toward the drier. Connect the straight fitting with a properly lubricated O-ring to the drier (See Photo 8, below).

### Improperly Seated O-ring Land

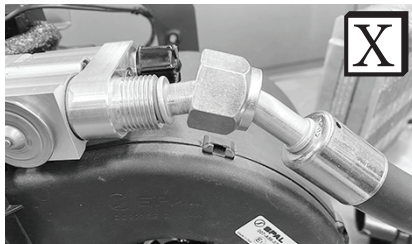

Photo 1

Feed #6 A/C hose through firewall, rubber boot and into engine compartment

### Properly Seated O-ring Land

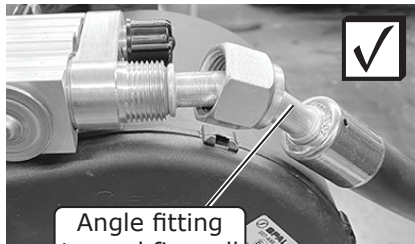

Photo 2

Angle fitting toward firewall

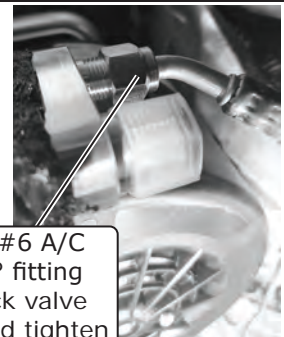

Photo 3

Connect #6 A/C hose 45° fitting onto block valve adapter and tighten



Photo 4



Photo 5

Connect #10 A/C hose 90° fitting onto block valve adapter and tighten

Wrap all exposed metal at block fitting with press tape

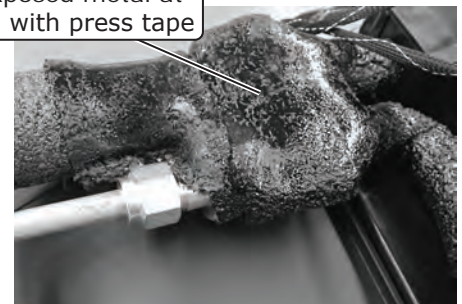

Photo 6

Route #10 A/C hose under module and feed through firewall and rubber boot



Photo 7

Connect #6 A/C hose straight fitting to drier

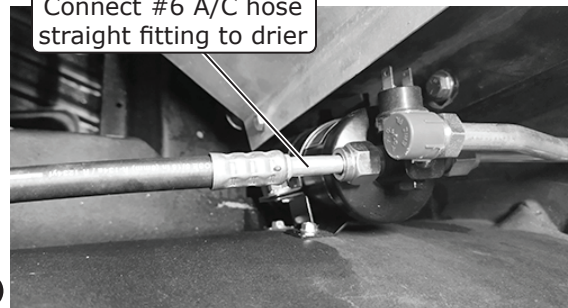

Photo 8



www.vintageair.com

## A/C Hose Installation (Cont.)

7. Connect the straight fitting from the #8 A/C hose to the #8 condenser hardline with a properly lubricated O-ring (See Lubricating O-rings, Page 10 and Photo 9, below).
8. Secure the lower heater hose to the fender well using the supplied Adel clamp. Secure the other hoses together using tie wraps (See Photo 9, below).
9. Secure the #6 and #8 A/C hoses to each other with Adel clamps near the drier as shown in Photo 10, below.
10. Use the modified A/C hose crimping instructions to complete the installation at the compressor.

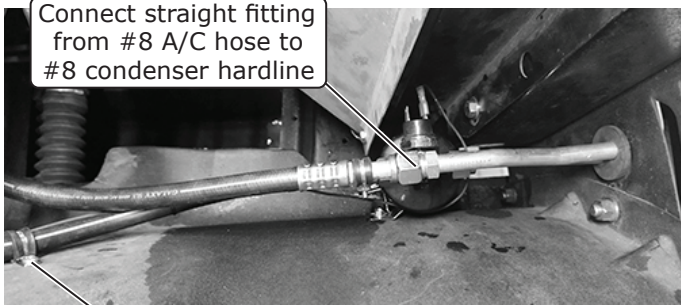

Connect straight fitting from #8 A/C hose to #8 condenser hardline

Secure lower heater hose to fender well using supplied Adel clamp

Photo 9

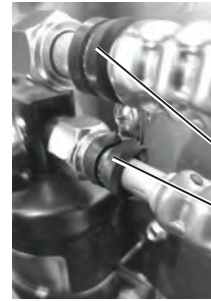

Secure #6 and #8 A/C hoses to each other with Adel clamps near drier

Photo 10

## Passenger Compartment Wiring

1. Select a suitable location for the main relay, then secure it using a #10 x 1/2" sheet metal screw (See Photo 1, below). Select a suitable ground location for the white ground wire eyelet from the heater control valve harness, then secure it using a #12 x 1/2" self-tapping screw (See Photo 1, below).
2. Route the violet power wire to a switched 12v power source on the fuse panel. **NOTE: This requires a male fuse extension (not supplied).**
3. Connect the tan wire to the factory dash lights to enable control panel backlighting (if applicable).
4. Connect the BSC wiring to the main harness (See Photo 2, below).
5. Connect the main harness to the ECU (See Photo 3, below).

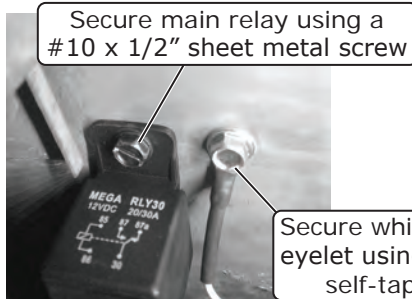

Secure main relay using a #10 x 1/2" sheet metal screw

Secure white ground wire eyelet using a #12 x 1/2" self-tapping screw

Photo 1



Connect BSC wiring to main harness

Photo 2

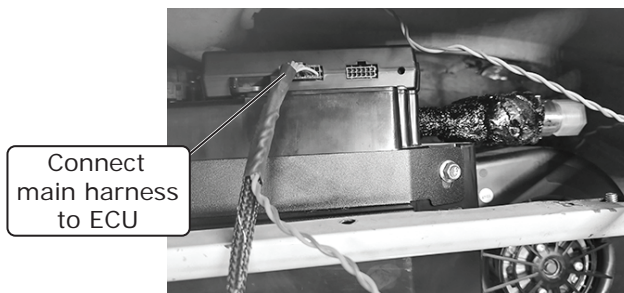

Connect main harness to ECU

Photo 3



www.vintageair.com

# Engine Compartment Wiring

1. Route the power and ground wires toward the battery.
2. Install the supplied heat shrink over the 16 AWG black fuse holder assembly wire, and crimp it to the 16 AWG red wire from the main wiring harness (See Photo 1, below and Quality Crimp Guidelines, Page 25).
3. Install the supplied heat shrink over the 12 AWG orange fuse holder assembly wire, and crimp it to the 12 AWG orange wire from the main wiring harness (See Photo 2, below and Quality Crimp Guidelines, Page 25).
4. Install fuses into the holders (See Photo 2, below).
5. Install the supplied heat shrink over the white ground wires, then crimp on the supplied eyelets (See Photo 3, below and Quality Crimp Guidelines, Page 25).
6. Connect the ground wiring eyelets to the negative battery terminal connector (See Photo 3, below).
7. Connect the positive wiring eyelets to the positive battery terminal connector (See Photo 4, below).
- NOTE: Do not connect power until installation is completed.**
8. Route the blue safety switch wire along the #6 A/C hose to the drier. Crimp the supplied female connector onto the blue wire and connect it to the binary safety switch (See Photo 5, below and Quality Crimp Guidelines, Page 25).
9. Connect the bullet connector of the compressor to the compressor lead.
10. Route the compressor lead along the #8 A/C hose toward the drier, then connect the female connector to the binary safety switch (See Photo 6, below).
11. Wrap all wiring with supplied split sleeve.

Install supplied heat shrink over 16 AWG black fuse holder assembly wire, and crimp to 16 AWG red wire from main wiring harness

Install supplied heat shrink over 12 AWG orange fuse holder assembly wire, and crimp to 12 AWG orange wire from main wiring harness

Install supplied heat shrink over white ground wires



Photo 1

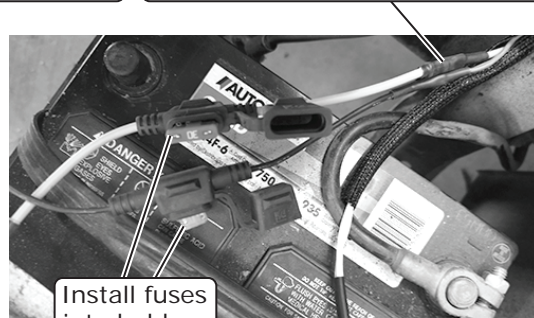

Install fuses into holders

Photo 2



Connect ground wiring eyelets to negative battery terminal connector

Photo 3

Connect positive wiring eyelets to positive battery terminal connector

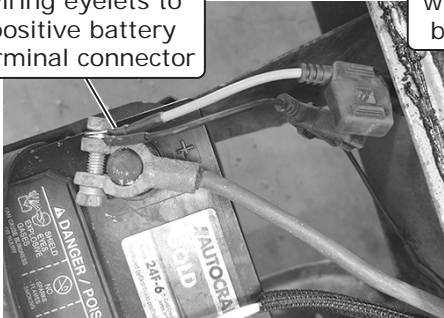

Photo 4

**NOTE: Do not connect power until installation is completed.**

Crimp supplied female connector onto blue wire, then connect to binary safety switch



Photo 5

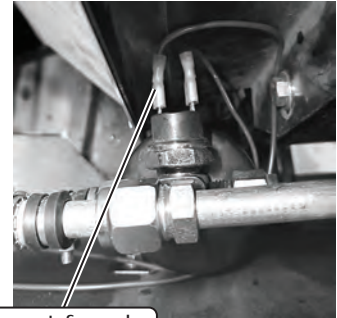

Connect female connector to binary safety switch

Photo 6



www.vintageair.com

## Louver Housing Installation

1. Place the under dash support brace into the pocket for the control panel as shown in Photo 1, below. Match drill holes with 9/64" drill bit.
2. Secure the under dash support brace to the under dash panel with (2) black pop rivets.
3. Remove the existing hardware on the underside of the dash, including the loosely installed 1/4-20 x 1/2" button head screws and glove box hinges (See Photo 2, below). **NOTE: The fresh air lever does not need to be removed.**
4. Place assembly under the dash, and secure it with (2) 1/4-20 x 1/2" button head screws going into the evaporator dash bracket (See Photo 3, below).
5. Reinstall the glove box hinges using (4) 10-32 x 1/2" pan head screws (See Photo 3, below).
6. Secure the under dash support brace to the evaporator module using a #8 x 1/2" pan head screw going into the hole on the bottom of the evaporator as shown in Photo 4, below.
7. Secure the under dash using the (2) remaining 10-32 x 1/2" pan head screws and (2) 10-32 nuts with star washers as shown in Photo 5, below.
8. Install the louver housing to the kick panel area using (3) #8 x 1/2" pan head screws as shown in Photo 6, below. **NOTE: Image shows duct hose pre-installed.**

Place under dash support brace into pocket for control panel, then match drill holes with 9/64" drill bit

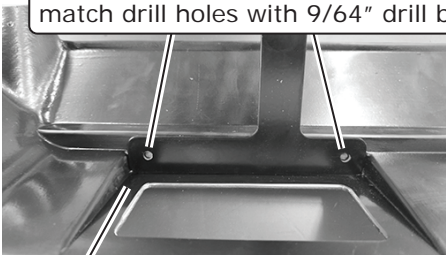

Under Dash Support Brace 640044

Photo 1

Remove existing hardware on underside of dash, including loosely installed 1/4-20 x 1/2" button head screws and glove box hinges



Photo 2

Secure with (2) 1/4-20 x 1/2" button head screws going into evaporator dash bracket

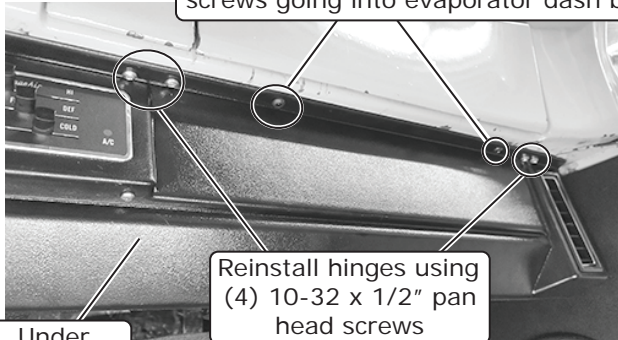

Under Dash Panel 623042

Photo 3

Reinstall hinges using (4) 10-32 x 1/2" pan head screws

Secure under dash support brace to evaporator module using #8 x 1/2" pan head screw

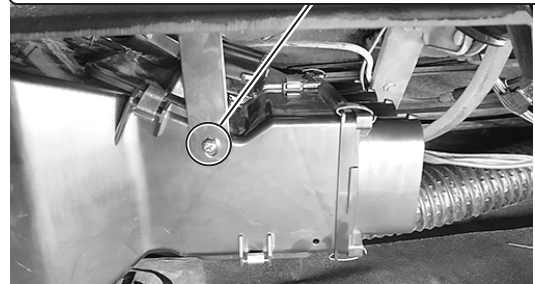

Bottom View of Evaporator Module

Photo 4

Install louver housing to kick panel area using (3) #8 x 1/2" pan head screws

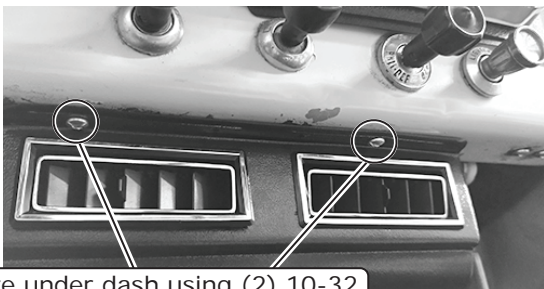

Secure under dash using (2) 10-32 x 1/2" pan head screws and (2) 10-32 nuts with star washers

Photo 5

Louver Housing 49069-VUI

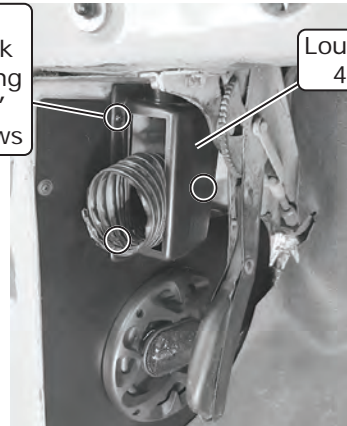

Photo 6



www.vintageair.com

## Control Panel Installation

1. Locate the control panel assembly and wiring harness. Remove the 1/4-20 locknut and the control panel mounting bracket from the control panel (See Photo 1, below).
2. Route the harness through the opening towards the ECU (See Photo 2, below).
3. Connect the control panel plug to the ECU as shown in Photo 3, below.
4. Place the control panel into the opening and reinstall the mounting bracket with the 1/4-20 locknut (See Photo 4, below).

Control Panel Assembly  
491274

Control Panel Mounting Bracket  
643045

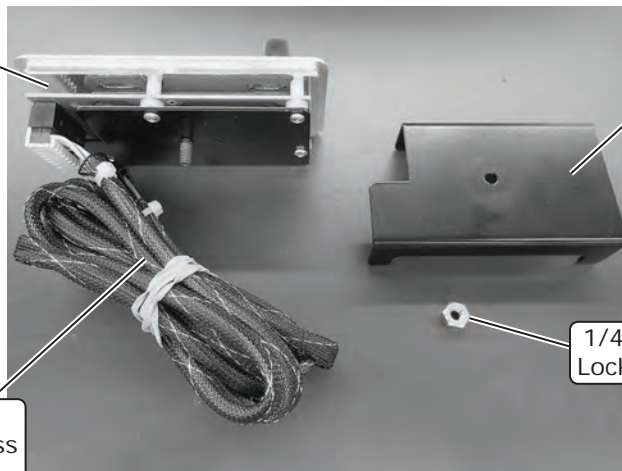

Universal Control Harness  
232007-VUR

1/4-20 Locknut

Photo 1

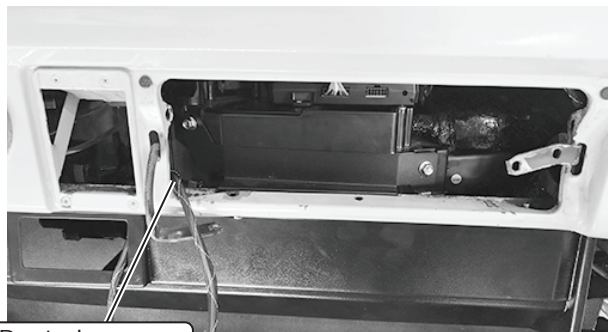

Route harness through opening toward ECU

Photo 2

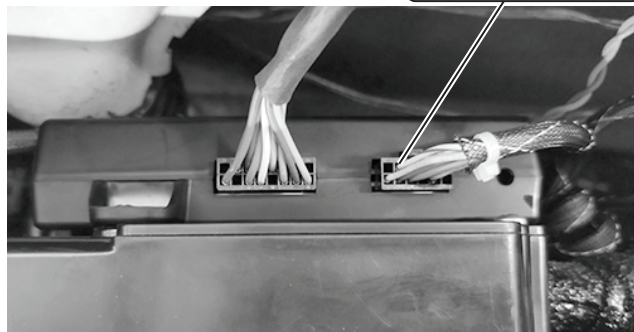

Connect control panel plug to ECU

Photo 3

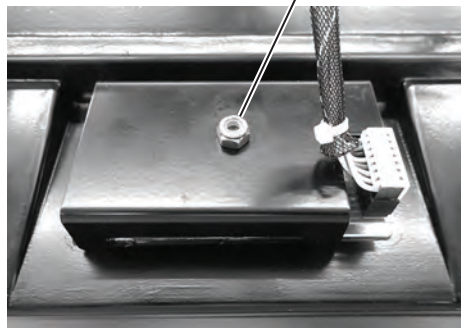

Reinstall mounting bracket with 1/4-20 locknut

Photo 4



www.vintageair.com

## Control Panel & Duct Hose Routing

**NOTE:** For the system to function optimally, the duct hoses must be routed as directly as possible, taking care to avoid kinks, sharp bends and unnecessary length. Vintage Air supplies duct hoses in continuous lengths that will need to be cut to size depending on application. Before cutting, familiarize yourself with the installation instructions and verify the routing will work with your application. For custom hose routing, additional hose may be needed and can be purchased from Vintage Air. Ensure that all duct hose routing is free and clear of windshield wiper arm mechanism. For dash vent louvers, it is recommended to pull the duct hose through the louver housing and connect to the louver, then click louver into place. To allow the hoses to route into the area behind the panels, the driver- and passenger-side dash louvers may require the kick panels to be modified. New panels made from 22 GA steel are available for purchase (See Additional Parts & Accessories, Page 2).

1. Stretch the duct hose until there is no slack, measure, mark and cut hose to size (See Photo 1, below).

Stretch, measure, mark and cut hose to size



Photo 1

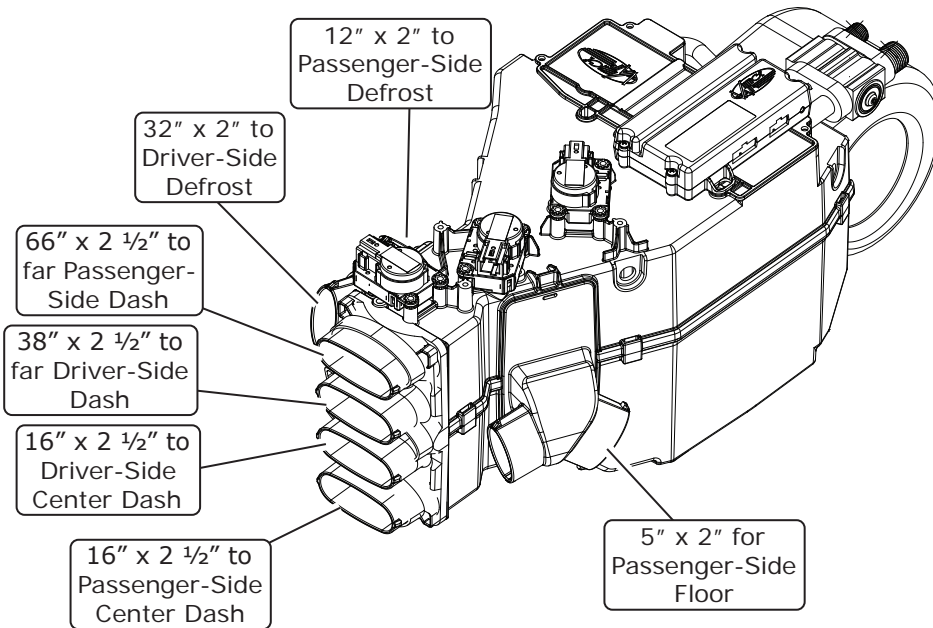

**NOTE:** ECU must be placed away from water and humidity, and also be accessible for servicing. If relocating, connectors must be positioned towards the bottom.

Position connectors towards bottom



www.vintageair.com

## Drain Hose Installation

1. Install 9" piece of drain hose onto the drain nipple of the evaporator. Feed the other end of the hose through the previously drilled 5/8" hole on the firewall (See Photo 1, below).
2. Install the remaining length of hose onto the 90° drain elbow, then install it onto the drain hose coming through the firewall (See Photo 2, below).

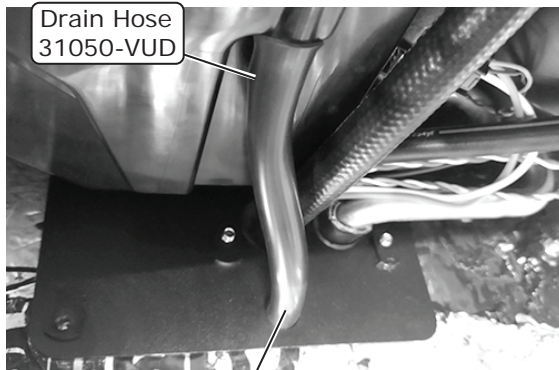

Feed other end of hose through previously drilled 5/8" hole on firewall

**Photo 1**

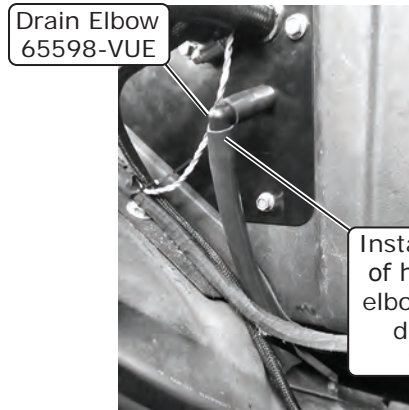

Install remaining length of hose onto 90° drain elbow, then install onto drain hose coming through firewall

**Photo 2**



www.vintageair.com

# Final Steps: Installation Check

| Installation Check       |   |
|--------------------------|---|
| ITEM TO CHECK            | Procedure   |
| <input type="checkbox"/> | <p>ECU</p> <p>If no blinking is observed after 1 minute of turning the ignition on, go to the next check.</p> <p>If repetitive blinking is observed, go to the <b>Advanced Diagnostics</b> Section to diagnose.</p>   |
| <input type="checkbox"/> | <p>Blower speed control</p> <p>Set the blower speed control to <b>OFF</b>, <u>confirm that the blower is off</u>.</p> <p>Position the blower speed control to <b>LOW</b> then <b>MEDIUM</b> and then <b>HIGH</b>. <u>At each setting confirm that the blower speed increases</u>, do this by feeling for the amount of air coming from the unit and hearing the blower speed increase.</p>  |
| <input type="checkbox"/> | <p>Mode control</p> <p>Set the <b>MODE</b> control to the <b>DASH</b> position. <u>Confirm that air is being blown at the dash vents</u>.</p> <p>Set the <b>MODE</b> control to the <b>FLOOR</b> position. <u>Confirm that air is being blown at the floor vents</u>.</p> <p>Set the <b>MODE</b> control to the <b>DEFROST</b> position. <u>Confirm that all air is being blown from the defrost vents</u></p> <p><b>If heater lines are installed:</b></p> <p>Set the <b>MODE</b> control to the <b>DASH</b> position. Set the <b>TEMP</b> control to the <b>MAX HEAT</b> position. <u>Confirm that HOT air is coming from the dash vents</u>.</p> |
| <input type="checkbox"/> | <p>Temperature control</p> <p><b>If system is charged:</b></p> <p>Set the <b>TEMP</b> control to the <b>MAX COOL</b> position. <u>Confirm that COLD air is coming from the dash vents</u>.</p> <p>Also <u>confirm that the compressor "clicks" on</u> when adjusting the <b>TEMP</b> control from the <b>MAX HEAT</b> position to the <b>MAX COOL</b> position.</p>   |
| <input type="checkbox"/> | <p>AC Indicator (If applicable)</p> <p>While the <b>MODE</b> control is set to the <b>DASH</b> position, and the <b>TEMP</b> control is set to the <b>MAX COOL/MIN HEAT</b> position, <u>confirm that the blue AC Indicator light is on</u>.</p>  |
| <input type="checkbox"/> | <p>Backlight (If applicable)</p> <p>If your control panel has backlight capabilities and has been wired, turn the dash lamp on and <u>confirm that the AC panel's legend is lit</u>.</p>  |
| <input type="checkbox"/> | <p>Fittings</p> <p>Verify AC and Heater fittings are all tight.</p>   |



www.vintageair.com

## Glove Box Installation

1. Secure the glove box door to the hinges using the OEM hardware (See Photo 1, below).
2. Install (7) #8 U-nuts onto the glove box opening, over the holes (See Photo 1, below).
3. Install the glove box into the opening (See Photo 2, below). **NOTE: Glove box walls must be squeezed inward when inserting through the opening.**
4. Secure with (7) #8 x 1/2" wide head screws (See Photo 2, below).

Install (7) #8 U-nuts onto glove box opening, over holes

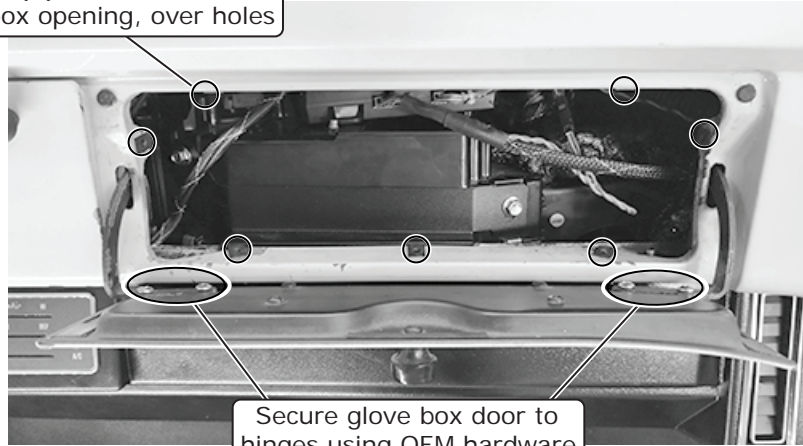

Photo 1

Secure with (7) #8 x 1/2" wide head screws

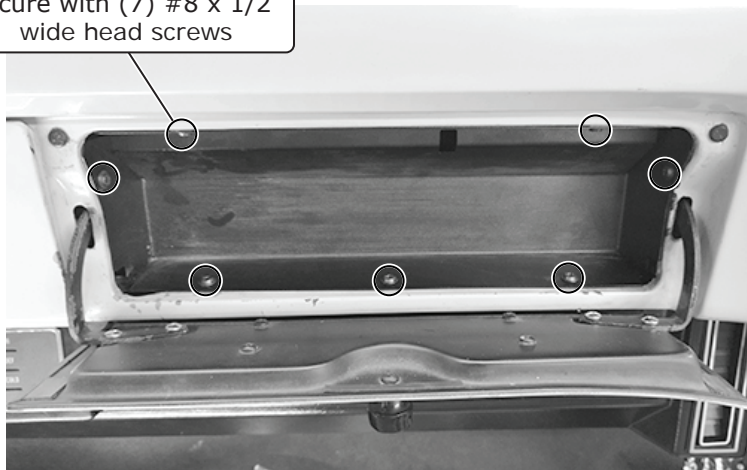

Photo 2



[www.vintageair.com](http://www.vintageair.com)

## *Final Steps: Completing the Install*

1. Reinstall all previously removed items.
2. Fill radiator with at least a 50/50 mixture of approved antifreeze and distilled water. It is the owner's responsibility to keep the freeze protection at the proper level for the climate in which the vehicle is operated. Failure to follow antifreeze recommendations will cause heater core to corrode prematurely and possibly burst in A/C mode and/or freezing weather, voiding your warranty.
3. Double check all fittings, brackets and belts for tightness. **NOTE: Vintage Air recommends that all A/C systems be serviced by a licensed automotive A/C technician.**
4. Evacuate the system for a minimum of 45 minutes prior to charging, and perform a leak check prior to servicing.
5. Charge the system to the capacities stated on Page 4 of this instruction manual.
6. See Operation of Controls procedures on Page 28.



www.vintageair.com

# Quality Crimp Guideline

Acceptable strip length  
(Some copper visible)

Crimped area is centered  
on each side of splice

Bad strip length  
(Too much copper visible)  
Visible copper should be  
just enough to ensure  
clearance between splice  
area and wire insulation

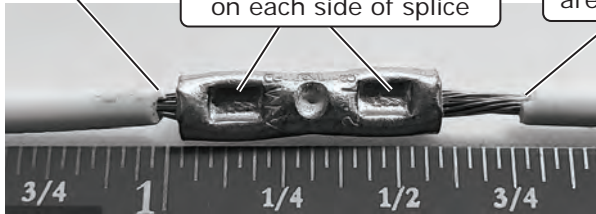

**Photo 1**

A good crimp requires  
seam of butt splice to be  
opposite of crimp die tooth

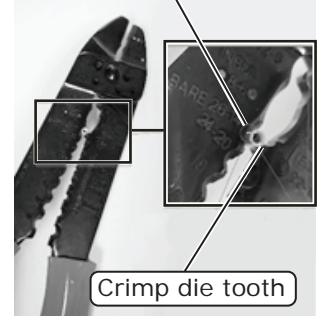

**Photo 2**

## Good Ring Terminal Crimp    Bad Ring Terminal Crimp



Crimped  
area is  
opposite  
of seam

**Photo 3**

Crimp  
area is  
centered  
on barrel

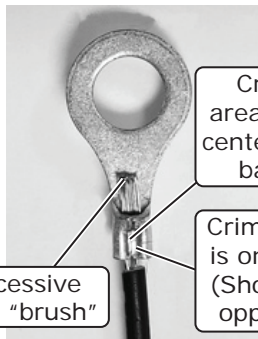

Crimp  
area is not  
centered on  
barrel

Excessive  
wire "brush"

Crimp area  
is on seam  
(Should be  
opposite)

**Photo 4**

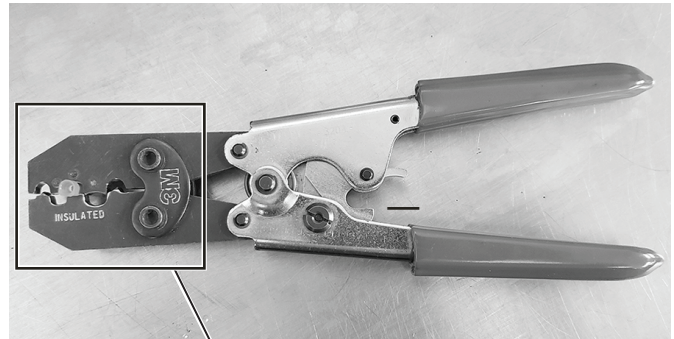

**Photo 5**

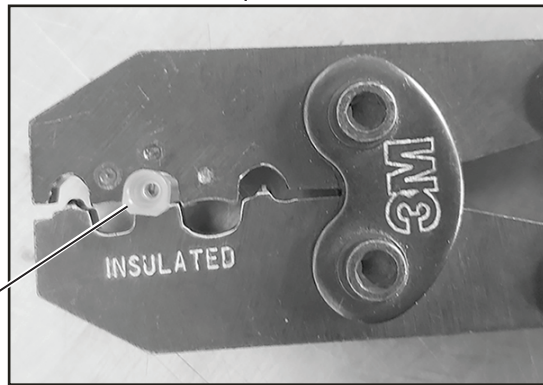

**Photo 5a**

Use a ratcheting crimp tool  
for insulated barrel terminals  
when crimping the provided  
female insulated terminal.  
Ensure terminal is inserted in  
appropriate position before  
crimping.



www.vintageair.com

# Gen 5 Wiring Diagram

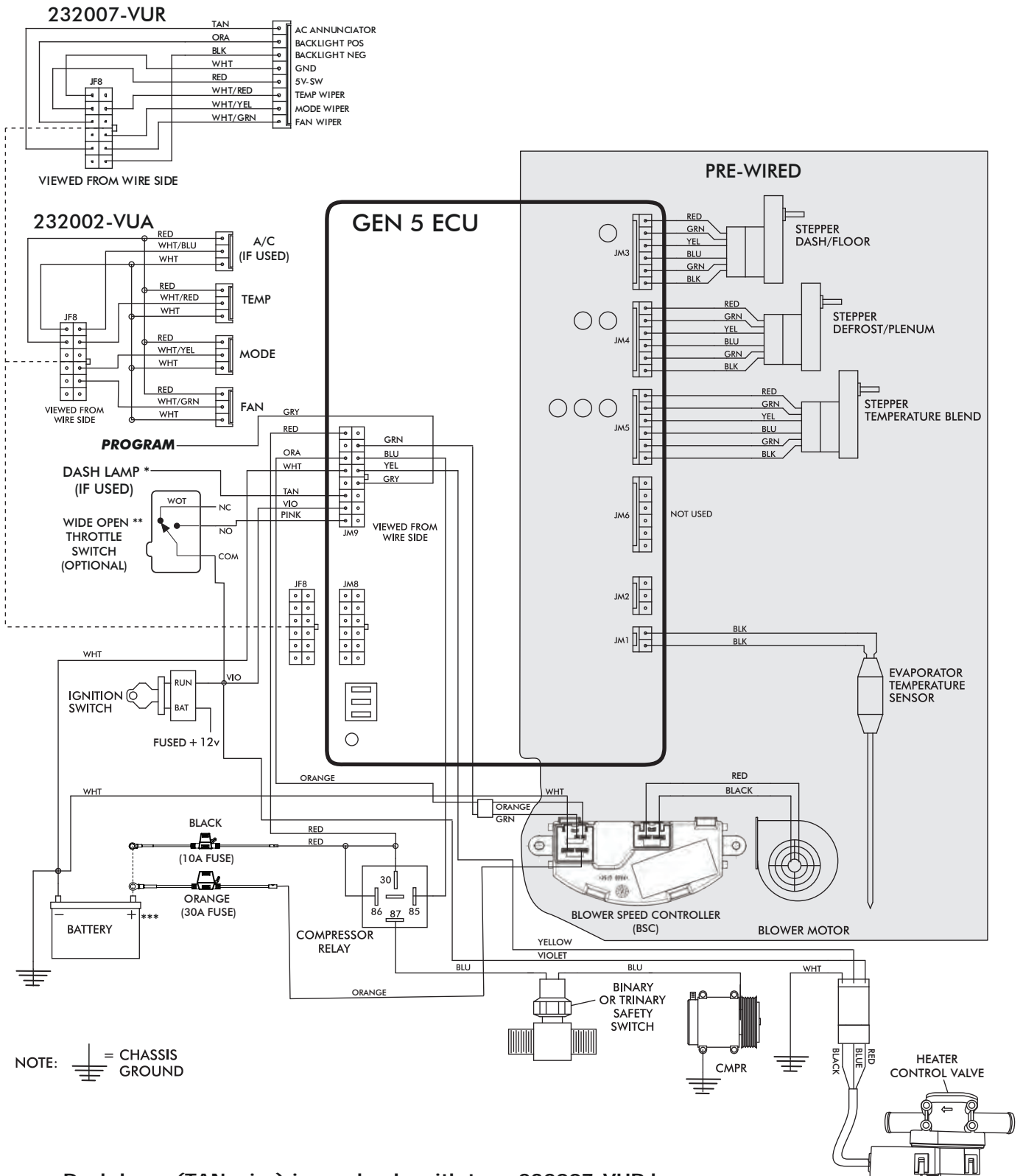

NOTE: = CHASSIS GROUND

- \* Dash lamp (TAN wire) is used only with type 232007-VUR harness.
- \*\* Wide open throttle switch contacts close only at full throttle, which disables A/C compressor.
- \*\*\* Install fuse assemblies at or as near to the battery as possible.



www.vintageair.com

# Gen 5 Wiring Instructions

WIRING HARNESS (231505) ↓

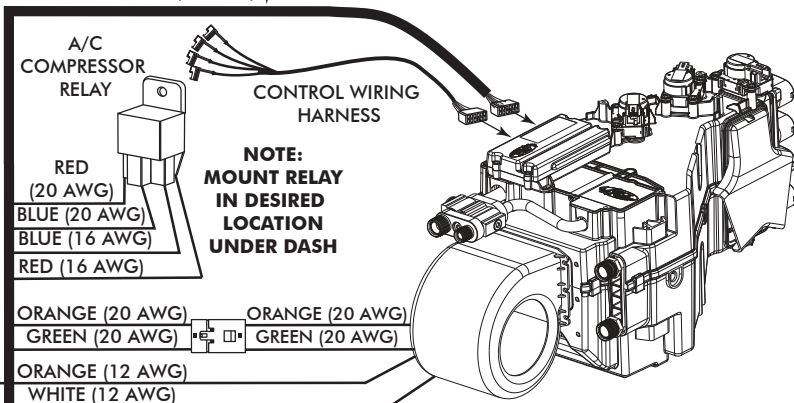

**NOTE:**  
MOUNT RELAY  
IN DESIRED  
LOCATION  
UNDER DASH

**Ignition Switch:**  
Using provided butt splice (PN 226004), connect the 20 AWG violet wire to a 5A fused and switched 12V source such as Key On.

**Wide Open Throttle Switch (Optional):**  
If a wide open throttle switch is required, connect the 20 AWG pink wire to a normally open switch that, when closed, connects a fused and switched 12V source to the pink wire. See Gen 5 wiring diagram for an example.

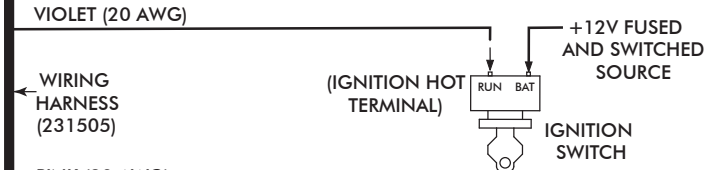

**Dash Light (Optional):**  
If using a Vintage Air control panel with back light, connect the 20 AWG tan wire to the vehicle's dash back light 0-12V using provided butt splice (PN 226004).

WIRING HARNESS (232020) →

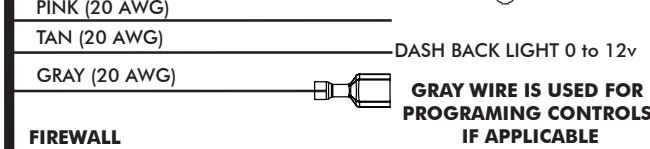

**Heater Control Valve:**  
Connect the Violet/Yellow/White twisted branch with 3 position connector into the heater control valve connector. Ensure that the mating latch is fully seated.

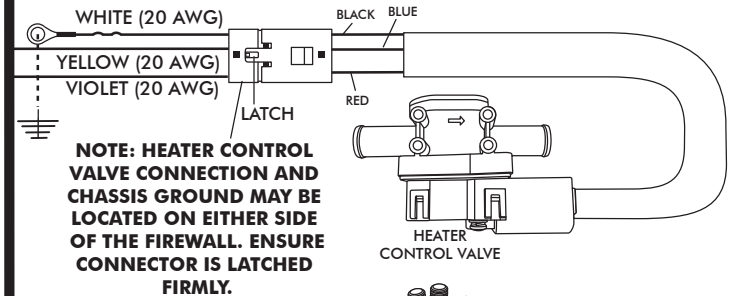

**NOTE: HEATER CONTROL VALVE CONNECTION AND CHASSIS GROUND MAY BE LOCATED ON EITHER SIDE OF THE FIREWALL. ENSURE CONNECTOR IS LATCHED FIRMLY.**

**Binary/Trinary & Compressor:**  
Binary Switch: Terminate provided insulated female terminal (PN 23172-VUW) to the blue 16 AWG wire. Connect as shown.  
Trinary Switch: Connect according to trinary switch wiring diagram.

WIRING HARNESS (232020) →

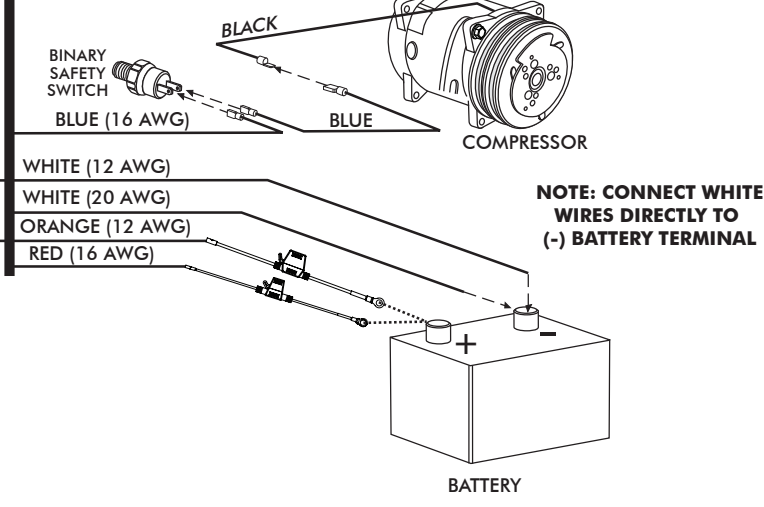

**Battery Connections:**  
ECU Ground: Terminate provided ring terminal (PN 226110) to 20 AWG white wire from the 231505 wire assembly and install at battery.  
ECU PWR: Terminate provided fuse assembly with black leads (PN 233012) to the 16 AWG red wire from the 231505 wire assembly. Install provided 10A Red Mini Fuse (PN 226118). Install at battery.  
Blower Speed Controller (BSC) Ground: Terminate provided ring terminal (PN 226111) to 12 AWG white wire from the 232020 wire assembly and install at battery.  
Blower Speed Controller (BSC) PWR: Terminate provided fuse assembly with orange leads (PN 233008) to the 12 AWG orange wire from the 232020 wire assembly. Install provided 30A Green ATO/ATC Fuse (PN 226125). Install at battery.



www.vintageair.com

## Operation of Controls

On Gen IV and Gen 5 systems with three lever/knob controls, the temperature control toggles between heat and A/C operations. To activate A/C, move the temperature lever/knob all the way to cold and then back it off to the desired vent temperature. For heat operation, move the temperature lever/knob all the way to hot and then adjust to the desired vent temperature. The blower will momentarily change speed, each time you toggle in and out of heat and A/C operations, to indicate the change.

### Blower Speed

This lever/knob controls blower speed, from OFF to HI.

### Mode Control

This lever/knob controls the mode positions, from DASH to FLOOR to DEFROST, with a blend in between.

### Temperature Control

This lever/knob controls the temperature, from HOT to COLD.

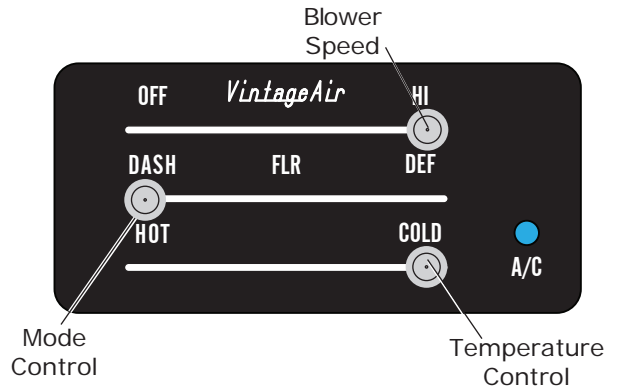

## A/C Operation

### Blower Speed

Adjust to desired speed.

### Mode Control

Adjust to desired mode position (DASH position recommended).

### Temperature Control

For A/C operation, adjust to coldest position to engage compressor (Adjust between HOT and COLD to reach desired temperature).

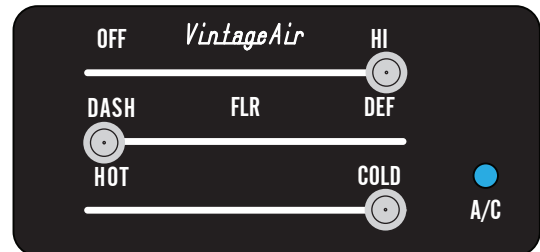

## Heat Operation

### Blower Speed

Adjust to desired speed.

### Mode Control

Adjust to desired mode position (FLOOR position recommended).

### Temperature Control

For maximum heating, adjust to hottest position (Adjust between HOT and COLD to reach desired temperature).

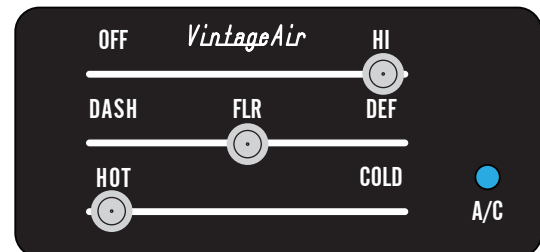

## Defrost/De-fog Operation

### Blower Speed

Adjust to desired speed.

### Mode Control

Adjust to DEFROST position for maximum defrost, or between FLOOR and DEFROST positions for a bi-level blend (Compressor is automatically engaged).

### Temperature Control

Adjust to desired temperature.

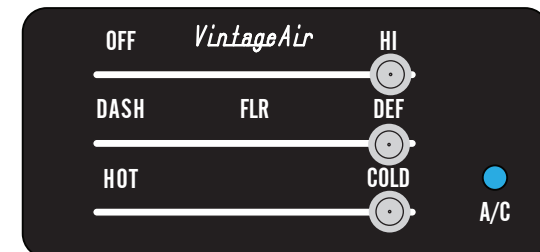



www.vintageair.com

# Troubleshooting Guide

This printed troubleshooting guide is our basic guide that covers common installation problems. To see our advanced diagnostics and troubleshooting guide, please refer to the following page for instructions on how to download the complete guide.

**WARNING: While troubleshooting the system, never probe connector terminals from the front mating side, only back probe.**  
**WARNING: While troubleshooting the system, never use automotive check lights.**

| Symptom   | Condition  | Checks   | Actions  | Notes  |
|---|--|--|--|--|
| 1. Blower stays on high speed with ignition on.             | No other functions work.                                 | Check for damaged pins or wires in the control panel wire assembly and mating header at ECU.   | If found damaged, replace wire assembly or ECU.  | If fuse continues to blow, there is a serious problem in the wiring. Check all wiring and ensure the wire is not damaged and shorting out along its route.   |
|   | All other functions work.                                | Check for a bad ECU GND.<br>Check for damaged pins or wires in the control panel wire assembly and mating header at ECU.<br>Check if Blower power fuse is blown.<br>Check for a bad ECU GND. | If found damaged, replace wire assembly or ECU.<br>Replace fuse.<br>Repair connection.           |  |
| 2. Compressor will not turn on (All other functions work).  | System is not charged.                                   | System must be charged for compressor to engage.   | Charge system.   | <b>Danger: Never bypass safety switch with engine running. Serious injury can result.</b>  |
|   | System is charged.                                       | Check for faulty A/C potentiometer or associated wiring (not applicable to 3-pot controls).  | Check continuity to ground on white control head wire.<br>Check for 5V on red control head wire. | To check for proper pot function, check voltage at white/red wire. Voltage should be between 0V and 5V, and will vary with pot lever position.   |
|   |  | Check for disconnected or faulty thermistor.   | Check 2-pin connector at ECU housing.  | Disconnected or faulty thermistor will cause compressor to be disabled.  |
| 3. Compressor will not turn off (All other functions work). | Compressor will not turn off (All other functions work). | Check for faulty A/C potentiometer or associated wiring.   | Repair or replace pot/control wiring.  | Red wire at A/C pot should have approximately 5V with ignition on. White wire will have continuity to chassis ground. White/Red wire should vary between 0V and 5V when lever is moved up or down. |
|   |  | Check for faulty A/C relay.  | Replace relay.   |  |



www.vintageair.com

# Troubleshooting Guide (Cont.)

| Symptom   | Condition  | Checks  | Actions   | Notes  |
|---|--|---|---|--|
| 4. System will not turn on, or runs intermittently. | Works when engine is not running; shuts off when engine is started | Noise interference from either ignition or alternator.                                    | Install capacitors on ignition coil and alternator. Ensure good ground at all points. Relocate coil and associated wiring away from ECU and ECU wiring. Check for burned or loose plug wires. | Ignition noise (radiated or conducted) will cause the system to shut down due to high voltage spikes. If this is suspected, check with a quality oscilloscope. Spikes greater than 16V will shut down the ECU. Install a radio capacitor at the positive post of the ignition coil (see radio capacitor installation bulletin). A faulty alternator or worn out battery can also result in this condition. |
|   | Will not turn on under any conditions.                             | Verify connections on power lead, ignition lead, and both white ground wires.             | Check for power at ECU, and confirm ignition is being applied to ECU properly.  |  |
|   |  | Verify battery voltage is greater than 10 volts and less than 16 while engine is running. | Verify proper meter function by checking the condition of a known good battery.   |  |
|   |  | Check for damaged mode switch or potentiometer and associated wiring.                     |   |  |
| 5. Loss of mode door function.                      | No mode change at all.   | Check for at least 12V at circuit breaker.  | Ensure all system grounds and power connections are clean and tight.  | System shuts off blower at 10V. Poor connections or weak battery can cause shutdown at up to 11V.  |
|   | Battery voltage is at least 12V.                                   | Check for faulty battery or alternator.   | Charge battery.   |  |
| 6. Blower turns on and off rapidly.                 | Battery voltage is less than 12V.                                  | Check for damaged switch or pot and associated wiring.                                    | Repair or replace.  |  |
|   | Erratic functions of blower, mode, temp, etc.                      |   |   |  |

## Advanced Diagnostics and Troubleshooting Guide

If after referencing the Troubleshooting Guide, the issue is not resolved, move to The Advanced Diagnostics and Troubleshooting Guide that covers the following:

- ECU Diagnostics Codes
- 1. ECU Blink Sequence
- 2. Firmware Version Number
- 3. ECU Model Number
- 4. ECU Start-Up Blink Sequence
- 5. Diagnostic Codes
- Complete Advanced Troubleshooting Guidelines

Access the latest version of the Advanced Diagnostics and Troubleshooting Guide by scanning the following QR code on your mobile device:



You can also access the guide by typing the following address into your web browser:

[https://www.vintageair.com/instructions\\_pdf/905000.pdf](https://www.vintageair.com/instructions_pdf/905000.pdf)





www.vintageair.com

## Packing List: Evaporator Kit (751633)

| No. | Qty. | Part No. | Description                                 |
|-----|------|----------|---|
| 1.  | 1    | 765125   | Gen 5 Magnum Evaporator Module with 444 ECU |
| 2.  | 1    | 791633   | Accessory Kit                               |

Checked By: \_\_\_\_\_  
Packed By: \_\_\_\_\_  
Date: \_\_\_\_\_

1



Gen 5 Magnum Evaporator  
Module with 444 ECU  
765125

2

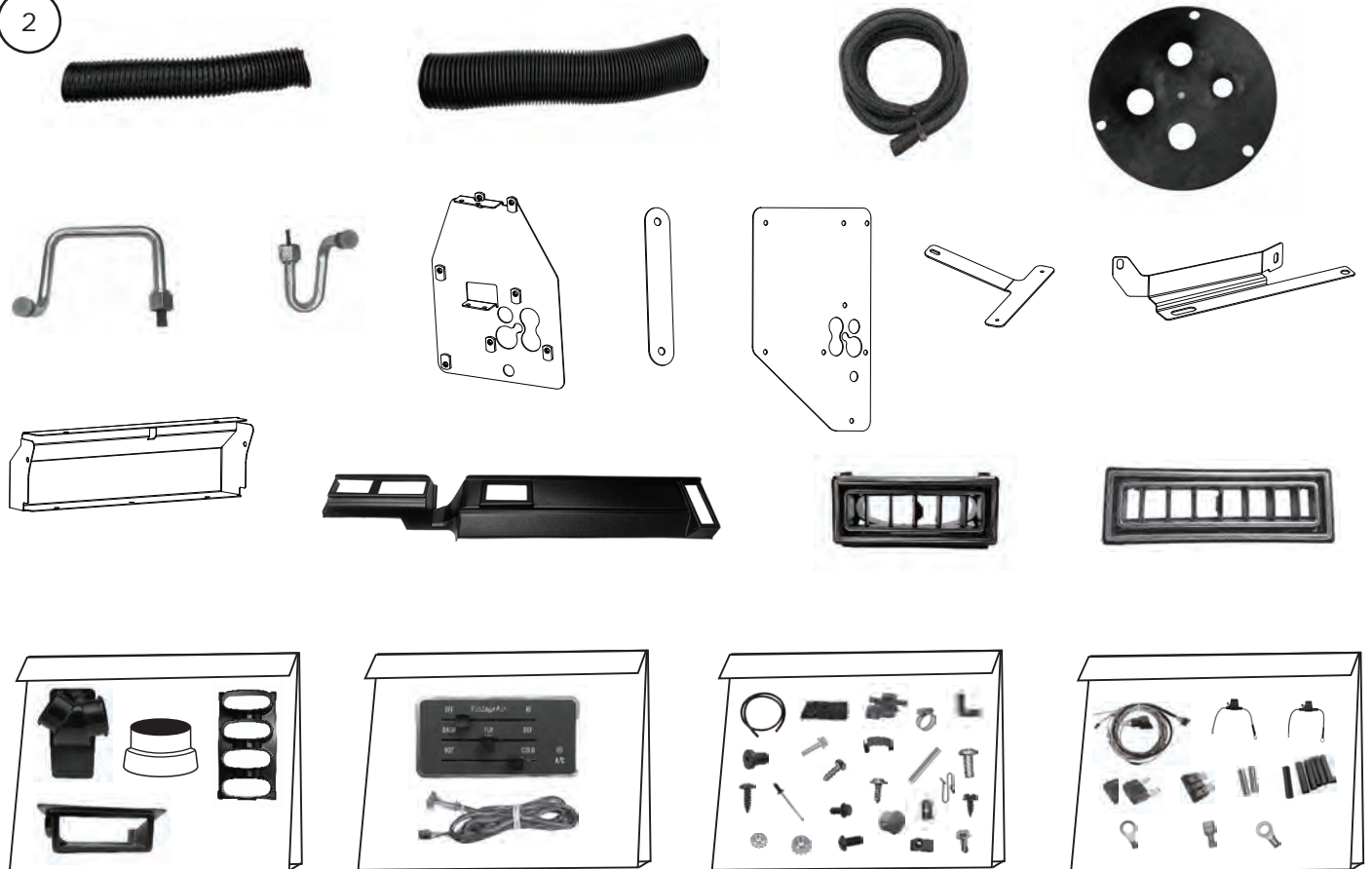

Accessory Kit  
791633

**NOTE: Images may not depict actual parts and quantities.  
Refer to packing list for actual parts and quantities.**