

TRIM TO THE TRADE

QUALITY PLUMBING SPECIALIST

2023 - 2025



Our NEW
Finish #38 Light Brushed Bronze



COMPLIMENTS MAJOR MANUFACTURERS'
BRUSHED BRONZES

We have an
Extensive Inventory of the
HOTTEST FINISH
our *Finish #20 Flat Black*





Our ever-popular

FINISH #47

ENEZIAN BRONZE

compliments major manufacturers' darker bronzes



QUALITY PLUMBING SPECIALIST

2023 - 2025

ORDERS & INQUIRIES:

customerservice@trimtothetrade.com

trimtothetrade.com

Office 760-343-3306

Fax 800-562-9998

77551 El Duna Court, Suite J

Palm Desert, CA 92211



CARE & CLEANING

As with all quality plumbing supplies, care must be taken during installation and regular long term use. There is a protective coating on all goods to protect the surface from scratching or tarnishing during shipping and storage. The protective coating is not meant to withstand normal day to day use on items which come into contact with acids (found in most foods) and corrosives (found in all detergents). Trim To The Trade does not warrant the wearing quality of the protective coating.

INSTALLATION

Decorative items should be the last items to be installed after final cleaning of the surrounding areas.

DO NOT USE putty or silicone sealer containing a curing acidic base for installation. These items will damage the protective coating through heat generation.

CARE AND CLEANING

Use a soft cloth to clean, dampened if necessary.

DO NOT USE compounds containing acids (muriatic, phosphoric, hydrofluoric, or toluene), solvents (xylene or toluene), or other cleansers (such as bleach, alcohol, aromatic oils, or those containing abrasives).

All of these products will cause damage to the protective coating and may further damage or destroy the base material through etching or pitting.

TABLE OF CONTENTS

PRODUCT FINISHES	3	1-3/8" TUBES FOR W & O	77
AIR GAPS & HOLE COVERS	4-5	NEW ADJUSTABLE SHOWER ROD & HOLDER	78
DISPOSAL FLANGE & STOPPER SETS	6-7	NEW ONE PIECE SHOWER RODS	79
NEW STOPPER STRAINER SETS	8	NEW SHOWER ROD FLANGES	80
DISPOSAL FLANGE & STOPPER SETS	9-10	SHOWER ROD HOLDERS & ACCESSORIES	81
LARGE BASKET STRAINERS	11	BRASS SHOWER HEADS	82
SINK & BAR STRAINERS	12-13	NEW 10" ROUND SHOWER HEAD	83
LOTION/SOAP DISPENSERS	14	NEW SHEPHERD'S CROOK SHOWER ARM & FLANGE ..	84
WATER DISPENSERS	15	NEW 8" ROUND SHOWER HEAD	85
DRAIN TRIM SETS	16-18	SHOWER ARMS & FLANGES	86-87
TRIM SET/GRILL	19	SHOWER ARMS	88-89
TILE SQUARES	20	SHOWER ARM FLANGES	90-91
SNAP-IN STRAINERS	21-27	VOLUME CONTROL	91
CROWNS	28	TUB SPOUTS	92-93
SCREWS	29	REMODEL PLATE	93
SHOWER DRAINS	30-31	DIVERTER SPOUTS	94
ROMAN TUB DRAINS	32-33	CLOSET SUPPLY SET	95-98
TANK LEVERS	34-37	LAVATORY SUPPLY SETS	99-101
CLOSET TANK ELBOW & SLIP JOINT NUT	37	FLAT HEAD RIGID SUPPLY TUBES	102
LAVATORY DRAINS	38-42	1/2" BULLNOSE RIGID SUPPLY TUBES	103
VESSEL SPACER	43	3/8" BULLNOSE RIGID SUPPLY TUBES	104
P-TRAPS (17 GAUGE)	44-46	1/2" IPS ANGLE STOPS	105-106
DECORATIVE BOTTLE TRAP	47	1/2" NOMINAL COMPRESSION ANGLE STOPS	107-108
S-TRAPS (17 GAUGE)	48	1/2" NOMINAL COMPRESSION ANGLE STOPS-	
SLIP JOINT EXTENSION TUBES	49	QUARTER TURN	109
TAILPIECES	50	1/2" IPS STRAIGHT STOPS	110-111
SLIP JOINT ELBOWS	51	1/2" NOMINAL COMPRESSION STRAIGHT STOPS ..	112-113
DOUBLE OFFSETS & SLIP JOINT NUTS	52	3/8" IPS ANGLE STOPS	114
COVER CASINGS	53	3/8" IPS STRAIGHT STOPS	115
BATH STRAINERS	54-56	STOPS WITH 5" EXTENSION TUBES	116-117
TRIP LEVER DRAIN SET	57	STOPS WITH CORRUGATED RISERS	118
W & O CONVERSION KITS	58-62	BRAIDED RISERS	119
FACE PLATES & ACCESSORIES	63	1/2" THREADED BRASS FITTINGS	120
BUSHINGS	64	3/8" THREADED BRASS FITTINGS	121
OFFSET BATH SUPPLIES	65	1/2" IPS NIPPLES	122-124
W & O TRIP LEVER STYLE	66-67	3/8" IPS NIPPLES	125
W & O LIFT & TURN STYLE	68-69	SURE GRIP FLANGES	126-127
W & O CHAIN & STOPPER	70	BELL FLANGES	128-129
W & O TIP-TOE STYLE	71-73	HIGH BOX FLANGES	130
W & O LIFT & TURN FOR FREESTANDING TUBS		LOG LIGHTER TRIM	131
WITH EXTENDED SHOE	74-75	INDEX OF PRODUCTS	132-134
1-1/2" TUBES FOR W & O	76	TERMS & CONDITIONS OF SALE	135

































Trim to the Trade has an extensive inventory in many finishes

Grill 4T-031 on Page 19



PRODUCT FINISHES

Color Set: We have “Color Sets” available to all of our customers for sampling purposes. Contact Customer Service for a complimentary set.

Finish	Code	Name	Finish	Code	Name
	1	Polished Chrome		30	Polished Nickel
	2	Polished Brass & PVD		31	Satin Nickel
	3	Antique Brass		32	Light Gold
	4	Antique Nickel (Pewter)		33	Antique Bronze
	5	Satin Brass		34	Oil Rubbed Bronze
	6	Satin Chrome		35	Satin Gold
	7	Polished Copper		36	Antique Copper
	8	Polished Gold		37	Satin Copper
	11	Uncoated Polished Brass		38	Light Brushed Bronze
	12	Black Nickel		40	Aged Pewter
	13	White		45	Matte Gold
	15	Gloss Black		46	Antique Gold
	16	Biscuit		47	Venezian Bronze
	19	Almond		48	Polished Bronze
	20	Flat Black		50	Brushed Nickel (Stainless)

COLOR DISCLAIMER: Actual product colors may vary from colors shown in the catalog.

AIR GAPS

4T-202 & 4T-203



4T-203

BRASS METAL AIR GAP CAP ONLY (NO RIM) | 4T-203

2-1/4" TALL

1-5/8" OD



4T-202

COMPLETE AIR GAP KIT (NO RIM) | 4T-202

PLASTIC BODY WITH BRASS CAP

IAPMO APPROVE

4T-202 & 4T-203

FINISHES & PRICE GROUPS:

PRICE GROUP A

- Polished Chrome (1)

PRICE GROUP B

- White (13)
- Gloss Black (15)
- Biscuit (16)
- Almond (19)
- Flat Black (20)

PRICE GROUP C

- Polished Brass & PVD (2)
- Antique Brass (3)
- Antique Nickel (Pewter) (4)
- Satin Brass (5)
- Satin Chrome (6)
- Polished Nickel (30)
- Satin Nickel (31)
- Oil Rubbed Bronze (34)
- Stainless/Brushed Nickel (50)

PRICE GROUP D

- Polished Copper (7)
- Uncoated Polished Brass (11)
- Antique Bronze (33)
- Satin Gold (35)
- Antique Copper (36)
- Satin Copper (37)
- Light Brushed Bronze (38)
- Venezian Bronze (47)

AIR GAPS & HOLE COVERS

4T-204, 4T-205 & 4T-200

BRASS METAL AIR GAP CAP ONLY WITH RIM | 4T-204

SITS FLUSH WITH COUNTERTOP 2-1/4" TALL 1-7/8" OD AT BASE



4T-204

4T-204 & 4T-205 FINISHES & PRICE GROUPS:

PRICE GROUP A

- Polished Chrome (1)

PRICE GROUP B

- White (13)
- Gloss Black (15)
- Biscuit (16)
- Almond (19)
- Flat Black (20)

PRICE GROUP C

- Polished Brass & PVD (2)
- Antique Brass (3)
- Antique Nickel (Pewter) (4)

- Satin Brass (5)
- Satin Chrome (6)
- Polished Nickel (30)
- Satin Nickel (31)
- Oil Rubbed Bronze (34)
- Stainless/Brushed Nickel (50)

PRICE GROUP D

- Uncoated Polished Brass (11)
- Satin Gold (35)
- Light Brushed Bronze (38)
- Venezian Bronze (47)



4T-205

AIR GAP KIT WITH RIM 4T-205

PLASTIC BODY WITH BRASS CAP

IAPMO APPROVED

4T-200 FINISHES & PRICE GROUPS:

PRICE GROUP A

- Polished Chrome (1)

PRICE GROUP B

- White (13)
- Gloss Black (15)
- Biscuit (16)
- Almond (19)
- Flat Black (20)

PRICE GROUP C

- Polished Brass & PVD (2)
- Antique Brass (3)
- Antique Nickel (Pewter) (4)
- Satin Brass (5)
- Satin Chrome (6)
- Polished Nickel (30)
- Satin Nickel (31)

- Oil Rubbed Bronze (34)
- Stainless/Brushed Nickel (50)

PRICE GROUP D

- Polished Copper (7)
- Polished Gold (8)
- Uncoated Polished Brass (11)
- Light Gold (32)
- Antique Bronze (33)
- Satin Gold (35)
- Antique Copper (36)
- Satin Copper (37)
- Light Brushed Bronze (38)
- Matte Gold (45)
- Antique Gold (46)
- Venezian Bronze (47)
- Polished Bronze (48)



4T-200

2" FAUCET HOLE COVER | 4T-200

SOLID TOP

DISPOSAL FLANGE & STOPPER SETS

4T-209K, 4T-209 & 4T-210



4T-209K

FLANGE & STOPPER SET | 4T-209K

FLANGE (4T-209) AND STOPPER (4T-210)

FITS ISE BADGER, KENMORE, MAYTAG, MOEN AND KITCHENAID

1-7/16" DEEP



4T-209

GARBAGE DISPOSAL FLANGE ONLY | 4T-209

FITS ISE BADGER, KENMORE, MAYTAG, MOEN AND KITCHENAID

1-7/16" DEEP



4T-210

GARBAGE DISPOSAL STOPPER ONLY | 4T-210

FITS ISE BADGER, KENMORE, MAYTAG, MOEN AND KITCHENAID

FITS 4T-209 AND 4T-207 FLANGES

4T-209K, 4T-209 & 4T-210 FINISHES & PRICE GROUPS:

PRICE GROUP A

- Polished Chrome (1)

PRICE GROUP B

- White (13)
- Gloss Black (15)
- Almond (19)
- Flat Black (20)

PRICE GROUP C

- Polished Brass & PVD (2)
- Antique Brass (3)
- Antique Nickel (Pewter) (4)
- Satin Brass (5)
- Satin Chrome (6)

- Polished Nickel (30)
- Satin Nickel (31)
- Oil Rubbed Bronze (34)
- Stainless/Brushed Nickel (50)

PRICE GROUP D

- Polished Copper (7)
- Polished Gold (8)
- Uncoated Polished Brass (11)
- Light Gold (32)
- Satin Gold (35)
- Antique Copper (36)
- Satin Copper (37)
- Light Brushed Bronze (38)
- Venezian Bronze (47)

DISPOSAL FLANGE & STOPPER SETS

4T-208 & 4T-207

DEEP FLANGE & STOPPER SET | 4T-208

DEEP FLANGE (4T-207) AND STOPPER (4T-210)

FITS ISE BADGER, KENMORE, MAYTAG AND KITCHENAID

2-3/8" DEEP-FITS



4T-208

DEEP GARBAGE DISPOSAL FLANGE ONLY | 4T-207

FITS ISE BADGER, KENMORE, MAYTAG, AND KITCHENAID

2-3/8" DEEP



4T-207

4T-208 & 4T-207 FINISHES & PRICE GROUPS:

PRICE GROUP A

- Polished Chrome (1)

PRICE GROUP B

- White (13)
- Gloss Black (15)
- Biscuit (16)
- Almond (19)
- Flat Black (20)

PRICE GROUP C

- Polished Brass & PVD (2)
- Antique Brass (3)
- Antique Nickel (Pewter) (4)

- Satin Brass (5)
- Satin Chrome (6)
- Polished Nickel (30)
- Satin Nickel (31)
- Oil Rubbed Bronze (34)
- Stainless/Brushed Nickel (50)

PRICE GROUP D

- Uncoated Polished Brass (11)
- Satin Gold (35)
- Antique Copper (36)
- Light Brushed Bronze (38)
- Venezian Bronze (47)

STOPPER-STRAINER SETS

4T-206, 4T-236 & 4T-237

NEW



4T-206

STOPPER-STRAINER | 4T-206

COMBINATION GARBAGE DISPOSAL STOPPER AND SINK STRAINER
STRAINER IS 3.1" IN DIAMETER, STOPPER IS 3.3" IN DIAMETER



4T-236

STOPPER-STRAINER SET | 4T-236

INCLUDES STOPPER-STRAINER (4T-206) AND
GARBAGE DISPOSAL FLANGE (4T-209)
FLANGE IS 1-7/16" DEEP



4T-237

DEEP FLANGE STOPPER-STRAINER SET | 4T-237

INCLUDES STOPPER-STRAINER (4T-206) AND DEEP GARBAGE DISPOSAL
FLANGE (4T-207)
FLANGE IS 2-3/8" DEEP

4T-206, 4T-236 & 4T-237 FINISHES & PRICE GROUPS:

PRICE GROUP A

- Polished Chrome (1)

PRICE GROUP B

- White (13)
- Flat Black (20)

PRICE GROUP C

- Polished Brass & PVD (2)
- Polished Nickel (30)
- Satin Nickel (31)
- Oil Rubbed Bronze (34)
- Stainless/Brushed Nickel (50)

DISPOSAL FLANGE & STOPPER SETS

4T-213K, 4T-213A & 4T-213S

FLANGE & STOPPER SET | 4T-213K

INCLUDES FLANGE (4T-213A) AND STOPPER (4T-213S)
FITS WASTE KING GOURMET EASY MOUNT, WASTE KING LEGEND SERIES, ELIMINATOR, GIBSON, CALORIC, FRIGIDAIRE, GE, KELVINATOR, MAGIC CHEF, MR. ROOTER, MODERN MAID, M. WARD, PHCC, SINKMASTER, TAPPAN/O'KEEFE, WHIRLWAY AND WHITE-WESTINGHOUSE



GARBAGE DISPOSAL FLANGE ONLY | 4T-213A

2-1/4" DEEP
1-1/4" THREADS WITH TEETH



GARBAGE DISPOSAL STOPPER | 4T-213S



4T-213K, 4T-213A & 4T-213S FINISHES & PRICE GROUPS:

PRICE GROUP A

- Polished Chrome (1)

PRICE GROUP B

- White (13)
- Gloss Black (15)
- Biscuit (16)
- Almond (19)
- Flat Black (20)

PRICE GROUP C

- Polished Brass & PVD (2)
- Antique Nickel (Pewter) (4)
- Satin Chrome (6)
- Polished Nickel (30)
- Satin Nickel (31)
- Oil Rubbed Bronze (34)
- Stainless/Brushed Nickel (50)

PRICE GROUP D

- Venezian Bronze (47)

DISPOSAL FLANGE & STOPPER SETS

4T-214, 4T-211 & 4T-212



4T-214

GARBAGE DISPOSAL FLANGE & STOPPER SET | 4T-214

INCLUDES FLANGE (4T-211) AND STOPPER (4T-212)

FITS WASTE KING GOURMET CUSTOM SERIES 3 BOLT MOUNT AND WHIRLAWAY

PRO 3 BOLT MOUNT

1-3/4" DEEP



4T-211

GARBAGE DISPOSAL FLANGE ONLY | 4T-211

FITS WASTE KING GOURMET CUSTOM SERIES 3 BOLT AND

WHIRLAWAY, PRO 3 BOLT MODELS



4T-212

GARBAGE DISPOSAL STOPPER ONLY | 4T-212

FITS WASTE KING GOURMET CUSTOM SERIES 3 BOLT AND

WHIRLAWAY PRO 3 BOLT MODELS

4T-214, 4T-211 & 4T-212 FINISHES & PRICE GROUPS:

PRICE GROUP A

- Polished Chrome (1)

PRICE GROUP B

- White (13)
- Gloss Black (15)
- Almond (19)
- Flat Black (20)

PRICE GROUP C

- Polished Brass & PVD (2)
- Antique Brass (3)
- Antique Nickel (Pewter) (4)

- Satin Brass (5)
- Satin Chrome (6)
- Polished Nickel (30)
- Satin Nickel (31)
- Oil Rubbed Bronze (34)
- Stainless/Brushed Nickel (50)

PRICE GROUP D

- Polished Copper (7)
- Antique Copper (36)
- Venezian Bronze (47)

LARGE BASKET STRAINERS

4T-231 & 4T-242

LARGE BASKET STRAINER WITH POST BASKET | 4T-231

INCLUDES BRASS NUTS & WASHERS

LARGE BASKET STRAINER AND POST STYLE BASKET (4T-232)

FITS 3-1/2" TO 4" OPENING

4-3/8" FLANGE DIAMETER

2-1/2" DEEP WITH 1-1/2" THREAD



4T-231

LARGE BASKET STRAINER WITH LOCKING WING NUT | 4T-242

INCLUDES BRASS NUTS AND WASHERS

LARGE BASKET STRAINER AND WING NUT LOCKING STYLE BASKET (4T-243)

FITS 3-1/2" TO 4" OPENING

4-3/8" FLANGE DIAMETER

2-1/2" DEEP WITH 1-1/2" THREAD



4T-242

4T-231 & 4T-242 FINISHES & PRICE GROUPS:

PRICE GROUP A

- Polished Chrome (1)

PRICE GROUP B

- White (13)
- Gloss Black (15)
- Biscuit (16)
- Almond (19)
- Flat Black (20)

PRICE GROUP C

- Polished Brass & PVD (2)
- Antique Brass (3)
- Antique Nickel (Pewter) (4)
- Satin Brass (5)

- Satin Chrome (6)
- Polished Nickel (30)
- Satin Nickel (31)
- Oil Rubbed Bronze (34)
- Stainless/Brushed Nickel (50)

PRICE GROUP D

- Polished Copper (7)
- Uncoated Polished Brass (11)
- Satin Gold (35)
- Antique Copper (36)
- Satin Copper (37)
- Light Brushed Bronze (38)
- Venezian Bronze (47)

SINK & BAR STRAINERS

4T-233, 4T-234 & 4T-235



4T-233

JUNIOR BASKET STRAINER WITH BASKET | 4T-233

INCLUDES BASKET (4T-234)

COMPLETE WITH NUTS & WASHERS

FITS 2" OPENING

2-5/8" DEEP

2-7/8" FLANGE DIAMETER



4T-234

JUNIOR BASKET ONLY | 4T-234

2-1/8" DEEP



4T-235

JUNIOR BASKET WITH 3-PRONG STRAINER | 4T-235

INCLUDES JUNIOR BASKET STRAINER (4T-233) AND 1-7/8" OD 3-PRONG STRAINER (4T-241)

COMPLETE WITH NUTS & WASHERS

FITS 2" OPENING

4T-233, 4T-234 & 4T-235 FINISHES & PRICE GROUPS:

PRICE GROUP A

- Polished Chrome (1)

PRICE GROUP B

- White (13)
- Gloss Black (15)
- Almond (19)
- Flat Black (20)

PRICE GROUP C

- Polished Brass & PVD (2)
- Antique Nickel (Pewter) (4)
- Satin Brass (5)
- Satin Chrome (6)
- Polished Nickel (30)

- Satin Nickel (31)
- Oil Rubbed Bronze (34)
- Stainless/Brushed Nickel (50)

PRICE GROUP D

- Polished Copper (7)
- Polished Gold (8)
- Black Nickel (12)
- Satin Gold (35)
- Antique Copper (36)
- Satin Copper (37)
- Light Brushed Bronze (38)
- Venezian Bronze (47)

SINK & BAR STRAINERS

4T-238 & 4T-240



MIDGET DUO SINK STRAINER WITH BASKET | 4T-238

COMPLETE WITH NUTS & WASHERS

1-1/4" BASKET DEPTH

FITS 2" OPENING

2-3/4" FLANGE DIAMETER

SINK PLUG WITH 3-PRONG STRAINER | 4T-240

COMPLETE WITH NUTS & WASHERS

FOR REGULAR OR BAR SINKS

COARSE THREAD 11-1/2" PER INCH

FITS 2" OPENING

1-9/16" DEEP

2-7/8" FLANGE DIAMETER



4T-238 & 4T-240 FINISHES & PRICE GROUPS:

PRICE GROUP A

- Polished Chrome (1)

PRICE GROUP B

- White (13)
- Gloss Black (15)
- Biscuit (16)
- Almond (19)
- Flat Black (20)

PRICE GROUP C

- Polished Brass & PVD (2)
- Antique Brass (3)
- Satin Brass (5)
- Satin Chrome (6)

- Polished Nickel (30)

- Satin Nickel (31)

- Oil Rubbed Bronze (34)

- Stainless/Brushed Nickel (50)

PRICE GROUP D

- Black Nickel (12)

- Satin Gold (35)

- Antique Copper (36)

- Satin Copper (37)

- Venezian Bronze (47)

LOTION/SOAP DISPENSERS

4T-215, 4T-215B & 4T-215C

All Lotion/Soap Dispensers include a 13 oz plastic bottle



4T-215

ECONOMY LOTION/SOAP DISPENSER | 4T-215

SOLID BRASS - 8" STRAW



4T-215B

HEAVY DUTY LOTION/SOAP DISPENSER | 4T-215B

SOLID BRASS - 9" STRAW



4T-215C

DECORATIVE HOOK STYLE LOTION/SOAP DISPENSER | 4T-215C

SOLID BRASS - 9" STRAW

4T-215, 4T-215B & 4T-215C FINISHES & PRICE GROUPS:

PRICE GROUP A

- Polished Chrome (1)

PRICE GROUP B

- White (13)
- Gloss Black (15)
- Biscuit (16)
- Almond (19)
- Flat Black (20)

PRICE GROUP C

- Polished Brass & PVD (2)
- Antique Brass (3)
- Antique Nickel (Pewter) (4)
- Satin Brass (5)
- Satin Chrome (6)
- Polished Nickel (30)
- Satin Nickel (31)
- Oil Rubbed Bronze (34)
- Stainless/Brushed Nickel (50)

PRICE GROUP D

- Antique Bronze (33)
- Satin Gold (35)
- Antique Copper (36)
- Light Brushed Bronze (38)
- Venezian Bronze (47)

LOTION DISPENSERS EXTENSIONS 4T-215-KIT & 4T-215BC-KIT



EXTENSION KIT FOR 4T-215

4T-215-KIT

APPROX. 2-1/4" NIPPLE FOR THICKER

COUNTERTOPS - 8" STRAW

EXTENSION KIT FOR 4T-215B

& 4T-215C | 4T-215BC-KIT

APPROX. 2-1/4" NIPPLE FOR THICKER

COUNTERTOPS - 9" STRAW

PRICE GROUP A

WATER DISPENSERS

4T-216, 4T-218 & 4T-217 Plus REPAIR KIT 4T-216-KIT

6" WATER DISPENSER FOR FILTERED WATER | 4T-216

7/16" DIAMETER HOLE REQUIRED FOR INSTALLATION

INPUT FOR 1/4" COMPRESSION FAUCET PART ONLY FOR FILTERED WATER



4T-216

8" WATER DISPENSER FOR FILTERED WATER | 4T-218

FAUCET PART ONLY FOR FILTERED WATER

2-1/2" SPUD FOR THICKER COUNTERTOPS



4T-218

10" WATER DISPENSER FOR FILTERED WATER | 4T-217

FAUCET PART ONLY FOR FILTERED WATER

2-1/2" SPUD FOR THICKER COUNTERTOPS



4T-217

PLEASE NOTE* WATER DISPENSERS ARE NOT USABLE AS AN INSTANT HOT OR REVERSE OSMOSIS



REPAIR KIT FOR 216, 217 & 218 | 4T-216-KIT
INCLUDES HANDLE, SPRING, O-RING AND NUT

PRICE GROUP A

4T-216, 4T-218 & 4T-217 FINISHES & PRICE GROUPS:

PRICE GROUP A

- Polished Chrome (1)

PRICE GROUP B

- White (13)
- Flat Black (20)

PRICE GROUP C

- Polished Brass & PVD (2)
- Polished Nickel (30)
- Satin Nickel (31)
- Oil Rubbed Bronze (34)
- Stainless/Brushed Nickel (50)

PRICE GROUP D

- Antique Bronze (33)
4T-217 & 4T-218 only
- Satin Gold (35)
4T-216 & 4T-218 only
- Antique Copper (36)
4T-216 & 4T-218 only
- Light Brushed Bronze (38)
- Venezian Bronze (47)

DRAIN TRIM SETS

4T-030, 4T-040 & 4T-3040



4T-030

DRAIN TRIM SET | 4T-030

Includes GRILL (4T-031)

CROWN (4T-032)

SCREWS (4T-033)

FITS PLUMBING PRODUCTS, PASCO AND AMERICAN

BRASS & ALUMINUM DRAINS

GRILL IS 3-3/8" OD DIAMETER

SCREW HOLES ARE 2-7/8" CENTER-TO-CENTER



4T-040

TILE SQUARE | 4T-040

4-1/4" OD - 3-5/8" ID

FITS PLUMBING PRODUCTS DRAINS

4T-3040



PLUMBING PRODUCTS DRAIN TRIM SET | 4T-3040

INCLUDES DRAIN TRIM SET (4T-030) WITH TILE SQUARE (4T-040)

4T-030, 4T-040 & 4T-3040 FINISHES & PRICE GROUPS:

PRICE GROUP A

- Polished Chrome (1)

PRICE GROUP B

- White (13)
- Almond (19)
- Flat Black (20)

PRICE GROUP C

- Polished Brass & PVD (2)
- Antique Brass (3)
- Antique Nickel (Pewter) (4)
- Satin Brass (5)
- Satin Chrome (6)
- Polished Nickel (30)

- Satin Nickel (31)
- Oil Rubbed Bronze (34)
- Stainless/Brushed Nickel (50)

PRICE GROUP D

- Polished Gold (8)
4T-030 only
- Light Gold (32)
- Antique Bronze (33)
4T-030 only
- Satin Gold (35)
- Light Brushed Bronze (38)
- Aged Pewter (40)
- Venezian Bronze (47)

DRAIN TRIM SETS

4T-029, 4T-2940, 4T-042, & 4T-4240

DRAIN TRIM SET W/ SNAP IN STRAINER | 4T-029

INCLUDES 3-1/4" STRAINER (4T-045) AND CROWN (4T-046)

FITS FRANK PATTERN (INSTANT SET) SHOWER DRAIN



4T-029

DELUXE TRIM SET W/ TILE SQUARE | 4T-2940

INCLUDES DRAIN TRIM SET (4T-029) WITH TILE SQUARE (4T-040)

FITS FRANK PATTERN (INSTANT SET) SHOWER DRAIN



4T-2940

DRAIN TRIM SET | 4T-042

INCLUDES GRILL (4T-031), CROWN (4T-042GC) AND SCREWS (4T-033)

FITS OATEY

GRILL IS 3-3/8" OD DIAMETER

SCREW HOLES ARE 2-7/8" CENTER-TO-CENTER



4T-042

DRAIN TRIM SET | 4T-4240

INCLUDES DRAIN TRIM SET (4T-042) AND TILE SQUARE (4T-040)

FITS OATEY



4T-4240

4T-029, 4T-2940, 4T-042, & 4T-4240 FINISHES & PRICE GROUPS:

PRICE GROUP A

- Polished Chrome (1)

PRICE GROUP B

- White (13)
- Biscuit (16)
- Almond (19)
- Flat Black (20)

PRICE GROUP C

- Polished Brass & PVD (2)
- Antique Brass (3)
- Antique Nickel (Pewter) (4)
- Satin Brass (5)

- Satin Chrome (6)

- Polished Nickel (30)
- Satin Nickel (31)
- Oil Rubbed Bronze (34)
- Stainless/Brushed Nickel (50)

PRICE GROUP D

- Satin Gold (35)
- Light Brushed Bronze (38)
- Aged Pewter (40)
- Venezian Bronze (47)

DRAIN TRIM SETS

4T-090 & 4T-091



4T-090

DRAIN TRIM SET | 4T-090

GRILL (4T-092) AND SCREWS (4T-094 & 4T-095)

FITS PLASTIC ODDITIES RECEPTOR DRAINS, C.P. INDUSTRIES, RICHMOND FOUNDRY,
PRIER BRASS AND RAPID FIT DRAINS

4" DIAMETER

SCREW HOLES ARE 3-3/8" CENTER-TO-CENTER



4T-091

DRAIN TRIM SET | 4T-091

GRILL (4T-093) AND SCREWS (4T-094 & 4T-095)

FITS PLASTIC ODDITIES SHOWER DRAIN AND SIOUX CHIEF
4-1/4" DIAMETER

SCREW HOLES ARE 2-5/8" CENTER-TO-CENTER

4T-090 & 4T-091 FINISHES & PRICE GROUPS:

PRICE GROUP A

- Polished Chrome (1)

PRICE GROUP B

- White (13)
- Gloss Black (15) 4T-091 only
- Biscuit (16)
- Almond (19)
- Flat Black (20)

PRICE GROUP C

- Polished Brass & PVD (2)
- Antique Brass (3)
- Antique Nickel (Pewter) (4)
- Satin Brass (5)
- Satin Chrome (6)

- Polished Nickel (30)
- Satin Nickel (31)
- Oil Rubbed Bronze (34)
- Stainless/Brushed Nickel (50)

PRICE GROUP D

- Polished Copper (7)
- Polished Gold (8)
- Uncoated Polished Brass (11)
- Light Gold (32)
- Antique Bronze (33)
- Satin Gold (35)
- Antique Copper (36)
- Light Brushed Bronze (38)
- Aged Pewter (40)
- Venezan Bronze (47)

TRIM SET/GRILL

4T-034 & 4T-031

3-3/8" GRILL SET | 4T-034

GRILL (4T-031) & SCREWS (4T-033)
FITS PLUMBING PRODUCTS, PASCO, OATEY AND AMERICAN
BRASS & ALUMINUM DRAINS
SCREW HOLES ARE 2-7/8" CENTER-TO-CENTER

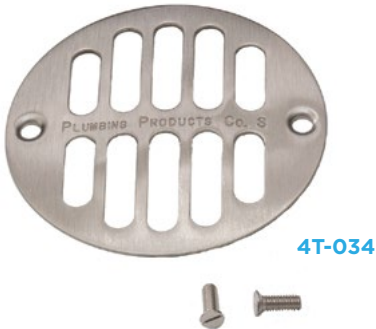

3-3/8" OD GRILL ONLY | 4T-031

SCREWS NOT INCLUDED
FITS PLUMBING PRODUCTS, PASCO, AMERICAN BRASS & ALUMINUM
AND OATEY DRAINS
SCREW HOLES ARE 2-7/8" CENTER-TO-CENTER



4T-034 & 4T-031 FINISHES & PRICE GROUPS:

<p>PRICE GROUP A</p> <ul style="list-style-type: none">• Polished Chrome (1)	<ul style="list-style-type: none">• Satin Chrome (6)• Polished Nickel (30)• Satin Nickel (31)• Oil Rubbed Bronze (34)• Stainless/Brushed Nickel (50)
<p>PRICE GROUP B</p> <ul style="list-style-type: none">• White (13)• Almond (19)• Flat Black (20)	<p>PRICE GROUP D</p> <ul style="list-style-type: none">• Polished Gold (8)• Antique Bronze (33)• Satin Gold (35)• Light Brushed Bronze (38)• Aged Pewter (40)• Venezian Bronze (47)
<p>PRICE GROUP C</p> <ul style="list-style-type: none">• Polished Brass & PVD (2)• Antique Brass (3)• Antique Nickel (Pewter) (4)• Satin Brass (5)	

TILE SQUARES

4T-039 & 4T-040



4T-039

TILE SQUARE | 4T-039

5-3/4" OD - 4-3/8" ID

FITS PLUMBING PRODUCTS DRAINS



4T-040

TILE SQUARE | 4T-040

4-1/4" OD - 3-5/8" ID

FITS PLUMBING PRODUCTS DRAINS

4T-039 & 4T-040 FINISHES & PRICE GROUPS:

PRICE GROUP A

- Polished Chrome (1)

PRICE GROUP B

- White (13)
- Almond (19)
- Flat Black (20)

PRICE GROUP C

- Polished Brass & PVD (2)
- Antique Brass (3)
- Antique Nickel (Pewter) (4)
- Satin Brass (5)
- Satin Chrome (6)
- Polished Nickel (30)

- Satin Nickel (31)
- Oil Rubbed Bronze (34)
- Stainless/Brushed Nickel (50)

PRICE GROUP D

- Antique Bronze (33)
4T-039 only
- Satin Gold (35)
- Antique Copper (36)
4T-039 only
- Light Brushed Bronze (38)
- Aged Pewter (40)
- Venezian Bronze (47)

SNAP-IN STRAINERS

4T-043

OUR MOST
POPULAR
SNAP-IN
STRAINER

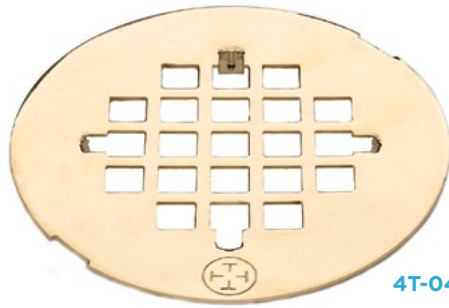

4T-043



4T-043



4T-043

4-1/4" OD SNAP-IN STRAINER | 4T-043

FITS OATEY, INTERCON, B & K IND., PRIER BRASS,
SCHIER, SIOUX CHIEF, SWAN AND AQUA GLASS SHOWER
RECEPTOR DRAINS
PRONG TO PRONG DIAMETER 2-7/8"

4T-043 FINISHES & PRICE GROUPS:

PRICE GROUP A

- Polished Chrome (1)

PRICE GROUP B

- White (13)
- Biscuit (16)
- Almond (19)
- Flat Black (20)

PRICE GROUP C

- Polished Brass & PVD (2)
- Antique Brass (3)
- Antique Nickel (Pewter) (4)
- Satin Brass (5)

- Satin Chrome (6)
- Polished Nickel (30)
- Satin Nickel (31)
- Oil Rubbed Bronze (34)
- Stainless/Brushed Nickel (50)

PRICE GROUP D

- Uncoated Polished Brass (11)
- Satin Gold (35)
- Antique Copper (36)
- Light Brushed Bronze (38)
- Aged Pewter (40)
- Venezeian Bronze (47)

SNAP-IN STRAINERS

4T-041 & 4T-044

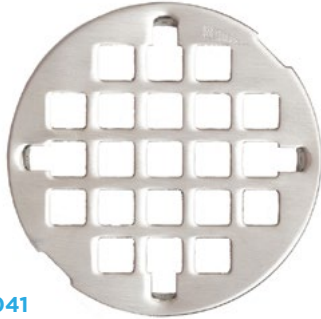

4T-041

SNAP-IN STRAINER | 4T-041

FITS OATEY #109

3-1/4" OD

PRONG-TO-PRONG DIAMETER IS 2-7/8"



4T-044

4-1/4" OD SNAP-IN STRAINER ONLY | 4T-044

FITS SWANSTONE DRAINS AND SIOUX CHIEF

PRONG TO PRONG DIAMETER 2-7/8"

PRONG LENGTH APPROX. 5/8"

4T-041 FINISHES & PRICE GROUPS:

PRICE GROUP A

- Polished Chrome (1)

PRICE GROUP B

- White (13)
- Gloss Black (15)
- Biscuit (16)
- Almond (19)
- Flat Black (20)

PRICE GROUP C

- Polished Brass & PVD (2)
- Antique Brass (3)
- Antique Nickel (Pewter) (4)
- Satin Brass (5)
- Polished Nickel (30)
- Satin Nickel (31)
- Oil Rubbed Bronze (34)
- Stainless/Brushed Nickel (50)

PRICE GROUP D

- Antique Bronze (33)
- Satin Gold (35)
- Light Brushed Bronze (38)
- Venezian Bronze (47)

4T-044 FINISHES & PRICE GROUPS:

PRICE GROUP A

- Polished Chrome (1)

PRICE GROUP B

- Flat Black (20)

PRICE GROUP C

- Polished Brass & PVD (2)
- Antique Nickel (Pewter) (4)
- Satin Chrome (6)
- Satin Nickel (31)
- Oil Rubbed Bronze (34)
- Stainless/Brushed Nickel (50)

SNAP-IN STRAINERS

4T-045 & 4T-047

4T-045 FINISHES & PRICE GROUPS:

PRICE GROUP A

- Polished Chrome (1)

PRICE GROUP B

- White (13)
- Gloss Black (15)
- Biscuit (16)
- Almond (19)
- Flat Black (20)

PRICE GROUP C

- Polished Brass & PVD (2)
- Antique Brass (3)
- Antique Nickel (Pewter) (4)
- Satin Brass (5)
- Satin Chrome (6)
- Polished Nickel (30)
- Satin Nickel (31)
- Oil Rubbed Bronze (34)
- Stainless/Brushed Nickel (50)

PRICE GROUP D

- Uncoated Polished Brass (11)
- Black Nickel (12)
- Antique Bronze (33)
- Satin Gold (35)
- Antique Copper (36)
- Light Brushed Bronze (38)
- Aged Pewter (40)
- Venezian Bronze (47)



4T-045

3-1/4" OD SNAP IN STRAINER | 4T-045

FITS FRANK PATTERN (INSTANT SET) SHOWER DRAIN

PRONG TO PRONG DIAMETER 2-7/8"

4T-047 FINISHES & PRICE GROUPS:

PRICE GROUP A

- Polished Chrome (1)

PRICE GROUP B

- Biscuit (16)
- Almond (19)
- Flat Black (20)

PRICE GROUP C

- Polished Brass & PVD (2)
- Antique Brass (3)
- Antique Nickel (Pewter) (4)
- Satin Brass (5)
- Satin Chrome (6)
- Polished Nickel (30)
- Satin Nickel (31)
- Oil Rubbed Bronze (34)
- Stainless/Brushed Nickel (50)

PRICE GROUP D

- Polished Gold (8)
- Satin Gold (35)
- Satin Copper (37)
- Light Brushed Bronze (38)
- Venezian Bronze (47)



4T-047

4-1/4" OD SNAP-IN STRAINER | 4T-047

FITS AMERICAN BRASS & ALUMINUM SHOWER DRAINS

PRONG-TO-PRONG DIAMETER IS 2-7/8"

SNAP-IN STRAINERS

4T-049 & 4T-049J



4T-049

4-1/2" OD SNAP-IN STRAINER | 4T-049

FITS FIAT CASCADE SHOWER DRAINS

PRONG-TO-PRONG DIAMETER IS 3-1/8"

4T-049 FINISHES & PRICE GROUPS:

PRICE GROUP A

- Polished Chrome (1)

PRICE GROUP B

- White (13)
- Almond (19)
- Flat Black (20)

PRICE GROUP C

- Polished Brass & PVD (2)
- Antique Brass (3)
- Antique Nickel (Pewter) (4)
- Satin Brass (5)
- Satin Chrome (6)
- Polished Nickel (30)
- Satin Nickel (31)
- Oil Rubbed Bronze (34)
- Stainless/Brushed Nickel (50)

PRICE GROUP D

- Antique Bronze (33)
- Satin Gold (35)
- Venezian Bronze (47)



4T-049J

4" OD STRAINER | 4T-049J

FITS FIAT TERRAZZO OR MOLDED STONE SHOWER

FLOORS (MFT)

4T-049J

FINISHES & PRICE GROUPS:

PRICE GROUP A

- Polished Chrome (1)

PRICE GROUP C

- Polished Brass & PVD (2)
- Antique Brass (3)
- Satin Brass (5)
- Satin Nickel (31)
- Oil Rubbed Bronze (34)
- Stainless/Brushed Nickel (50)

SNAP-IN STRAINERS

4T-063 & 4T-0663J

4T-063 FINISHES & PRICE GROUPS:

PRICE GROUP A

- Polished Chrome (1)

PRICE GROUP B

- White (13)
- Gloss Black (15)
- Biscuit (16)
- Almond (19)
- Flat Black (20)

PRICE GROUP C

- Polished Brass & PVD (2)
- Antique Brass (3)
- Satin Brass (5)
- Satin Chrome (6)
- Polished Nickel (30)
- Satin Nickel (31)
- Oil Rubbed Bronze (34)
- Stainless/Brushed Nickel (50)

PRICE GROUP D

- Satin Gold (35)
- Light Brushed Bronze (38)
- Venezian Bronze (47)



4T-063

4-1/4" OD SNAP-IN STRAINER | 4T-063

FITS FLORESTONE SHOWER PAN DRAINS

PRONG-TO-PRONG DIAMETER IS 3"

4T-0663J

FINISHES & PRICE GROUPS:

PRICE GROUP A

- Polished Chrome (1)

PRICE GROUP B

- White (13)
- Biscuit (16)
- Flat Black (20)

PRICE GROUP C

- Polished Brass & PVD (2)
- Antique Brass (3)
- Satin Brass (5)
- Satin Nickel (31)
- Oil Rubbed Bronze (34)
- Stainless/Brushed Nickel (50)

PRICE GROUP D

- Polished Gold (8)
- Satin Gold (35)
- Antique Copper (36)
- Venezian Bronze (47)



4T-0663J

4-5/8" OD SNAP-IN STRAINER | 4T-0663J

FITS MUSTEE SHOWER PANS THAT USE PLASTIC SD

SERIES BASES

PRONG-TO-PRONG DIAMETER IS 3"

LENGTH IS 3/8"

SNAP-IN STRAINERS

4T-077G & 4T-483



4T-077G

4-1/4" OD SNAP-IN STRAINER | 4T-077G

FITS CP INDUSTRIES SHOWER DRAIN AND SIOUX CHIEF 8262-P DRAIN

PRONG-TO-PRONG DIAMETER IS 2-13/16"

4T-077G

FINISHES & PRICE GROUPS:

PRICE GROUP A

- Polished Chrome (1)

PRICE GROUP B

- White (13)
- Gloss Black (15)
- Biscuit (16)
- Almond (19)
- Flat Black (20)

PRICE GROUP C

- Polished Brass & PVD (2)
- Antique Brass (3)
- Antique Nickel (Pewter) (4)
- Satin Chrome (6)
- Polished Nickel (30)
- Satin Nickel (31)
- Oil Rubbed Bronze (34)
- Stainless/Brushed Nickel (50)

PRICE GROUP D

- Polished Gold (8)
- Satin Gold (35)
- Light Brushed Bronze (38)



4T-483

3" FIT-ALL SNAP-IN STRAINER | 4T-483

FITS MOST 2" PIPES

PRONG LENGTH IS APPROX. 1-1/4"

4T-483

FINISHES & PRICE GROUPS:

PRICE GROUP A

- Polished Chrome (1)

PRICE GROUP B

- White (13)
- Flat Black (20)

PRICE GROUP C

- Polished Brass & PVD (2)
- Antique Brass (3)
- Antique Nickel (Pewter) (4)
- Satin Chrome (6)
- Satin Nickel (31)
- Oil Rubbed Bronze (34)
- Stainless/Brushed Nickel (50)

PRICE GROUP D

- Polished Copper (7)
- Satin Gold (35)

SNAP-IN STRAINERS

4T-048 & 4T-480

4T-048

FINISHES & PRICE GROUPS:

PRICE GROUP A

- Polished Chrome (1)

PRICE GROUP B

- White (13)

PRICE GROUP C

- Polished Brass & PVD (2)
- Antique Nickel (Pewter) (4)
- Satin Chrome (6)
- Satin Nickel (31)
- Oil Rubbed Bronze (34)
- Stainless/Brushed Nickel (50)

PRICE GROUP D

- Polished Copper (7)
- Antique Copper (36)



4T-048

4" FIT-ALL STRAINER | 4T-048

SNAP-IN, FITS MOST 3" PIPES

PRONG LENGTH IS APPROX. 1-1/4"

4T-480

FINISHES & PRICE GROUPS:

PRICE GROUP A

- Polished Chrome (1)

PRICE GROUP C

- Polished Brass & PVD (2)
- Satin Chrome (6)
- Satin Nickel (31)
- Oil Rubbed Bronze (34)
- Stainless/Brushed Nickel (50)

PRICE GROUP D

- Polished Copper (7)



4T-480

5" FIT-ALL SNAP-IN STRAINER | 4T-480

FITS MOST 4" PIPES

PRONG LENGTH IS APPROX. 1-1/4"

CROWNS

4T-032, 4T-042GC & 4T-046



4T-032

3-1/2" OD (3" ID) CROWN | 4T-032

FITS PLUMBING PRODUCTS, PASCO AND AMERICAN BRASS & ALUMINUM DRAINS



4T-042GC

3-5/8" OD (3" ID) CROWN | 4T-042GC

FITS OATEY DRAINS



4T-046

3-1/2" OD (2-7/8" ID) CROWN | 4T-046

FITS FRANK PATTERN (INSTANT SET) SHOWER DRAIN

4T-032 FINISHES & PRICE GROUPS:

PRICE GROUP A

- Polished Chrome (1)

PRICE GROUP B

- White (13)
- Gloss Black (15)
- Biscuit (16)
- Flat Black (20)

PRICE GROUP C

- Polished Brass & PVD (2)
- Antique Brass (3)
- Antique Nickel (Pewter) (4)
- Satin Brass (5)

- Satin Chrome (6)
- Polished Nickel (30)
- Satin Nickel (31)
- Oil Rubbed Bronze (34)
- Stainless/Brushed Nickel (50)

PRICE GROUP D

- Polished Gold (8)
- Antique Bronze (33)
- Satin Gold (35)
- Light Brushed Bronze (38)
- Aged Pewter (40)
- Veneizian Bronze (47)

4T-042GC & 4T-046 FINISHES & PRICE GROUPS:

PRICE GROUP A

- Polished Chrome (1)

PRICE GROUP B

- White (13)
- Gloss Black (15)
- Biscuit (16)
- Almond (19)
- Flat Black (20)

PRICE GROUP C

- Polished Brass & PVD (2)
- Antique Brass (3)
- Antique Nickel (Pewter) (4)
- Satin Brass (5)
- Satin Chrome (6)
- Polished Nickel (30)
- Satin Nickel (31)
- Oil Rubbed Bronze (34)
- Stainless/Brushed Nickel (50)

PRICE GROUP D

- Satin Gold (35)
- Light Brushed Bronze (38)
- Veneizian Bronze (47)

SCREWS

4T-033, 4T-094 & 4T-095

4T-033

FINISHES & PRICE GROUPS:

PRICE GROUP A

- Polished Chrome (1)

PRICE GROUP B

- White (13)
- Gloss Black (15)
- Biscuit (16)
- Almond (19)
- Flat Black (20)

PRICE GROUP C

- Polished Brass & PVD (2)
- Antique Brass (3)
- Antique Nickel (Pewter) (4)
- Satin Brass (5)
- Satin Chrome (6)
- Polished Nickel (30)
- Satin Nickel (31)
- Oil Rubbed Bronze (34)
- Stainless/Brushed Nickel (50)

PRICE GROUP D

- Polished Copper (7)
- Polished Gold (8)
- Antique Bronze (33)
- Satin Gold (35)
- Antique Copper (36)
- Light Brushed Bronze (38)
- Venezian Bronze (47)



4T-033

8-32 X 3/8" FLATHEAD MACHINE SCREW | 4T-033

REPLACEMENT SCREW FOR 4T-030 & 4T-034

SET OF TWO



4T-094

10-24 X 3/8" FLATHEAD MACHINE SCREW | 4T-094

REPLACEMENT SCREW FOR 4T-090

SET OF TWO

4T-094 & 4T-095

FINISHES & PRICE GROUPS:

PRICE GROUP A

- Polished Chrome (1)

PRICE GROUP B

- White (13)
- Biscuit (16)
- Flat Black (20)

PRICE GROUP C

- Polished Brass & PVD (2)
- Antique Brass (3)
- Antique Nickel (Pewter) (4)
- Satin Brass (5)
- Satin Chrome (6)
- Polished Nickel (30)
- Satin Nickel (31)
- Oil Rubbed Bronze (34)
- Stainless/Brushed Nickel (50)

PRICE GROUP D

- Polished Copper (7)
- Polished Gold (8)
- Satin Gold (35)
- Light Brushed Bronze (38)
- Aged Pewter (40)
- Venezian Bronze (47)



4T-095

8 X 3/8" PHILLIPS FLAT HEAD SELF-TAPPING TYPE "A" SCREW | 4T-095

REPLACEMENT SCREW FOR 4T-090

SET OF TWO

SHOWER DRAINS

4T-002, 4T-004, 4T-005, 4T-006, 4T-007 & 4T-5NC

ALL SHOWER DRAINS ARE FACTORY ASSEMBLED WITH 4T-030 DRAIN TRIM SET



1-1/2" IPS EZ TEST CAST IRON SHOWER DRAIN | 4T-002

4T-002



2" IPS EZ TEST CAST IRON SHOWER DRAIN | 4T-004

4T-004



2" CAULK CAST IRON SHOWER DRAIN | 4T-005

4T-005



2" QUICK CAULK CAST IRON SHOWER DRAIN | 4T-006

INCLUDES JIFFY SEAL (4T-2JQ)

4T-006



2" NO HUB DRAIN | 4T-007

NEOPRENE COUPLING NOT INCLUDED

4T-007



2" NO CAULK LOS ANGELES (L. A.)
CODE CAST IRON SHOWER DRAIN
4T-5NC

FOR CAST IRON, STEEL OR PLASTIC PIPE

4T-5NC

SHOWER DRAINS

4T-502A, 4T-503P, 4T-020 & 4T-021

ALL SHOWER DRAINS ARE FACTORY ASSEMBLED WITH 4T-030 DRAIN TRIM SET

2" NO CAULK ABS GLUE ON SHOWER DRAIN | 4T-502A

LA CODE



2" NO CAULK PVC GLUE ON SHOWER DRAIN | 4T-503P

LA CODE

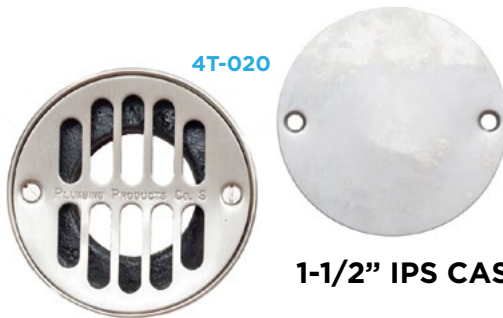

1-1/2" IPS CAST IRON PROTECTION DRAIN | 4T-020

2" IPS CAST IRON PROTECTION DRAIN | 4T-021

4T-002, 4T-004, 4T-005, 4T-006, 4T-007, 4T-5NC, 4T-502A, 4T-503P, 4T-020 & 4T-021 FINISHES & PRICE GROUPS:

PRICE GROUP A

- Polished Chrome (1)

PRICE GROUP B

- White (13)
- Almond (19)
- Flat Black (20)

PRICE GROUP C

- Polished Brass & PVD (2)
- Antique Brass (3)
- Antique Nickel (Pewter) (4)
- Satin Brass (5)
- Satin Chrome (6)

- Polished Nickel (30)
- Satin Nickel (31)
- Oil Rubbed Bronze (34)
- Stainless/Brushed Nickel (50)

PRICE GROUP D

- Polished Gold (8)
- Light Gold (32)
- Antique Bronze (33)
- Satin Gold (35)
- Light Brushed Bronze (38)
- Aged Pewter (40)
- Venezian Bronze (47)



ROMAN TUB DRAINS

4T-055, 4T-062, 4T-064, 4T-065 & 4T-068

ALL THE ROMAN TUB DRAINS COME WITH THE 4T-055 DRAIN TOP



4T-055

ROMAN TUB DRAIN TOP ONLY | 4T-055

INCLUDES CROWN (6CR) AND SCREWS (4T-056)



4T-062

1-1/2" IPS EZ TEST CAST IRON ROMAN TUB DRAIN | 4T-062



4T-064

2" IPS EZ TEST CAST IRON ROMAN TUB DRAIN | 4T-064



4T-065

2" CAULK CAST IRON ROMAN TUB DRAIN | 4T-065



4T-068

2" CAULK CAST IRON PROTECTION DRAIN FOR MARBLE TUBS | 4T-068

ROMAN TUB DRAINS

4T-066A, 4T-5NCTD, 4T-067 & 4T-6420

ALL THE ROMAN TUB DRAINS COME WITH THE 4T-055 DRAIN TOP

2" QUICK CAULK CAST IRON W/ GASKET

ROMAN TUB DRAIN | 4T-066A

RING NOT EXPOSED IN THIS INSTALLATION



4T-066A

2" NO CAULK CAST IRON LOS ANGELES CODE

ROMAN TUB DRAIN | 4T-5NCTD

RING NOT EXPOSED IN THIS INSTALLATION



4T-5NCTD

2" NO HUB CAST IRON ROMAN TUB DRAIN | 4T-067

RING NOT EXPOSED IN THIS INSTALLATION



4T-067

4T-055, 4T-062, 4T-064,
4T-065, 4T-068, 4T-066A,
4T-5NCTD, 4T-067 & 4T-056

FINISHES & PRICE GROUPS:

PRICE GROUP A

- Polished Chrome (1)

PRICE GROUP B

- White (13)
- Flat Black (20)

PRICE GROUP C

- Polished Brass & PVD (2)
- Antique Brass (3)
- Antique Nickel (Pewter) (4)
- Satin Chrome (6)
- Polished Nickel (30)
- Satin Nickel (31)
- Oil Rubbed Bronze (34)
- Stainless/Brushed Nickel (50)

PRICE GROUP D

- Satin Gold (35)
- Light Brushed Bronze (38)
- Venezian Bronze (47)



4T-6420

CHURCH OF LATTER-DAY SAINTS BAPTISMAL

FONT DRAIN PACKAGE | 4T-6420

RING NOT EXPOSED IN THIS INSTALLATION

AVAILABLE IN **POLISHED CHROME ONLY**

PRICE GROUP A



REPLACEMENT SCREWS FOR ROMAN TUB DRAINS

4T-056

TWO PER BAG

TANK LEVERS

4T-190 & 4T-193



4T-190

STANDARD TANK LEVER W/ 8" ARM | 4T-190

FITS MOST STANDARD TOILETS

FRONT MOUNT - LEFT SIDE



4T-193

ARROW TANK LEVER W/ 8" ARM | 4T-193

FITS MOST STANDARD TOILETS

FRONT MOUNT - LEFT SIDE

4T-190 & 4T-193 FINISHES & PRICE GROUPS:

PRICE GROUP A

- Polished Chrome (1)

PRICE GROUP B

- White (13)
- Gloss Black (15)
- Biscuit (16)
- Almond (19)
- Flat Black (20)

PRICE GROUP C

- Polished Brass & PVD (2)
- Antique Brass (3)
- Antique Nickel (Pewter) (4)
- Satin Brass (5)
- Satin Chrome (6)
- Polished Nickel (30)
- Satin Nickel (31)

- Oil Rubbed Bronze (34)

- Stainless/Brushed Nickel (50)

PRICE GROUP D

- Polished Copper (7)
- Polished Gold (8)
- Light Gold (32)
- Antique Bronze (33)
4T-193 only
- Satin Gold (35)
4T-190 only
- Antique Copper (36)
- Light Brushed Bronze (38)
4T-190 only
- Aged Pewter (40)
- Venezian Bronze (47)

TANK LEVERS

4T-224 & 4T-225



TANK LEVER FOR TOTO | 4T-224

FITS CARLYLE, CAROLINA, SUPREME, SUPREME ADA, ULTIMATE,
ULTRAMAX, ADA, CST70414 AND CST704L14
STRAIGHT ARM - SIDE MOUNT



TANK LEVER FOR TOTO | 4T-225

FITS VESPIN, DRAKE AND DRAKE ADA
CURVED ARM - SIDE MOUNT

4T-224 & 4T-225 FINISHES & PRICE GROUPS:

PRICE GROUP A

- Polished Chrome (1)

PRICE GROUP B

- White (13)
- Gloss Black (15)
- Almond (19)
- Flat Black (20)

PRICE GROUP C

- Polished Brass & PVD (2)
- Antique Brass (3)
- Antique Nickel (Pewter) (4)

- Satin Chrome (6)
- Polished Nickel (30)
- Satin Nickel (31)
- Oil Rubbed Bronze (34)
- Stainless/Brushed Nickel (50)

PRICE GROUP D

- Polished Gold (8)
- Light Gold (32)
- Satin Gold (35)
- Antique Copper (36)
- Light Brushed Bronze (38)

TANK LEVERS

4T-194 & 4T-195



4T-194

ANGLE MOUNT TANK LEVER | 4T-194

FITS KOHLER WELLWORTH II AND UNIVERSAL

RUNDLE ATHENS

4T-194

FINISHES & PRICE GROUPS:

PRICE GROUP A

- Polished Chrome (1)

PRICE GROUP B

- White (13)
- Gloss Black (15)
- Biscuit (16)
- Almond (19)
- Flat Black (20)

PRICE GROUP C

- Polished Brass & PVD (2)
- Antique Brass (3)
- Antique Nickel (Pewter) (4)
- Satin Brass (5)
- Satin Chrome (6)
- Polished Nickel (30)
- Satin Nickel (31)
- Oil Rubbed Bronze (34)
- Stainless/Brushed Nickel (50)

PRICE GROUP D

- Polished Gold (8)
- Light Gold (32)
- Antique Bronze (33)
- Satin Gold (35)
- Antique Copper (36)
- Aged Pewter (40)
- Venezian Bronze (47)

4T-195

FINISHES & PRICE GROUPS:

PRICE GROUP A

- Polished Chrome (1)

PRICE GROUP B

- Gloss Black (15)
- Flat Black (20)

PRICE GROUP C

- Polished Brass & PVD (2)
- Antique Nickel (Pewter) (4)
- Satin Chrome (6)
- Polished Nickel (30)
- Satin Nickel (31)
- Oil Rubbed Bronze (34)
- Stainless/Brushed Nickel (50)

PRICE GROUP D

- Polished Gold (8)
- Antique Bronze (33)



4T-195

TANK LEVER W/ 8" ARM | 4T-195

FITS ELJER NEW EMBLEM

TANK LEVERS, CLOSET TANK ELBOW & SLIP JOINT NUT

4T-196, 4T-197 & 4T-198

4T-196

FINISHES & PRICE GROUPS:

PRICE GROUP A

- Polished Chrome (1)

PRICE GROUP B

- White (13)
- Gloss Black (15)
- Biscuit (16)
- Flat Black (20)

PRICE GROUP C

- Polished Brass & PVD (2)
- Antique Brass (3)
- Antique Nickel (Pewter) (4)
- Satin Brass (5)
- Satin Chrome (6)
- Polished Nickel (30)
- Satin Nickel (31)
- Oil Rubbed Bronze (34)
- Stainless/Brushed Nickel (50)

PRICE GROUP D

- Antique Bronze (33)
- Antique Copper (36)
- Aged Pewter (40)
- Venezian Bronze (47)



4T-196

STANDARD TANK LEVER W/ 8" ARM | 4T-196

FITS MOST STANDARD TOILETS

FRONT MOUNT - LEFT SIDE



4T-198

2" X 2" SLIP JOINT NUT | 4T-198



4T-197

CLOSET TANK ELBOW | 4T-197

INCLUDES 2 BRASS SLIP JOINT NUTS (4T-198)

AND WASHERS

MEASURES 2" X 6" X 8"

4T-197 & 4T-198

FINISHES & PRICE GROUPS:

PRICE GROUP A

- Polished Chrome (1)

PRICE GROUP B

- White (13)
- Flat Black (20)

PRICE GROUP C

- Polished Brass & PVD (2)
- Antique Brass (3)
- Antique Nickel (Pewter) (4)
- Satin Brass (5)
- Polished Nickel (30)
- Satin Nickel (31)
- Oil Rubbed Bronze (34)
- Stainless/Brushed Nickel (50)

PRICE GROUP D

- Light Brushed Bronze (38)
- Aged Pewter (40)

LAVATORY DRAINS

4T-245 & 4T-245L



4T-245

MUSHROOM STYLE PLUG | 4T-245

- POP-UP STYLE
- PUSH TO SEAL/RELEASE
- HAS OVERFLOW HOLES
- 2.16" MUSHROOM PLATE

4T-245

FINISHES & PRICE GROUPS:

PRICE GROUP A

- Polished Chrome (1)

PRICE GROUP B

- White (13)
- Flat Black (20)

PRICE GROUP C

- Polished Brass & PVD (2)
- Antique Brass (3)
- Antique Nickel (Pewter) (4)
- Satin Brass (5)
- Polished Nickel (30)
- Satin Nickel (31)
- Oil Rubbed Bronze (34)
- Stainless/Brushed Nickel (50)

PRICE GROUP D

- Uncoated Polished Brass (11)
- Satin Gold (35)
- Antique Copper (36)
- Light Brushed Bronze (38)
- Venezian Bronze (47)

NEW

4T-245L



MUSHROOM STYLE PLUG W/ LARGER PLATE | 4T-245L

- POP-UP STYLE
- PUSH TO SEAL/RELEASE
- HAS OVERFLOW HOLES
- 2.75" MUSHROOM PLATE

4T-245L

FINISHES & PRICE GROUPS:

PRICE GROUP A

- Polished Chrome (1)

PRICE GROUP B

- Flat Black (20)

PRICE GROUP C

- Polished Brass & PVD (2)
- Polished Nickel (30)
- Satin Nickel (31)
- Oil Rubbed Bronze (34)
- Stainless/Brushed Nickel (50)

PRICE GROUP D

- Light Brushed Bronze (38)

LAVATORY DRAINS

4T-246 & 4T-246L

4T-246

FINISHES & PRICE GROUPS:

PRICE GROUP A

- Polished Chrome (1)

PRICE GROUP B

- White (13)
- Gloss Black (15)
- Flat Black (20)

PRICE GROUP C

- Polished Brass & PVD (2)
- Antique Brass (3)
- Antique Nickel (Pewter) (4)
- Satin Brass (5)
- Polished Nickel (30)
- Satin Nickel (31)
- Oil Rubbed Bronze (34)
- Stainless/Brushed Nickel (50)

PRICE GROUP D

- Uncoated Polished Brass (11)
- Antique Bronze (33)
- Satin Gold (35)
- Antique Copper (36)
- Light Brushed Bronze (38)
- Venezian Bronze (47)

MUSHROOM STYLE PLUG | 4T-246

POP-UP STYLE

PUSH TO SEAL/RELEASE

NO OVERFLOW HOLE

2.16" MUSHROOM PLATE



4T-246

4T-246L

FINISHES & PRICE GROUPS:

PRICE GROUP A

- Polished Chrome (1)

PRICE GROUP B

- Flat Black (20)

PRICE GROUP C

- Polished Brass & PVD (2)
- Antique Brass (3)
- Satin Brass (5)
- Polished Nickel (30)
- Satin Nickel (31)
- Oil Rubbed Bronze (34)
- Stainless/Brushed Nickel (50)

PRICE GROUP D

- Satin Gold (35)
- Light Brushed Bronze (38)
- Venezian Bronze (47)

MUSHROOM STYLE PLUG WITH LARGER PLATE

4T-246L

POP-UP STYLE

PUSH TO SEAL/RELEASE

NO OVERFLOW HOLE

LARGE MUSHROOM STYLE PLATE

2.75" DIAMETER

NEW



4T-246L

LAVATORY DRAINS

4T-251 & 4T-251N



4T-251

2 PIECE PO PLUG GRID DRAIN | 4T-251

ALL PARTS ARE PLATED - HAS OVERFLOW HOLES

FITS 1-1/2" OPENING

TAILPIECE IS 1-1/4" OD X 8"



4T-251N

2 PIECE CO PLUG GRID DRAIN | 4T-251N

ALL PARTS ARE PLATED - NO OVERFLOW HOLES

FITS 1-1/2" OPENING

TAILPIECE IS 1-1/4" OD X 8"

4T-251 & 4T-251N FINISHES & PRICE GROUPS:

PRICE GROUP A

- Polished Chrome (1)

PRICE GROUP B

- White (13)
- Gloss Black (15)
- Flat Black (20)

PRICE GROUP C

- Polished Brass & PVD (2)
- Antique Brass (3)
- Antique Nickel (Pewter) (4)
- Satin Brass (5)
- Satin Chrome (6)
- Polished Nickel (30)
- Satin Nickel (31)

- Oil Rubbed Bronze (34)
- Stainless/Brushed Nickel (50)

PRICE GROUP D

- Polished Copper (7)
- Uncoated Polished Brass (11)
- Black Nickel (12)
4T-251N only
- Antique Bronze (33)
- Satin Gold (35)
- Antique Copper (36)
- Satin Copper (37)
- Light Brushed Bronze (38)
- Aged Pewter (40)
- Venezian Bronze (47)

LAVATORY DRAINS

4T-253 & 4T-253N

2 PIECE LIFT & TURN | 4T-253

ALL PARTS PLATED - HAS OVERFLOW HOLES

FITS 1-1/2" OPENING

TAILPIECE IS 1-1/4" OD X 8"



4T-253N

2 PIECE LIFT & TURN | 4T-253N

ALL PARTS PLATED - NO OVERFLOW HOLES

FITS 1-1/2" OPENING

TAILPIECE IS 1-1/4" OD X 8"

4T-253 & 4T-253N FINISHES & PRICE GROUPS:

PRICE GROUP A

- Polished Chrome (1)

PRICE GROUP B

- White (13)
- Flat Black (20)

PRICE GROUP C

- Polished Brass & PVD (2)
- Antique Brass (3)
- Antique Nickel (Pewter) (4)
- Satin Brass (5)
- Satin Chrome (6)
- Polished Nickel (30)

- Satin Nickel (31)
- Oil Rubbed Bronze (34)
- Stainless/Brushed Nickel (50)

PRICE GROUP D

- Uncoated Polished Brass (11)
- Antique Bronze (33)
- Satin Gold (35)
- Antique Copper (36)
- Satin Copper (37)
- 4T-253N only
- Light Brushed Bronze (38)
- Venezeian Bronze (47)

LAVATORY DRAINS

4T-247 & 4T-249



4T-247

POP-UP LAVATORY DRAIN ASSEMBLY | 4T-247

ALL VISIBLE PARTS ARE PLATED
FITS 1-1/2" OPENING SIZE 1-1/4" OD X 8"
HAS OVERFLOW HOLES



4T-247

FINISHES & PRICE GROUPS:

PRICE GROUP A

- Polished Chrome (1)

PRICE GROUP B

- White (13)
- Biscuit (16)
- Almond (19)
- Flat Black (20)

PRICE GROUP C

- Polished Brass & PVD (2)
- Antique Brass (3)
- Antique Nickel (Pewter) (4)
- Satin Brass (5)
- Satin Chrome (6)
- Polished Nickel (30)
- Satin Nickel (31)
- Oil Rubbed Bronze (34)
- Stainless/Brushed Nickel (50)

PRICE GROUP D

- Polished Gold (8)
- Uncoated Polished Brass (11)
- Satin Gold (35)
- Antique Copper (36)
- Light Brushed Bronze (38)
- Venezian Bronze (47)

4T-249

FINISHES & PRICE GROUPS:

PRICE GROUP A

- Polished Chrome (1)

PRICE GROUP B

- Flat Black (20)

PRICE GROUP C

- Polished Brass & PVD (2)
- Antique Brass (3)
- Antique Nickel (Pewter) (4)
- Satin Chrome (6)
- Polished Nickel (30)
- Satin Nickel (31)
- Oil Rubbed Bronze (34)
- Stainless/Brushed Nickel (50)

PRICE GROUP D

- Uncoated Polished Brass (11)
- Satin Gold (35)
- Antique Copper (36)

4T-249



MUSHROOM STYLE FIXED CO PLUG

4T-249

STATIONARY - NON SEALING

NO OVERFLOW HOLES

2-3/4" DIAMETER PLATE

LAVATORY DRAINS & VESSEL SPACER

4T-250 & 4T-701

4T-250

FINISHES & PRICE GROUPS:

PRICE GROUP A

- Polished Chrome (1)

PRICE GROUP B

- Gloss Black (15)
- Almond (19)

PRICE GROUP C

- Polished Brass & PVD (2)
- Antique Brass (3)
- Polished Nickel (30)
- Satin Nickel (31)
- Oil Rubbed Bronze (34)

PRICE GROUP D

- Polished Copper (7)
- Satin Gold (35)
- Venezian Bronze (47)



4T-250

1 PIECE PLUG | 4T-250

INCLUDES CHAIN & STOPPER (4T-175SC)

CRUMB CUP (4T-252) SIZE 1-1/4" OD X 6-1/4"

FITS 1-1/2" OPENING



4T-701

VESSEL SPACER | 4T-701

1-3/4" ID

4" OD X 11/16" TALL

4T-701

FINISHES & PRICE GROUPS:

PRICE GROUP A

- Polished Chrome (1)

PRICE GROUP B

- White (13)
- Flat Black (20)

PRICE GROUP C

- Polished Brass & PVD (2)
- Antique Brass (3)
- Satin Brass (5)
- Satin Chrome (6)
- Polished Nickel (30)
- Satin Nickel (31)
- Oil Rubbed Bronze (34)
- Stainless/Brushed Nickel (50)

PRICE GROUP D

- Satin Gold (35)
- Antique Copper (36)
- Light Brushed Bronze (38)
- Aged Pewter (40)
- Venezian Bronze (47)

P-TRAPS (17 GAUGE)

4T-254 & 4T-254K



4T-254

1-1/4" X 1-1/4" P-TRAP | 4T-254

INCLUDES 4T-259 FLANGE



4T-254K

1-1/4" X 1-1/4" P-TRAP WITH 14" WALL BEND | 4T-254K

INCLUDES 4T-259 FLANGE

4T-254 & 4T-254K FINISHES & PRICE GROUPS:

PRICE GROUP A

- Polished Chrome (1)

PRICE GROUP B

- White (13)
- Biscuit (16)
- Flat Black (20)

PRICE GROUP C

- Polished Brass & PVD (2)
- Antique Brass (3)
- Antique Nickel (Pewter) (4)
- Satin Brass (5)
- Satin Chrome (6)
- Polished Nickel (30)
- Satin Nickel (31)
- Oil Rubbed Bronze (34)
- Stainless/Brushed Nickel (50)

PRICE GROUP D

- Polished Copper (7)
4T-254 only
- Polished Gold (8)
4T-254 only
- Uncoated Polished Brass (11)
- Light Gold (32)
4T-254 only
- Antique Bronze (33)
- Satin Gold (35)
- Antique Copper (36)
- Light Brushed Bronze (38)
- Aged Pewter (40)
4T-254 only
- Venezian Bronze (47)

P-TRAPS (17 GAUGE)

4T-2566, 4T-2566K & 4T-2551D

1-1/2" X 1-1/2" P-TRAP | 4T-2566

INCLUDES 4T-258 FLANGE



1-1/2" X 1-1/2" P-TRAP WITH 14" WALL BEND | 4T-2566K

INCLUDES 4T-258 FLANGE



1-1/2" X 1-1/4" REDUCED NUT P-TRAP | 4T-2551D

INCLUDES 4T-258 FLANGE



4T-2566, 4T-2566K & 4T-2551D FINISHES & PRICE GROUPS:

PRICE GROUP A

- Polished Chrome (1)

PRICE GROUP B

- Gloss Black (15)
- Flat Black (20)

PRICE GROUP C

- Polished Brass & PVD (2)
- Antique Brass (3)
- Antique Nickel (Pewter) (4)
- Satin Brass (5)
- Satin Chrome (6)
- Polished Nickel (30)

- Satin Nickel (31)
- Oil Rubbed Bronze (34)
- Stainless/Brushed Nickel (50)

PRICE GROUP D

- Uncoated Polished Brass (11)
- Satin Gold (35)
- Antique Copper (36)
- Light Brushed Bronze (38)
- Aged Pewter (40)
- 4T-2566 & 4T-2551D only
- Venezian Bronze (47)

P-TRAPS (17 GAUGE)

4T-255D & 4T-2565



4T-255D

1-1/2" X 1-1/4" REDUCED NECK P-TRAP | 4T-255D

INCLUDES 4T-258 FLANGE



4T-2565

1-1/4" X 1-1/4" P-TRAP W/ CLEANOUT | 4T-2565

INCLUDES 4T-259 FLANGE

4T-255D & 4T-2565 FINISHES & PRICE GROUPS:

PRICE GROUP A

- Polished Chrome (1)

PRICE GROUP B

- White (13)
- Flat Black (20)

PRICE GROUP C

- Polished Brass & PVD (2)
- Antique Brass (3)
- Satin Chrome (6)
- Polished Nickel (30)

- Satin Nickel (31)
- Oil Rubbed Bronze (34)
- Stainless/Brushed Nickel (50)

PRICE GROUP D

- Uncoated Polished Brass (11)
- Satin Gold (35)
- Antique Copper (36)
- Light Brushed Bronze (38)
4T-255D only
- Venezian Bronze (47)

DECORATIVE BOTTLE TRAP

4T-2577



4T-2577

1-1/4" X 1-1/4" ROUND BRASS P-TRAP | 4T-2577

12" WALL ARM

ROUND WALL FLANGE & CLEANOUT

4T-2577

FINISHES & PRICE GROUPS:

PRICE GROUP A

- Polished Chrome (1)

PRICE GROUP B

- Flat Black (20)

PRICE GROUP C

- Polished Brass & PVD (2)
- Satin Brass (5)
- Polished Nickel (30)
- Satin Nickel (31)
- Oil Rubbed Bronze (34)
- Stainless/Brushed Nickel (50)

PRICE GROUP D

- Satin Gold (35)
- Light Brushed Bronze (38)

S-TRAPS (17 GAUGE)

4T-3648, 4T-3649 & 4T-3650



4T-3648

1-1/4" X 1-1/4" 17 G S-TRAP | 4T-3648

INCLUDES

- FLANGE (4T-259)
- 2 SLIP JOINT NUTS (4T-300)
- 2 WASHERS (SJ7W)

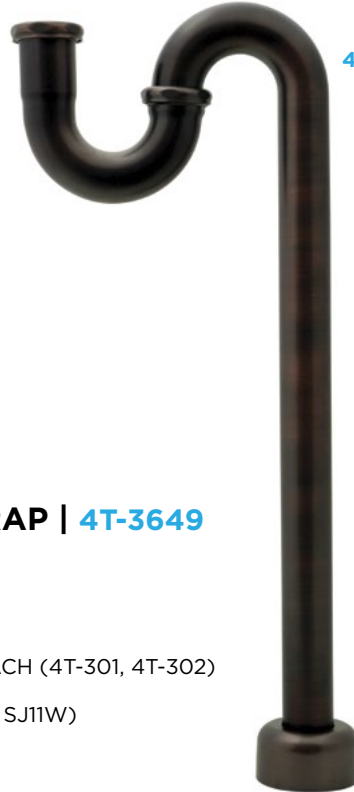

4T-3649

1-1/2" X 1-1/4" 17 G S-TRAP | 4T-3649

INCLUDES

- FLANGE (4T-258)
- TWO SLIP JOINT NUTS ONE EACH (4T-301, 4T-302)
- 2 WASHERS ONE EACH (SJ9W, SJ11W)

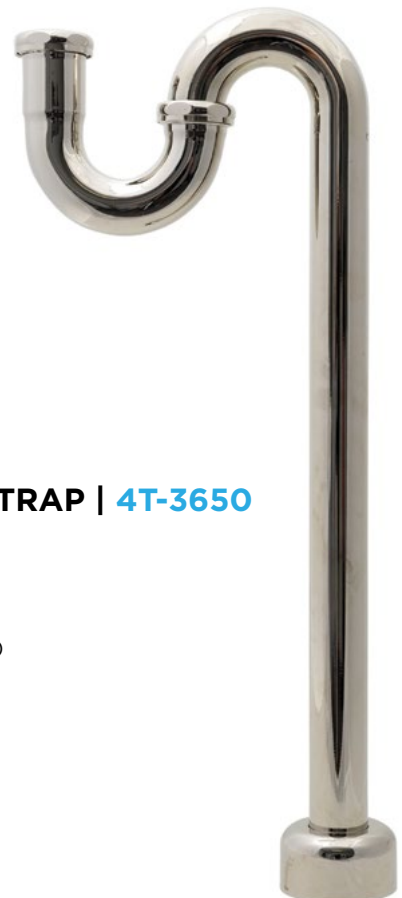

4T-3650

1-1/2" X 1-1/2" 17 G S-TRAP | 4T-3650

INCLUDES

- FLANGE (4T-258)
- 2 SLIP JOINT NUTS (4T-302)
- 2 WASHERS (SJ11W)

4T-3648, 4T-3649 & 4T-3650 FINISHES & PRICE GROUPS:

PRICE GROUP A

- Polished Chrome (1)

PRICE GROUP C

- Polished Brass & PVD (2)
- Polished Nickel (30)
- Satin Nickel (31)
- Oil Rubbed Bronze (34)
- Stainless/Brushed Nickel (50)

PRICE GROUP D

- Satin Gold (35)
4T-3648 & 4T-3650 only
- Light Brushed Bronze (38)
4T-3648 only

SLIP JOINT EXTENSION TUBES

4T-267, 4T-267A, 4T-268 & 4T-268A

1-1/2" OD X 8" SLIP JOINT EXTENSION TUBE | 4T-267

NUT (4T-302)

WASHER (SJ11W)



4T-267

1-1/2" OD X 12" SLIP JOINT EXTENSION TUBE | 4T-267A

NUT (4T-302)

WASHER (SJ11W)



4T-267A

1-1/4" OD X 8" SLIP JOINT EXTENSION TUBE | 4T-268

NUT (4T-300)

WASHER (SJ7W)



4T-268

1-1/4" OD X 12" SLIP JOINT EXTENSION TUBE | 4T-268A

NUT (4T-300)

WASHER (SJ7W)



4T-268A

4T-267, 4T-267A, 4T-268 & 4T-268A FINISHES & PRICE GROUPS:

PRICE GROUP A

- Polished Chrome (1)

PRICE GROUP B

- Flat Black (20)

PRICE GROUP C

- Polished Brass & PVD (2)
- Antique Brass (3)
- Antique Nickel (Pewter) (4)
- Satin Brass (5)
- Satin Chrome (6)

- Polished Nickel (30)
- Satin Nickel (31)
- Oil Rubbed Bronze (34)
- Stainless/Brushed Nickel (50)

PRICE GROUP D

- Uncoated Polished Brass (11)
- Satin Gold (35)
- Antique Copper (36)
- Light Brushed Bronze (38)
- Venezian Bronze (47)

TAILPIECES

4T-367, 4T-368, 4T-369, 4T-370 & 4T-371



4T-367

FLANGED SINK TAILPIECE | 4T-367

1-1/2" OD X 8"



4T-368

THREADED TAILPIECE | 4T-368

1-1/4" OD X 8"

THREADED ON BOTH ENDS



4T-369

THREADED TAILPIECE | 4T-369

1-1/4" OD X 12"

THREADED ON BOTH ENDS



4T-370

THREADED TAILPIECE | 4T-370

1-1/2" OD X 8"

THREADED ON BOTH ENDS



4T-371

THREADED TAILPIECE | 4T-371

1-1/2" OD X 12"

THREADED ON BOTH ENDS

4T-367, 4T-368, 4T-369, 4T-370 & 4T-371

FINISHES & PRICE GROUPS:

PRICE GROUP A

- Polished Chrome (1)

PRICE GROUP B

- Flat Black (20)

PRICE GROUP C

- Polished Brass & PVD (2)
- Antique Brass (3)
- Satin Brass (5)
- Polished Nickel (30)

- Satin Nickel (31)

- Oil Rubbed Bronze (34)

- Stainless/Brushed Nickel (50)

PRICE GROUP D

- Uncoated Polished Brass (11)

- Satin Gold (35)

- 4T-367, 4T-368 & 4T-369 only

- Light Brushed Bronze (38)

- Venetian Bronze (47)

SLIP JOINT ELBOWS

4T-628, 4T-629 & 4T-682

1-1/4" OD X 8" SLIP JOINT ELBOW | 4T-628

NUT (4T-300) AND WASHER (SJ7W)



4T-628

1-1/2" OD X 8" SLIP JOINT ELBOW | 4T-629

NUT (4T-302) AND WASHER (SJ11W)



4T-629

1-1/2" OD X 14" SLIP JOINT ELBOW | 4T-682

NUT (4T-302) AND WASHER (SJ11W)



4T-682

4T-628, 4T-629 & 4T-682 FINISHES & PRICE GROUPS:

PRICE GROUP A

- Polished Chrome (1)

PRICE GROUP B

- Flat Black (20)

PRICE GROUP C

- Polished Brass & PVD (2)
- Polished Nickel (30)

- Satin Nickel (31)

- Oil Rubbed Bronze (34)

- Stainless/Brushed Nickel (50)

PRICE GROUP D

- Uncoated Polished Brass (11)

DOUBLE OFFSETS & SLIP JOINT NUTS

4T-630, 4T-631, 4T-300, 4T-301 & 4T-302

4T-630 & 4T-631 FINISHES & PRICE GROUPS:

PRICE GROUP A

- Polished Chrome (1)

PRICE GROUP B

- Flat Black (20)

PRICE GROUP C

- Polished Brass & PVD (2)
- Antique Brass (3)
- Polished Nickel (30)
- Satin Nickel (31)
- Oil Rubbed Bronze (34)
- Stainless/Brushed Nickel (50)

PRICE GROUP D

- Uncoated Polished Brass (11)
- Venezian Bronze (47)



4T-630

1-1/4" OD DOUBLE OFFSET | 4T-630

2 SLIP JOINT NUTS (4T-300)

2 NEOPRENE WASHERS

22 GAUGE

12" DOUBLE OFFSET



4T-631

1-1/2" OD DOUBLE OFFSET | 4T-631

2 SLIP JOINT NUTS (4T-302)

2 NEOPRENE WASHERS

22 GAUGE

12" DOUBLE OFFSET



4T-300

1-1/4" X 1-1/4" SLIP JOINT NUT | 4T-300

INCLUDES WASHER (SJ7W)



4T-301

1-1/2" X 1-1/4" SLIP JOINT NUT

4T-301

INCLUDES WASHER (SJ9W)



4T-302

1-1/2" X 1-1/2" SLIP JOINT NUT

4T-302

INCLUDES WASHER (SJ11W)

4T-300, 4T-301 & 4T-302 FINISHES & PRICE GROUPS:

PRICE GROUP A

- Polished Chrome (1)

PRICE GROUP B

- White (13)
- Gloss Black (15)
- Biscuit (16)
- Almond (19)
- Flat Black (20)

PRICE GROUP C

- Polished Brass & PVD (2)
- Antique Brass (3)
- Antique Nickel (Pewter) (4)
- Satin Brass (5)
- Satin Chrome (6)
- Polished Nickel (30)

- Satin Nickel (31)

- Oil Rubbed Bronze (34)
- Stainless/Brushed Nickel (50)

PRICE GROUP D

- Polished Copper (7)
- Uncoated Polished Brass (11)
- Black Nickel (12)
- Light Gold (32)
- Antique Bronze (33)
- Satin Gold (35)
- Antique Copper (36)
- Satin Copper (37)
- Light Brushed Bronze (38)
- Aged Pewter (40)
- Venezian Bronze (47)

COVER CASINGS

4T-265, 4T-265A, 4T-265G, 4T-283 & 4T-283C

4T-265, 4T-265A & 4T-265G FINISHES & PRICE GROUPS:

PRICE GROUP A

- Polished Chrome (1)

PRICE GROUP C

- Polished Brass & PVD (2)
- Polished Nickel (30)
- Satin Nickel (31)
- Oil Rubbed Bronze (34)
- Stainless/Brushed Nickel (50)

2" OD X 10" COVER CASING

4T-265

COVERS 1-1/2" IPS

STEEL PIPE

BRASS BASE METAL

1-14/16" ID

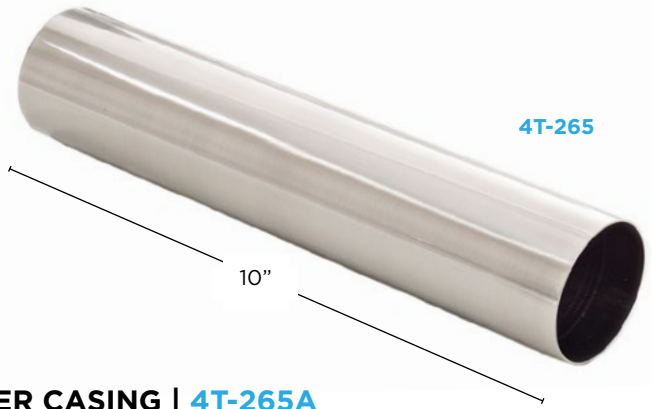

2" OD X 6" COVER CASING | 4T-265A

BRASS BASE METAL

1-14/16" ID

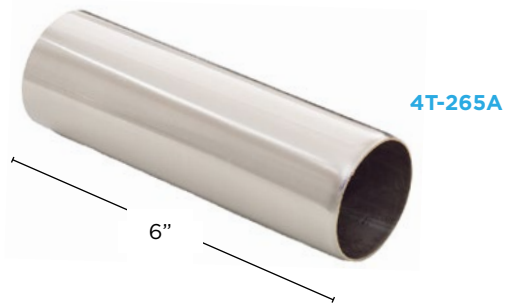

2" OD X 6" SINK FUNNEL | 4T-265G

BELL APPROXIMATELY 3-3/8" OD



4T-283, 4T-283C FINISHES & PRICE GROUPS:

PRICE GROUP A

- Polished Chrome (1)

PRICE GROUP B

- White (13)
- Gloss Black (15)
- Biscuit (16)
- Almond (19)
- Flat Black (20)

PRICE GROUP C

- Polished Brass & PVD (2)
- Antique Brass (3)
- Antique Nickel (Pewter) (4)
- Satin Brass (5)
- Satin Chrome (6)
- Polished Nickel (30)
- Satin Nickel (31)
- Oil Rubbed Bronze (34)
- Stainless/Brushed Nickel (50)

PRICE GROUP D

- Light Gold (32)
- Antique Bronze (33)
- Satin Gold (35)
- Antique Copper (36)
- 4T-283C only
- Light Brushed Bronze (38)
- Venezian Bronze (47)

15/16" OD X 10" COVER CASING

4T-283

FOR USE WITH STEEL PIPE

UNDER LAVATORY WHEN

PIPE EXTENDS FROM WALL

FITS OVER 1/2" IPS PIPE

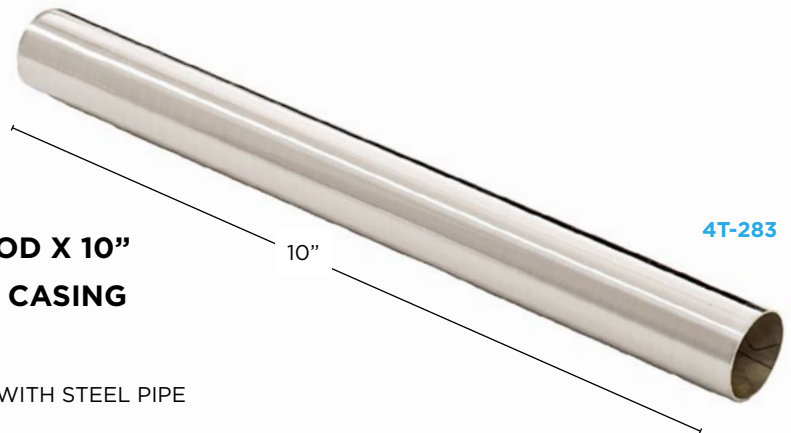

3-1/2" COVER TUBE | 4T-283C

FOR NOMINAL 1/2" COPPER TUBE



BATH STRAINERS

4T-185, 4T-199X, 4T-335 & 4T-336



4T-185

LIFT & TURN BATH PLUG | 4T-185

1-5/8" OD FINE THREAD (16 PER INCH)
2-3/8" DIAMETER
1-1/4" THREADS
BUTTON RAISED 1/4"



4T-199X

LIFT & TURN BATH PLUG | 4T-199X

4T-185 WITH REDUCING BUSHING (4T-186P) 1-1/2" OD
1-5/8" OD - COARSE THREAD

4T-186P



4T-335 & 4T-336

PUSH/PULL BATH PLUG | 4T-335

1-5/8" OD FINE THREAD
16 THREADS PER INCH

PUSH/PULL BATH PLUG W/ REDUCING BUSHING | 4T-336

4T-335 WITH REDUCING BUSHING (4T-186P) 1-1/2" OD
1-5/8" OD COARSE THREAD

4T-186P



4T-185, 4T-199X, 4T-335 & 4T-336 FINISHES & PRICE GROUPS:

PRICE GROUP A

- Polished Chrome (1)

PRICE GROUP B

- White (13)
- Gloss Black (15)
- Biscuit (16)
- Almond (19)
- Flat Black (20)

PRICE GROUP C

- Polished Brass & PVD (2)
- Antique Brass (3)
- Antique Nickel (Pewter) (4)
- Satin Brass (5)
- Satin Chrome (6)
- Polished Nickel (30)

- Satin Nickel (31)
- Oil Rubbed Bronze (34)
- Stainless/Brushed Nickel (50)

PRICE GROUP D

- Polished Copper (7)
4T-185 & 4T-199X only
- Polished Gold (8)
- Light Gold (32)
- Antique Bronze (33)
- Satin Gold (35)
- Antique Copper (36)
- Light Brushed Bronze (38)
- Aged Pewter (40)
- Venezeian Bronze (47)

BATH STRAINERS

4T-1850A, 4T-1850B, 4T-187, 4T-1869 & 4T-1870

TIP-TOE DRAIN STOPPER | 4T-1850A

1-5/8" OD - FINE THREAD (16 PER INCH)

TIP-TOE DRAIN STOPPER W/ REDUCING BUSHING | 4T-1850B

4T-1850A WITH REDUCING BUSHING (4T-186P) 1-1/2" OD



4T-1850A & 4T-1850B

4T-1850A & 4T-1850B FINISHES & PRICE GROUPS:

PRICE GROUP A

- Polished Chrome (1)

PRICE GROUP B

- White (13)
- Biscuit (16)
- Almond (19)
- Flat Black (20)

PRICE GROUP C

- Polished Brass & PVD (2)
- Antique Brass (3)
- Antique Nickel (Pewter) (4)
- Satin Brass (5)

- Satin Chrome (6)
- Polished Nickel (30)
- Satin Nickel (31)
- Oil Rubbed Bronze (34)
- Stainless/Brushed Nickel (50)

PRICE GROUP D

- Antique Bronze (33)
- Satin Gold (35)
- Antique Copper (36)
- Light Brushed Bronze (38)
- Aged Pewter (40)
- Venezian Bronze (47)



4T-186P

DOME STRAINER W/ SCREW | 4T-187

STRAINER (4T-1870) AND SCREW (4T-1869)

FITS GERBER STYLE STRAINER BODY

COUNTERSUNK CENTER HOLE FOR #10 OVAL SCREW (4T-1869)



4T-187 & 4T-1870

4T-187, 4T-1869 & 4T-1870 FINISHES & PRICE GROUPS:

PRICE GROUP A

- Polished Chrome (1)

PRICE GROUP B

- White (13)
- Gloss Black (15)
- Biscuit (16)
- Almond (19)
- Flat Black (20)

PRICE GROUP C

- Polished Brass & PVD (2)
- Antique Brass (3)
- Antique Nickel (Pewter) (4)
- Satin Brass (5)

- Satin Chrome (6)
- Polished Nickel (30)
- Satin Nickel (31)
- Oil Rubbed Bronze (34)
- Stainless/Brushed Nickel (50)

PRICE GROUP D

- Polished Copper (7)
- Light Gold (32)
- Antique Bronze (33)
- Satin Gold (35)
- Antique Copper (36)
- Light Brushed Bronze (38)
- Aged Pewter (40)
- Venezian Bronze (47)

2-7/8" OD DOME

STRAINER ONLY | 4T-1870

COUNTERSUNK CENTER HOLE FOR (4T-1869)



4T-1869

10-24X 2" PHILLIPS OVAL HEAD 2" MACHINE SCREW | 4T-1869

REPLACEMENT SCREW FOR (4T-187) & (4T-1870)

BATH STRAINERS

4T-183A, 4T-304 & 4T-1833



4T-183A & 4T-304

BATHTUB STRAINER SET | 4T-183A

INCLUDES STRAINER BODY (4T-1833)

3-PRONG SNAP-IN STRAINER (4T-184)

BATHTUB STRAINER SET W/ REDUCING BUSHING | 4T-304

4T-183A WITH 3-PRONG STRAINER (4T-184)

REDUCING BUSHING (4T-186P) COARSE THREAD (11-1/2 PER INCH)

FITS TUB WASTE & OVERFLOW WITH 1-1/2" SHOW



4T-186P



4T-1833

1-5/8" BATHTUB STRAINER BODY ONLY | 4T-1833

FINE THREAD (16 PER INCH)

4T-183A, 4T-304 & 4T-1833 FINISHES & PRICE GROUPS:

PRICE GROUP A

- Polished Chrome (1)

PRICE GROUP B

- White (13)
- Gloss Black (15)
- Biscuit (16)
- Almond (19)
- Flat Black (20)

PRICE GROUP C

- Polished Brass & PVD (2)
- Antique Brass (3)
- Antique Nickel (Pewter) (4)
- Satin Brass (5)
- Satin Chrome (6)
- Polished Nickel (30)

- Satin Nickel (31)
- Oil Rubbed Bronze (34)
- Stainless/Brushed Nickel (50)

PRICE GROUP D

- Polished Gold (8)
- Light Gold (32)
4T-183A only
- Antique Bronze (33)
- Satin Gold (35)
- Antique Copper (36)
- Light Brushed Bronze (38)
- Aged Pewter (40)
4T-183A only
- Venezian Bronze (47)

TRIP LEVER DRAIN SET

4T-169



FLAT BLACK (20)

TRIP LEVER DRAIN SET | 4T-169

INCLUDES DOME STRAINER SET (4T-187)

TRIP LEVER FACE PLATE WITH SCREWS (4T-170X)



STAINLESS/BRUSHED NICKEL (50)

4T-169 FINISHES & PRICE GROUPS:

PRICE GROUP A

- Polished Chrome (1)

PRICE GROUP B

- White (13)
- Gloss Black (15)
- Biscuit (16)
- Almond (19)
- Flat Black (20)

PRICE GROUP C

- Polished Brass & PVD (2)
- Antique Brass (3)
- Antique Nickel (Pewter) (4)
- Satin Brass (5)
- Satin Chrome (6)

- Polished Nickel (30)
- Satin Nickel (31)
- Oil Rubbed Bronze (34)
- Stainless/Brushed Nickel (50)

PRICE GROUP D

- Polished Copper (7)
- Light Gold (32)
- Antique Bronze (33)
- Satin Gold (35)
- Antique Copper (36)
- Light Brushed Bronze (38)
- Aged Pewter (40)
- Venezian Bronze (47)

W & O CONVERSION KITS

4T-1900C, 4T-1900CB, 4T-1901C & 4T-1901CB



4T-1900C

TRIP LEVER CONVERSION KIT W/ PLASTIC BUSHING | 4T-1900C

INCLUDES TRIP LEVER FACE PLATE W/ SCREWS (4T-170X)
BATHTUB STRAINER (4T-183A)
PLASTIC REDUCING BUSHING (4T-186P) 1-1/2" OD



4T-186P

TRIP LEVER CONVERSION KIT W/BRASS BUSHING | 4T-1900CB

INCLUDES TRIP LEVER FACE PLATE W/ SCREWS (4T-170X)
BATHTUB STRAINER (4T-183A)
BRASS REDUCING BUSHING (4T-186) 1-1/2" OD



4T-186



4T-1901C

4T-186P

4T-186KP

TRIP LEVER CONVERSION KIT W/ 2 BUSHINGS | 4T-1901C

INCLUDES TRIP LEVER FACE PLATE W/ SCREWS (4T-170X)
BATHTUB STRAINER SET (4T-183A)
2 PLASTIC REDUCING BUSHINGS (4T-186P, 4T-186KP)



4T-186K

TRIP LEVER CONVERSION KIT W/ 2 BUSHINGS | 4T-1901CB

INCLUDES TRIP LEVER FACE PLATE W/ SCREWS (4T-170X)
BATHTUB STRAINER SET (4T-183A)
2 BRASS REDUCING BUSHINGS (4T-186, 4T-186K)



4T-186

4T-1900C, 4T-1900CB, 4T-1901C & 4T-1901CB FINISHES & PRICE GROUPS:

PRICE GROUP A

- Polished Chrome (1)

PRICE GROUP B

- White (13)
- Gloss Black (15)
- Biscuit (16)
- Almond (19)
- Flat Black (20)

PRICE GROUP C

- Polished Brass & PVD (2)
- Antique Brass (3)
- Antique Nickel (Pewter) (4)
- Satin Brass (5)
- Satin Chrome (6)
- Polished Nickel (30)
- Satin Nickel (31)
- Oil Rubbed Bronze (34)
- Stainless/Brushed Nickel (50)

PRICE GROUP D

- Polished Copper (7)
- Light Gold (32)
- Antique Bronze (33)
- Satin Gold (35)
- Antique Copper (36)
- Light Brushed Bronze (38)
- Aged Pewter (40)
- Venezian Bronze (47)

W & O CONVERSION KITS

4T-1902C & 4T-1902CB

LIFT & TURN CONVERSION KIT W/ PLASTIC BUSHING | 4T-1902C

INCLUDES 2-HOLE FACE PLATE & SCREWS (4T-174X)

BATH PLUG (4T-185)

PLASTIC REDUCING BUSHING (4T-186P) 1-1/2" OD



FLAT BLACK (20)



SATIN NICKEL (31)



4T-186

4T-1902C & 4T-1902CB

FINISHES & PRICE GROUPS:

PRICE GROUP A

- Polished Chrome (1)

PRICE GROUP B

- White (13)
- Gloss Black (15)
- Biscuit (16)
- Almond (19)
- Flat Black (20)

PRICE GROUP C

- Polished Brass & PVD (2)
- Antique Brass (3)
- Antique Nickel (Pewter) (4)
- Satin Brass (5)
- Satin Chrome (6)
- Polished Nickel (30)
- Satin Nickel (31)
- Oil Rubbed Bronze (34)
- Stainless/Brushed Nickel (50)

PRICE GROUP D

- Light Gold (32)
- Antique Bronze (33)
- Satin Gold (35)
- Antique Copper (36)
- Light Brushed Bronze (38)
- Aged Pewter (40)
- Venezian Bronze (47)

LIFT & TURN CONVERSION KIT W/ BRASS BUSHING | 4T-1902CB

INCLUDES 2-HOLE FACE PLATE & SCREWS (4T-174X)

BATH PLUG (4T-185)

BRASS REDUCING BUSHING (4T-186) 1-1/2" OD

W & O CONVERSION KITS

4T-1903C, 4T-1903CB, 4T-1904C & 4T-1904CB

TIP-TOE DRAIN CONVERSION KIT W/ PLASTIC BUSHING | 4T-1903C

INCLUDES 2-HOLE FACE PLATE & SCREWS (4T-174X)

TIP-TOE DRAIN (4T-1850A)

PLASTIC REDUCING BUSHING (4T-186P) 1-1/2" OD



4T-1903C & 4T-1903CB

TIP-TOE DRAIN CONVERSION KIT W/ BRASS BUSHING | 4T-1903CB

INCLUDES 2-HOLE FACE PLATE & SCREWS (4T-174X)

TIP-TOE DRAIN (4T-1850A)

BRASS REDUCING BUSHING (4T-186) 1-1/2" OD



4T-186

TIP-TOE CONVERSION KIT W/ PLASTIC BUSHING | 4T-1904C

INCLUDES 1- HOLE FACE PLATE W/ SCREWS (4T-173X)

TIP-TOE DRAIN (4T-1850A)

CONVERSION BAR (4T-171-KIT)

PLASTIC REDUCING BUSHING (4T-186P) 1-1/2" OD



4T-1904C & 4T-1904CB

4T-186

TIP-TOE CONVERSION KIT W/ BRASS BUSHING | 4T-1904CB

INCLUDES 1- HOLE FACE PLATE W/ SCREWS (4T-173X), TIP-TOE DRAIN (4T-1850A),

CONVERSION BAR (4T-171-KIT) AND BRASS REDUCING BUSHING (4T-186) 1-1/2" OD

4T-1903C, 4T-1903CB, 4T-1904C & 4T-1904CB FINISHES & PRICE GROUPS:

PRICE GROUP A

- Polished Chrome (1)

PRICE GROUP B

- White (13)
- Biscuit (16)
- Almond (19)
- Flat Black (20)

PRICE GROUP C

- Polished Brass & PVD (2)
- Antique Brass (3)
- Antique Nickel (Pewter) (4)
- Satin Brass (5)
- Satin Chrome (6)
- Polished Nickel (30)
- Satin Nickel (31)
- Oil Rubbed Bronze (34)
- Stainless/Brushed Nickel (50)

PRICE GROUP D

- Antique Bronze (33)
- Satin Gold (35)
- Antique Copper (36)
- Light Brushed Bronze (38)
- Aged Pewter (40)
- Venezian Bronze (47)

W & O CONVERSION KITS

4T-1905C & 4T-1905CB

LIFT & TURN CONVERSION KIT W/ PLASTIC BUSHING | 4T-1905C

INCLUDES 1-HOLE FACE PLATE & SCREWS (4T-173X)

BATH PLUG (4T-185)

CONVERSION BAR (4T-171-KIT)

PLASTIC REDUCING BUSHING (4T-186P) 1-1/2" OD



LIFT & TURN CONVERSION KIT W/ BRASS BUSHING 4T-1905CB

INCLUDES 1 -HOLE FACE PLATE & SCREWS (4T-173X)

BATH PLUG (4T-185)

CONVERSION KIT (4T-171-KIT)

BRASS BUSHING (4T-186) 1-1/2" OD



4T-1905C & 4T-1905CB FINISHES & PRICE GROUPS:

PRICE GROUP A

- Polished Chrome (1)

PRICE GROUP B

- White (13)
- Gloss Black (15)
- Biscuit (16)
- Almond (19)
- Flat Black (20)

PRICE GROUP C

- Polished Brass & PVD (2)
- Antique Brass (3)
- Antique Nickel (Pewter) (4)
- Satin Brass (5)
- Satin Chrome (6)

- Polished Nickel (30)

- Satin Nickel (31)
- Oil Rubbed Bronze (34)
- Stainless/Brushed Nickel (50)

PRICE GROUP D

- Polished Copper (7)
- Light Gold (32)
- Antique Bronze (33)
- Satin Gold (35)
- Antique Copper (36)
- Light Brushed Bronze (38)
- Aged Pewter (40)
- Venezian Bronze (47)



W & O CONVERSION KITS

4T-1906C, 4T-1906CB, 4T-1907C & 4T-1907CB



4T-1906C

PUSH/PULL CONVERSION KIT W/ PLASTIC BUSHING | 4T-1906C

INCLUDES 2-HOLE FACE PLATE (4T-174X)

BATH PLUG (4T-335)

PLASTIC REDUCING BUSHING (4T-186P) 1-1/2" OD



PUSH/PULL CONVERSION KIT W/ BRASS BUSHING | 4T-1906CB

INCLUDES 2-HOLE FACE PLATE (4T-174X)

BATH PLUG (4T-335)

BRASS REDUCING BUSHING (4T-186) 1-1/2" OD



4T-1907C



4T-186

PUSH/PULL CONVERSION KIT W/ PLASTIC BUSHING | 4T-1907C

INCLUDES 1-HOLE FACE PLATE (4T-173X)

BATH PLUG (4T-335)

CONVERSION BAR (4T-171-KIT)

PLASTIC REDUCING BUSHING (4T-186P) 1-1/2" OD

PUSH/PULL CONVERSION KIT W/ BRASS BUSHING | 4T-1907CB

INCLUDES 1-HOLE FACE PLATE (4T-173X)

BATH PLUG (4T-335), CONVERSION BAR (4T-171-KIT)

BRASS REDUCING BUSHING (4T-186) 1-1/2" OD

4T-186

4T-1906C, 4T-1906CB, 4T-1907C & 4T-1907CB FINISHES & PRICE GROUPS:

PRICE GROUP A

- Polished Chrome (1)

PRICE GROUP B

- White (13)
- Biscuit (16)
- Almond (19)
- Flat Black (20)

PRICE GROUP C

- Polished Brass & PVD (2)
- Antique Brass (3)
- Antique Nickel (Pewter) (4)
- Satin Brass (5)
- Satin Chrome (6)
- Polished Nickel (30)
- Satin Nickel (31)
- Oil Rubbed Bronze (34)
- Stainless/Brushed Nickel (50)

PRICE GROUP D

- Light Gold (32)
4T-170X & 4T-173X only
- Antique Bronze (33)
- Satin Gold (35)
- Antique Copper (36)
- Light Brushed Bronze (38)
- Aged Pewter (40)
- Venezian Bronze (47)

FACE PLATES & ACCESSORIES

4T-170X, 4T-173X, 4T-174X & 4T-172

TRIP LEVER STYLE FACE PLATE | 4T-170X

INCLUDES SCREWS (4T-172)

2" CENTER-TO-CENTER



1 HOLE FACE PLATE WITH SCREW | 4T-173X

INCLUDES SCREW (4T-172)

FOR USE WITH CHAIN & STOPPER

2 HOLE FACE PLATE WITH SCREWS | 4T-174X

INCLUDES SCREW (4T-172)

2" CENTER-TO-CENTER



4T-170X, 4T-173X, 4T-174X & 4T-172

FINISHES & PRICE GROUPS:

PRICE GROUP A

- Polished Chrome (1)

PRICE GROUP B

- White (13)
- Gloss Black (15)
- Biscuit (16)
- Almond (19)
- Flat Black (20)

PRICE GROUP C

- Polished Brass & PVD (2)
- Antique Brass (3)
- Antique Nickel (Pewter) (4)
- Satin Brass (5)
- Satin Chrome (6)
- Polished Nickel (30)
- Satin Nickel (31)
- Oil Rubbed Bronze (34)
- Stainless/Brushed Nickel (50)

PRICE GROUP D

- Polished Copper (7)
- Light Gold (32)
- Antique Bronze (33)
- Satin Gold (35)
- Antique Copper (36)
- Light Brushed Bronze (38)
- Aged Pewter (40)
- Venezian Bronze (47)



1/4"-20 X 1-1/2" BRASS OVAL HEAD MACHINE SCREW | 4T-172

COMPATIBLE WITH ALL STYLES OF FACEPLATES



OVERFLOW BAR W/ 2 SCREWS | 4T-171-KIT

CONVERTS TWO HOLE APPLICATION TO ONE HOLE

PRICE GROUP A

BUSHINGS

4T-186, 4T-186P, 4T-186K & 4T-186KP



4T-186

REDUCING BUSHING IN ROUGH BRASS | 4T-186

ROUGH BRASS ONLY - REDUCES SHOE SIZE FROM 1-1/2" TO 1-3/8"

INTERIOR THREADS ARE FINE (16 PER INCH), 1-3/8" DIAMETER

EXTERIOR THREADS ARE COARSE (11-1/2 PER INCH)

1-1/2" DIAMETER

PRICE GROUP A



4T-186P

PLASTIC REDUCING BUSHING | 4T-186P

REDUCES SHOE SIZE FROM 1-1/2" TO 1-3/8"

INTERIOR THREADS ARE FINE (16 PER INCH), 1-3/8" DIAMETER

EXTERIOR THREADS ARE COARSE (11-1/2 PER INCH)

1-1/2" DIAMETER

PRICE GROUP A



4T-186K

REDUCING BUSHING IN ROUGH BRASS FOR KOHLER W & O 4T-186K

FITS KOHLER WASTE & OVERFLOW ITEMS - INTERIOR THREADS ARE COARSE (11-1/2 PER INCH)

EXTERIOR THREADS ARE FINE (16 PER INCH)

PRICE GROUP A



4T-186KP

PLASTIC REDUCING BUSHING | 4T-186KP

FITS KOHLER WASTE & OVERFLOW ITEMS

INTERIOR THREADS ARE COARSE (11-1/2 PER INCH)

EXTERIOR THREADS ARE FINE (16 PER INCH)

PRICE GROUP A

OFFSET BATH SUPPLIES

4T-188, 4T-189 & 4T-188K

SINGLE OFFSET BATH SUPPLY | 4T-188

INCLUDES

- SET OF TWO 1/2" OD RISERS
- 2 NUTS EACH (1/2", 3/4")
- 2 WASHERS (4T-106-AA, 4T-109-AA)
- 2 FRICTION RINGS EACH (4T-T105-AA, 4T-T108-AA)
- 2 FLANGES (4T-303)



DOUBLE OFFSET BATH SUPPLY (SET OF 2) | 4T-189

INCLUDES

- SET OF TWO 1/2" OD RISERS (4T-189L, 4T-189R)
- 2 NUTS EACH (1/2", 3/4")
- 2 WASHERS (4T-106-AA, 4T-109-AA)
- 2 FRICTION RINGS EACH (4T-T105-AA, 4T-T108-AA)
- 2 FLANGES (4T-303)



4T-188, 4T-189 & 4T-188K

FINISHES & PRICE GROUPS:

PRICE GROUP A

- Polished Chrome (1)

PRICE GROUP C

- Polished Brass & PVD (2)
- Polished Nickel (30)
- Satin Nickel (31)
- Oil Rubbed Bronze (34)
- Stainless/Brushed Nickel (50)

REPLACEMENT KIT FOR OFFSET BATH SUPPLIES | 4T-188K

INCLUDES

- 2 NUTS (1/2", 3/4")
- 2 WASHERS EACH (4T-106-AA, 4T-109-AA)
- 2 FRICTION RINGS EACH (4T-T105-AA, 4T-T108-AA)
- FOR USE WITH 4T-188 AND 4T-189

W & O TRIP LEVER STYLE

4T-176X & 4T-177X



16" TRIP LEVER WASTE & OVERFLOW | 4T-176X

INCLUDES

- FACE PLATE & SCREWS (4T-170X)
- BATHTUB STRAINER SET (4T-183A)
- MAXIMUM MAKEUP IS 16"
- 1-1/2" OD TUBULAR

22" TRIP LEVER WASTE & OVERFLOW | 4T-177X

INCLUDES

- FACE PLATE & SCREWS (4T-170X)
- BATHTUB STRAINER SET (4T-183A)
- MAXIMUM MAKEUP IS 22"
- 1-1/2" OD TUBULAR

4T-176X & 4T-177X

4T-176X & 4T-177X FINISHES & PRICE GROUPS:

PRICE GROUP A

- Polished Chrome (1)

PRICE GROUP B

- White (13)
- Gloss Black (15)
- Biscuit (16)
- Almond (19)
- Flat Black (20)

PRICE GROUP C

- Polished Brass & PVD (2)
- Antique Brass (3)
- Antique Nickel (Pewter) (4)
- Satin Brass (5)

- Satin Chrome (6)
- Polished Nickel (30)
- Satin Nickel (31)
- Oil Rubbed Bronze (34)
- Stainless/Brushed Nickel (50)

PRICE GROUP D

- Light Gold (32)
- Antique Bronze (33)
- Satin Gold (35)
- Antique Copper (36)
- Light Brushed Bronze (38)
- Aged Pewter (40)
- Venezian Bronze (47)

W & O TRIP LEVER STYLE

4T-1760X & 4T-9922D

16" TRIP LEVER WASTE & OVERFLOW FOR FREESTANDING TUBS | 4T-1760X

INCLUDES

- FACE PLATE & SCREWS (4T-170X)
- BATHTUB STRAINER SET (4T-183A)
- FLANGE (4T-2588)
- EXPOSED PARTS ARE PLATED FOR FREESTANDING TUBS
- MAXIMUM MAKEUP IS 16"
- 1-1/2" OD TUBULAR

22" TRIP LEVER WASTE & OVERFLOW FOR FREESTANDING TUBS | 4T-9922D

INCLUDES

- FACE PLATE & SCREWS (4T-170X)
- BATHTUB STRAINER SET (4T-183A)
- FLANGE (4T-2588)
- EXPOSED PARTS ARE PLATED FOR FREESTANDING TUBS
- MAXIMUM MAKEUP IS 22"
- 1-1/2" OD TUBULAR

4T-1760X & 4T-9922D

FINISHES & PRICE GROUPS:

PRICE GROUP A

- Polished Chrome (1)

PRICE GROUP B

- Flat Black (20)

PRICE GROUP C

- Polished Brass & PVD (2)
- Antique Brass (3)
- Satin Brass (5)
- Polished Nickel (30)
- Satin Nickel (31)
- Oil Rubbed Bronze (34)
- Stainless/Brushed Nickel (50)

PRICE GROUP D

- Satin Gold (35)
- Light Brushed Bronze (38)
- Venezian Bronze (47)



4T-1760X & 4T-9922D

W & O LIFT & TURN STYLE

4T-178X & 4T-179X



4T-178X & 4T-179X

16" LIFT & TURN WASTE & OVERFLOW | 4T-178X

INCLUDES

- FACE PLATE & SCREWS (4T-174X)
- BATHTUB PLUG (4T-185)
- MAXIMUM MAKEUP IS 16"
- 1-1/2" OD TUBULAR

22" LIFT & TURN WASTE & OVERFLOW | 4T-179X

INCLUDES

- FACE PLATE & SCREWS (4T-174X)
- BATHTUB PLUG (4T-185)
- MAXIMUM MAKEUP IS 22"
- 1-1/2" OD TUBULAR

4T-178X & 179X FINISHES & PRICE GROUPS:

PRICE GROUP A

- Polished Chrome (1)

PRICE GROUP B

- White (13)
- Gloss Black (15)
- Biscuit (16)
- Almond (19)
- Flat Black (20)

PRICE GROUP C

- Polished Brass & PVD (2)
- Antique Brass (3)
- Antique Nickel (Pewter) (4)
- Satin Brass (5)
- Satin Chrome (6)

- Polished Nickel (30)
- Satin Nickel (31)
- Oil Rubbed Bronze (34)
- Stainless/Brushed Nickel (50)

PRICE GROUP D

- Polished Copper (7)
- Polished Gold (8)
- Light Gold (32)
- Antique Bronze (33)
- Satin Gold (35)
- Antique Copper (36)
- Light Brushed Bronze (38)
- Aged Pewter (40)
- Venezian Bronze (47)

W & O LIFT & TURN STYLE

4T-7711D & 4T-7722D

16" LIFT & TURN WASTE & OVERFLOW FOR FREESTANDING TUBS | 4T-7711D

INCLUDES

- FACE PLATE & SCREWS (4T-174X)
- BATH PLUG (4T-185)
- FLANGE (4T-2588)
- EXPOSED PARTS ARE PLATED FOR FREESTANDING TUBS
- MAXIMUM MAKEUP IS 16
- 1-1/2" OD TUBULAR

22" LIFT & TURN WASTE & OVERFLOW FOR FREESTANDING TUBS | 4T-7722D

INCLUDES

- FACE PLATE & SCREWS (4T-174X)
- BATH PLUG (4T-185)
- FLANGE (4T-2588)
- EXPOSED PARTS ARE PLATED FOR FREESTANDING TUBS
- MAXIMUM MAKEUP IS 22"
- 1-1/2" OD TUBULAR



4T-7711D & 4T-7722D

4T-7711D & 4T-7722D

FINISHES & PRICE GROUPS:

PRICE GROUP A

- Polished Chrome (1)

PRICE GROUP B

- Flat Black (20)

PRICE GROUP C

- Polished Brass & PVD (2)
- Antique Brass (3)
- Satin Brass (5)
- Polished Nickel (30)
- Satin Nickel (31)
- Oil Rubbed Bronze (34)
- Stainless/Brushed Nickel (50)

PRICE GROUP D

- Satin Gold (35)
- Light Brushed Bronze (38)
- Venezian Bronze (47)

W & O CHAIN & STOPPER

4T-1800A & 4T-9855D

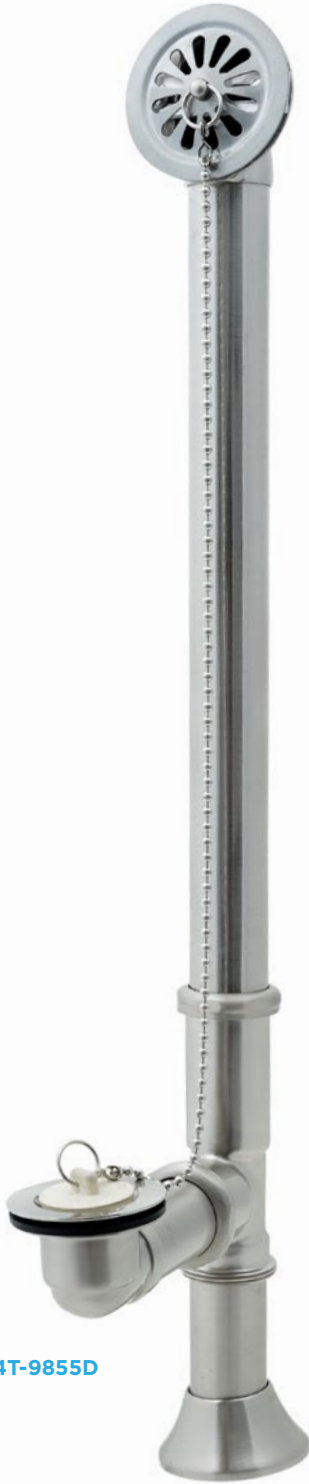

4T-1800A & 4T-9855D

16" CHAIN & STOPPER WASTE & OVERFLOW FOR FREESTANDING TUBS | 4T-1800A

INCLUDES

- OVERFLOW SET (4T-175)
- STRAINER BODY (4T-1833) AND FLANGE (4T-2588)
- EXPOSED PARTS ARE PLATED FOR FREESTANDING TUBS
- MAXIMUM MAKEUP IS 16"
- 1-1/2" OD TUBULAR

22" CHAIN & STOPPER WASTE & OVERFLOW FOR FREESTANDING TUBS | 4T-9855D

INCLUDES

- OVERFLOW SET (4T-175)
- STRAINER BODY (4T-1833)
- FLANGE (4T-2588)
- EXPOSED PARTS ARE PLATED FOR FREESTANDING TUBS
- MAXIMUM MAKEUP IS 22"
- 1-1/2" OD TUBULAR

4T-1800A & 4T-9855D

FINISHES & PRICE GROUPS:

PRICE GROUP A

- Polished Chrome (1)

PRICE GROUP B

- Flat Black (20)

PRICE GROUP C

- Polished Brass & PVD (2)
- Antique Brass (3)
- Satin Brass (5)
- Satin Nickel (31)
- Oil Rubbed Bronze (34)
- Stainless/Brushed Nickel (50)

PRICE GROUP D

- Venezian Bronze (47)

W & O TIP-TOE STYLE

4T-1802A & 4T-1803A

16" TIP-TOE WASTE & OVERFLOW | 4T-1802A

INCLUDES

- FACE PLATE (4T-174X)
- TIP-TOE DRAIN (4T-1850A)
- 1-1/2" OD TUBULAR
- MAXIMUM MAKE UP IS 16"

22" TIP-TOE WASTE & OVERFLOW | 4T-1803A

INCLUDES

- FACE PLATE (4T-174X)
- TIP-TOE DRAIN (4T-1850A)
- 1-1/2" OD TUBULAR
- MAXIMUM MAKE UP IS 22"

4T-1802A & 4T-1803A

FINISHES & PRICE GROUPS:

PRICE GROUP A

- Polished Chrome (1)

PRICE GROUP B

- White (13)
- Biscuit (16)
- Almond (19)
- Flat Black (20)

PRICE GROUP C

- Polished Brass & PVD (2)
- Antique Brass (3)
- Antique Nickel (Pewter) (4)
- Satin Brass (5)
- Satin Chrome (6)
- Polished Nickel (30)
- Satin Nickel (31)
- Oil Rubbed Bronze (34)
- Stainless/Brushed Nickel (50)

PRICE GROUP D

- Antique Bronze (33)
- Satin Gold (35)
- Antique Copper (36)
- Light Brushed Bronze (38)
- Aged Pewter (40)
- Venezian Bronze (47)



4T-1802A & 4T-1803A

W & O TIP-TOE STYLE

4T-1804A & 4T-1805A



16" TIP-TOE WASTE & OVERFLOW FOR FREESTANDING TUBS | 4T-1804A

INCLUDES

- FACE PLATE (4T-174X)
- FLANGE (4T-2588)
- TIP-TOE DRAIN (4T-1850A)
- 1-1/2" OD TUBULAR
- EXPOSED PARTS ARE PLATED FOR FREESTANDING TUBS
- MAXIMUM MAKE UP IS 16"

22" TIP-TOE WASTE & OVERFLOW FOR FREESTANDING TUBS | 4T-1805A

INCLUDES

- FACE PLATE (4T-174X)
- FLANGE (4T-2588)
- TIP-TOE DRAIN (4T-1850A)
- 1-1/2" OD TUBULAR
- EXPOSED PARTS ARE PLATED FOR FREESTANDING TUBS
- MAXIMUM MAKE UP IS 22"

4T-1804A & 4T-1805A

4T-1804A & 4T-1805A

FINISHES & PRICE GROUPS:

PRICE GROUP A

- Polished Chrome (1)

PRICE GROUP B

- Flat Black (20)

PRICE GROUP C

- Polished Brass & PVD (2)
- Antique Brass (3)
- Satin Brass (5)
- Polished Nickel (30)
- Satin Nickel (31)
- Oil Rubbed Bronze (34)
- Stainless/Brushed Nickel (50)

PRICE GROUP D

- Satin Gold (35)
- Light Brushed Bronze (38)
- Venezian Bronze (47)

W & O TIP-TOE STYLE

4T-1833A | Extended Shoe Tube-9-1/2"

22" TIP-TOE WASTE & OVERFLOW WITH EXTENDED SHOE TUBE | 4T-1833A

INCLUDES:

- TWO HOLE PLATE & SCREWS (4T-174X)
- TIP-TOE DRAIN (4T-1850A)
- 1-1/2" TUBULAR
- MAXIMUM MAKEUP IS 22"



4T-1833A

FINISHES & PRICE GROUPS:

PRICE GROUP A

- Polished Chrome (1)

PRICE GROUP B

- White (13)
- Biscuit (16)
- Almond (19)
- Flat Black (20)

PRICE GROUP C

- Polished Brass & PVD (2)
- Antique Brass (3)
- Antique Nickel (Pewter) (4)
- Satin Brass (5)
- Satin Chrome (6)
- Polished Nickel (30)
- Satin Nickel (31)
- Oil Rubbed Bronze (34)
- Stainless/Brushed Nickel (50)

PRICE GROUP D

- Antique Bronze (33)
- Satin Gold (35)
- Antique Copper (36)
- Light Brushed Bronze (38)
- Aged Pewter (40)
- Venezian Bronze (47)

4T-1833A

22" LIFT & TURN WASTE & OVERFLOW FOR FREESTANDING TUBS

4T-5599 | EXTENDED SHOE TUBE-9-1/2"



22" LIFT & TURN WASTE & OVERFLOW FOR FREESTANDING TUBS | 4T-5599

INCLUDES

- TWO HOLE FACE PLATE & SCREWS (4T-174X)
- LIFT & TURN BATH PLUG (4T-185)
- FLANGE (4T-2588)
- EXPOSED PARTS ARE PLATED FOR FREESTANDING TUBS
- MAXIMUM MAKEUP IS 22"
- 1-1/2" OD TUBULAR

4T-5599

FINISHES & PRICE GROUPS:

PRICE GROUP A

- Polished Chrome (1)

PRICE GROUP B

- Flat Black (20)

PRICE GROUP C

- Polished Brass & PVD (2)
- Satin Brass (5)
- Polished Nickel (30)
- Satin Nickel (31)
- Oil Rubbed Bronze (34)
- Stainless/Brushed Nickel (50)

PRICE GROUP D

- Satin Gold (35)
- Light Brushed Bronze (38)

22" LIFT & TURN WASTE & OVERFLOW FOR FREESTANDING TUBS

4T-5599E | EXTENDED SHOE TUBE-18"

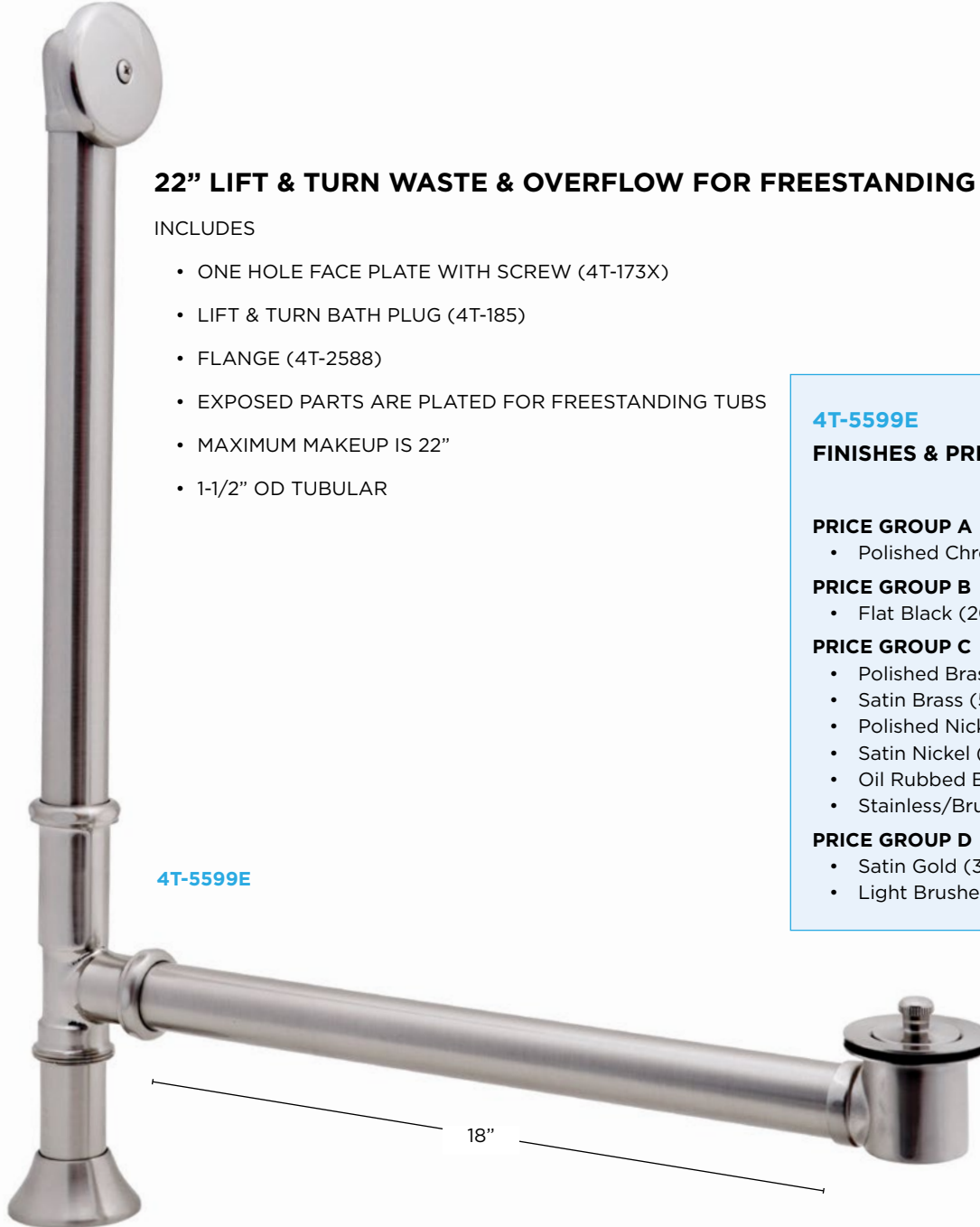

22" LIFT & TURN WASTE & OVERFLOW FOR FREESTANDING TUBS | 4T-5599E

INCLUDES

- ONE HOLE FACE PLATE WITH SCREW (4T-173X)
- LIFT & TURN BATH PLUG (4T-185)
- FLANGE (4T-2588)
- EXPOSED PARTS ARE PLATED FOR FREESTANDING TUBS
- MAXIMUM MAKEUP IS 22"
- 1-1/2" OD TUBULAR

4T-5599E

FINISHES & PRICE GROUPS:

PRICE GROUP A

- Polished Chrome (1)

PRICE GROUP B

- Flat Black (20)

PRICE GROUP C

- Polished Brass & PVD (2)
- Satin Brass (5)
- Polished Nickel (30)
- Satin Nickel (31)
- Oil Rubbed Bronze (34)
- Stainless/Brushed Nickel (50)

PRICE GROUP D

- Satin Gold (35)
- Light Brushed Bronze (38)

4T-5599E

18"

1-1/2" TUBES FOR W & O

4T-1773A, 4T-1774A, 4T-1775A, 4T-1776A & 4T-1777A



1-1/2" OD X 3" OVERFLOW TUBE | 4T-1773A

THREADED AT ONE END

4T-1773A

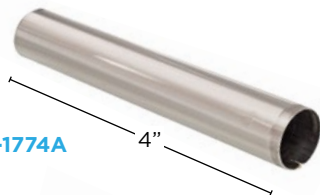

1-1/2" OD X 4" OVERFLOW TUBE | 4T-1774A

THREADED AT ONE END

4T-1774A

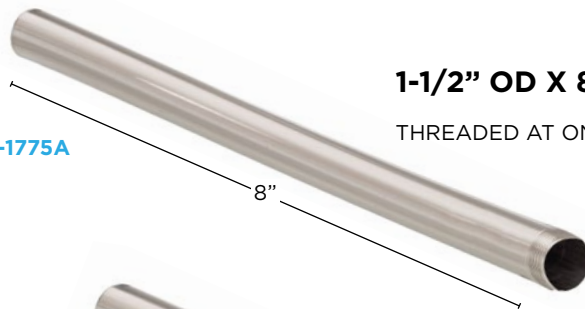

1-1/2" OD X 8" OVERFLOW TUBE | 4T-1775A

THREADED AT ONE END

4T-1775A



1-1/2" OD X 9-1/2" OVERFLOW TUBE | 4T-1776A

THREADED AT ONE END

4T-1776A

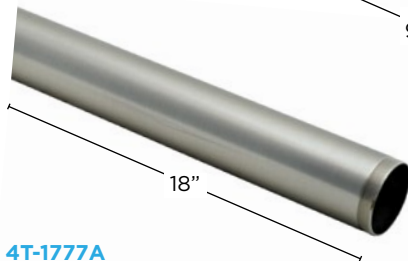

1-1/2" OD X 18" OVERFLOW TUBE | 4T-1777A

THREADED AT ONE END

4T-1777A

4T-1773A, 4T-1774A, 4T-1775A, 4T-1776A & 4T-1777A

FINISHES & PRICE GROUPS:

PRICE GROUP A

- Polished Chrome (1)

PRICE GROUP B

- Flat Black (20)

PRICE GROUP C

- Polished Brass & PVD (2)
- Antique Brass (3)
- Satin Brass (5)

- Polished Nickel (30)

- Satin Nickel (31)

- Oil Rubbed Bronze (34)

- Stainless/Brushed Nickel (50)

PRICE GROUP D

- Satin Gold (35)

- Light Brushed Bronze (38)

- Venezian Bronze (47)

1-3/8" TUBES FOR W & O

4T-1779A, 4T-1780A, 4T-1781A, 4T-1782A & 4T-1783A

1-3/8" OD X 3" OVERFLOW | 4T-1779A

THREADED AT ONE END

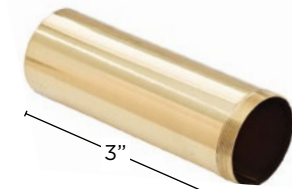

4T-1779A

1-3/8" OD X 4" OVERFLOW TUBE | 4T-1780A

THREADED AT ONE END

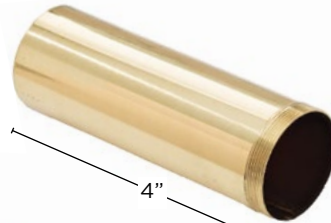

4T-1780A

1-3/8" OD X 8" OVERFLOW TUBE | 4T-1781A

THREADED AT ONE END

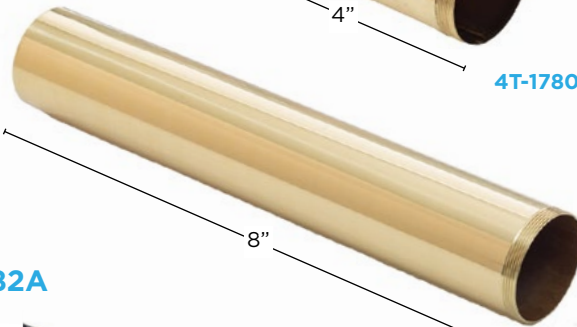

4T-1781A

1-3/8" OD X 12" OVERFLOW TUBE | 4T-1782A

THREADED AT ONE END



4T-1782A

1-3/8" OD X 18" OVERFLOW TUBE | 4T-1783A

THREADED AT ONE END



4T-1783A

4T-1779A, 4T-1780A, 4T-1781A,
4T-1782A & 4T-1783A

FINISHES & PRICE GROUPS:

PRICE GROUP A

- Polished Chrome (1)

PRICE GROUP C

- Polished Brass & PVD (2)

ADJUSTABLE SHOWER ROD & HOLDER

4T-1020

NEW

TWO-PIECE ADJUSTABLE SHOWER ROD | 4T-1020

STAINLESS STEEL TWO-PIECE ROD IS ADJUSTABLE FROM 43"-72"

COMES WITH TWO FLANGES AS SHOWN



4T-1020



4T-1020

FINISHES & PRICE GROUPS:

PRICE GROUP A

- Polished Chrome (1)

PRICE GROUP B

- Flat Black (20)

PRICE GROUP C

- Polished Brass & PVD (2)
- Satin Brass (5)
- Polished Nickel (30)
- Satin Nickel (31)
- Oil Rubbed Bronze (34)
- Stainless/Brushed Nickel (50)

PRICE GROUP D

- Satin Gold (35)
- Light Brushed Bronze (38)

ONE PIECE SHOWER RODS

4T-1060, 4T-1072 & 4T-1090

NEW

ONE-PIECE 60" STAINLESS STEEL SHOWER ROD | 4T-1060

1" DIAMETER

ROD ONLY, HOLDERS SOLD SEPARATELY



4T-1060

4T-1060 & 4T-1072

FINISHES & PRICE GROUP

PRICE GROUP A

- Polished Chrome (1)

PRICE GROUP B

- Flat Black (20)

PRICE GROUP C

- Polished Brass & PVD (2)
- Satin Brass (5)
- Polished Nickel (30)
- Satin Nickel (31)
- Oil Rubbed Bronze (34)
- Stainless/Brushed Nickel (50)

PRICE GROUP D

- Satin Gold (35)
- Light Brushed Bronze (38)

NEW

ONE-PIECE 72" STAINLESS STEEL SHOWER ROD | 4T-1072

1" DIAMETER

ROD ONLY, HOLDERS SOLD SEPARATELY



4T-1072

ONE-PIECE 60" BRASS SHOWER ROD | 4T-1090

1" DIAMETER

ROD ONLY, HOLDERS SOLD SEPARATELY



4T-1090

4T-1090

FINISHES & PRICE GROUPS:

PRICE GROUP A

- Polished Chrome (1)

PRICE GROUP B

- White (13)
- Gloss Black (15)
- Biscuit (16)
- Almond (19)
- Flat Black (20)

PRICE GROUP C

- Polished Brass & PVD (2)
- Antique Brass (3)
- Antique Nickel (Pewter) (4)

- Satin Brass (5)
- Satin Chrome (6)
- Polished Nickel (30)
- Satin Nickel (31)
- Oil Rubbed Bronze (34)
- Stainless/Brushed Nickel (50)

PRICE GROUP D

- Satin Gold (35)
- Antique Copper (36)
- Satin Copper (37)
- Light Brushed Bronze (38)
- Aged Pewter (40)

SHOWER ROD FLANGES

4T-1190 & 4T-1150

NEW

SOLID BRASS DECORATIVE ROD FLANGES | 4T-1190

SET OF TWO

FITS ALL 1" DIAMETER SHOWER RODS



4T-1190

4T-1190 & 4T-1150 FINISHES & PRICE GROUPS:

PRICE GROUP A

- Polished Chrome (1)

PRICE GROUP B

- Flat Black (20)

PRICE GROUP C

- Satin Brass (5)
- Satin Nickel (31)
- Oil Rubbed Bronze (34)
- Stainless/Brushed Nickel (50)

PRICE GROUP D

- Light Brushed Bronze (38)

DIE CAST ROUND HEAVY DUTY SHOWER ROD FLANGES | 4T-1150

SET OF TWO

FITS ALL 1" DIAMETER SHOWER RODS

COMES WITH TWO DECORATIVE SCREWS AND DRYWALL ANCHORS



4T-1150

SHOWER ROD HOLDERS & ACCESSORIES

4T-1160, 4T-1170, 4T-119 & 4T-112

SHOWER ROD FLANGE SET WITH CONCEALED SCREWS | 4T-1160

INCLUDES 2 FLANGES

2 BRACKETS (PF16-AA) AND UNPLATED SCREWS



4T-1160

4T-1170



SHOWER ROD FLANGE SET WITH EXPOSED SCREWS | 4T-1170

INCLUDES 2 FLANGES AND PLATED SCREWS

SHOWER CURTAIN PIN SET | 4T-119

PACKAGED 12 PINS PER BAG



4T-119

ADJUSTABLE ROD HOLDER SET | 4T-112



4T-112 FINISHES & PRICE GROUPS:

PRICE GROUP A

- Polished Chrome (1)

PRICE GROUP B

- White (13)
- Gloss Black (15)
- Biscuit (16)
- Almond (19)
- Flat Black (20)

PRICE GROUP C

- Polished Brass & PVD (2)
- Antique Brass (3)
- Satin Chrome (6)
- Polished Nickel (30)
- Satin Nickel (31)
- Oil Rubbed Bronze (34)
- Stainless/Brushed Nickel (50)

PRICE GROUP D

- Light Brushed Bronze (38)
- Venezian Bronze (47)

4T-1160, 4T-1170 & 4T-119

FINISHES & PRICE GROUPS:

PRICE GROUP A

- Polished Chrome (1)

PRICE GROUP B

- White (13)
- Gloss Black (15)
- Biscuit (16)
- Flat Black (20)

PRICE GROUP C

- Polished Brass & PVD (2)
- Antique Brass (3)
- Antique Nickel (Pewter) (4)
- Satin Brass (5)

- Satin Chrome (6)

- Polished Nickel (30)

- Satin Nickel (31)

- Oil Rubbed Bronze (34)

- Stainless/Brushed Nickel (50)

PRICE GROUP D

- Antique Copper (36)

- Satin Copper (37)

- Light Brushed Bronze (38)

- Aged Pewter (40)

- Venezian Bronze (47)

4T-119 only

BRASS SHOWER HEADS

4T-121, 4T-122 & 4T-141



4T-121

BRASS SHOWER HEAD | 4T-121

2-1/4" DIAMETER FACE WITH FLOW RESTRICTOR

4T-121 FINISHES & PRICE GROUPS:

PRICE GROUP A

- Polished Chrome (1)

PRICE GROUP B

- White (13)

PRICE GROUP C

- Polished Brass & PVD (2)
- Antique Brass (3)
- Polished Nickel (30)
- Satin Nickel (31)
- Oil Rubbed Bronze (34)
- Stainless/Brushed Nickel (50)



4T-122

6 SHOWER JET BRASS SHOWER HEAD | 4T-122

2-3/4" DIAMETER FACE WITH FLOW RESTRICTOR

4T-122 FINISHES & PRICE GROUPS:

PRICE GROUP A

- Polished Chrome (1)

PRICE GROUP B

- Flat Black (20)

PRICE GROUP C

- Polished Brass & PVD (2)
- Antique Brass (3)
- Satin Chrome (6)
- Satin Nickel (31)
- Oil Rubbed Bronze (34)
- Stainless/Brushed Nickel (50)

PRICE GROUP D

- Antique Bronze (33)
- Venezian Bronze (47)



4T-141

8 SHOWER JET LARGE BRASS SHOWER HEAD | 4T-141

3-1/2" DIAMETER FACE WITH FLOW RESTRICTOR

4T-141 FINISHES & PRICE GROUPS:

PRICE GROUP A

- Polished Chrome (1)

PRICE GROUP B

- Almond (19)

PRICE GROUP C

- Polished Brass & PVD (2)
- Antique Brass (3)
- Polished Nickel (30)
- Satin Nickel (31)
- Oil Rubbed Bronze (34)
- Stainless/Brushed Nickel (50)

10" ROUND SHOWER HEAD

4T-124



< A THIN 2.5 mm THICK

4T-124 FINISH & PRICE GROUP:

PRICE GROUP A

- Polished Chrome (1) ONLY

10" ROUND STAINLESS STEEL SHOWER HEAD | 4T-124

FEATURES 558 NOZZLES

SHOWER HEAD IS 2.5 mm THICK

1.75 GPM

FLOW RESTRICTOR

SHOWN WITH 4T-145 SHEPHERD'S CROOK 16" SHOWER ARM

SHOWER ARM NOT INCLUDED, AVAILABLE ON PAGE 84

SHEPHERD'S CROOK SHOWER ARM & FLANGE

4T-145

NEW

16" BRASS SHEPHERD'S CROOK SHOWER ARM | 4T-145

GREAT FOR USE WITH RAIN SHOWER HEADS

INCLUDES FLANGE (4T-132)



4T-145

FLAT BLACK (20)



POLISHED CHROME (1)

4T-145 FINISHES & PRICE GROUP

PRICE GROUP A

- Polished Chrome (1)

PRICE GROUP B

- Flat Black (20)

PRICE GROUP C

- Polished Brass & PVD (2)
- Satin Brass (5)
- Satin Nickel (31)
- Oil Rubbed Bronze (34)
- Stainless/Brushed Nickel (50)

PRICE GROUP D

- Light Brushed Bronze (38)

8" ROUND SHOWER HEAD

4T-128

NEW

8" ROUND STAINLESS STEEL SHOWER HEAD | 4T-128

FEATURE 75 NOZZLES



4T-128

< A THIN 6 mm

4T-128

FINISHES & PRICE GROUP

PRICE GROUP A

- Polished Chrome (1)

PRICE GROUP B

- Flat Black (20)

PRICE GROUP C

- Polished Brass & PVD (2)
- Satin Nickel (31)
- Oil Rubbed Bronze (34)

PRICE GROUP D

- Light Brushed Bronze (38)

SHOWN WITH THE 4T-145 SHEPHERD'S CROOK SHOWER ARM

SHOWER ARM NOT INCLUDED, AVAILABLE ON PAGE 84

SHOWER ARMS & FLANGES

4T-146, 4T-148 & 4T-150



4T-146

6" BRASS SHOWER ARM | 4T-146

INCLUDES FLANGE (4T-132)



4T-148

8" BRASS SHOWER ARM | 4T-148

INCLUDES FLANGE (4T-132)



4T-150

10" BRASS SHOWER ARM | 4T-150

INCLUDES FLANGE (4T-132)

4T-146, 4T-148 & 4T-150 FINISHES & PRICE GROUPS:

PRICE GROUP A

- Polished Chrome (1)

PRICE GROUP B

- White (13)
- Gloss Black (15)
- Almond (19)
- Flat Black (20)

PRICE GROUP C

- Polished Brass & PVD (2)
- Antique Brass (3)
- Antique Nickel (Pewter) (4)

- Satin Brass (5)
- Satin Chrome (6)
- Polished Nickel (30)
- Satin Nickel (31)
- Oil Rubbed Bronze (34)
- Stainless/Brushed Nickel (50)

PRICE GROUP D

- Satin Gold (35)
- Antique Copper (36)
4T-148 only
- Light Brushed Bronze (38)
- Venezian Bronze (47)

SHOWER ARMS & FLANGES

4T-147, 4T-149 & 4T-151D

4T-147 FINISHES & PRICE GROUPS:

PRICE GROUP A

- Polished Chrome (1)

PRICE GROUP C

- Polished Brass & PVD (2)
- Polished Nickel (30)
- Satin Nickel (31)
- Oil Rubbed Bronze (34)
- Stainless/Brushed Nickel (50)

4T-149 FINISHES & PRICE GROUPS:

PRICE GROUP A

- Polished Chrome (1)

PRICE GROUP B

- White (13)
- Flat Black (20)

PRICE GROUP C

- Polished Brass & PVD (2)
- Antique Nickel (Pewter) (4)
- Polished Nickel (30)
- Satin Nickel (31)
- Oil Rubbed Bronze (34)
- Stainless/Brushed Nickel (50)

PRICE GROUP D

- Light Brushed Bronze (38)
- Aged Pewter (40)
- Venezian Bronze (47)

4T-151D FINISHES & PRICE GROUPS:

PRICE GROUP A

- Polished Chrome (1)

PRICE GROUP B

- Flat Black (20)

PRICE GROUP C

- Polished Brass & PVD (2)
- Antique Brass (3)
- Antique Nickel (Pewter) (4)
- Satin Brass (5)
- Polished Nickel (30)
- Satin Nickel (31)
- Oil Rubbed Bronze (34)
- Stainless/Brushed Nickel (50)

PRICE GROUP D

- Satin Gold (35)
- Light Brushed Bronze (38)
- Venezian Bronze (47)

12" HOOK SHOWER ARM | 4T-147

WELDED FLANGE



1/2" X 12" L SHOWER ARM | 4T-149

INCLUDES FLANGE (4T-132)



"S" SHOWER ARM | 4T-151D

INCLUDES FLANGE (4T-132)

RAISES SHOWER HEAD APPROXIMATELY 10" FROM INLET



SHOWER ARMS

1/2" IPS | 12", 18" & 24" LENGTH

4T-415N, 4T-416N, & 4T-417N

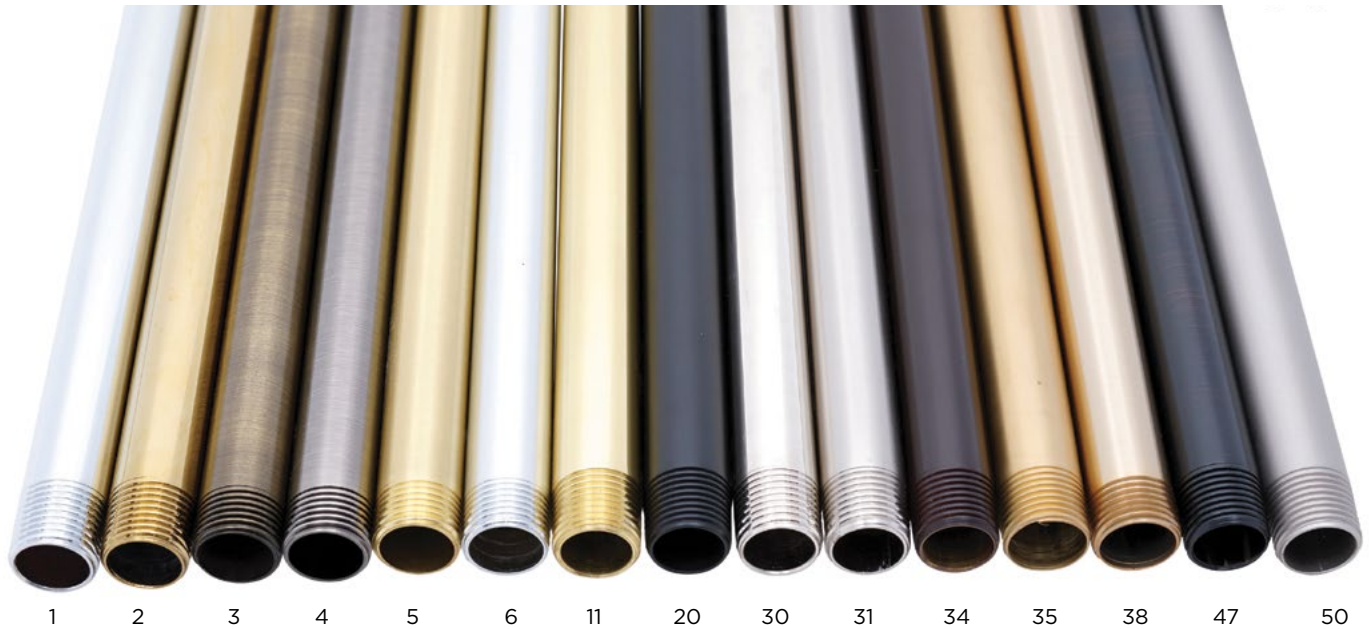

1/2" IPS X 12" CEILING MOUNT SHOWER ARM | 4T-415N

12" LENGTH, FLANGE NOT INCLUDED

1/2" IPS X 18" CEILING MOUNT SHOWER ARM | 4T-416N

18" LENGTH, FLANGE NOT INCLUDED

1/2" IPS X 24" CEILING MOUNT SHOWER ARM | 4T-417N

24" LENGTH, FLANGE NOT INCLUDED

4T-415N, 4T-416N, & 4T-417N FINISHES & PRICE GROUPS:

PRICE GROUP A

- Polished Chrome (1)

PRICE GROUP B

- Flat Black (20)

PRICE GROUP C

- Polished Brass & PVD (2)
- Antique Brass (3)
- Antique Nickel (Pewter) (4)
- Satin Brass (5)
- Satin Chrome (6)
- Polished Nickel (30)
- Satin Nickel (31)
- Oil Rubbed Bronze (34)
- Stainless/Brushed Nickel (50)

PRICE GROUP D

- Uncoated Polished Brass (11)
- Satin Gold (35)
- Light Brushed Bronze (38)
- Venezian Bronze (47)

SHOWER ARMS

1/2" IPS | 30" - 60" LENGTH

4T-418N, 4T-419N, 4T-420N, 4T-421N, 4T-422N & 4T-423N

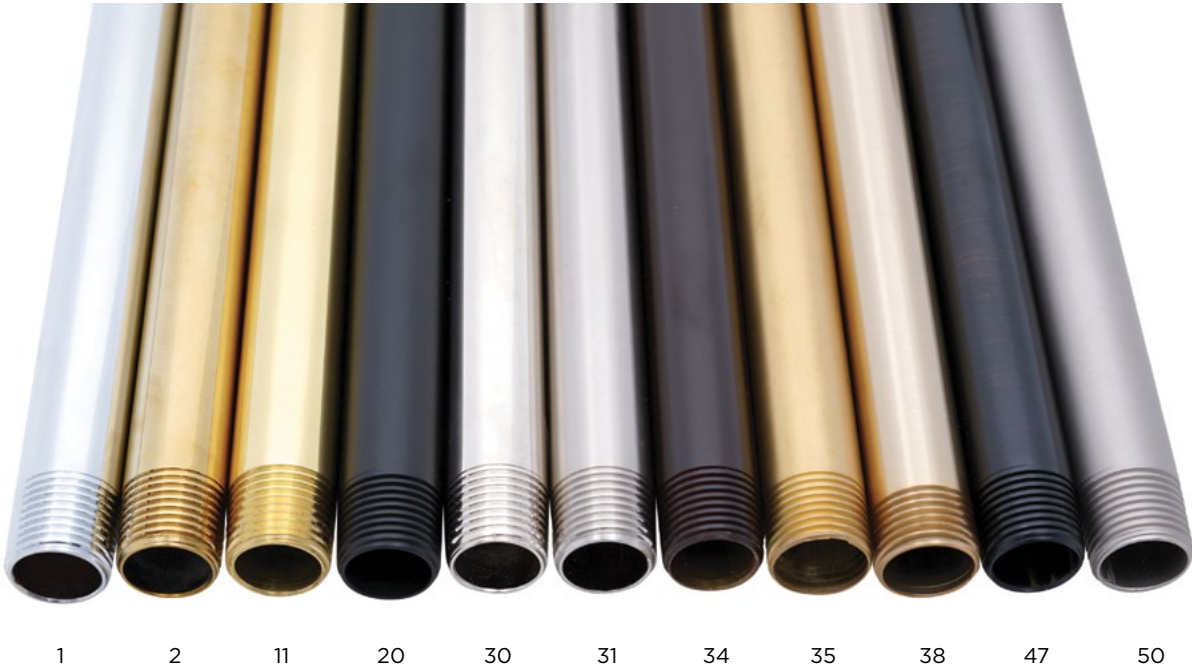

1/2" IPS X 30" CEILING MOUNT SHOWER ARM | 4T-418N

FLANGE NOT INCLUDED

1/2" IPS X 36" CEILING MOUNT SHOWER ARM | 4T-419N

FLANGE NOT INCLUDED

1/2" IPS X 48" CEILING MOUNT SHOWER ARM | 4T-420N

FLANGE NOT INCLUDED

1/2" IPS X 42" CEILING MOUNT SHOWER ARM | 4T-421N

FLANGE NOT INCLUDED

1/2" IPS X 54" CEILING MOUNT SHOWER ARM | 4T-422N

FLANGE NOT INCLUDED

1/2" IPS X 60" CEILING MOUNT SHOWER ARM | 4T-423N

FLANGE NOT INCLUDED

4T-418N, 4T-419N, 4T-420N, 4T-421N, 4T-422N & 4T-423N FINISHES & PRICE GROUPS:

PRICE GROUP A

- Polished Chrome (1)

PRICE GROUP B

- Flat Black (20)

PRICE GROUP C

- Polished Brass & PVD (2)
- Polished Nickel (30)
- Satin Nickel (31)
- Oil Rubbed Bronze (34)
- Stainless/Brushed Nickel (50)

PRICE GROUP D

- Uncoated Polished Brass (11)
- Satin Gold (35)
- Light Brushed Bronze (38)
- Venezian Bronze (47)

SHOWER ARM FLANGES

4T-132 & 4T-152

SHOWER ARM FLANGE (SURE GRIP STYLE) | 4T-132

2-3/8" OD



4T-132

4T-132 FINISHES & PRICE GROUPS:

PRICE GROUP A

- Polished Chrome (1)

PRICE GROUP B

- White (13)
- Gloss Black (15)
- Biscuit (16)
- Almond (19)
- Flat Black (20)

PRICE GROUP C

- Polished Brass & PVD (2)
- Antique Brass (3)
- Antique Nickel (Pewter) (4)
- Satin Brass (5)
- Satin Chrome (6)
- Polished Nickel (30)

- Satin Nickel (31)

- Oil Rubbed Bronze (34)
- Stainless/Brushed Nickel (50)

PRICE GROUP D

- Polished Gold (8)
- Uncoated Polished Brass (11)
- Black Nickel (12)
- Antique Bronze (33)
- Satin Gold (35)
- Antique Copper (36)
- Satin Copper (37)
- Light Brushed Bronze (38)
- Aged Pewter (40)
- Antique Gold (46)
- Venezian Bronze (47)

SHOWER ARM FLANGE WITH SET SCREW | 4T-152

2-3/4" OD



4T-152

4T-152 FINISHES & PRICE GROUPS:

PRICE GROUP A

- Polished Chrome (1)

PRICE GROUP B

- White (13)
- Flat Black (20)

PRICE GROUP C

- Polished Brass & PVD (2)
- Antique Brass (3)
- Antique Nickel (Pewter) (4)
- Satin Brass (5)

- Satin Chrome (6)

- Polished Nickel (30)
- Satin Nickel (31)
- Oil Rubbed Bronze (34)
- Stainless/Brushed Nickel (50)

PRICE GROUP D

- Black Nickel (12)
- Light Gold (32)
- Antique Copper (36)
- Venezian Bronze (47)

SHOWER ARM FLANGES & VOLUME CONTROL

4T-153 & 4T-156

CAST BRASS SHOWER ARM FLANGE W/ SET SCREW | 4T-153

3-1/4" OD



4T-153

4T-153 FINISHES & PRICE GROUPS:

PRICE GROUP A

- Polished Chrome (1)

PRICE GROUP B

- Flat Black (20)

PRICE GROUP C

- Polished Brass & PVD (2)
- Antique Nickel (Pewter) (4)
- Polished Nickel (30)

- Satin Nickel (31)

- Oil Rubbed Bronze (34)

- Stainless/Brushed Nickel (50)

PRICE GROUP D

- Satin Gold (35)

- Light Brushed Bronze (38)

- Venezian Bronze (47)

BRASS VOLUME CONTROL | 4T-156

1/2" INLET

1/2" OUTLET WITH "O" RING SEAL



4T-156

4T-156 FINISHES & PRICE GROUPS:

PRICE GROUP A

- Polished Chrome (1)

PRICE GROUP B

- White (13)
- Almond (19)
- Flat Black (20)

PRICE GROUP C

- Polished Brass & PVD (2)
- Antique Brass (3)
- Antique Nickel (Pewter) (4)
- Satin Brass (5)

- Satin Chrome (6)

- Polished Nickel (30)

- Satin Nickel (31)

- Oil Rubbed Bronze (34)

- Stainless/Brushed Nickel (50)

PRICE GROUP D

- Black Nickel (12)

- Satin Gold (35)

- Light Brushed Bronze (38)

- Venezian Bronze (47)

TUB SPOUTS

4T-160, 4T-164 & 4T-165



4T-160



4T-164

1/2" IPS FRONT CONNECT ZINC DIE CAST TUB SPOUT | 4T-160

5" LENGTH - 2-5/8" BASE

QUICK CONNECT ZINC DIE CAST TUB SPOUT | 4T-164

5" LENGTH

QUICK-CONNECT SLIDE FOR 1/2" COPPER WIRE TUBE

4T-160 & 4T-164

FINISHES & PRICE GROUPS:

PRICE GROUP A

- Polished Chrome (1)

PRICE GROUP B

- White (13)

PRICE GROUP C

- Polished Brass & PVD (2)
- Satin Nickel (31)
- Oil Rubbed Bronze (34)
- Stainless/Brushed Nickel (50)



4T-165

1/2" IPS FRONT CONNECT BRASS TUB SPOUT | 4T-165

5" LENGTH - 2-1/4" BASE

4T-165

FINISHES & PRICE GROUPS:

PRICE GROUP A

- Polished Chrome (1)

PRICE GROUP B

- Gloss Black (15)
- Almond (19)
- Flat Black (20)

PRICE GROUP C

- Polished Brass & PVD (2)
- Antique Brass (3)
- Satin Nickel (31)
- Oil Rubbed Bronze (34)
- Stainless/Brushed Nickel (50)

PRICE GROUP D

- Satin Gold (35)
- Venetian Bronze (47)

TUB SPOUTS & REMODEL PLATE

4T-166, 4T-168 & 4T-541

4T-166

FINISHES & PRICE GROUPS:

PRICE GROUP A

- Polished Chrome (1)

PRICE GROUP C

- Polished Brass & PVD (2)
- Antique Brass (3)
- Satin Nickel (31)
- Oil Rubbed Bronze (34)
- Stainless/Brushed Nickel (50)



4T-166

1/2" IPS BACK CONNECT BRASS TUB SPOUT | 4T-166

5" LENGTH - 2-3/16" BASE

4T-168

FINISHES & PRICE GROUPS:

PRICE GROUP A

- Polished Chrome (1)

PRICE GROUP B

- White (13)

PRICE GROUP C

- Polished Brass & PVD (2)
- Satin Nickel (31)
- Oil Rubbed Bronze (34)
- Stainless/Brushed Nickel (50)

PRICE GROUP D

- Satin Gold (35)
- Venezian Bronze (47)



4T-168

8-1/2" BRASS TUB SPOUT | 4T-168

1/2" TO 3/4" IPS BACK CONNECT

INCLUDES REDUCING BUSHING

4T-541

FINISHES & PRICE GROUPS:

PRICE GROUP A

- Polished Chrome (1)

PRICE GROUP B

- White (13)
- Biscuit (16)
- Almond (19)
- Flat Black (20)

PRICE GROUP C

- Polished Brass & PVD (2)
- Antique Brass (3)
- Polished Nickel (30)
- Satin Nickel (31)
- Oil Rubbed Bronze (34)
- Stainless/Brushed Nickel (50)

PRICE GROUP D

- Venezian Bronze (47)



4T-541

ONE HOLE REMODEL PLATE | 4T-541

FITS MOEN AND DELTA

13" LENGTH, 7 3/8" HEIGHT

HOLE IS 5" DIAMETER

DIVERTER SPOUTS

4T-162, 4T-163 & 4T-167

4T-162



**1/2" IPS FRONT CONNECT ZINC DIE CAST
DIVERTER SPOUT | 4T-162**

5" LENGTH - 2-5/8" BASE

4T-162

FINISHES & PRICE GROUPS:

PRICE GROUP A

- Polished Chrome (1)

PRICE GROUP B

- White (13)
- Flat Black (20)

PRICE GROUP C

- Polished Brass & PVD (2)
- Antique Brass (3)
- Satin Nickel (31)
- Oil Rubbed Bronze (34)
- Stainless/Brushed Nickel (50)

4T-163



**QUICK CONNECT ZINC DIE CAST DIVERTER
TUB SPOUT | 4T-163**

5" LENGTH - 2-3/8" BASE

4T-163

FINISHES & PRICE GROUPS:

PRICE GROUP A

- Polished Chrome (1)

PRICE GROUP B

- White (13)
- Flat Black (20)

PRICE GROUP C

- Polished Brass & PVD (2)
- Satin Nickel (31)
- Oil Rubbed Bronze (34)
- Stainless/Brushed Nickel (50)

4T-167



**1/2" - 3/4" IPS BACK CONNECT BRASS
DIVERTER SPOUT | 4T-167**

5" LENGTH - INCLUDES REDUCING BUSHING

4T-167

FINISHES & PRICE GROUPS:

PRICE GROUP A

- Polished Chrome (1)

PRICE GROUP B

- White (13)
- Almond (19)
- Flat Black (20)

PRICE GROUP C

- Polished Brass & PVD (2)
- Antique Brass (3)
- Polished Nickel (30)
- Satin Nickel (31)
- Oil Rubbed Bronze (34)
- Stainless/Brushed Nickel (50)

PRICE GROUP D

- Polished Gold (8)
- Satin Gold (35)
- Venezian Bronze (47)

CLOSET SUPPLY SET

4T-715 & 4T-715X

CLOSET SUPPLY SET | 4T-715

INCLUDES

- 3/8" IPS X 3/8 OD" COMP ANGLE STOP (4T-38638)
- 3/8" OD X 20" FLATHEAD RIGID SUPPLY TUBE (4T-2739)
- 3/8" X 4" NIPPLE (4T-430N)
- 3/8" IPS SURE GRIP FLANGE (4T- 28438)



CLOSET SUPPLY SET WITH CROSS HANDLE | 4T-715X

INCLUDES

- 3/8" IPS X 3/8 OD" COMP CROSS HANDLE ANGLE STOP (4T-38638X)
- 3/8" OD X 20" FLATHEAD RIGID SUPPLY TUBE (4T- 2739)
- 3/8" X 4" NIPPLE (4T-430N)
- 3/8" IPS SURE GRIP FLANGE (4T-28438)



4T-715 & 4T-715X

FINISHES & PRICE GROUPS:

PRICE GROUP A

- Polished Chrome (1)

PRICE GROUP B

- White (13)
- Flat Black (20)

PRICE GROUP C

- Polished Brass & PVD (2)
- Antique Brass (3)
- Satin Brass (5)
- Satin Chrome (6)
- Polished Nickel (30)
- Satin Nickel (31)
- Oil Rubbed Bronze (34)
- Stainless/Brushed Nickel (50)

PRICE GROUP D

- Satin Gold (35)
- Light Brushed Bronze (38)
- Venezian Bronze (47)

CLOSET SUPPLY SET

4T-716 & 4T-716X



4T-716

CLOSET SUPPLY SET | 4T-716

INCLUDES

- 1/2" IPS X 1/2" OR 7/16" SJ ANGLE STOP (4T-286)
- 1/2" OD X 20" FLAT HEAD RIGID SUPPLY TUBE (4T-2781D)
- 1/2" X 4" NIPPLE (4T-405N)
- 1/2" IPS SURE GRIP FLANGE (4T-284)



4T-716X

CLOSET SUPPLY SET WITH CROSS HANDLE | 4T-716X

INCLUDES

- 1/2" IPS X 1/2" OR 7/16" SJ CROSS HANDLE ANGLE STOP (4T-286X)
- 1/2" OD X 20" FLAT HEAD RIGID SUPPLY TUBE (4T-2781D)
- 1/2" X 4" NIPPLE (4T-405N)
- 1/2" IPS SURE GRIP FLANGE (4T-284)

4T-716 & 4T-716X FINISHES & PRICE GROUPS:

PRICE GROUP A

- Polished Chrome (1)

PRICE GROUP B

- White (13)
- Flat Black (20)

PRICE GROUP C

- Polished Brass & PVD (2)
- Antique Brass (3)
- Satin Brass (5)
- Polished Nickel (30)
- Satin Nickel (31)
- Oil Rubbed Bronze (34)
- Stainless/Brushed Nickel (50)

PRICE GROUP D

- Satin Gold (35)
- Light Brushed Bronze (38)
- Venezian Bronze (47)

CLOSET SUPPLY SET

4T-717 & 4T-717X

CLOSET SUPPLY SET | 4T-717

INCLUDES

- 1/2" COMP X 3/8" OD COMP ANGLE STOP (4T-28738)
- 3/8" OD X 20" FLAT HEAD RIGID SUPPLY TUBE (4T-2739)
- 5/8" OD SURE GRIP FLANGE (4T-285)



4T-717 & 4T-717X

FINISHES & PRICE GROUPS:

PRICE GROUP A

- Polished Chrome (1)

PRICE GROUP B

- White (13)
- Biscuit (16)
- Flat Black (20)

PRICE GROUP C

- Polished Brass & PVD (2)
- Antique Brass (3)
- Antique Nickel (Pewter) (4)
- Satin Brass (5)
- Satin Chrome (6)
- Polished Nickel (30)
- Satin Nickel (31)
- Oil Rubbed Bronze (34)
- Stainless/Brushed Nickel (50)

PRICE GROUP D

- Light Gold (32)
- Antique Bronze (33)
- Satin Gold (35)
- Antique Copper (36)
- Satin Copper (37)
- Light Brushed Bronze (38)
- Venezian Bronze (47)



CLOSET SUPPLY SET WITH CROSS HANDLE | 4T-717X

INCLUDES

- 1/2" COMP X 3/8" OD COMP CROSS HANDLE ANGLE STOP (4T-28738X)
- 3/8" OD X 20" FLAT HEAD RIGID SUPPLY TUBE (4T-2739)
- 5/8" OD SURE GRIP FLANGE (4T-285)

CLOSET SUPPLY SET

4T-718 & 4T-718X



4T-718

CLOSET SUPPLY SET | 4T-718

INCLUDES

- 1/2" COMP X 1/2" OR 7/16" SJ ANGLE STOP (4T-287)
- 1/2" OD X 20" FLAT HEAD RIGID SUPPLY TUBE (4T-2781D)
- 5/8" OD SURE GRIP FLANGE (4T-285)



4T-718X

CLOSET SUPPLY SET WITH CROSS HANDLE | 4T-718X

INCLUDES

- 1/2" COMP X 1/2" OR 7/16" SJ CROSS HANDLE ANGLE STOP (4T-287X)
- 1/2" OD X 20" FLAT HEAD RIGID SUPPLY TUBE (4T-2781D)
- 5/8" OD SURE GRIP FLANGE (4T-285)

4T-718 & 4T-718X FINISHES & PRICE GROUPS:

PRICE GROUP A

- Polished Chrome (1)

PRICE GROUP B

- White (13)
- Flat Black (20)

PRICE GROUP C

- Polished Brass & PVD (2)
- Antique Brass (3)
- Satin Brass (5)
- Polished Nickel (30)
- Satin Nickel (31)
- Oil Rubbed Bronze (34)
- Stainless/Brushed Nickel (50)

PRICE GROUP D

- Venezian Bronze (47)

LAVATORY SUPPLY SETS

4T-725, 4T-725X, 4T-726 & 4T-726X

LAVATORY SUPPLY SET | 4T-725

INCLUDES

- (2) 3/8" IPS X 3/8 OD" COMP ANGLE STOPS (4T-38638)
- (2) 3/8" OD X 20" BULLNOSE RIGID SUPPLY TUBES (4T-2838)
- (2) 3/8" X 4" NIPPLES (4T-430N)
- (2) 3/8" IPS SURE GRIP FLANGES (4T-28438)



4T-725 & 4T-725X

FINISHES & PRICE GROUPS:

PRICE GROUP A

- Polished Chrome (1)

PRICE GROUP B

- White (13)
- Flat Black (20)

PRICE GROUP C

- Polished Brass & PVD (2)
- Antique Brass (3)
- Satin Brass (5)
- Satin Chrome (6)
- Polished Nickel (30)
- Satin Nickel (31)
- Oil Rubbed Bronze (34)
- Stainless/Brushed Nickel (50)

PRICE GROUP D

- Satin Gold (35)
- Light Brushed Bronze (38)
- Venezian Bronze (47)

LAVATORY SUPPLY SET WITH CROSS HANDLE | 4T-725X

INCLUDES

- (2) 3/8" IPS X 3/8 OD" COMP CROSS HANDLE ANGLE STOPS (4T-38638X)
- (2) 3/8" OD X 20" BULLNOSE RIGID SUPPLY TUBES (4T-2838)
- (2) 3/8" X 4" NIPPLES (4T-430N)
- (2) 3/8" IPS SURE GRIP FLANGES (4T-28438)



4T-726 & 4T-726X

FINISHES & PRICE GROUPS:

PRICE GROUP A

- Polished Chrome (1)

PRICE GROUP B

- White (13)
- Flat Black (20)

PRICE GROUP C

- Polished Brass & PVD (2)
- Antique Brass (3)
- Satin Brass (5)
- Polished Nickel (30)
- Satin Nickel (31)
- Oil Rubbed Bronze (34)
- Stainless/Brushed Nickel (50)

PRICE GROUP D

- Satin Gold (35)
- Light Brushed Bronze (38)
- Venezian Bronze (47)

LAVATORY SUPPLY SET | 4T-726

INCLUDES

- (2) 1/2" IPS X 3/8 OD" COMP ANGLE STOPS (4T-28638)
- (2) 3/8" OD X 20" BULLNOSE RIGID SUPPLY TUBES (4T-2838)
- (2) 1/2" X 4" NIPPLES (4T-405N)
- (2) 1/2" IPS SURE GRIP FLANGES (4T-284)

LAVATORY SUPPLY SET WITH CROSS HANDLE | 4T-726X

INCLUDES

- (2) 1/2" IPS X 3/8 OD" COMP CROSS HANDLE ANGLE STOPS (4T-28638X)
- (2) 3/8" OD X 20" BULLNOSE RIGID SUPPLY TUBES (4T-2838)
- (2) 1/2" X 4" NIPPLES (4T-405N)
- (2) 1/2" IPS SURE GRIP FLANGES (4T-284)

4T-28638X



LAVATORY SUPPLY SET

4T-727 & 4T-727X



4T-727

LAVATORY SUPPLY SET | 4T-727

INCLUDES

- (2) 1/2" IPS X 1/2" OR 7/16" SJ ANGLE STOPS (4T-286)
- (2) 1/2" OD X 20" BULLNOSE RIGID SUPPLY TUBES (4T-2800)
- (2) 1/2" X 4" NIPPLES (4T-405N)
- (2) 1/2" IPS SURE GRIP FLANGES (4T-284)



4T-727X

LAVATORY CROSS HANDLE SUPPLY SET | 4T-727X

INCLUDES

- (2) 1/2" IPS X 1/2" OR 7/16" SJ CROSS HANDLE ANGLE STOPS (4T-286X)
- (2) 1/2" OD X 20" BULLNOSE RIGID SUPPLY TUBES (4T-2800)
- (2) 1/2" X 4" NIPPLES (4T-405N)
- (2) 1/2" IPS SURE GRIP FLANGES (4T-284)

4T-727 & 4T-727X FINISHES & PRICE GROUPS:

PRICE GROUP A

- Polished Chrome (1)

PRICE GROUP B

- White (13)
- Flat Black (20)

PRICE GROUP C

- Polished Brass & PVD (2)
- Antique Brass (3)
- Satin Brass (5)
- Polished Nickel (30)
- Satin Nickel (31)
- Oil Rubbed Bronze (34)
- Stainless/Brushed Nickel (50)

PRICE GROUP D

- Satin Gold (35)
- Light Brushed Bronze (38)
- Venetian Bronze (47)

LAVATORY SUPPLY SET

4T-728 & 4T-728X

LAVATORY SUPPLY SET | 4T-728

INCLUDES

- (2) 1/2" COMP X 3/8" OD COMP ANGLE STOPS (4T-28738)
- (2) 3/8" OD X 20" BULLNOSE RIGID SUPPLY TUBES (4T-2838)
- (2) 5/8" OD SURE GRIP FLANGES (4T-285)



4T-728

4T-728 & 4T-728X

FINISHES & PRICE GROUPS:

PRICE GROUP A

- Polished Chrome (1)

PRICE GROUP B

- White (13)
- Biscuit (16)
- Flat Black (20)

PRICE GROUP C

- Polished Brass & PVD (2)
- Antique Brass (3)
- Antique Nickel (Pewter) (4)
- Satin Brass (5)
- Satin Chrome (6)
- Polished Nickel (30)
- Satin Nickel (31)
- Oil Rubbed Bronze (34)
- Stainless/Brushed Nickel (50)

PRICE GROUP D

- Light Gold (32)
- Antique Bronze (33)
- Satin Gold (35)
- Satin Copper (37)
- Light Brushed Bronze (38)
- Venezian Bronze (47)



4T-728X

LAVATORY SUPPLY SET WITH CROSS HANDLE | 4T-728X

INCLUDES

- (2) 1/2" COMP X 3/8" OD COMP CROSS HANDLE ANGLE STOPS (4T-28738X)
- (2) 3/8" OD X 20" BULLNOSE RIGID SUPPLY TUBES (4T-2838)
- (2) 5/8" OD SURE GRIP FLANGES (4T-285)

FLAT HEAD RIGID SUPPLY TUBES

FOR TOILET APPLICATIONS [4T-2738](#), [4T-2739](#), [4T-2780](#) & [4T-2781D](#)

[4T-2738](#)



3/8" OD X 12" FLAT HEAD RIGID SUPPLY TUBE | [4T-2738](#)

SOLD EACH

[4T-2739](#)



3/8" OD X 20" FLAT HEAD RIGID SUPPLY TUBE | [4T-2739](#)

SOLD EACH

**1/2" OD X 12" FLAT HEAD RIGID
SUPPLY TUBE | [4T-2780](#)**

SOLD EACH

[4T-2780](#)



**1/2" OD X 20" FLAT HEAD RIGID
SUPPLY TUBE | [4T-2781D](#)**

SOLD EACH

[4T-2781D](#)



[4T-2738](#), [4T-2739](#),
[4T-2780](#) & [4T-2781D](#)

FINISHES & PRICE GROUPS:

PRICE GROUP A

- Polished Chrome (1)

PRICE GROUP B

- White (13)
- Biscuit (16)
- Flat Black (20)

PRICE GROUP C

- Polished Brass & PVD (2)
- Antique Brass (3)
- Antique Nickel (Pewter) (4)
- Satin Brass (5)
- Satin Chrome (6)
- Polished Nickel (30)
- Satin Nickel (31)
- Oil Rubbed Bronze (34)
- Stainless/Brushed Nickel (50)

PRICE GROUP D

- Light Gold (32)
- Antique Bronze (33)
- Satin Gold (35)
- Antique Copper (36)
- Light Brushed Bronze (38)
- Venezian Bronze (47)

1/2" BULLNOSE RIGID SUPPLY TUBES

FOR LAVATORY APPLICATIONS [4T-2799](#), [4T-2800](#) & [4T-2839](#)

1/2" OD X 12" BULLNOSE RIGID SUPPLY TUBE | [4T-2799](#)

SOLD EACH



1/2" OD X 20" BULLNOSE RIGID SUPPLY TUBE | [4T-2800](#)

SOLD EACH



1/2" OD X 30" BULLNOSE RIGID SUPPLY TUBE | [4T-2839](#)

SOLD EACH



[4T-2799](#), [4T-2800](#) & [4T-2839](#)

FINISHES & PRICE GROUPS:

PRICE GROUP A

- Polished Chrome (1)

PRICE GROUP B

- White (13)
- Flat Black (20)

PRICE GROUP C

- Polished Brass & PVD (2)
- Antique Brass (3)
- Antique Nickel (Pewter) (4)
- Satin Brass (5)

- Satin Chrome (6)
- Polished Nickel (30)
- Satin Nickel (31)
- Oil Rubbed Bronze (34)
- Stainless/Brushed Nickel (50)

PRICE GROUP D

- Polished Gold (8)
- Satin Gold (35)
- Light Brushed Bronze (38)
- Venezian Bronze (47)

3/8" BULLNOSE RIGID SUPPLY TUBES

4T-28328, 4T-2838 & 4T-2840



3/8" OD X 12" BULLNOSE RIGID SUPPLY TUBE | 4T-28328

SOLD EACH

4T-28328



4T-2838

3/8" OD X 20" BULLNOSE RIGID SUPPLY TUBE | 4T-2838

SOLD EACH



4T-2840

3/8" OD X 30" BULLNOSE RIGID SUPPLY TUBE | 4T-2840

SOLD EACH



4T-28328, 4T-2838 & 4T-2840 FINISHES & PRICE GROUPS:

PRICE GROUP A

- Polished Chrome (1)

PRICE GROUP B

- White (13)
- Biscuit (16)
- Flat Black (20)

PRICE GROUP C

- Polished Brass & PVD (2)
- Antique Brass (3)
- Antique Nickel (Pewter) (4)
- Satin Brass (5)
- Satin Chrome (6)
- Polished Nickel (30)

- Satin Nickel (31)
- Oil Rubbed Bronze (34)
- Stainless/Brushed Nickel (50)

PRICE GROUP D

- Polished Gold (8)
- Light Gold (32)
- Antique Bronze (33)
- Satin Gold (35)
- Antique Copper (36)
- Light Brushed Bronze (38)
- Aged Pewter (40)
- Venezian Bronze (47)

1/2" IPS ANGLE STOPS

4T-286, 4T-286X, 4T-28638 & 4T-28638X

OVAL HANDLE SLIP JOINT ANGLE STOP | 4T-286

1/2" IPS X 1/2" OR 7/16" SLIP JOINT

USE WITH 1/2" OD RISER



4T-286

CROSS HANDLE ANGLE STOP | 4T-286X

1/2" IPS X 1/2" OR 7/16" SLIP JOINT

USE WITH 1/2" OD RISER



4T-286X

OVAL HANDLE ANGLE STOP | 4T-28638

1/2" IPS X 3/8" OD COMPRESSION

USE WITH 3/8" OD RISER



4T-28638

4T-286, 4T-286X, 4T-28638 & 4T-28638X FINISHES & PRICE GROUPS:

PRICE GROUP A

- Polished Chrome (1)

PRICE GROUP B

- White (13)
- Flat Black (20)

PRICE GROUP C

- Polished Brass & PVD (2)
- Antique Brass (3)
- Satin Brass (5)
- Polished Nickel (30)
- Satin Nickel (31)
- Oil Rubbed Bronze (34)
- Stainless/Brushed Nickel (50)

PRICE GROUP D

- Satin Gold (35)
- Light Brushed Bronze (38)
- Venezian Bronze (47)

CROSS HANDLE ANGLE STOP | 4T-28638X

1/2" IPS X 3/8" OD COMPRESSION

USE WITH 3/8" OD RISER



4T-28638X

1/2" IPS ANGLE STOPS

4T-39612 & 4T-39612X

OVAL HANDLE ANGLE STOP | 4T-39612

1/2" IPS X 1/2" OD COMPRESSION

USE WITH 1/2" OD RISER



4T-39612



4T-39612X

CROSS HANDLE ANGLE STOP | 4T-39612X

1/2" IPS X 1/2" OD COMPRESSION

USE WITH 1/2" OD RISER

4T-39612 & 4T-39612X FINISHES & PRICE GROUPS:

PRICE GROUP A

- Polished Chrome (1)

PRICE GROUP C

- Polished Brass & PVD (2)
- Polished Nickel (30)
- Satin Nickel (31)
- Oil Rubbed Bronze (34)
- Stainless/Brushed Nickel (50)



1/2" NOMINAL COMPRESSION ANGLE STOPS

4T-287, 4T-287X, 4T-39312 & 4T-39312X

OVAL HANDLE SLIP JOINT ANGLE STOP | 4T-287

1/2" NOMINAL COMPRESSION X 1/2" OD OR 7/16" SJ

USE WITH 1/2" OD RISER

4T-287 & 4T-287X

FINISHES & PRICE GROUPS:

PRICE GROUP A

- Polished Chrome (1)

PRICE GROUP B

- White (13)
- Flat Black (20)

PRICE GROUP C

- Polished Brass & PVD (2)
- Antique Brass (3)
- Satin Brass (5)
- Polished Nickel (30)
- Satin Nickel (31)
- Oil Rubbed Bronze (34)
- Stainless/Brushed Nickel (50)

PRICE GROUP D

- Venezian Bronze (47)



4T-287



4T-287X

CROSS HANDLE SLIP JOINT ANGLE STOP | 4T-287X

1/2" NOMINAL COMPRESSION X 1/2" OD OR 7/16" SJ

USE WITH 1/2" OD RISER

OVAL HANDLE ANGLE STOP | 4T-39312

1/2" NOMINAL COMPRESSION X 1/2" OD COMPRESSION

USE WITH 1/2" OD RISER



4T-39312



4T-39312X

CROSS HANDLE ANGLE STOP | 4T-39312X

1/2" NOMINAL COMPRESSION X 1/2" OD COMPRESSION

USE WITH 1/2" OD RISER

4T-39312 & 4T-39312X

FINISHES & PRICE GROUPS:

PRICE GROUP A

- Polished Chrome (1)

PRICE GROUP C

- Polished Brass & PVD (2)
- Antique Nickel (Pewter) (4)
- Satin Brass (5)
- Satin Nickel (31)
- Oil Rubbed Bronze (34)
- Stainless/Brushed Nickel (50)

PRICE GROUP D

- Satin Gold (35)

1/2" NOMINAL COMPRESSION ANGLE STOPS

4T-28738 & 4T-28738X



OVAL HANDLE ANGLE STOP | 4T-28738

1/2" NOMINAL COMPRESSION X 3/8" OD COMPRESSION

USE WITH 3/8" OD RISER

4T-28738



4T-28738X

CROSS HANDLE ANGLE STOP | 4T-28738X

1/2" NOMINAL COMPRESSION X 3/8" OD COMPRESSION

USE WITH 3/8" OD RISER

4T-28738 & 4T-28738X FINISHES & PRICE GROUPS:

PRICE GROUP A

- Polished Chrome (1)

PRICE GROUP B

- White (13)
- Biscuit (16)
- Flat Black (20)

PRICE GROUP C

- Polished Brass & PVD (2)
- Antique Brass (3)
- Antique Nickel (Pewter) (4)
- Satin Brass (5)
- Satin Chrome (6)
- Polished Nickel (30)
- Satin Nickel (31)
- Oil Rubbed Bronze (34)
- Stainless/Brushed Nickel (50)

PRICE GROUP D

- Uncoated Polished Brass (11)
- Light Gold (32)
- Antique Bronze (33)
- Satin Gold (35)
- Antique Copper (36)
- Satin Copper (37)
- Light Brushed Bronze (38)
- Venezian Bronze (47)

1/2" NOMINAL COMPRESSION ANGLE STOPS-QUARTER TURN

4T-55138

QUARTER TURN 1/2" NOMINAL COMPRESSION X 3/8" OD COMPRESSION ANGLE STOP | 4T-55138

THE QUARTER TURN VERSION OF OUR POPULAR 4T-28738 ANGLE STOP



4T-55138



4T-55138

FINISHES & PRICE GROUPS:

PRICE GROUP A

- Polished Chrome (1)

PRICE GROUP B

- Flat Black (20)

PRICE GROUP C

- Polished Brass & PVD (2)
- Antique Brass (3)
- Satin Brass (5)
- Polished Nickel (30)
- Satin Nickel (31)
- Oil Rubbed Bronze (34)
- Stainless/Brushed Nickel (50)

PRICE GROUP D

- Uncoated Polished Brass (11)
- Satin Gold (35)
- Light Brushed Bronze (38)
- Venezian Bronze (47)

1/2" IPS STRAIGHT STOPS

4T-288, 4T-288X, 4T-28838 & 4T-28838X



4T-288

OVAL HANDLE SLIP JOINT STRAIGHT STOP | 4T-288

1/2" IPS X 1/2" OR 7/16" SJ

USE WITH 1/2" OD RISER INLET IS 1/2" IPS

OUTLET IS 1/2" OD



4T-288X

CROSS HANDLE SLIP JOINT STRAIGHT STOP | 4T-288X

1/2" IPS X 1/2" OR 7/16" SJ

USE WITH 1/2" OD RISER INLET IS 1/2" IPS

OUTLET IS 1/2" OD



4T-28838

OVAL HANDLE STRAIGHT STOP | 4T-28838

1/2" IPS X 3/8" OD COMPRESSION

USE WITH 3/8" OD RISER



4T-28838X

CROSS HANDLE STRAIGHT STOP | 4T-28838X

1/2" IPS X 3/8" OD COMPRESSION

USE WITH 3/8" OD RISER

4T-288, 4T-288X, 4T-28838 & 4T-28838X FINISHES & PRICE GROUPS:

PRICE GROUP A

- Polished Chrome (1)

PRICE GROUP B

- Satin Chrome (6)
(4T-28838 only)
- Flat Black (20)

PRICE GROUP C

- Polished Brass & PVD (2)
- Antique Brass (3)
- Satin Chrome (6)
- Polished Nickel (30)
- Satin Nickel (31)
- Oil Rubbed Bronze (34)
- Stainless/Brushed Nickel (50)

PRICE GROUP D

- Antique Brass (3)
4T-28838 only
- Satin Gold (35)
- Venezian Bronze (47)

1/2" IPS STRAIGHT STOPS

4T-39812 & 4T-39812X

OVAL HANDLE STRAIGHT STOP | 4T-39812

1/2" IPS X 1/2" OD COMPRESSION

USE WITH 1/2" OD RISER



4T-39812



4T-39812X

4T-39812 & 4T-39812X

FINISHES & PRICE GROUPS:

PRICE GROUP A

- Polished Chrome (1)

PRICE GROUP B

- Flat Black (20)

PRICE GROUP C

- Polished Brass & PVD (2)
- Polished Nickel (30)
- Satin Nickel (31)
- Oil Rubbed Bronze (34)
- Stainless/Brushed Nickel (50)

PRICE GROUP D

- Satin Gold (35)

CROSS HANDLE STRAIGHT STOP | 4T-39812X



1/2" NOMINAL COMPRESSION STRAIGHT STOPS

4T-289, 4T-289X, 4T-39412 & 4T-39412X



4T-289

OVAL HANDLE STRAIGHT STOP | 4T-289

1/2" NOMINAL COMPRESSION X 1/2" OR 7/16" SLIP JOINT

USE WITH 1/2" OD RISER



4T-289X

CROSS HANDLE STRAIGHT STOP 4T-289X

1/2" NOMINAL COMPRESSION X 1/2" OR 7/16"

SLIP JOINT USE WITH 1/2" OD RISER



4T-39412

OVAL HANDLE STRAIGHT STOP | 4T-39412

1/2" NOMINAL COMPRESSION X 1/2" OD COMPRESSION

USE WITH 1/2" OD RISER



4T-39412X

CROSS HANDLE STRAIGHT STOP | 4T-39412X

1/2" NOMINAL COMPRESSION X 1/2" OD COMPRESSION

USE WITH 1/2" OD RISER

4T-289 & 4T-289X

FINISHES & PRICE GROUPS:

PRICE GROUP A

- Polished Chrome (1)

PRICE GROUP B

- Flat Black (20)

PRICE GROUP C

- Polished Brass & PVD (2)
- Polished Nickel (30)
- Satin Nickel (31)
- Oil Rubbed Bronze (34)
- Stainless/Brushed Nickel (50)

PRICE GROUP D

- Satin Gold (35)

4T-39412 & 4T-39412X

FINISHES & PRICE GROUPS:

PRICE GROUP A

- Polished Chrome (1)

PRICE GROUP B

- Flat Black (20)

PRICE GROUP C

- Polished Brass & PVD (2)
- Antique Brass (3)
- Satin Brass (5)
- Polished Nickel (30)
- Satin Nickel (31)
- Oil Rubbed Bronze (34)
- Stainless/Brushed Nickel (50)

PRICE GROUP D

- Satin Gold (35)
- Light Brushed Bronze (38)
- Venezian Bronze (47)

1/2" NOMINAL COMPRESSION STRAIGHT STOPS

4T-28938 & 4T-28938X

OVAL HANDLE STRAIGHT STOP | 4T-28938

1/2" NOMINAL COMPRESSION X 3/8" OD COMPRESSION

USE WITH 3/8" OD RISER



4T-28938



4T-28938X

4T-28938 & 4T-28938X FINISHES & PRICE GROUPS:

PRICE GROUP A

- Polished Chrome (1)

PRICE GROUP B

- White (13)
- Flat Black (20)

PRICE GROUP C

- Polished Brass & PVD (2)
- Antique Brass (3)
- Antique Nickel (Pewter) (4)
- Satin Brass (5)
- Satin Chrome (6)
- Polished Nickel (30)
- Satin Nickel (31)
- Oil Rubbed Bronze (34)
- Stainless/Brushed Nickel (50)

PRICE GROUP D

- Satin Gold (35)
- Light Brushed Bronze (38)
- Venezian Bronze (47)

CROSS HANDLE STRAIGHT STOP | 4T-28938X

1/2" NOMINAL COMPRESSION X 3/8" OD COMPRESSION

USE WITH 3/8" OD RISER

3/8" IPS ANGLE STOPS

4T-38638 & 4T-38638X



OVAL HANDLE ANGLE STOP | 4T-38638

3/8" IPS X 3/8" OD COMPRESSION

USE WITH 3/8" OD RISER

4T-38638



4T-38638X

CROSS HANDLE ANGLE STOP | 4T-38638X

3/8" IPS X 3/8" OD COMPRESSION

USE WITH 3/8" OD RISER

4T-38638 & 4T-38638X FINISHES & PRICE GROUPS:

PRICE GROUP A

- Polished Chrome (1)

PRICE GROUP B

- White (13)
- Flat Black (20)

PRICE GROUP C

- Polished Brass & PVD (2)
- Antique Brass (3)
- Satin Brass (5)
- Satin Chrome (6)
- Polished Nickel (30)
- Satin Nickel (31)
- Oil Rubbed Bronze (34)
- Stainless/Brushed Nickel (50)

PRICE GROUP D

- Satin Gold (35)
- Light Brushed Bronze (38)
- Venezian Bronze (47)



3/8" IPS STRAIGHT STOPS

4T-38838 & 4T-38838X

OVAL HANDLE STRAIGHT STOP | 4T-38838

3/8" IPS X 3/8" OD COMPRESSION

USE WITH 3/8" OD RISER



4T-38838



4T-38838X

4T-38838 & 4T-38838X

FINISHES & PRICE GROUPS:

PRICE GROUP A

- Polished Chrome (1)

PRICE GROUP B

- Flat Black (20)

PRICE GROUP C

- Polished Brass & PVD (2)
- Antique Brass (3)
- Satin Brass (5)
- Polished Nickel (30)
- Satin Nickel (31)
- Oil Rubbed Bronze (34)
- Stainless/Brushed Nickel (50)

PRICE GROUP D

- Satin Gold (35)
- Light Brushed Bronze (38)
- Venezian Bronze (47)

CROSS HANDLE STRAIGHT STOP | 4T-38838X

3/8" IPS X 3/8" OD COMPRESSION

USE WITH 3/8" OD RISER



STOPS WITH 5" EXTENSION TUBES

4T-29212, 4T-29212X, 4T-29412 & 4T-29412X



4T-29212

OVAL HANDLE ANGLE STOP W/ 5" EXTENSION TUBE | 4T-29212

1/2" NOMINAL SWEAT X 1/2" OD COMPRESSION

INCLUDES BELL FLANGE (4T-307)



4T-29212X

CROSS HANDLE ANGLE STOP W/ 5" EXTENSION TUBE | 4T-29212X

1/2" NOMINAL SWEAT X 1/2" OD COMPRESSION

INCLUDES BELL FLANGE (4T-307)



4T-29412

OVAL HANDLE STRAIGHT STOP W/ 5" EXTENSION TUBE | 4T-29412

1/2" NOMINAL SWEAT X 1/2" OD COMPRESSION

INCLUDES BELL FLANGE (4T-307)



4T-29412X

CROSS HANDLE STRAIGHT STOP W/ 5" EXTENSION TUBE | 4T-29412X

1/2" NOMINAL SWEAT X 1/2" OD COMPRESSION

INCLUDES BELL FLANGE (4T-307)

4T-29212, 4T-29212X, 4T-29412 & 4T-29412X FINISHES & PRICE GROUPS:

PRICE GROUP A

- Polished Chrome (1)

PRICE GROUP B

- Flat Black (20)

PRICE GROUP C

- Polished Brass & PVD (2)
- Antique Brass (3)
- Satin Brass (5)
- Polished Nickel (30)
- Satin Nickel (31)
- Oil Rubbed Bronze (34)
- Stainless/Brushed Nickel (50)

PRICE GROUP D

- Satin Gold (35)
4T-29212 & 4T-29212X only
- Light Brushed Bronze (38)
4T-29212 & 4T-29212X only

STOPS WITH 5" EXTENSION TUBES

4T-29238, 4T-29238X, 4T-29438, & 4T-29438X

OVAL HANDLE ANGLE STOP W/ 5" EXTENSION TUBE | 4T-29238

1/2" NOMINAL SWEAT X 3/8" OD COMPRESSION

INCLUDES BELL FLANGE (4T-307)



CROSS HANDLE ANGLE STOP W/ 5" EXTENSION TUBE | 4T-29238X

1/2" NOMINAL SWEAT X 3/8" OD COMPRESSION

INCLUDES BELL FLANGE (4T-307)



OVAL HANDLE STRAIGHT STOP W/ 5" EXTENSION TUBE | 4T-29438

1/2" NOMINAL SWEAT X 3/8" OD COMPRESSION

INCLUDES BELL FLANGE (4T-307)



CROSS HANDLE STRAIGHT STOP W/ 5" EXTENSION TUBE | 4T-29438X

1/2" NOMINAL SWEAT X 3/8" OD COMPRESSION

INCLUDES BELL FLANGE (4T-307)

4T-29238, 4T-29238X, 4T-29438, & 4T-29438X FINISHES & PRICE GROUPS:

PRICE GROUP A

- Polished Chrome (1)

PRICE GROUP B

- Flat Black (20)

PRICE GROUP C

- Polished Brass & PVD (2)
- Antique Brass (3)
- Satin Brass (5)
- Polished Nickel (30)
- Satin Nickel (31)
- Oil Rubbed Bronze (34)
- Stainless/Brushed Nickel (50)

PRICE GROUP D

- Satin Gold (35)
- Light Brushed Bronze (38)
- Venezian Bronze (47)

STOPS WITH CORRUGATED RISERS

4T-3812, 4T-3812X, 4T-3815, 4T-3815X, 4T-3820 & 4T-3820X



4T-3812

OVAL HANDLE ANGLE STOP W/ CORRUGATED RISER | 4T-3812

3/8" OD X 12" FLEX RISER AND 1/2" COMPRESSION ANGLE STOP

INCLUDES 5/8" OD SURE GRIP FLANGE (4T-285)



4T-3812X

CROSS HANDLE ANGLE STOP W/ CORRUGATED RISER | 4T-3812X

3/8" OD X 12" FLEX RISER AND 1/2" COMPRESSION ANGLE STOP

INCLUDES 5/8" OD SURE GRIP FLANGE (4T-285)



4T-3815

OVAL HANDLE ANGLE STOP W/ CORRUGATED RISER | 4T-3815

3/8" OD X 15" FLEX RISER AND
1/2" COMPRESSION ANGLE STOP

INCLUDES 5/8" OD SURE GRIP FLANGE (4T-285)



4T-3815X

CROSS HANDLE ANGLE STOP W/ CORRUGATED RISER | 4T-3815X

3/8" OD X 15" FLEX RISER AND
1/2" COMPRESSION ANGLE STOP

INCLUDES 5/8" OD SURE GRIP FLANGE (4T-285)



4T-3820

OVAL HANDLE ANGLE STOP W/ CORRUGATED RISER | 4T-3820

3/8" OD X 20" FLEX RISER AND 1/2"
COMPRESSION ANGLE STOP

INCLUDES 5/8" OD SURE GRIP FLANGE (4T-285)



4T-3820X

CROSS HANDLE ANGLE STOP W/ CORRUGATED RISER | 4T-3820X

3/8" OD X 20" FLEX RISER AND 1/2"
COMPRESSION ANGLE STOP

INCLUDE 5/8" OD SURE GRIP FLANGE (4T-285)

4T-3812, 4T-3812X, 4T-3815 & 4T-3815X FINISHES & PRICE GROUPS:

PRICE GROUP A

- Polished Chrome (1)

PRICE GROUP B

- Flat Black (20)

PRICE GROUP C

- Polished Brass & PVD (2)
- Antique Brass (3)
- Antique Nickel (Pewter) (4)
- Satin Chrome (6)
- Satin Nickel (31)
- Oil Rubbed Bronze (34)
- Stainless/Brushed Nickel (50)

4T-3820 & 4T-3820X FINISHES & PRICE GROUPS:

PRICE GROUP A

- Polished Chrome (1)

PRICE GROUP B

- Flat Black (20)

PRICE GROUP C

- Polished Brass & PVD (2)
- Antique Nickel (Pewter) (4)
- Satin Nickel (31)
- Oil Rubbed Bronze (34)
- Stainless/Brushed Nickel (50)

PRICE GROUP D

- Polished Gold (8)
- Satin Gold (35)
- Venetian Bronze (47)

BRAIDED RISERS

4T-295, 4T-296, 4T-297 & 4T-298

ALL BRAIDED RISERS ARE SOLD SEPARATELY

4T-295

FINISHES & PRICE GROUPS:

PRICE GROUP A

- Polished Chrome (1)

PRICE GROUP B

- Satin Nickel (31)

3/8" COMPRESSION X 1/2" IPS X 12" BRAIDED RISER | 4T-295

SINK AND LAVATORY APPLICATIONS

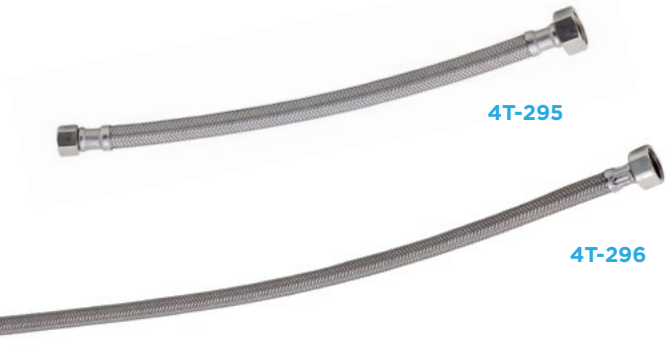

4T-296

FINISHES & PRICE GROUPS:

PRICE GROUP A

- Polished Chrome (1)

PRICE GROUP C

- Polished Nickel (30)
- Satin Nickel (31)
- Stainless/Brushed Nickel (50)

3/8" COMPRESSION X 1/2" IPS X 20" BRAIDED RISER | 4T-296

SINK AND LAVATORY APPLICATIONS



SOLD EACH

4T-297

FINISHES & PRICE GROUPS:

PRICE GROUP A

- Polished Chrome (1)

PRICE GROUP C

- Polished Nickel (30)
- Satin Nickel (31)
- Stainless/Brushed Nickel (50)

3/8" COMPRESSION X 7/8" PLASTIC BALLCOCK CONNECTOR X 12" BRAIDED RISER | 4T-297

4T-298

FINISHES & PRICE GROUPS:

PRICE GROUP A

- Polished Chrome (1)

PRICE GROUP B

- Satin Nickel (31)
- Stainless/Brushed Nickel (50)



SOLD EACH

3/8" COMPRESSION X 7/8" PLASTIC BALLCOCK CONNECTOR X 16" BRAIDED RISER | 4T-298

1/2" THREADED BRASS FITTINGS

4T-309, 4T-311, 4T-313, 4T-315, 4T-317, 4T-319, & 4T-323



1/2" IPS 90° ELBOW | 4T-309

4T-309



1/2" IPS COUPLING | 4T-311

4T-311



1/2" IPS 45° ELBOW | 4T-313

4T-313



1/2" IPS TEE | 4T-315

4T-315



1/2" IPS ELBOW 90° STREET | 4T-317

4T-317



1/2" IPS CAP | 4T-319

4T-319



4T-323

1/2" IPS UNION | 4T-323

4T-309, 4T-311, 4T-313, 4T-315,
4T-317, 4T-319, & 4T-323
FINISHES & PRICE GROUPS:

PRICE GROUP A

- Polished Chrome (1)

PRICE GROUP C

- Polished Brass & PVD (2)
- Antique Brass (3)
- Polished Nickel (30)
- Satin Nickel (31)
- Oil Rubbed Bronze (34)
- Stainless/Brushed Nickel (50)

PRICE GROUP D

- Uncoated Polished Brass (11)

3/8" THREADED BRASS FITTINGS

4T-310, 4T-312, 4T-314, 4T-316, 4T-318, 4T-320 & 4T-3223

3/8" IPS 90° ELBOW | 4T-310



4T-310

3/8" IPS COUPLING | 4T-312



4T-312

3/8" IPS 45° ELBOW | 4T-314



4T-314

3/8" IPS TEE | 4T-316



4T-316

3/8" IPS ELBOW 90° STREET | 4T-318



4T-318

3/8" IPS CAP | 4T-320



4T-320

3/8" IPS UNION | 4T-3223



4T-3223

4T-310, 4T-312, 4T-314, 4T-316,
4T-318, 4T-320, & 4T-3223
FINISHES & PRICE GROUPS:

PRICE GROUP A

- Polished Chrome (1)

PRICE GROUP C

- Polished Brass & PVD (2)
- Satin Nickel (31)

PRICE GROUP D

- Uncoated Polished Brass (11)

1/2" IPS NIPPLES

1-1/2" TO 11" IN LENGTH

4T-400N TO 4T-414N

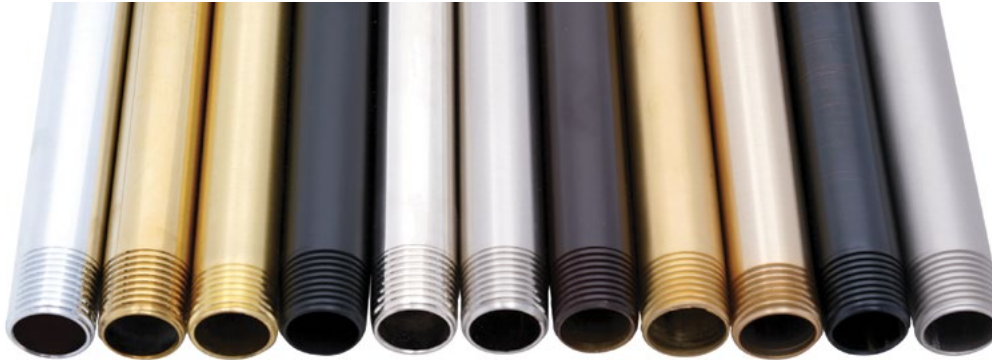

1 2 5 20 30 31 34 35 38 47 50

1/2" IPS X 1-1/2" NIPPLE | [4T-400N](#)

1/2" IPS X 2" NIPPLE | [4T-401N](#)

1/2" IPS X 2-1/2" NIPPLE | [4T-402N](#)

1/2" IPS X 3" NIPPLE | [4T-403N](#)

1/2" IPS X 3-1/2" NIPPLE | [4T-404N](#)

1/2" IPS X 4" NIPPLE | [4T-405N](#)

1/2" IPS X 4-1/2" NIPPLE | [4T-406N](#)

1/2" IPS X 5" NIPPLE | [4T-407N](#)

1/2" IPS X 5-1/2" NIPPLE | [4T-408N](#)

1/2" IPS X 6" NIPPLE | [4T-409N](#)

1/2" IPS X 7" NIPPLE | [4T-410N](#)

1/2" IPS X 8" NIPPLE | [4T-411N](#)

1/2" IPS X 9" NIPPLE | [4T-412N](#)

1/2" IPS X 10" NIPPLE | [4T-413N](#)

1/2" IPS X 11" NIPPLE | [4T-414N](#)

4T-400N TO 4T-414N FINISHES & PRICE GROUPS:

PRICE GROUP A

- Polished Chrome (1)

PRICE GROUP B

- Flat Black (20)

PRICE GROUP C

- Polished Brass & PVD (2)
- Satin Brass (5)
- Polished Nickel (30)
- Satin Nickel (31)
- Oil Rubbed Bronze (34)
- Stainless/Brushed Nickel (50)

PRICE GROUP D

- Uncoated Polished Brass (11)
- Satin Gold (35)
4T-403N, 4T-405N, 4T-409N,
4T-411N, 4T-413N only
- Light Brushed Bronze (38)
- Venezian Bronze (47)

1/2" IPS NIPPLES

12", 18" & 24" IN LENGTH

4T-415N, 4T-416N, 4T-417N

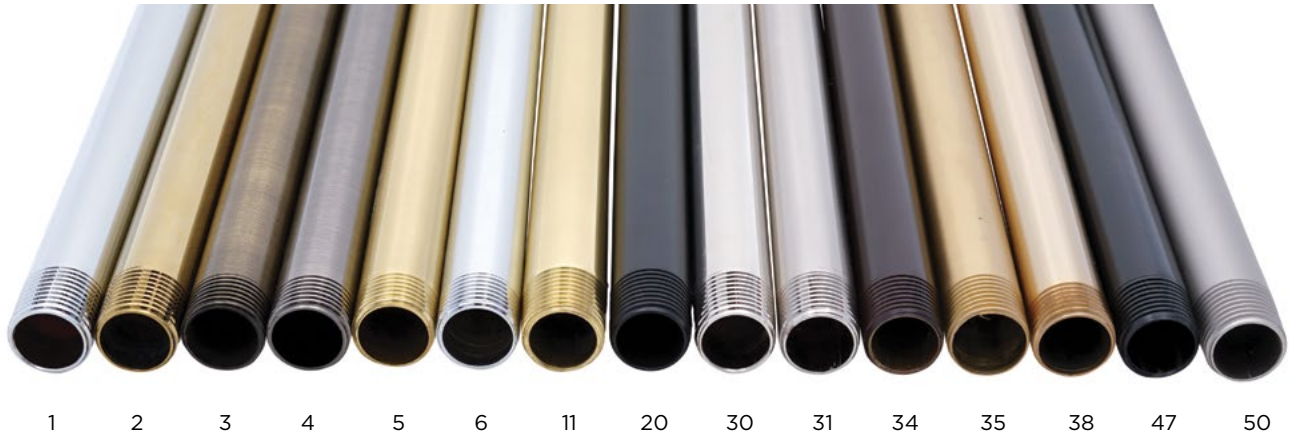

1/2" IPS X 12" NIPPLE | 4T-415N

1/2" IPS X 18" NIPPLE | 4T-416N

1/2" IPS X 24" NIPPLE | 4T-417N

4T-415N, 4T-416N, 4T-417N FINISHES & PRICE GROUPS:

PRICE GROUP A

- Polished Chrome (1)

PRICE GROUP B

- Flat Black (20)

PRICE GROUP C

- Polished Brass & PVD (2)
- Antique Brass (3)
- Antique Nickel (Pewter) (4)
- Satin Brass (5)
- Satin Chrome (6)
- Polished Nickel (30)
- Satin Nickel (31)
- Oil Rubbed Bronze (34)
- Stainless/Brushed Nickel (50)

PRICE GROUP D

- Uncoated Polished Brass (11)
- Satin Gold (35)
- Light Brushed Bronze (38)
- Venezian Bronze (47)

1/2" IPS NIPPLES

30", 36", 42", 48", 54" & 60" IN LENGTH

4T-418N, 4T- 419N, 4T- 421N, 4T-420N, 4T-422N, 4T-423N

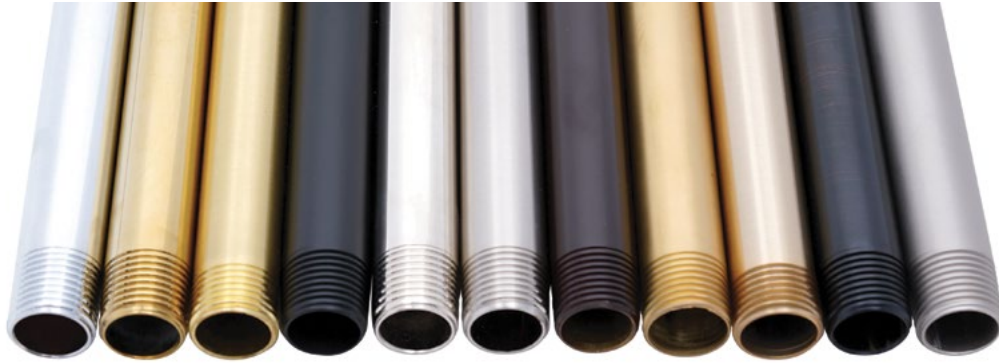

1 2 11 20 30 31 34 35 38 47 50

1/2" IPS X 30" NIPPLE | [4T-418N](#)

1/2" IPS X 36" NIPPLE | [4T-419N](#)

1/2" IPS X 42" NIPPLE | [4T-421N](#)

1/2" IPS X 48" NIPPLE | [4T-420N](#)

1/2" IPS X 54" NIPPLE | [4T-422N](#)

1/2" IPS X 60" NIPPLE | [4T-423N](#)

4T-418N, 4T- 419N, 4T- 421N, 4T-420N, 4T-422N, 4T-423N FINISHES & PRICE GROUPS:

PRICE GROUP A

- Polished Chrome (1)

PRICE GROUP B

- Flat Black (20)

PRICE GROUP C

- Polished Brass & PVD (2)
- Polished Nickel (30)
- Satin Nickel (31)
- Oil Rubbed Bronze (34)
- Stainless/Brushed Nickel (50)

PRICE GROUP D

- Uncoated Polished Brass (11)
- Satin Gold (35)
- Light Brushed Bronze (38)
- Venetian Bronze (47)

3/8" IPS NIPPLES

4T-425N, 4T-426N, 4T-428N, 4T-429N, 4T-430N, 4T-431N,
4T-432N, 4T-434N, 4T-435N, 4T-436N, 4T-438N, & 4T-440N

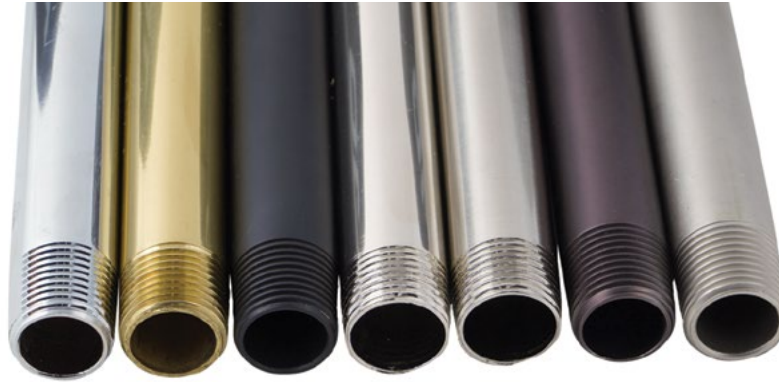

1 2 20 30 31 34 50

4T-425N, 4T-426N, 4T-428N,
4T-429N, 4T-430N, 4T-432N,
4T-434N, 4T-435N, 4T-436N,
4T-438N, & 4T-440N

FINISHES & PRICE GROUPS:

PRICE GROUP A

- Polished Chrome (1)

PRICE GROUP B

- Flat Black (20)

PRICE GROUP C

- Polished Brass & PVD (2)
- Antique Brass (3)
4T-430N only
- Antique Nickel (Pewter) (4)
4T-430N only
- Satin Brass (5)
4T-430N only
- Polished Nickel (30)
- Satin Nickel (31)
- Oil Rubbed Bronze (34)
- Stainless/Brushed Nickel (50)

PRICE GROUP D

- Uncoated Polished Brass (11)
- Satin Gold (35)
4T-430N only
- Light Brushed Bronze (38)
4T-430N only
- Venezian Bronze (47)
4T-430N only

3/8" IPS X 1-1/2" NIPPLE | [4T-425N](#)

3/8" IPS X 2" NIPPLE | [4T-426N](#)

3/8" IPS X 3" NIPPLE | [4T-428N](#)

3/8" IPS X 3-1/2" NIPPLE | [4T-429N](#)

3/8" IPS X 4" NIPPLE | [4T-430N](#)

3/8" IPS X 5" NIPPLE | [4T-432N](#)

3/8" IPS X 6" NIPPLE | [4T-434N](#)

3/8" IPS X 7" NIPPLE | [4T-435N](#)

3/8" IPS X 8" NIPPLE | [4T-436N](#)

3/8" IPS X 10" NIPPLE | [4T-438N](#)

3/8" IPS X 12" NIPPLE | [4T-440N](#)

SURE GRIP FLANGES

4T-261, 4T- 262, 4T- 263, & 4T-266



4T-261

1-1/2" OD SHALLOW PATTERN SURE GRIP FLANGE | 4T-261



4T-262

1-1/2" IPS SHALLOW PATTERN SURE GRIP FLANGE | 4T-262



4T-263

2" OD SHALLOW PATTERN SURE GRIP FLANGE | 4T-263



4T-266

1-1/4" OD SHALLOW PATTERN SURE GRIP FLANGE | 4T-266

**4T-261, 4T- 262,
4T- 263 & 4T-266
FINISHES & PRICE GROUPS:**

PRICE GROUP A

- Polished Chrome (1)

PRICE GROUP B

- White (13)
- Gloss Black (15)
- Almond (19)
- Flat Black (20)

PRICE GROUP C

- Polished Brass & PVD (2)
- Antique Brass (3)
- Satin Brass (5)
- Polished Nickel (30)
- Satin Nickel (31)
- Oil Rubbed Bronze (34)
- Stainless/Brushed Nickel (50)

PRICE GROUP D

- Satin Gold (35)
- Light Brushed Bronze (38)

SURE GRIP FLANGES

4T-284, 4T-28438 & 4T-285

1/2" IPS LOW PATTERN SURE GRIP FLANGE | 4T-284



4T-284

3/8" IPS LOW PATTERN SURE GRIP FLANGE | 4T-28438



4T-28438

5/8" OD LOW PATTERN SURE GRIP FLANGE | 4T-285



4T-285

4T-284, 4T-28438 & 4T-285 FINISHES & PRICE GROUPS:

PRICE GROUP A

- Polished Chrome (1)

PRICE GROUP B

- White (13)
- Gloss Black (15)
- Biscuit (16)
- Almond (19)
- Flat Black (20)

PRICE GROUP C

- Polished Brass & PVD (2)
- Antique Brass (3)
- Antique Nickel (Pewter) (4)
- Satin Brass (5)
- Satin Chrome (6)
- Polished Nickel (30)

- Satin Nickel (31)
- Oil Rubbed Bronze (34)
- Stainless/Brushed Nickel (50)

PRICE GROUP D

- Polished Gold (8)
- Uncoated Polished Brass (11)
- Black Nickel (12)
- Light Gold (32)
- Antique Bronze (33)
- Satin Gold (35)
- Antique Copper (36)
- Light Brushed Bronze (38)
- Aged Pewter (40)
- Venezian Bronze (47)

BELL FLANGES

4T-2588, 4T-303 & 4T-306



4T-2588

1-1/2" OD DEEP PATTERN BELL FLANGE | 4T-2588



4T-303

1/2" OD BELL FLANGE | 4T-303



4T-306

5/8" OD BELL FLANGE | 4T-306

4T-2588, 4T-303 & 4T-306 FINISHES & PRICE GROUPS:

PRICE GROUP A

- Polished Chrome (1)

PRICE GROUP B

- White (13)
- Almond (19)
- Flat Black (20)

PRICE GROUP C

- Polished Brass & PVD (2)
- Antique Brass (3)
- Antique Nickel (Pewter) (4)
- Satin Brass (5)

- Satin Chrome (6)
- Polished Nickel (30)
- Satin Nickel (31)
- Oil Rubbed Bronze (34)
- Stainless/Brushed Nickel (50)

PRICE GROUP D

- Antique Bronze (33)
- Satin Gold (35)
- Light Brushed Bronze (38)
- Aged Pewter (40)
- Venezian Bronze (47)

BELL FLANGES

4T-307, 4T-308 & 4T-30838

11/16" OD BELL FLANGE | 4T-307



4T-307

1/2" IPS BELL FLANGE | 4T-308



4T-308

3/8" IPS BELL FLANGE | 4T-30838



4T-30838

4T-307, 4T-308 & 4T-30838

FINISHES & PRICE GROUPS:

PRICE GROUP A

- Polished Chrome (1)

PRICE GROUP B

- White (13)
- Almond (19)
- Flat Black (20)

PRICE GROUP C

- Polished Brass & PVD (2)
- Antique Brass (3)
- Antique Nickel (Pewter) (4)
- Satin Brass (5)

- Satin Chrome (6)
- Polished Nickel (30)
- Satin Nickel (31)
- Oil Rubbed Bronze (34)
- Stainless/Brushed Nickel (50)

PRICE GROUP D

- Antique Bronze (33)
- Satin Gold (35)
- Light Brushed Bronze (38)
- Aged Pewter (40)
- Venezian Bronze (47)

HIGH BOX FLANGES

4T-258, 4T-259, 4T-260 & 4T-264



4T-258

1-1/2" OD DEEP PATTERN HIGH BOX FLANGE | 4T-258



4T-259

1-1/4" OD DEEP PATTERN HIGH BOX FLANGE | 4T-259



4T-260

1-1/2" IPS DEEP PATTERN HIGH BOX FLANGE | 4T-260



4T-264

2" OD DEEP PATTERN HIGH BOX FLANGE | 4T-264

4T-258, 4T-259, 4T-260 & 4T-264 FINISHES & PRICE GROUPS:

PRICE GROUP A

- Polished Chrome (1)

PRICE GROUP B

- White (13)
- Gloss Black (15)
- Almond (19)
- Flat Black (20)

PRICE GROUP C

- Polished Brass & PVD (2)
- Antique Brass (3)
- Antique Nickel (Pewter) (4)
- Satin Brass (5)

- Satin Chrome (6)

- Polished Nickel (30)

- Satin Nickel (31)

- Oil Rubbed Bronze (34)

- Stainless/Brushed Nickel (50)

PRICE GROUP D

- Uncoated Polished Brass (11)

- Satin Gold (35)

- Antique Copper (36)

- Light Brushed Bronze (38)

- Aged Pewter (40)

- Venezian Bronze (47)

LOG LIGHTER TRIM

4T-1916 & 4T-1917

LOG LIGHTER KIT | 4T-1916

EXPOSED FLANGE AND KEY

FOR PRICE PFISTER, ARROWHEAD BRASS AND SIOUX CHIEF

2" DIAMETER

1-3/4" DEEP



LOG LIGHTER KEY ONLY | 4T-1917

5/16" X 3"

4T-1916 & 4T-1917 FINISHES & PRICE GROUPS:

PRICE GROUP A

- Polished Chrome (1)

PRICE GROUP B

- White (13)
- Gloss Black (15)
- Flat Black (20)

PRICE GROUP C

- Polished Brass & PVD (2)
- Antique Brass (3)
- Satin Brass (5)

- Satin Chrome (6)

- Polished Nickel (30)

- Satin Nickel (31)

- Oil Rubbed Bronze (34)

- Stainless/Brushed Nickel (50)

PRICE GROUP D

- Satin Gold (35)

- Antique Copper (36)

- Light Brushed Bronze (38)

- Venezian Bronze (47)

INDEX OF PRODUCTS

4T-002 30	4T-066A 33	4T-171-KIT 63	4T-209 6
4T-004 30	4T-067 33	4T-172 63	4T-209K 6
4T-005 30	4T-068 32	4T-173X 63	4T-210 6
4T-5NC 30	4T-077G 26	4T-174X 63	4T-211 10
4T-5NCTD 33	4T-090 18	4T-176X 66	4T-212 10
4T-006 30	4T-091 18	4T-177X 66	4T-213A 9
4T-007 30	4T-094 29	4T-178X 68	4T-213K 9
4T-020 31	4T-095 29	4T-179X 68	4T-213S 9
4T-021 31	4T-119 81	4T-183A 56	4T-214 10
4T-029 17	4T-121 80, 81	4T-185 54	4T-215 14
4T-030 16	4T-122 82	4T-186 58, 59, 60, 61, 62, 64	4T-215B 14
4T-031 19	4T-128 85	4T-186K 58, 64	4T-215BC-KIT 14
4T-032 28	4T-132 90, 91	4T-186KP 64	4T-215C 14
4T-033 29	4T-141 82	4T-186P 54, 55, 56, 58, 64	4T-215-KIT 14
4T-034 19	4T-145 84	4T-187 55	4T-216 15
4T-039 20	4T-146 86	4T-188 65	4T-216-KIT 15
4T-040 16, 20	4T-147 87	4T-188K 65	4T-217 15
4T-041 22	4T-148 86	4T-189 65	4T-218 15
4T-042 17	4T-149 87	4T-190 34	4T-224 35
4T-042GC 28	4T-150 86	4T-193 34	4T-225 35
4T-043 21	4T-151D 87	4T-194 36	4T-231 11
4T-044 22	4T-152 90	4T-195 36	4T-233 12
4T-045 23	4T-153 91	4T-196 37	4T-234 12
4T-046 28	4T-156 91	4T-197 37	4T-235 12
4T-047 23	4T-160 92	4T-198 37	4T-236 8
4T-048 27	4T-162 94	4T-199X 54	4T-237 8
4T-049 24	4T-163 94	4T-200 5	4T-238 13
4T-049J 24	4T-164 92	4T-202 4	4T-240 13
4T-055 32	4T-165 92	4T-203 4	4T-242 11
4T-056 33	4T-166 93	4T-204 5	4T-245 38
4T-062 32	4T-167 94	4T-205 5	4T-245L 38
4T-063 25	4T-168 93	4T-206 8	4T-246 39
4T-064 32	4T-169 57	4T-207 7	4T-246L 39
4T-065 32	4T-170X 63	4T-208 7	4T-247 42

INDEX OF PRODUCTS

4T-249 42	4T-289 112	4T-400N 122	4T-435N 125
4T-250 43	4T-289X 112	4T-401N 122	4T-436N 125
4T-251 40	4T-295 119	4T-402N 122	4T-438N 125
4T-251N 40	4T-296 119	4T-403N 122	4T-440N 125
4T-253 41	4T-297 119	4T-404N 122	4T-480 27
4T-253N 41	4T-298 119	4T-405N 122	4T-483 26
4T-254 44	4T-300 52	4T-406N 122	4T-502A 31
4T-254K 44	4T-301 52	4T-407N 122	4T-503P 31
4T-255D 46	4T-302 52	4T-408N 122	4T-541 93
4T-258 130	4T-303 128	4T-409N 122	4T-628 51
4T-259 130	4T-304 56	4T-410N 122	4T-629 51
4T-260 130	4T-306 128	4T-411N 122	4T-630 52
4T-261 126	4T-307 129	4T-412N 122	4T-631 52
4T- 262 126	4T-308 129	4T-413N 122	4T-0663J 25
4T- 263 126	4T-309 120	4T-414N 122	4T-682 51
4T-264 130	4T-310 121	4T-415N 88, 123	4T-701 43
4T-265 53	4T-311 120	4T-416N 88, 123	4T-715 95
4T-265A 53	4T-312 121	4T-417N 88, 123	4T-715X 95
4T-265G 53	4T-313 120	4T-418N 89, 124	4T-716 96
4T-266 126	4T-314 121	4T- 419N 124	4T-716X 96
4T-267 49	4T-315 120	4T-419N 89	4T-717 97
4T-267A 49	4T-316 121	4T-420N 89, 124	4T-717X 97
4T-268 49	4T-317 120	4T- 421N 124	4T-718 98
4T-268A 49	4T-318 121	4T-421N 89	4T-718X 98
4T-283 53	4T-319 120	4T-422N 89, 124	4T-725 99
4T-283C 53	4T-320 121	4T-423N 89, 124	4T-725X 99
4T-284 127	4T-323 120	4T-425N 125	4T-726 99
4T-285 127	4T-335 54	4T-426N 125	4T-726X 99
4T-286 105	4T-336 54	4T-428N 125	4T-727 100
4T-286X 105	4T-367 50	4T-429N 125	4T-727X 100
4T-287 107	4T-368 50	4T-430N 125	4T-728 101
4T-287X 107	4T-369 50	4T-431N 125	4T-728X 101
4T-288 110	4T-370 50	4T-432N 125	4T-1060 79
4T-288X 110	4T-371 50	4T-434N 125	4T-1072 79

INDEX OF PRODUCTS

4T-1090 78	4T-1905CB 61	4T-4240 17	4T-39412X 112
4T-1170 81	4T-1906C 62	4T-5599 74	4T-39612 106
4T-1760X 67	4T-1906CB 62	4T-5599E 75	4T-39612X 106
4T-1773A 76	4T-1907C 62	4T-6420 33	4T-39812 111
4T-1774A 76	4T-1907CB 62	4T-7711D 69, 73	4T-39812X 111
4T-1775A 76	4T-1916 131	4T-7722D 69	4T-55138 109
4T-1776A 76	4T-1917 131	4T-9855D 70	
4T-1777A 76	4T-2551D 45	4T-9922D 67	
4T-1779A 77	4T-2565 46	4T-28328 104	
4T-1780A 77	4T-2566 45	4T-28438 127	
4T-1781A 77	4T-2566K 45	4T-28638 105	
4T-1782A 77	4T-2577 47	4T-28638X 99, 105	
4T-1783A 77	4T-2588 128	4T-28738 108	
4T-1800A 70	4T-2738 102	4T-28738X 108	
4T-1802A 71	4T-2739 102	4T-28838 110	
4T-1803A 71	4T-2780 102	4T-28838X 110	
4T-1804A 72	4T-2781D 102	4T-28938 113	
4T-1805A 72	4T-2799 103	4T-28938X 113	
4T-1833 56	4T-2800 103	4T-29212 116	
4T-1850A 55	4T-2838 104	4T-29212X 116	
4T-1850B 55	4T-2839 103	4T-29238 117	
4T-1869 55	4T-2840 104	4T-29238X 117	
4T-1870 55	4T-2940 17	4T-29412 116	
4T-1900C 58	4T-3040 16	4T-29412X 116	
4T-1900CB 58	4T-3223 121	4T-29438 117	
4T-1901C 58	4T-3648 48	4T-29438X 117	
4T-1901CB 58	4T-3649 48	4T-30838 129	
4T-1902C 59	4T-3650 48	4T-38638 114	
4T-1902CB 59	4T-3812 118	4T-38638X 114	
4T-1903C 60	4T-3812X 118	4T-38838 115	
4T-1903CB 60	4T-3815 118	4T-38838X 115	
4T-1904C 60	4T-3815X 118	4T-39312 107	
4T-1904CB 60	4T-3820 118	4T-39312X 107	
4T-1905C 61	4T-3820X 118	4T-39412 112	

TERMS AND CONDITIONS OF SALE

LIMITED WARRANTY: Trim To The Trade warrants that its products are free from defects in materials and workmanship for a period of 90 days to the user thereof. Warranty (1) does not include, and Trim To The Trade does not assume any liability for, (a) the finish or wearing quality thereof on any of its products, (b) any obligation other than replacement of the defective product upon presentation thereof to Trim to The Trade during the warranty period, (c) any labor charges, removal and installation expenses, freight or postage to or from Trim To The Trade or any incidental or consequential damages resulting from any defective product and (2) is in lieu of all other warranties, expressed or implied.

Some states do not allow limitations on how long an implied warranty lasts, so the above limitation may not apply. Some states do not allow the exclusion or limitation of incidental or consequential damages, so the above limitation or exclusion may not apply.

This warranty gives you specific legal rights, and you may have other rights which vary from state to state.

PRODUCT LIABILITY: Insurance statements are available upon request.

PRICES: Prices are listed in our separate "Price List". If you are missing a price list, please visit our website trimtothetrade.com to download the most current price list or contact Customer Service.

Prices listed are Suggested Retail Prices. Prices are subject to change without notice. Prices are listed in US Currency.

MINIMUM INVOICE CHARGE: There is no minimum billing to ship to you our customer. However, there is a \$30.00 net minimum to ship directly to your customer. Air orders exempt.

FREIGHT: Shipper reserves the right to ship merchandise by method of our choosing. Shipments are F.O.B. Palm Desert, California. Full Freight Allowed on shipments of \$600.00 NET invoice value within the continental United States. Full Freight allowed on shipments of \$1700.00 NET invoice value to Hawaii, Alaska, and Canada. Freight allowance will not apply to customers outside the United States and Canada boundaries. We will not ship merchandise collect to your customer. Trim To The Trade places insurance on all shipments leaving our warehouse, covering damage or loss, for full value of shipment. Insurance charges are automatically added to freight charges on invoices to you.

Freight Collect shipments require your UPS/FED EX account number.

When customer requests special handling, any next day, second day, third day, etc., it is the customer's responsibility to notify Trim to the Trade of any handling discrepancies within one week, as the carriers have a time limit for this type of dispute.

We are only responsible for the number of cartons the customer signs for.

RETURNS: Merchandise cannot be returned without prior authorization from our returns department. All returns are subject to a minimum of 30% restocking charge. All returns must be properly packaged and accompanied by either a copy of the original invoice or packing slip. Shipping charges for returned merchandise must be prepaid. No C.O.D.'s will be accepted. Credits are issued upon inspection. We do not even-exchange, or swap merchandise. We will re-invoice replacement merchandise and credit the returned merchandise. If we receive merchandise that is not from Trim to the Trade you will be notified immediately and will have 30 days to respond. After 30 days the merchandise will be scrapped.

RETURN AUTHORIZATIONS: Any materials returned, other than defective items, will carry the following re-stock charges:

30% - Items returned within 30 days from Invoice date

30% - Items returned between 1-3 months

40% - Items returned between 4-6 months

50% - Items returned between 6-12 months

NO RETURNS on items over one year old, regardless if defective or not.

CLAIMS: All claims for defective merchandise, shipment shortages, and billing errors, must be made within one week after receipt of goods.

PRODUCT MODIFICATION: We reserve the right to modify any product contained herein without any prior notice.

TRIM TO THE TRADE: Shall not be responsible for typographical errors and will not be held responsible for any liability associated with misprints, errors and/or pricing discrepancies in this publication.

POSSESSION OF THIS CATALOG DOES NOT CONSTITUTE ANY OFFER TO SELL.



Trim to the Trade

**Orders and Inquiries:
customerservice@trimtothetrade.com**

trimtothetrade.com

**Office 760-343-3306
Fax 800-562-9998**

**77551 El Duna Court, Suite J
Palm Desert, CA 92211**