

murdock

INDOOR BOTTLE FILLERS AND DRINKING FOUNTAINS



BF168S-BCD



A171408S-UG-VR-BF12S



BFEZS168-BCD

Scan to see
Easy Maintenance
More Savings!



 MORRIS GROUP INTERNATIONAL

WWW.MORRISGROUPINT.COM

murdock

A172408S-UG-VR-BF12S-BCD



BF168S-BCD

springH2O[®]
BOTTLE FILLERS BY MURDOCK[®]

BOOK

Stainless Steel Bottle Fillers

FEATURES AND BENEFITS

- Aesthetically pleasing
- All stainless steel
- Eco-friendly bottle counter display
- Industry leading 1.2 GPM laminar water flow
- Indoor/outdoor use
- Vandal-resistant
- Available in custom colors



SpringH2O® Standalone Curved Sensor Operated Bottle Filler
BF16S



SpringH2O® Curved Push Button
Bottle Filler in Enviro-glaze®
BF11S



SpringH2O® Curved Sensor
Operated Bottle Filler
BF12S-BCD

OPTION -AP

Auto-Purge
Function Controller



Murdock Manufacturing offers option -AP, the Auto-Purge Function Controller, as an add-on to BF12S and BF16S plug-in bottle fillers. These products feature an Auto-Purge Sensor which allows adjustment of Purge Cycle, Sensor Range and Lock-out functions. The -AP Sensor Function Remote Controller provides for adjustment of the Auto-Purge Timing Cycle, Infrared Sensor Detection Range and Activation Lock-out settings.

Custom Colors & Logos

Whether you want to
blend in or stand out,
Murdock's Custom Colors
is the solution for you!



A171408S-UG-BF12S-BCD-EG22

POWDERCOATED LOGOS

For a look that's more personal, we can integrate powder coated logos, colors and decals on most any Murdock® unit. Simply provide us with your team, company or personal logo for a truly unique drinking fountain.

STANDARD FINISHES

Visit www.murdockmfg.com to see all available color and finish options for our products. Finishes not available on every product.

CUSTOM/MATCH FINISHES

Looking for a specific color to match an existing wall or color pattern? No problem. Murdock has the unique ability to match all Drinking Fountains, Water Coolers and Bottle Fillers to any Pantone® color swatch. Color match your unit so that you don't have to design your space around it... make it a part of the room!



Thirsty for some color?

Custom color powder coats bond with Murdock's seamless drinking fountains and bottle fillers for an eye-catching alternative that is built to last.

Add your custom logos!



Solar Flame (yellow)
EG-12



Pearl White
EG-11 *



Diamond White
EG-09



Yukon Brass
EG-04



Custom Color



Alpine Lake (blue)
EG-13



Firehouse Red
EG-15 *



Matte White
EG-26



Textured Fairway
Green EG-27



Textured Firehouse
Red EG-28

All models shown:
A171408S-UG-VR-BF12S-BCD

*We have the ability
to color match!*

Enviro-Glaze®

Murdock Manufacturing has developed a color coating system which will allow you to purchase durable stainless steel fixtures in designer colors. The Enviro-Glaze® finish is a superior finish which gives you a colorful and functional alternative to a stainless steel finish.

Color Selection



Silver Sage Patina
EG-01 *



Quicksilver
EG-02



Autumn Bronze
EG-03



Yukon Brass
EG-04

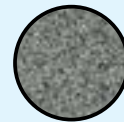

River-Rock Granite
EG-05

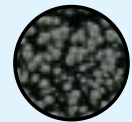

Raindrop
EG-06



Onyx (black)
EG-07



Textured Onyx
(black) EG-08



Diamond White
EG-09

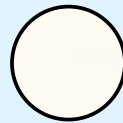

Snow White
EG-10 *

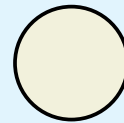

Pearl White
EG-11 *

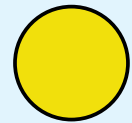

Solar Flame (yellow)
EG-12

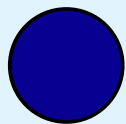

Alpine Lake (blue)
EG-13

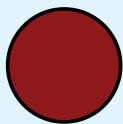

Firehouse Red
EG-15 *

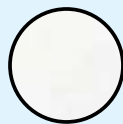

Matte White
EG-26

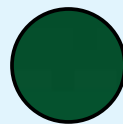

Textured Fairway
Green EG-27

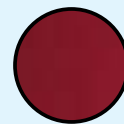

Textured Firehouse
Red EG-28

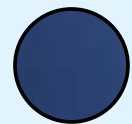

Textured Alpine
Lake EG-29

**For Indoor Use Only*

Note: Printed color swatches may differ slightly from actual Enviro-Glaze® coating. Contact your local representative for samples.



*SpringH2O® Standalone Curved
Sensor Operated Bottle Filler
in Solar Flame (yellow)
BF16S-BCD-EG12*

*SpringH2O® Standalone Curved
Sensor Operated Bottle Filler
in Alpine Lake EG-13
BF16-BCD-EG13*



*SpringH2O® Standalone Curved
Sensor Operated Bottle Filler
in Texture Fairway Green EG-27
BF16S-BCD-EG27*



murdock

Water Filtration

WF3EZ

3,000 Gallon Capacity
Filters Microplastics

**Reduces PFAS,
Lead, Bacteria,
Chlorine, and
Microplastics
in Water**



murdock
Filter Cartridge
7012-347-000

Maximum Flow	1.5 GPM
Maximum Pressure	125 PSI
Maximum Temperature	120°F
Service Life	3000 Gallons

NOTE: DO NOT USE WHERE THE WATER IS MICROBIOLOGICALLY UNSAFE OR OF UNKNOWN QUALITY WITHOUT ADEQUATE DISINFECTION BEFORE OR AFTER THE UNIT

NOTE: INSTALL IN COLD-WATER APPLICATIONS ONLY

NOTE: ITEMS 1 THROUGH 3 ARE NOT REQUIRED WHEN REPLACING THE CARTRIDGE HOUSING

- 1. Shut off water supply.
 - 2. Turn the flow direction of the filter.
 - 3. For quick connection: Rotate push screw to the left and pull the filter out of the housing.
 - 4. After replacing the cartridge, simply attach the push screw to the right and check for leaks. If leaks occur, stop step 3. If leaks persist, discontinue use and call your servicing dealer.
 - 5. Run 2 gallons of water through the filter before use.
- OR REPLACEMENT UNIT**
Call 1-800-453-7465
www.murdockmfg.com

NOTE: INSTALL IN COMPLIANCE WITH LOCAL AND STATE REGULATIONS

Rated by NSF to NSF42 for lead reduction and NSF401 for microplastic reduction.

Model No. BF12



Model No. BF12S-BCD



Replace your Bottle Filler!

- No need to drill new holes! SpringH2O® and H2O-To-Go® bottle fillers match the hole configuration of many existing bottle fillers—including select competitor models.
- Compatible with many existing water cooler models
- Rough-ins match existing models for easy installation
- Bottle Counter Display (optional) shows how many 16-oz water bottles were saved

Number of Parts

OURS: Only 27 parts

THEIRS: 60+ parts



Replace your Water Cooler with an A17 Series!

- Universal Bracket is compatible with several popular water cooler brands
- Reuse the existing mounting bracket and screw patterns

Single Mechanical Button

OURS: Single mechanical button with no complicated maintenance.

THEIRS: Three electronic buttons that can complicate maintenance.

Replace the Filter with Ease

- EZ Door™ filter allows replacement in four quick steps - unlatch door, remove filter, insert new filter, latch door
- No removing the shroud
- Auto shut-off simplifies filter changes

Refrigeration via Tube Evaporator

- Wraps around the water tube
- Eliminates tank of stored water that could potentially harbor bacteria

OURS: Refrigeration tube to chill water is wrapped around the water tube. Coil keeps sediment moving through to the strainer.

THEIRS: Chilling tank has standing water that can allow sediment to collect in the bottom and possibly become contaminated.

MURDOCK

OURS VS THEIRS

Easy Maintenance + Fewer Parts =
More Savings!

Easy access with only two top screws to loosen Self-holding, lightweight face tilts forward for easy maintenance



BF12-BCD

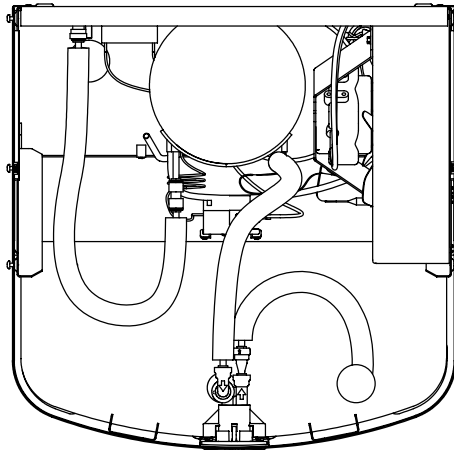

Murdock Water Cooler
27 Parts

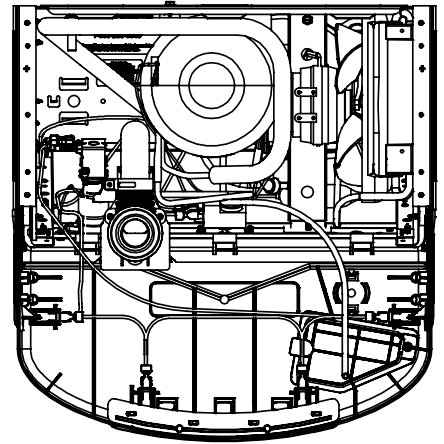

Competitor's Water Cooler
60+ Parts



AUTO-STOP

AUTO-STOP allows cartridge and strainer service without removing cooler deck to access water supply stop

PATENT No. 10,100,933

LESS TIME: Routine maintenance takes 2 minutes

LESS MAINTENANCE: Access water shut off, cartridge, and filter from the front without removing the shroud!

LESS EXPENSE: Fewer parts to repair and less expensive parts

LESS WORK: Universal rough-in will match existing footprints for easy retrofit

WATER SHUT OFF: Exclusive, patented Auto-Stop feature

*Premium Features
at a Value Price*

Water Filtration



Filter Comparison

Model No.	WF3 (OLD)	WF3000 (NEW)
Capacity (gallons)	3,000	3,000
Replacement Filter	RWF3	RWF3000
Filters PFAS/PFOS	No	Yes
NSF/ANSI Standard 42 Chlorine Reduction	Yes	Yes
NSF/ANSI Standard 53 Lead Reduction to 1 Micron	Yes	Yes
NSF/ANSI Standard 372 Lead in Water	Yes	Yes
NSF/ANSI Standard 401 Removal of Microplastics	No	Yes

Filter Accessory Comparison

WF3EZ	WFS
Quick drop-down door assembly offers easy access to change the filter	Stainless steel wall mount cabinet with hinged, fold-down cover
Designed for A17 water coolers	Allows filtration on units without built-in filter capacity
Compatible with all Murdock® filters	Compatible with all Murdock® filters

**Learn More
about our Filters**



murdock

Indoor Drinking Fountains



*Stainless Steel ADA Wall Mount
Water Cooler with matching
Sensor Operated Bottle Filler
A171408S-UG-BF12S-EG22*



A171408S-UG-VR-BF12S-BCD

A17 Series



A171408S-UG-VR

Durable, reliable drinking fountains suitable for use alone or combined with bottle fillers. The A17 series includes some of our most popular drinking fountains.

- Crisp, chilled water from in-unit refrigeration
- Maintenance Advantage® design
- Child/Adult ADA compliant
- Accommodates a 3,000 gallon water filter
- Vandal-resistant models available



A17-VR Series

- Durable, vandal-resistant design

A171408S-UG-VR



A17FGVR Series

- Enhanced vandal resistance for the highest security needs

A171408S-FG-VR



A172 Series

- Enhanced design
- Bi-level construction

A172108S-UG

murdock

WATER COOLER & BOTTLE FILLER



A13-VR Series

- Vandal-resistant drinking fountain with oval bowl

A131400S-VR



A15-VR Series

- Vandal-resistant drinking fountain with rounded square bowl

A151400S-VR



A19 Series

- Wide basin

A191400S



A311.8 Series

- Wall-mounted drinking fountain with in-unit refrigeration

A31108S-G



A611.8 Series

- Freestanding drinking fountain with in-unit refrigeration

A61108S-G

A481 & A481CUSP Series

- Recessed drinking fountain with in-unit refrigeration
- CUSP variant includes a companion cuspidor
- Non-ADA

A481408S-CUSP



A481408S



AL81408S-BF

AL81.8 Series

- Ligature resistant
- Integrated chiller above fountain

AL81 Series

- Ligature Resistant
- Integrated chiller below fountain



AR81408S-BF

AR81 Series

- Ligature resistant
- Integrated chiller above fountain



Murdock

Indoor Bottle Fillers



H2O-To-Go![®] BF16 Series

- Attractive design
- Series includes deck-mounted and standalone models with many configuration options
- Refrigerated options

BF16-BCD



BF1S and BF2S

- Mounts to A17 series water fountain
- Pushbutton (BF1S) or touchless (BF2S) operation

BF2S-BCD

BF1SC and BF2SC

- Mounts to A151 or comparable water fountains
- Drains to fountain



BF1SC

BFEZ168

- H2O-To-Go![®] EZReach[®] compact 2/3 size bottle filler



BFEZS168-BCD

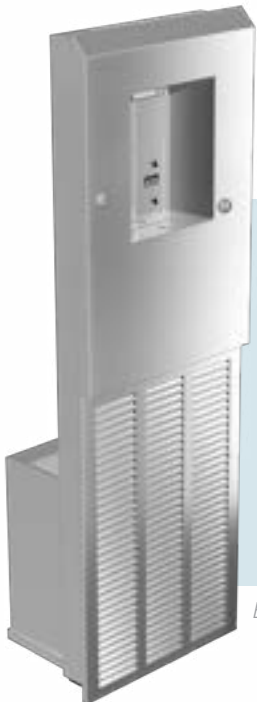

BF38 and BF48

- Standalone, wall-mounted design
- Pushbutton (BF38) or touchless (BF48) operation
- In-unit refrigeration

BF38



BF12R-BCD

- Deck mounted bottle filler to retrofit older Murdock[®] water coolers

BF12R-BCD



BF168S-BCD-EG29

Reliable bottle fillers suitable for use alone or combined with drinking fountains. The BF16 series includes some of our most popular bottle fillers.

- All stainless steel construction
- Attractive, curved design
- Configuration options include mounting type (wall or deck) and operation (pushbutton or sensor)



SpringH2O® Standalone Curved Sensor Operated Bottle Filler - BF16S-BCD

murdock

DRINKING FOUNTAIN & BOTTLE FILLER Combination Units



A171400S-UG-VR

**A171 and A172 Series
drinking fountains are
compatible with**

- SpringH2O® Series
- H2O-To-Go!® Series
- BF1S and BF2S Series



A172400S-UG-VR-BF12S-BCD



**SpringH2O®
Series**

A172400S-UG-VR-BF12S-BCD



**H2O-To-Go!®
Series**

BF12-BCD



**BF1S and BF2S
Series**

BF2SC



A131408S-VR-BF4

- Vandal-resistant design
- ADA compliant 



A131-VR-BF4

- Vandal-resistant design
- ADA compliant 

A151-VR-BF4

- Vandal-resistant design
- Recessed bottle filler
- Integrated refrigeration
- ADA compliant 



A151408S-VR-BF4

- Vandal-resistant design
- Recessed bottle filler
- Integrated refrigeration
- ADA compliant 

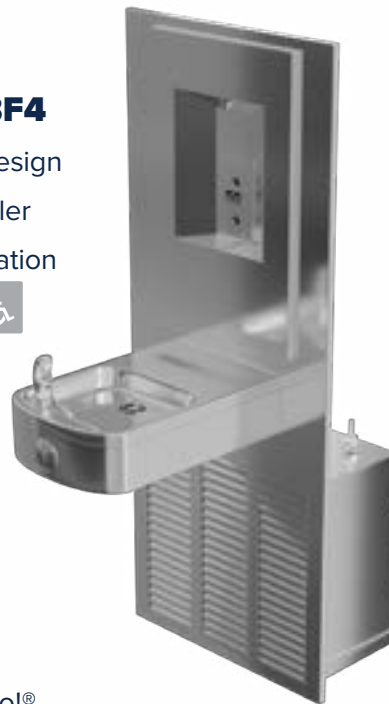

A191408S-BF12

- Pushbutton drinking fountain with H2O-To-Go!® bottle filling station
- ADA compliant 



A171408S-FG-VR-BF1S

- Enhanced vandal resistance
- ADA compliant 

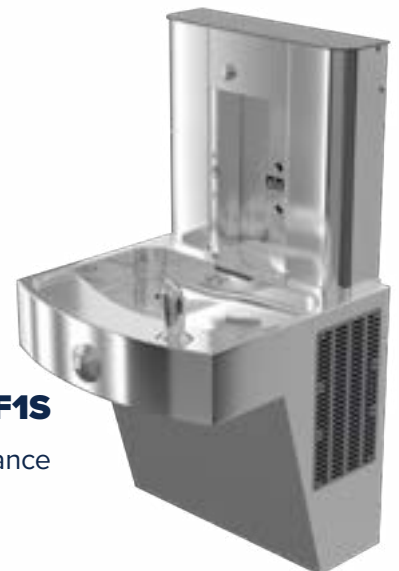

murdock

**Custom colors
are also available
on our outdoor units!**



GYM74-PF

*Outdoor Pedestal Bottle
Filler with Barrier-Free
Drinking Fountain*

BOOK



See our complete line of outdoor drinking fountains by scanning the code above.

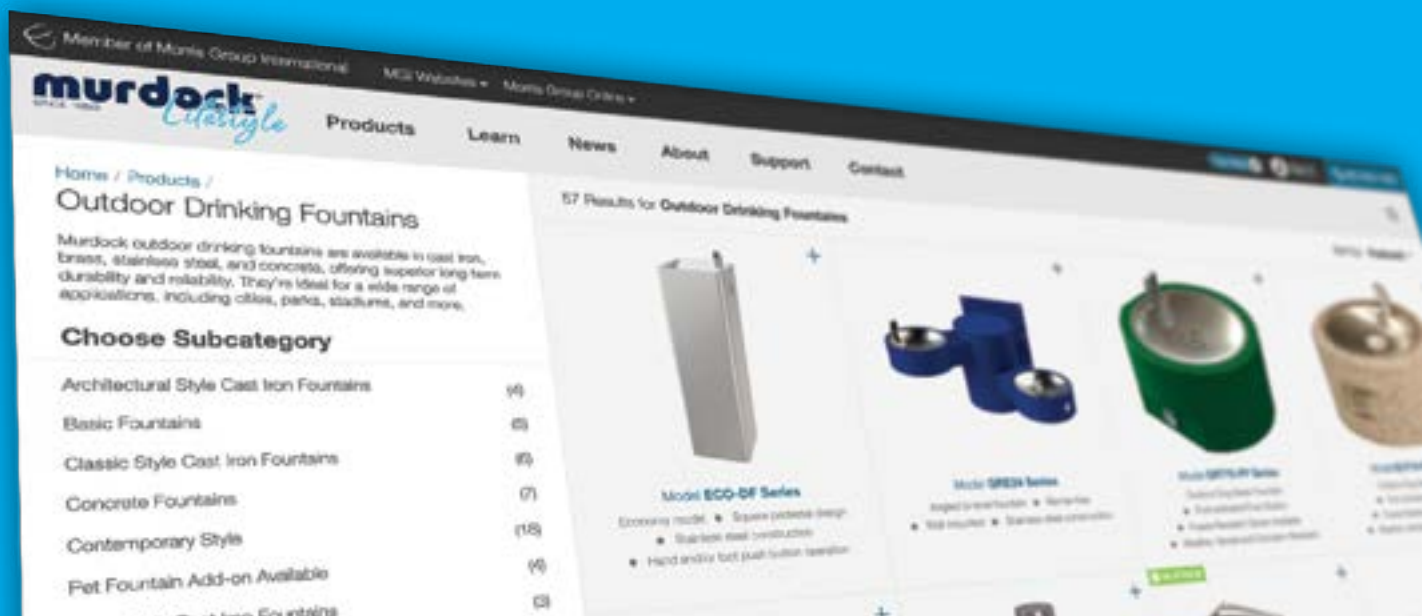

MORRIS GROUP INTERNATIONAL

WWW.MORRISGROUPINT.COM

PLUMBING



FIRE PROTECTION



MANUFACTURING SUPPORT



SALES AND DISTRIBUTION



PHONE: (626) 336-4561
E-MAIL: INFO@MURDOCKMFG.COM
WEBSITE: MURDOCKMFG.COM

L1001638
0126