

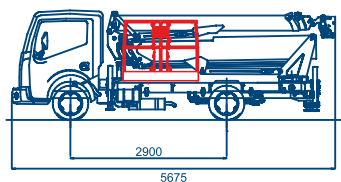

DT24

 **cela**

360° CONTINUOS

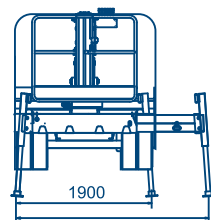
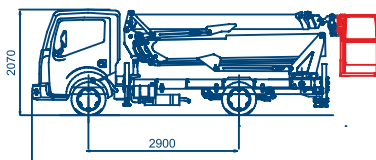
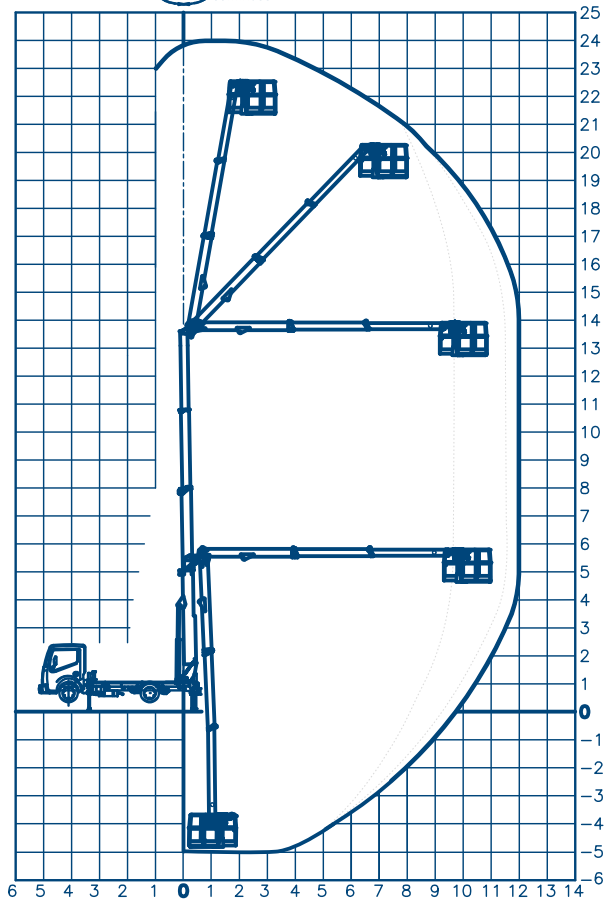

DOTAZIONE STANDARD

- ARTICOLAZIONI CON BOCCHOLE AUTO LUBRIFICANTI
- STABILIZZAZIONE IN SAGOMA CON TRAVERGE POSTERIORI ESTENSIBILI
- COMANDO DAL CESTELLO PER SEGNALE ACUSTICO
- COMANDO DI AVVIO/ARRESTO DEL MOTORE DAL CESTELLO
- CONTATORE ELETTRICO
- DISPOSITIVO MULTIASIALE PER CONTROLLO VISIVO DELLA STABILIZZAZIONE DEL TELAIO
- IMPIANTO IDRAULICO A FILTRAGGIO DIFFERENZIATO CON FILTRI AD ALTA EFFICIENZA SIA SULLE LINEE DI MANDATA CHE SULLE LINEE DI RITORNO
- POMPA DI EMERGENZA MANUALE
- PRESA ELETTRICA NEL CESTO 230 V NEL CESTO
- ROTAZIONE CESTELLO 80° + 90°
- SISTEMA ANTICOLLISIONE CABINA
- STABILIZZAZIONE "EASY LIFT"
- TUBAZIONI E CAVI ALL'INTERNO DEI BRACCI
- VALVOLE DI BLOCCO FLANGIATE
- DISTRIBUTORE ELETTRIDRAULICO PROPORZIONALE COMPENSATO CON FLOW-SHARING
- COMANDI A CONTROLLO ELETTRONICO
- TRASMISSIONE DATI IN CANBUS

www.cela.it

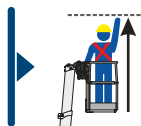

24 ,00 m

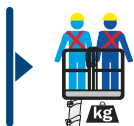

200 kg

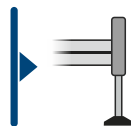

H + H

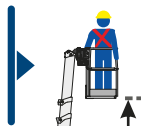

22 ,00 m

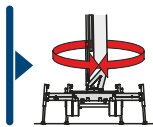

360°

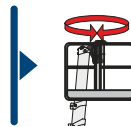

90°+90°

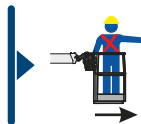

12 ,00 m

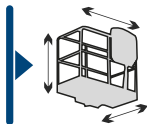

1,4x0,7x1,1
1,8x0,7x1,1



ELECTRONIC

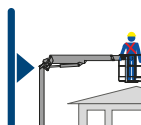

14 ,00 m

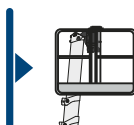

ALUMINIUM



3,5 T



Celo industry

STANDARD EQUIPMENT



- ANTI-COLLISION DEVICE BETWEEN BOOMS AND TRUCK CABIN
- BASKET ROTATION 90° + 90°
- BUZZER FROM THE BASKET
- EASY-LIFT STABILIZATION
- ELECTRIC HOUR-COUNTER
- EMERGENCY HAND-PUMP
- FLANGED HOLDING VALVES
- HYDRAULIC SYSTEM WITH DIFFERENTIAL FILTERING SYSTEM IN BOTH FLOW DIRECTION
- MAGNETIC REVOLVING LIGHT ON TRUCK CABIN
- 230 V ELECTRIC PLUG IN THE BASKET
- PIPES AND CABLES INSIDE THE BOOMS
- SELF-GRASING BUSHES
- START-STOP OF THE ENGINE FROM THE BASKET
- CLOSED TO SHAPE STABILIZATION WITH EXTENSIBLE OUTTRIGGERS
- VISUAL CONTROL DEVICE FOR CHASSIS STABILIZATION
- ELECTRO-HYDRAULIC PROPORTIONAL VALVE BLOCK WITH FLOWSHARING
- ELECTRONICALLY MANAGED CONTROLS
- CAN-BUS DATA TRANSMISSION

STANDARD AUSSTATTUNG



- ANFAHRSCHUTZ FÜR KABINE ARBEITSKORB
- 90° + 90° DREHBARER ARBEITSKORB
- ELEKTRISCHER STUNDENZÄHLER
- GELENKE MIT SELBSTSCHMIERENDEN BUCHSEN
- HAND-NOTPUMPE
- HOCHLEISTUNGSFILTER IN DER HYDRAULIK ANLAGE FÜR VOR- UND RÜCKLAUFPILTER
- IN ARMEN LIEGENDE LEITUNGEN UND KABEL
- 230V STECKDOSE IM ARBEITSKORB
- MAGNETISCHE BLINKLEUCHTE AUF DER FAHRZEUGSKABINE
- MOTOR START-STOPP VOM ARBEITSKORB
- MULTI-AXIALE EINRICHTUNG FÜR DIE VISUELLE PRÜFUNG DER ABSTÜTZUNG
- KASTENAUFAU
- WARNHUPE VOM ARBEITSKORB
- SICHERHEITS- HALTEVENTILE
- ABSTÜTZUNG IM FAHRZEUGPROFIL MIT RÜCK- ERSTRECKBAREN AUSLEGERN
- ELEKTRO-HYDRAULISCHER PROPORTIONALER VERTEILER MIT FLOWSHARING
- ELEKTRONISCHEN STEUERUNGEN
- CAN-BUS DATASENDUNG

CONFIGURATION STANDARD



- ARTICULATIONS AUTOLUBRIFIANTES
- STABILISATION DANS LE GABARIT AVEC TRAVERSES ARRIÈRE EXTENSIBLES
- CLAXSON DANS LE PANIER
- COMPTE-HEURES ELECTRIQUE
- DISPOSITIF MULTI-AXIAL POUR LE CONTRÔLE VISUEL DE LA STABILISATION DU CHÂSSIS
- GYROPHARE MAGNETIQUE SUR LA CABINE CAMION
- INSTALLATION HYDRAULIQUE DIFFÉRENTIELLE AVEC FILTRE À HAUTE EFFICACITÉ SOIT SUR LES LIGNES DE RETOUR, SOIT SUR LES LIGNES DE REFOULEMENT
- MISE EN MARCHÉ ET ARRÊT DU MOTEUR DANS PANIER
- POMPE D'ÉMERGENCE MANUELLE
- PRISE ÉLECTRIQUE 230 V DANS LE PANIER
- ROTATION PANIER 90° + 90°
- SYSTÈME ANTICOLLISION CABINE ET PANIER
- STABILISATION "EASY LIFT"
- SOUPAPES FLANGE
- TUYAUX ET CÂBLES DANS LES BRAS
- DISTRIBUTEUR ELECTRO-HYDRAULIQUE PROPORTIONNEL AVEC FLOWSHARING
- COMMANDES À CONTROL ÉLECTRONIQUE
- TRANSMISSION DONNÉES CAN-BUS

Cela **DT24**

la soluzione *the solution*

1 LA PIATTAFORMA INVISIBILE
The Invisible Boom

2 PASSIAMO SOPRA OGNI COSA
We fly all over

14 mts up and
12 mts over:
never so high

3 SOTTOSOPIRA
Downunder

4 TUTTO IN UNO
All in one

5 ATTERRIAMO OVUNQUE
We land anywhere

6 ANDIAMO SU DRITTI
Let's go straight up

14 m

7 DOLCI E VELOCI
Sweets and fast

Comandi a controllo elettronico,
manovre multiple simultanee
Electronic controls, multi syncro manoeuvres

8 NON TI FACCIAMO GIRARE LA TESTA
We don't drive (your head) crazy

90° + 90°

9 CONFIGURAZIONI OPERATIVE *Operational Configuration*

