

OIL COOLING GUIDE

PORSCHE

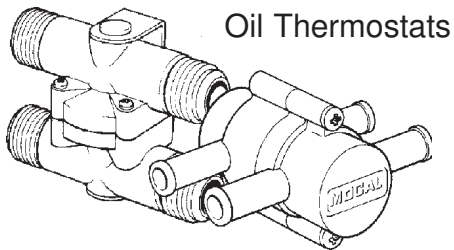

Porsche 911 / 930 Series ❖ Porsche 914-4 / 914-6 ❖ Porsche 924 / 928 / 944



Oil Thermostats

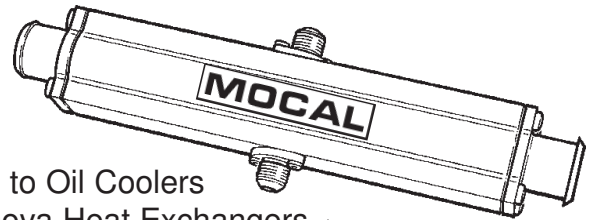

Water to Oil Coolers
Laminova Heat Exchangers

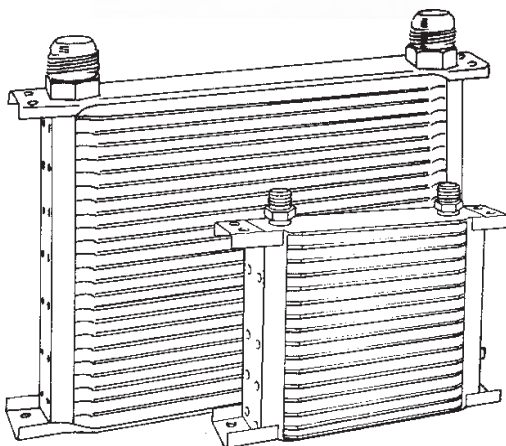
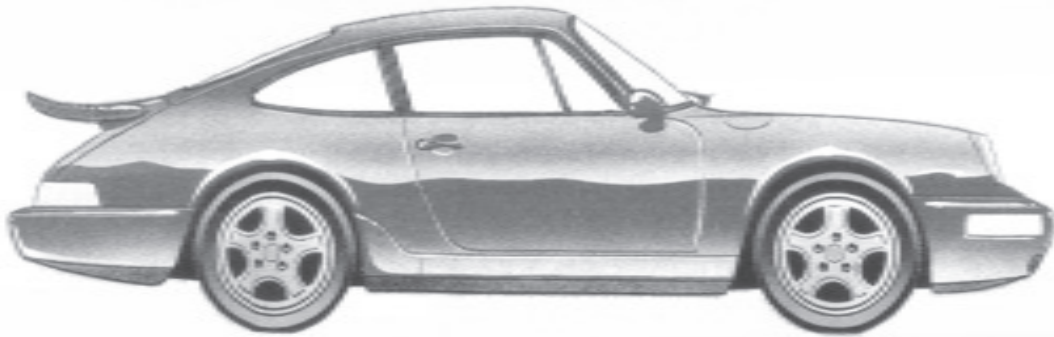

Oil Coolers
235mm & 115mm
Core Sizes - Radiator Type

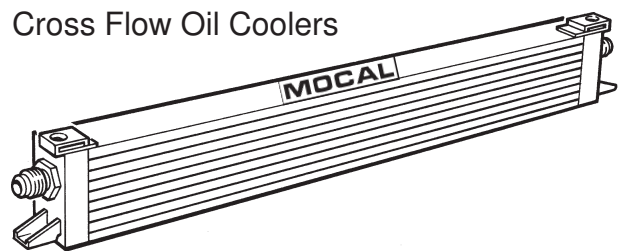

Cross Flow Oil Coolers

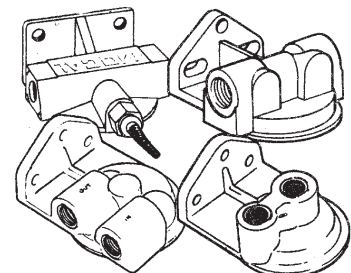

Remote Oil Filter Equipment

Catalog Supplement



Fender Mount Oil Cooler Installations For PORSCHE 911/930 Series

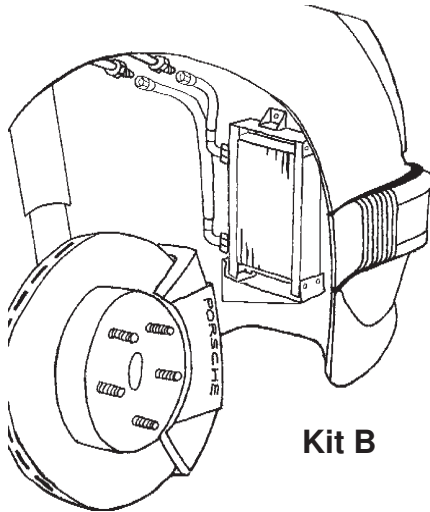

Kit B



19 Row 235m cooler w/ assembled hoses & brackets

Kit B-"loop" replacement kit

This kit is especially good for replacing the factory "loop" oil device located in the front right fender making it easy to upgrade to a MOCAL oil radiator at an economical price. We have sold these "B Kits" over 25 years making it the most popular oil cooling upgrade available. Kits include: Oil cooler with pre-assembled hoses with fittings swagged into Aeroquip reinforced rubber hose. Custom brackets are supplied for easy installation.

19 Row (235m) Cooler Kit **KPORB** **\$425.00**
cooler size 11" x 6" x 2"

Larger Cooler Option

Substitute a 30% larger 310 matrix (14"h x 6"w x 2"d) cooler.

19 Row (310m) Cooler Kit **KPORB+** **\$520.00**
cooler size 14" x 6" x 2"

Fan Options

Install a fan for increased cooling performance in some driving or climate conditions. Mounting special slim zip/strip locking ties through cooler fins. Adjustable wiring kit with relay/controller or simple 12 volt relay (you supply switch).

5.25" Push Fan **A52FAN-PU** **\$79.50**
fan mounts forward of cooler

5.25" Pull Fan **A52FAN-PL** **\$79.50**
fan mounts rear of cooler (wheel/tire side)

Mounting Ties & Locks (4) **ABKT1** **\$16.45**

Adjustable Wiring Kit (160^o-210^of) **AFTR1** **\$105.00**

Relay & Wiring Harness **RELAY12** **\$8.50**



5.25" fan & mounting ties



Adjustable thermo fan wiring kit

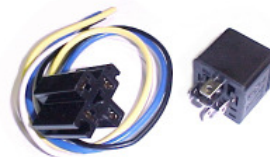

12v relay & wiring

MOCAL USA

MOCAL USA



FENDER MOUNT OIL COOLER SIZE COMPARISON

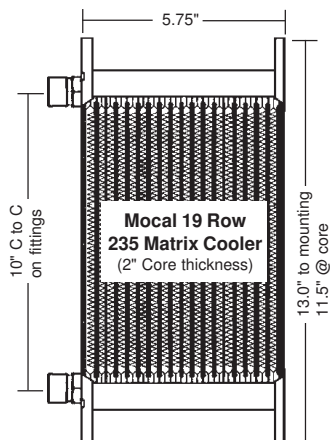

MOCAL 19 Row 235 Matrix Cooler

All aluminum 19 pass core incorporating oil turbulators for maximum efficiency. Full size -12AN 3/4" inlet/outlet for unimpeded oil flow. This cooler is the basis of our popular fender mount "B" Kit offering radiator oil cooler performance at an entry level price.

Popular Porsche Applications:

Front fender all 911 years (fittings sideways, as pictured) Our ("B" install kit) supplies assembled hoses and fittings to locate the 19 row cooler in place of the factory "loop" cooling device. The 6.5" fan kit can be added if desired.

Front spoiler (fittings top) Some aftermarket spoiler/bumpers have enough height for this option. *Measure before ordering - 8.5" height required to clear fittings.*

Rear engine cover on 914's (fittings forward). 25 row size is an optional up-grade. The 6.5" fan kit can be added to either size.

Rear brake ducts. The type of decor ducts commonly added to turbo style rear wheel houses. The 19 row cooler lends itself to being mounted (fittings inboard) behind one or both* rear ducts. **two 19 rows run in series are more than capable of cooling highly modified and or turbocharged engines.* This option is very popular on slope nose front ends where front end space is limited. The front cooler can actually be eliminated.

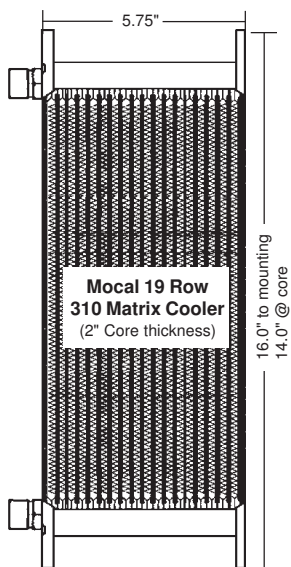

MOCAL 19 Row 310 Matrix Cooler

All aluminum 19 pass extended core incorporating oil turbulators for maximum efficiency. Full size -12AN 3/4" inlet/outlet for unimpeded oil flow. This (new for 1995) cooler is a stretched version of the standard 235 matrix 19 row cooler offering 30% more oil cooling capacity. It is an excellent choice when a margin of over-kill is desired or where hard duty is the norm. These coolers offer performance similar to our proven 44 and 50 row models at a more affordable price.

Popular Porsche Applications:

Front fender all 911 years (fittings sideways, as pictured) Our ("B" Plus install kit) supplies assembled hoses and fittings to locate the 19 row extended cooler in place of the factory "loop" cooling device. The 6.5" fan kit can be added if desired.

Front spoiler (fittings top) Some aftermarket spoiler/bumpers have enough height for this option. *Measure before ordering 8.5" height required to clear fittings.*

Rear engine covers on 911's without A/C. We have had a few customers install these coolers in "whale tail" engine covers under the grill, where the A/C condenser usually is located.

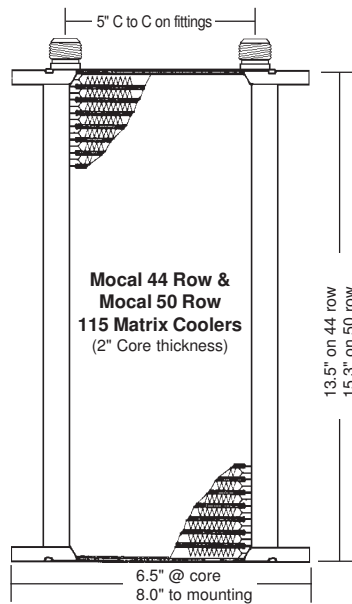

MOCAL 44 & 50 Row 115 Matrix Cooler

All aluminum 44 or 50 pass core incorporating oil turbulators for maximum efficiency. Full size -12AN 3/4" inlet/outlet for unimpeded oil flow. Outstanding performance and user friendly dimensions make these coolers are very popular in front fender and front spoiler applications.

Popular Porsche Applications:

Front fender all 911 years (fittings top, as pictured) The 44 and 50 row coolers are very close to the size, shape and layout of the factory Porsche radiator coolers used in 84 and newer 911 models. Our 6.5" cooling fan can be added if desired.

Front spoiler (fittings towards RH side) most aftermarket spoilers and spoiler/bumpers have plenty of room for either the 44 or 50 row core sizes turned sideways.

Rear engine covers on 911's without A/C. We have had a few customers install these coolers in "whale tail" engine covers under the grill, where the A/C condenser usually is located.

Installation kits providing pre-sized and assembled hoses with metric and Aeroquip fittings are available for most 911 models. Universal bracket material is supplied which can be used to assist in mounting the oil cooler in various locations and positions. Forspecial applications we can provide bulk lengths of hose (stainless braid AQP or R6 textile) and fittings (aircraft type) for customer D.I.Y. assembly.

MOCAL USA

MOCAL USA



COMPLETE OIL COOLING KITS*
*for cars without factory plumbing

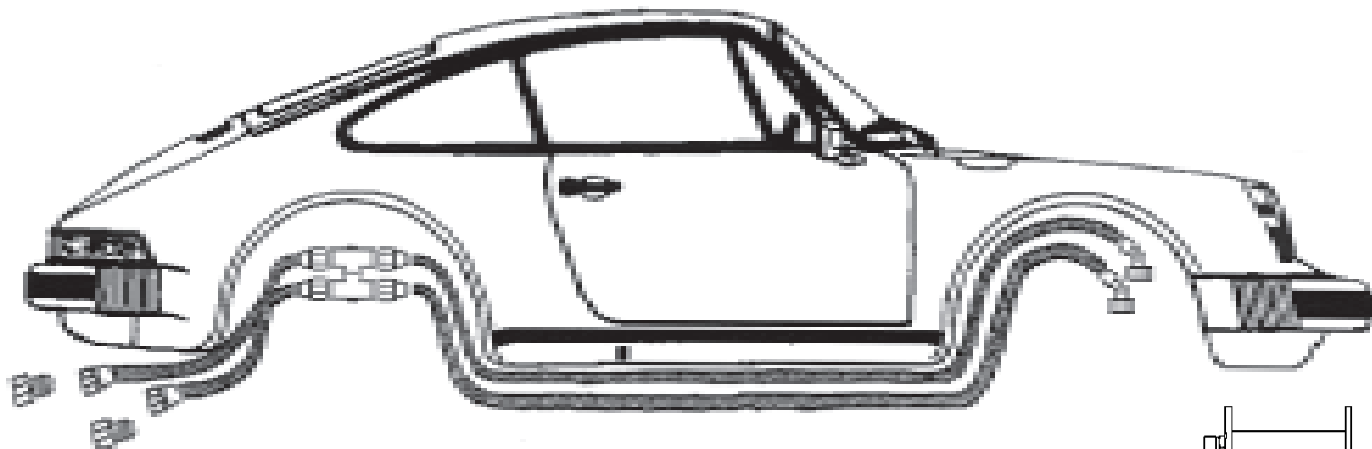

Many pre. 1977 Porsche 911's are not equipped with factory oil plumbing (hard lines and thermostat). In this case fitting an oil cooler requires making a hose run from the rear to the front of the vehicle and back. We find the easiest and most cost effective method of plumbing is to duplicate the factory plumbing route using Aeroquip hose and fittings with a Mocal oil thermostat and oil cooler.

The various kits that we offer to accomplish this task include; one of a number of oil cooler options (some are suitable for both fender or front spoiler location), Mocal -12 AN Oil Thermostat with mounting bracket, 30 foot length of AQP -12 AN stainless braid 3/4" ID hose, 30mm metric to -12 AN adaptors for the oil tank and engine pipe, -12 AN alloy aircraft hose ends and assorted mounting accessories. The above components will allow for a fairly easy DIY installation that is both efficient and durable, that is why most racing cars oiling systems are also plumbed in this method. *This kit is supplied in bulk, meaning the hose lengths and hose ends are to be assembled and fitted by the customer.*

KIT C 19 Row Oil Cooler and the above listed plumbing components needed to install oil lines and Mocal Thermostat on non-factory oil line equipped 911's. *This kit is for front fender mounting only.*
Kit Price \$975.00

KIT C+ 19 Row "extended" Oil Cooler and the above listed plumbing components needed to install oil lines and Mocal Thermostat on non-factory oil line equipped 911's. *This kit is suitable for front fender mounting only.*
Kit Price \$1025.00

KIT D 44 Row Oil Cooler and the above listed plumbing components needed to install oil lines and Mocal Thermostat on non-factory oil line equipped 911's. *This kit is suitable for both fender and front spoiler (when turned sideways) mounting, specify when ordering.*
Kit Price \$1150.00

KIT E 50 Row Oil Cooler and the above listed plumbing components needed to install oil lines and Mocal Thermostat on non-factory oil line equipped 911's. *This kit is suitable for both fender and front spoiler (when turned sideways) mounting, specify when ordering.*
Kit Price \$1255.00

KIT F 72 Row Oil Cooler and the above listed plumbing components needed to install oil lines and Mocal Thermostat on non-factory oil line equipped 911's. *This kit is suitable for front spoiler mounting only.*
Kit Price \$1415.00

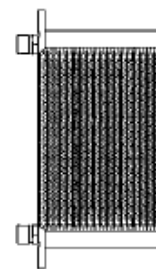

Kit C
19 Row Cooler
(11h x 6w x 2d)

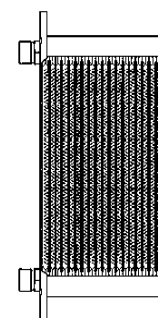

Kit C+
19 Row Cooler
"Extended"
(14h x 6w x 2d)

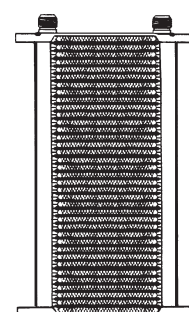

Kit D
44 Row Cooler
(14h x 6.5w x 2d)
fender or spoiler

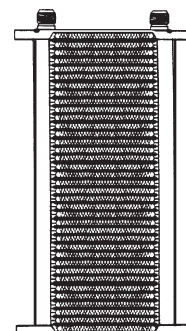

Kit E
50 Row Cooler
(16h x 6w x 2d)
fender or spoiler

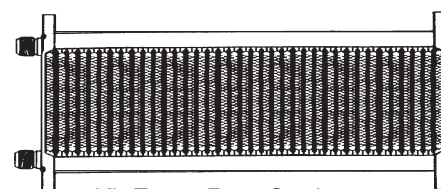

Kit F 72 Row Cooler
(6.5h x 22w x 2d)
front spoiler mounting only



COMPLETE OIL COOLING KITS* *for cars without factory plumbing

Kits for adding oil cooling to 1974-78 911's not factory equipped or project cars of most years without stock plumbing. The largest cooler that can be fitted in the fender is normally 50 row. Depending on front spoiler, a 44, 50, 60 or 70 row cooler can normally be fitted (check dimensions). Drawings of most coolers elsewhere in this document. Kits include: oil cooler, thermostat, mounting brackets, uncut length of -12AN stainless braid hose, aircraft type hose ends, metric adaptors, hose clips to secure/locate hose. Adding a fan is optional for front fender installations (see elsewhere in document) but is not normally used with front spoiler applications as airflow is not usually an issue at the front of the car.



KIT D 44 Row Oil Cooler kit for non-factory oil line equipped 911's.

Price \$1150.00

This kit is suitable for fender or front spoiler (when turned sideways) mounting, specify when ordering.

KIT E 50 Row Oil Cooler kit for non-factory oil line equipped 911's.

Price \$1255.00

This kit is suitable for fender or front spoiler (when turned sideways) mounting, specify when ordering.

KIT F 72 Row Oil Cooler kit for non-factory oil line equipped 911's.

Price \$1415.00

This kit is suitable for front spoiler mounting only.

KIT G 60 Row Oil Oil Cooler kit for non-factory oil line equipped 911's.

Price \$1345.00

This kit is suitable for front spoiler mounting only.

Size Comparison
115m (Series 1) Oil coolers
front fender or spoiler
apliaction



44 Row
(13.5" x 6.5" x 2")

50 Row
(15.25" x 6.5" x 2")

60 Row
(18.5" x 6.5" x 2")

72 Row
(22.25" x 6.5" x 2")



5.25" fan
for fender
mount can
be added



OIL THERMOSTATS

All Porsche 911 series automobiles that incorporate oil cooling systems include an oil thermostat device. We could not agree more. That is why Mocal has become one of the largest aftermarket suppliers of oil thermostat devices in the world, making them the choice for anyone considering adding oil cooling equipment on cars not originally thermo equipped. Mocal Thermostats are available in all popular (-8AN, -10AN, -12AN, -16AN) sizes, the -12AN and -16AN sizes are most popular for 911/930 applications.

Mocal thermostats are designed to prevent the flow of engine oil through the oil cooler until the desired temperature is reached. Prolonged use of engines in conditions that oil cannot reach optimum working temperatures will cause sludge formation and crankcase oil dilution, leading to excessive wear especially in the cylinder bores. Thermostats combat this by regulating oil flow to accelerate warm up. This in turn reduces drag helping, to yield optimum engine efficiency and performance.

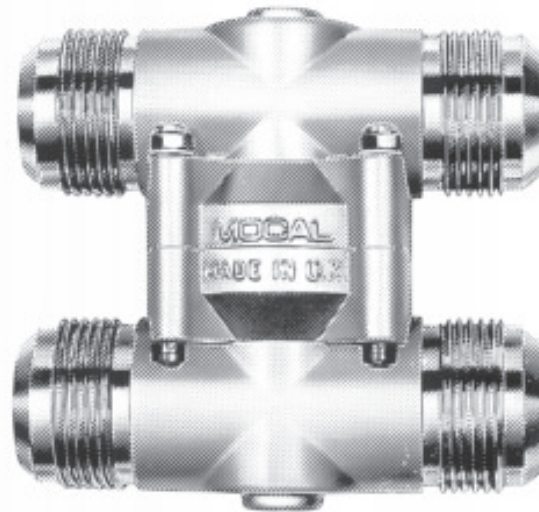

Specifications

- ◆ All aluminum CNC machined housing
- ◆ Aeroquip compatible male fittings
- ◆ Available in AN-8, AN-10, AN-12 and AN-16 fittings
- ◆ Factory set 180 degree operation
(optional temperatures ranges available)
- ◆ Includes mounting hardware
- ◆ Race proven design
(used by major racing teams world wide)

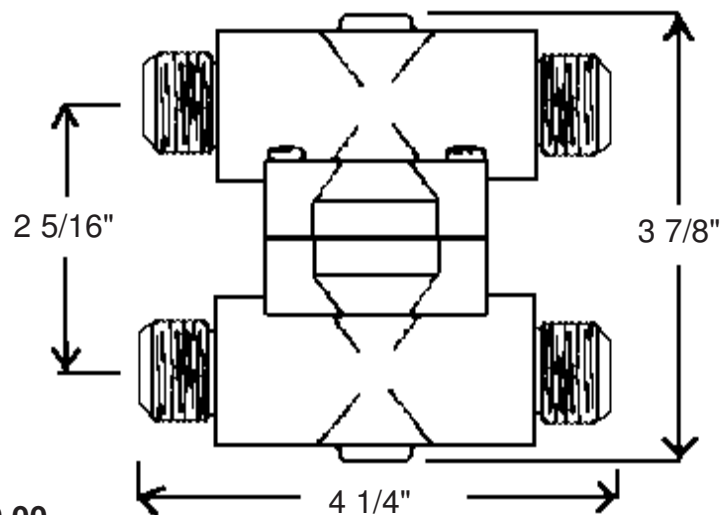

-12 AN Thermostat A0T2-12 \$190.00
 -16 AN Thermostat A0T2-16 \$190.00

MOCAL USA

MOCAL USA



REMOTE OIL FILTER MOUNT

When plumbing 911 type engines for alternate location tanks and oil filters, be careful when selecting the oil filter mount. Most filter mounts on the market use 1/2" NPT tread on the inlet/outlet ports, which is too restrictive and can cause oil flow issues on drysump engines. We have a solution with this large format remote oil filter mount that uses generously sized 22mm inlet/outlet (same as ports used throughout the factory oiling system). The filter stand is four port type which allows for numerous configurations: left in/out, right in/out, right to left, or left to right. The mounting bracket can even be swapped to that the flow pattern can be switched if you need. All in all a very versatile piece. For filters choose any of the Fram (or alike) HP series racing filters in 13/16" thread. Hardware and (2) M22 plugs are included. Choose M22 x -12AN or -16AN male/male unions (sold separately). Note -16AN size fittings can only be used in right/left or left right cross configurations, not both in same side.



Specifications

- ◆ All aluminum CNC machined housing
- ◆ Interchangeable flow patterns & mounting
- ◆ Large M22 x 1.5 ports are better flowing than 1/2" NPT
- ◆ Uses large can racing oil filters
- ◆ Includes mounting hardware & plugs
- ◆ Made in USA

HD 4 Port Filter Mount RFH4HD \$99.00
uses 13/16" filter

M22 x -12AN Fitting M22AN12-SE \$8.75ea
M22 x -16AN Fitting M22AN16-SE \$9.60ea





911/930 Front Spoiler Oil Coolers

44 Row
\$545.00

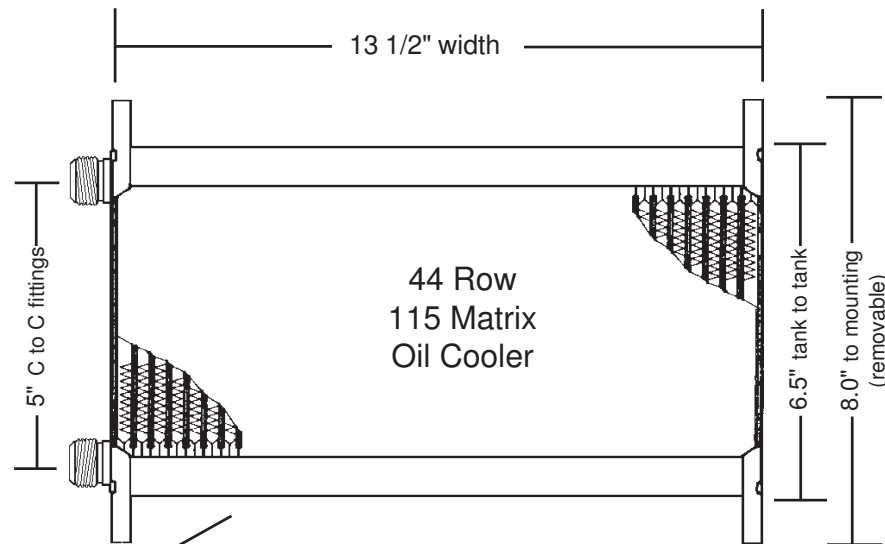

NOTE: 44 & 50 row coolers are 2" thick

50 Row
\$599.00

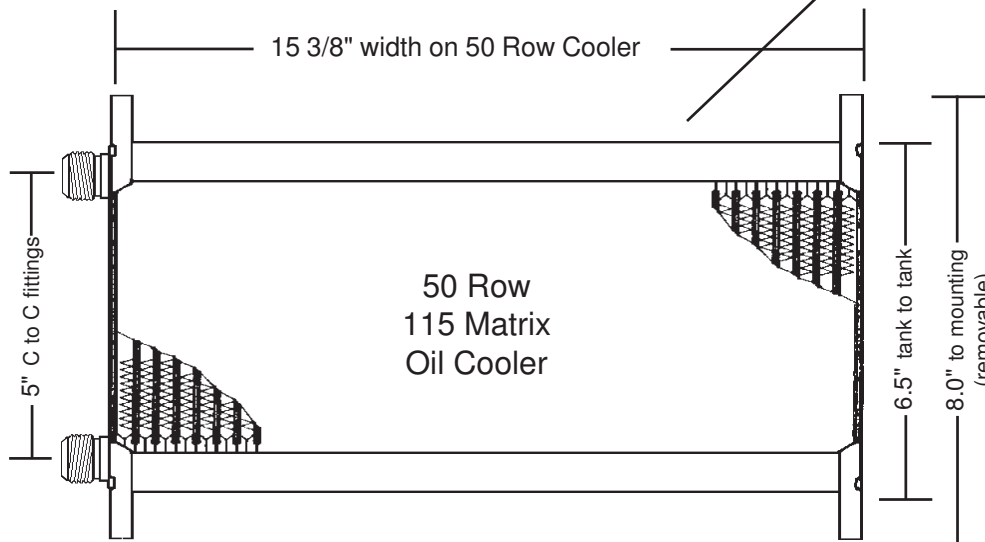

Another popular cooling option is to mount a Mocal 115 matrix (44, 50, 60, 65, or 70 row) oil cooler sideways in a front spoiler. The 44 & 50 row coolers are the same core sizes that we commonly install upright in front fender applications, but when mounted in the spoiler they offer better performance due to greater air flow. All 115 matrix coolers are available in either AN-12 or AN-16 fittings.

MOCAL USA

MOCAL USA



911/930 Front Spoiler Oil Coolers

60 Row
\$605.00

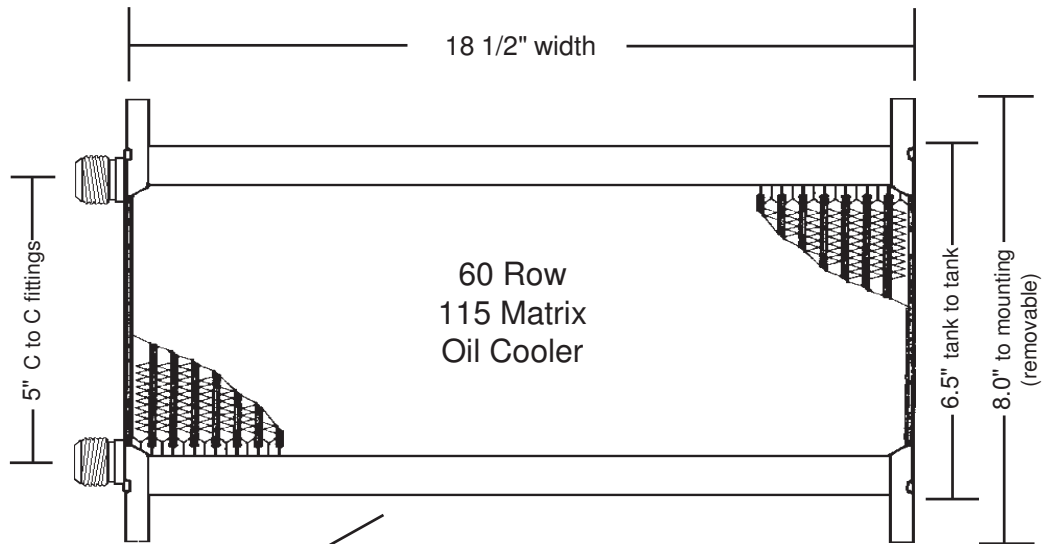

NOTE: 60 & 65 row coolers are 2" thick

65 Row
\$655.00

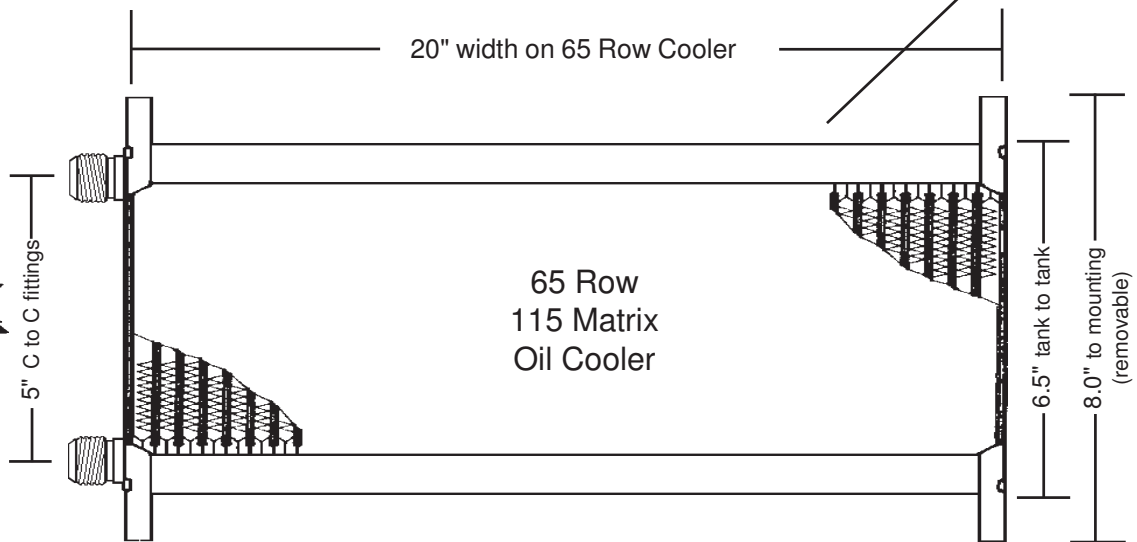

The 60 and 65 row 115mm coolers are a relatively new offering. At 18 1/2" and 20" these versatile size cores fill in the gap between the 50 and 72 row models. We now have 5 core size possibilities between 13 1/2 and 22 1/4" to suit just about any type front spoiler application!

MOCAL USA

MOCAL USA



911/930 Front Spoiler Oil Coolers

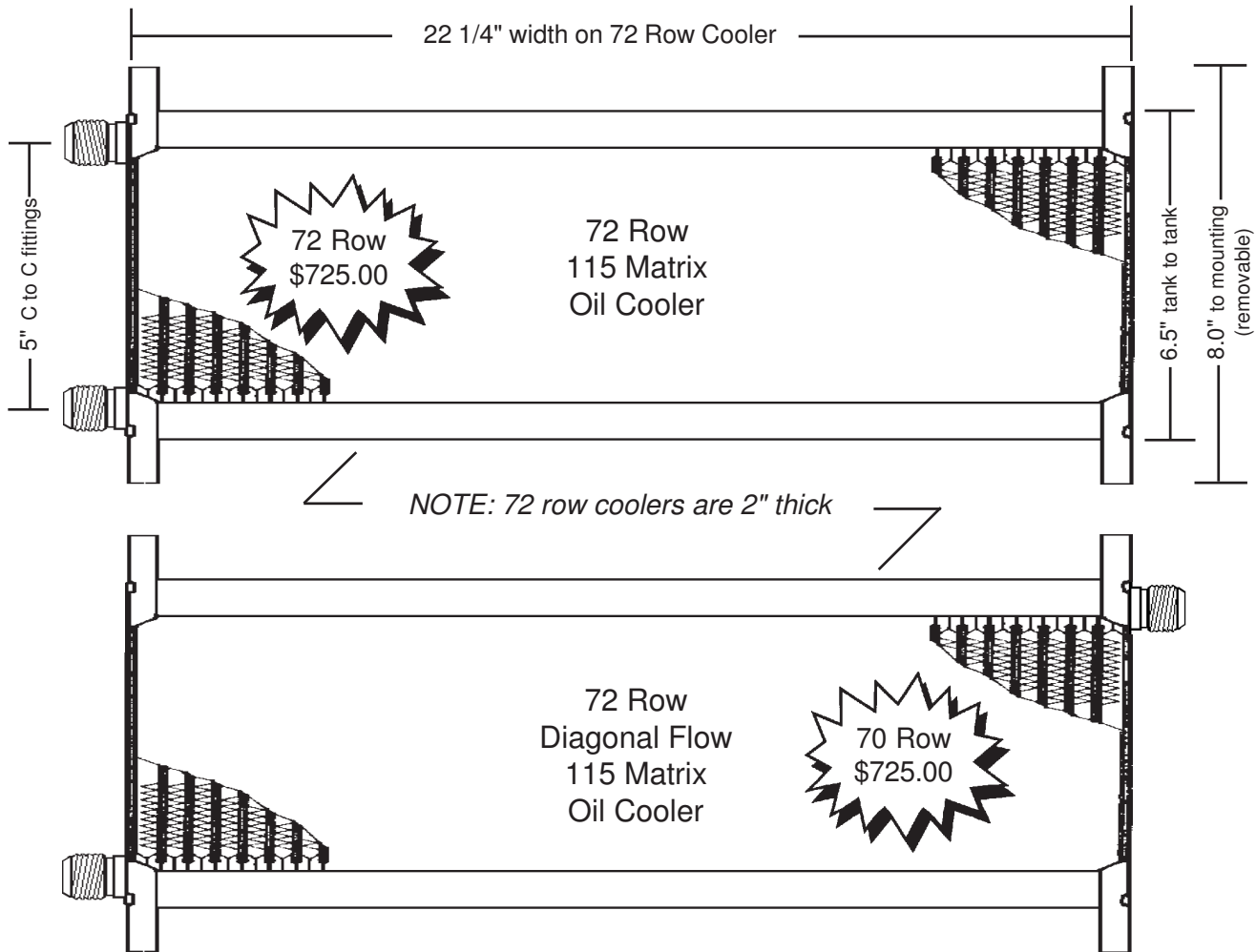

Currently the largest of the 115m (Series 1) oil coolers, 72 row coolers are available with same side inlet/outlet or diagonal flow plumbing.

MOCAL USA

MOCAL USA



Front Spoiler Oil Coolers

M22 Female Port Accepts (shown w/ M22 plug, others optional)



M22 Female Port Accepts (shown w/ -12AN union, others optional)

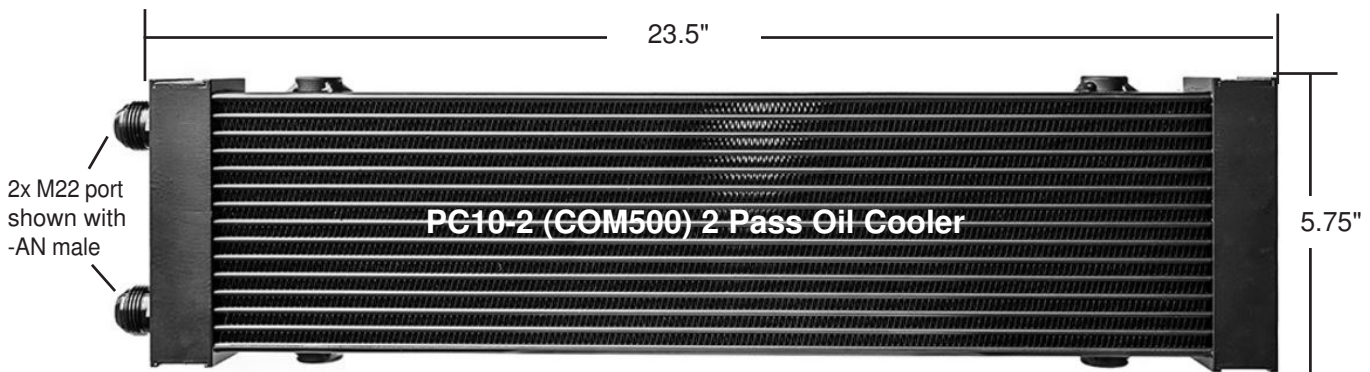
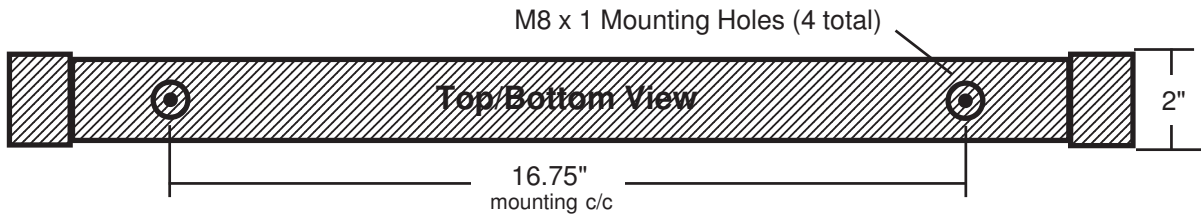

These large, versatile oil coolers make fitting front spoiler applications a breeze. The competition derived PC10 oil cooler is a cross flow type with one fluid connection per side. Oil flows across cooler, side to side using one of the two provided ports at end or rear. The remaining 2 ports are plugged or may be fitted with a temperature sender for use with a gauge. For installations where fluid connection is preferred on the same side we offer a dual pass version, the PC10-2, with both fluid connections on one side (oil flows across cooler and returns to the same side). Fluid connection ports on both PC10 and PC10-2 are M22 x 1.5 female thread which accepts -AN (-12, -16) or metric (M26, M30) size plumbing.

Cross Flow Oil Cooler	PC10	\$795.00
Dual Pass Oil Cooler	PC10-2	\$795.00



911/930 Front Spoiler Oil Coolers

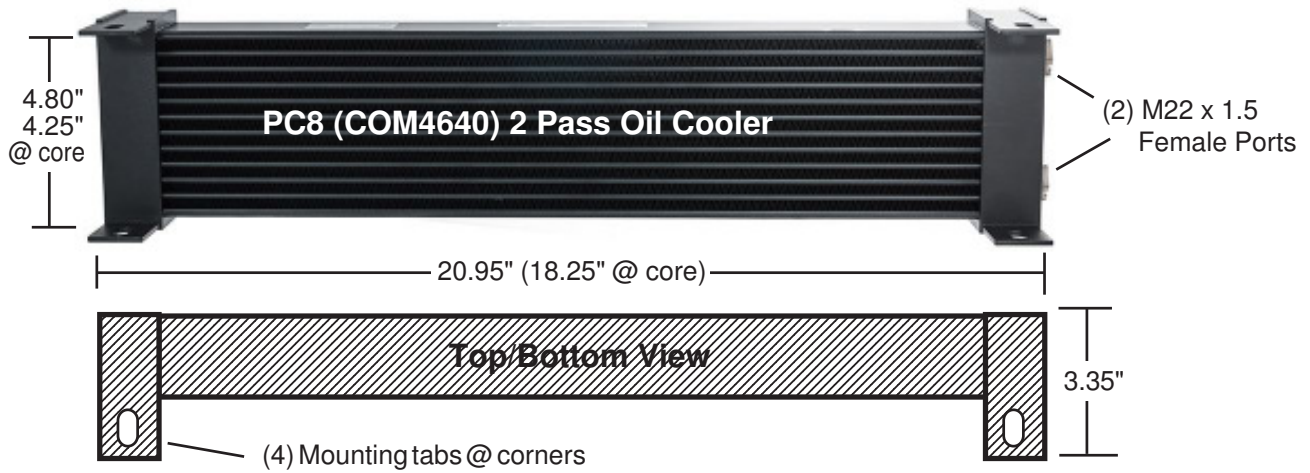

The competition derived PC8 oil cooler is a 2 pass type with both fluid connection on one side (oil flows across cooler and returns to the same side). Fluid connection ports are M22 x 1.5 female thread which accepts -AN (-12, -16) or metric (M26, M30) size plumbing. To aid in installation, cooler is constructed with mounting tab at four corner points.

2 Pass Flow Oil Cooler PC8 (COM4640) \$521.50

AN -12 Fittings or
AN -16 Fittings

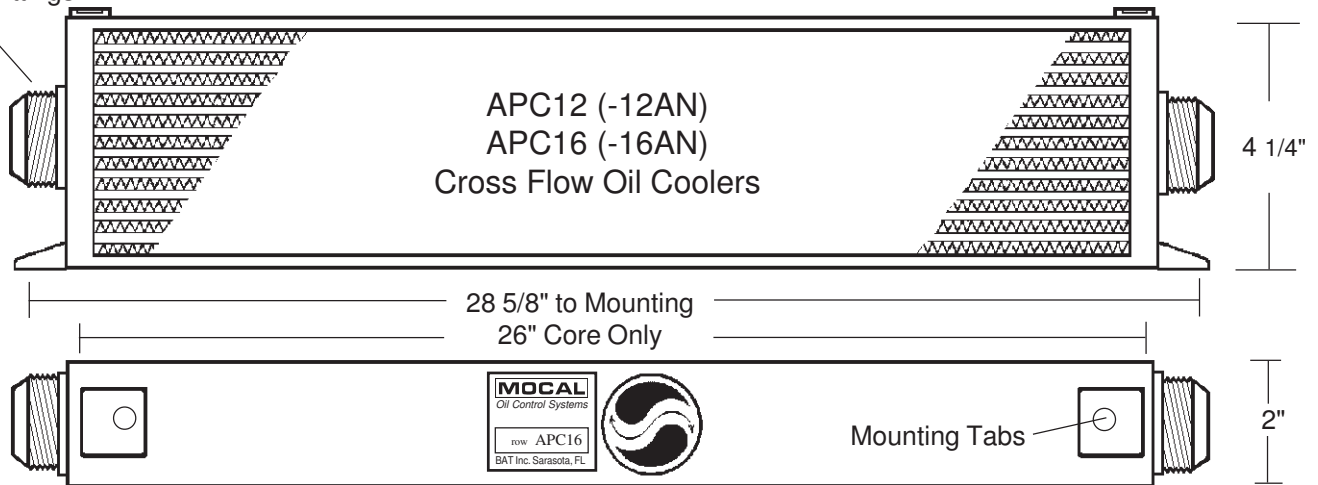

Another one of our popular front mount coolers is the APC12 or 16. These are quite similar in size to one of the "RUF" coolers, but with either AN-12 or -16 fittings rather than 30mm metric (for ease of plumbing here in the states) and will fit the "RUF" and other front spoilers. As with the PC10 series coolers the APC is a high efficiency cross flow design incorporating "oil turbulators". Unique double oil passages give the APC the highest performance rating for its size.

Cross Flow Oil Cooler -12AN APC12 \$742.50
Cross Flow Oil Cooler -16AN APC16 \$742.50

BAT inc. 7630 Matoaka Road. Sarasota, FL 34243 ♦ phone (941) 355-0005 ♦ fax (941) 355-4683



OIL COOLING ACCESSORIES

Electric Fans

Using an electric fan can be helpful to increase air flow through a cooler mounted in a poor air flow location. We have 3 sizes (5.5", 6.5" and 7.5" diameter) in pusher and puller models available. They can be easily mounted to Mocal and most other oil cooling devices. These electric fans are especially good for applications in very warm climates and or heavy traffic commuting. Add a fan on the A/C condenser for better HVAC performance too. *(specify push or pull blade when ordering)*

5.25" Electric Fan (6 x 4")	A5FAN	\$79.50
6.5" Electric Fan (7 x 2")	A6FAN	\$95.50
7.5" Electric Fan (8 x 2")	A7FAN	\$92.50

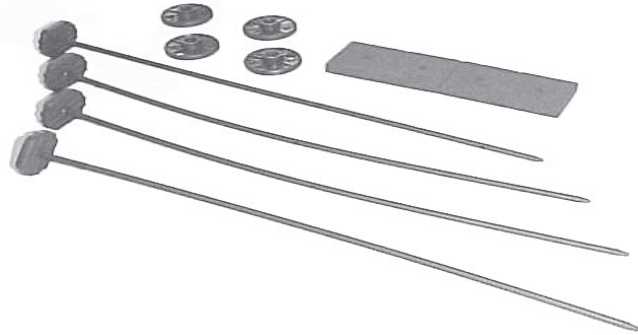
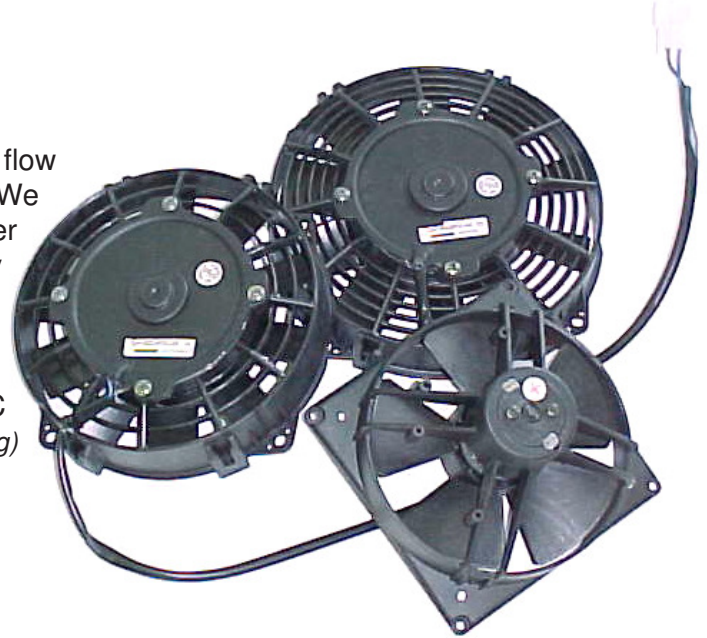

Electric Fan Mounting Kit

Nylon "zip tie" mounting kit includes four heavy duty tie mounts with protective foam pads for easy installation. Simply push ties through cooler core "fins", align with fan mounting holes, zip locks in place.

Fan Mounting Kit	ABKT1	\$16.45
------------------	-------	---------

Electric Fan Wiring Kit w/Adjustable Thermo

This kit includes all necessary components for electric fan installation: adjustable thermal switch (160f - 210f degree) pre-wired sensor relay module, insulated wire & connectors, in-line fuse block w/30 amp fuse, power taps and wiring schematic/instructions.

Fan Wiring Kit	AFTR1	\$105.00
----------------	-------	----------

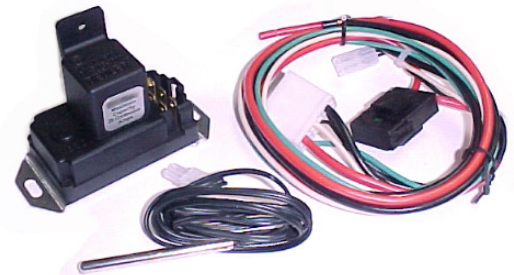

Stainless Braided Brake Hoses

BAT competition brake hoses incorporate a stainless braid exterior over a teflon interior to keep line expansion "flexing" to a minimum. This greatly reduces the "spongy" pedal feel common with standard rubber brake hoses. Our stainless lines are assembled from genuine Aeroquip AN-3 hose with premium (DOT approved) swage ends installed. All hoses include O.E. strut mount bushings and any required "bumpers" for a proper secure fit; we feel this is a very important feature - definitely not a situation where a zip-tie will do. We have a list of applications for most Porsche models and can do custom specification lines with a supplied sample or drawing.

Call with application for price.

BAT inc. 7630 Matoaka Road. Sarasota, FL 34243 ♦ phone (941) 355-0005 ♦ fax (941) 355-4683



Electric Fans

Using a small electric fan to increase air flow through an oil cooler - or other cooling device mounted in a poor air flow situation - is especially helpful. For these special applications we can supply a number of small fans ranging from 4 to 7.5 inches in diameter.

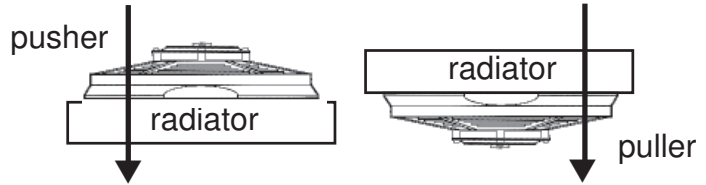

Fans blades are designed in either pusher and puller blade configurations for maximum performance. This is a very important feature because as-much-as 25% of a fans efficiency is lost when the blade is turning opposite it's designed rotation, (i.e. using a pusher fan to pull).

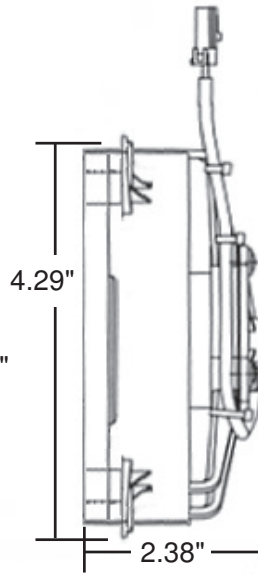
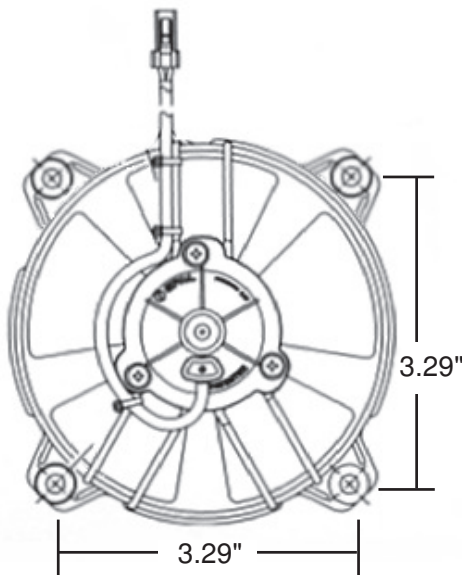

4" Electric Fan

max airflow 147cfm (pull)
125cfm (push)

electrical 12 volt
1.9 - 2.5 amp

part# pull fan A4FAN-PL
push fan A4FAN-PU
\$75.50

5.2" Electric Fan

max airflow 312 cfm (pull)
312 cfm (push)

electrical 12 volt
1.9 - 3.0 amp

part# pull fan A52FAN-PL
push fan A52FAN-PU
\$79.50

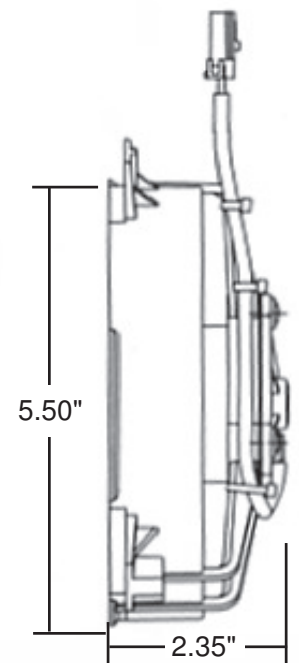
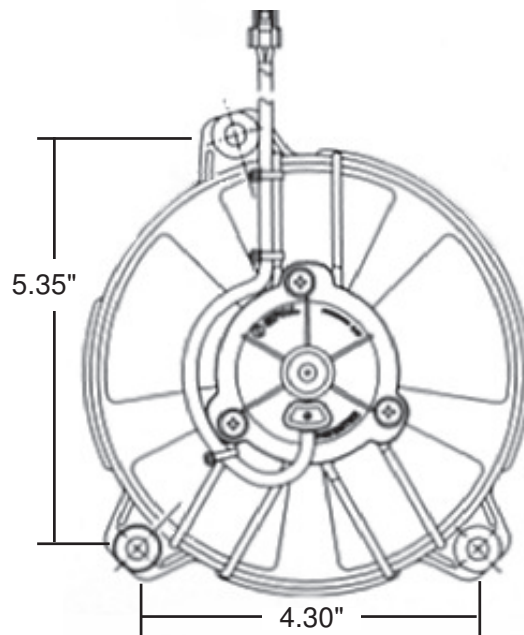

MOCAL USA

MOCAL USA



Oil Cooling components for:
PORSCHE 914-4

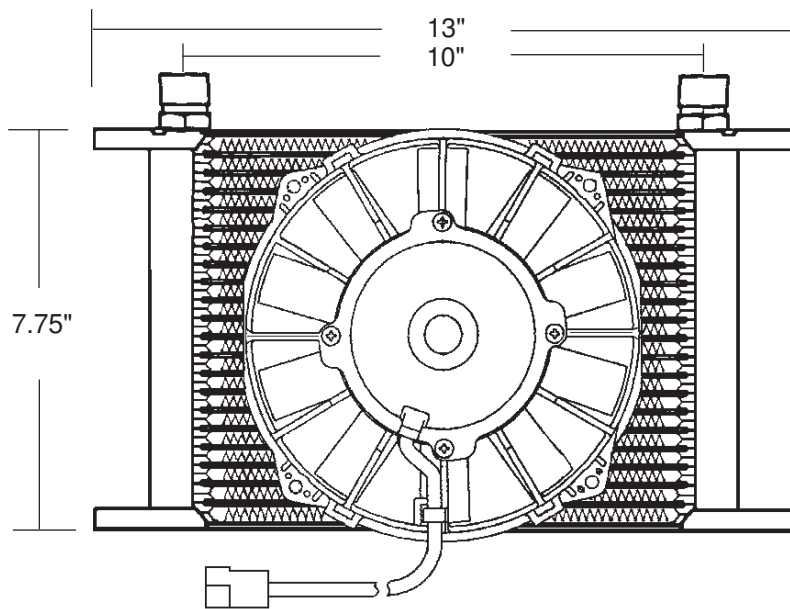

Mocal 25 Row Oil Cooler
w/ 6.5 inch Cool-Pac Fan

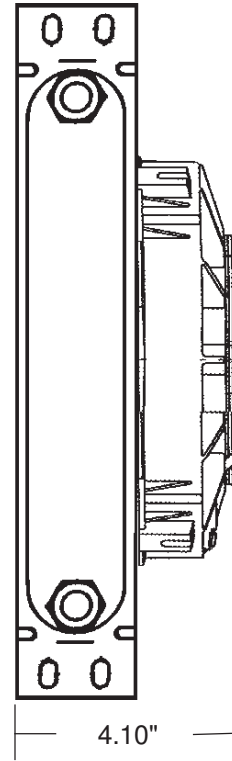

MOCAL USA

MOCAL USA



Mocal SP1 or SP1T*
Sandwich Plate 3/4"-16 Thread
* SP1T has built in thermostat



The Mocal oil cooling kit for the Porsche 914-4 consists of a 25 row -10AN oil cooler & 6.5" cooling fan with with a SP1T thermostatic sandwich plate and -10AN AQP stainless hose and fittings. The cooler is mounted to the underside of the engine grille, the plastic rain pan can be removed or a hole the size of the cooler can be made in the center. The SP1T thermo. sandwich plate mounts between the oil filter and the filter mount allowing oil flow to the cooler after 180 degrees. We supply enough AQP stainless oil hose and aircraft fittings to link the sandwich plate to the oil cooler.

Complete Kit Price	\$575.00
Non thermo kit	\$425.00
Thermo kit less Fan	\$490.00
Basic Kit (no fan, no thermo plate)	\$450.00



Oil Cooling components for:
**PORSCHE 924/944/
 968**

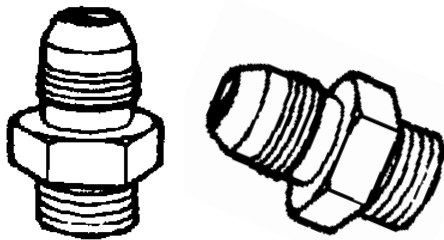
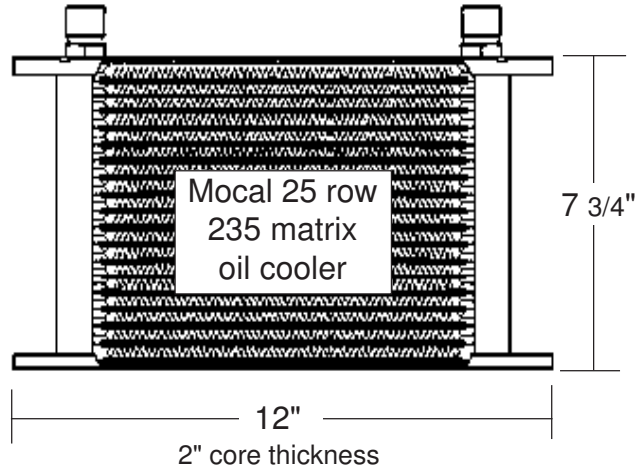
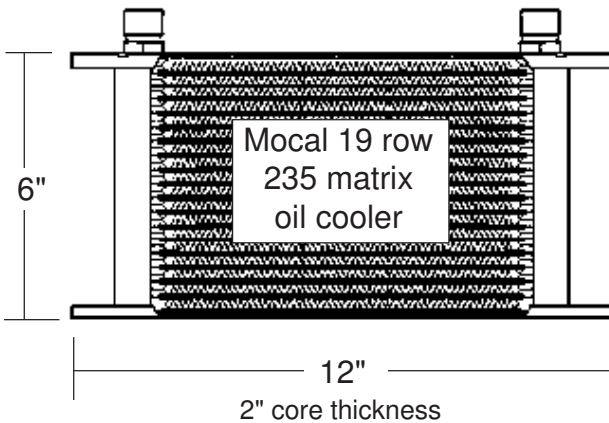

Metric fittings (22mm x -10AN or 22mm x -12AN) thread directly into filter housings on some models.

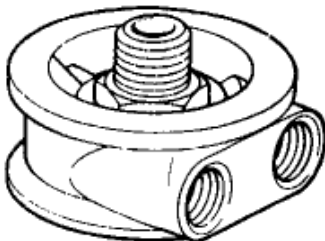

Mocal SP1 or SP1T*
 Sandwich Plate 3/4"-16 or 20mm Thread
 fits 924 or 944 between filter & block
 1/2" thread take-off for either
 1/2 x -10AN or 1/2" x -12AN fittings
 * SP1T has built in thermostat

Plumbing the **924** or **944** for oil cooling is fairly straight forward. On non turbo applications a thermostatic sandwich plate installs between the oil filter and engine block allowing oil take-off. Aeroquip hose and fittings are then used for the plumbing run to the cooler and back. We usually plumb these applications with -10AN (5/8" line size). A 16, 19, or 25 row Mocal cooler is installed in the front of the vehicle in a appropriate area. 944 turbo cars that have factory oil coolers can be upgraded to either a 19 or 25 row Mocal cooler in -10AN or -12AN line sizes. We supply the special metric fittings for the factory filter hosing to convert to -10AN or -12AN which will allow for easy plumbing with typical AN type hose and fittings. We can also supply the required installation components for plumbing Accusump oil accumulators on 924 and 944, 944 turbo cars. Call for oil cooling kit options and pricing.

For **944S2** and **968** we can rebuild or refit factory oil hoses. These unique hoses incorporate bolt-on manifolds at both the engine and cooler connections. A popular option is for us to refit the engine manifold with new hoses (length optional). On the cooler side we fit new -AN hose ends (size and angle optional). This conversion will allow connection to any aftermarket oil cooler. Call for quote.

MOCAL USA

MOCAL USA



Transmission/Differential Cooling



Transmission, differential, transaxle coolers can be added to most Porsche models. Some 911 versions have provision for cooling and a mechanical pump, but more likely an electric pump is used to handle the circulation duties. We have a number of pump options in the \$185.00 - \$399.00 range. All are purpose built positive displacement pumps specifically designed for the rigors of motor racing. For coolers we have a wide range of sizes and shapes of traditional Mocal & Setrab air to oil coolers. Some cooler sizes can be fitted with a fan or cooling duct for additional air flow when mounted in poor airflow locations. Another option for water cooled cars would be to use a water to oil cooler which we have several sizes to choose from. When using a pump for circulation in cooling systems it is important to add filtration to protect the pump from debris which can damage or cause pump failure. Small bits of gear and other metal tend to wear off and is more common than you might think.

Oil filter housings in -6 (3/8"), -8 (1/2") and -10 (5/8") in either 240 and 100 micron are available. For plumbing we stock a wide range of -AN hose fittings and adaptors to handle any plumbing task. We also supply the more uncommon items like metric x -AN adaptors, plugs, bushings and banjo fittings. We have a wealth of experience in the plumbing/cooling field and look forward to assisting you in any related project no matter how big or small.

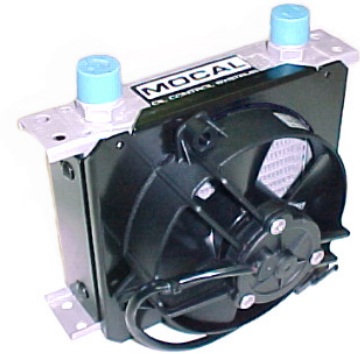



Metric Hose Fittings to AQP Hose Ends & Adaptors



BAT Inc. offers a comprehensive line of Metric to -AN hose ends and adaptors. Aluminum hose ends attach easily to popular -AN braided hose and fit directly to common metric sizes found on many European & Asian automobiles. Plumbing aftermarket oil and fuel components or replacing/modifying O.E. factory hoses has never been easier. **BAT** can also supply adaptors to convert from Metric to -AN for use with commonly available -AN hose and fittings products.

STRAIGHT HOSE END

- M12x1.5 X -4AN
- M12x1.5 X -6AN
- M14x1.5 X -6AN
- M16x1.5 X -6AN
- M16x1.5 X -8AN
- M18x1.5 X -8AN
- M18x1.5 X -10AN
- M22x1.5 X -10AN
- M26x1.5 X -12AN
- M30x1.5 X -12AN
- M30x1.5 X -16AN



45 DEGREE HOSE END

- M12x1.5 X -4AN
- M12x1.5 X -6AN
- M14x1.5 X -6AN
- M16x1.5 X -6AN
- M16x1.5 X -8AN
- M18x1.5 X -8AN
- M18x1.5 X -10AN
- M22x1.5 X -10AN
- M26x1.5 X -12AN
- M30x1.5 X -12AN
- M30x1.5 X -16AN



90 DEGREE HOSE END

- M12x1.5 X -4AN
- M12x1.5 X -6AN
- M14x1.5 X -6AN
- M16x1.5 X -6AN
- M16x1.5 X -8AN
- M18x1.5 X -8AN
- M18x1.5 X -10AN
- M22x1.5 X -10AN
- M26x1.5 X -12AN
- M30x1.5 X -12AN
- M30x1.5 X -16AN



MOCAL USA

MOCAL USA



Metric to -AN Union/Adaptors

Male Metric x Male AN (union) threads into female metric ports (usually in place of metric x metric union) converting to male -AN so that -AN hose end can be attached. Also for joining a female metric hose end to a female -AN hose end (possibly where one metric hose terminates and needs to be extended to a AN threaded device).

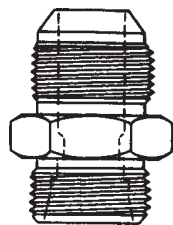

male x male

Female Metric x Male AN (adaptor) threads over male metric fittings converting them to male -AN which will allow connection with a -AN female hose end.

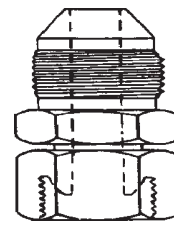

female x male

MALE -AN X MALE METRIC (UNION) ALLOY

-3AN	X	M10x1.0 convex
-3AN	X	M10x1.25 convex
-3AN	X	M12x1.0 convex
-3AN	X	M12x1.5 convex
-4AN	X	M10x1.0 convex
-4AN	X	M12x1.0 convex
-4AN	X	M12x1.5 convex
-4AN	X	M12x1.5
-4AN	X	M14x1.5
-4AN	X	M16x1.5
-4AN	X	M18x1.5
-6AN	X	M10x1.0 flat
-6AN	X	M12x1.0
-6AN	X	M12x1.25
-6AN	X	M12x1.5 flat
-6AN	X	M14x1.5
-6AN	X	M16x1.5
-6AN	X	M18x1.5
-8AN	X	M14x1.5
-8AN	X	M16x1.5
-8AN	X	M18x1.5
-8AN	X	M22x1.5
-10AN	X	M16x1.5
-10AN	X	M18x1.5
-10AN	X	M20x1.5
-10AN	X	M22x1.5
-12AN	X	M16x1.5 flat
-12AN	X	M18x1.5
-12AN	X	M20x1.5
-12AN	X	M22x1.5
-12AN	X	M24x1.5
-12AN	X	M26x1.5
-12AN	X	M28x1.5
-12AN	X	M30x1.5
-16AN	X	M22x1.5
-16AN	X	M26x1.5
-16AN	X	M30x1.5

MALE -AN X MALE METRIC (UNION) STEEL

-3AN	X	M10x1.0 convex
-3AN	X	M10x1.25 convex
-4AN	X	M10x1.0 convex
-4AN	X	M12x1.0 convex
-6AN	X	M10x1.0
-6AN	X	M12x1.5
-6AN	X	M14x1.5
-6AN	X	M16x1.5
-6AN	X	M18x1.5
-6AN	X	M20x1.5
-8AN	X	M14x1.5
-8AN	X	M 16x1.5
-8AN	X	M 18x1.5
-10AN	X	M16x1.5
-10AN	X	M18x1.5
-16AN	X	M 26x1.5

FEMALE METRIC to MALE -AN

M14x1.5	X	-6AN
M16x1.5	X	-6AN
M16x1.5	X	-8AN
M18x1.5	X	-8AN
M22x1.5	X	-10AN
M26x1.5	X	-12AN
M30x1.5	X	-12AN
M30x1.5	X	-16AN



Metric Swage Fittings & Components



Fitting shown with FBN rubber hose



Fitting shown with AHL lightweight hose

As an option to plumbing 911 type cars with aftermarket plumbing (hose & fittings) we can also provide more traditional O.E. looking "swage" or "crimp-on" type plumbing. This type of plumbing is becoming quite popular again, especially with the values of early 911's being what they are, and the desire for originality. We offer this type of plumbing as bulk components or assembled to your specifications. When purchasing bulk components be advised special equipment and knowledge of assembly is required.

Recommended hose with this type of hose fitting is either Eaton Aeroquip FBN-12 (3/4") rubber or AHL-12 (3/4") Lightweight AHL series hose. For the -16 (1") size we offer AHL-16 Lightweight AHL series hose.

Metric Crimp-on Hose Ends

26MM x 1.5 for 3/4" I.D. hose

M26 Straight for 3/4" hose	SW2612-00	\$29.95
M26 45° Degree for 3/4" hose	SW2612-45	\$39.50
M26 90° Degree for 3/4" hose	S W2612-90	\$39.50

30MM x 1.5 for 3/4" I.D. Hose

M30 Straight for 3/4" hose	SW3012-00	\$26.25
M30 45° Degree for 3/4" hose	SW3012-45	\$45.50
M30 90° Degree for 3/4" hose	SW3012-90	\$45.50

30MM x 1.5 for 1" I.D. Hose

M30 Straight for 1" hose	SW3016-00	\$26.25
M30 45° Degree for 1" hose	SW3016-45	\$56.25
M30 90° Degree for 1" hose	S W3016-90	\$56.25



Crimp Ferrules

28MM for 3/4" Hose	FER-M28	\$4.50
30MM for 1" Hose	FER-M30	\$4.95

Hose

3/4" I.D. Rubber	FBN-12	\$6.45 foot
3/4" I.D. Lightweight	AHL-12	\$9.65 foot
1" I.D. Lightweight	AHL-16	\$12.65 foot



O.E. Type Oil Cooler & Tank

911/930 Carrera Type Front Oil Cooler

A quality reproduction of the front fender radiator type auxiliary front oil cooler (core 13" x 7" x 2") used on various 911/930 models world wide 1984-1989. Factory part # 930 207 053 02. Cooler has provisions for mounting O.E. cooler fan, sensor switch, gravel guard and standard brackets/mounting. This cooler can also be used for updating earlier inefficient trombone type coolers on cars with factory M30 size plumbing/fittings. When retrofitting, factory mounting brackets and hoses are available as a Porsche parts kit # 10 0201 053.



Oil Cooler APC911 N/A

Porsche 911 Oil Tank - New

With the cost of early 911 parts soaring, used beat-up oil tanks are fetching over 1,000. Fortunately we can now provide quality, direct fit, reproductions of the early 911 (1965-1971) oil tanks. Tanks have standard mounting and fluid connections (M26 size). There are also provisions for oil level sensor, check your application as some really early 911's do not have oil level sensor. Supplied as bare tank, you will need to reuse your filter console, oil level sensor and drain plug. Factory # 911.107.001.16

Oil Tank APT911 \$459.00



MOCAL USA

MOCAL USA



Fuel Tank Quick Fill Flange

Quick Fill Flange for Porsche 991 Cup & Cayman GT4 CS

This quick fill flange takes the place of the standard equipment flush aviation fuel cap and flange found on Porsche 991 Cup and Cayman GT4 CS fuel tanks. Simply swap out the cap and flange for this quick fill version that accepts ATL and generic "red" bottle valves. Made by the same manufacturer/supplier to Porsche as the standard cap and flange which assures proper fit. Specifications: 101.6mm (4") PCD / 8 hole mounting 61.5mm (2.25") single connection. Gasket and hardware is included.

Porsche Fuel Tank Flange RF-AA-009 \$379.00

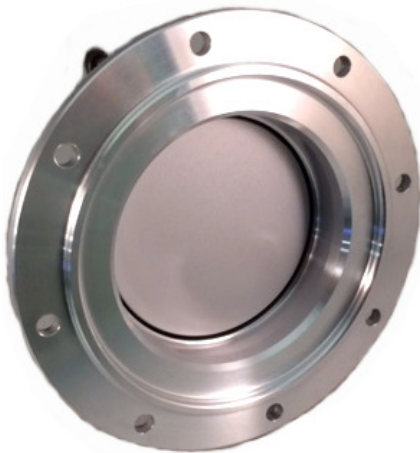

TOP VIEW

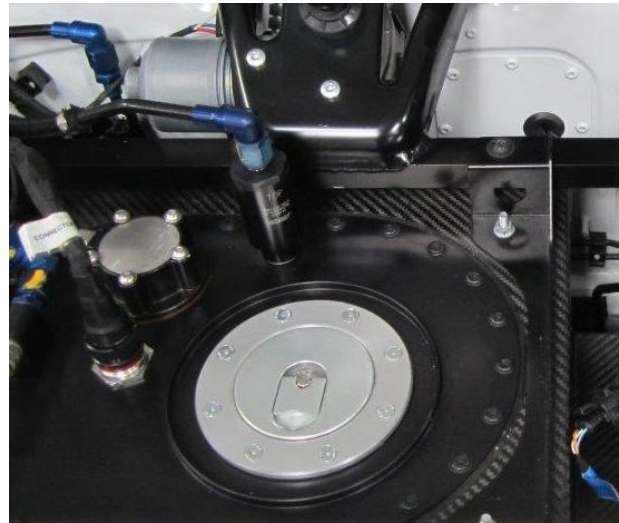
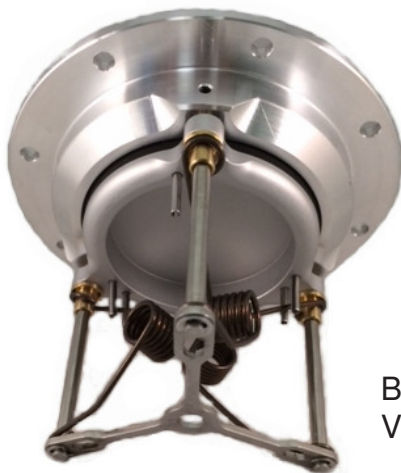

Photo of stock tank with Aviation type fuel cap and flange.



BOTTOM VIEW



SIDE VIEW

MOCAL USA

MOCAL USA

We have prepared this fitting identification guide to help in the selection of metric adaptors for plumbing 6 cylinder Porsche applications. As a rule cars built before 1970 use the smaller 26mm fitting sizes and cars later than 1974 use the larger 30mm type throughout. Cars built in the 1970 to 1974 range have been known to use either 26mm or 30mm or a bit of both sizes, making it is very important to make these visual inspections and take measurements. This would also apply to any car that has been involved in an engine swap or one with an unknown history.

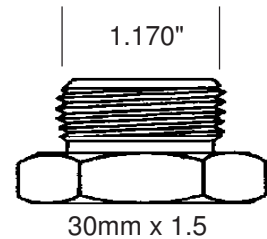
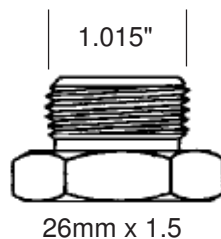

For cars that were not factory oil cooling equipped, plumbing begins at the oil line that originally connected the oil pump to the tank and is one of a few different types described below. An all rubber "textile" hose (example 1) was used on pre 1970 cars, later cars changed to a metal tube running from the pump and under the flywheel with a flexible bit of rubber "textile" hose on the end connecting to the tank. On cars (1974 and up) the rubber hose section can be un-threaded from the steel line and the oil tank location (example 3). Cars built between 1970-73 the rubber section of hose is sometimes swagged permanently on the end of the metal tube running from the pump (example 2). Sorting out this engine pipe is the most complex part of the whole system. Once that is done the rest of the system should take shape, running forward through the thermostat and cooler finishing up back at the oil tank which will also be converted to a AN metric adaptor (see diagram A).

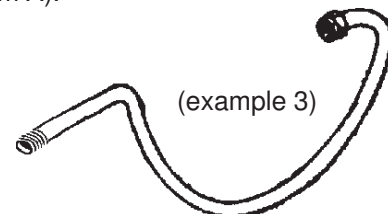
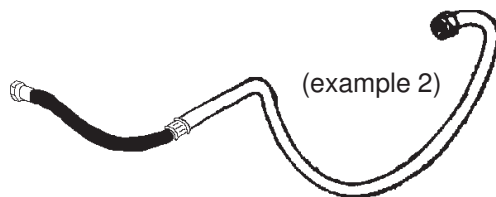
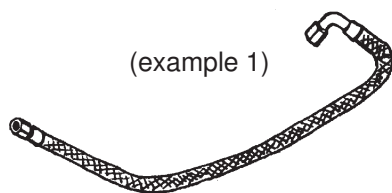

An all rubber "textile" hose (example 1) was used on pre 1970 cars. A 26mm male x -12AN male union is fitted to the end of the factory hose, then the hose is routed forward towards the location of the new oil thermostat. *An option to eliminate the original rubber hose is to back out the 22/26mm fitting from the engine case and replace it with a 22mm x -12AN male/male union.* Plumbing can now begin from either the redirected rubber hose or oil pump output with stainless -12AN hose and fittings to the thermostat (from engine) port.

On cars built between 1970-73 the rubber section of hose might be permanently "swagged" on the end of the metal tube running from the pump. In this case a 26 or 30mm male x -12AN male union is fitted to the end of the factory hose (depending on metric thread size), then the hose is routed forward towards the location of the new oil thermostat. If your oil pipe is threaded (as diagram 3) remove the rubber hose and fit the required 26 or 30mm female metric x male -12AN adaptor. Plumbing can now begin from either the redirected rubber hose or oil pipe with stainless -12AN hose and fittings to the thermostat (from engine) port.

The oil pipe used on 1974 and later cars is the larger 30mm thread size- with removable rubber hose section. Simply un-thread the rubber hose from the pipe and fit a 30mm female x -12AN male adaptor. Plumbing can now begin from the oil pipe with stainless -12AN hose and fittings to the thermostat (from engine) port. *On full race, turbo or high output engines a 30mm female x -16AN male adaptor can be fitted allowing the rest of the system to be plumbed in the larger -16AN hose and fitting size.*

The oil tank is the final destination and last hose connection of the completed oil system. Oil tanks will be either 26 or 30mm metric and will require the proper female metric x male AN adaptor. 911's later than 1974 will use the larger 30mm size, anything earlier should be 26mm- check thread size to be sure.

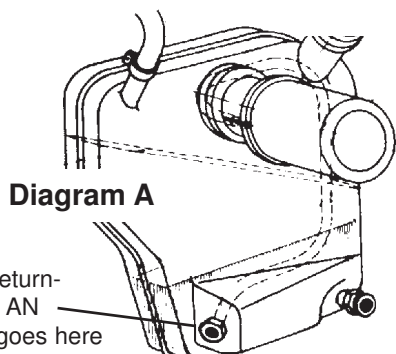

Factory 914-6 tanks are usually 26mm- any aftermarket oil tank should be checked for thread size, some are already in AN thread size. *30mm female x -16AN male fittings are available for systems being plumbed in the larger hose and fitting size.*

Male Metric x Male AN (union) threads into female metric ports (usually in place of metric x metric union) converting to male -AN so that -AN hose end can be attached. Also for joining a female metric hose end to a female -AN hose end (possibly where one metric hose terminates and needs to be extended to a AN threaded device).

Metric to -AN Union/Adaptors

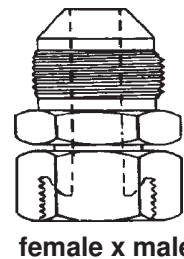
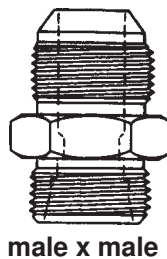

Female Metric x Male AN (adaptor) threads over male metric fittings converting them to male -AN which will allow connection with a -AN female hose end.



Imported & Distributed By:



British American Transfer Inc.
7630 Matoaka Rd.
Sarasota, FL. 34243
(941) 355-0005
fax (941) 355-4683