



PROMODAY 2026

ITALIA € IVA ESCLUSA





PROMODAY 2026

FASANOTOOLS.COM

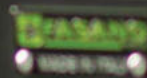



02	—	CHIAVI DI MANOVRA
06	—	CHIAVI A BUSSOLA
12	—	GIRAVITI E PINZE
16	—	ELETTRONICA ED ELETTROTECNICA
18	—	UTENSILI DINAMOMETRICI
20	—	UTENSILI DA TAGLIO
22	—	MANUTENZIONE GENERALE
28	—	ILLUMINAZIONE
36	—	POWER TOOLS
42	—	ESTRATTORI
44	—	UTENSILI PNEUMATICI
52	—	CARRELLI E BANCHI DA LAVORO
92	—	ARREDAMENTO TECNICO
106	—	ARREDAMENTO FURGONI
110	—	AUTOMOTIVE
132	—	PROFESSIONAL EQUIPMENT



CHIAVI DI MANOVRA



INDUSTRIAL

FG 600/A

CHIAVE COMBINATA

DESIGN DELLA TESTA OTTIMIZZATO
Per garantire un'elevata forza torcente

ELEVATE PRESTAZIONI
Raggiunge valori di coppia superiori del doppio rispetto agli standard

TESTA POLIGONALE DISASSATA
Inclinata di 15° per accedere a dadi e bulloni incassati rispetto alla superficie di lavoro e per proteggere la mano dell'utilizzatore



15°

FG 600A/SC16

€/LISTINO
~~245,00~~

PROMO
149,00€

SET CHIAVI COMBINATE POLIGONALI - SERIE INDUSTRIAL
Contenuto: 6, 7, 8, 10, 12, 13, 14, 16, 17, 19, 21, 22, 24, 27, 30, 32mm

FG 600A/SC25

€/LISTINO
~~405,00~~

PROMO
229,00€

SET CHIAVI COMBINATE POLIGONALI - SERIE INDUSTRIAL
Contenuto: 6, 7, 8, 9, 10, 11, 12, 13, 14, 15, 16, 17, 18, 19, 20, 21, 22, 23, 24, 25, 26, 27, 28, 30, 32mm



FG 600/SC16

€/LISTINO
~~232,00~~

PROMO
139,00€

SET CHIAVI COMBINATE POLIGONALI
Contenuto: 6, 7, 8, 10, 12, 13, 14, 16, 17, 19, 21, 22, 24, 27, 30, 32mm

FG 600/SC25

€/LISTINO
~~385,00~~

PROMO
219,00€

SET CHIAVI COMBINATE POLIGONALI
Contenuto: 6, 7, 8, 9, 10, 11, 12, 13, 14, 15, 16, 17, 18, 19, 20, 21, 22, 23, 24, 25, 26, 27, 28, 30, 32mm



FG 600L/SC10

€/LISTINO
~~162,00~~

PROMO
99,00€

SET CHIAVI COMBINATE POLIGONALI EXTRA LUNGHE
Contenuto: 10, 11, 12, 13, 14, 15, 16, 17, 18, 19mm



**CHIAVE
COMBINATA
TWISTER**

La chiave **TWISTER** Fasano Tools ha un design unico e innovativo: la rotazione sul manico fa sì che la forchetta e la testa poligonale siano perpendicolari tra loro, affinché l'utilizzatore impugni la chiave dal lato piatto avendo a disposizione una superficie maggiore di appoggio.

Questo consente di aumentare la forza torcente di più del **30%** rispetto alle chiavi standard, riducendo notevolmente lo sforzo e l'affaticamento della mano durante l'uso.



FG 600/TW

**MAGGIORE
FORZA
TORCENTE**

FG 600TW/S12

€/LISTINO
~~198,00~~

**PROMO
119,00€**

SET CHIAVI COMBINATE TWISTER

Contenuto: 8, 9, 10, 11, 12, 13, 14, 15, 16, 17, 18, 19mm



FG 600XL/SC7

€/LISTINO
~~210,00~~

**PROMO
129,00€**

SET CHIAVI POLIGONALI DOPPIE EXTRA LUNGHE

Contenuto: 8x10, 12x14, 13x15, 16x18, 17x19, 21x23, 22x24mm



FG 615/SC8

€/LISTINO
~~116,00~~

**PROMO
69,00€**

SET CHIAVI POLIGONALI DOPPIE CURVE

Contenuto: 6x7, 8x9, 10x11, 12x13, 14x15, 16x17, 18x19, 20x22mm



FG 602/SC13

€/LISTINO
~~150,00~~

**PROMO
89,00€**

SET CHIAVI A DOPPIA FORCHETTA

Contenuto: 6x7, 8x9, 10x11, 12x13, 14x15, 16x17, 18x19, 20x22, 21x23, 24x26, 25x28, 27x29, 30x32mm



FG 180/SP9

€/LISTINO
~~216,00~~

**PROMO
129,00€**

SET CHIAVI PER RACCORDI TUBO

Contenuto: 8x10, 10x11, 11x13, 12x14, 17x19, 19x22, 24x27, 30x32mm



FG 600E/S4

€/LISTINO
~~56,00~~

**PROMO
33,90€**

SET 4 CHIAVI DOPPIE DIRITTE TORX

Contenuto: E6xE8, E10xE12, E14xE18, E20xE24





FG 623H/S6

€/LISTINO
~~120,00~~

PROMO
72,00€

SET CHIAVI A T MASCHIO ESAGONALI AD ASTA FISSA

Contenuto: 2,5, 3, 4, 5, 6, 8mm

FG 623H/S8

€/LISTINO
~~175,00~~

PROMO
105,00€

SET CHIAVI A T MASCHIO ESAGONALI AD ASTA FISSA

Contenuto: 2, 2,5, 3, 4, 5, 6, 8, 10mm

FG 623H/S14

€/LISTINO
~~345,00~~

PROMO
209,00€

SET CHIAVI A T MASCHIO ESAGONALI AD ASTA FISSA

Contenuto: 2, 2,5, 3, 3,5, 4, 4,5, 5, 6, 7, 8, 9, 10, 12, 14mm



INDUSTRIAL

CHIAVE A T MASCHIO AD ASTA FISSA



FG 623/H

PRESTAZIONI ED ERGONOMIA

La **Chiave maschio a T** Fasano Tools è stata progettata per raggiungere prestazioni elevate in termini di coppia. L'impugnatura fissa e lo speciale acciaio al Cromo Vanadio garantiscono un elevato livello di resistenza.

L'ergonomia è stata notevolmente migliorata grazie al nuovo design, mentre le estremità brunate (fino alla misura da 8 mm) garantiscono un'elevata resistenza e forza torcente.

ACCIAIO AL CROMO VANADIO

FG 621H/S8C

€/LISTINO
~~162,00~~

PROMO
99,00€

SET CHIAVI A T MASCHIO ESAGONALI AD ASTA SCORREVOLE

Contenuto: 2, 2,5, 3, 4, 5, 6, 8, 10mm



FG 618/S7B

€/LISTINO
~~265,00~~

PROMO
159,00€

SET CHIAVI A T SNODATE ESAGONALI

Contenuto: 7, 8, 10, 12, 13, 14, 17mm

FG 618/S7

€/LISTINO
~~293,00~~

PROMO
175,00€

SET CHIAVI A T SNODATE ESAGONALI

Contenuto: 8, 10, 11, 13, 14, 17, 19mm

FG 618/S10

€/LISTINO
~~418,00~~

PROMO
249,00€

SET CHIAVI A T SNODATE ESAGONALI

Contenuto: 8, 10, 11, 12, 13, 14, 15, 16, 17, 19mm

FG 621TX/S13

€/LISTINO
~~250,00~~

PROMO
149,00€

SET CHIAVI A T MASCHIO TORX CON ASTA SCORREVOLE

Contenuto: 6, 7, 8, 9, 10, 15, 20, 25, 27, 30, 40, 45, 50 TX



GIRATUBI MODELLO AMERICANO



CODICE	Ø GAS MAX	Ø MM MAX	L/MM	€/LISTINO	€/PROMO
FG 30/GA1.5	1"1/2	33	250	40,00	24,00
FG 30/GA2	2"	42	300	48,00	29,00
FG 30/GA2B	2"	48	350	56,00	34,00
FG 30/GA2.5	2"1/2	60	450	82,00	49,00
FG 30/GA3	3"	73	600	125,00	75,00
FG 30/GA5	5"	102	900	150,00	90,00
FG 30/GA6	6"	141	1200	240,00	145,00

GIRATUBI MODELLO SVEDESE CON GANASCE PARALLELE A 45°



CODICE	Ø GAS MAX	Ø MM MAX	L/MM	€/LISTINO	€/PROMO
FG 32/GP1	1"	41	300	32,00	19,00
FG 32/GP1.5	1"1/2	56	420	45,00	27,00
FG 32/GP2	2"	68	530	70,00	42,00

GIRATUBI MODELLO AMERICANO IN ALLUMINIO



CODICE	Ø GAS MAX	Ø MM MAX	L/MM	€/LISTINO	€/PROMO
FG 33/GA2	2"	48	350	60,00	36,00
FG 33/GA2.5	2"1/2	60	450	80,00	49,00
FG 33/GA3	3"	73	600	140,00	85,00
FG 33/GA5	5"	102	900	260,00	155,00
FG 33/GA6	6"	141	1200	310,00	189,00

GIRATUBI MODELLO LEGGERO



CODICE	Ø GAS MAX	Ø MM MAX	L/MM	€/LISTINO	€/PROMO
FG 34/GL1	1"	38	175	25,00	14,90
FG 34/GL1.5	1"1/2	50	225	30,00	18,00
FG 34/GL2	2"	57	260	35,00	21,00
FG 34/GL2.5	2"1/2	70	300	40,00	24,00
FG 34/GL3	3"	50	225	45,00	27,00

FG 605/ST11-B

€/LISTINO
~~238,00~~

PROMO
139,00€

SET CHIAVI A CRICCO REVERSIBILI

Contenuto: 8, 9, 10, 11, 12, 13, 14, 15, 16, 17, 19mm



ANELLO IN ACCIAIO INTEGRATO CHE CONSENTE LA TENUTA DEL BULLONE



LEVA DI INVERSIONE A FILO TESTA E CON LINGUETTA INCLINATA VERSO IL BASSO PER UN MAGGIORE SPAZIO DI MANOVRA

FG 606/SP9

€/LISTINO
~~140,00~~

PROMO
85,00€

SET CHIAVI COMBinate A CRICCO NON REVERSIBILI

Contenuto: 8, 10, 11, 12, 13, 14, 15, 17, 19mm



FG 610FL/SP9

€/LISTINO
~~252,00~~

PROMO
149,00€

SET CHIAVI COMBinate A CRICCO FLESSIBILI

Contenuto: 8, 10, 12, 13, 15, 16, 17, 18, 19mm



FG 622A/S2

€/LISTINO
~~80,00~~

PROMO
49,00€

SET 2 CHIAVI A CRICCO UNIVERSALE SERIE EXTRA-LUNGA

Contenuto: 21x22, 24x27 mm



FG 615A/S6

€/LISTINO
~~130,00~~

PROMO
79,00€

SET 6 CHIAVI DOPPIE CON CRICCO REVERSIBILE UNIVERSALE A 90 DENTI

Contenuto: 8x9, 10x11, 12x13, 14x15, 16x18, 17x19mm





CHIAVI A BUSSOLA



23 mm
DI INGOMBRO
TOTALE

NEW

FG 625/S15

€LISTINO

~~98,00~~

PROMO
59,00€

SET BUSSOLE E ACCESSORI

Con chiavi a bussola piatte e cricchetto

Fornito in box di ABS con modulo in gomma morbida

3/8"

CONTENUTO



L/mm 190



L/mm 75 - 3/8"



3/8"



8- 9- 10- 11- 12- 13- 14- 15- 16- 17- 18-19mm



BUSSOLE PIATTE

— QUALITÀ E PRATICITÀ D'USO

- Cricchetto con meccanismo a 72 denti ed impugnatura antiscivolo
- Inversione del senso di rotazione con una sola mano grazie all'apposita leva e meccanismo di aggancio/sgancio rapido degli accessori con sistema a scatto

— MASSIMA ACCESSIBILITÀ

Consente di raggiungere con il minimo sforzo anche i punti di difficile accesso grazie all'adattatore e alla prolunga in dotazione

Design ultra sottile della testa del cricchetto: solo 11 mm di spessore



FG 624/S25

€LISTINO

~~98,00~~

PROMO
49,00€

SET 25 UTENSILI - ATTACCO 1/4"

1/4"



CONTENUTO



FG 624/E

6,8,10,11,12,13mm



FG 624/CR14



FG 89/38PI1

1/4"x 1/4"



FG 85/25PH

1, 2, 3



FG 85/25PZ

1, 2, 3



FG 85/25F

4, 5, 6, 7



FG 85/25TX

10, 15, 20, 25, 27, 30, 40

FG 625/S110

€/LISTINO
~~488,00~~

PROMO
259,00€

SET 110 UTENSILI - ATTACCO 1/4" E 1/2"



CONTENUTO

	FG 625/A	8,9,10,11,12,13,14,15,16,17,18,19,20,21,22,23,24,25,26,27,30,32
	FG 624/E	4,5,6,7,8,9,10,11,12,13,14
	FG 624/CR14	
	FG 625/CR12	
	FG 625/SN12	
	FG 624/SN14	
	FG 625/ES12	
	FG 624/ES14	
	FG 624/GR14C	
	FG 625/PA	125, 250
	FG 624/PA	50, 100
	FG 89/38P11	1/4"x1/4"
	FG 85/25PH	1,2,3
	FG 85/25SL	3,4,4.5,5,5.5,6,6.5
	FG 85/25PZ	1,2,3
	FG 85/H	1.5,2,2.5,3,4,5,6
	FG 85/25T	9,10,15,20,25,27,30,40
	FG 88/60P12	

	FG 139/B	
	FG 48/L	
	FG 49	
	FG 600/B	8,10,11,12,13,14,15,17,19
	FG 22	3x75, 4x100, 5.5x100
	FG 22/PH	0x60, PH1x80, PH2x100
	FG 59/XT160	
	FG 63/XT160	
	FG 58/B240	
	FG 132/H500	
	FG 79/SP	
	FG 93/M24	
	FG 44/MT5	



FG 625/S27

€/LISTINO
~~196,00~~

PROMO
99,00€

SET 27 UTENSILI - ATTACCO 1/2"



CONTENUTO

	FG 625/A	8,9,10,11,12,13,14,15,16,17,18,19,20,21,22,23,24,25,26,27,30,32
	FG 625/CR12	
	FG 625/SN12	
	FG 625/ES12	
	FG 625/PA	125,250



CHIAVI A BUSSOLA



CONTENUTO

	FG 625/A	10,11,12,13,14,15,16,17,18,19,20,21,22,23,24,27,30,32
	FG 624/E	4,4.5,5.5,5.6,7,8,9,10,11,12,13,14
	FG 625L/A	14,15,17,19,22
	FG 624E/L	6,7,8,9,10,11,12,13
	FG 625/TX	10,11,12,14,16,18,20,24
	FG 624/TX	4,5,6,7,8
	FG 181/B	16,21
	FG 624/CR14	
	FG 625/CR12	

FG BEST 108

€/LISTINO

~~279,00~~

PROMO
139,00€

SET 108 UTENSILI - ATTACCO 1/4" E 1/2"



	FG 625/SN12	
	FG 624/SN14	
	FG 625/ES12	
	FG 624/ES14	
	FG 624/GR14	
	FG 625/PR	125
	FG 624/PR	50,100
	FG 87/AD	
	FG 139/D	1,5,2,2.5
	FG 147/	PH (1,2), PZ (1,2), SL (4, 5.5, 6.5), H (4,5.5,6.5), TX (10,15,20,25,30)
	FG 85/	PH (3,4), PZ (3,4), SL (8,10,12), H (7,8,10,12,14), TX (40,45,50,55,60)



CONTENUTO

	FG 625/A	10, 11, 12, 13, 14, 15, 16, 17, 18, 19, 20, 21, 22, 24, 27, 30, 32
	FG 624/E	4, 4.5, 5, 5.5, 6, 7, 8, 9, 10, 11, 12, 13, 14
	FG 624/B	10, 11, 12, 13, 14, 15, 16, 17, 18, 19
	FG 624/TX	
	FG 624B/TX	4, 5, 6, 7, 8, 10, 11, 12, 14, 16, 18, 20, 24
	FG 625/TX	
	FG 625L/A	16, 17, 18, 19, 22
	FG 624B/L	10, 11, 12, 13, 14, 15
	FG 624E/L	4, 5, 6, 7, 8, 9, 10
	FG 181/B	16, 21
	FG 181/A	18
	FG 87/AD	1/2"x5/16"
	FG 87/AD3	3/8"x5/16"
	FG 624/PR	50, 100
	FG 624B/PR	125
	FG 625/PR	125

FG BEST 171

€/LISTINO

~~409,00~~

PROMO
179,00€

SET 171 UTENSILI - ATTACCO 1/4", 3/8" E 1/2"



	FG 625/CR12	
	FG 624/CR38	
	FG 624/CR14	
	FG 624/GR14	
	FG 625/SN12	
	FG 624/SN38	
	FG 624/SN14	
	FG 625/ES12-B	
	FG 624/ES14	
	FG 139/D	1, 1.5, 2, 2.5, 3, 4, 5
	FG 147/	PH (0, 1, 2), PZ (0, 1, 2), SL (4, 5.5, 6.5, 7), H (3, 4, 5), TX (8, 9, 10, 15, 20, 25, 27, 30), RTX (8, 9, 10, 15, 20, 25, 27, 30)
	FG 87/25	PH (3, 4), PZ (3, 4), SL (8, 10, 12), H (7, 8, 10, 12, 14), TX (40, 45, 50, 55, 60, 70), RTX (40, 45, 50, 55, 60, 70)
	FG 85/25	M (5, 6, 8), T (5, 6, 7), TT7, RIBE (5, 6, 7, 8, 9), TS (10, 15, 20, 25, 27, 30, 40, 45)

NEW



**AMPIO ASSORTIMENTO,
SEMPRE IN ORDINE E A PORTATA DI MANO**

77 CHIAVI A BUSSOLA

6 DIVERSI PROFILI TORX NELLE MISURE PIÙ UTILIZZATE

3 DIVERSI ATTACCHI 1/4", 3/8", 1/2"

PER SVOLGERE DIVERSE LAVORAZIONI

ELEVATE PRESTAZIONI E DURATA NEL TEMPO:

utensili di elevata qualità, in acciaio al cromo vanadio

ORDINE E PRATICITÀ: forniti in comoda e robusta valigetta

con clip di chiusura in metallo ed indicazione della misura

e del profilo per ciascuna chiave,

per essere sempre ordinati e pronti all'uso.

FG 625TX/S77

€/LISTINO
~~295,00~~

**PROMO
179,00€**

SET 77 UTENSILI TORX E TORX PLUS
- ATTACCO 1/4", 3/8", 1/2"

3/8"

1/4"

1/2"

CONTENUTO

		TX	1/4": TX6, 8, 10, 15, 20, 25, 27, 30 3/8": TX40, 45, 47, 50, 55 1/2": TX60, 70
		TX CON FORO	1/4": T8H, 10, 15, 20, 25, 27, 30 3/8": T40H, 45, 50, 55 1/2": T60H
		TX ESTERNO	1/4": E4, 5, 6, 7, 8 3/8": E10, 12, 14, 16 1/2": E18, 20, 22, 24
		TX IP	1/4": 8IP, 10, 15, 20, 25, 27, 30 3/8": 40IP, 45, 50 1/2": 55IP, 60
		TX IPR	1/4": 8IPR, 10, 15, 20, 25, 27, 30 3/8": 40IPR, 45, 50 1/2": 55IPR, 60
		TX PLUS ESTERNO	1/4": EP4, 5, 6, 7, 8 3/8": EP10, 12, 14, 16 1/2": EP18, 20, 22, 24



FG 150TX/S32

€/LISTINO
~~201,00~~

**PROMO
119,00€**

SET 32 INSERTI A BUSSOLA CON
IMPRONTA TORX - ATTACCO 1/2"



CONTENUTO

	FG 150/TX	20 - 70
	FG 150L/TX	20 - 70
	FG 150XL/TX	40 - 70
	FG 150XXL/TX	40 - 70





CHIAVI A BUSSOLA



FG 150M/S26

€/LISTINO
~~185,50~~

PROMO
99,00€

SET 26 INSERTI A BUSSOLA CON IMPRONTA XZN - ATTACCO 1/2"



CONTENUTO

	FG 150/M	5 - 16
	FG 150L/M	5 - 16
	FG 150XL/M	5 - 14
	FG 150XXL/M	8 - 14



FG 150H/S30

€/LISTINO
~~185,00~~

PROMO
99,00€

SET 30 INSERTI A BUSSOLA CON IMPRONTA ESAGONALE - ATTACCO 1/2"



CONTENUTO

	FG 150/H	5 - 19
	FG 150L/H	5 - 13
	FG 150XL/H	5 - 14
	FG 150XXL/H	5 - 12



FG 629A/S15

€/LISTINO
~~639,00~~

PROMO
339,00€

SET 15 CHIAVI A BUSSOLA ESAGONALI - ATTACCO 3/4"



CONTENUTO

	FG 629/A	19,22,24,27,30,32,36,41,46,50,60mm
	FG 629/CR34	
	FG 629/SN34	
	FG 629/ES34	
	FG 629/PR200	



FG 629B/S15

€/LISTINO
~~639,00~~

PROMO
339,00€

SET 15 CHIAVI A BUSSOLA POLIGONALI - ATTACCO 3/4"



CONTENUTO

	FG 629/B	19,22,23,27,30,32,36,41,46,50,60mm
	FG 629/CR34	
	FG 629/SN34	
	FG 629/ES34	
	FG 629/PR200	

FG 152/RTXS10

€/LISTINO
~~170,00~~

PROMO
99,00€

SET 10 INSERTI A BUSSOLA RINFORZATI TORX - ATTACCO 1/2"
Contenuto:
RTX20, RTX25, RTX27, RTX30, RTX40, RTX45, RTX50, RTX55, RTX60, RTX70



FG 152RH/S9

€/LISTINO
~~129,00~~

PROMO
69,00€

SET 9 INSERTI A BUSSOLA RINFORZATI ESAGONALI - ATTACCO 1/2"
Contenuto:
RH5, RH6, RH7, RH8, RH10, RH12, RH14, RH17, RH19



FG 152RM/S9

€/LISTINO
~~130,00~~

PROMO
69,00€

SET 9 INSERTI A BUSSOLA RINFORZATI XZN - ATTACCO 1/2"
Contenuto:
RM5, RM6, RM8, RM9, RM10, RM12, RM14, RM16, RM18



**CHIAVE
A BUSSOLA
DA 1/2"
ESAGONALE
RINFORZATA**



EXTRA-PIATTA

FG 629C/S10

€/LISTINO
~~319,50~~

PROMO
179,00€

SET 10 CHIAVI A BUSSOLA ESAGONALI RINFORZATE
- ATTACCO 3/4"
Contenuto: 17,19,22,24,27,30,32,36,41,46mm



FG 630A/S14

€/LISTINO
~~896,50~~

PROMO
499,00€

SET 14 CHIAVI A BUSSOLA ESAGONALI RINFORZATE
- ATTACCO 1"
Contenuto: 24,27,30,32,33,34,36,38,41,46,50,55,60,65mm



FG 628/S6

€/LISTINO
~~98,00~~

PROMO
59,00€

SET 6 CHIAVI A BUSSOLA ESAGONALI RINFORZATE PIATTE
- ATTACCO 1/2"
Contenuto: 22,23,24,27,30,32mm



FG 628/S12

€/LISTINO
~~134,00~~

PROMO
79,00€

SET 12 CHIAVI A BUSSOLA ESAGONALI RINFORZATE PIATTE
- ATTACCO 1/2"
Contenuto: 10,11,12,13,14,15,16,17,18,19,20,21mm





GIRAVITI E PINZE



FG 22/S6

€/LISTINO
~~36,00~~

PROMO
21,90€

SET GIRAVITI PER VITI CON TESTA A INTAGLIO E A CROCE PHILLIPS

Contenuto: 3x75, 4x100, 5.5x100, PH0x60, PH1x80, PH2x100



FG 22/S8

€/LISTINO
~~48,00~~

PROMO
27,90€

SET GIRAVITI PER VITI CON TESTA A INTAGLIO E A CROCE PHILLIPS

Contenuto: 3x75, 4x100, 5.5x100, 6.5x30, PH0x60, PH1x80, PH2x100, PH2x30



FG 22/S8B

€/LISTINO
~~52,00~~

PROMO
31,90€

SET GIRAVITI PER VITI CON TESTA A INTAGLIO E A CROCE PHILLIPS

Contenuto: 2.5x75, 3.5x100, 4x100, 6.5x150, 8x150, PH0x60, PH1x80, PH2x150



FG 22/S12

€/LISTINO
~~90,00~~

PROMO
53,90€

SET GIRAVITI PER VITI CON TESTA A INTAGLIO E A CROCE PHILLIPS

Contenuto: 2.5x60, 3x75, 4x100, 5.5x150, 6.5x150, 8x150, 4x30, PH0x60, PH1x80, PH2x100, PH3x150, PH1x30



FG 22TX/S6

€/LISTINO
~~66,50~~

PROMO
39,90€

SET GIRAVITI PER VITI CON IMPRONTA TORX
Contenuto: TX10, TX15, TX20, TX25, TX27, TX30



FG 22FX/S10

€/LISTINO
~~147,00~~

PROMO
89,90€

SET GIRAVITI A BUSSOLA ESAGONALE CON ASTA FISSA
Contenuto: 5, 5.5, 6, 7, 8, 9, 10, 11, 12, 13 mm



FG 22RTX/S8

€/LISTINO
~~94,50~~

PROMO
49,90€

SET GIRAVITI PER VITI CON IMPRONTA TAMPER RESISTANT TORX
Contenuto: RTX10, RTX15, RTX20, RTX25, RTX27, RTX30, RTX40, RTX45



FG 139

€/LISTINO
~~32,00~~

PROMO
22,90€

SET 12 CHIAVI MASCHIO A L CON IMPRONTA ESAGONALE SFERICA - SERIE CORTA
Contenuto: 1.5, 2, 2.5, 3, 4, 4.5, 5, 5.5, 6, 7, 8, 10 mm



FG 139/B

€/LISTINO
~~16,50~~

PROMO
9,90€

SET 10 CHIAVI MASCHIO ESAGONALI A L - SERIE CORTA
Contenuto: 1.5, 2, 2.5, 3, 4, 5, 5.5, 6, 8, 10 mm



TESTA SFERICA



FG 139/L

€/LISTINO
~~41,50~~

PROMO
24,90€

SET 12 CHIAVI MASCHIO A L CON IMPRONTA ESAGONALE SFERICA - SERIE LUNGA
Contenuto: 1.5, 2, 2.5, 3, 4, 4.5, 5, 5.5, 6, 7, 8, 10 mm



FG 139/C

€/LISTINO
~~24,50~~

PROMO
14,90€

SET 10 CHIAVI MASCHIO ESAGONALI A L - SERIE LUNGA
Contenuto: 1.5, 2, 2.5, 3, 4, 5, 5.5, 6, 8, 10 mm



TESTA SFERICA



FG 142/S9

€/LISTINO
~~128,00~~

PROMO
76,90€

SET 9 CHIAVI MASCHIO CON IMPUGNATURA BI-MATERIALE E IMPRONTA ESAGONALE SFERICA
Contenuto: 2, 2.5, 3, 4, 5, 6, 7, 8, 10mm



FG 139/LM

€/LISTINO
~~56,00~~

PROMO
33,90€

SET 10 CHIAVI MASCHIO ESAGONALI A L
Contenuto: 1.5, 2, 2.5, 3, 4, 5, 6, 7, 8, 10 mm



ESTREMITÀ MAGNETICA



FG 138/BP

€/LISTINO

~~62,00~~

PROMO
36,90€

SET 9 CHIAVI MASCHIO TORX A L E TESTA SFERICA

Contenuto: TX8, 10, 15, 20, 25, 27, 30, 40, 50



TESTA SFERICA

FG 138/B

€/LISTINO

~~34,00~~

PROMO
19,90€

SET 10 CHIAVI MASCHIO A L CON IMPRONTA TORX

Contenuto: TX9, TX10, TX15, TX20, TX25, TX27, TX30, TX40, TX45, TX50 - SERIE CORTA



FG 138/M

€/LISTINO

~~62,00~~

PROMO
37,90€

SET 9 CHIAVI MASCHIO A L CON IMPRONTA TORX

Contenuto: TX10, TX15, TX20, TX25, TX27, TX30, TX40, TX45, TX50



ESTREMITÀ MAGNETICA

FG 138/C

€/LISTINO

~~37,00~~

PROMO
19,90€

SET 10 CHIAVI MASCHIO A L CON IMPRONTA TORX

Contenuto: TX9, TX10, TX15, TX20, TX25, TX27, TX30, TX40, TX45, TX50 - SERIE LUNGA



FG 138

€/LISTINO

~~55,00~~

PROMO
32,90€

SET 12 CHIAVI MASCHIO A L CON IMPRONTA TORX

Contenuto: TX7, 8, 9, 10, 15, 20, 25, 27, 30, 40, 45, 50



FG 88/25-S31

€/LISTINO

~~92,00~~

PROMO
59,00€

SET 30 INSERTI RINFORZATI DA 1/4" E PORTA INSERTI MAGNETICO

Contenuto: PH1, PH2, PH3 (x2);

PZ1, PZ2, PZ3;

SQ1, SQ2, SQ3;

T8, T9, T10, T15, T20, T25, T27, T30, T40;

H2, H3, H4, H5, H6, H8;

SL4, SL5.5, SL8

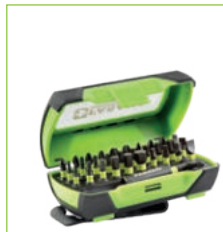

FG 143TX/S6

€/LISTINO

~~82,00~~

PROMO
49,90€

SET 6 CHIAVI MASCHIO TORX CON IMPUGNATURA BI-MATERIALE

Contenuto: TX10, TX15, TX20, TX25, TX30, TX40



FG 85/175-S9

€/LISTINO
~~92,00~~

PROMO
59,90€

SET 8 GIRAVITI BIVALENTI E 1 IMPUGNATURA DI MANOVRA

Contenuto: FG 85/175FPH0, PH1, PH2 (SL 4, 5.5, 6.5mm - PH 0, 1, 2)
- FG 85/175T6-8, T7-9, T10-15, T20-25, T30-40
- FG 85/IM



FG 85/175-S10

€/LISTINO
~~92,00~~

PROMO
59,90€

SET 9 GIRAVITI BIVALENTI E 1 IMPUGNATURA DI MANOVRA

Contenuto: FG 85/175FPH0, PH1, PH2 (SL 4, 5.5, 6.5mm - PH 0, 1, 2)
- FG 85/175PZ1-2 (PZ1-2) - FG 85/175H2.5, H3,H4,H5,H6
- FG 85/IM



FG 59XT/S3

€/LISTINO
~~89,50~~

PROMO
49,90€

SET 3 PINZE ASSORTITE INDUSTRIAL

Contenuto: FG 59/XT180, FG 63/XT160, FG 61/XT160

FG 59XT/S3B

€/LISTINO
~~99,50~~

PROMO
59,90€

SET 3 PINZE ASSORTITE INDUSTRIAL

Contenuto: FG 63/H180, FG 61/XT200, FG 59/XT180



FG 58/C250

€/LISTINO
~~40,00~~

PROMO
23,90€

PINZA REGOLABILE A CERNIERA CHIUSA CON SCORRIMENTO RAPIDO

mm - pollici: 250 - 10"
HRC: 54-58



INNOVATIVO SISTEMA DI SCORRIMENTO
SENZA PULSANTE CON MECCANISMO
AUTOBLOCCANTE, PER ADATTARSI
RAPIDAMENTE AI DIVERSI
DIAMETRI DEI TUBI



FG 51/S4

€/LISTINO
~~99,80~~

PROMO
56,90€

SET 4 PINZE PER ANELLI ELASTICI 10-25MM

Contenuto: FG 51/140, FG 52/140, FG 53/140, FG 54/140

FG 51/S4B

€/LISTINO
~~105,00~~

PROMO
62,90€

SET 4 PINZE PER ANELLI ELASTICI 19-60MM

Contenuto: FG 51/180, FG 52/180, FG 53/180, FG 54/180



FG 55/S4

€/LISTINO
~~140,00~~

PROMO
79,90€

SET 4 PINZE PER ANELLI ELASTICI CON INSERTI RINFORZATI IN ACCIAIO 10-25MM

Contenuto: FG 55/140, FG 56/140, FG 57/140, FG 58/140

FG 55/S4B

€/LISTINO
~~145,00~~

PROMO
84,90€

SET 4 PINZE PER ANELLI ELASTICI CON INSERTI RINFORZATI IN ACCIAIO 19-60MM

Contenuto: FG 55/180, FG 56/180, FG 57/180, FG 58/180



INSERTI RINFORZATI PER ANELLI DI GRANDE TENUTA



ELETTRONICA ED ELETTROTECNICA



FG 22E/S6

€LISTINO ~~60,00~~

PROMO 36,90€

SET 6 GIRAVITI ISOLATI

Contenuto: 3x100, 4x100, 5.5x125, PH0x60, PH1x80, PH2x100



FG 22E/SZ6

€LISTINO ~~60,00~~

PROMO 36,90€

SET 6 GIRAVITI ISOLATI

Contenuto: 3x100, 4x100, 5.5x125, PZ0x60, PZ1x80, PZ2x100



FG 68/SP

€LISTINO ~~36,00~~

PROMO 21,90€

PINZA TAGLIA E SPELLAFILI PER CAPICORDA ISOLATI

Ø/mm²: 0.2-6
AWG: 8-24
L/mm: 205



FG 68/SP2

€LISTINO ~~20,00~~

PROMO 11,90€

SPELLAFILI FRONTALE, DOTATA DI INCAVO SPELLAFILI

Ø/mm²: 0.2-6
AWG: 27-17
L/mm: 175



FG 68U/S439

€LISTINO ~~298,00~~

PROMO 179,00€

SET PINZA UNIVERSALE + 3 MATRICI (FG 68/MAT4, MAT16, MAG) CON ASSORTIMENTO 435 CAPICORDA ISOLATI



FG 59IS/S3

€LISTINO ~~125,00~~

PROMO 69,90€

SET 3 PINZE ASSORTITE CON MANICI ISOLATI

Contenuto: FG 59/IS180, FG 61/IS200, FG 63/IS160



FG 96/DG

€/LISTINO
~~200,00~~

PROMO
119,00€



MULTIMETRO DIGITALE DC/AC - OHM
Classe II
Categoria sovratensione: CAT III 300V
Test di continuità
Frequenza: 10Hz-200kHz
Prova diodi
Duty cycle 5%-95% RH ($\pm 0.1\%$)
Temperatura -20°C/400°C ($\pm 1.5\% \pm 3.0^\circ\text{C}$)
/ 400°C/1000°C ($\pm 2.0\% \pm 3.0^\circ\text{C}$)
Misurazione Lux 4.000 Lux (± 1) /
40.000 Lux (± 10)
Capacità rilevazione umidità 30%-90% RH
($\pm 0.1\%$)
Capacità di rilevazione suono 35 - 100dB
($\pm 0.1\text{dB}$)
Stand by dopo 15 minuti
Indicatore di livello batteria
Batteria da 9 V



DC	AC	Ω	LXPXH/MM
400mV-300V	4V-300V	400 Ω -40M Ω	165x80x35

FG 98/DG

€/LISTINO
~~350,00~~

PROMO
199,00€



MULTIMETRO DIGITALE
Classe II
Categoria sovratensione: CAT III 600V
Prova diodi
Test di continuità
Tecnologia NCV
Possibilità di memorizzare i dati
Display LCD
Luce led posta sul retro per illuminare
area di lavoro
Cover protettiva rimovibile in gomma
Auto spegnimento dopo 10 minuti di inutilizzo
Puntali in dotazione
Alimentazione: 1 batteria tipo AAA da 1.5V



DC	AC	Ω	LXPXH/MM
6V-1000V	6V-750V	600 Ω -60M Ω	184x90x46

FG 97/DG

€/LISTINO
~~140,00~~

PROMO
79,00€



MULTIMETRO DIGITALE SMART
Classe II
Categoria sovratensione: CAT IV 600V;
CAT III 1000V
Frequenza: 100 kHz
Frequenza di campionamento 3 volte
al secondo
Possibilità di memorizzare i dati
Display LCD
Prova diodi
Luce led per illuminare area di lavoro
Base di appoggio
Gancio di appendimento
Vano porta puntali sul retro
Auto spegnimento dopo 15 minuti di inutilizzo
Puntali e sonda in dotazione
Alimentazione: 1 batteria da 9V tipo 6F22



DC	AC	Ω	LXPXH/MM
600mV-600V	6V-600V	600 Ω -60M Ω	148x76x21

FG 99/DG

€/LISTINO
~~260,00~~

PROMO
149,00€



PINZA AMPEROMETRICA DIGITALE
Classe II
Categoria sovratensione: CAT III 600V
Frequenza di campionamento 3 volte al secondo
Prova diodi
Tecnologia NCV
Auto spegnimento dopo 15 minuti di inutilizzo
Luce led frontale per illuminare area di lavoro
Display LCD
Temperatura: -20°C ÷ 1000°C (-4°F ÷ 1832°F)
Frequenza: 10Hz; 100Hz; 1000Hz; 10kHz;
100kHz; 1000kHz; 10MHz
Custodia, puntali e sonda in dotazione
Alimentazione: 3 batterie da 1.5V TIPO AAA



DC	AC	Ω	LXPXH/MM
600mV-600V	6V-600V	600 Ω -60M Ω	194x59x29

**UTENSILI
DINAMOMETRICI**

CHIAVI DINAMOMETRICHE A DISINNESTO E ATTACCO QUADRO

 Precisione $\pm 4\%$

Fornite con verbale di taratura



CODICE	RISOLUZIONE NM	ATTACCO	NM	€/LISTINO	€/PROMO
FG 531	0.1	1/4"	5-25	215,00	129,00
FG 533/2	0.25	3/8"	10-50	240,00	145,00
FG 536/1	0.5	1/2"	20-100	240,00	145,00
FG 536/2	1.0	1/2"	40-200	250,00	149,00
FG 536/3	2.0	1/2"	60-340	275,00	169,00

**CHIAVE DINAMOMETRICA CON CRICCHETTO REVERSIBILE PER SERRAGGI
DESTORSI E SINISTRORSI**

 Precisione $\pm 4\%$ - Fornita in cassetta di ABS

Testa a cricchetto con rilascio rapido

Impugnatura ergonomica con anello di regolazione

Fornita con verbale di taratura



CODICE	RISOLUZIONE NM	ATTACCO	NM	€/LISTINO	€/PROMO
FG 540/1	2.5	3/4"	150-750	1.050,00	639,00
FG 540/2	2.5	3/4"	200-1000	1.200,00	729,00
FG 540/3	1.5	1"	200-1000	1.400,00	849,00

**BARRA DINAMOMETRICA A DISINNESTO PER SERRAGGI
DESTORSI E SINISTRORSI**

 Precisione $\pm 4\%$

Fornita con verbale di taratura

Fornita in cassetta di ABS



CODICE	NM	ATTACCO	€/LISTINO	€/PROMO
FG 538/1	140-560	3/4"	800,00	489,00
FG 538/2	200-800	3/4"	880,00	539,00
FG 539/1	200-1000	1"	1.150,00	699,00



CHIAVE DINAMOMETRICA DIGITALE PER NM E GRADI - 1/2"

Precisione di serraggio $\pm 4\%$
Destorsa e Sinistrorsa
Doppia manualità di misurazione: PICCO e TRACCIA
Indicatore sonoro e visivo a 12 led al raggiungimento della coppia prefissata
Possibilità di memorizzare fino a 250 differenti serraggi grazie al software PC incluso nel kit
Interfaccia PC tramite presa USB
Possibilità di impostare fino a 9 serraggi predefiniti
Alimentazione: 2 batterie 1.5V

1/2"

CE

CODICE	NM	€/LISTINO	€/PROMO
FG 543/DG1	6.8-135	650,00	399,00
FG 543/DG2	10-200	770,00	469,00



FG 546/DG

€/LISTINO
~~330,00~~

PROMO
199,00€

GONIOMETRO DIGITALE PER SERRAGGI IN COPPIA E ANGOLARI

Precisione di serraggio $\pm 2\%$
Destorso e Sinistrorso
Doppia modalità di misurazione: PICCO e TRACCIA
Indicatore sonoro e visivo a 6 led al raggiungimento della coppia prefissata
Possibilità di memorizzare fino a 50 differenti serraggi
Alimentazione: 2 batterie 1.5V

1/2"

CE



FG 547/DG

€/LISTINO
~~210,00~~

PROMO
129,00€

GONIOMETRO DIGITALE PER SERRAGGI ANGOLARI

Precisione di serraggio $\pm 2\%$
Destorso e Sinistrorso
Indicatore sonoro e visivo a 6 led al raggiungimento della coppia prefissata
Dotato di supporto magnetico posteriore

CE

CHIAVE DINAMOMETRICA A INNESTO FEMMINA

Precisione $\pm 4\%$
Fornita con verbale di taratura



CODICE	NM	RISOLUZIONE	■ X □	L/MM	€/LISTINO	€/PROMO
FG 544/1	5-25	0.1	9x12	259	195,00	119,00
FG 544/2	10-50	0.25	9x12	385	216,00	129,00
FG 544/3	20-100	0.5	9x12	385	232,00	139,00
FG 544/4	40-200	1.0	14x18	480	278,00	169,00



MOLTIPLICATORE DI COPPIA DESTORSO/SINISTRORSO

CODICE	■ X □	RAPPORTO	NM	Ø/MM	€/LISTINO	€/PROMO
FG 581/A	1/2" x 3/4"	1:6.5	231-1.500	80	860,00	529,00
FG 581/B	1/2" x 1"	1:12	208-2.500	80	1.320,00	799,00

**UTENSILI
DA TAGLIO**

FG 70/S110

 €LISTINO
~~335,00~~
**PROMO
199,00€**
SET 110 MASCHI E FILIERE IN ACCIAIO AL CROMO + ACCESSORI
 Passo grosso e fine filettatura metrica

						ACCESSORI
2x.04	6x0.75	12x1	2x0.4	6x0.75	12x1	GF25x9
3x0.5	7x0.75	12x1.25	3x0.5	7x0.75	12x1.25	GF8x14
4x0.7	8x0.75	12x1.5	4x0.7	8x0.75	12x1.5	GMM1.5
5x0.8	8x1	14x1	5x0.8	8x1	14x1	GMM3
6x1	9x0.75	14x1.25	6x1	9x0.75	14x1.25	GMC1
7x1	9x1	14x1.5	7x1	9x1	14x1.5	
8x1.25	10x0.75	16x1	8x1.25	10x0.75	16x1	
9x1.25	10x1	16x1.5	9x1.25	10x1	16x1.5	
10x1.5	10x1.25	18x1.5	10x1.5	10x1.25	18x1.5	
11x1.5	11x0.75		11x1.5	11x0.75		
12x1.75	11x1		12x1.75	11x1		
14x2	11x1.25		14x2	11x1.25		
16x2	12x0.75		16x2	12x0.75		

FG 81HSS/S3

 €LISTINO
~~260,00~~
**PROMO
159,00€**
SET 3 FRESE CONICHE IN ACCIAIO HSS
 4-12mm, 4-20mm, 4-30mm

FG 75CO/S25

 €LISTINO
~~245,00~~
**PROMO
149,00€**
SET PUNTE ELICOIDALI CILINDRICHE IN ACCIAIO HSS-COBALTO 5% RETTIFICATO
 Contenuto: 1-13x0.5mm

FG 49/L

€/LISTINO
~~18,00~~

PROMO
10,90€

FORBICI MULTIUSO A LAME LUNGHE IN ACCIAIO INOX

L/mm 200
Lama 87mm
Apertura max 151mm
HRC: 52-54



FG 48/B

€/LISTINO
~~23,00~~

PROMO
13,90

CUTTER A SERRAMANICO CON LAMA TRAPEZOIDALE

L/mm: 110-180
Fornito con 3 lame di ricambio



FG 48/C

€/LISTINO
~~9,60~~

PROMO
5,90

CUTTER PROFESSIONALE CON LAMA LUNGA

L/mm: 154

NEW



FG 48/P

€/LISTINO
~~14,50~~

PROMO
8,90

CUTTER PROFESSIONALE A STILO

L/mm: 142
Fornito con 3 lame di ricambio



FG 49/TC

€/LISTINO
~~44,00~~

PROMO
26,90€

FORBICI DA ELETTRICISTA DOTATE DI INCAVO SPELLAFILI

L/mm 140 - Lama 65mm
Lama microdentata in acciaio
HRC: 56
Struttura integrale in acciaio Inox
Tagliacavi 12mm
Con supporto per cintura



SUPPORTO PER CINTURA



STRUTTURA INTERAMENTE IN ACCIAIO FORGIATO

FG 49/TCX

€/LISTINO
~~58,50~~

PROMO
35,90€

FORBICI DA ELETTRICISTA DOTATE DI INCAVO SPELLAFILI

L/mm 160 - Lama 50mm
Lama microdentata in acciaio
HRC: 56
Struttura integrale in acciaio Inox
Tagliacavi 15mm
Con supporto per cintura



SUPPORTO PER CINTURA



STRUTTURA INTERAMENTE IN ACCIAIO FORGIATO

FG 49/CF

€/LISTINO
~~32,00~~

PROMO
17,90€

FORBICI DA ELETTRICISTA CON CRIMPATORE PER TERMINALI A TUBETTO

L/mm 155 - Lama 45mm
Lama in acciaio
HRC 52-54
Capacità tagliacavi 12mm
Dotate di incavo spellafili e crimpatore per terminali a tubetto



CRIMPATORE PER TERMINALI A TUBETTO

FG 77/PVC4

€/LISTINO
~~50,00~~

PROMO
29,90€

TRONCATUBI A CRICCO

Sistema a cremagliera con avanzamento progressivo
Dotata di piattaforma in nylon che facilita il taglio di profili piatti
Per tubi in PVC
Ømm: 0-42



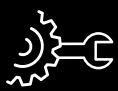

MANUTENZIONE GENERALE



FLESSOMETRO CON CASSA IN ABS ANTI-SHOCK E NASTRO IN ACCIAIO RIVESTITO IN NYLON
Classe II



CODICE	L/MT	BANDA MM	€/LISTINO	€/PROMO
FG 44/MT3	3	16	11,50	6,90€
FG 44/MT5	5	25	18,00	10,90€
FG 44/MT8	8	25	24,50	14,90€
FG 44/MT10	10	25	29,50	17,90€

FG 95/DG

€/LISTINO
~~96,00~~

PROMO
57,90€

CALIBRO A CORSOIO DIGITALE, LETTURA CINQUANTESIMALE
L/mm: 155



FG 95/CA

€/LISTINO
~~52,00~~

PROMO
29,90€

CALIBRO A CORSOIO, LETTURA CINQUANTESIMALE

Scala cromata
Asta sottile
Bloccaggio a vite
Inox temprato
L/mm: 150



FG 128/S11

€/LISTINO
~~122,00~~

PROMO
72,90€

SET 11 UTENSILI DA PERCUSSIONE CON IMPUGNATURA
Contenuto: FG 128/SC12, FG 128/SC16, FG 128/PU2, FG 128/PU10



FG 128C/S6

€/LISTINO
~~42,00~~

PROMO
28,90€

SET 6 CACCIASPINE
Misure: 2, 3, 4, 5, 6, 8mm



FG 47/S3

€/LISTINO

~~61,00~~

PROMO
36,90€

SET 3 RASCHIETTI A BATTERE CON LAMA IN ACCIAIO INOX
Lama in acciaio Inox
Impugnatura dotata di testa in acciaio per utilizzo a battere
Impugnatura in polipropilene con rivestimento in gomma anti-scivolo
Dotato di foro per appendimento



FG 125/S3

€/LISTINO

~~70,00~~

PROMO
39,90€

SET 3 LEVE A PERCUSSIONE
Contenuto: 300, 450, 600mm



FG 93/M50

€/LISTINO

~~31,00~~

PROMO
18,90€

SPECCHIETTO TELESCOPICO E ARTICOLATO IN ACCIAIO
Ø/mm specchietto 50
L/mm asta 240-698



FG 126/S3

€/LISTINO

~~35,00~~

PROMO
19,90€

SET 3 MINI LEVE CON ESTREMITÀ INCLINATA
L'angolo inclinato a 25° consente l'accesso anche nei punti più difficili
Estremità a battere sulla leva Ø/mm 6

NEW



FG 93/M95

€/LISTINO

~~31,00~~

PROMO
18,90€

SPECCHIETTO TELESCOPICO E ARTICOLATO IN ACCIAIO
Dimensioni specchietto mm 50x95
L/mm asta 370-775



FG 92/GR

€/LISTINO

~~28,00~~

PROMO
16,90€

PROLUNGA MAGNETICA FLESSIBILE
Capacità 1 Kg
L/mm 700
Dotata di griffe prensili

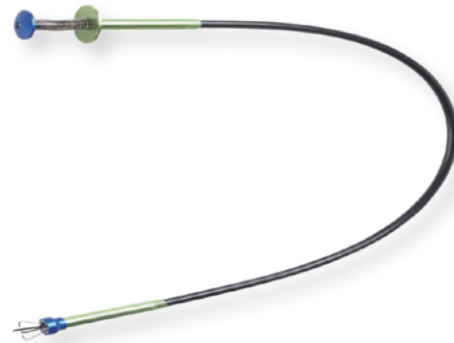

CON GRIFFE PRENSILI

FG 92/PM

€/LISTINO

~~21,00~~

PROMO
12,90€

PROLUNGA MAGNETICA FLESSIBILE
Impugnatura in gomma antiscivolo
Asta 1 metro
Ø/mm 3,9



FG 92/PF

€/LISTINO

~~27,50~~

PROMO
15,90€

PROLUNGA MAGNETICA ARTICOLATA
Capacità 3,5 kg
L/mm asta 400
Ø/mm 1,5
Punta magnetica



FG 92/PM4

€/LISTINO

~~27,50~~

PROMO
14,90€

PROLUNGA MAGNETICA TELESCOPICA
L/mm 165-622
Impugnatura in PVC antiscivolo
Capacità 2.3kg





FG 98/GAS

€/LISTINO
~~140,00~~

PROMO
85,00€

SALDATORE PORTATILE A GAS

Temperatura: 210-400 °C

25-80 Watt

Autonomia 120 minuti

Dotato di 4 beccucci per saldatura, taglio, fiamma, soffio

Fornito in box di ABS



FG 98/LT

€/LISTINO
~~188,00~~

PROMO
115,00€

SALDATORE PORTATILE CON BATTERIA AL LITIO

Temperatura max: 600 °C

Autonomia 40 minuti

Tempo di ricarica 3.5h

Fornito con punte per saldare, tagliare e soffiare

Fornito in box di ABS

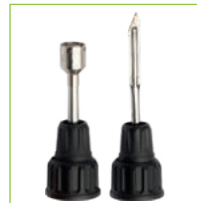

FG 96/SS36

€/LISTINO
~~65,00~~

PROMO
39,90€

SALDATORE A STILO A DOPPIA POTENZA

Classe di protezione I

30/60 Watt - 230V - Ø/mm 5.8



FG 494/S12

€/LISTINO
~~55,00~~

PROMO
32,90€

PISTOLA PER COLLA A CALDO

Potenza nominale di riscaldamento 80W

Temperatura di esercizio: 193°C (383 °F)

Tempo di riscaldamento: 3/5 minuti

Lunghezza stick colla: 200mm

Diametro stick colla: 11.5mm

Fornita in box di ABS con 12 stick colla inclusi



FG 493/AL

€/LISTINO
~~47,00~~

PROMO
28,90€

PISTOLA PER SIGILLANTE CON TUBO IN ALLUMINIO

L/mm 240

Dotata di sistema anti-goccia

Capacità 300cc



FG 493/N

€/LISTINO
~~39,00~~

PROMO
23,90€

PISTOLA PER SIGILLANTE CON TUBO IN ACCIAIO

Corpo principale e meccanismo interno interamente in acciaio

Capacità 300cc



FG 494/A180

€/LISTINO
~~175,00~~

PROMO
99,00€

PISTOLA PER COLLA A CALDO

Dotata di piede d'appoggio per evitare che la punta riscaldata tocchi la superficie del piano di lavoro

Potenza nominale di riscaldamento 180W

Temperatura di esercizio 193°C

Tempo di riscaldamento 3/5 minuti

L/mm stick colla 100/250/350

Stick colla Ø/mm 11/11,5

Fornita con 1 beccuccio di ricambio



FG 113/A

€/LISTINO
~~195,00~~

PROMO
119,00€

BAULE PORTA UTENSILI IN LAMIERA

Dotato di maniglioni laterali richiudibili
Predisposizione per lucchetto di chiusura
Struttura in lamiera d'acciaio 0.8mm
Dimensioni 520x290x290 mm



FG 113/B

€/LISTINO
~~210,00~~

PROMO
129,00€

BAULE PORTA UTENSILI IN LAMIERA

Dotato di maniglioni laterali richiudibili
Predisposizione per lucchetto di chiusura
Struttura in lamiera d'acciaio 0.8mm
Dimensioni 650x350x350 mm



FG 113/C

€/LISTINO
~~250,00~~

PROMO
149,00€

BAULE PORTA UTENSILI IN LAMIERA

Dotato di maniglioni laterali richiudibili
Predisposizione per lucchetto di chiusura
Struttura in lamiera d'acciaio 0.8mm
Dimensioni 850x350x350 mm



FG 113/D

€/LISTINO
~~325,00~~

PROMO
199,00€

BAULE PORTA UTENSILI IN LAMIERA

Dotato di maniglioni laterali richiudibili
Predisposizione per lucchetto di chiusura
Struttura in lamiera d'acciaio 0.8mm
Dimensioni 1000x400x450 mm



FG 111/AS104

€/LISTINO
~~863,50~~

PROMO
329,00€

CASSETTA PORTA-UTENSILI A 5 SCOMPARTI CON ASSORTIMENTO 104 UTENSILI



FG 111/A

€/LISTINO
~~62,00~~

PROMO
32,90€

CASSETTA PORTA-UTENSILI A 3 SCOMPARTI

Predisposizione per lucchetto
Divisorio scomparto superiore
Struttura in lamiera
Dimensioni 430x200x160 mm



CASSETTA PORTA-UTENSILI A 5 SCOMPARTI

Predisposizione per lucchetto
Divisorio scomparto superiore
Struttura in lamiera



CODICE	DIMENSIONI MM	€/LISTINO	€/PROMO
FG 111/B	430x200x200	75,00	39,90€
FG 111/C	530x200x200	94,00	49,90€

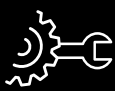

FG 1450

€/LISTINO
~~132,00~~

PROMO
79,90€

BORSA PORTA UTENSILI IN TESSUTO TECNICO 600D

Tessuto tecnico ad elevata resistenza
Base semi rigida con rialzi in plastica
Ampio vano centrale
Tasche multiple interne ed esterne
Tasca chiusa sul retro e doppia tasca chiusa frontale con passanti
Tracolla imbottita regolabile



BASE SEMIRIGIDA



TASCA CHIUSA SUL RETRO



FG 1456

€/LISTINO
~~230,00~~

PROMO
139,00€

TROLLEY PORTA UTENSILI IN TESSUTO TECNICO 600D

Tessuto tecnico ad elevata resistenza
Tasche interne ed esterne per un'ottimale organizzazione dello spazio
Struttura rigida con ampio scomparto interno per l'alloggiamento di utensili e accessori
Manico telescopico e 2 ruote resistenti per il facile trasporto
2 tasche esterne frontali chiuse



AMPIO SCOMPARTO INTERNO



TESSUTO TECNICO AD ELEVATA RESISTENZA



FG 1452

€/LISTINO
~~145,00~~

PROMO
85,90€

CESTELLO PORTA UTENSILI IN TESSUTO TECNICO 600D CON COVER

Struttura rigida in tessuto tecnico ad elevata resistenza
Base in plastica rigida per la protezione del contenuto
Ampio scomparto aperto per facile accesso al contenuto
Cover di chiusura con velcro a scomparsa
Maniglione in metallo con impugnatura in gomma morbida
Tasche multiple e passanti interni ed esterni
Tasca chiusa laterale e tasca porta seghetto frontale
Tracolla imbottita regolabile



TASCHE MULTIPLE



AMPIO SCOMPARTO CENTRALE APERTO



FG 1460

€/LISTINO
~~150,00~~

PROMO
89,00€

ZAINO PORTAUTENSILI IN TESSUTO TECNICO 600D

Tessuto tecnico ad elevata resistenza
Base in plastica rigida per la protezione del contenuto
Doppio vano interno, porta utensili e porta pc e documenti
Tasche multiple laterali e frontali, interne ed esterne
Schienale ergonomico imbottito
Spallacci imbottiti e cinturino pettorale regolabile



DOPPIO VANO INTERNO CON PORTA PC



SPALLACCI IMBOTTITI



FG 1454

€/LISTINO
~~188,00~~

PROMO
109,00€

BORSA PORTA UTENSILI IN TESSUTO TECNICO 600D

Struttura rigida in tessuto tecnico ad elevata resistenza
Base in plastica rigida per la protezione del contenuto
Due ampi scomparti separati
Tasche multiple e passanti interni ed esterni
Tasche chiuse sul retro e sul fronte
Comoda maniglia e tracolla imbottita regolabile



TASCHE MULTIPLE INTERNE



TASCA CHIUSA SUL RETRO



FG 1465

€/LISTINO
~~200,00~~

PROMO
119,00€

ZAINO PORTAUTENSILI IN TESSUTO TECNICO 600D CON RUOTE E SISTEMA TROLLEY

Tessuto tecnico ad elevata resistenza
Spallacci imbottiti e cinturino pettorale regolabile e richiudibile in apposita tasca
Doppio vano interno, porta utensili e porta pc e documenti
Tasche multiple laterali e frontali, interne ed esterne
Dimensioni bagaglio a mano
Manico telescopico a scomparsa
Ruote integrate con cover richiudibile
Schienale ergonomico imbottito



DIMENSIONI BAGAGLIO A MANO



DOPPIO VANO INTERNO



VALIGIA PORTAUTENSILI IN ABS

Maniglione a scomparsa per facilitarne il trasporto
Sistema di chiusura rinforzato
Porta etichette
Predisposizione per lucchetto di chiusura



IMPILABILI



PREDISPOSIZIONE PER LUCCHETTO DI CHIUSURA

CODICE	DIMENSIONI mm	€/LISTINO	€/PROMO
FG 1425	456x372x115	102,00	59,90
FG 1426	456x372x155	120,00	72,90
FG 1427	456x372x262	170,00	99,00

FG 1434

€/LISTINO
~~145,00~~

PROMO
89,00€

VALIGIA PORTAUTENSILI DOTATA DI BOX INTERNI IN ABS

Maniglione a scomparsa per facilitarne il trasporto
Sistema di chiusura rinforzato
Porta etichette
Predisposizione per lucchetto di chiusura
Dimensioni 456x372x115mm - Peso 3,2kg



FG 109/L3

€/LISTINO
~~280,00~~

PROMO
139,00

CARRELLO PORTA OGGETTI PIEGHEVOLE

Sistema di bloccaggio
Dimensioni: 945x485x810mm
Peso: 11kg
Portata 300kg



FG 1433

€/LISTINO
~~190,00~~

PROMO
99,00€

CARRELLO PIEGHEVOLE RICHIUDIBILE

Ruote Ø 180 mm
Struttura in ferro - base in alluminio
Peso 6kg - Portata 100kg



DIMENSIONI DA CHIUSO:
835x485x70mm



Base
480x350mm

FG 1445

€/LISTINO
~~45,00~~

PROMO
24,90€

BOX PORTAMINUTERIE DOTATO DI 8 CONTENITORI ASPORTABILI E DIVISORI REGOLABILI

Dimensioni mm 385x320x60



FG 1440

€/LISTINO
~~60,00~~

PROMO
29,90€

BOX PORTAMINUTERIE DOTATO DI 12 CONTENITORI ASPORTABILI

Dimensioni mm 400x400x70



ILLUMINAZIONE



FG 202

€/LISTINO
~~56,00~~

PROMO
33,90€

LAMPADA RICARICABILE A LED CON TSC SYSTEM

Led di puntamento superiore
TSC SYSTEM, tecnologia di spegnimento automatico al contatto con superfici
Corpo in alluminio anodizzato
Doppio magnete, sulla base e sul retro
Gancio per cintura
Cavo USB tipo C in dotazione
Dimensioni 46x115 mm

MAX 1200 LUMEN

3h T MAX 10h CE

115mm



GANCIO POSTERIORE PER CINTURA



LED DI PUNTAMENTO SUPERIORE



TECNOLOGIA DI SPEGNIMENTO PER CONTATTO

FG 204

€/LISTINO
~~32,50~~

PROMO
19,90€

MINI LAMPADA PORTATILE A LED

Gancio per cintura
Cavo USB tipo C in dotazione
Dimensioni 21x89 mm

MAX 300 LUMEN

89mm



CE 2.5h T MAX 3h



BASE MAGNETICA



DESIGN COMPATTO

FG 203

€/LISTINO
~~18,00~~

PROMO
9,90€

MINI FARETTO PORTATILE A LED

Dotato di magneti posteriori e doppia porta per ricarica
Incluso cavo di ricarica USB tipo C
Corpo in alluminio anodizzato
Funzione dimmer
Dimensioni: 28,4x32mm

MAX 100 LUMEN

CE MAX 3h 0.5h T



BASE MAGNETICA



DOPIA PORTA DI RICARICA TIPO C E MICRO USB

FG 214/L600

€/LISTINO
~~85,00~~

PROMO
42,90€

TORCIA RICARICABILE A LED

Cono luminoso regolabile
Indicatore stato di ricarica
In dotazione base di ricarica con supporto a parete e cavo USB
Dimensioni 135x31mm

MAX 600 LUMEN

CE MAX 15h 4h T



CONO LUMINOSO REGOLABILE



PIASTRA DI SUPPORTO A PARETE IN DOTAZIONE

FG 211

€/LISTINO
~~110,00~~

PROMO
59,90€

LAMPADA RICARICABILE A LED

Led di puntamento superiore
Regolatore di luminosità
Orientabile a 360°
Design sottile del corpo in polipropilene con inserti in gomma antiscivolo
5 livelli di indicazione dell'autonomia residua
Base magnetica con gancio estraibile e regolabile in 9 posizioni
Grado di resistenza ad acqua e polveri IP54
Caricabatterie in dotazione
H/mm 385



MAX 600 LUMEN



385mm



LED DI PUNTAMENTO SUPERIORE



ORIENTABILITÀ A 360°

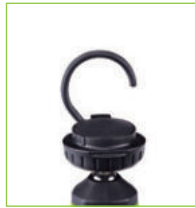

BASE MAGNETICA E GANCIO ESTRAIBILE

FG 207

€/LISTINO
~~65,00~~

PROMO
38,90€

LAMPADA RICARICABILE A LED

Led di puntamento superiore
Pivotante a 180°
Base magnetica
Indicatore stato di carica
Grado di resistenza ad acqua e polveri IP54
Cavo USB tipo C in dotazione
H/mm 300



MAX 300 LUMEN

CE

300mm

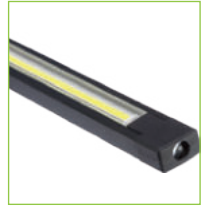

LED DI PUNTAMENTO SUPERIORE



GIREVOLE E PIVOTANTE A 180°

FG 212

€/LISTINO
~~78,00~~

PROMO
43,90€

LAMPADA RICARICABILE A LED

Led di puntamento superiore
Orientabile a 360°
Base magnetica
Grado di protezione IP20
Cavo USB tipo C in dotazione
H/mm 174



MAX 200 LUMEN

CE



174mm



LED DI PUNTAMENTO SUPERIORE



ORIENTABILITÀ A 360°

FG 207/B

€/LISTINO
~~98,00~~

PROMO
59,90€

LAMPADA RICARICABILE A LED

Led di puntamento superiore
Pivotante e girevole a 180°
3 livelli di indicazione dell'autonomia residua
Gancio estraibile integrato nella base
Grado di resistenza ad acqua e polveri IP54
Grado di resistenza agli urti IK07
Base magnetica
Cavo USB tipo C in dotazione
H/mm 400



MAX 700 LUMEN

CE

400mm



GIREVOLE FINO A 180°



PIVOTANTE FINO A 180°



SELETORE LUMINOSITÀ 60-700 LUMEN

FG 213/B

€/LISTINO
~~140,00~~

PROMO
79,00€

MAX 1000 LUMEN

MAX 10h 3h T



LAMPADA PORTATILE A LED WIRELESS

Doppio led sul fronte e sul retro da 600/300 lumen e led di puntamento superiore da 120 lumen
Modalità Full Lighting a tre led accesi per la massima illuminazione dell'ambiente di lavoro con 1000 lumen
Gancio estraibile girevole sulla base
Magnete sul retro e sulla base della lampada
Pivotante a 180°
3 led di indicazione dello stato di carica
Base di ricarica magnetica con cavo USB tipo C in dotazione
Dimensioni: 51.5x42.5x343 mm

NEW

343mm



BASE DI RICARICA A INDUZIONE



PIVOTANTE A 180°



MASSIMA LUMINOSITÀ 1000 LUMEN

FG 201

€/LISTINO
~~50,00~~

PROMO
29,90€

MAX 100 LUMEN

MAX 6h 2.5h T



TORCIA TELESCOPICA MAGNETICA RICARICABILE A LED

Asta telescopica allungabile fino a 505 mm
Led indicatore dello stato di carica sul pulsante ON/OFF
Gancio laterale
Cavo USB tipo C in dotazione
Dimensioni 21x18x178mm

178mm



FUNZIONE PICK-UP (1.2 KG DI CAPACITÀ DI CARICO DEL MAGNETE)



GANCIO PER CINTURA



ASTA TELESCOPICA (MAX 505mm)

FG 213/L480

€/LISTINO
~~65,00~~

PROMO
39,90€

MAX 500 LUMEN

2.5h MAX 10h

LAMPADA DA TESTA A DOPPIO LED

Con sensore on/off contactless
4 livelli di inclinazione
Indicatore stato di carica
4 magneti posteriori per utilizzo senza banda elastica
Batteria estraibile e possibilità di utilizzo con 3 batterie AAA
Cavo USB tipo C in dotazione
Dimensioni 68x39 mm



DOTATA DI 4 MAGNETI POSTERIORI PER L'UTILIZZO SENZA BANDA ELASTICA



4 LIVELLI DI INCLINAZIONE



SENSORE ON/OFF CONTACTLESS

FG 206

€/LISTINO
~~56,00~~

PROMO
33,90€

MAX 360 LUMEN

4.5h IP X4 MAX 3h



LAMPADA RICARICABILE A LED

Design slim
Magneti sul retro
Gancio per appendere la lampada
Grado di protezione IPX4
Cavo micro USB in dotazione
Dimensioni 10x249 mm

249mm



GANCIO SUPERIORE



EXTRA PIATTA

FG 205/C

€LISTINO
~~140,00~~

PROMO
69,00€

MAX 1000 LUMEN

LAMPADA RICARICABILE A LED

Led di puntamento superiore con luminosità da 60 lumen
2 ganci estraibili girevoli a 360° sul retro
2 magneti posteriori + 1 magnete posto sotto la base girevole
4 led di indicazione dello stato di carica
Cavo USB tipo C in dotazione
Funzione power bank (output max USB 5V 1A)
Funzione dimmer
Dimensioni 66x39x310

NEW

MAX 12h

4.5h

CE

310mm



1 BASE GIREVOLE A 180°



LED DI PUNTAMENTO SUPERIORE 60 LUMEN



2 GANCI ESTRAIBILI GIREVOLI A 360°

FG 217/B

€LISTINO
~~300,00~~

PROMO
179,00€

MAX 6000 LUMEN

LAMPADA RICARICABILE A 3 FARI LED DOTATA DI TREPPEDI

Utilizzabile anche collegata al caricabatteria con luminosità da 500 lm
Potente batteria al litio da 7.3V - 8000mAh
3 fari led pivotanti (180°) e rotanti (270°)
4 led di indicazione dello stato di carica
Funzione Power Bank 5V 1A
Base magnetica con gancio estraibile integrato
Altezza totale di 1700 mm (lampada inclusa)
Sacca in nylon in dotazione
Cavo USB tipo C in dotazione
Dimensioni 90x90x205

CE

MAX 8h

10h



3 MAGNETI SULLA BASE



FARI LED PIVOTANTI A 180° E ROTANTI A 270°

205mm



FG 205/B

€LISTINO
~~85,00~~

PROMO
49,90€

MAX 600 LUMEN

LAMPADA RICARICABILE A LED

Led di puntamento superiore con luminosità da 200 lumen
Gancio estraibile girevole posizionato sul retro
Base orientabile a 180° con magnete integrato
4 led di indicazione dello stato di carica
Cavo USB tipo C in dotazione
Dimensioni 54x32x186

CE

MAX 12h

3h

186mm



UN GANCIO ESTRAIBILE GIREVOLE A 360°



BASE MAGNETICA ORIENTABILE FINO A 180°

TREPPEDI TELESCOPICO FINO A 1,70 M



FG 210/C

€/LISTINO
~~165,00~~

PROMO
99,00€

FARETTO DA LAVORO RICARICABILE A LED

Funzione Power Bank (Output max USB 5V 2A)
Supporto orientabile a 180°
5 livelli di indicazione dell'autonomia residua
Grado di resistenza ad acqua e polveri IP65
Grado di resistenza agli urti IK07
Indice di resa cromatica CRI 70+
Cavo USB tipo C in dotazione
Dimensioni 208x140 mm

MAX 3000 LUMEN



SUPPORTO ORIENTABILE 180°



FUNZIONE POWER BANK

FG 222/A

€/LISTINO
~~80,00~~

PROMO
49,00€

LAMPADA RICARICABILE A LED CON CASSE WIRELESS

LED di puntamento superiore
Doppia cassa wireless da 5W
Gancio con magneti integrati, estraibile ed orientabile a 180°
per appendere o appoggiare la lampada
Grado di resistenza ad acqua e polveri IP54
Cavo USB tipo C in dotazione
Dimensioni 65x164 mm

MAX 500 LUMEN



LED DI PUNTAMENTO SUPERIORE DA 160 LUMEN



DOPPIA CASSA WIRELESS 5W



GANCIO ESTRAIBILE ED ORIENTABILE FINO A 180°

FG 210/W

€/LISTINO
~~70,00~~

PROMO
39,90€

FARETTO PORTATILE A LED

Faretto orientabile a 210° con magnete integrato
Luce spot 250 lumen
Ricaricabile in 2 modi:
- con cavo USB tipo C in dotazione in 4h;
- in modalità wireless in 6h
3 led di indicazione dello stato di carica
Dimensioni: 83x35x100 mm

MAX 670 LUMEN



BASE MAGNETICA



LUCE SPOT/LUCE SPOT DIFFUSA



FARETTO ORIENTABILE 210°



FG 222/B

€/LISTINO
~~290,00~~

PROMO
169,00€

FARO DA LAVORO RICARICABILE A LED CON CASSE WIRELESS

Doppia cassa wireless da 10W
Funzione Power Bank (Output max USB 5V 1A)
Corpo orientabile a 140°
5 livelli di indicazione dell'autonomia residua
Gancio estraibile e girevole integrato nella base
Grado di resistenza ad acqua e polveri IP65
Caricabatterie in dotazione
Dimensioni 210x210 mm



MAX 4000 LUMEN



GANCIO ESTRAIBILE E INTEGRATO



CASSE WIRELESS 10W



CORPO ORIENTABILE A 140°

FG 221

€/LISTINO
~~260,00~~

PROMO
159,00€

FARO DA LAVORO A DOPPIO CORPO ILLUMINANTE

Rotazione orizzontale di 180° per faro
Corpo orientabile a 90°
Batteria al litio estraibile da 14,8V con funzione Power Bank (Output max USB 5V 2A)
5 livelli di indicazione dell'autonomia residua
Caricabatteria in dotazione
Dimensioni 190x295 mm

MAX 4500 LUMEN



BATTERIA A LITIO CON FUNZIONE POWER BANK



BATTERIA ESTRAIBILE



CORPI ILLUMINANTI ORIENTABILI FINO A 180°

FG 224/L5200

€/LISTINO
~~210,00~~

PROMO
129,00€

FARO DA CANTIERE RICARICABILE A LED CON LENTE ANTIABBAGLIAMENTO

Speciale lente opaca che riduce l'effetto abbagliamento ed aumenta la diffusione della luce
Supporto orientabile a 180° ed agganciabile ai treppiedi
3 livelli di indicazione dell'autonomia residua
Grado di resistenza ad acqua e polveri IP65
Grado di resistenza agli urti IK07
Caricabatterie in dotazione
Dimensioni 273x205 mm



MAX 5200 LUMEN



MAX 15h
4h T



ORIENTABILE 180°

GRADO DI PROTEZIONE IP65

FG 224/SU

TREPPIEDI PER FARO DA CANTIERE FG 224/L5200
Altezza massima 1,60 M

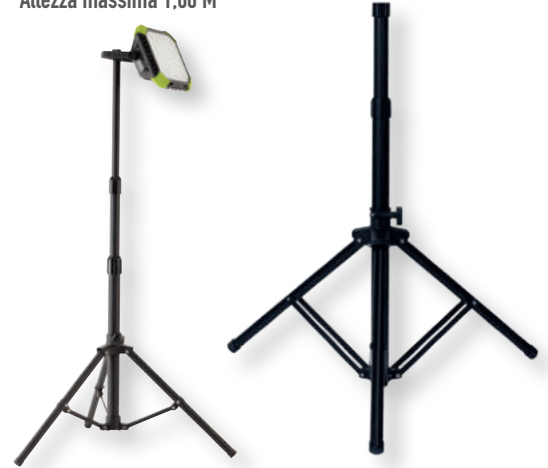

€/LISTINO
~~80,00~~

PROMO
49,00€

MAX 10h
4.5h T



MAX 1200 LUMEN

FG 209

€/LISTINO
~~265,00~~

PROMO
149,00€

LAMPADA SOTTOCOFANO RICARICABILE A LED CON LENTE TRASPARENTE E SEMITRASPARENTE

Lunghezza regolabile fino a 2150mm
4 livelli di indicazione dell'autonomia residua
3 tipologie di lente disponibili
Caricabatteria in dotazione
Ruotabile a 360°
Funzione dimmer



BRIGHT MODE (1200 LM)

COMFORTABLE MODE (1100 LM)

SOFT MODE (600 LM)



FG 210/B

€/LISTINO
~~70,00~~

PROMO
39,90€

LAMPADA A TUBO PORTATILE A LED

Dotata di luce spot superiore
Sistema di aggancio magnetico
Modalità luce rossa d'emergenza
Incluso cavo di ricarica USB tipo C
Funzione dimmer



486mm

6h T
MAX 15h



MAX 1200 LUMEN



LUCE SPOT 400 LUMEN

FUNZIONE POWER BANK

SISTEMA DI AGGANCIO MAGNETICO





LAMPADE PER CONTROLLO COLORE

SETTORE CARROZZERIA



FG 234

€/LISTINO
~~105,00~~

PROMO
59,00€

☀️ COB LED - cri 96+
3 COLORI
2700K 4500K 6500K

🔋 MAX 3h
🕒 3h
CE

LAMPADA DA TESTA LED AD ELEVATO INDICE DI RESA CROMATICA PER CONTROLLO COLORE

Alto indice di resa cromatica CRI 96+
3 opzioni di temperatura colore 2700K/4500K/ 6500K
Cavo USB in dotazione
Dimensioni 50x50 mm



SENSORE ON/OFF CONTACTLESS



4 LIVELLI DI INCLINAZIONE

MAX 160 LUMEN

FG 235

€/LISTINO
~~135,00~~

PROMO
79,00€

☀️ COB LED - cri 96+
3 COLORI
2700K 4500K 6500K

LAMPADA RICARICABILE A LED AD ELEVATO INDICE DI RESA CROMATICA PER CONTROLLO COLORE

Alto indice di resa cromatica CRI 96+
3 opzioni di temperatura colore 2700K/4500K/ 6500K
Grado di resistenza ad acqua e polveri IP65
Grado di resistenza agli urti IK07
Base di ricarica da tavolo con presa USB + cavo USB in dotazione
Dimensioni 50x190 mm



180°



190mm



BASE MAGNETICA + SUPER MAGNETE SUL RETRO



LENTE SOSTITUIBILE



GANCIO ESTRAIBILE

CE
🕒 4h
🔋 MAX 4h

MAX 500 LUMEN

FG 236

€/LISTINO
~~335,00~~

PROMO
199,00€

FARO RICARICABILE A LED AD ELEVATO INDICE DI RESA CROMATICA PER CONTROLLO COLORE

Alto indice di resa cromatica CRI 96+

5 opzioni di temperatura colore

2700K/3500K/4500K/5500K/6500K

Base pivotante a 180°

Funzione memoria sui parametri dell'ultimo utilizzo

Grado di resistenza ad acqua e polveri IP65

Grado di resistenza agli urti IK07

Accessorio treppiedi non incluso

Dimensioni 115x190 mm

190mm



PANNELLO DI CONTROLLO



CARICABATTERIE A SGANCIO RAPIDO CON CAVO DA 5 M



2700K 3500K 4500K 5500K 6500K



MAX 2000 LUMEN

FG 236/SU

€/LISTINO
~~100,00~~

PROMO
59,00€

TREPPIEDI PER FARO LED FG 236

Altezza 476 mm (chiuso) - 1440 mm (aperto)

Numero di estensioni dei piedi 3

Massimo carico 2 Kg

Peso netto: 1098 gr



476mm



1440mm

FG 225/SK1.5

€/LISTINO
~~300,00~~

PROMO
149,00€

AVVOLGICAVO AUTOMATICO 15M 3GX1.5MM² CON PRESA SCHUKO

Lunghezza cavo in ingresso 1,20 M

15m x 3G 1.5mm² 1000W

230V AC 2000W



LIMITATORE DI RIENTRO PER ARRESTARE LA CORSA



SISTEMA DI BLOCCAGGIO A QUALSIASI LUNGHEZZA



FG 225/SK2.5

€/LISTINO
~~370,00~~

PROMO
179,00€

AVVOLGICAVO AUTOMATICO 15M 3GX2.5MM² CON PRESA SCHUKO

Lunghezza cavo in ingresso 1,20 M

15m x 3G 2.5mm² 1600W

230V AC 3200W

STAFFA A MURO ORIENTABILE A 360°



POWER TOOLS

PRESTAZIONI
AFFIDABILITA'
QUALITA'



**BRUSHLESS
MOTOR**

PRESTAZIONI
PERFORMANCE

EFFICIENZA
EFFICIENCY

Scopri la gamma di elettroattrezzi Fasano Tools progettata per soddisfare le esigenze dell'utilizzatore professionale.

Due linee diverse, con batterie al litio rispettivamente con voltaggio 14,4V e 18V, sviluppate per ottimizzare le prestazioni degli utensili, che sfruttano tecnologie di ultima generazione, dotate di celle di elevata

qualità e di innovativi sistemi di gestione e protezione.

Gli utensili a batteria Fasano Tools hanno motore brushless (senza spazzole) e sono forniti in robusta valigetta con manico antiscivolo e clip in metallo, ideale per il pratico riponimento e trasporto degli utensili e della relativa dotazione.

GAMMA

14.4V

Li-ion
2Ah

MANEGGEVOLEZZA E VERSATILITÀ

La piattaforma 14,4V si compone di 7 modelli tutti compatibili con la stessa batteria 14,4V per un'elevata versatilità nelle diverse situazioni d'uso. Grazie al design compatto questi utensili consentono di lavorare con comodità e le loro prestazioni sono adeguate a portare a termine il lavoro nel minor tempo possibile.



GAMMA

18V

Li-ion
5Ah

MASSIME PRESTAZIONI

La piattaforma 18V comprende gli utensili che sono in grado di erogare le prestazioni più elevate per svolgere le applicazioni più gravose. La nuova smerigliatrice angolare da 125 mm a velocità variabile ed il nuovo avvitatore compatto da 1/4" completano la gamma 18V, ampliandone i campi di applicazione.



GAMMA

18V



FG 330/LT2

€/LISTINO
~~860,00~~

PROMO
399,00€

TRAPANO AVVITATORE CON PERCUSSIONE - 18V

Motore Brushless

Elevate prestazioni, fino a 135 Nm di coppia massima

Mandrino autoserrante da 13 mm in acciaio

11 posizioni di regolazione della coppia

Doppia velocità

Max percussione: 32000 bpm

Velocità a vuoto 0-550/2000 rpm

Max foratura legno/metallo/muratura: 89/13/16mm

Luce led per illuminare l'area di lavoro

Frizione elettronica

Sistema Anti Kick Back per il massimo controllo dell'utensile

Dotazione: 2 batterie al litio 18V - 5Ah, caricabatteria, gancio per cintura in metallo, impugnatura laterale, valigetta in ABS con clip di chiusura in metallo



DIMENSIONI



PRESTAZIONI ELEVATE IN OGNI APPLICAZIONE

18V CE

BRUSHLESS
MOTOR

LI-ION
BATTERY

135
Nm
MAX
TORQUE

FG 335/LT2

€/LISTINO
~~920,00~~

PROMO
439,00€

NEW

SMERIGLIATRICE ANGOLARE 125mm - 18V

Motore Brushless

Velocità regolabile in 5 posizioni tramite apposito selettore

Interruttore a slitta con blocco

Impugnatura laterale orientabile in due posizioni

Cuffia di protezione ad aggancio rapido

Griglie di protezione anti polvere

Dotazione: 2 batterie al litio 18V - 5Ah, caricabatteria, cuffia di protezione, impugnatura laterale, chiave di servizio, valigetta in ABS con clip di chiusura in metallo



DIMENSIONI



MANICO AUSILIARIO LATERALE



SELETTORE VELOCITÀ IN 5 POSIZIONI



18V CE

BRUSHLESS
MOTOR

LI-ION
BATTERY

8.000
MAX RPM



FG 305/LT2

€/LISTINO

~~850,00~~

PROMO

399,00€

AVVITATORE A IMPULSI COMPATTO ATTACCO 1/2" - 18V

Motore Brushless

470 Nm di coppia massima in avvitatura e 510 Nm in svitatura

4 modalità di funzionamento ad avvitare

Diametro bullone M10 - M16

Velocità a vuoto 0-2500 rpm

Funzione Tightening Control per il controllo del serraggio

Soft bolt removal mode, previene la caduta del bullone in svitatura

Design compatto

Triplo led per illuminare l'area di lavoro

Dotazione: 2 batterie al litio 18V - 5Ah, caricabatteria, gancio per cintura in metallo, valigetta in ABS con clip di chiusura in metallo



DIMENSIONI



TRIPLO LED

18V CE

1/2" BRUSHLESS MOTOR



510 Nm MAX TORQUE

FG 310/LT2

€/LISTINO

~~950,00~~

PROMO

469,00€

AVVITATORE A IMPULSI ATTACCO 1/2" - 18V

Motore Brushless

740 Nm di coppia massima in avvitatura e 880 Nm in svitatura

4 modalità di funzionamento ad avvitare

Diametro bullone M16 - M22

Velocità a vuoto 0-2200 rpm

Funzione Tightening Control per il controllo del serraggio

Soft bolt removal mode, previene la caduta del bullone in svitatura

Triplo led per illuminare l'area di lavoro

Dotazione: 2 batterie al litio 18V - 5Ah, caricabatteria, gancio per cintura in metallo, valigetta in ABS con clip di chiusura in metallo



DIMENSIONI



TRIPLO LED

18V CE

1/2" BRUSHLESS MOTOR



880 Nm MAX TORQUE

FG 315/LT2

€/LISTINO

~~1.050,00~~

PROMO

529,00€

AVVITATORE A IMPULSI AD ALTA COPPIA ATTACCO 1/2" - 18V

Motore Brushless

Elevate prestazioni, fino a 950 Nm di coppia massima in avvitatura e 1800 Nm in svitatura

4 modalità di funzionamento ad avvitare

Diametro bullone M12 - M32

Velocità a vuoto 0-1800 rpm

Funzione Tightening Control per il controllo del serraggio

Soft bolt removal mode, previene la caduta del bullone in svitatura

Triplo led per illuminare l'area di lavoro

Dotazione: 2 batterie al litio 18V - 5Ah, caricabatteria, gancio per cintura in metallo, valigetta in ABS con clip di chiusura in metallo



DIMENSIONI



TRIPLO LED

18V CE

1/2" BRUSHLESS MOTOR



1800 Nm MAX TORQUE

FG 320/LT2

€/LISTINO
~~1.100,00~~

PROMO
569,00€

AVVITATORE A IMPULSI AD ALTA COPPIA ATTACCO 3/4" - 18V

Motore Brushless
Elevate prestazioni, fino a 950 Nm di coppia massima in avvitatura e 1800 Nm in svitura
4 modalità di funzionamento ad avvitare
Diametro bullone M12 - M32
Velocità a vuoto 0-1750 rpm
Funzione Tightening Control per il controllo del serraggio
Soft bolt removal mode, previene la caduta del bullone in svitura
Tripla led per illuminare l'area di lavoro
Dotazione: 2 batterie al litio 18V - 5Ah, caricabatteria, gancio per cintura in metallo, valigetta in ABS con clip di chiusura in metallo



DIMENSIONI



TRIPLO LED

18V CE

3/4" BRUSHLESS MOTOR

LI-ION BATTERY

1800 Nm
MAX TORQUE

FG 325/LT2

€/LISTINO
~~860,00~~

PROMO
349,00€

NEW

AVVITATORE A IMPULSI COMPATTO ATTACCO 1/4" - 18V

Motore Brushless
Power control: 3 velocità + 2 modalità dedicate (legno e bulloni) per regolare le prestazioni in base alle applicazioni
Design compatto
Attacco esagonale femmina 1/4"
225 Nm di coppia massima
Diametro bullone standard M5 - M16
Velocità a vuoto 0-1900/2800/3600 rpm
Tripla led per illuminare l'area di lavoro
Dotazione: 2 batterie al litio 18V - 5Ah, caricabatteria, gancio per cintura in metallo, valigetta in ABS con clip di chiusura in metallo



DIMENSIONI



TRIPLO LED

18V CE

1/4" BRUSHLESS MOTOR

LI-ION BATTERY

225 Nm
MAX TORQUE



GAMMA AVVITATORI A IMPULSI 18V



FG 325/LT2

FG 305/LT2

FG 310/LT2

FG 315/LT2

FG 320/LT2

	FG 325/LT2	FG 305/LT2	FG 310/LT2	FG 315/LT2	FG 320/LT2
TECNOLOGIA MOTORE	Brushless	Brushless	Brushless	Brushless	Brushless
ATTACCO	Esagonale femmina 1/4"	Quadro maschio 1/2"	Quadro maschio 1/2"	Quadro maschio 1/2"	Quadro maschio 3/4"
BATTERIA	18V - 5Ah	18V - 5Ah	18V - 5Ah	18V - 5Ah	18V - 5Ah
COPPIA MAX AVVITATURA (NM)	225	470	740	950	950
COPPIA MAX SVITATURA (NM)	-	510	880	1800	1800
Ø BULLONE	M5-M16	M10-M16	M16-M22	M12-M32	M12-M32
VELOCITÀ A VUOTO (GIRI/MIN)	0-3600	0-2500	0-2200	0-1800	0-1750
PESO CON BATTERIA (GR)	1.600	1.890	2.360	3.450	3.560



GAMMA

14.4V



FG 360/LT1

€/LISTINO ~~495,00~~

PROMO 259,00€

CRICCHETTO 1/2" - 14,4V

Motore Brushless
Elevate prestazioni, fino a 95 Nm di coppia massima

Velocità a vuoto 300 Rpm

Testa sottile

Velocità variabile

Luce led per illuminare l'area di lavoro

Dotazione: 1 batteria al litio 14,4V - 2Ah, 1 caricabatteria, valigetta in ABS con clip di chiusura in metallo

14.4V CE

BRUSHLESS MOTOR



DIMENSIONI



TESTA SOTTILE PER LA MASSIMA ACCESSIBILITÀ

FG 363/LT1

€/LISTINO ~~505,00~~

PROMO 269,00€

CRICCHETTO 3/8" - 14,4V

Motore Brushless
Elevate prestazioni, fino a 95 Nm di coppia massima

Velocità a vuoto 550 Rpm

Design lungo

Velocità variabile

Luce led per illuminare l'area di lavoro

Dotazione: 1 batteria al litio 14,4V - 2Ah, 1 caricabatteria, valigetta in ABS con clip di chiusura in metallo

14.4V CE

BRUSHLESS MOTOR



DIMENSIONI



DESIGN LUNGO PER ACCEDERE AI PUNTI PIÙ DIFFICILI

FG 366/LT1

€/LISTINO ~~525,00~~

PROMO 279,00€

CRICCHETTO 1/4" - 14,4V

Motore Brushless
Massima efficienza, fino a 61 Nm di coppia massima con una velocità di 500 giri al minuto

Design lungo

Velocità variabile

Luce led per illuminare l'area di lavoro

Dotazione: 1 batteria al litio 14,4V - 2Ah, 1 caricabatteria, valigetta in ABS con clip di chiusura in metallo

14.4V CE

BRUSHLESS MOTOR



DIMENSIONI



DESIGN LUNGO PER ACCEDERE AI PUNTI PIÙ DIFFICILI

FG 370/LT1

€/LISTINO
~~600,00~~

PROMO
319,00€

LEVIGATRICE A NASTRO - 14,4V 10X330MM

Motore Brushless
Nastro 10x330 mm
Velocità variabile
Velocità a vuoto: 20000 Rpm
Velocità del nastro: 0~1327 m/min
Design leggero ed ergonomico
Luce led per illuminare l'area di lavoro
Dotazione: 1 batteria al litio 14,4V - 2Ah, 1 caricabatteria,
valigetta in ABS con clip di chiusura in metallo



DIMENSIONI



BRACCIO GIREVOLE A 360°

14.4V

BRUSHLESS
MOTOR



FG 373/LT1

€/LISTINO
~~600,00~~

PROMO
319,00€

LEVIGATRICE A NASTRO - 14,4V 20X520MM

Motore Brushless
Nastro 20x520 mm
Velocità variabile
Velocità a vuoto: 20000 Rpm
Velocità del nastro: 0~1327 m/min
Design leggero ed ergonomico
Luce led per illuminare l'area di lavoro
Dotazione: 1 batteria al litio 14,4V - 2Ah, 1 caricabatteria,
valigetta in ABS con clip di chiusura in metallo



DIMENSIONI



BRACCIO GIREVOLE A 360°

14.4V

BRUSHLESS
MOTOR



FG 380/LT1

€/LISTINO
~~505,00~~

PROMO
269,00€

MINI SMERIGLIATRICE DRITTA 14,4V

Motore Brushless
4 velocità
Velocità a vuoto: 24500 Rpm
Design compatto
Testa dritta con attacco a pinza da 6 mm
Diametro massimo dischi per smeriglio 55 mm
Luce led per illuminare l'area di lavoro
Dotazione: 1 batteria al litio 14,4V - 2Ah, 1 caricabatteria,
valigetta in ABS con clip di chiusura in metallo



DIMENSIONI



PANNELLO DI CONTROLLO VELOCITÀ DI LAVORO

14.4V

BRUSHLESS
MOTOR



FG 383/LT1

€/LISTINO
~~525,00~~

PROMO
279,00€

MINI SMERIGLIATRICE ANGOLARE 14,4V

Motore Brushless
4 velocità
Velocità a vuoto: 24500 Rpm
Design compatto
Testa angolare con attacco a pinza da 6 mm
Diametro massimo dischi per smeriglio 55 mm
Luce led inclinabile per illuminare l'area di lavoro
Dotazione: 1 batteria al litio 14,4V - 2Ah, 1 caricabatteria,
valigetta in ABS con clip di chiusura in metallo



DIMENSIONI



PANNELLO DI CONTROLLO VELOCITÀ DI LAVORO

14.4V

BRUSHLESS
MOTOR





ESTRATTORI



FG 162/S3

€/LISTINO
~~366,00~~

PROMO
219,00€

SET 3 ESTRATTORI UNIVERSALI A 2 GRIFFE

Presca esterna
Griffe scorrevoli in acciaio al cromo vanadio

Contenuto:
A/mm 15-85 - H/mm 100
A/mm 15-125 - H/mm 100
A/mm 20-160 - H/mm 150



ESTRATTORE UNIVERSALE A 2 GRIFFE SOTTILI

Griffe intercambiabili super sottili da 2mm in acciaio al cromo vanadio
Presca interna ed esterna
Vite in acciaio al cromo vanadio



CODICE	A/MM	B/MM	C/MM	€/LISTINO	€/PROMO
FG 168/EF1	110	140	186	340,00	209,00€
FG 168/EF2	195	140	186	350,00	215,00€

ESTRATTORE A 3 GRIFFE PER PRESca INTERNA ED ESTERNA

Dotato di 3 griffe per presca interna e 3 griffe per presca esterna
Griffe in acciaio al cromo vanadio



CODICE	Ø INTERNA	Ø ESTERNA	€/LISTINO	€/PROMO
FG 165/IE1	25-100mm	0-75mm	325,00	199,00€
FG 165/IE2	45-150mm	40-130mm	760,00	459,00€

FG 163/S2B

€/LISTINO
~~263,00~~

PROMO
159,00€

ESTRATTORE CON GRIFFE PER PRESca INTERNA ED ESTERNA

7 - 140/23 - 130 (per presca esterna)
40 - 180 (per presca interna)
Griffe autoregolabili in acciaio al cromo vanadio



MASSA BATTENTE
M12x1.5



CODICE	PER	€/LISTINO	€/PROMO
FG 165/MB1	FG 165/IE1	170,00	99,00€
FG 165/MB2	FG 165/IE2	330,00	199,00€

FG 168SD/S4

€/LISTINO
~~162,00~~

PROMO
99,00€

SET 4 SPACCADADI
Contenuto: FG 168/SD1 -SD2-SD3-SD4



SET ESTRATTORI PER DADI DESTORSI DANNEGGIATI CON ATTACCO 1/2"
Fornito su supporto in ABS appendibile con ganci a clip e meccanismo finecorsa anticaduta

1/2"



CODICE	CONTENUTO	€/LISTINO	€/PROMO
FG 168A/S5	22, 24, 27, 30, 32 mm	115,00	69,00€
FG 168A/S13	8, 9, 10, 11, 12, 13, 14, 15, 16, 17, 18, 19, 21 mm	220,00	129,00€

FG 168EP/S5

€/LISTINO
~~35,00~~

PROMO
21,00€

SET 5 ESTRATTORI CONICI PER VITI E PRIGIONIERI SPEZZATI
Inserimento a percussione



FG 168/S25

€/LISTINO
~~145,00~~

PROMO
89,00€

SET ESTRATTORI PER VITI E PRIGIONIERI SPEZZATI
Dotato di guide per interno ed esterno e punte per forare
Utilizzo: viti/bulloni con diametro 6-16mm

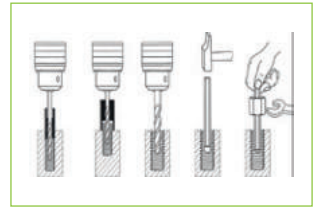

FG 168/S9

€/LISTINO
~~188,00~~

PROMO
109,00€

SET 9 ESTRATTORI A RULLI PER VITI PRIGIONIERE
Contenuto: FG 168/R6 - R16



FG 182/S5B

€/LISTINO
~~475,00~~

PROMO
289,00€

SET ESTRATTORI AD ESPANSIONE PER INTERNI CON ACCESSORI



FG 182/S14

€/LISTINO
~~248,00~~

PROMO
149,00€

SET ESTRATTORI PER CUSCINETTI CON FALSE SFERE
Ø/mm 5,6,8,9,11,12,5





UTENSILI PNEUMATICI



FGA 307

€/LISTINO
~~250,00~~

PROMO
149,00€

AVVITATORE AD IMPULSI 1/2"

- 745 Nm MAX
- 610 Nm MAX
- 136 L/min
- 9.500 MAX RPM
- 1200gr
- 6.2 Bar



MARTELLINO SINGOLO

1.085 Nm
MAX TORQUE



FGA 307/AN

€/LISTINO
~~340,00~~

PROMO
189,00€

AVVITATORE ANGOLARE AD IMPULSI 1/2"

- 420 Nm MAX
- 264 Nm MAX
- 113 L/min
- 9.000 MAX RPM
- 1150gr
- 6.2 Bar



MARTELLINO SINGOLO

680 Nm
MAX TORQUE



FGA 309

€/LISTINO
~~300,00~~

PROMO
179,00€

AVVITATORE AD IMPULSI 1/2"

- 1.085 Nm MAX
- 745 Nm MAX
- 151 L/min
- 7.300 MAX RPM
- 1900gr
- 6.2 Bar



MARTELLINO DOPPIO

1.700 Nm
MAX TORQUE



FGA 312

€/LISTINO
~~380,00~~

PROMO
199,00€

AVVITATORE AD IMPULSI 1/2"

- 1130 Nm MAX
- 950 Nm MAX
- 136 L/min
- 7.500 MAX RPM
- 2000gr
- 6.2 Bar



MARTELLINO DOPPIO

2.000 Nm
MAX TORQUE



FGA 316

€/LISTINO
~~760,00~~

PROMO
459,00€

AVVITATORE AD IMPULSI 3/4"

FGA 316/L

€/LISTINO
~~850,00~~

PROMO
519,00€

AVVITATORE AD IMPULSI 3/4" AD ALBERO LUNGO 6"



MARTELLO DOPPIO

CE



FGA 319

€/LISTINO
~~1.250,00~~

PROMO
659,00€

AVVITATORE AD IMPULSI 1"

FGA 319/L

€/LISTINO
~~1.350,00~~

PROMO
719,00€

AVVITATORE AD IMPULSI 1" AD ALBERO LUNGO 6"



PIN-LESS

CE



FGA 321

€/LISTINO
~~1.130,00~~

PROMO
589,00€

AVVITATORE AD IMPULSI 1"

FGA 321/B

€/LISTINO
~~1.220,00~~

PROMO
649,00€

AVVITATORE AD IMPULSI 1" AD ALBERO LUNGO 6"



MARTELLO DOPPIO

CE



FGA 321/C

€/LISTINO
~~1.320,00~~

PROMO
699,00€

AVVITATORE AD IMPULSI 1" AD ALBERO LUNGO 6"



PIN-LESS

CE

CONSIGLIATO PER UTILIZZI INTENSIVI





UTENSILI PNEUMATICI

FGA 290

€/LISTINO
~~195,00~~

PROMO
119,00€

CRICCHETTO REVERSIBILE 1/4"
Sistema di reversibilità integrata sulla testa
Sistema di azionamento a pinza



FGA 291/D

€/LISTINO
~~180,00~~

PROMO
109,00€

MINI CRICCHETTO CON ATTACCO QUADRO 1/4"



— DIMENSIONI RIDOTTE: SOLO 125MM —



FGA 292/B

€/LISTINO
~~215,00~~

PROMO
129,00€

CRICCHETTO REVERSIBILE 1/2"



UTENSILI SEMPRE EFFICIENTI

Per gli utensili pneumatici Fasano Tools sono disponibili a catalogo i kit di manutenzione ordinaria, per ottimizzare il tuo lavoro con utensili sempre ordinati ed efficienti.

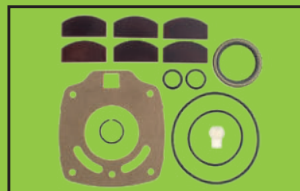
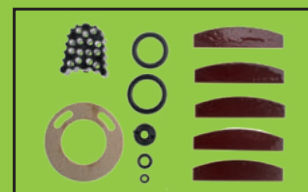
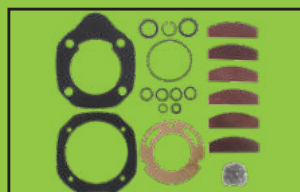

FGA 322

€/LISTINO
~~140,00~~

PROMO
85,00€

LEVIGATRICE PER PNEUMATICI



FGA 390

€/LISTINO
~~162,00~~

PROMO
99,00€

PISTOLA DI GONFIAGGIO

Corpo in alluminio nichelato
Rivestimento in gomma antiolio
Manometro Ø80 (0-10bar)
Protezione sovrappressioni
Leva a due posizioni scarico/gonfiaggio
Lunghezza tubo: 500 mm





AVVOLGITUBO

FGA 383/AR15

€/LISTINO ~~275,00~~ **PROMO 139,00€**

AVVOLGITUBO AUTOMATICO PER ARIA COMPRESSA - 15MT
 Ø tubo: 8x12mm
 Raccordo in uscita 1/4" maschio
 Raccordo in entrata 1/4" maschio

FGA 385/AR15

€/LISTINO ~~360,00~~ **PROMO 179,00€**

AVVOLGITUBO AUTOMATICO PER ARIA COMPRESSA - 15MT
 Ø tubo: 10x13mm
 Raccordo in uscita 3/8" maschio
 Raccordo in entrata 3/8" maschio

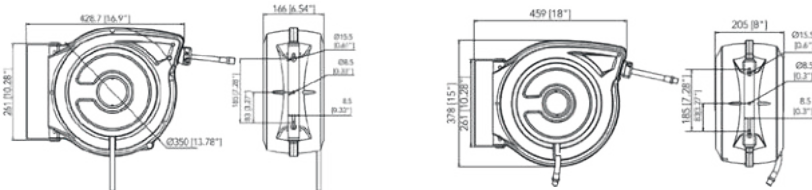

TUBO IN POLIURETANO RETINATO
STAFFA A MURO ORIENTABILE A 360°



Guida di scorrimento automatico

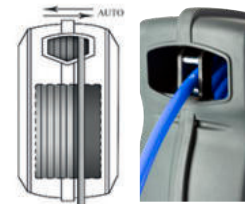

Sistema di bloccaggio a qualsiasi lunghezza

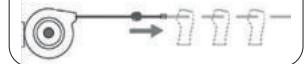

Riavvolgimento a velocità controllata



FGA 419

€/LISTINO ~~23,00~~ **PROMO 13,90€**

PISTOLA DI SOFFIAGGIO
 Valvola ad apertura progressiva
 Corpo in alluminio nichelato
 Impugnatura in gomma anti-scivolo



FGA 416

€/LISTINO ~~21,00~~ **PROMO 12,90€**

PISTOLA DI SOFFIAGGIO
 Valvola ad apertura progressiva
 Filettatura in ottone





UTENSILI PNEUMATICI

LEVIGATRICE ROTO-ORBITALE



152mm	11000 MAX RPM	900gr
45.2 L/min	6.2 Bar	

150mm	11000 MAX RPM	800gr
46 L/min	6.2 Bar	



CODICE		€/LISTINO	€/PROMO
FGA 340	Ø plattello 152mm	295,00	169,00€
FGA 340/B	Ø plattello 150mm	295,00	169,00€

FGA 342/B

€/LISTINO
~~285,00~~

PROMO
169,00€

LEVIGATRICE ROTO-ORBITALE

Ø orbita: 2,5 mm
Plattello 3 fori in dotazione



75mm	11000 MAX RPM	500gr
46 L/min	6.2 Bar	

FGA 344

€/LISTINO
~~250,00~~

PROMO
149,00€

UTENSILE STACCAVETRI CON LAMA OSCILLANTE

Fornito con una lama da 57mm (FGA 344/LS1)
Convogliatore dell'aria in uscita

NEW

20.000 MAX RPM
0.50 Hp
1060gr
6.2 Bar



FGA 342

€/LISTINO
~~230,00~~

PROMO
139,00€

LEVIGATRICE ORBITALE

Diametro orbita: 2mm
3 plattelli in dotazione



74 L/min	13000 MAX RPM	500gr	6.2 Bar
----------	---------------	-------	---------

FGA 343/N10

€/LISTINO
~~230,00~~

PROMO
139,00€

LEVIGATRICE A NASTRO

Dimensione nastro: 10x330mm
3 nastri in dotazione



0.70 Hp	18000 MAX RPM	90 L/min	800gr	6.2 Bar
---------	---------------	----------	-------	---------

FGA 343/N20

€/LISTINO
~~310,00~~

PROMO
189,00€

LEVIGATRICE A NASTRO

Dimensione nastro: 20x520mm
3 nastri in dotazione



0.70 Hp	18000 MAX RPM	107 L/min	960gr	6.2 Bar
---------	---------------	-----------	-------	---------

FGA 337

€/LISTINO
~~130,00~~

PROMO
79,00€

LEVIGATRICE PNEUMATICA PER RIMOZIONE RESIDUI GOMMOSI



FGA 330

€/LISTINO
~~295,00~~

PROMO
179,00€

SEGHETTO ALTERNATIVO

Corpo in alluminio rivestito in gomma antiscivolo
Protezione lama anteriore in acciaio



FGA 339

€/LISTINO
~~355,00~~

PROMO
199,00€

LEVIGATRICE ANGOLARE - Ø DISCO: 115MM

Capacità disco: 115mm
Sistema di regolazione velocità a pinza



FGA 332

€/LISTINO
~~145,00~~

PROMO
89,00€

TRAPANO REVERSIBILE CON MANDRINO AUTOSERRANTE 1-10MM

Mandrino autoserrante 1-10mm (3/8")



FGA 335

€/LISTINO
~~210,00~~

PROMO
119,00€

RIVETTATRICE PNEUMATICA

4 testine intercambiabili
Dotata di serbatoio posteriore per caduta rivetti
Corpo in acciaio resistente agli urti
Attacco aria 1/4" gas
Ø interno tubo aria 10mm (3/8")
ALLUMINIO: 2.4, 3.2, 4.0, 4.8
ACCIAIO: 2.4, 3.2, 4.0, 4.8
INOX: 2.4, 3.2, 4.0



FGA 336

€/LISTINO
~~600,00~~

PROMO
369,00€

RIVETTATRICE PNEUMATICA

4 testine intercambiabili
Dotata di serbatoio posteriore per caduta rivetti
Corpo in acciaio resistente agli urti
Attacco aria 1/4" gas
Ø interno tubo aria 10mm (3/8")
ALLUMINIO: 3.0/3.2, 4.0, 4.8, 6.4
ACCIAIO: 3.0/3.2, 3.2, 4.0, 4.8, 6.4
INOX: 3.0/3.2, 3.2, 4.0, 4.8





FGA 346/B

€/LISTINO
~~230,00~~

PROMO
139,00€

MICROSMERIGLIATRICE ASSIALE
Capacità pinza: 3mm



FGA 334

€/LISTINO
~~145,00~~

PROMO
89,00€

SMERIGLIATRICE DIRITTA A PINZA
Capacità pinza: 6mm



LAME IN KEVLAR

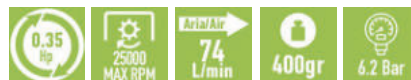

FGA 338

€/LISTINO
~~125,00~~

PROMO
75,00€

SMERIGLIATRICE DIRITTA A PINZA
Corpo in acciaio rivestito in gomma antiscivolo
Capacità pinza: 6mm



LAME IN KEVLAR



FGA 334/AN115

€/LISTINO
~~185,00~~

PROMO
109,00€

SMERIGLIATRICE ANGOLARE A PINZA - INCLINAZIONE 115°
Capacità pinza: 6mm



LAME IN KEVLAR



FGA 338/AN

€/LISTINO
~~170,00~~

PROMO
99,00€

SMERIGLIATRICE ANGOLARE A PINZA
Corpo in acciaio rivestito in gomma antiscivolo
Capacità pinza: 6mm



LAME IN KEVLAR



FGA 334/AN

€/LISTINO
~~185,00~~

PROMO
109,00€

SMERIGLIATRICE ANGOLARE A PINZA
Capacità pinza: 6mm



LAME IN KEVLAR



FGA 338/L

€/LISTINO
~~165,00~~

PROMO
99,00€

SMERIGLIATRICE PINZA AD ALBERO LUNGO
Corpo in acciaio rivestito in gomma antiscivolo
Capacità pinza: 6mm



LAME IN KEVLAR



FGA 334/L

€/LISTINO
~~185,00~~

PROMO
109,00€

SMERIGLIATRICE A PINZA AD ALBERO LUNGO
Capacità pinza: 6mm



LAME IN KEVLAR



GAMMA AIR COMPACT

Design compatto e prestazioni ottimizzate per lavorare in maniera efficiente, con rapidità e precisione



FGA 348/A

€/LISTINO
~~170,00~~

PROMO
99,00€

SMERIGLIATRICE DIRITTA A PINZA COMPACT

Design leggero e compatto
Capacità della pinza 6 mm (1/4")
Attacco aria 1/4" gas
Ø interno tubo aria 10mm (3/8")

CE NEW



— DIMENSIONI RIDOTTE: SOLO 118MM —

30.000
MAX RPM

0.30
Hp

318gr

6.2 Bar

FGA 348/C

€/LISTINO
~~250,00~~

PROMO
149,00€

SMERIGLIATRICE ANGOLARE COMPACT - Ø DISCO 51MM

Design leggero e compatto
Attacco aria 1/4" gas
Ø interno tubo aria 10mm (3/8")
Ø foro del disco da smeriglio da utilizzare: 9.5mm
In dotazione 1 disco da 2mm e 1 disco da 3mm

CE NEW



— DIMENSIONI RIDOTTE: SOLO 108MM —

22000
MAX RPM

0.30
Hp

420gr

6.2 Bar

FGA 348/B

€/LISTINO
~~210,00~~

PROMO
119,00€

SMERIGLIATRICE ANGOLARE A PINZA COMPACT

Design leggero e compatto
Capacità della pinza 6 mm (1/4")
Attacco aria 1/4" gas
Ø interno tubo aria 10mm (3/8")

CE NEW



— DIMENSIONI RIDOTTE: SOLO 121MM —

22000
MAX RPM

0.30
Hp

443gr

6.2 Bar

FGA 348/D

€/LISTINO
~~280,00~~

PROMO
159,00€

LEVIGATRICE ORBITALE COMPACT

Design leggero e compatto
Attacco aria 1/4" gas
Ø interno tubo aria 10mm (3/8")
Filettatura 5/16" - 24 UNF
Ø del platorello 51mm, in dotazione

CE NEW



— DIMENSIONI RIDOTTE: SOLO 108MM —

22000
MAX RPM

0.30
Hp

420gr

6.2 Bar

IL MEGLIO DEL MADE IN ITALY



I nostri carrelli sono frutto di un intenso lavoro di ricerca, sviluppo, progettazione e produzione interna.

SOLIDITA' E FUNZIONALITA' SONO I TRATTI DISTINTIVI DEI NOSTRI CARRELLI PORTAUTENSILI

Una gamma completa di modelli che si differenziano per design, colorazioni e funzionalità per offrire all'utilizzatore le migliori soluzioni possibili in base alle sue esigenze



CASSETTI COMPATIBILI
CON TUTTI I TERMOFORMATI
FASANO TOOLS

FG 102



FG 100



FG 122



FG 150



STANDARD

DISPONIBILI CON 5-6-7-8 CASSETTI
IN 5 VARIANTI COLORE + 14 VARIANTI COLORE FG 100 BICOLOR

FG 104



FG 124



XL

DISPONIBILI CON 6-7 CASSETTI
IN 4 VARIANTI COLORE

FG 125



NEW

FG 126



NEW

FG 162V/14L



NEW

FG 162V/14P



PORTATA
MASSIMA
2400Kg

CON APPENDICE LATERALE
DISPONIBILI IN 4 VARIANTI COLORE

CON PIANO DI LAVORO UNICO
IN LAMIERA D'ACCIAIO DA 2MM CON TOP IN POLICARBONATO
O IN MULTISTRATO IN PIOCCO DA 18MM
DISPONIBILI IN 4 VARIANTI COLORE CON 14 CASSETTI

LA QUALITA' CHE DURA NEL TEMPO

**I CARRELLI FASANO TOOLS
TI SEMPLIFICANO IL LAVORO:
SONO REALIZZATI CON LA MASSIMA
CURA DEI DETTAGLI PER CUSTODIRE
I TUOI UTENSILI CON AFFIDABILITÀ E PRATICITÀ.**

**IL MANIGLIONE LATERALE IN ACCIAIO
E LE RUOTE RIVESTITE IN GOMMA VULCANIZZATA
RENDONO I CARRELLI MANEGGEVOLI
E FACILMENTE TRASPORTABILI.**

**LA LAMIERA D'ACCIAIO CON SPESSORE 10/10
GARANTISCE SOLIDITÀ, STABILITÀ E ROBUSTEZZA.**



**I CASSETTI SONO DOTATI DI:
MANIGLIE IN LAMIERA D'ACCIAIO
APERTURA AD ESTRAZIONE TOTALE
GUIDE TELESCOPICHE CON SISTEMA SOFT CLOSING
TAPPETINI PROTETTIVI ANTIGRAFFIO E ANTISCIVOLO**

**PORTATA DEI CASSETTI:
45 KG NELLA VERSIONE STANDARD
60 KG NELLA VERSIONE XL**



DIVISORI PER CASSETTO

**PREDISPOSIZIONE PER DIVISORI
INTERNI PER L'ORGANIZZAZIONE
DELLA MINUTERIA**

**PER ASSICURARE ORDINE
E PRECISIONE AL TUO LAVORO!**





CARRELLI PORTA UTENSILI

**OGNI DETTAGLIO
FA LA DIFFERENZA
IN TERMINI
DI SOLIDITA'
E RESISTENZA
NEL TEMPO**



TOP SUPERIORE IN GOMMA CON FINITURA CARBON 3D



APERTURA TOTALE DEL CASSETTO CON MECCANISMO SOFT CLOSING



PREDISPOSIZIONE INTERNA PER DIVISORI ADATTI ALLA MINUTERIA



RUOTE RIVESTITE IN GOMMA VULCANIZZATA (2 FISSE + 2 GIREVOLI DI CUI 1 CON FRENO)

FG 122



CARRELLO PORTA UTENSILI

Scocca elettrosaldata
Guide telescopiche con meccanismo soft closing
Top superiore in gomma con finitura carbon 3D
Chiusura centralizzata
Maniglia con spessore 20/10
Cassetti dotati di tappetini antigraffio e predisposizione per divisori interni
Apertura totale dei cassetti
Maniglione laterale in acciaio inox
Capacità massima dei cassetti: 45kg



800 Kg
PORTATA STATICA

CODICE				Cassetti	Peso/Kg	€/listino	€/PROMO
FG 122V/5G	FG 122D/5G	FG 122B/5G	FG 122R/5G	5	65	1.030,00	499,00€
FG 122V/6G	FG 122D/6G	FG 122B/6G	FG 122R/6G	6	69	1.080,00	529,00€
FG 122V/7G	FG 122D/7G	FG 122B/7G	FG 122R/7G	7	71	1.150,00	549,00€

FG 122/PC

NEW

PORTA PC
Per FG 102, FG 104, FG 105, FG 109, FG 122, FG 124, FG 125, FG 126
Richiudibile



€/LISTINO

~~80,00~~

PROMO
49,00€

FG 122/PL

NEW

PORTA LATTINE
Per FG 122, FG 124, FG 125, FG 126

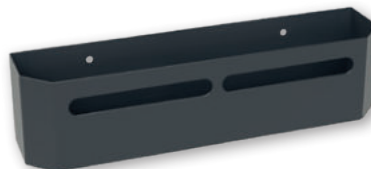

€/LISTINO

~~58,00~~

PROMO
34,90€

FG 100/PR

PORTA ROTOLO
Per FG 100, FG 122, FG 124, FG 125, FG 126



€/LISTINO

~~62,00~~

PROMO
37,90€

FG 124



CARRELLO PORTA UTENSILI

Scocca elettrosaldata
Top superiore in gomma con finitura carbon 3D
Chiusura centralizzata
Guide telescopiche con meccanismo soft closing
Cassetti dotati di tappetini antigraffio e predisposizione per divisori interni
Apertura totale dei cassetti
Maniglia con spessore 20/10
Maniglione laterale in acciaio inox
Capacità massima dei cassetti: 60kg



CODICE				Cassetti	Peso/Kg	€/listino	€/PROMO
FG 124V/6G	FG 124D/6G	FG 124B/6G	FG 124R/6G	6	82	1.300,00	619,00€
FG 124V/7G	FG 124D/7G	FG 124B/7G	FG 124R/7G	7	85	1.400,00	659,00€

FG 125

NEW



CARRELLO PORTA UTENSILI CON APPENDICE LATERALE

Scocca elettrosaldata
Top superiore in gomma con finitura carbon 3D
Chiusura centralizzata
Armadietto laterale con ripiani interni amovibili e anta apribile a 120° dotata di chiusura di sicurezza
Guide telescopiche con meccanismo soft closing
Cassetti dotati di tappetini antigraffio e predisposizione per divisori interni
Apertura totale dei cassetti
Maniglia con spessore 20/10
Maniglione laterale in acciaio inox
Capacità massima dei cassetti: 45kg



CODICE				Cassetti	Peso/Kg	€/listino	€/PROMO
FG 125V/5G	FG 125D/5G	FG 125B/5G	FG 125R/5G	5	86	1.460,00	729,00€
FG 125V/6G	FG 125D/6G	FG 125B/6G	FG 125R/6G	6	90	1.510,00	749,00€
FG 125V/7G	FG 125D/7G	FG 125B/7G	FG 125R/7G	7	92	1.580,00	769,00€

FG 126

NEW



CARRELLO PORTA UTENSILI CON APPENDICE LATERALE

Scocca elettrosaldata
Top superiore in gomma con finitura carbon 3D
Armadietto laterale con ripiani interni amovibili e anta apribile a 120° dotata di chiusura di sicurezza
Guide telescopiche con meccanismo soft closing
Chiusura centralizzata
Cassetti dotati di tappetini antigraffio e predisposizione per divisori interni
Apertura totale dei cassetti
Maniglia con spessore 20/10
Maniglione laterale in acciaio inox
Capacità massima dei cassetti: 60kg



CODICE				Cassetti	Peso/Kg	€/listino	€/PROMO
FG 126V/6G	FG 126D/6G	FG 126B/6G	FG 126R/6G	6	103	1.730,00	849,00€
FG 126V/7G	FG 126D/7G	FG 126B/7G	FG 126R/7G	7	106	1.830,00	899,00€



CARRELLI E BANCHI DA LAVORO

FG 123



CARRELLO PORTA UTENSILI CON PENSILE

- Pensile superiore dotato di pistoni a gas
- Griglia porta utensili
- Scocca elettrosaldata
- Top superiore in gomma con finitura carbon 3D
- Chiusura centralizzata
- Maniglia con spessore 20/10
- Cassetti dotati di tappetini antigraffio e predisposizione per divisori interni
- Guide telescopiche con meccanismo soft closing
- Apertura totale dei cassetti
- Maniglione laterale in acciaio inox
- Ruote rivestite in gomma vulcanizzata Ø125mm (2 fisse e 2 girevoli di cui 1 con freno)
- Capacità massima dei cassetti: 45kg

NEW



PENSILE SUPERIORE DOTATO DI PISTONI A GAS



GRIGLIA PORTA UTENSILI



800 Kg PORTATA STATICA

CODICE				Cassetti	Peso/Kg	€/listino	€/PROMO
FG 123V/5G	FG 123B/5G	FG 123R/5G	FG 123D/5G	5	81	1.430,00	699,00€
FG 123V/6G	FG 123B/6G	FG 123R/6G	FG 123D/6G	6	85	1.480,00	729,00€
FG 123V/7G	FG 123B/7G	FG 123R/7G	FG 123D/7G	7	87	1.550,00	749,00€

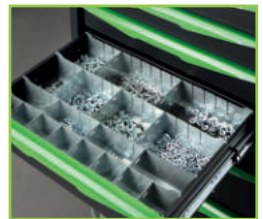

PREDISPOSIZIONE PER DIVISORI INTERNI

FG 100



CARRELLO PORTA UTENSILI FG 100

- Guide telescopiche con meccanismo soft closing
- 4 ruote in gomma vulcanizzata Ø125mm (2 fisse e 2 girevoli, 1 con freno)
- Chiusura laterale centralizzata
- Cassetti dotati di tappetini antigraffio
- Predisposizione per divisori interni
- Maniglie in acciaio
- Ripiano superiore in ABS e griglie porta utensili laterali
- Porta flaconi laterale di serie
- Pannelli laterali con fori per appendimento ganci porta utensili
- Capacità massima dei cassetti: 45kg

800 Kg PORTATA STATICA



SISTEMA DI CHIUSURA LATERALE



MANIGLIONE IN ACCIAIO

CODICE					Cassetti	Peso/Kg	€/listino	€/PROMO
FG 100V/5T	FG 100B/5T	FG 100R/5T	FG 100D/5T	FG 100W/5T	5	58	1.000,00	519,00€
FG 100V/6T	FG 100B/6T	FG 100R/6T	FG 100D/6T	FG 100W/6T	6	60	1.050,00	549,00€
FG 100V/7T	FG 100B/7T	FG 100R/7T	FG 100D/7T	FG 100W/7T	7	62	1.100,00	569,00€



CASSETTO CON APERTURA COMPLETA



FG 162



CARRELLO PORTA UTENSILI A 14 CASSETTI

Guide telescopiche soft closing
Maniglione laterale in acciaio
Porta rotolo e porta lattine in dotazione
Cassetti dotati di tappetino interno in gomma
Pannelli laterali con fori per ganci porta utensili
Ripiano superiore in lamiera da 2mm, con top in policarbonato
4 ruote rivestite in gomma vulcanizzata Ø160mm
(2 fisse, 2 girevoli con freno)
Ante apribili a 110°, dotate di serratura e 2 ripiani interni amovibili
Griglia laterale portautensili (530x240mm)
14 cassetti: 5 cassetti 580x398x75mm, 2 cassetti 580x398x135mm, 5 cassetti 580x235x75mm, 2 cassetti 580x235x135mm
Portata 2400 kg
Capacità massima dei cassetti: 45kg



2400 Kg **PORTATA STATICA**



CODICE				Cassetti	Peso/kg	€/listino	€/PROMO
FG 162V/14P	FG 162D/14P	FG 162B/14P	FG 162R/14P	14	193	3.300,00	1.699,00€



ANTA APRIBILE A 110°



MANIGLIONE IN ACCIAIO INOX



CASSETTI CON PREDISPOSIZIONE PER

FG 162

NEW



CARRELLO PORTA UTENSILI A 14 CASSETTI CON TOP IN LEGNO

Guide telescopiche soft closing
Maniglione laterale in acciaio
Porta rotolo e porta lattine in dotazione
Cassetti dotati di tappetino interno in gomma
Pannelli laterali con fori per ganci porta utensili
Ripiano superiore in multistrato in pioppo da 18mm
4 ruote rivestite in gomma vulcanizzata Ø160mm (2 fisse, 2 girevoli con freno)
Ante apribili a 110°, dotate di serratura e 2 ripiani interni amovibili
Griglia laterale portautensili (530x240mm)
14 cassetti: 5 cassetti 580x398x75mm, 2 cassetti 580x398x135mm, 5 cassetti 580x235x75mm, 2 cassetti 580x235x135mm
Portata 2400kg



2400 Kg **PORTATA STATICA**



CODICE				Cassetti	Peso/kg	€/listino	€/PROMO
FG 162V/14L	FG 162B/14L	FG 162R/14L	FG 162D/14L	14	184	3.300,00	1.699,00€



POSSIBILITÀ DI APPLICARE DIVERSI ACCESSORI



TOP IN MULTISTRATO IN PIOPPO DA 18mm

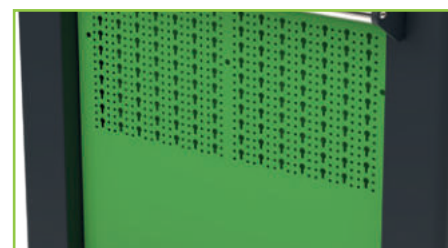

FORI PER GANCI PORTAUTENSILI



CARRELLI E BANCHI DA LAVORO



FG 120/CO1V

€/LISTINO
~~2.600,00~~

PROMO
1.199,00€

CONFIGURAZIONE MAXI STATION

Ripiano superiore in acciaio (spessore 20/10) con top in policarbonato
Verniciatura satinata opaca
Maniglione in acciaio inox
Cassetti con apertura totale completi di tappetini antigraffio e predisposizione divisori
Frontalini copriruota ribaltabili
4 ruote girevoli Ø125mm con corpo in polipropilene e rivestite in gomma vulcanizzata (2 con freno)

Composto da:
FG 120V/7T - Cassettiera a 7 cassetti
FG 120V/A - Modulo armadietto
FG 120V/A - Modulo armadietto
Dimensioni mm (LxWxH): 1540x460x1030



FG 120/CO1D



FG 120/CO1B



FG 120/CO1R



FG 120/CO2V

€/LISTINO
~~2.690,00~~

PROMO
1.249,00€

CONFIGURAZIONE MAXI STATION

Ripiano superiore in acciaio (spessore 20/10) con top in policarbonato
Verniciatura satinata opaca
Maniglione in acciaio inox
Cassetti con apertura totale completi di tappetini antigraffio e predisposizione divisori
Frontalini copriruota ribaltabili
4 ruote girevoli Ø125mm con corpo in polipropilene e rivestite in gomma vulcanizzata (2 con freno)

Composto da:
FG 120V/7T - Cassettiera a 7 cassetti
FG 120V/A - Modulo armadietto
FG 120V/B - Modulo porta carta con cassetto porta rifiuti
Dimensioni mm (LxWxH): 1540x460x1030



FG 120/CO2D



FG 120/CO2B



FG 120/CO2R

FG 127V/A

€/LISTINO
~~570,00~~

PROMO
299,00€

NEW

CARRELLO MULTIFUNZIONE

Struttura in lamiera di acciaio con spessore 20/10
Maniglie frontali e maniglione posteriore
per la massima maneggevolezza durante gli spostamenti
Piano di appoggio inclinato ideale per laptop
Ripiano laterale porta mouse
2 ripiani regolabili in altezza
5 ganci avvolgicavo in lamiera di acciaio
3 contenitori laterali
Porta rotolo posteriore
4 ruote girevoli con rivestimento in gomma antigraffio
(Ø 75mm, di cui 2 con freno)
Peso: 25 Kg



5 AVVOLGICAVI LATERALI IN LAMIERA



PIANO DI APPOGGIO INCLINATO CON VANO LATERALE PORTA MOUSE



MANIGLIONE POSTERIORE



FG 127V/B

€/LISTINO
~~680,00~~

PROMO
359,00€

NEW

CARRELLO MULTIFUNZIONE CON ANTA DI CHIUSURA

Struttura in lamiera di acciaio con spessore 20/10
Maniglie frontali e maniglione posteriore
per la massima maneggevolezza durante gli spostamenti
Piano di appoggio inclinato ideale per laptop
Ripiano laterale porta mouse
1 ripiano regolabile in altezza ed 1 ripiano fisso
Vano con anta dotata di chiusura di sicurezza
5 ganci avvolgicavo in lamiera di acciaio
3 contenitori laterali
Porta rotolo posteriore
4 ruote girevoli con rivestimento in gomma antigraffio
(Ø 75mm, di cui 2 con freno)
Peso: 28 Kg



MANIGLIE FRONTALI



VANO CON ANTA DI CHIUSURA



PORTA ROTOLO POSTERIORE

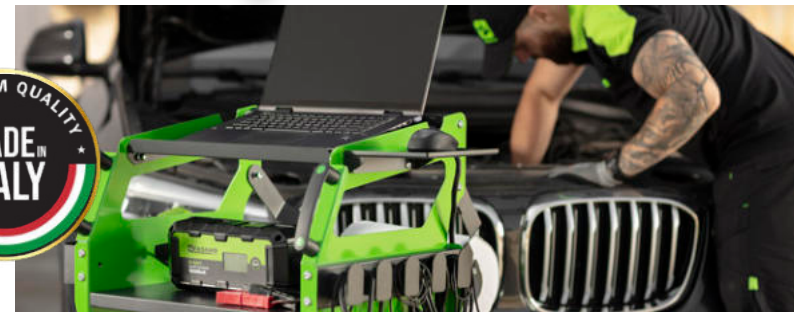

FG 101V/3G

€/LISTINO
~~500,00~~

PROMO
249,00€

CARRELLO PORTA UTENSILI A 3 CASSETTI MOD. FG 101
Peso 26,5Kg



2 RIPIANI (SUPERIORE E INFERIORE) PORTA OGGETTI 680X460 MM



POSSIBILITÀ DI INSERIMENTO MODULI DI UTENSILERIA

FG 108/B

€/LISTINO
~~140,00~~

PROMO
69,00€

CARRELLO MULTI-SERVIZIO UNIVERSALE PER MINUTERIE E ATTREZZI DA LAVORO



DOTATO DI 16 VASCETTE AMOVIBILI PORTA MINUTERIE



STRUTTURA LATERALE IN ALLUMINIO E RIPIANI E ACCESSORI IN ABS



CARRELLI E BANCHI DA LAVORO

FG 101D/AS165

€ LISTINO
~~1.623,00~~

PROMO
699,00€

CARRELLO PORTA UTENSILI A 6 CASSETTI MOD. FG 101
CON ASSORTIMENTO 165 UTENSILI IN MODULI RIGIDI

ASSORTIMENTO 165 UTENSILI



1° CASSETTO



- FG 102/03G: Modulo 14 chiavi combinate 6 - 19mm
- FG 102/17E: Modulo 65 utensili da 1/4"
- FG 102/21E: Modulo chiavi a bussola esagonali 1/2" 8-32mm + accessori

2° CASSETTO



- FG 102/48G: Modulo 52 inserti - attacco 10mm
- FG 102/VA1: Modulo porta minuterie
- FG 102/65B: Modulo pinza autobloccante e pinza regolabile a cerniera aperta

3° CASSETTO



- FG 102/45D: Modulo 6 giraviti a taglio e croce
- FG 102/45I: Modulo 6 giraviti Torx
- FG 102/39D: Modulo 3 pinze



SISTEMA DI APERTURA A BAIONETTA

FG 101D/AS196

€ LISTINO
~~2.127,00~~

PROMO
799,00€

**CARRELLO PORTA UTENSILI A 7 CASSETTI MOD. FG 101
CON ASSORTIMENTO 196 UTENSILI IN MODULI RIGIDI**

ASSORTIMENTO 196 UTENSILI



1° CASSETTO



- FG 102/03G: Modulo 14 chiavi combinate 6 - 19mm
- FG 102/17E: Modulo 65 utensili da 1/4"
- FG 102/21B: Modulo chiavi a bussola esagonali 1/2" 8-32mm + accessori

2° CASSETTO



- FG 102/39D: Modulo 3 pinze
- FG 102/45I: Modulo 6 giraviti con impronta Torx
- FG 102/45D: Modulo 6 giraviti a taglio e croce

3° CASSETTO



- FG 102/48G: Modulo 52 inserti - attacco 10mm
- FG 102/60D: Modulo utensili per manutenzione
- FG 102/23C: Modulo 14 utensili rinforzati da 1/2"

4° CASSETTO



- FG 618/A8, A10, A13, A17, A19: Chiavi a T esagonali snodate





CARRELLI E BANCHI DA LAVORO

FG 102V/AS205

€ LISTINO
~~2.558,00~~

PROMO
999,00€

CARRELLO PORTA UTENSILI A 7 CASSETTI MOD. FG 102
CON ASSORTIMENTO 205 UTENSILI IN MODULI RIGIDI



CODICE

FG 102D/AS205	FG 102B/AS205	FG 102R/AS205	FG 102V/AS205
---------------	---------------	---------------	---------------



ASSORTIMENTO 205 UTENSILI

1° CASSETTO



- FG 102/03G: Modulo 14 chiavi combinate 6 - 19mm
- FG 102/17: Modulo 11 chiavi a bussola da 1/4" 4-14mm + accessori
- FG 102/21B: Modulo chiavi a bussola esagonali 1/2" 8-32mm + accessori

2° CASSETTO



- FG 102/21TX: Modulo 44 utensili Torx
- FG 102/21H: Modulo rigido inserti a bussola 1/2" esagonali e XZN
- FG 102/39D: Modulo 3 pinze

3° CASSETTO



- FG 102/45F: Modulo 6 giraviti a croce Phillips
- FG 102/45G: Modulo 7 giraviti a intaglio
- FG 102/48G: Modulo 52 inserti - attacco 10mm

4° CASSETTO

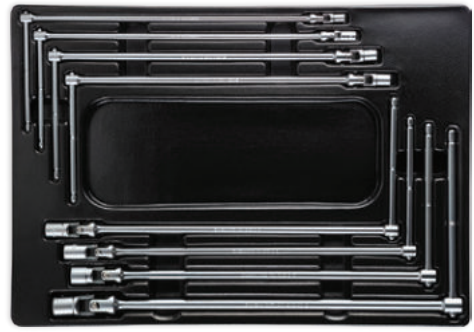

- FG 102/10C: Modulo 8 chiavi a T snodate esagonali 7-19mm

TOP IN GOMMA



FG 122V/AS170

€ LISTINO
2.805,00

PROMO
1.099,00€

NEW

CARRELLO PORTA UTENSILI A 7 CASSETTI MOD. FG 122 CON ASSORTIMENTO 170 UTENSILI IN MODULI RIGIDI



CODICE

FG 122V/AS170	FG 122D/AS170	FG 122B/AS170	FG 122R/AS170
---------------	---------------	---------------	---------------

ASSORTIMENTO 170 UTENSILI

1° CASSETTO



- FG 102/03G: Modulo 14 chiavi combinate 6 - 19mm
- FG 102/03L: Modulo 6 chiavi combinate
- FG 102/51H: Modulo 7 chiavi maschio esagonali

2° CASSETTO



- FG 102/17E: Modulo 65 utensili da 1/4"
- FG 102/21B: Modulo chiavi a bussola esagonali 1/2" 8-32mm + accessori
- FG 102/21H: Modulo rigido inserti a bussola 1/2" esagonali e XZN

3° CASSETTO



- FG 102/45F: Modulo 6 giraviti a croce Phillips
- FG 102/45G: Modulo 7 giraviti a intaglio
- FG 102/56C: Modulo utensili a percussione

4° CASSETTO



- FG 102/42C: Modulo 4 pinze per anelli elastici
- FG 102/39XT: Modulo 3 pinze - serie industrial
- FG 102/65B: Modulo pinza autobloccante e pinza regolabile a cerniera aperta



**4 RUOTE IN GOMMA
VULCANIZZATA Ø125mm
(2 FISSE E 2 GIREVOLI
1 CON FRENO)**





CARRELLI E BANCHI DA LAVORO

FG 122V/AS212

€ LISTINO
~~2.300,00~~

PROMO
1.099,00€

CARRELLO PORTA UTENSILI A 7 CASSETTI MOD. FG 122
CON ASSORTIMENTO 212 UTENSILI IN MODULI RIGIDI

NEW



CODICE

FG 122V/AS212	FG 122D/AS212	FG 122B/AS212	FG 122R/AS212
---------------	---------------	---------------	---------------

ASSORTIMENTO 212 UTENSILI

1° CASSETTO



- FG 102/03G: Modulo 14 chiavi combinate 6 - 19mm
- FG 102/03L: Modulo 6 chiavi combinate
- FG 102/21B: Modulo chiavi a bussola esagonali 1/2" 8-32mm + accessori

2° CASSETTO



- FG 102/17E: Modulo 65 utensili da 1/4"
- FG 102/19: Modulo utensili con attacco quadro 3/8"
- FG 102/45I: Modulo 6 giraviti con impronta Torx

3° CASSETTO



- FG 102/39XT: Modulo 3 pinze - serie industrial
- FG 102/42C: Modulo 4 pinze per anelli elastici
- FG 102/45E: Modulo 8 giraviti ad intaglio e a croce Phillips

4° CASSETTO



- FG 102/56C: Modulo utensili a percussione
- FG 102/65B: Modulo pinza autobloccante e pinza regolabile a cerniera aperta
- FG 102/48G: Modulo inserti corti e lunghi con attacco 10mm

CASSETTO
CON APERTURA
TOTALE



FG 100V/AS183

€/LISTINO
2.685,00

PROMO
1.199,00€

**CARRELLO PORTA UTENSILI A 7 CASSETTI MOD. FG 100
CON ASSORTIMENTO 183 UTENSILI IN MODULI RIGIDI**



CODICE

FG 100V/AS183	FG 100B/AS183	FG 100R/AS183	FG 100D/AS183	FG 100W/AS183
---------------	---------------	---------------	---------------	---------------

ASSORTIMENTO 183 UTENSILI

1° CASSETTO



- FG 102/03G: Modulo 14 chiavi combinate 6 - 19mm
- FG 102/03L: Modulo 6 chiavi combinate
- FG 102/21B: Modulo chiavi a bussola esagonali 1/2" 8-32mm + accessori

2° CASSETTO



- FG 102/17: Modulo 11 chiavi a bussola da 1/4" 4-14mm + accessori
- FG 102/48G: modulo inserti corti e lunghi con attacco 10mm
- FG 102/21TX: Modulo 44 utensili con impronta Torx

3° CASSETTO



- FG 102/39XT: Modulo 3 pinze - serie Industrial
- FG 102/45D: Modulo 6 giraviti taglio e croce
- FG 102/45I: Modulo 6 giraviti con impronta Torx

4° CASSETTO



- FG 102/10C: Modulo 8 chiavi a T snodate esagonali 7-19mm



**MANIGLIONE
INTEGRATO
IN ACCIAIO**





CARRELLI E BANCHI DA LAVORO

FG 100V/AS371

€/LISTINO
~~3.784,80~~

PROMO
1.399,00€

CARRELLO PORTA UTENSILI A 7 CASSETTI MOD. FG 100
CON ASSORTIMENTO 371 UTENSILI IN MODULI RIGIDI



CODICE

FG 100V/AS371	FG 100B/AS371	FG 100R/AS371	FG 100D/AS371	FG 100W/AS371
---------------	---------------	---------------	---------------	---------------

ASSORTIMENTO 371 UTENSILI

1° CASSETTO



- FG 102/03G: Modulo 14 chiavi combinate 6 - 19mm
- FG 102/03L: Modulo 6 chiavi combinate
- FG 102/03E: Modulo 8 chiavi doppia forchetta + FG 139C/FS

2° CASSETTO



- FG 102/17E: Modulo 65 utensili da 1/4"
- FG 102/19: Modulo utensili con attacco quadro 3/8"
- FG 102/21B: Modulo chiavi a bussola esagonali 1/2" 8-32mm + accessori

3° CASSETTO



- FG 102/21TX: Modulo 44 utensili con impronta Torx
- FG 102/21H: Modulo rigido inserti a bussola 1/2" esagonali e XZN
- FG 102/21R: Modulo inserti a bussola ribe con attacco 1/2"

4° CASSETTO



- FG 102/56C: Modulo utensili da percussione
- FG 102/39XT: Modulo 3 pinze - serie Industrial
- FG 102/42C: Modulo 4 pinze per anelli elastici

5° CASSETTO



- FG 102/45G: Modulo 7 giraviti ad taglio
- FG 102/45F: Modulo 6 giraviti a croce Phillips
- FG 102/45I: Modulo 6 giraviti con impronta Torx

6° CASSETTO



- FG 102/48G: Modulo 52 inserti - attacco 10mm
- FG 102/65B: Modulo pinza autobloccante e pinza regolabile a cerniera aperta
- FG 102/23C: Modulo 14 utensili rinforzati da 1/2"
- FG 85/S31: Set 30 inserti + porta inserti



FG 124V/AS257

€ LISTINO
3.448,00

PROMO
1.499,00€

CARRELLO PORTA UTENSILI A 7 CASSETTI MOD. FG 124 CON ASSORTIMENTO 257 UTENSILI IN MODULI RIGIDI

NEW



CODICE

FG 124V/AS257	FG 124D/AS257	FG 124B/AS257	FG 124R/AS257
---------------	---------------	---------------	---------------

ASSORTIMENTO 257 UTENSILI

1° CASSETTO



- FG 102/03H: Modulo rigido 18 chiavi combinate
- FG 102/03E: Modulo rigido 8 chiavi a doppia forchetta + FG 139C/FS
- FG 102/07C: Modulo 7 chiavi doppie poligonali

2° CASSETTO



- FG 102/17E: Modulo 65 utensili da 1/4"
- FG 102/21TX: Modulo 44 utensili con impronta Torx
- FG 102/21B: Modulo chiavi a bussola esagonali 1/2" 8-32mm + accessori
- FG 102/48G: Modulo 52 inserti - attacco 10mm

3° CASSETTO



- FG 102/42C: Modulo 4 pinze per anelli elastici
- FG 102/39XT: Modulo 3 pinze - serie Industrial
- FG 102/45D: Modulo 6 giraviti taglio e croce
- FG 102/45I: Modulo 6 giraviti con impronta Torx

4° CASSETTO



- FG 102/65B: Modulo pinza autobloccante e pinza regolabile a cerniera aperta
- FG 102/10C: Modulo 8 chiavi a T snodate esagonali 7-19mm

**MANIGLIA
IN ACCIAIO 20/10**





CARRELLI E BANCHI DA LAVORO

FG 102/03G

€/LISTINO
~~140,00~~

PROMO
85,00€

MODULO 14 CHIAVI COMBinate IN MM
FG 600/B6,7,8,9,10,11,12,13, 14,15,16,17,18,19mm

1/3



FG 102/07C

€/LISTINO
~~92,00~~

PROMO
59,90€

MODULO 7 CHIAVI DOPPIE POLIGONALI
FG 615/B6x7, 8x9, 10x11,12x13, 14x15, 16x17, 18x19mm

1/3



FG 102/03L

€/LISTINO
~~145,00~~

PROMO
89,00€

MODULO 6 CHIAVI COMBinate
FG 600/B21, 22, 24, 27, 30, 32 mm

1/3



FG 102/07D

€/LISTINO
~~138,00~~

PROMO
83,90€

MODULO 5 CHIAVI DOPPIE POLIGONALI
FG 615/B20x22, 21x23, 24x27, 25x28, 30x32mm

1/3

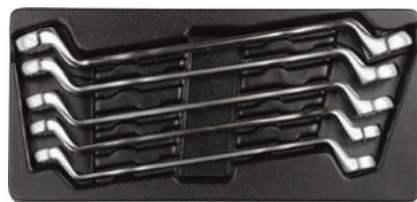

FG 102/03H

€/LISTINO
~~250,00~~

PROMO
149,00€

MODULO 18 CHIAVI COMBinate IN MM
FG 600/B6,7,8,10,11,12,13,14,16,17,18,19, 21, 22, 24, 27, 30, 32mm

2/3



FG 102/08C

€/LISTINO
~~245,00~~

PROMO
149,00€

MODULO 11 CHIAVI A CRICCO REVERSIBILE
FG 605/B8, 10, 11, 12, 13, 14, 15, 16, 17, 18, 19mm

1/3



FG 102/10C

€/LISTINO
~~340,00~~

PROMO
209,00€

MODULO 8 CHIAVI A T SNODATE
FG 618/A7, 8, 10, 11, 13, 14, 17, 19 mm

1/1



FG 102/03E

€/LISTINO
~~85,00~~

PROMO
51,90€

MODULO 8 CHIAVI DOPPIA FORCHETTA
FG 602/B6x7, 8x9, 10x11, 12x13, 14x15, 16x17, 18x19, 20x22 mm + FG 139C/FS

1/3



FG 102/03F

€/LISTINO
~~100,00~~

PROMO
59,90€

MODULO 5 CHIAVI DOPPIA FORCHETTA
FG 602/B21x23, 24x26, 25x28, 27x29, 30x32 mm

1/3



FG 102/13C

€/LISTINO
~~185,00~~

PROMO
115,00€

MODULO 10 CHIAVI A PIPA 6X12PT
FG 613/A6,7,8,10,11,12,13,14,17,19mm

1/3



FG 102/17

€/LISTINO
~~135,00~~

PROMO
79,90€

MODULO CHIAVI A BUSSOLA ESAGONALI

FG 615/B6x7, 8x9, 10x11,12x13, 14x15, 16x17, 18x19mm



1/3

1/4"



1/3

1/2"



MODULO CHIAVI A BUSSOLA
10-32mm



CODICE	ATTACCO	€/LISTINO	€/PROMO
FG 102/21E	Esagonale	170,00€	99,00€
FG 102/21D	Poligonale	170,00€	99,00€

FG 102/17E

€/LISTINO
~~275,00~~

PROMO
169,00€

MODULO CHIAVI A BUSSOLA ESAGONALI

FG 605/B8, 10, 11, 12, 13, 14, 15, 16, 17, 18, 19mm



1/3

1/4"



FG 102/21TX

€/LISTINO
~~245,00~~

PROMO
149,00€

MODULO UTENSILI CON IMPRONTA TORX



1/3

1/2"



FG 102/19

€/LISTINO
~~200,00~~

PROMO
119,00€

MODULO CHIAVI A BUSSOLA ESAGONALI

8-23mm Esagonali



1/3

3/8"



1/3

1/2"



FG 102/21H

€/LISTINO
~~210,00~~

PROMO
129,00€

MODULO INSERTI A BUSSOLA

FG 150/H2-H8, FG 150L/H2-H8, FG 150/M5-M16, FG 150L/M5-M16



1/3

1/2"



FG 102/19B

€/LISTINO
~~200,00~~

PROMO
119,00€

MODULO CHIAVI A BUSSOLA POLIGONALI

8- 23mm Poligonali



1/3

1/2"



1/3

1/2"



FG 102/21R

€/LISTINO
~~230,00~~

PROMO
139,00€

MODULO INSERTI A BUSSOLA RIBE

FG 150/R4-R14, FG 150L/R4-R14, FG 150/R4-R14, FG 150L/R4-R14



1/3

1/2"



MODULO CHIAVI A BUSSOLA

10-32mm



1/3

1/2"



1/2

3/4"



MODULO CHIAVI A BUSSOLA ESAGONALI
34-50mm



CODICE	ATTACCO	€/LISTINO	€/PROMO
FG 102/21B	Esagonale	245,00€	149,00€
FG 102/21C	Poligonale	255,00€	149,00€

CODICE	ATTACCO	€/LISTINO	€/PROMO
FG 102/25	Esagonale	395,00€	239,00€
FG 102/25B	Poligonale	395,00€	239,00€



CARRELLI E BANCHI DA LAVORO

FG 102/23C

€/LISTINO

~~145,50~~

PROMO
89,00€

MODULO 13 CHIAVI A BUSSOLA RINFORZATE
FG 628/C10,11,12,13,14,16,17,18,19,21,22,23,24mm
+ FG 628/PR125



1/3

1/2"



FG 102/45D

€/LISTINO

~~47,00~~

PROMO
28,90€

MODULO 6 GIRAVITI TAGLIO E CROCE
FG 22/3x100, 4x125, 5.5x150, 6.5x150,
FG 22/PH1x80, PH2x150



1/3



FG 102/51H

€/LISTINO

~~130,00~~

PROMO
79,90€

MODULO 7 CHIAVI MASCHIO ESAGONALI
FG 621/H2, 2.5, 3, 4, 5, 6, 8mm



1/3



FG 102/45E

€/LISTINO

~~57,00~~

PROMO
34,90€

MODULO 8 GIRAVITI TAGLIO E CROCE
3x100, 4x125, 5.5x150, 6.5x150, 6.5x38,
PH1x80, PH2x150, PH2x38



1/3



FG 102/39XT

€/LISTINO

~~102,00~~

PROMO
59,90€

MODULO 3 PINZE - SERIE INDUSTRIAL
FG 59/XT180 - FG 61/XT160 - FG 63XT160



1/3

FG 102/45F

€/LISTINO

~~54,00~~

PROMO
32,90€

MODULO 6 GIRAVITI A CROCE PHILLIPS
PH0x60, PH1x150, PH2x100, PH2x150, PH3x150, PH2x38



1/3



FG 102/39D

€/LISTINO

~~75,00~~

PROMO
45,90€

MODULO 3 PINZE
FG 59PV/180, FG 61PV/160, FG 63PV/160



1/3

FG 102/45G

€/LISTINO

~~54,00~~

PROMO
32,90€

MODULO 7 GIRAVITI A TAGLIO
2.5x60, 3x100, 3.5x100, 4x125, 5.5x150, 5.5x100, 6.5x150



1/3



MODULO 4 PINZE PER ANELLI ELASTICI INTERNI ED ESTERNI



1/3

FG 102/45U

€/LISTINO

~~92,00~~

PROMO
59,90€

MODULO 12 GIRAVITI TAGLIO E CROCE



2/3



CODICE	CAPACITÀ	€/LISTINO	€/PROMO
FG 102/41C	8-25mm	98,00€	59,90€
FG 102/42C	19-60mm	110,00€	65,00€

MODULO 6 GIRAVITI CON IMPRONTA TORX
TX10, TX15, TX20, TX25, TX27, TX30



1/3  

CODICE	ATTACCO	€/LISTINO	€/PROMO
FG 102/45I	Torx	66,00€	39,90€
FG 102/45L	Torx forato	67,00€	39,90€

FG 102/56C

€/LISTINO
~~125,00~~

PROMO
76,90€

MODULO UTENSILI DA PERCUSSIONE
FG 132/500, FG 136/40, FG 126/SN1, FG 126/SN3



1/3 

FG 102/60D

€/LISTINO
~~51,00~~

PROMO
29,90€

MODULO UTENSILI PER MANUTENZIONE
FG 44/MT5, FG 50/AR, FG 48/LG, FG 79/SP4, FG 497/OP1



1/3 

FG 102/45T

€/LISTINO
~~78,00~~

PROMO
45,90€

MODULO 6 GIRAVITI A BUSSOLA ESAGONALE
FG 22/FX6, FX7, FX8, FX10, FX13



1/3 

FG 102/48G

€/LISTINO
~~120,00~~

PROMO
72,90€

MODULO 52 INSERTI - ATTACCO 10MM



1/3  

FG 102/62B

€/LISTINO
~~95,00~~

PROMO
57,90€

MODULO LIME A TAGLIO MEZZODOLCE
FG 80/8AR, FG 80/8AM, FG 80/8AP, FG 80/8AT, FG 80/8AQ



1/3 

FG 102/50F

€/LISTINO
~~76,00~~

PROMO
45,90€

MODULO 6 CHIAVI MASCHIO ESAGONALI
FG 142/2, 2.5, 3, 4, 5, 6



1/3 

FG 102/65B

€/LISTINO
~~65,00~~

PROMO
39,90€

MODULO PINZE AUTOBLOCCANTI
FG 58/B240, FG 69/CJ250



1/3 

FG 102/50G

€/LISTINO
~~76,00~~

PROMO
45,90€

MODULO 6 CHIAVI MASCHIO TORX
FG 143/TX10, TX15, TX20, TX25, TX27, TX30



1/3 

FG 102/VA1

€/LISTINO
~~15,00~~

PROMO
8,90€

MODULO VUOTO PORTA MINUTERIE



1/3 



CARRELLI E BANCHI DA LAVORO

FG 122V/AS217

€/LISTINO
2.597,50

PROMO
1.099,00€

CARRELLO PORTA UTENSILI FG 122 A 6 CASSETTI
CON ASSORTIMENTO 217 UTENSILI IN MODULI DI GOMMA



CODICE

FG 122V/AS217	FG 122D/AS217	FG 122B/AS217	FG 122R/AS217
---------------	---------------	---------------	---------------

ASSORTIMENTO 217 UTENSILI

1° CASSETTO

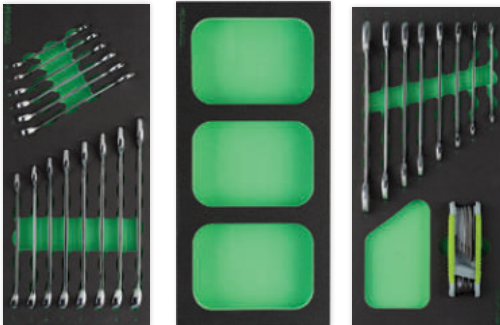

- FG 100/03G: Modulo 14 chiavi combinate 6 - 19mm
- FG 100/VA1: Modulo porta minuterie
- FG 100/03E: Modulo 8 chiavi a forchetta + set 9 chiavi maschio esagonali

2° CASSETTO



- FG 100/17: Modulo utensili con attacco quadro 1/4"
- FG 100/19: Modulo utensili con attacco quadro 3/8"
- FG 100/21B: Modulo utensili con attacco quadro 1/2"

3° CASSETTO



- FG 100/39XT: Modulo 3 pinze assortite - serie industrial
- FG 100/48E: Modulo 98 inserti con attacco 1/4" e 2 porta inserti
- FG 100/65B: Modulo pinze autobloccanti

4° CASSETTO

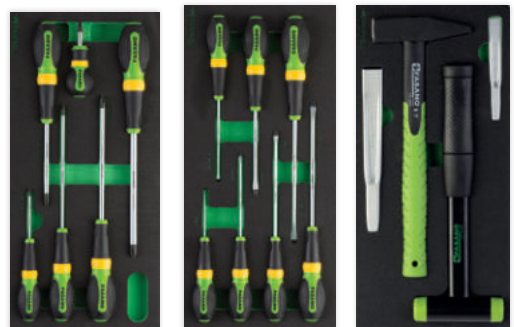

- FG 100/45F: Modulo 6 giraviti a croce Phillips
- FG 100/45G: Modulo 7 giraviti con testa ad intaglio
- FG 100/56C: Modulo utensili da percussione



**TOP SUPERIORE IN GOMMA
CON FINITURA CARBON 3D**



FG 100V/AS224

€/LISTINO
2.878,00

PROMO
1.199,00€

**CARRELLO PORTA UTENSILI FG 100 A 7 CASSETTI
CON ASSORTIMENTO 224 UTENSILI IN MODULI DI GOMMA**



CODICE

FG 100V/AS224	FG 100B/AS224	FG 100R/AS224	FG 100D/AS224	FG 100W/AS224
---------------	---------------	---------------	---------------	---------------

ASSORTIMENTO 224 UTENSILI

1° CASSETTO



- FG 100/03G: Modulo 14 chiavi combinate 6 - 19mm
- FG 100/17E: Modulo 65 utensili da 1/4"
- FG 100/21B: Modulo chiavi a bussola esagonali 1/2" 8-32mm + accessori

2° CASSETTO



- FG 100/39XT: Modulo 3 pinze assortite - serie industrial
- FG 100/VA1: Modulo porta minuterie
- FG 100/21TX: Modulo utensili torx con attacco 1/4" e 1/2"

3° CASSETTO



- FG 100/45I: Modulo 6 giraviti con impronta torx
- FG 100/45D: Modulo 6 giraviti a taglio e croce
- FG 100/48G: Modulo inserti corti e lunghi con attacco 10mm

4° CASSETTO

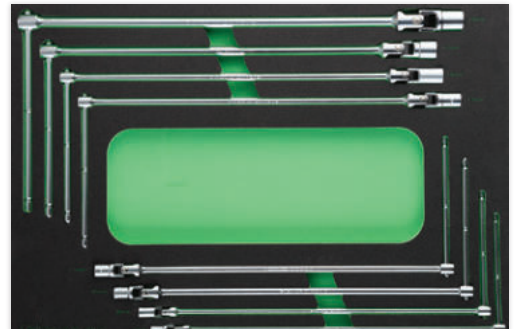

- FG 100/10C: Modulo 8 chiavi a T snodate 7-19mm



**RIPIANO SUPERIORE
IN ABS**





CARRELLI E BANCHI DA LAVORO

FG 122V/AS413

€/LISTINO
~~4.862,80~~

PROMO
1.399,00€

CARRELLO PORTA UTENSILI FG 122 A 7 CASSETTI
CON ASSORTIMENTO 413 UTENSILI IN MODULI DI GOMMA



CODICE

FG 122V/AS413	FG 122D/AS413	FG 122B/AS413	FG 122R/AS413
---------------	---------------	---------------	---------------

ASSORTIMENTO 413 UTENSILI

1° CASSETTO

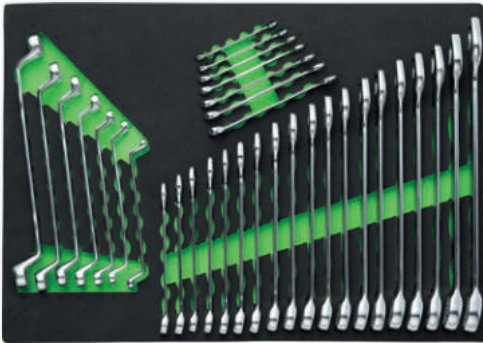

-FG 100/03M: Modulo chiavi combinate poligonali e poligonali doppie curve

2° CASSETTO



-FG 100/21F: Modulo chiavi a bussola esagonali, inserti e accessori 1/4", 3/8", 1/2"

3° CASSETTO



-FG 100/81G: Modulo inserti e chiavi a bussola 1/4" e 1/2"

4° CASSETTO

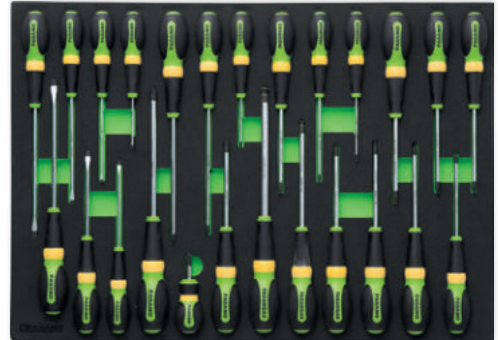

-FG 100/45R: Modulo giraviti impronte a intaglio, Phillips, esagonali sferiche e Torx

5° CASSETTO



-FG 100/39E: Modulo pinze e inserti

**MODULI IN GOMMA
A PIENO CASSETTO**



FG 100V/AS230

€/LISTINO
~~3.571,50~~

PROMO
1.399,00€

**CARRELLO PORTA UTENSILI FG 100 A 7 CASSETTI
CON ASSORTIMENTO 230 UTENSILI IN MODULI IN GOMMA**



CODICE

FG 100V/AS230	FG 100B/AS230	FG 100R/AS230	FG 100D/AS230	FG 100W/AS230
---------------	---------------	---------------	---------------	---------------

ASSORTIMENTO 230 UTENSILI

1° CASSETTO



- FG 100/03G: Modulo 14 chiavi combinate 6 - 19mm
- FG 100/03L: Modulo 6 chiavi combinate
- FG 100/03E: Modulo 8 chiavi a forchetta + set 9 chiavi maschio esagonali

2° CASSETTO

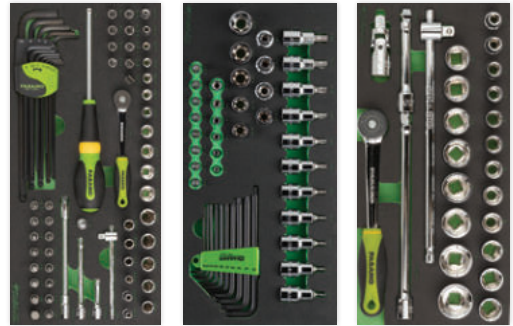

- FG 100/17E: Modulo 65 utensili da 1/4"
- FG 100/21TX: Modulo utensili torx con attacco 1/4" e 1/2"
- FG 100/21B: Modulo chiavi a bussola esagonali 1/2" 8-32mm + accessori

3° CASSETTO



- FG 100/81F: Modulo inserti a bussola con attacco quadro 1/2"
- FG 100/65B: Modulo pinze autobloccanti
- FG 100/42C: Modulo 4 pinze per anelli elastici 19-60mm

4° CASSETTO



- FG 100/39XT: Modulo 3 pinze assortite - serie industrial
- FG 100/45D: Modulo 6 giraviti a taglio e croce
- FG 100/45I: Modulo 6 giraviti con impronta torx

5° CASSETTO



- FG 100/10D: Modulo 12 chiavi a T snodate esagonali



FG 122V/AS402

€/LISTINO
~~4.819,40~~

PROMO
1.499,00€

CARRELLO PORTA UTENSILI FG 122 A 7 CASSETTI
CON ASSORTIMENTO 402 UTENSILI IN MODULI DI GOMMA



CODICE

FG 122V/AS402	FG 122D/AS402	FG 122B/AS402	FG 122R/AS402
---------------	---------------	---------------	---------------

ASSORTIMENTO 402 UTENSILI

1° CASSETTO

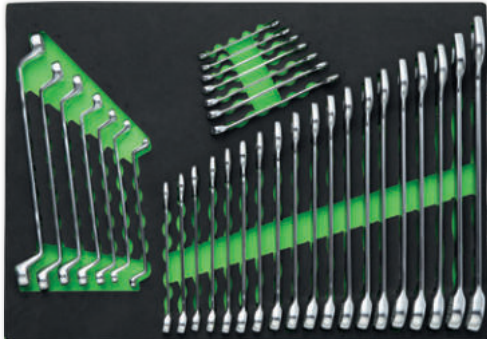

FG 100/03M: Modulo chiavi combinate poligonali e poligonali doppie curve

2° CASSETTO



-FG 100/21F: Modulo chiavi a bussola esagonali, inserti e accessori 1/4", 3/8", 1/2"

3° CASSETTO



-FG 100/81G: Modulo inserti e chiavi a bussola 1/4" e 1/2"

4° CASSETTO



-FG 100/39F: Modulo giraviti, pinze e inserti

5° CASSETTO



- FG 100/10C: Modulo 8 chiavi a T snodate 7-19m

 **FASANO**
TOOLS

FG 100VD/AS355

€/LISTINO
~~4.293,80~~

PROMO
1.599,00€

**CARRELLO BI-COLOR PORTA UTENSILI FG 100 A 7 CASSETTI
CON ASSORTIMENTO 355 UTENSILI IN MODULI IN GOMMA**



ASSORTIMENTO 355 UTENSILI

1° CASSETTO

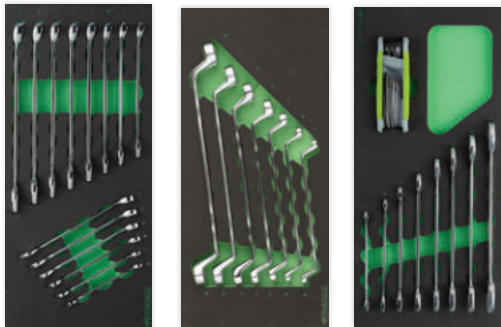

- FG 100/03G: Modulo 14 chiavi combinate 6 - 19mm
- FG 100/07C: Modulo 7 chiavi doppie poligonali
- FG 100/03E: Modulo 8 chiavi a forchetta + set 9 chiavi maschio esagonali

2° CASSETTO



- FG 100/17E: Modulo 65 utensili da 1/4"
- FG 100/19: Modulo chiavi a bussola esagonali
- FG 100/21B: Modulo chiavi a bussola esagonali 1/2" 8-32mm + accessori

3° CASSETTO



- FG 100/21TX: Modulo utensili torx con attacco 1/4" e 1/2"
- FG 100/81F: Modulo inserti a bussola esagonale e XZN
- FG 100/82B: Modulo inserti a bussola ribbe con attacco 1/2"

4° CASSETTO

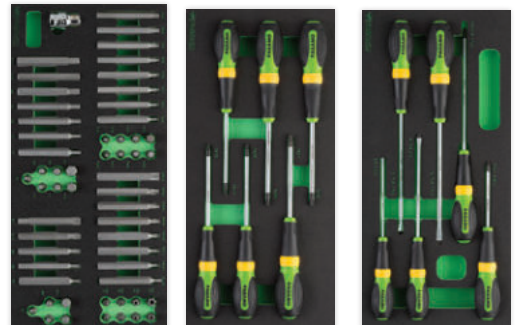

- FG 100/48G: Modulo inserti con attacco mm
- FG 100/45I: Modulo 6 giraviti Torx
- FG 100/45D: Modulo 6 giraviti a taglio e croce Phillips

5° CASSETTO



- FG 100/65B: Modulo 2 pinze
- FG 100/39XT: Modulo 3 pinze assortite -serie industrial
- FG 100/42C: Modulo 4 pinze per anelli elastici 19-60mm

6° CASSETTO

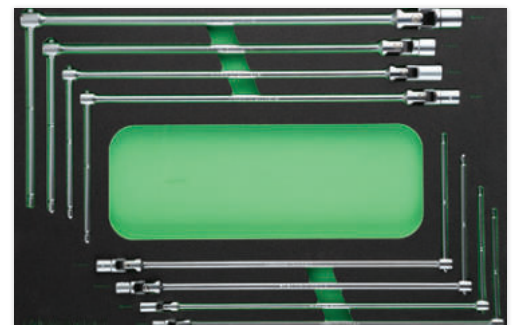

- FG 100/10C: Modulo 8 chiavi a T snodate 7-19m
- FG 85/S31: Set 30 inserti + porta inserti



CARRELLI E BANCHI DA LAVORO

FG 124V/AS322

€ LISTINO
3.926,50

PROMO
1.599,00€

**CARRELLO PORTA UTENSILI FG 124 A 7 CASSETTI
CON ASSORTIMENTO 322 UTENSILI IN MODULI DI GOMMA**



CODICE

FG 124V/AS322	FG 124D/AS322	FG 124B/AS322	FG 124R/AS322
---------------	---------------	---------------	---------------

ASSORTIMENTO 322 UTENSILI

1° CASSETTO



- FG 100/03G: Modulo 14 chiavi combinate 6 - 19mm
- FG 100/03L: Modulo 6 chiavi combinate 21, 22, 24, 27, 30, 32 mm
- FG 100/VA4: Modulo porta minuteria
- FG 100/21H: Modulo chiavi a bussola esagonali

2° CASSETTO

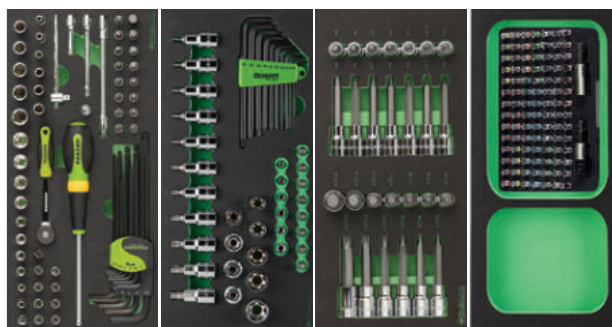

- FG 100/17E: Modulo 65 utensili da 1/4"
- FG 100/21TX: Modulo utensili torx con attacco 1/4" e 1/2"
- FG 100/81F: Modulo inserti a bussola esagonali e XZN 1/2"
- FG 100/48E: Modulo 98 inserti con attacco 1/4" e 2 porta inserti

3° CASSETTO



- FG 100/42C: Modulo 4 pinze per anelli elastici 19-60mm
- FG 100/39XT: Modulo 3 pinze assortite - serie industrial
- FG 100/45D: Modulo 6 giraviti a taglio e croce
- FG 100/45I: Modulo 6 giraviti con impronta Torx

4° CASSETTO

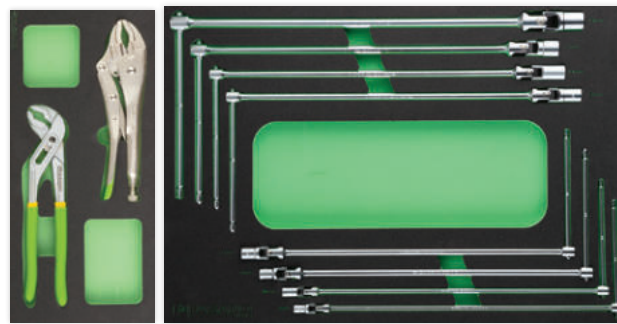

- FG 100/65B: Modulo pinze autobloccanti
- FG 100/10C: Modulo 8 chiavi a T snodate 7-19mm



**MANIGLIONE
IN ACCIAIO INOX**

FG 162V/AS308

€LISTINO
6.163,50

PROMO
2.799,00€

**CARRELLO PORTA UTENSILI FG 162 A 14 CASSETTI
CON ASSORTIMENTO 308 UTENSILI IN MODULI DI GOMMA**



CODICE

FG 162V/AS308	FG 162B/AS308	FG 162R/AS308	FG 162D/AS308
---------------	---------------	---------------	---------------

ASSORTIMENTO 308 UTENSILI

1° CASSETTO

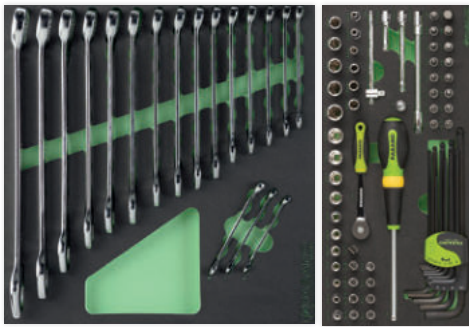

- FG 100/03H: Modulo 18 chiavi combinate in mm
- FG 100/17E: Modulo 65 utensili da 1/4"

2° CASSETTO



- FG 100/21B: Modulo chiavi a bussola esagonali 1/2" 8-32mm + accessori
- FG 100/21TX: Modulo utensili torx con attacco 1/4" e 1/2"
- FG 100/19: Modulo utensili con attacco quadro 3/8"

3° CASSETTO

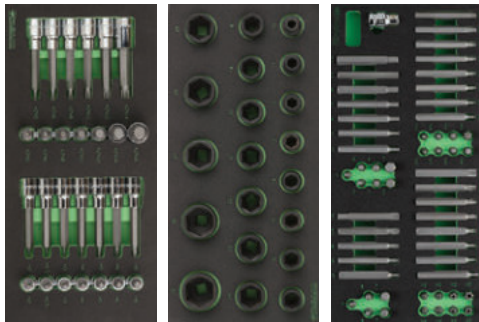

- FG 100/81F: Modulo inserti a bussola con attacco quadro 1/2"
- FG 100/23C: Modulo 20 chiavi a bussola rinforzate
- FG 100/48C: Modulo inserti corti e lunghi con attacco 10mm

4° CASSETTO

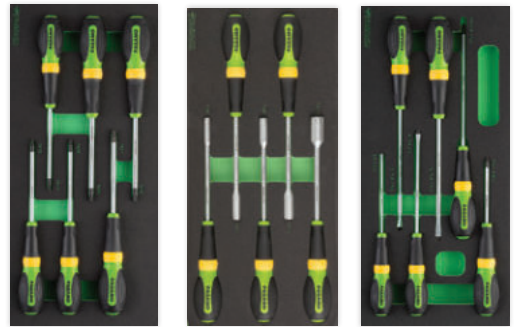

- FG 100/45I: Modulo 6 giraviti con impronta Torx
- FG 100/45T: Modulo 5 giraviti a bussola esagonali
- FG 100/45D: Modulo 6 giraviti a taglio e croce

5° CASSETTO

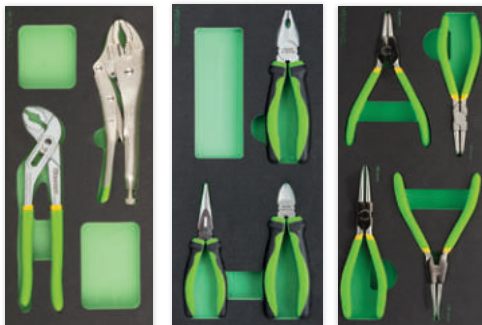

- FG 100/65B: Modulo pinze autobloccanti
- FG 100/39XT: Modulo 3 pinze assortite - serie industrial
- FG 100/42C: Modulo 4 pinze per anelli elastici 19-60mm

6° CASSETTO

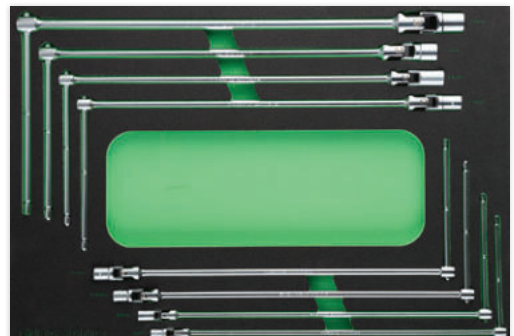

- FG 100/10C: Modulo 8 chiavi a T snodate 7-19mm



CARRELLI E BANCHI DA LAVORO

MODULO 14 CHIAVI COMBinate IN MM
FG 600/B6,7,8,9,10,11,12,13,14,15,16,17,18,19mm



1/3

CODICE	CHIAVE	€/LISTINO	€/PROMO
FG 100/03G	FG 600/B	160,00€	95,00€
FG 100/03G-A	FG 600/A	170,00€	99,90€

MODULO 6 CHIAVI COMBinate IN MM
FG 600/B21,22,24,27,30,32mm



1/3

CODICE	CHIAVE	€/LISTINO	€/PROMO
FG 100/03L	FG 600/B	158,00€	95,00€
FG 100/03L-A	FG 600/A	168,00€	99,90€

MODULO 18 CHIAVI COMBinate IN MM
FG 600/B6,7,8,10,11,12,13,14,16,17,18,19,21,22,24,27,30,32mm



2/3

CODICE	CHIAVE	€/LISTINO	€/PROMO
FG 100/03H	FG 600/B	310,00€	189,00€
FG 100/03H-A	FG 600/A	320,00€	195,00€

FG 100/03E

€/LISTINO
~~98,00~~

PROMO
59,90€

MODULO 8 CHIAVI DOPPIA FORCHETTA
FG 602/B6x7,8x9,10x11,12x13,14x15,16x17,18x19,20x22 mm + FG 139C/FS

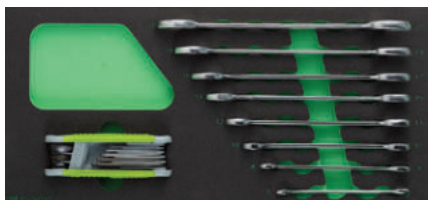

1/3

FG 100/03F

€/LISTINO
~~110,00~~

PROMO
64,90€

MODULO 5 CHIAVI DOPPIA FORCHETTA
FG 602/B21x23,24x26,25x28,27x29,30x32 mm



1/3

FG 100/07C

€/LISTINO
~~112,00~~

PROMO
65,90€

MODULO 7 CHIAVI DOPPIE POLIGONALI
FG 615/B6x7,8x9,10x11,12x13,14x15,16x17,18x19mm

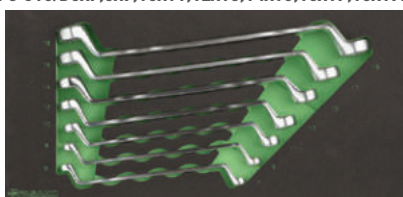

1/3

FG 100/07D

€/LISTINO
~~160,00~~

PROMO
97,90€

MODULO 5 CHIAVI DOPPIE POLIGONALI
FG 615/B20x22,21x23,24x27,25x28,30x32mm



1/3

FG 100/08C

€/LISTINO
~~265,00~~

PROMO
149,00€

MODULO 8 CHIAVI A CRICCHETTO
FG 605/B8,10,11,12,13,14,15,16,17,18,19mm



1/3

FG 100/10C

€/LISTINO
~~390,00~~

PROMO
239,00€

MODULO 8 CHIAVI A T SNODATE
FG 618/A7,8,10,11,13,14,17,19 mm

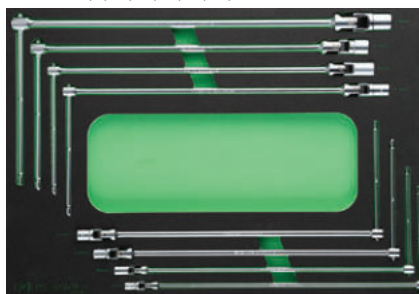

1/1

FG 100/10D

€/LISTINO
~~570,00~~

PROMO
349,00€

MODULO 12 CHIAVI A T SNODATE
FG 618/A7,8,10,11,12,13,14,15,16,17,18,19 mm



1/1

FG 100/17

€/LISTINO
~~145,00~~

PROMO
85,00€

MODULO CHIAVI A BUSSOLA ESAGONALI
4-14mm



1/3

1/4"

FG 100/17E

€/LISTINO
~~290,00~~

PROMO
175,00€

MODULO CHIAVI A BUSSOLA ESAGONALI



1/3

1/4"

FG 100/18

€/LISTINO
~~295,00~~

PROMO
179,00€

MODULO CHIAVI A BUSSOLA ESAGONALI
9-19mm



1/3

3/8"

FG 100/19

€/LISTINO
~~240,00~~

PROMO
145,00€

MODULO CHIAVI A BUSSOLA ESAGONALI
9-19mm



1/3

3/8"

MODULO CHIAVI A BUSSOLA ESAGONALI
10-32mm



1/3

1/2"

CODICE	ATTACCO	€/LISTINO	€/PROMO
FG 100/21B	Esagonale	250,00€	149,00€
FG 100/21C	Poligonale	250,00€	149,00€

MODULO CHIAVI A BUSSOLA ESAGONALI
10-32mm

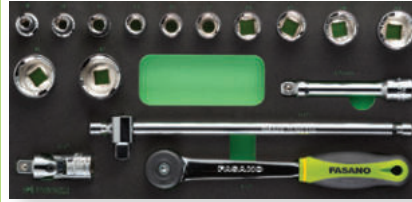

1/3

1/2"

CODICE	ATTACCO	€/LISTINO	€/PROMO
FG 100/21M	Esagonale	170,00€	99,00€
FG 100/21D	Poligonale	170,00€	99,00€

FG 100/21H

€/LISTINO
~~440,00~~

PROMO
269,00€

MODULO CHIAVI A BUSSOLA ESAGONALI
Bussole corte: 8-32 mm (esclusa 25mm)
Bussole lunghe: 10-32 mm

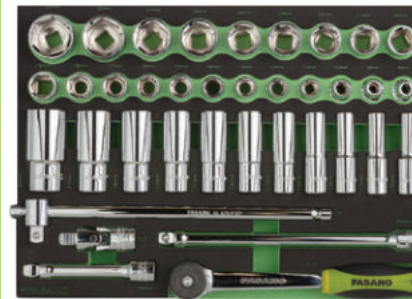

2/3

1/2"

FG 100/21TX

€/LISTINO
~~270,00~~

PROMO
159,00€

MODULO UTENSILI CON IMPRONTA TORX

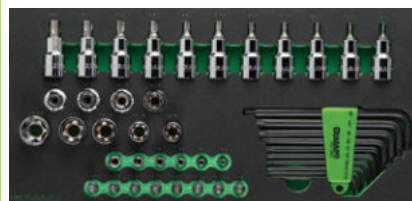

1/3

1/4"

1/2"

FG 100/81F

€/LISTINO
~~200,00~~

PROMO
119,00€

MODULO INSERTI A BUSSOLA
FG 150/H2-H8, FG 150L/H2-H8,
FG 150/M5-M16, FG 150L/M5-M14

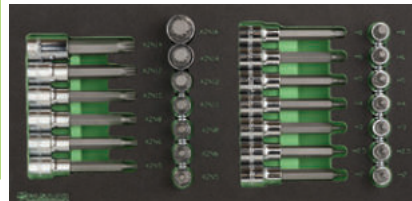

1/3

1/2"



CARRELLI E BANCHI DA LAVORO

FG 100/23C

€/LISTINO
~~220,00~~

PROMO
135,00€

MODULO 20 CHIAVI A BUSSOLA RINFORZATE

FG 628/C10, 11, 12, 13, 14, 15, 16, 17, 18, 19, 21, 22, 23, 24, 25, 26, 27, 30, 32mm



1/3

1/2"



FG 100/65C

€/LISTINO
~~136,00~~

PROMO
82,90€

MODULO PINZE AUTOBLOCCANTI

FG 70/CJ250 - FG 58/A240 - FG 49/HE250



1/3

FG 100/23B

€/LISTINO
~~360,00~~

PROMO
219,00€

MODULO 19 CHIAVI A BUSSOLA RINFORZATE

FG 628/L10, 11, 12, 13, 14, 15, 16, 17, 18, 19, 21, 22, 23, 24, 25, 27, 29, 30, 32mm



1/3

1/2"



FG 100/45D

€/LISTINO
~~69,00~~

PROMO
41,90€

MODULO 6 GIRAVITI TAGLIO E CROCE

FG 22/3x100, 4x125, 5.5x200, 6.5x150, FG 22/PH1x80, PH2x150



1/3



FG 100/39XT

€/LISTINO
~~110,00~~

PROMO
66,90€

MODULO 3 PINZE ASSORTITE - SERIE INDUSTRIAL

FG 59/XT180 - FG 61/XT160 - FG 63/XT160



1/3

FG 100/45E

€/LISTINO
~~84,00~~

PROMO
49,90€

MODULO 8 GIRAVITI TAGLIO E CROCE

3x100, 4x125, 5.5x150, 6.5x150, 6.5x38, PH1x80, PH2x150, PH2x38



1/3



MODULO 4 PINZE PER ANELLI ELASTICI INTERNI ED ESTERNI



1/3

FG 100/45F

€/LISTINO
~~70,00~~

PROMO
42,90€

MODULO 6 GIRAVITI A CROCE PHILLIPS

PH0x60, PH1x150, PH2x100, PH2x150, PH3x150, PH2x38



1/3



CODICE	CAPACITÀ	€/LISTINO	€/PROMO
FG 100/41C	8-25mm	113,00€	67,90€
FG 100/42C	19-60mm	118,00€	71,90€

FG 100/65B

€/LISTINO
~~93,50~~

PROMO
54,90€

MODULO PINZE AUTOBLOCCANTI

FG 58/B240, FG 69/CJ250



1/3

FG 100/45G

€/LISTINO
~~70,00~~

PROMO
42,90€

MODULO 7 GIRAVITI A TAGLIO

2.5x60, 3x100, 3.5x100, 4x125, 5.5x150, 5.5x100, 6.5x150



1/3



FG 100/45I

€/LISTINO

~~85,00~~

PROMO
51,90€

MODULO 6 GIRAVITI CON IMPRONTA TORX
TX10, TX15, TX20, TX25, TX27, TX30



1/3



FG 100/50F

€/LISTINO

~~90,00~~

PROMO
54,90€

MODULO 6 CHIAVI MASCHIO ESAGONALI
FG 142/2, 2.5, 3, 4, 5, 6

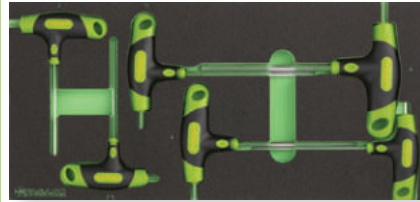

1/3



FG 100/45T

€/LISTINO

~~88,00~~

PROMO
52,90€

MODULO 5 GIRAVITI A BUSSOLA ESAGONALE
FG 22/FX6, FX7, FX8, FX10, FX13

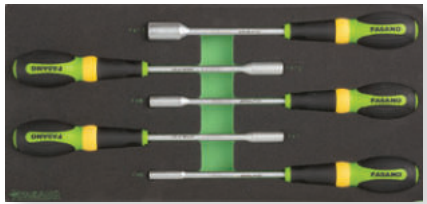

1/3



FG 100/50G

€/LISTINO

~~90,00~~

PROMO
54,90€

MODULO 6 CHIAVI MASCHIO TORX
FG 143/TX10, TX15, TX20, TX25, TX27, TX30

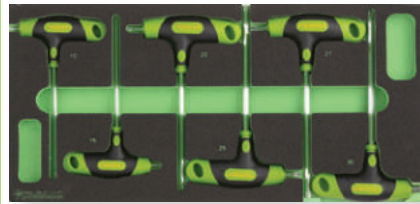

1/3



FG 100/45H

€/LISTINO

~~80,00~~

PROMO
49,00€

MODULO 5 GIRAVITI EXTRA LUNGI
FG 22/2.5x300, 4x400, 5.5x400, FG 22/PH1x400, PH2x400

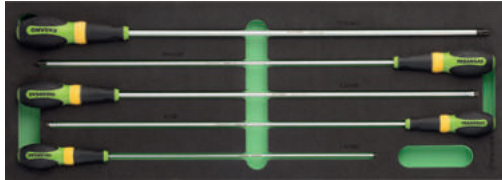

1/2



FG 100/56C

€/LISTINO

~~135,00~~

PROMO
82,90€

MODULO UTENSILI DA PERCUSSIONE
FG 132/500, FG 136/40 - FG 126/SN1, FG 126/SN3



1/3

FG 100/48G

€/LISTINO

~~130,00~~

PROMO
79,90€

MODULO 52 INSERTI - ATTACCO 10MM

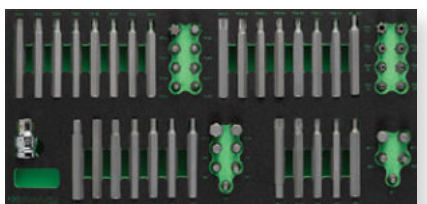

1/3

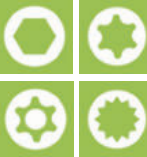

FG 100/54

€/LISTINO

~~180,00~~

PROMO
109,00€

MODULO 5 UTENSILI DI MISURAZIONE
FG 95/CA, FG 188/2, FG 95/M1, FG 81/PT1, FG 44/MT5



1/3

FG 100/51H

€/LISTINO

~~145,00~~

PROMO
89,00€

MODULO 7 CHIAVI MASCHIO ESAGONALI
FG 621/H2, 2.5, 3, 4, 5, 6, 8mm

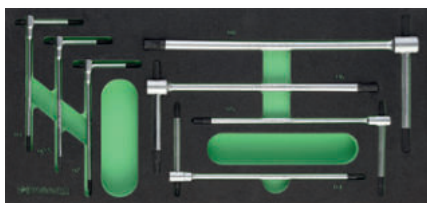

1/3



FG 100/76C

€/LISTINO

~~275,00~~

PROMO
169,00€

MODULI TAPPI E CHIAVI FILTRO OLIO
FG 176/F01 - FG 176/RE - FG 175/S15



1/3



MODULI IN GOMMA A PIENO CASSETTO

IMPRONTA BI COLORE

SPECIFICHE DELL' UTENSILE IMPRESSO CON LASER, PER TROVARE A COLPO D'OCCHIO TUTTO CIÓ CHE SERVE E RISPARMIARE TEMPO



FG 100/03M

MODULO CHIAVI COMBinate POLIGONALI E POLIGONALI
DOPPIE CURVE

33
PEZZI

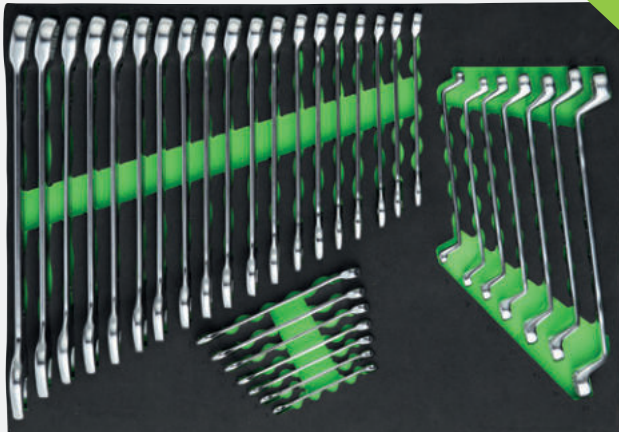

FG 600/B

Chiaavi combinate poligonali
6, 7, 8, 9, 10, 11, 12, 13, 14, 15, 16, 17, 18, 19, 20, 21, 22, 23, 24, 25,
26, 27, 28, 29, 30, 32



FG 615/B

Chiaavi poligonali doppie curve
6x7, 8x9, 10x11, 12x13, 14x15, 16x17, 18x19



€/LISTINO

~~565,00~~

PROMO

279,00€

FG 100/45R

MODULO GIRAVITI IMPRONTE A INTAGLIO, PHILLIPS,
ESAGONALI SFERICHE E TORX

25
PEZZI

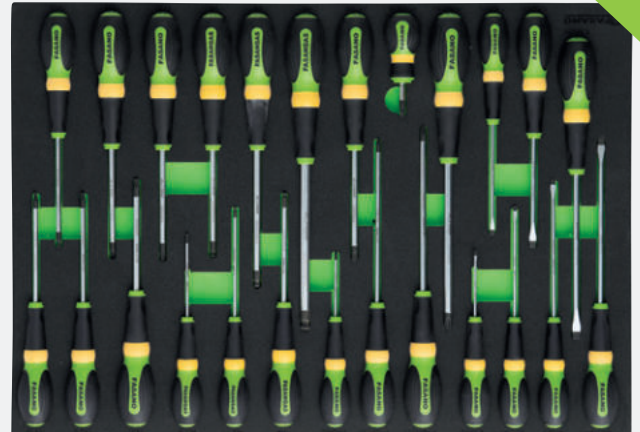

FG 22/PH

Giraviti per viti con testa a croce Phillips
0x60, 1x150, 2x100, 2x150, 3x150



FG 22/PH

Giravite per viti con testa a croce Phillips - serie Stubby
2x30



FG 22/

Giraviti per viti con testa a intaglio
2.5x60, 3x100, 3.5x100, 4x125, 5.5x150, 5.5x100, 6.5x150



FG 22/TX

Giraviti per viti con impronta Torx
10, 15, 20, 25, 27, 30



FG 22/H

Giraviti per viti con impronta esagonale sferica
2.5, 3, 4, 5, 6, 8



€/LISTINO

~~276,40~~

PROMO

159,00€

FG 100/39F
MODULO GIRAVITI, PINZE ED INSERTI

128
PEZZI



FG 22/PH
Giraviti per viti con testa a croce Phillips
1x150, 2x100

FG 22/
Giraviti per viti con testa a intaglio
3x100, 4x125, 5.5x100

FG 22/TX
Giraviti per viti con impronta Torx
10, 15, 20, 25, 27, 30

FG 59/XT180
Pinza universale
180mm

FG 63/XT160
Tronchese a taglianti diagonali
160mm

FG 51/180
Pinza a becchi dritti per anelli elastici esterni
180mm

FG 53/180
Pinza a becchi dritti per anelli elastici interni
180mm

FG 139
Chiavi maschio a L con impronta esagonale sferica
1.5, 2, 2.5, 3, 4, 4.5, 5, 5.5, 6, 7, 8, 10

FG 85/S100
Set 98 inserti da 1/4" + 2 porta inserti
PH 0, 1, 2, 3; PZ 0, 1, 2, 3; Tri-Wing 1, 2, 3, 4, 6, 8, 10; XZN 5, 6, 8;
TX 8, 9, 10, 15, 20, 25, 27, 30, 40, 45; S 0, 1, 2, 3;
TX 8, 10, 15, 20, 25, 27, 30, 35, 40; SL 3, 4, 4.5, 5, 5.5, 6, 6.5, 7;
H 1.5, 2, 2.5, 3, 4, 5, 5.5, 6, 1/16, 5/64, 3/32, 7/64, 1/8, 9/64,
5/32, 3/16, 7/32, 1/4;
HTR 2, 2.5, 3, 4, 5, 6, 5/64, 3/32, 7/64, 1/8, 9/64, 5/32; SP 4, 6, 8, 10;
SP 5/32, 3/16, 1/4 + 2 porta inserti 1/4"

FG 88/P14
Porta inserti con manico bi-materiale
258mm

€LISTINO
~~432,00~~

PROMO
249,00€

FG 100/39E
MODULO PINZE ED INSERTI

122
PEZZI



FG 59/XT180
Pinza universale
180mm

FG 63/XT160
Tronchese a taglianti diagonali
160mm

FG 61/XT160
Pinza becchi mezzotondi dritti
160mm

FG 69/CJ250
Pinza regolabile autobloccante con ganasce concave
250mm

FG 58/B240
Pinza regolabile a cerniera chiusa
240mm

FG 85/S100
Set 98 inserti da 1/4" + 2 porta inserti
PH 0, 1, 2, 3; PZ 0, 1, 2, 3; Tri-Wing 1, 2, 3, 4, 6, 8, 10; XZN 5, 6, 8;
TX 8, 9, 10, 15, 20, 25, 27, 30, 40, 45; S 0, 1, 2, 3;
TX 8, 10, 15, 20, 25, 27, 30, 35, 40; SL 3, 4, 4.5, 5, 5.5, 6, 6.5, 7;
H 1.5, 2, 2.5, 3, 4, 5, 5.5, 6, 1/16, 5/64, 3/32, 7/64, 1/8, 9/64,
5/32, 3/16, 7/32, 1/4;
HTR 2, 2.5, 3, 4, 5, 6, 5/64, 3/32, 7/64, 1/8, 9/64, 5/32; SP 4, 6, 8, 10;
SP 5/32, 3/16, 1/4 + 2 porta inserti 1/4"

FG 88/P14
Porta inserti con manico bi-materiale

FG 139
Chiavi maschio a L con impronta esagonale sferica
1.5, 2, 2.5, 3, 4, 4.5, 5, 5.5, 6, 7, 8, 10

FG 51/180
Pinza a becchi dritti per anelli elastici esterni
180mm

FG 52/180
Pinza a becchi a 90° per anelli elastici esterni
180mm

FG 53/180
Pinza a becchi dritti per anelli elastici interni
180mm

FG 54/180
Pinza a becchi a 90° per anelli elastici interni
180mm

€LISTINO
~~475,40~~

PROMO
259,00€



CARRELLI E BANCHI DA LAVORO

FG 100/21F

MODULO CHIAVI A BUSSOLA ESAGONALI, INSERTI E ACCESSORI 1/4", 3/8", 1/2"

115 PEZZI



-  **FG 624/E - FG 624E/L**
Chiavi a bussola esagonali 1/4" -serie normale e serie lunga
4, 5, 6, 7, 8, 9, 10, 11, 12, 13, 14
-  **FG 624/CR14**
Cricchetto reversibile con attacco quadro maschio 1/4" a 72 denti
-  **FG 624/PA**
Prolunghe con attacco quadro maschio e femmina 1/4" angolari
50, 100mm
-  **FG 624/PRF150**
Prolunga con attacco quadro maschio e femmina 1/4"
150mm
-  **FG 624/ES14**
Quadro maschio scorrevole 1/4"
-  **FG 624/SN14**
Snodo con attacco quadro maschio e femmina 1/4"
-  **FG 624/GR14C**
Quadro maschio 1/4" con impugnatura
-  **FG 147/H**
Chiavi a bussola da 1/4" con inserto per viti ad impronta esagonale
2,5, 3, 4, 5, 6, 7, 8, 10
-  **FG 147/PH**
Chiavi a bussola da 1/4" con inserto per viti ad impronta a croce Phillips
1, 2, 3, 4
-  **FG 147/TX**
Chiavi a bussola da 1/4" con inserto per viti ad impronta Torx
9, 10, 15, 20, 25, 27, 30, 40
-  **FG 147/SL**
Chiavi a bussola da 1/4" con inserto per viti con impronta a taglio
4, 5,5, 6,5, 8, 10
-  **FG 139/L**
Chiavi maschio a L con impronta sferica - serie lunga
1,5, 2, 2,5, 3, 4, 4,5, 5, 5,5, 6, 7, 8, 10
-  **FG 624B/PA**
Prolunghe con attacco quadro maschio e femmina 3/8" angolari
75, 125, 150, 250
-  **FG 624/SN38**
Snodo con attacco quadro maschio e femmina 3/8"
-  **FG 624/ES38**
Quadro maschio scorrevole 3/8"
-  **FG 624/CR38**
Cricchetto reversibile con attacco quadro maschio 3/8" a 72 denti
-  **FG 624/B**
Chiavi a bussola esagonali - attacco 3/8"
8, 9, 10, 11, 12, 13, 14, 15, 16, 17, 18, 19, 21, 22, 23
-  **FG 625/A**
Chiavi a bussola esagonali - attacco 1/2"
8, 9, 10, 11, 12, 13, 14, 15, 16, 17, 18, 19, 20, 21, 22, 23, 24, 25, 26, 27, 30, 32
-  **FG 625/PA**
Prolunghe con attacco quadro maschio e femmina 1/2" angolari
125, 250
-  **FG 625/CR12**
Cricchetto reversibile con attacco quadro maschio 1/2" a 72 denti
-  **FG 625/SN12**
Snodo con attacco quadro maschio e femmina 1/2"
-  **FG 625/ES12**
Quadro maschio scorrevole 1/2"

€LISTINO
1.036,00

PROMO
599,00€

FG 100/81G

MODULO INSERTI E CHIAVI A BUSSOLA 1/4" E 1/2"

118 PEZZI



-  **FG 150/H**
Chiavi a bussola da 1/2" con inserto per viti ad impronta esagonale
2, 2,5, 3, 4, 5, 6, 8
-  **FG 150L/H**
Chiavi a bussola da 1/2" con inserto lungo per viti ad impronta esagonale
2, 2,5, 3, 4, 5, 6, 8
-  **FG 150/M**
Chiavi a bussola da 1/2" con inserto per viti ad impronta XZN
5, 6, 8, 10, 12, 14, 16
-  **FG 150L/M**
Chiavi a bussola da 1/2" con inserto lungo per viti ad impronta XZN
5, 6, 8, 10, 12, 14
-  **FG 624/TX**
Chiavi a bussola Torx - attacco 1/4"
4, 5, 6, 7, 8, 10
-  **FG 625/TX**
Chiavi a bussola Torx - attacco 1/2"
8, 10, 12, 14, 16, 18, 20, 22, 24
-  **FG 147/TX**
Chiavi a bussola da 1/4" con inserto per viti ad impronta Torx
9, 10, 15, 20, 25, 27, 30, 40
-  **FG 150/TX**
Chiavi a bussola da 1/2" con inserto per viti ad impronta Torx
10, 15, 20, 25, 27, 30, 40, 45, 50, 55, 60
-  **FG 138/C**
Chiavi maschio a L con impronta Torx - serie lunga
TX9, TX10, TX15, TX20, TX25, TX27, TX30, TX40, TX45, TX50
-  **FG 150/R**
Chiavi a bussola da 1/2" con inserto per viti ad impronta RIBE
4, 5, 6, 7, 8, 9, 10, 11, 12, 13, 14
-  **FG 150L/R**
Chiavi a bussola da 1/2" con inserto lungo per viti ad impronta RIBE
4, 5, 6, 7, 8, 9, 10, 11, 12, 13, 14
-  **FG 147/H**
Chiavi a bussola da 1/4" con inserto per viti ad impronta esagonale
2,5, 3, 4, 5, 6, 7, 8, 10
-  **FG 147/PH**
Chiavi a bussola da 1/4" con inserto per viti ad impronta a croce Phillips
1, 2, 3, 4
-  **FG 147/PT**
Chiavi a bussola da 1/4" con inserto per viti ad impronta pentalobata
1, 2, 3, 4
-  **FG 147/SL**
Chiavi a bussola da 1/4" con inserto per viti con impronta a taglio
4, 5,5, 6,5, 8, 10
-  **FG 624/CS14**
Quadro maschio 1/4" snodato con impugnatura
-  **FG 625/CS12**
Quadro maschio 1/2" snodato con impugnatura

€LISTINO
1.366,00

PROMO
499,00€

FG 100/56D

MODULO UTENSILI PER MANUTENZIONE GENERALE

**15
PEZZI**



-  **FG 132/500**
Martello tipo tedesco con manico in resina
500 Gr
-  **FG 136/30**
Mazzuola anti-rimbalzo con battenti intercambiabili in plastica
Ø 30 mm
-  **FG 126/SN**
Scalpelli nervati
125mm, 200mm
-  **FG 95/CA**
Calibro a corsoio, lettura cinquantennale
150mm
-  **FG 80/8AR**
Lima con impugnatura a taglio mezzodolce tonda
8"
-  **FG 80/8AM**
Lima con impugnatura a taglio mezzodolce mezzotonda
8"
-  **FG 80/8AP**
Lima con impugnatura a taglio mezzodolce piatta
8"
-  **FG 80/8AQ**
Lima con impugnatura a taglio mezzodolce quadrata 8"
-  **FG 80/8AT**
Lima con impugnatura a taglio mezzodolce triangolare 8"
-  **FG 50/AR**
Seghetto compatto con impugnatura
Lama 140mm
-  **FG 48/LG**
Cutter professionale con lama lunga
16.7mm
-  **FG 497/OP2**
Oliatore a pressione con cannuccia rientrante in ottone
80cc
-  **FG 44/MT5**
Flessometro con cassa in ABS anti-shock e nastro in acciaio
rivestito in nylon
5 metri
-  **FG 79/SP4**
Spazzola con fili in acciaio ondulato ottonato
270mm





€/LISTINO ~~364,00~~ **PROMO 219,00€**

FG 100/95B

MODULO UTENSILI PER GOMMISTI

**18
PEZZI**

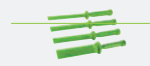

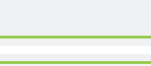
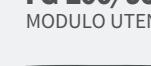
-  **FG 536/2**
Chiave dinamometrica con cricchetto reversibile e aggancio 1/2"
40-200Nm
-  **FG 628/R**
Chiavi a bussola rinforzate per cerchi in lega leggera
17,19,21mm
-  **FG 198/PE**
Pinza per rimozione pesi adesivi equilibratura ruote
-  **FG 186P/S4**
4 Leve in nylon
-  **FG 628R/L**
Chiavi a bussola rinforzate per cerchi in lega leggera - mod. lungo
17,19,21mm
-  **FG 126/P500**
Leva per pneumatici dotata di protezione in ABS 500 mm
-  **FG 628/R**
Chiavi a bussola rinforzate per dadi ruota
16.5x17.5,18.5x19.5,21x21.5,22x22.5,27x27.5

€/LISTINO ~~684,50~~ **PROMO 399,00€**

FG 100/95C

MODULO UTENSILI PER GOMMISTI

**41
PEZZI**



-  **FG 628/R**
Chiavi a bussola rinforzate per cerchi in lega leggera
17,19,21mm
-  **FG 628/C**
Chiavi a bussola esagonali rinforzate - attacco 1/2"
10,11,12,13,14,15,16,17,18,19,20,21,22,23,24,25,26,27,30,32mm
-  **FG 628/L**
Chiavi a bussola esagonali rinforzate lunghe - attacco 1/2"
10,13,14,17,19,21,22,24
-  **FG 152/RH**
Inserti a bussola rinforzati esagonali - attacco 1/2"
5,6,7,8,10,12,14,17,19
-  **FGA 309**
Avvitatore a impulsu 1/2"
1700 Nm max

€/LISTINO ~~818,50~~ **PROMO 469,00€**



CARRELLI E BANCHI DA LAVORO



FG 128/2

€/LISTINO

~~700,00~~

PROMO
349,00€

BANCO DA LAVORO 2.0MT

Ripiano superiore in lamiera d'acciaio zincato da 2mm

Peso totale: 59,5 Kg

Portata statica: 2000 Kg

Dimensioni: 2000x670x880 mm



FG 128/D2

€/LISTINO

~~950,00~~

PROMO
479,00€

BANCO DA LAVORO 2.0MT DOTATO DI 2 CASSETTI

Ripiano superiore in lamiera d'acciaio zincato da 2mm

Peso totale: 74,5 Kg

Portata statica: 2000 Kg

Dimensioni: 2000x670x880 mm



FG 128/D2



FG 128/B2



FG 128/R2



FG 129/2

€/LISTINO

~~850,00~~

PROMO
449,00€

BANCO DA LAVORO 2.0MT

Ripiano superiore in lamiera d'acciaio zincato da 3mm

Peso totale: 83 Kg

Portata statica: 2000 Kg

Dimensioni: 2000x745x880 mm



FG 129/D2

€/LISTINO

~~1.100,00~~

PROMO
579,00€

BANCO DA LAVORO 2.0MT DOTATO DI 2 CASSETTI

Ripiano superiore in lamiera d'acciaio zincato da 3mm

Peso totale: 92 Kg

Portata statica: 2000 Kg

Dimensioni: 2000x745x880 mm



FG 129/D2



FG 129/B2



FG 129/R2



FG 129/1

€/LISTINO

~~550,00~~

PROMO
289,00€

BANCO DA LAVORO 1.0MT

Ripiano superiore in lamiera d'acciaio zincato da 3mm
Ripiano inferiore in lamiera d'acciaio fornita di serie
2 montanti

Predisposizione per fissaggio a pavimento
Struttura verniciata con vernice epossidica

Peso totale: 58 Kg
Portata statica: 2000 Kg
Dimensioni: 1000x745x880 mm



FG 129/D1

€/LISTINO

~~690,00~~

PROMO
359,00€

BANCO DA LAVORO 1.0MT DOTATO DI 1 CASSETTO

Ripiano superiore in lamiera d'acciaio zincato da 3mm
Ripiano inferiore in lamiera d'acciaio fornita di serie
2 montanti

Predisposizione per fissaggio a pavimento
Struttura verniciata con vernice epossidica

Peso totale: 64.5 Kg
Portata statica: 2000 Kg
Dimensioni: 1000x745x880 mm



FG 129/D1



FG 129/B1



FG 129/R1



FG 129/1.5

€/LISTINO

~~650,00~~

PROMO
339,00€

BANCO DA LAVORO 1.5MT

Ripiano superiore in lamiera d'acciaio zincato da 3mm
Ripiano inferiore in lamiera d'acciaio fornita di serie
2 montanti

Predisposizione per fissaggio a pavimento
Struttura verniciata con vernice epossidica

Peso totale: 61 Kg
Portata statica: 2000 Kg
Dimensioni: 1500x745x880 mm



FG 129/D1.5

€/LISTINO

~~790,00~~

PROMO
419,00€

BANCO DA LAVORO 1.5MT DOTATO DI 1 CASSETTO

Ripiano superiore in lamiera d'acciaio zincato da 3mm
Ripiano inferiore in lamiera d'acciaio fornita di serie
2 montanti

Predisposizione per fissaggio a pavimento
Struttura verniciata con vernice epossidica

Peso totale: 83.5 Kg
Portata statica: 2000 Kg
Dimensioni: 1500x745x880 mm



FG 129/D1.5



FG 129/B1.5



FG 129/R1.5



CARRELLI E BANCHI DA LAVORO



FG 137/D1.5

€/LISTINO
~~1.400,00~~

PROMO
739,00€

**BANCO DA LAVORO 1.5MT CON VASCA DI RACCOLTA
DOTATO DI RUOTE GIREVOLI**

Ripiano microforato

Vasca di raccolta estraibile con capacità 30 litri

Peso totale: 90 Kg

Dimensioni: 1500x745x880 mm



FG 137/D1.5



FG 137/B1.5



FG 137/R1.5



**CASSETTO
RACCOLTA FLUIDI**



**RUBINETTO DI
SCARICO FLUIDI**



**RIPIANO MICROFORATO
AMOVIBILE**



FG 131/D2

€/LISTINO
~~1.700,00~~

PROMO
899,00€

**BANCO DA LAVORO 2.0MT CON RIPIANO IN ACCIAIO
E CASSETTIERA 5 CASSETTI**

Peso totale: 121.50 Kg

Dimensioni: 2000x670x920 mm

Chiusura centralizzata



FG 131/D2



FG 131/B2



FG 131/R2



FG 132/D2

€/LISTINO
~~2.350,00~~

PROMO
1.249,00€

**BANCO DA LAVORO 2.0MT CON RIPIANO IN ACCIAIO
E 2 CASSETTIERE 5 CASSETTI**

Peso totale: 163 Kg

Dimensioni: 2000x745x920

Chiusura centralizzata



FG 132/D2



FG 132/B2



FG 132/R2



FG 107/A

€/LISTINO
~~165,00~~

PROMO
79,00€

CARRELLO PORTA ATTREZZI IN LAMIERA D'ACCIAIO

Lamiera d'acciaio: 1mm
2 ruote fisse e 2 ruote girevoli con freno (Ø100mm)
Profondità ripiano: 7,8 cm
Portata statica distribuita in 3 ripiani: 90Kg
Dimensioni: 730x380x780
Peso kg: 16,4



FG 106/B

€/LISTINO
~~336,00~~

PROMO
179,00€

CARRELLO PORTA ATTREZZI IN LAMIERA D'ACCIAIO

Lamiera d'acciaio 1.5mm
Ruote montate su supporto rotante a piastra con gruppo rotante realizzato con doppia corona di sfere
2 ruote fisse, 1 girevole + 1 girevole con freno (Ø100mm)
Dimensione: 460x930x885 mm
Peso totale: 22 Kg



FG 106/C

€/LISTINO
~~428,00~~

PROMO
199,00€

CARRELLO PORTA ATTREZZI IN LAMIERA D'ACCIAIO - MOD. GIGANTE

Lamiera d'acciaio 2,0mm
Ruote montate su supporto rotante a piastra con gruppo rotante realizzato con doppia corona di sfere
2 ruote fisse, 1 girevole + 1 girevole con freno (Ø125mm)
Dimensione: 560x1000x950 mm
Peso totale: 44 Kg



**PRODUZIONE
100% MADE IN ITALY**

ARREDAMENTO FG 118 TECNICO



**VERNICIATURA
SATINATA
OPACA**



**700mm DI PROFONDITÀ
DEL PIANO DI LAVORO
IN ACCIAIO DA 3mm**

I DETTAGLI CHE FANNO LA DIFFERENZA

- PRESE CON ATTACCO STANDARD, SHUKO E USB
- CASSETTIERE CON CASSETTI TOTALMENTE APRIBILI, DOTATI DI TAPPETINI IN GOMMA E PREDISPOSIZIONE PER I DIVISORI INTERNI

- ARMADIETTI CON 4 RIPIANI INTERNI E CERNIERE SOFT-CLOSING
- RIVESTIMENTO SUPERIORE IN POLICARBONATO E NUOVA FINITURA ANTIGRAFFIO
- PENSILI CON ANTE DOTATE DI PISTONI A GAS





FG 118/CO2V

€/LISTINO
~~5.840,00~~

PROMO
2.499,00€

CONFIGURAZIONE DI ARREDAMENTO TECNICO DA 2050MM

Configurazione composta da:

FG 118V/69A: Modulo armadietto con 2 antine

FG 118V/7T: Cassetiera mobile a 7 cassetti

FG 118V/40F: Modulo porta carta dotato di cassetto porta rifiuti

2 pensili superiori

2 griglie porta utensili

2 Prese in dotazione: 1 presa 220V a 2 poli, 1 presa Schuko a 2 poli + USB

Dimensioni: 2050x757x2000 mm



FG 118/CO2D



FG 118/CO2B



FG 118/CO2R



FG 118/CO3V

€/LISTINO
~~6.620,00~~

PROMO
2.899,00€

CONFIGURAZIONE DI ARREDAMENTO TECNICO DA 2550MM

Con igurazione composta da:

FG 117/AR1V: Armadio porta oggetti in metallo ad 1 antina

FG 118V/69A: Modulo armadietto con 2 antine

FG 118V/7T: Cassetiera mobile a 7 cassetti

FG 118V/40F: Modulo porta carta dotato di cassetto porta rifiuti

2 pensili superiori

2 griglie porta utensili

2 Prese in dotazione: 1 presa 220V a 2 poli, 1 presa Schuko a 2 poli + USB

Dimensioni: 2550x757x2000 mm



FG 118/CO3D



FG 118/CO3B



FG 118/CO3R



FG 118/CO30V

€/LISTINO
7.670,00

PROMO
3.299,00€

CONFIGURAZIONE DI ARREDAMENTO TECNICO DA 3050MM

- FG 118V/205A: Struttura base per con igurazione da 2050mm, dotata di pensili superiori
 - FG 118V/40A: Modulo armadietto con antina singola
 - FG 118V/7T: Cassettiera mobile a 7 cassetti
 - FG 118V/69V7: Cassettiera fissa a 7 cassetti
 - FG 117/AR1V: Armadio a un'anta
 - FG 117/AR1V: Armadio a un'anta
- Dimensioni mm (LxWxH): 3050x757x2000



FG 118/CO30D



FG 118/CO30B



FG 118/CO30R



**EFFETTO
METALLICO**

ANTISCIVOLO

ANTIMACCHIA

FG 117/PVC-1

€/LISTINO
~~21,00~~

**PROMO
12,90€**

PIASTRELLA IN PVC

- Spessore 6mm
- Capacità di carico 15-20 t/m²
- Resistente agli agenti chimici
- Antiscivolo
- Antimacchia
- Pratico sistema di montaggio ad incastro
- Effetto metallico
- Ideale per officine, locali commerciali e industriali, ecc.

DIMENSIONI:
500x500mm

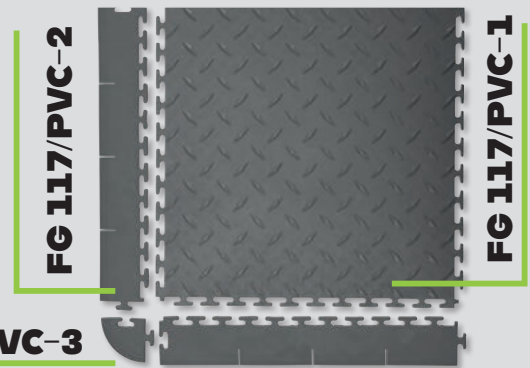

FG 117/PVC-2

€/LISTINO
~~8,00~~

**PROMO
4,90€**

BORDO DI CHIUSURA

DIMENSIONI:
80x500mm



FG 117/PVC-3

€/LISTINO
~~5,00~~

**PROMO
2,90€**

ANGOLO DI CHIUSURA

DIMENSIONI:
80x80mm



FG 117PVC/S5

€/LISTINO
~~221,00~~

**PROMO
129,00€**



**SET 5 PIASTRELLE IN PVC
CON BORDI E ANGOLI DI CHIUSURA**

- 5PZ FG 117/PVC -1 piastrella
- 12PZ FG 117/PVC -2 bordo
- 4PZ FG 117/PVC -3 angolare

FG 117PVC/S6

€/LISTINO
~~258,00~~

**PROMO
149,00€**



**SET 6 PIASTRELLE IN PVC
CON BORDI E ANGOLI DI CHIUSURA**

- 6PZ FG 117/PVC -1 piastrella
- 14PZ FG 117/PVC -2 bordo
- 4PZ FG 117/PVC -3 angolare



FG 118 + ASSORTIMENTO

351 PZ

DI UTENSILI IN MODULI
A PIENO CASSETTO

DEL VALORE
DI 1.980,00€

FG 118V/AS351

€/LISTINO
~~11.399,30~~

PROMO
4.699,00€

CON ASSORTIMENTO DI 351 UTENSILI INDISPENSABILI



FG 118B/AS351



FG 118R/AS351



FG 118D/AS351



PIANO DI LAVORO IN ACCIAIO DA 3mm - PROFONDITÀ 70 cm

CONFIGURAZIONE DI ARREDAMENTO TECNICO DA 3050 mm

FG 118V/205A: Struttura base dotata di 2 pensili superiori

FG 118V/7T: Cassetiera mobile a 7 cassetti

FG 118/69V7: Cassetiera fissa a 7 cassetti

FG 118V/40F: Modulo porta carta, dotato di cassetto porta rifiuti

FG 117/AR1V: Armadio porta oggetti ad 1 anta

FG 117/AR1V: Armadio porta oggetti ad 1 anta

DIMENSIONI:
3050X757X2000mm

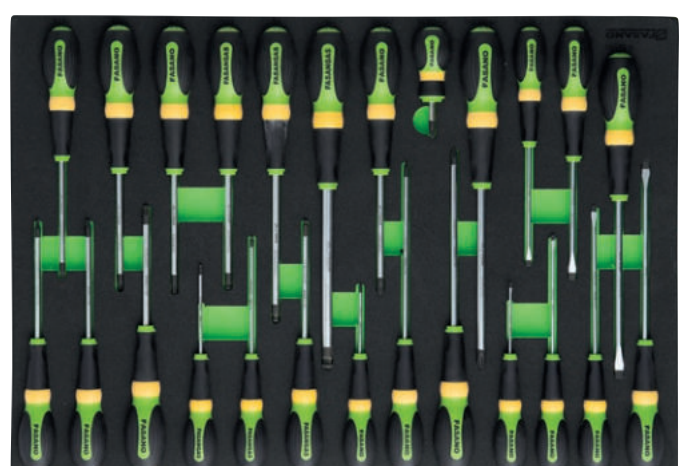
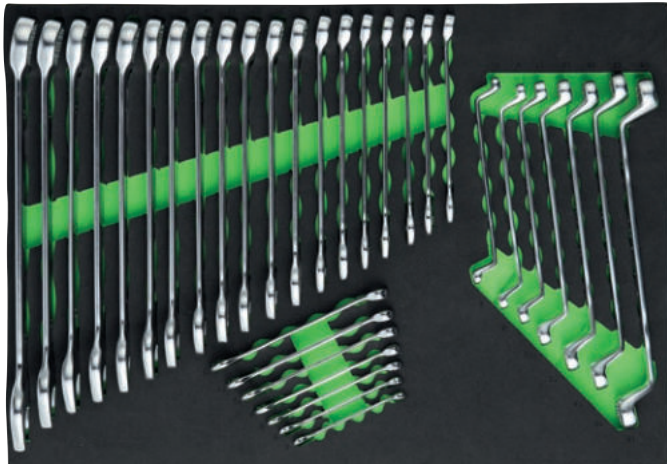

- FG 100/03M:** Modulo chiavi combinate poligonali (6-32mm) e poligonali doppie curve (6x7 - 18x19 mm)
- FG 100/21F:** Modulo chiavi a bussola esagonali, inserti e accessori 1/4", 3/8", 1/2"
- FG 100/39E:** Modulo pinze e inserti da 1/4"
- FG 100/45R:** Modulo giraviti impronte a intaglio, Phillips, esagonali sferiche e Torx
- FG 100/56D:** Modulo utensili per manutenzione generale
- FG 100/95C:** Modulo utensili per gommisti con avvitatore FGA 309

FGA 309
AVVITATORE AD IMPULSI 1/2"





SCOPRI DI PIÙ

SISTEMA DI ARREDAMENTO TECNICO FG 117



DISPONIBILE IN 4 VARIANTI COLORE



NEW

PIANO DI LAVORO IN ACCIAIO DA 2mm
DOTATO DI TOP IN POLICARBONATO ANTIGRAFFIO
DA OGGI DISPONIBILE IN DUE PROFONDITÀ

SCEGLI IL PIANO DA LAVORO PIU' ADATTO ALLE TUE ESIGENZE

La versione con profondita' da 600mm

ha il codice che termina con **FG 117/... - 60**



PROFONDITÀ 460mm



PROFONDITÀ 600mm

RIPIANI INTERNI E MECCANISMO DI CHIUSURA SOFT CLOSING

VERNICIATURA SATINATA OPACA

CASSETTI PREDISPOSTI PER DIVISORI INTERNI PORTA MINUTERIE



FG 117/CO2V

€/LISTINO
~~4.525,00~~

PROMO
1.799,00€

PROFONDITÀ 460mm

FG 117/CO2V-60

€/LISTINO
~~4.825,00~~

PROMO
1.999,00€

PROFONDITÀ 600mm

CONFIGURAZIONI FG 117 DA 2070mm

Configurazione composta da:
 FG 117V/68A: Modulo armadietto
 FG 117V/7G: Carrello porta utensili
 FG 117V/68B: Armadietto, porta carta e porta rifiuti
 3 griglie porta utensili
 3 pensili superiori



FG 117/CO2D - FG 117/CO2D-60



FG 117/CO2B - FG 117/CO2B-60



FG 117/CO2R - FG 117/CO2R-60



FG 117/CO3V

€/LISTINO
~~5.395,00~~

PROMO
2.199,00€

PROFONDITÀ 460mm

FG 117/CO3V-60

€/LISTINO
~~5.695,00~~

PROMO
2.399,00€

PROFONDITÀ 600mm

CONFIGURAZIONI FG 117 DA 2570mm + ARMADIO

Configurazione composta da:
 FG 117V/68A: Modulo armadietto
 FG 117V/7G: Carrello porta utensili
 FG 117V/68B: Armadietto, porta carta e porta rifiuti
 FG 117/AR1V: Armadio ad un anta
 3 griglie porta utensili
 3 pensili superiori



FG 117/CO3D - FG 117/CO3D-60



FG 117/CO3B - FG 117/CO3B-60



FG 117/CO3R - FG 117/CO3R-60



FG 117/CO25V

€/LISTINO
~~5.675,00~~

PROMO
2.349,00€

PROFONDITÀ 460mm

FG 117/CO25V-60

€/LISTINO
~~5.975,00~~

PROMO
2.549,00€

PROFONDITÀ 600mm

CONFIGURAZIONE FG 117 DA 2070mm + ARMADIO

FG 117V/207A: Struttura con griglie porta utensili e 3 pensili superiori

FG 117V/7G: Cassettiera mobile a 7 cassetti

FG 117V/68A: Modulo armadietto con doppia antina

FG 117V/68B: Modulo armadietto con 1 antina

+ modulo porta carta con cassetto porta rifiuti

FG 117/AR2V: Armadio a due ante



FG 117/CO25D - FG 117/CO25D-60



FG 117/CO25B - FG 117/CO25B-60



FG 117/CO25R - FG 117/CO25R-60



FG 117/CO24V

€/LISTINO
~~6.000,00~~

PROMO
2.499,00€

PROFONDITÀ 460mm

FG 117/CO24V-60

€/LISTINO
~~6.300,00~~

PROMO
2.699,00€

PROFONDITÀ 600mm

CONFIGURAZIONI FG 117 DA 2070mm + ARMADIO

FG 117V/207A: Struttura base dotata di griglie porta-utensili e 3 pensili superiori

FG 117V/7G: Carrello a 7 cassetti

FG 117V/68V7: Cassettiera fissa a 7 cassetti

FG 117V/68B: Modulo armadietto con 1 antina

+ modulo porta carta con cassetto porta rifiuti

FG 117/AR2V: Armadio a due ante



FG 117/CO24D - FG 117/CO24D-60



FG 117/CO24B - FG 117/CO24B-60



FG 117/CO24R - FG 117/CO24R-60



FG 117/CO16V

€/LISTINO
~~3.815,00~~

PROMO
1.699,00€

PROFONDITÀ 460mm

FG 117/CO16V-60

€/LISTINO
~~4.015,00~~

PROMO
1.859,00€

PROFONDITÀ 600mm

CONFIGURAZIONI FG 117 DA 1380MM + ARMADIO

FG 117V/138A: Struttura base dotata di griglie porta-utensili e 2 pensili superiori

FG 117V/68A: Modulo armadietto

FG 117/68V5: Cassettiera fissa a 5 cassetti

FG 117/AR1V: Armadio ad un'anta



FG 117/CO16D - FG 117/CO16D-60



FG 117/CO16B - FG 117/CO16B-60



FG 117/CO16R - FG 117/CO16R-60

FG 117/CO30V

€/LISTINO
~~8.480,00~~

PROMO
3.499,00€

PROFONDITÀ 460mm

FG 117/CO30V-60

€/LISTINO
~~9.080,00~~

PROMO
3.899,00€

PROFONDITÀ 600mm



CONFIGURAZIONI FG 117 AD ANGOLO

Configurazione composta da:

FG 117V/207A: Struttura con griglie porta utensili e 3 pensili superiori

FG 117V/138A: Struttura base dotata di griglie porta-utensili e 2 pensili superiori

FG 117/50AN: Struttura angolare dotata di due griglie porta utensili

FG 117V/68B: Armadietto, porta carta e porta rifiuti

FG 117V/7G: Carrello porta utensili a 7 cassetti

FG 117V/68A: Modulo armadietto

FG 117/68V6: Cassettiera fissa a 6 cassetti

FG 117V/68A: Modulo armadietto



FG 117/CO30D - FG 117/CO30D-60



FG 117/CO30B - FG 117/CO30B-60



FG 117/CO30R - FG 117/CO30R-60



FG 117

L'ARREDO TECNICO DEI TUOI SOGNI AD UN PREZZO IMBATTIBILE



FGA 383/AR15
AVVOLGITUBO
AUTOMATICO
PER ARIA
COMPRESSA
-15mt, Ø8X12mm

FG 117V/AS266

€/LISTINO

7.304,00

PROMO
2.999,00€

FG 117V/AS266-60

€/LISTINO

7.624,00

PROMO
3.199,00€

PROFONDITÀ **460mm**

PROFONDITÀ **600mm**

**CON ASSORTIMENTO DI 265 UTENSILI
+ AVVITATORE IN OMAGGIO**



FG 117B/AS266
FG 117B/AS266-60



FG 117R/AS266
FG 117R/AS266-60



FG 117D/AS266
FG 117D/AS266-60



CONFIGURAZIONE DI ARREDAMENTO TECNICO DA 3070 mm

FG 117V/207A: Struttura con griglie porta utensili e 3 pensili superiori

FG 117V/7G: Cassettiera mobile a 7 cassetti

FG 117V/68A: Modulo armadietto con doppia antina

FG 117V/68C: Modulo aria compressa + modulo porta carta e cassetto porta rifiuti

FG 117/AR2V: Armadio a due ante

DIMENSIONI DISPONIBILI:

3070x510x2000mm

3070x630x2000mm



ASSORTIMENTO

265 PZ

**DI UTENSILI
DEL VALORE
DI 900,00 €**

**+ IN OMAGGIO
AVVITATORE**

**FGA 309
DEL VALORE
DI 179,00€**



1° CASSETTO

83 PZ

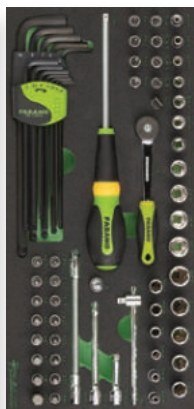

FG 100/03H: Modulo 18 chiavi combinate 6 - 32 mm
FG 100/17E: Modulo chiavi a bussola esagonali da 1/4"

2° CASSETTO

75 PZ

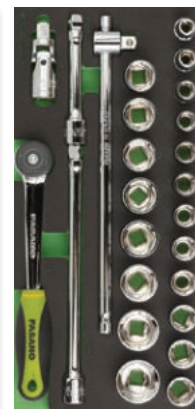

FG 100/45D: Modulo 6 giraviti taglio e croce
FG 100/21B: Modulo chiavi a bussola esagonali da 1/2"
FG 100/21TX: Modulo utensili con impronta Torx da 1/4" e 1/2"

3° CASSETTO

107 PZ



FG 100/48E: Modulo 98 inserti con attacco 1/4" + 2 porta inserti
FG 100/39XT: Modulo 3 pinze assortite - serie Industrial
FG 100/42C: Modulo 4 pinze per anelli elastici

IN OMAGGIO

L'IMMANCABILE

FGA 309

**AVVITATORE
AD IMPULSI 1/2"**





FG 117/CO26V

€/LISTINO
~~5.960,00~~

PROMO
2.699,00€

PROFONDITÀ 460mm

FG 117/CO26V-60

€/LISTINO
~~6.260,00~~

PROMO
2.899,00€

PROFONDITÀ 600mm

NEW



**ORDINE
E PULIZIA
NEGLI SPAZI
DI LAVORO**

**NUOVO MODULO
CON LAVABO
INTEGRATO**



PIANO DI LAVORO IN ACCIAIO DA 2mm

**CONFIGURAZIONE DI ARREDAMENTO TECNICO
DA 2570 mm**

FG 117V/138A: Struttura con griglie porta utensili e 2 pensili superiori

FG 117V/68LVA: Modulo con griglia porta utensili, pensile superiore e armadietto con lavabo

FG 117/68V7: Cassettiera fissa a 7 cassetti

FG 117V/68B: Modulo armadietto con 1 antina + modulo porta carta con cassetto porta rifiuti

FG 117/AR1V: Armadio ad 1 anta

DIMENSIONI DISPONIBILI:

2570X510X2000mm
2570X630X2000mm



**FG 117/CO26B
FG 117/CO26B-60**



**FG 117/CO26R
FG 117/CO26R-60**



**FG 117/CO26D
FG 117/CO26D-60**

FG 117V/68LVB

€/LISTINO
1.150,00

PROMO
599,00€

FG 117V/68LVB-60

€/LISTINO
1.250,00

PROMO
649,00€

PROFONDITÀ 460mm

PROFONDITÀ 600mm

NEW



MODULO FG 117 CON ARMADIETTO E LAVABO INTEGRATO

- Due antine
- Ripiano interno amovibile
- Serratura centrale
- Vasca in acciaio inossidabile 400x340x140 mm

DIMENSIONI DISPONIBILI:

680X460X1015mm
680X600X1015mm

INCLUSI:
RUBINETTO MISCELATORE
GRUPPO DI SCARICO
TAPPO DI CHIUSURA
TAPPO FILTRO



FG 117B/68LVB
FG 117B/68LVB-60



FG 117R/68LVB
FG 117R/68LVB-60



FG 117D/68LVB
FG 117D/68LVB-60

FG 117V/68LVA

€/LISTINO
1.750,00

PROMO
799,00€

FG 117V/68LVA-60

€/LISTINO
1.850,00

PROMO
849,00€

PROFONDITÀ 460mm

PROFONDITÀ 600mm

NEW



INCLUSI:
RUBINETTO MISCELATORE
GRUPPO DI SCARICO
TAPPO DI CHIUSURA
TAPPO FILTRO

DIMENSIONI DISPONIBILI:

690X490X2000mm
690X630X2000mm

MODULO FG 117 CON PENSILE E ARMADIETTO CON LAVABO INTEGRATO

- Struttura base con griglia e pensile superiore
- Modulo armadietto con lavabo integrato



FG 117B/68LVA
FG 117B/68LVA-60



FG 117R/68LVA
FG 117R/68LVA-60



FG 117D/68LVA
FG 117D/68LVA-60



ARREDAMENTO FURGONI

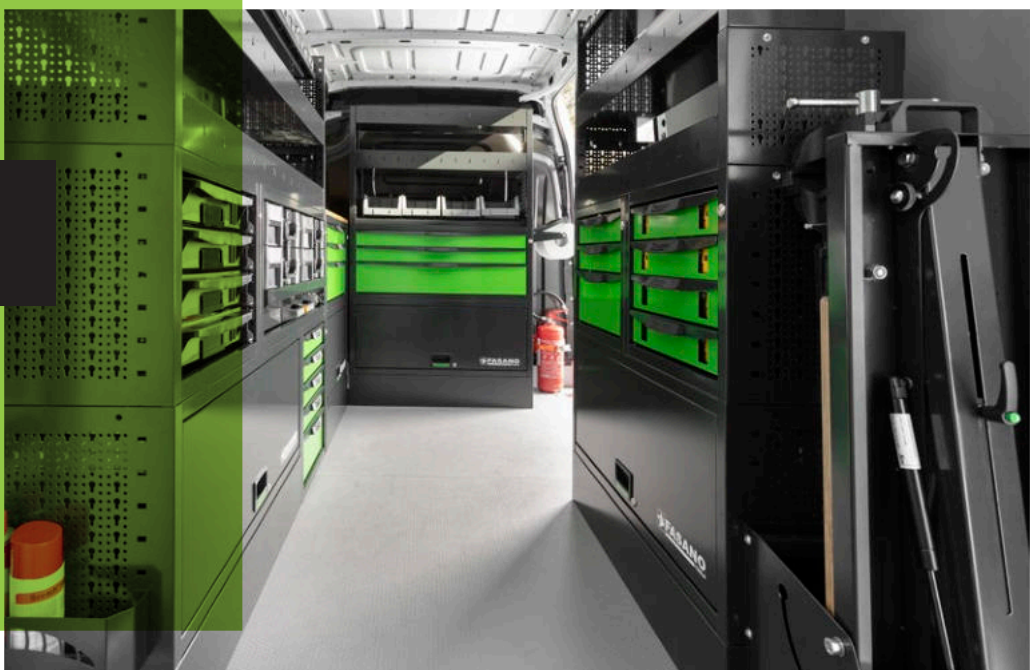

FG 119V/CO16

€/LISTINO

~~1.870,80~~

PROMO
899,00€

CONFIGURAZIONE ARREDAMENTO TECNICO PER FURGONI

Dimensioni mm: 980x400x1057

Peso kg: 61,8

Comprende (dall'alto verso il basso)

FG 119/MRT40-9: coppie montanti laterali

FG 119/RP40-92: ripiano con divisori amovibili

FG 119V/C49-3: cassetiera a 3 cassette

FG 119V/C49-4: cassetiera a 4 cassette

FG 119V/BA98: base aperta

FG 119/RI98: rialzo per basi aperte o chiuse

FG 119/KS: kit staffaggio



FG 119V/CO16



FG 119B/CO16



FG 119R/CO16



MANIGLIE IN ABS
CON IMPUGNATURA
ERGONOMICA



CASSETTI CON
APERTURA COMPLETA
PER MODULI PORTA UTENSILI



VALIGIE COMPONENTI
CON SCOMPARTI
PORTA MINUTERIE

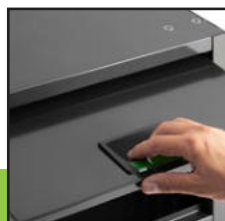

ANTE ESTRAIBILI
AD APERTURA TOTALE



VASCHE IN PLASTICA
PORTA MINUTERIE



PIANALI
ANTISCIVOLO



FG 119V/CO12

€/LISTINO
~~2.315,20~~

PROMO
1.199,00€

CONFIGURAZIONE ARREDAMENTO TECNICO PER FURGONI

Dimensioni mm: 980x400x1592

Peso kg: 74,9

Comprende (dall'alto verso il basso)

- FG 119/M30-40: coppie montanti laterali
- FG 119/RV30-92: ripiano con vaschette in plastica
- FG 119/RP30-92: ripiano con divisori amovibili
- FG 119/M40-23: coppie montanti laterali
- FG 119/RP40-92: ripiano con divisori amovibili
- FG 119V/C49-3: cassettera a 3 cassetti
- FG 119V/C49-4: cassettera a 4 cassetti
- FG 119V/BA98: base aperta
- FG 119/R198: rialzo per basi aperte o chiuse
- FG 119/KS: kit staffaggio



FG 119V/CO12

FG 119B/CO12

FG 119R/CO12



FG 119V/CO25

€/LISTINO
~~1.870,80~~

PROMO
989,00€

CONFIGURAZIONE ARREDAMENTO TECNICO PER FURGONI

Dimensioni mm: 1225x400x1057

Peso kg: 76,2

Comprende (dall'alto verso il basso)

- FG 119/MRT40-9: coppie di montanti laterali
- FG 119/RP40-116: ripiano con divisori amovibili
- FG 119V/C49-4: cassettera a 4 cassetti
- FG 119V/C73-3 cassettera a 3 cassetti
- FG 119/BVF-L122B: base alta con frontalino apribile
- FG 119/KS: kit staffaggio



FG 119V/CO25

FG 119B/CO25

FG 119R/CO25



ARREDAMENTO FURGONI



FG 119V/C033

€/LISTINO
~~3.281,60~~

PROMO
1.599,00€

CONFIGURAZIONE ARREDAMENTO TECNICO PER FURGONI

Dimensioni mm: 1470x400x1360

Peso kg: 114

Comprende (dall'alto verso il basso)

FG 119/M30-40: coppie di montanti laterali

FG 119/RP30-141: ripiano con divisori amovibili

FG 119/RV30-141: ripiano con vaschette in plastica

FG 119V/C49-V1: modulo dotato di 4 valigette portaminuterie

FG 119V/C98-3: cassetiera a 3 cassetti

FG 119V/BA98: base aperta

FG 119V/C49-5B: base con 5 cassetti

FG 119/RI98: rialzo per basi aperte o chiuse

FG 119/KS: kit staffaggio



FG 119V/C033



FG 119B/C033



FG 119R/C033



FG 119V/C018

€/LISTINO
~~1.968,00~~

PROMO
999,00€

CONFIGURAZIONE ARREDAMENTO TECNICO PER FURGONI

Dimensioni mm (LxPxH): 980x400x980

Peso kg: 56,5

Comprende (dall'alto verso il basso)

FG 119/98TL: piano di lavoro in legno

FG 119/C49-3: cassetiera a 3 cassetti

FG 119/C49-4: cassetiera a 4 cassetti

FG 119V/BA98: base aperta

FG 119/RI98: rialzo per basi aperte o chiuse

FG 119/KS: kit staffaggio



FG 119V/C018



FG 119B/C018



FG 119R/C018



FG 119V/CO27

€/LISTINO
~~2.070,00~~

PROMO
1.099,00€

CONFIGURAZIONE ARREDAMENTO TECNICO PER FURGONI

Dimensioni mm (LxPxH): 1225x400x980

Peso kg: 71,6

Comprende (dall'alto verso il basso)

FG 119/73TL: piano di lavoro in legno

FG 119/49TL: piano di lavoro in legno

FG 119/C49-4: cassetiera a 4 cassetti

FG 119/C73-3: cassetiera a 3 cassetti

FG 119/BVF-L122B: base alta con frontalino apribile

FG 119/KS: kit staffaggio



FG 119V/CO27

FG 119B/CO27

FG 119R/CO27



FG 119M/CO13

€/LISTINO
~~1.274,40~~

PROMO
599,00€

CONFIGURAZIONE ARREDAMENTO TECNICO PER FURGONI

Dimensioni mm (LxPxH): 980x400x1592

Peso kg: 38

Comprende (dall'alto verso il basso)

FG 119/M30-40: coppie montanti laterali

FG 119/RP30-92: ripiano con divisori amovibili

FG 119/RP30-92: ripiano con divisori amovibili

FG 119/M40-23: coppie montanti laterali

FG 119/M40-40: coppie montanti laterali

FG 119/RP40-92: ripiano con divisori amovibili

FG 119/RP40-92: ripiano con divisori amovibili

FG 119/BVF-L98B: base con frontalino apribile

FG 119/KS: kit staffaggio



FG 119M/CO28

€/LISTINO
~~1.346,40~~

PROMO
699,00€

CONFIGURAZIONE ARREDAMENTO TECNICO PER FURGONI

Dimensioni mm (LxPxH): 1225x400x1592

Peso kg: 47

Comprende (dall'alto verso il basso)

FG 119/M30-40: coppie montanti laterali

2 x FG 119/RP30-116: ripiani con divisori amovibili

FG 119/M40-23: coppie montanti laterali

FG 119/M40-40: coppie montanti laterali

2 x FG 119/RP40-116: ripiani con divisori amovibili

FG 119/BVF-L122B: base con frontalino apribile

FG 119/KS: kit staffaggio





AUTOMOTIVE



FG 178/UF

€/LISTINO
~~60,00~~

PROMO
35,90€

IMBUTO UNIVERSALE PER OLIO



FG 175/PR

€/LISTINO
~~40,00~~

PROMO
23,90€

PROLUNGA PER CHIAVI A BUSSOLA PER TAPPI OLIO

Dotata di contenitore di raccolta olio
Attacco 3/8" - 1/2"
Capacità 1200 cc



FG 175/S30

€/LISTINO
~~221,50~~

PROMO
129,00€

SET 28 CHIAVI A TAZZA PER FILTRI OLIO



FG 175PF/S4

€/LISTINO
~~76,50~~

PROMO
45,90€

SET 4 CHIAVI A TAZZA PER FILTRI OLIO - MOD. PURFLUX



FG 178/UF83

€/LISTINO
~~35,00~~

PROMO
19,90€

CHIAVE AUTOSERRANTE PER SMONTAGGIO FILTRI OLIO

3/8"

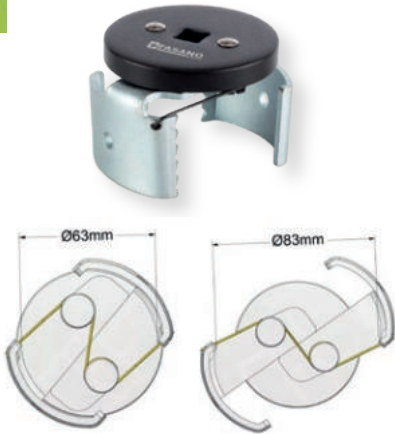

1/2"

CHIAVE AUTOSERRANTE PER FILTRI OLIO PER SERRAGGI DESTROSI E SINISTRORSI - MODELLO PESANTE

CODICE	ØMM	€/LISTINO	€/PROMO
FG 178/UF110	80 - 110 mm	115,00	69,00€
FG 178/UF145	104 - 145 mm	165,00	99,00€

FG 175/S15

€/LISTINO
~~135,00~~

PROMO
79,90€

SET 15 CHIAVI A BUSSOLA MAGNETICHE PER TAPPI OLIO

Esagono maschio 8, 10, 12, 14, 17 mm
Esagono femmina 13, 14, 17, 18, 19, 21 mm
Torx TX45



FG 178/FL

€/LISTINO
~~45,50~~

PROMO
26,90€

IMBUTO FLESSIBILE IN ALLUMINIO RIVESTITO IN GOMMA

Flessibile e modellabile, per facilitare il riempimento e lo svuotamento dei liquidi
L/mm 370
L1/mm 170



FG 175/S4

€/LISTINO
~~72,50~~

PROMO
39,90€

SET UTENSILI PER SMONTAGGIO TAPPI OLIO IN PLASTICA

Adatto per VAG TFSI E TDI, FORD, BMW, CITROEN/PEUGEOT



FG 175/S114

€/LISTINO
~~220,00~~

PROMO
129,00€

SET RIPARAZIONE TAPPI OLIO

- M 13x1.25
- M 13x1.5
- M 15x1.5
- M 17x1.5
- M 20x1.5
- M 22x1.5



FG 202/PV

€/LISTINO
~~230,00~~

PROMO
139,00€

POMPA DI PRESSIONE E DEPRESSIONE



**FG 203/S20**€LISTINO
~~370,00~~**PROMO**
219,00€**KIT CONTROLLO TENUTA IMPIANTO DI RAFFREDDAMENTO****FG 201/S7**€LISTINO
~~340,00~~**PROMO**
199,00€**SET RIPRISTINO PRESSIONE CIRCUITO CARBURANTE SISTEMI DIESEL**

Nuovo modello con pompa bi-direzionale

**FG 176/S13**€LISTINO
~~445,00~~**PROMO**
269,00€**POMPA PER INSERIMENTO OLIO CAMBI E DIFFERENZIALI MANUALI E AUTOMATICI**

Fornito di 12 accessori per connessione diretta

Dotato di valvola di non ritorno

Capacità 7.5l

**TAPPI OPTIONAL PER FG 203/S20**FG 203/BW1
BMWFG 203/FO1
FORD Fiesta
from 2008FG 203/FO2
FORDFG 203/OP1
OPELFG 203/TO1
TOYOTAFG 203/FT1
FIAT

CODICE	MARCA	€/LISTINO	€/PROMO
FG 203/BW1	BMW	37,50	22,90€
FG 203/FO1	FORD FIESTA dal 2008	37,50	22,90€
FG 203/FO2	FORD FIESTA	37,50	22,90€
FG 203/FT1	FIAT	46,00	27,90€
FG 203/OP1	OPEL	37,50	22,90€
FG 203/TO1	TOYOTA	37,50	22,90€

FG 203/S7€LISTINO
~~166,00~~**PROMO**
99,00€**STRUMENTO PER IL RIEMPIMENTO A DEPRESSIONE DEI CIRCUITI DI RAFFREDDAMENTO**

Utile per effettuare uno spurgo perfetto grazie alla messa sotto vuoto del circuito di raffreddamento

**FG 491/200**€LISTINO
~~32,00~~**PROMO**
22,90€**SIRINGA PER OLIO E FLUIDI**

Fornita con 2 guarnizioni di ricambio - Capacità 200cc

FG 491/1500€LISTINO
~~85,00~~**PROMO**
51,90€**SIRINGA PER OLIO E FLUIDI**

Fornita con 2 guarnizioni di ricambio

Non adatta per carburanti e olii minerali - Capacità 1500cc

**FG 491/DF1500**€LISTINO
~~135,00~~**PROMO**
79,90€**SIRINGA PER ESTRAZIONE CARBURANTE DEL CIRCUITO DIESEL**

Dotata di adattatori a innesto rapido - Capacità 1500cc



FG 191/S22

€/LISTINO
~~620,00~~

PROMO
369,00€

SET UNIVERSALE PER ESTRAZIONE ELETTRO-INIETTORI BOSCH, DELPHI, SIEMENS E DENSO

Completo di massa battente 4.8 kg



FG 191/S24

€/LISTINO
~~460,00~~

PROMO
279,00€

SET UTENSILE PNEUMATICO PER ESTRAZIONE ELETTRO-INIETTORI BOSCH, DELPHI, SIEMENS E DENSO



FG 190/RI

€/LISTINO
~~58,00~~

PROMO
34,90€

ESTRATTORE PER RONDELLE INIETTORI



FG 190/RE

€/LISTINO
~~180,00~~

PROMO
99,00€

ESTRATTORI INIETTORI DIESEL M9R - RENAULT/OPEL/NISSAN



FG 190/IP

€/LISTINO
~~48,00~~

PROMO
28,90€

UTENSILE PER ESTRAZIONE UGELLO ELETTRO-INIETTORI



FG 190/OP

€/LISTINO
~~45,00~~

PROMO
26,90€

ESTRATTORE INIETTORI OPEL MOTORI BENZINA AD INIEZIONE DIRETTA



FG 190/S8

€/LISTINO
~~80,00~~

PROMO
49,00€

KIT ESTRAZIONE INIETTORI BMW N54/MINI N14



**FG 191/S14**€LISTINO
~~155,00~~**PROMO**
95,00€**KIT PER PULIZIA SEDI INIETTORI**
In valigetta ABS**CODICE**

FG 191/S14-2	1- Asta filettata M5X0.8XL200mm
FG 191/S14-3	2- Tappo chiusura sede iniettore
FG 191/S14-4	3- Spazzola lunga per la pulizia della sede iniettore
FG 191/S14-1	4- Prolunga flessibile
FG 191/S14-6	5- Spazzola a tazza Ø 15
FG 191/S14-7	6- Spazzola a tazza Ø 20
FG 191/S14-8	7- Spazzola Ø 24x85L
FG 191/S14-9	8- Spazzola Ø 18x85L
FG 191/S14-10	9- Spazzola Ø 21x85L

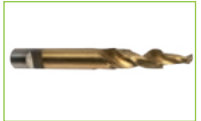
FG 190/S6B€LISTINO
~~165,00~~**PROMO**
99,00€**SET PER FRESATURA SEDI INIETTORI**
In valigetta ABS**FG 174/SC**€LISTINO
~~118,50~~**PROMO**
72,90€**CHIAVE REGOLABILE PER GHIERE GALLEGGIANTI SERBATOIO CARBURANTE**
Ømm: 88-170**FG 182/S16**€LISTINO
~~510,00~~**PROMO**
309,00€**SET ESTRAZIONE CANDELETTE SPEZZATE**
In valigetta ABS**PUNTE PER FORARE IN TITANIO****CONO DI CENTRAGGIO/ESTRATTORE IN ACCIAIO****FG 183/S5**€LISTINO
~~115,00~~**PROMO**
69,00€**SET CHIAVI A BUSSOLA PER CANDELETTE PRERISCALDAMENTO MOTORI DIESEL**
Contenuto: 8,9,10,12,14mm**FG 181RE/S2**€LISTINO
~~86,00~~**PROMO**
49,90€**SET 2 CHIAVI A BUSSOLA EXTRA-LUNGHE POLIGONALI PER RIMOZIONE CANDELE D'ACCENSIONE**
Contenuto: 14, 16mm**FG 181/C14**€LISTINO
~~32,50~~**PROMO**
19,90€**CHIAVE A BUSSOLA SNODATA PER CANDELE D'ACCENSIONE BMW**
Ø 14mm

FG 179/SF

€/LISTINO
~~1.820,00~~

PROMO
929,00€

APPARECCHIO SPURGO LIQUIDO FRENI 12V

- Alimentazione 12V con cavi batteria
- Vano serbatoio con anta porta tappi e 2 mensole porta oggetti posteriori
- Indicatore livello liquido freni a 3 led
- Adatto per liquido freni tipo DOT3, DOT4, DOT5.1
- Pressione massima 2 Bar - Portata 2 l/min
- 4 ruote (due girevoli, 1 con freno)
- In dotazione:
 - 4 bottiglie di recupero liquido freni con tappo e catena con gancio
 - Tubo trasparente con adattatore in gomma (4 m)
 - 10 tappi diversi in base alle applicazioni
 - tappo conico
 - tappi con meccanismo a baionetta (5, 8, 2)
 - tappi con meccanismo con filettatura (I2, F2, D2, E2, G2, M2)



NEW
CE

10 TAPPI IN DOTAZIONE

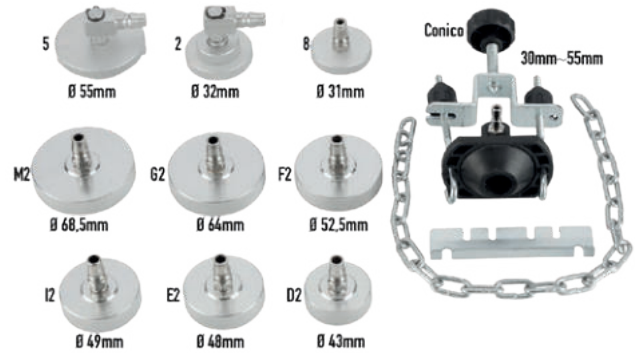

4 BOTTIGLIE DI RECUPERO LIQUIDO FRENI CON TAPPO E SISTEMA A CATENA

VANO SERBATOIO CON ANTA PORTA TAPPI

INDICAZIONE LIVELLO LIQUIDO FRENI A 3 LED

GANCI PORTA TUBI 4 RUOTE (2 GIREVOLI, 1 CON FRENO)

FG 178/BF

€/LISTINO
~~255,00~~

PROMO
149,00€

ASPIRATORE PNEUMATICO PER LIQUIDO FRENI

- Dotato di sonde e attacchi universali
- Capacità 2 litri



FG 178/S6

€/LISTINO
~~330,00~~

PROMO
189,00€

SET TAPPI PER VEICOLI ASIATICI

Toyota, Hyundai, Nissan, Mitsubishi, Mazda, Subaru, Honda, Suzuki





FG 199/PF

€/LISTINO
~~230,00~~

PROMO
139,00€

SET ARRETRATORE PNEUMATICO PER PISTONCINI FRENI A DISCO
Per destrorsi e sinistrorsi



FG 172/BS

€/LISTINO
~~220,00~~

PROMO
129,00€

DIVARICATORE AD ARIA COMPRESSA PER CUFFIE SEMIASI
Per giunti con diametro compreso tra 25 mm e 110 mm
Struttura interna rinforzata in acciaio
Pressione massima 9 bar
Pressione raccomandata 5 ÷ 8 bar
Dimensione minima del tubo aria 3/8"
Attacco aria 1/4"



NEW

FG 628/S7

€/LISTINO
~~115,00~~

PROMO
69,00€

SET 3 BUSSOLE PER CERCHI IN LEGA LEGGERA CON ADATTATORI PER BULLONI DANNEGGIATI
17, 19, 21mm



1/2"



FG 186P/S4

€/LISTINO
~~24,50~~

PROMO
14,90€

SET 4 LEVE IN NYLON



FG 198/PE

€/LISTINO
~~60,00~~

PROMO
35,90€

PINZA PER RIMOZIONE PESI ADESIVI EQUILIBRATURA RUOTE



CHIAVE A BUSSOLA RINFORZATA PER DADI BULLONI

1/2"



FG 125/LV

€/LISTINO
~~20,50~~

PROMO
11,90€

GANCIO LEVA UNIVERSALE PER ASSALI

Per montaggi e smontaggi semplici e sicuri di parti dell'asse.
Grazie al suo speciale design può essere inserito molto vicino alla sospensione
L/mm 103 - L1/mm 88 - L2/mm 38 - L3/mm 25

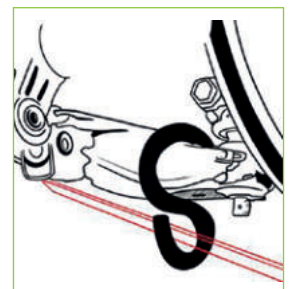

CODICE	MM	APPLICAZIONE	€/LISTINO	€/PROMO
FG 628/R17.5	16.5x17.5	FIAT, JEEP	€ 21,00	€ 12,90
FG 628/R18.5	18.5x19.5	FORD	€ 21,00	€ 12,90
FG 628/R21.5	21x21.5	FORD GALAXY, VOLVO, TOYOTA	€ 23,00	€ 13,90
FG 628/R22.5	22x22.5	CHRYSLER DODGE, LAND ROVER, RANGE ROVER	€ 23,00	€ 13,90
FG 628/R27.5	27x27.5	LAND ROVER DISCOVERY, RANGE ROVER	€ 26,00	€ 15,90

FG 125/SB

€/LISTINO
~~65,00~~

PROMO
39,00€

UTENSILE SEPARATORE PER BRACCETTI OSCILLANTI

Meccanismo di funzionamento a leva tramite scorrevoli, cricchetti o chiavi da inserire in uno dei tre attacchi quadri da 1/2" presenti sull'utensile
Perni con rivestimento antiscivolo per una maggiore sicurezza

NEW

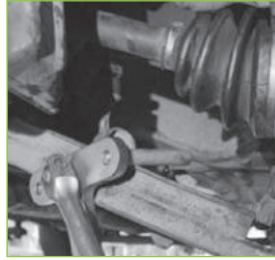

FG 198/DF

€/LISTINO
~~370,00~~

PROMO
219,00€

ESTRATTORE CON VITE IDRAULICA PER MOZZI E CUSCINETTI RUOTE 3,4,5 FORI

Piastra a 10 fori
Per mozzi fino a M12



FG 198/S11

€/LISTINO
~~138,00~~

PROMO
82,90€

SET 11 UTENSILI PER SMONTAGGIO BULLONI PINZE FRENO

Audi, BMW, Ford, Mercedes Benz, Porsche, Volkswagen



FG 168/GA

€/LISTINO
~~65,00~~

PROMO
38,90€

UTENSILE DIVARICATORE UNIVERSALE

Elevata capacità (5 - 11,5 mm)
Utilizzo universale
Superfici di pressione parallele



FG 159/PM

€/LISTINO
~~230,00~~

PROMO
139,00€

SET PRESSORI PER AMMORTIZZATORI

Dotato di 2 coppie di barre filettate
L/mm barre: 65-200/65-370



FG 165/S26

€/LISTINO
~~700,00~~

PROMO
429,00€

SET UTENSILI SPECIALI PER MONTAGGIO/SMONTAGGIO SILENT BLOCK

Boccole per Ø 44-82mm
4 barre filettate M10, M12, M14, M16



FG 166/S28

€/LISTINO
~~475,00~~

PROMO
279,00€

SET PER MONTAGGIO/SMONTAGGIO CUSCINETTI RUOTA

Smontaggio Ø 34-45mm
Montaggio Ø 60-84mm

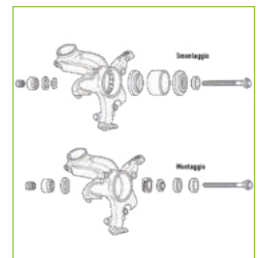

FG 198/S7

€/LISTINO
~~82,00~~

PROMO
49,90€

SET 6 SPAZZOLE MOZZI RUOTA CON ADATTATORE

3 spazzole Ø/mm 16
3 spazzole Ø/mm 14

NEW

1/2"





FG 98/B

€/LISTINO
~~580,00~~

PROMO
349,00€

AVVIATORE DI EMERGENZA PORTATILE 12V, 22AH

Per avviamento di soccorso di veicoli con batterie da 12V
 Batteria al piombo tipo AGM con capacità da 22Ah
 Corrente di avviamento 800A
 Corrente di spunto 2200A
 Cavi 2 AWG in puro rame lunghi 1,65 metri
 Pinze da 1000A con manico in ABS per la massima comodità d'uso
 Display LCD multifunzione
 Led per indicazione della percentuale di carica e della tensione della batteria
 Fusibile di protezione da 500A sul cavo della pinza rossa con funzione test integrità
 Alert inversione della polarità
 Luce led per illuminare l'area di lavoro anche durante le ore notturne
 Prese di emergenza: accendisigari 12V DC 15A e USB 5V 2,4A (power bank)
 Caricabatterie da muro in dotazione



CAVI 2AWG IN PURO RAME DA 1,65M



FUNZIONE POWER BANK



CARICABATTERIE IN DOTAZIONE

CE **CORRENTE DI SPUNTO 2200A** **11,9kg**

FG 98/C

€/LISTINO
~~1.150,00~~

PROMO
699,00€

AVVIATORE DI EMERGENZA PORTATILE 12/24V, 44AH

Per avviamento di soccorso di veicoli e veicoli commerciali con batterie da 12V o 24V
 Ideale per auto, veicoli commerciali, imbarcazioni, mezzi agricoli, generatori, ecc.
 2 batterie al piombo tipo AGM con capacità 22Ah ciascuna
 Corrente di avviamento: 1600A a 12V; 800A a 24V
 Corrente di spunto: 4400A a 12V; 2200A a 24V
 Cavi 1AWG in puro rame, lunghi 1,65 metri
 Pinze da 1000A con manico in ABS per la massima comodità d'uso
 Display LCD multifunzione
 Alert inversione della polarità
 Led per indicazione della percentuale di carica e della tensione della batteria
 Sistema elettronico di protezione della batteria interna
 Luce led per illuminare l'area di lavoro anche durante le ore notturne
 Prese di emergenza: accendisigari 12V DC 15A e USB 5V 2,4A (power bank)
 Caricabatterie da muro in dotazione

CORRENTE DI SPUNTO 4400A - 2200A **19,9kg**



LUCI LED DISPLAY LCD



CAVI 1AWG IN PURO RAME DA 1,65M



CARICABATTERIE IN DOTAZIONE

CE

FG 97/LT

€/LISTINO
~~250,00~~

PROMO
149,00€

AVVIATORE PORTATILE MULTIFUNZIONE

Adatto per l'avviamento di emergenza di motori con batteria da 12V
 Display LCD - Led con 5 modalità - 2 uscite USB 5V 2.4A
 Cavo 12V 10A per presa accendisigari in dotazione
 3 modalità di ricarica (in dotazione: caricabatterie, cavo USB tipo C, adattatore 14V 1A per presa accendisigari)
 Funzione Power Bank - Funzione Travel Lock
 In dotazione boost con morsetti per avviamento motore, custodia



CORRENTE DI SPUNTO 800A **CAPACITÀ BATTERIA 18000mAh**

SISTEMA ELETTRONICO DI PROTEZIONE DELLA BATTERIA INTERNA

FG 98/A1.5

€LISTINO
~~66,00~~

PROMO
39,90€

CARICABATTERIE E MANTENITORE DI CARICA 6/12V

Utilizzabile con batterie AGM, STD, GEL, LFP da 6 o 12V

3 led indicatori dello stato di carica

Protezione da surriscaldamento, inversione di polarità, cortocircuito, sovraccarico

In dotazione cavi con pinze e cavi con occhielli

Dimensioni 110x63x35mm - Peso 0,298kg

NEW



CE



MAX CORRENTE DI CARICA
1.5A

FG 98/A25

€LISTINO
~~330,00~~

PROMO
199,00€

CARICABATTERIE E MANTENITORE DI CARICA 12/24V

Utilizzabile con batterie AGM, LIQ, GEL, LFP da 12 o 24V

Display LCD

Pannello di controllo

Funzione Boost per la ricarica rapida (35A a 12V, 20A a 24V)

Funzione test alternatore

Protezione da sovraccarico e inversione di polarità

In dotazione cavi con pinze

Dimensioni mm 250x130x80 - Peso 1,650kg

CAPACITÀ DI CARICA
10-300Ah

MAX CORRENTE DI CARICA
25A (12V) - 12A (24V)

NEW



CE

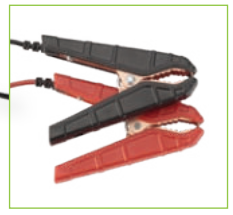

FG 98/A5

€LISTINO
~~120,00~~

PROMO
69,90€

CARICABATTERIE E MANTENITORE DI CARICA 6/12V

Utilizzabile con batterie AGM, LIQ, GEL, LFP da 6 o 12V

Display LCD con pannello di controllo

Protezione da sovraccarico e inversione di polarità

In dotazione cavi con pinze e cavi con occhielli

Dimensioni 170x85x45mm - Peso 0,515kg

NEW



CE

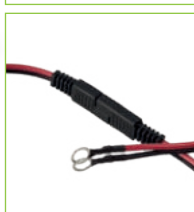

MAX CORRENTE DI CARICA
2.5A (6V) - 5A (12V)

CAPACITÀ DI CARICA
5-80Ah

FG 98/A160

€LISTINO
~~1.400,00~~

PROMO
849,00€

CARICABATTERIE E MANTENITORE DI CARICA MULTIFUNZIONE 12V

Utilizzabile con batterie AGM, STD, EFB, GEL, LFP 12V

Display LCD

Pannello di controllo

Funzione test alternatore

Funzione di recupero batterie scariche

Protezione da sovraccarico, inversione di polarità, surriscaldamento, cortocircuito

In dotazione cavi con pinze

Dimensioni mm 270x390x105 - Peso 2kg

NEW

CE



CORRENTE DI CARICA
10/20/50/80/120/160A

CAPACITÀ DI CARICA
14-2000Ah

FG 98/A15

€LISTINO
~~280,00~~

PROMO
169,00€

CARICABATTERIE E MANTENITORE DI CARICA 6/12/24V

Utilizzabile con batterie sia al piombo acido che al litio

Display LCD

8 fasi di ricarica

Funzione WINTER (ciclo di carica ottimizzato in presenza di basse temperature)

Funzione JUMP (ricarica per batterie molto scariche)

Indicatore del livello di carica

Identificazione delle batterie esauste

Funzione di recupero batterie scariche per batterie al piombo acido

Protezione da surriscaldamento, inversione di polarità, cortocircuito, sovraccarico

In dotazione cavi con pinze

Dimensione 200x120x70 mm - Peso 1,3Kg



MAX CORRENTE DI CARICA
15A (6V e 12V) - 8A (24V)

CAPACITÀ DI CARICA
max 150Ah





FG 215/S40

€/LISTINO
1.550,00

PROMO
879,00€

TESTER PROVA COMPRESIONE DIGITALE CON FINTE INIETTORI E FINTE CANDELETTE PER SISTEMI DIESEL

Grado di precisione: 1%FS
Software in 8 lingue (IT, EN, DE, FR, ES, PT, GR, PL)
Display touch screen LCD retroilluminato a colori 4.3"
Dotazione:
Sensore di pressione 0-80 Bar
Morsetti di collegamento a batteria 12V
Kit raccordi e tubo per sistemi Benzina
Kit raccordi e tubo per sistemi Diesel



ACCESSORI DI BASE IN DOTAZIONE



PROVA ALTERNATORE
PROVA TENSIONE BATTERIA



PROVA COMPRESIONE



**IDEATO, INGEGNERIZZATO
E INTERAMENTE PRODOTTO IN ITALIA**

FG 219/S

€/LISTINO
3.350,00

PROMO
1.999,00€

TESTER MULTI-FUNZIONE PER PROVA COMPRESIONE PROVA PRESSIONE CARBURANTI E PRESSIONE OLIO MOTORE

Grado di precisione: 1%FS
Software in 8 lingue (IT, EN, DE, FR, ES, PT, GR, PL)
Display touch screen LCD retroilluminato a colori, 4.3"
Dotazione:
Sensori di pressione 0-80 Bar e 0-2.500 Bar;
Morsetti di collegamento a batteria 12V;
Kit raccordi e tubo per sistemi Benzina;
Tubazione per attacchi sistemi Diesel



POSSIBILITÀ DI MEMORIZZARE E SCARICARE LE PROVE SU PC, PERSONALIZZANDO LA SCHEDA DATI CON TUTTE LE INFORMAZIONI DEL CLIENTE.



PROVA ALTERNATORE
PROVA TENSIONE BATTERIA



PROVA COMPRESIONE



PROVA PRESSIONE CARBURANTE
(ALTA E BASSA)



PROVA OLIO MOTORE

FG 220/BT

€LISTINO
~~429,00~~

PROMO
249,00€

TESTER DIGITALE PER BATTERIE 12V E 24V

Tensione di funzionamento: da 9V a 35V DC
Tempo di verifica della batteria: circa 1 minuto
Batteria interna per memoria data/ora: CR1220 (1 pezzo)
Dimensioni: 90x50x235mm



CARATTERISTICHE:	DISPLAY RETROILLUMINATO
	SOFTWARE 6 LINGUE: italiano; inglese; spagnolo; polacco; tedesco; francese
	STAMPANTE INTEGRATA CON ROTOLO DI CARTA TERMICA
	SISTEMA RILEVAZIONE FALSO CONTATTO COLLEGAMENTO PINZE
APPLICAZIONI:	TEST BATTERIE 12 E 24V
	TEST ALTERNATORE (INTELLIGENTE E NORMALE) 12-24V CARICA
	TEST SISTEMA DI AVVIAMENTO
BATTERIE SUPPORTATE:	PB, WET, GEL AGM, AGM FLAT, EFB
APPLICAZIONI:	CCA: 100-1700; IEC: 100-1000; EN: 100-1700; DIN: 100-1000; JIS
LUNGHEZZA DEI CAVI:	570 mm

FG 220/EN

€LISTINO
~~459,00~~

PROMO
259,00€

VIDEOSCOPIO DIGITALE CON SONDA FLESSIBILE ED ORIENTABILE

Sonda lunga 1 metro ed orientabile a 360° per la massima flessibilità
Diametro della sonda 5,5 mm per accedere anche ai punti più stretti e difficili da raggiungere
Display LCD da 4.3" per immagini chiare e dettagliate con un'elevata precisione
Sonda progettata per resistere alle condizioni più difficili (temperatura di utilizzo da -10° a 50°)
Angolo di visione 90°
Profondità di campo visivo 15 - 100 mm
Risoluzione massima Full HD 1920x1080 pixel
Batteria integrata al litio da 3.7V - 2600mAh
Autonomia della batteria fino a 4 ore
Tempo di ricarica 4 ore
Fornito in custodia di nylon semirigida
In dotazione scheda SD da 32gb, cavo USB-C e due panni per la pulizia lente e display
Dimensioni mm 220x123x48
Peso 364 gr



FORNITO IN CUSTODIA DI NYLON SEMI-RIGIDA

DISPLAY LCD DA 4,3"

VIDEOSCOPIO DIGITALE

ISPEZIONE E MANUTENZIONE DI MACCHINARI ED IMPIANTI



SONDA CON ILLUMINAZIONE A 6 LED REGOLABILE SU 3 MODALITÀ



SCOPRI DI PIÙ

IN DOTAZIONE SCHEDA SD DA 32 GB PER REGISTRARE E ARCHIVIARE IMMAGINI, VIDEO E AUDIO

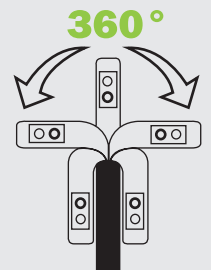

SONDA LUNGA 1 metro ORIENTABILE A 360° PER LA MASSIMA FLESSIBILITA'



**FG 179/ST**

€/LISTINO

~~25,00~~**PROMO
14,90€****CHIAVE A BUSSOLA PER INSTALLAZIONE/RIMOZIONE SISTEMA START-STOP GRUPPO PSA**

Attacco quadro 1/2"

Speciale profilo anteriore triangolare

Per veicoli Peugeot e Citroen con tecnologia micro-ibrida e-HDi



1/2"

**NEW****FG 172/AS2**

€/LISTINO

~~113,00~~**PROMO
69,00€****PINZA PER ANELLI STRINGITUBO CON PROLUNGA INTERCAMBIABILE**
Apertura mm 3-52**FG 172/FA**

€/LISTINO

~~72,50~~**PROMO
41,90€****PINZA PER FASCETTE A SCATTO CLIC****FG 172/TC**

€/LISTINO

~~35,00~~**PROMO
19,90€****PINZA RIMOZIONE PIOLI CATENE****FG 172/PA**

€/LISTINO

~~72,00~~**PROMO
43,90€****PINZA PER SERRAGGIO E TAGLIO FASCETTE A NASTRO IN ACCIAIO INOX**

Indicata anche per fascette Panduit

Ømm 4.7 - 9.5

**FG 172/TG**

€/LISTINO

~~49,50~~**PROMO
21,90€****PINZA PER RIMOZIONE TUBI ACQUA E CARBURANTE****FG 172/MA**

€/LISTINO

~~92,00~~**PROMO
59,90€****PINZA PER FASCETTE A MOLLE**

Con ganasce multipresa regolabili

**FG 181/PM2**

€/LISTINO

~~93,00~~**PROMO
54,90€****ESTRATTORE UNIVERSALE PER PULEGGE**

FG 171/FL

€/LISTINO

~~52,00~~

PROMO
29,90€

PINZA RACCORDI RAPIDI TUBO CARBURANTE CON TESTA FLESSIBILE



FG 171/N

€/LISTINO

~~30,00~~

PROMO
17,90€

PINZA RACCORDI RAPIDI TUBO CARBURANTE



FG 184/S5

€/LISTINO

~~162,00~~

PROMO
99,00€

SET 5 CHIAVI PER DADI TENDICINGHIA
13,15,16,17,19mm



FG 172/RL2

€/LISTINO

~~25,00~~

PROMO
14,90€

PINZA PER ESTRAZIONE RELÉ
Ømm 15-50



FG 172/GO2

€/LISTINO

~~105,00~~

PROMO
63,90€

PINZA PER COLLARI OETIKER



3/8"



FG 172/OT

€/LISTINO

~~58,00~~

PROMO
33,90€

PINZA PER COLLARI OETIKER



FG 184/S4

€/LISTINO

~~92,00~~

PROMO
59,90€

SET CHIAVI TENDICINGHIA

Per Gruppo VAG (1.8L - 2L benzina, 1.9L - 2L diesel), PSA (1.4L-1.5L-1.6L-2L-2.2L diesel), FCA (0.9L TwinAir benzina)

NEW



3/8"

FG 172/CA

€/LISTINO

~~60,00~~

PROMO
35,90€

PINZA PER CAPPUCCI CANDELE

Ømm: 14
L/mm: 290





SETTORE CARROZZERIA

GLI STRUMENTI MIGLIORI, PER VERI PROFESSIONISTI

FG 130AL/S5

€LISTINO

~~37,50~~**PROMO
22,90€**

KIT PUNZONI IN PLASTICA E BULINO IN ALLUMINIO

1 bulino in alluminio regolabile 70mm-100mm
Filettatura M8x1.25

4 punzoni in gomma dura resistente agli urti e anti-graffio



FG 130/S10

€LISTINO

~~650,00~~**PROMO
399,00€**

SET 10 UTENSILI PER CARROZZERIA

Contenuto: Spatole a cucchiaio e a cazzuola, tassi a rotaia, a virgola, a tacco e curvo, martelli con testa tonda e quadrata/a punta, mazzuola e porta lima con lima



FG 184P/S3

€LISTINO

~~27,00~~**PROMO
15,90€**

SET 3 CUNEI IN PLASTICA

Materiale: Polipropilene ad alta resistenza



FG 185P/S4

€LISTINO

~~29,50~~**PROMO
17,90€**

KIT 4 LEVE PER PARTI IN PLASTICA

Materiale: Nylon e fibra di vetro

Elevata resistenza alla torsione

Dotate di foro per appendimento



FG 188/P1

€LISTINO

~~21,00~~**PROMO
12,90€**

LEVA PER PARTI IN PLASTICA

Materiale: Nylon e fibra di vetro

Elevata resistenza alla torsione

Dotata di foro per appendimento



FG 188P/S2

€LISTINO

~~43,00~~**PROMO
25,90€**

KIT CUNEI PER RIMOZIONE MODANATURE IN PLASTICA

Materiale: Polipropilene ad alta resistenza

1pz dotato di manico resistente alle percussioni

1pz senza manico per ideale per spazi ristretti



FG 184R/S3

€/LISTINO

~~48,00~~

PROMO
28,90€

SET 3 RASCHIETTI IN ACCIAIO CON MANICO IN ABS

L1/mm 280
L2/mm: 10,8 - 25 - 40

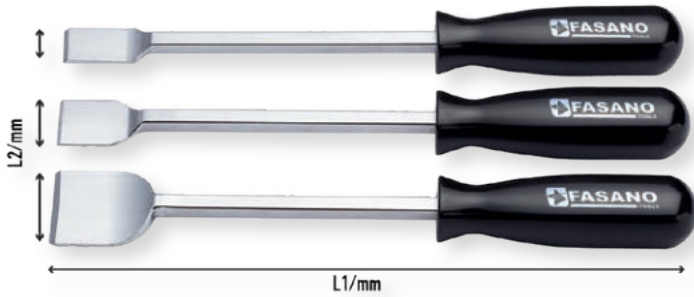

FG 186P/S5

€/LISTINO

~~37,50~~

PROMO
19,90€

SET 5 LEVAPIOLI IN NYLON



FG 184/R1

€/LISTINO

~~22,00~~

PROMO
12,90€

RASCHIETTO IN ACCIAIO CON MANICO IN ABS

L1/mm 280
L2/mm: 19

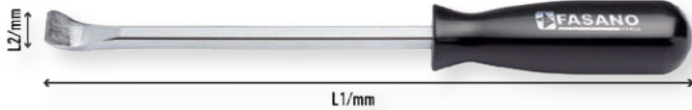

FG 186/S5

€/LISTINO

~~98,00~~

PROMO
59,90€

SET 5 LEVAPIOLI CON LAMA IN ACCIAIO INOX



FG 184/R2

€/LISTINO

~~24,00~~

PROMO
13,90€

RASCHIETTO IN ACCIAIO CON PROTEZIONE IN PVC E MANICO IN ABS

L1/mm 275
L2/mm: 25,6

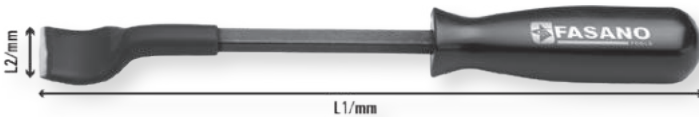

FG 186/AL1

€/LISTINO

~~26,00~~

PROMO
15,90€

LEVA EXTRA PIATTA IN METALLO

Design unico della lama con un lato curvo ed uno dritto per la rimozione di elementi di fissaggio interni ed esterni anche negli spazi più stretti
Punta sottile ad alta resistenza



FG 185B/S2

€/LISTINO

~~42,50~~

PROMO
25,90€

SET 2 LEVAPIOLI CON MANICO IN ABS



FG 185/S5

€/LISTINO

~~98,00~~

PROMO
59,90€

SET 5 LEVAPIOLI CON MANICO IN ABS

Contenuto: FG 185/A1, FG 185/A2, FG 185/A6,
FG 185/A7, FG 185/A8



FG 186/S4

€/LISTINO

~~27,50~~

PROMO
16,90€

SET 4 UNCINI CON LAMA IN ACCIAIO

Con impugnatura bimatériale



**FG 185/CR**

€/LISTINO

~~11,50~~**PROMO
6,90€****UTENSILE LEVA PER MOLLE A "C"**

Ideale per la rimozione delle molle a C presenti sulle manovelle alzavetro

**FG 185/RM**

€/LISTINO

~~32,50~~**PROMO
19,90€****UTENSILE PER RIMOZIONE MANIGLIA POGGIA MANO - GRUPPO VAG**Impugnatura in ABS
L/mm 255**FG 185/OM**

€/LISTINO

~~31,00~~**PROMO
18,90€****UTENSILE PER RIMOZIONE CLIP OMEGA**

Per Gruppo VAG, Tesla, Mercedes-Benz (2008 ~ 2020)

Utilizzabile anche per rimuovere clip simili sul rivestimento del bagagliaio Tesla (Model Y) e sul rivestimento della portiera Tesla (Model Y)

**SET 3 LEVERINI IN MATERIALE PLASTICO**

CODICE		€/LISTINO	€/PROMO
FG 186/S3	3 LEVERINI	10,00	5,90€
FG 186/S3B	3 UNCINI	12,00	6,90€

FG 189/PO1

€/LISTINO

~~23,00~~**PROMO
13,90€****UTENSILE RIMOZIONE CILINDRETTO CHIUSURA PORTIERE - GRUPPO VAG****FG 183/RV1**

€/LISTINO

~~22,00~~**PROMO
12,90€****UTENSILE RIMOZIONE GUARNIZIONI VETRI**Impugnatura in ABS
L/mm 252**UTENSILE RIMOZIONE SCHEGGE**Ideale per la pulizia del canale alzavetro
Punta sferica per evitare danneggiamenti delle guide portiera**FG 189/PO2**

€/LISTINO

~~41,00~~**PROMO
24,90€****UTENSILE RIMOZIONE CILINDRETTO CHIUSURA PORTIERE - GRUPPO VAG**

CODICE	L/MM	€/LISTINO	€/PROMO
FG 182/RG10	255	21,00	12,90€
FG 182/RG24	320	27,50	16,90€

FG 183/CM

€/LISTINO

~~51,50~~

PROMO
29,90€

COLTELLO MANUALE DOTATO DI CAVO E SISTEMA FERMA CAVO

Impugnatura e cavo rivestito in PVC
Fornito con una lama da 25mm già montata



FG 183/RA1

€/LISTINO

~~27,00~~

PROMO
15,90€

RASCHIETTO MANUALE A LAMA DRITTA

Fornito con una lama in dotazione - Impugnatura in ABS dotata di foro per di appendamento
Dotato di protezione lama in ABS



COLTELLO MANUALE DOTATO DI LAMA INTERCambiabile

Fornito con una lama in dotazione - Impugnatura con rivestimento in PVC
Sistema di bloccaggio lama a vite



CODICE	L/MM	€/LISTINO	€/PROMO
FG 183/CK250	250	22,00	12,90€
FG 183/CK450	450	35,00	19,90€
FG 183/CK600	600	44,00	24,90€

FG 187/GR

€/LISTINO

~~31,00~~

PROMO
18,90€

UTENSILE UNIVERSALE PER FISSAGGIO GUARNIZIONI

Dotato di 6 accessori
Sistema guida a rullo
Impugnatura in ABS



FG 187/GU

€/LISTINO

~~29,50~~

PROMO
17,90€

LEVA BLOCCAFILO

L1/mm: 345 - L2/mm: 145



FG 187/GU2

€/LISTINO

~~29,50~~

PROMO
17,90€

GUIDAFILO A T CON IMPUGNATURA IN ABS

L/mm: 320



FG 187/S7

€/LISTINO

~~216,50~~

PROMO
129,00€

SET 7 UTENSILI PER CRISTALLI AUTO



FG 187/K40

€/LISTINO

~~196,00~~

PROMO
119,00€

VENTOSA SINGOLA DOTATA DI IMPUGNATURA E SISTEMA POMPANTE

Capacità 40Kg
Diametro: 178mm - 7"





FG 187/S2

€LISTINO
~~750,00~~

PROMO
459,00€

SET PER SMONTAGGIO PARABREZZA CON SISTEMA VENTOSE A CRICCHETTO

In valigetta di ABS

Ventose da 150mm con pompa manuale

Bobina di avvolgimento del filo da taglio con azionamento da 10mm (3/8")

Capacità massima di aspirazione: 50kg per ogni ventosa



1. Passare il filo taglia cristalli (consigliato FG 187/NY) dall'interno all'esterno dell'abitacolo, forando con un passafilo il sigillante vetro del parabrezza

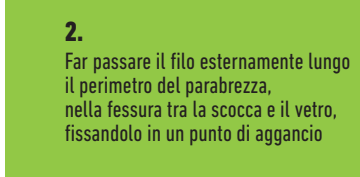

2. Far passare il filo esternamente lungo il perimetro del parabrezza, nella fessura tra la scocca e il vetro, fissandolo in un punto di aggancio

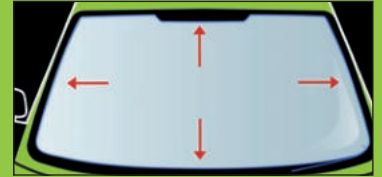

3. Procedere a installare le due ventose sul parabrezza usando la pompa manuale. Assicurarsi di arrivare fino alla scomparsa della linea rossa per ottenere la massima tenuta



4. Inserire l'altro capo del filo nella puleggia e tendere il filo utilizzando un cricchetto. Per ottenere la massima tensione, utilizzare la terza ventosa in modo da mantenere sempre un angolo di 45° durante la trazione del filo

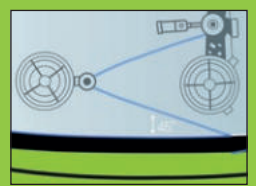

SCOPRI DI PIÙ

FG 188P/S4

€LISTINO
~~65,00~~

PROMO
39,90€

SET PROTEZIONE CRUSCOTTO CON MANIGLIA



FG 165BC/S6

€LISTINO
~~230,00~~

PROMO
139,00€

SET 6 ESTRATTORI PER BRACCI TERGICRISTALLO

1: VW, Porsche; 2: Ford, Seat, Mercedes; 3: BMW, VW; 4: Audi A3-A4-A5-A6; 5: VW, Opel, Honda; 6: Audi Q7



FG 187/PN

€LISTINO
~~263,00~~

PROMO
159,00€

TIRABOLLI PNEUMATICO, DOTATO DI 3 VENTOSE

Ventose: Ø/mm 130, 100, 80

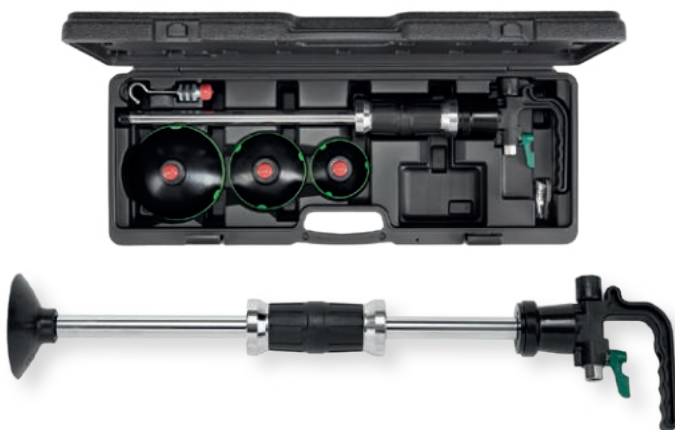

FG 166/DS19

€LISTINO
~~65,00~~

PROMO
39,90€

FG 166/DS24

€LISTINO
~~65,00~~

PROMO
39,90€

DISPENSER PER NASTRO PER MASCHERATURA

Consente l'applicazione facile, veloce e precisa del nastro Fissabile a parete tramite kit di fissaggio in dotazione



NEW

FG 104V/AS284

€/LISTINO
~~4.274,00~~

PROMO
1.599,00€

**CARRELLO PORTA UTENSILI FG 104 A 7 CASSETTI
CON ASSORTIMENTO 284 UTENSILI IN MODULI IN GOMMA
PER CARROZZERIA**



CODICE

FG 104V/AS284	FG 104B/AS284	FG 104R/AS284	FG 104D/AS284
---------------	---------------	---------------	---------------

ASSORTIMENTO 284 UTENSILI

1° CASSETTO



- FG 100/03G: Modulo 14 chiavi combinate 6 - 19mm
- FG 100/17E: Modulo 65 utensili da 1/4"
- FG 100/21TX: Modulo 44 utensili TORX
- FG 100/45F: Modulo 6 giraviti a croce Phillips

2° CASSETTO



- FG 100/45I: Modulo 6 giraviti con impronta Torx
- FG 100/45T: Modulo 5 giraviti a bussola esagonali
- FG 100/56C: Modulo 4 utensili da percussione
- FG 100/81F: Modulo 27 inserti a bussola da 1/2" esagonali e XZN

3° CASSETTO



- FG 100/21M: Modulo 16 chiavi a bussola esagonali
- FG 100/39XT: Modulo 3 pinze assortite - serie Industrial
- FG 100/50G: Modulo 6 chiavi maschio Torx
- FG 100/68: Modulo 5 levapioli

4° CASSETTO



- FG 100/52A: Modulo 8 levapioli
- FG 100/52B: Modulo 26 utensili da taglio per carrozzeria
- FG 100/VA4: Modulo di riempimento con vani porta minuteria
- FG 100/52C: Modulo 5 utensili per cristalli veicoli

5° CASSETTO



- FG 100/52D: Modulo 10 leve in nylon
- FG 100/52E: Modulo 5 cunei in plastica
- FG 100/52F: Modulo 5 raschietti
- FG 100/52G: Modulo 5 utensili carrozzeria

6° CASSETTO

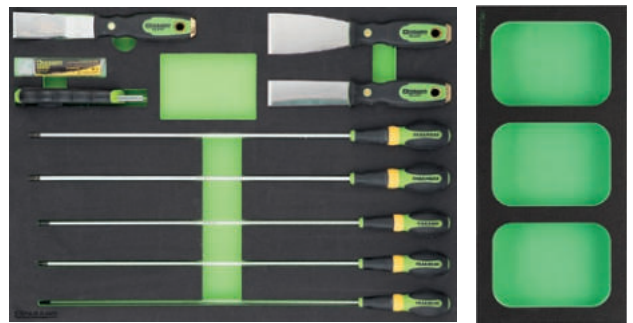

- FG 100/52H: Modulo utensili manutenzione carrozzeria
- FG 100/VA1: Modulo conv ani porta minuteria

**ASSORTIMENTO COMPLETO
PER CARROZZERIA**





**UTENSILI ESSENZIALI PER AFFRONTARE
LE NUOVE SFIDE DEL FUTURO**

THE HYBRID REVOLUTION

**KIT 26 UTENSILI ISOLATI, CON ELMETTO DIELETTRICO
E GUANTI DIELETTRICI 1000 V**

Conforme alla normativa 1000V IEC 60900

**IDEALE PER INTERVENTI SU
VEICOLI ELETTRICI ED IBRIDI**



FG 59/IS200



FG 61/IS200



FG 63/IS160



FG 603/E10,11,12,
13,14,17,19



FG 625E/10,11,12,
13,14,17,19



FG 22E/4X100, 5.5X125,
FG22E/PH1X80, PH2X100



FG 625E/CR12



FG 625E/PR250



FG 49/E



FG 48/IS



FG 22/CF250



CODICE	TAGLIA GUANTI	€/LISTINO	€/PROMO
FG 603/S28A	Taglia 9	1.048,50€	559,00€
FG 603/S28B	Taglia 10	1.048,50€	559,00€

FG 100V/AS56

€/LISTINO
~~2.743,00~~

PROMO
1.299,00€

**CARRELLO MANUTENZIONE VEICOLI ELETTRICI E IBRIDI
CON ASSORTIMENTO DI 56 UTENSILI ISOLATI**



CODICE

FG 100V/AS56	FG 100B/AS56	FG 100R/AS56	FG 100D/AS56	FG 100W/AS56
--------------	--------------	--------------	--------------	--------------

ASSORTIMENTO 56 UTENSILI ISOLATI

Conforme alla norma 1000V IEC 60900



1° CASSETTO

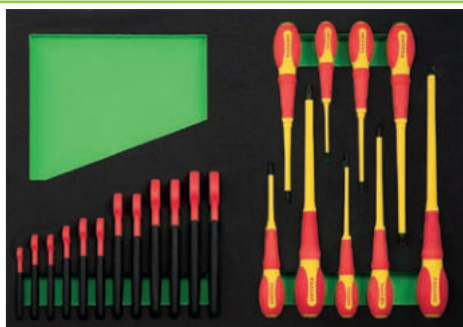

FG 100/03-IS: Modulo chiavi a forchetta e giraviti isolati

- Chiavi a forchetta isolate 7-19mm
- Giraviti isolati a taglio 2.5x75mm, 3x100mm, 5.5x125, 6.5x150mm, 8x175mm
- Giraviti isolati per viti a croce Phillips PH0x60, PH1x80, PH2x100, PH3x150

2° CASSETTO



FG 100/21-IS: Modulo bussole da 1/2" e accessori isolati

- Chiavi a bussola esagonali da 1/2" 10-32mm
- Inseri a bussola esagonali corti e lunghi da 1/2" 4-10mm
- Accessori da 1/2"

3° CASSETTO

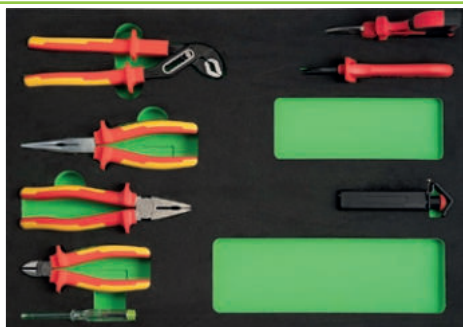

FG 100/39-IS Modulo pinze e utensili da taglio isolati

- Pinze assortite e tronchese diagonale isolate
- Forbice con manici isolati
- Cutter professionale isolato
- Spellacavi elicoidale



FG 603/TA1

€/LISTINO
~~286,00~~

PROMO
149,00€

TAPPETO ISOLANTE 1.000V

Dimensioni 1.000 x 1.000 x 3mm

Classe di isolamento 3

Tensione di esercizio 26500 V

Conforme alla norma IEC-EN 61111





SMONTA AMMORTIZZATORI

DESIGN MIGLIORATO
PER INCREMENTARE
LA COMODITÀ E LA SICUREZZA
DELL'OPERATORE
DURANTE L'UTILIZZO

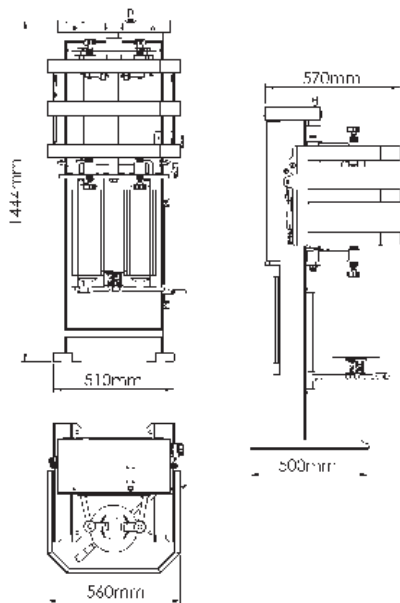

NEW

**+11 CM
DI ALTEZZA
PER LAVORARE
CON MAGGIOR
COMFORT**



**Nuovo meccanismo
di sollevamento della gabbia
con pistone a gas,
per agevolare la manovra
ed evitare l'abbassamento
accidentale**



**Cavo di sicurezza che sostiene
il pistone anche in caso di errato
inserimento dell'ammortizzatore**

**Altezza della gabbia aumentata
per una maggiore superficie di
protezione**



**GRIFFE IN ACCIAIO
C45 BONIFICATO,
con opportuno
trattamento termico,
per una elevata
resistenza meccanica**

FG 750/1P

€LISTINO
~~3.000,00~~

PROMO
1.599,00€

SMONTA-AMMORTIZZATORI DOTATO DI 1 PISTONE
Potenza spinta: 1.2 ton (10 bar) - 0.9 ton (8 bar)
Corsa di compressione molla: 300mm



FG 750/2P

€LISTINO
~~3.700,00~~

PROMO
1.899,00€

SMONTA-AMMORTIZZATORI DOTATO DI 2 PISTONI
Potenza spinta: 2.4 ton (10 bar) - 1.9 ton (8 bar)
Corsa di compressione molla: 300mm



FG 752/1P

€LISTINO
~~3.700,00~~

PROMO
1.799,00€

SMONTA-AMMORTIZZATORI DOTATO DI 1 PISTONE E DISPLAY DIGITALE
Il display digitale visualizza la pressione applicata durante la fase di utilizzo



DISPLAY DIGITALE

FG 752/2P

€LISTINO
~~4.400,00~~

PROMO
2.099,00€

SMONTA-AMMORTIZZATORI DOTATO DI 2 PISTONI E DISPLAY DIGITALE
Il display digitale visualizza la pressione applicata durante la fase di utilizzo



DISPLAY DIGITALE



PRESSE IDRAULICHE

NEW



DOPPIA MODALITA' DI FUNZIONAMENTO:
MANUALE CON LEVA E PNEUMATICA CON PEDALE

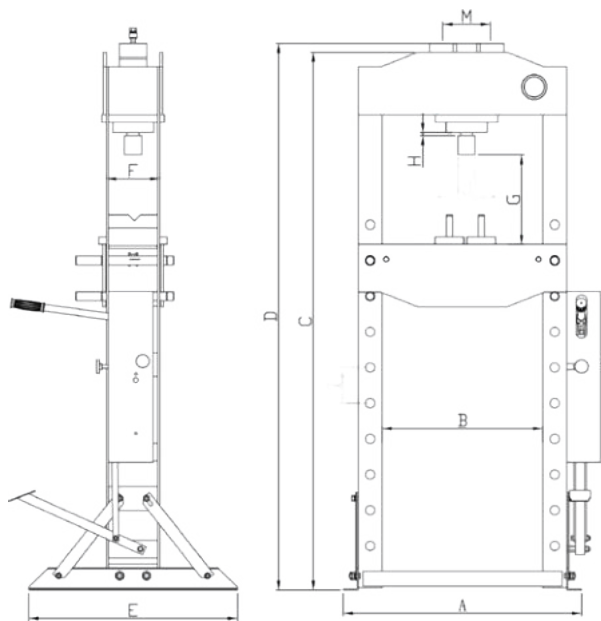

MISURE (mm)

	A	B	C	D	E	F	G	H	M
FG 742/20TP	760	540	1612	1663	600	140	58-1018	145	180
FG 742/30TP	780	540	1808	1838	740	180	166-1126	150	200
FG 742/50TP	1030	730	1838	1918	740	202	88-1068	220	245

FG 742/20TP

€/LISTINO
~~2.100,00~~

PROMO
1.099,00

PRESSA IDRAULICA MANUALE E PNEUMATICA CON PISTONE MOBILE

- Capacità 20 ton
- Funzionamento in 2 modalità: manuale con leva e pneumatica a pedale
- Pistone mobile con ritorno automatico
- Manometro
- Dotata di coppia di prismi a V
- Leva amovibile per funzionamento manuale
- Sistema pneumatico con funzionamento a pedale
- Altezza del piano di lavoro regolabile

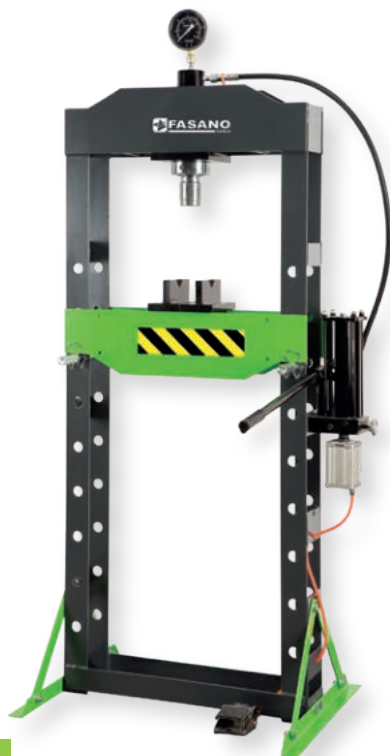

NEW



COPIA DI PRISMI A V



PISTONE MOBILE CON RITORNO AUTOMATICO

FG 742/30TP

€/LISTINO
~~2650,00~~

PROMO
1.399,00

PRESSA IDRAULICA MANUALE E PNEUMATICA CON PISTONE MOBILE

- Capacità 30 ton
- Funzionamento in 2 modalità: manuale con leva e pneumatica a pedale
- Pistone mobile con ritorno automatico
- Manometro
- Dotata di coppia di prismi a V
- Leva amovibile per funzionamento manuale
- Sistema pneumatico con funzionamento a pedale
- Con argano a fune per la regolazione dell'altezza del piano di lavoro

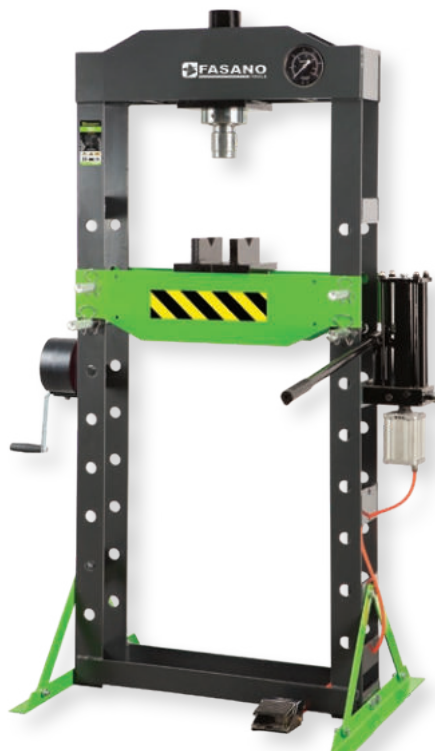

NEW



ARGANO A FUNE PER REGOLARE ALTEZZA PIANO DI LAVORO



PISTONE MOBILE CON RITORNO AUTOMATICO

FG 742/50TP

€/LISTINO
~~4.800,00~~

PROMO
2.499,00

PRESSA IDRAULICA MANUALE E PNEUMATICA CON PISTONE MOBILE

Capacità 50 ton
Funzionamento in 2 modalità: manuale con leva e pneumatica a pedale
Pistone mobile con ritorno automatico - Manometro
Dotata di coppia di prismi a V
Leva amovibile per funzionamento manuale
Sistema pneumatico con funzionamento a pedale
Con argano a fune per la regolazione dell'altezza del piano di lavoro



NEW



ARGANO A FUNE PER
REGOLARE ALTEZZA PIANO
DI LAVORO



PISTONE MOBILE CON
RITORNO AUTOMATICO

FG 745/CMR

€/LISTINO
~~950,00~~

PROMO
499,00€

CAVALLETTO SOSTEGNO MOTORE RICHIUDIBILE

Versione richiudibile
Possibilità di rotazione a 360°
Ruote in acciaio per una maggiore durata e capacità
L1/mm 995 - L2/mm 585



SISTEMA DI ROTAZIONE A
360° A MANOVELLA



FG 740/0.6T

€/LISTINO
~~600,00~~

PROMO
319,00€

SOLLEVATORE IDRAULICO DA FOSSA E SOTTOPONTE

Sistema di sollevamento a pedale
Dotato di 4 ruote girevoli
Portata 600kg

600 PORTATA
kg **MASSIMA**

NEW



FG 745/CMF

€/LISTINO
~~470,00~~

PROMO
249,00€

CAVALLETTO SOSTEGNO MOTORE

Possibilità di rotazione a 360°
Ruote in acciaio per una maggiore durata e capacità
L1/mm 860 - L2/mm 725



SISTEMA DI ROTAZIONE A 360°





FG 718/2.5T

€ LISTINO
~~470,00~~

PROMO
249,00€

SOLLEVATORE IDRAULICO 2.5T MODELLO CORTO

- Robusta struttura in acciaio
- Velocità di discesa controllata
- Manico con gomma antiurto
- 4 ruote in nylon
- Valvola di spurgo dell'aria

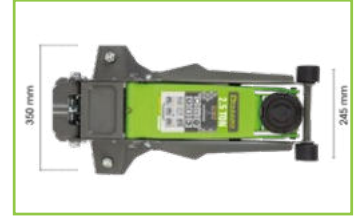

FG 718/3.5T

€ LISTINO
~~562,00~~

PROMO
299,00€

SOLLEVATORE IDRAULICO 3.5T MODELLO CORTO E RIBASSATO

- Design ribassato, ideale per lavorare su veicoli con bassa altezza da terra
- Portata elevata per utilizzo anche su fuoristrada e furgoni
- Robusta struttura in acciaio
- Velocità di discesa controllata
- Manico con gomma antiurto
- 4 ruote in nylon
- Valvola di spurgo dell'aria

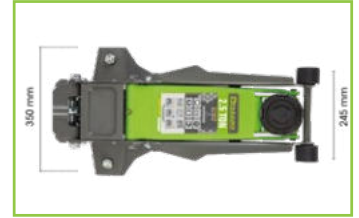

FG 719/2T

€/LISTINO
~~740,00~~

PROMO
369,00€

SOLLEVATORE IDRAULICO 2T MODELLO LUNGO E RIBASSATO

Design ribassato, ideale per lavorare anche su veicoli con bassa altezza da terra

Versione lunga

Sollevamento tramite manico con gomma antiurto

Robusta struttura in acciaio

Velocità di discesa controllata

4 ruote in nylon

Valvola di spurgo dell'aria

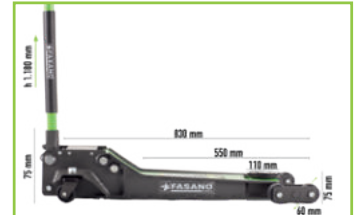
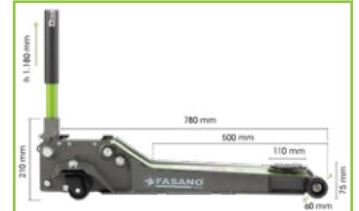

FG 721/2T

€/LISTINO
~~910,00~~

PROMO
399,00€

SOLLEVATORE IDRAULICO 2T MODELLO LUNGO E RIBASSATO CON DOPPIE RUOTE ANTERIORI BASCULANTI

Ideale per lavorare anche su veicoli con bassa altezza da terra

6 ruote in nylon (4 basculanti)

Sollevamento tramite manico rivestito con gomma antiurto

Robusta struttura in acciaio

Velocità di discesa controllata

Dotato di valvola di spurgo dell'aria



FG 722/5T

€/LISTINO
~~1.440,00~~

PROMO
759,00€

SOLLEVATORE IDRAULICO A CARRELLO 5T MODELLO LUNGO PER MEZZI PESANTI

Sistema di sollevamento ausiliario a pedale

Ruote in acciaio montate su cuscinetti a sfera

Self-return integrato

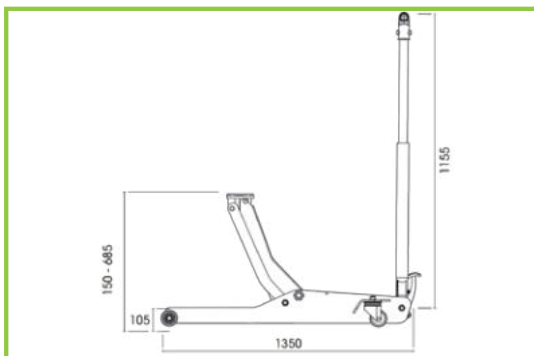

SISTEMA DI SOLLEVAMENTO AUSILIARIO A PEDALE



RUOTE IN ACCIAIO MONTATE SU CUSCINETTI A SFERA





FG 213/LT

€/LISTINO
~~330,00~~

PROMO
175,00€

LEVA PER ESTRAZIONE TESTINE BRACCIO OSCILLANTE E AMMORTIZZATORI



FG 213/SM

€/LISTINO
~~820,00~~

PROMO
429,00€

TRAVERSA SOSTEGNO MOTORE INFERIORE

Utile per il sostenimento del motore o del cambio durante i lavori di manutenzione sia di autovetture che di veicoli commerciali



ASTA ESTENSIBILE PER FACILITARE L'USO ANCHE SU VEICOLI CON COLLE DEL CAMBIO PARTICOLARMENTE LARGHE

COPPIA DI COLONNETTE DI SOSTEGNO



CODICE	CAPACITÀ KG	H-MIN/MAX MM	€/LISTINO	€/PROMO
FG 725/3T	3000	285-425	100,00	52,90€
FG 725/6T	6000	390-605	170,00	89,00€
FG 725/12T	12000	495-720	300,00	159,00€

SOLLEVATORI IDRAULICI A BOTTIGLIA



CODICE	CAPACITÀ KG	H-MIN/MAX MM	€/LISTINO	€/PROMO
FG 735/4T	4000	193-373	85,00	45,00€
FG 735/6T	6000	210-416	98,00	52,00€
FG 735/10T	10000	230-460	142,00	75,00€
FG 735/16T	16000	230-440	168,00	89,00€
FG 735/20T	20000	242-452	210,00	109,00€

FG 750/A

€/LISTINO
~~430,00~~

PROMO
229,00€

CARRELLI MOVIMENTAZIONE VEICOLI

Capacità 680 Kg
L1/mm: 550 - L2/mm: 620
Sistema di sollevamento a pedale
Dotato di 4 ruote girevoli

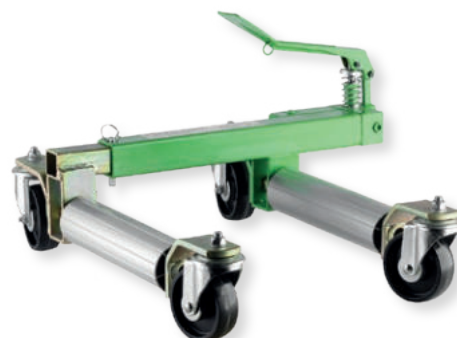

FG 748/0.5T

€/LISTINO
~~250,00~~

PROMO
132,00€

SUPPORTO SOSTEGNO MOTORE

Capacità kg: 500
L/mm: 1550



FG 738/1T

€/LISTINO
~~1.100,00~~

PROMO
579,00€

GRU IDRAULICA PIEGHEVOLE

Versione richiudibile
Ruote in acciaio per una maggiore durata e capacità
Portata massima 1.000 kg
L/mm: 800 - A/mm: 80



POMPA A DOPPIO EFFETTO

FG 1009/...

POLO IN COTONE

Tessuto 96% cotone 4% elasthan
Peso 190 g/m2
3 bottoni
taglia M - L - XL



CODICE	€/LISTINO	€/PROMO
FG 1009/M	55,00€	32,90€
FG 1009/L	55,00€	32,90€
FG 1009/XL	55,00€	32,90€

FG 1010/...

T-SHIRT IN COTONE

Tessuto 100% cotone
Peso 160 g/m2
taglia M - L - XL



CODICE	€/LISTINO	€/PROMO
FG 1010/M	26,00€	15,90€
FG 1010/L	26,00€	15,90€
FG 1010/XL	26,00€	15,90€

FG 1020/...

GILET IN TESSUTO TECNICO SOFTSHELL

Comodo, traspirante e termoregolabile
TESSUTO 100% poliestere
Peso 320 g/m2
Chiusura frontale
2 tasche esterne con cerniera
+ 2 tasche interne
Inseri rifrangenti sui fianchi
taglia M - L - XL



CODICE	€/LISTINO	€/PROMO
FG 1020/M	135,00€	79,00€
FG 1020/L	135,00€	79,00€
FG 1020/XL	135,00€	79,00€

FG 1022/...

GIACCA IN TESSUTO TECNICO SOFTSHELL

Comoda, traspirante e termoregolabile
TESSUTO 100% poliestere - Peso 320 g/m2
Chiusura frontale
3 tasche esterne con cerniera
+ 2 tasche interne
Inseri rifrangenti sulle maniche
taglia M - L - XL



CODICE	€/LISTINO	€/PROMO
FG 1022/M	165,00€	99,00€
FG 1022/L	165,00€	99,00€
FG 1022/XL	165,00€	99,00€

FG 1015

CAPPELLINO CON VISIERA

Tessuto 65% poliestere 35% cotone
taglia unica



€/LISTINO	13,00	PROMO
		7,90€

FG 1014

BERRETTO INVERNALE

TESSUTO 100% acrilico
Con risvolto
taglia unica



€/LISTINO	22,00	PROMO
		12,90€

FG 1016

CAPPELLINO A 6 PANNELLI CON VISIERA

Tessuto 100% poliestere con lavorazione ottoman
Chiusura regolabile con fibbia in metallo
taglia unica



€/LISTINO	30,00	PROMO
		17,90€

FG 1012

ZAINO IN TESSUTO TECNICO

Ampio vano centrale con tasca porta pc
Due tasche frontali con cerniera
e due tasche laterali
Schienale e spallacci imbottiti
Dimensioni: 40x30x18 cm



€/LISTINO	54,00	PROMO
		32,90€

INDICE ANALITICO

CODICE	PAGINA	€/Pz
FG 22/S6	12	21,90€
FG 22/S8B	12	31,90€
FG 22/S8	12	27,90€
FG 22/S12	12	53,90€
FG 22TX/S6	13	39,90€
FG 22RTX/S8	13	49,90€
FG 22FX/S10	13	89,90€
FG 22E/S6	16	36,90€
FG 22E/SZ6	16	36,90€
FG 30/GA1.5	5	24,00€
FG 30/GA2	5	29,00€
FG 30/GA2B	5	34,00€
FG 30/GA2.5	5	49,00€
FG 30/GA3	5	75,00€
FG 30/GA5	5	90,00€
FG 30/GA6	5	145,00€
FG 32/GP1	5	19,00€
FG 32/GP1.5	5	27,00€
FG 32/GP2	5	42,00€
FG 33/GA2	5	36,00€
FG 33/GA2.5	5	49,00€
FG 33/GA3	5	85,00€
FG 33/GA5	5	155,00€
FG 33/GA6	5	189,00€
FG 34/GL1	5	14,90€
FG 34/GL1.5	5	18,00€
FG 34/GL2	5	21,00€
FG 34/GL2.5	5	24,00€
FG 34/GL3	5	27,00€
FG 44/MT3	22	6,90€
FG 44/MT5	22	10,90€
FG 44/MT8	22	14,90€
FG 44/MT10	22	17,90€
FG 47/S3	23	36,90€
FG 48/B	21	13,90€
FG 48/C	21	5,90€
FG 48/P	21	8,90€
FG 49/L	21	10,90€
FG 49/MU	21	15,90€
FG 49/TC	21	26,90€
FG 49/CF	21	17,90€
FG 49/TCX	21	35,90€
FG 51/S4	15	56,90€
FG 51/S4B	15	62,90€
FG 55/S4	15	79,90€
FG 55/S4B	15	84,90€

CODICE	PAGINA	€/Pz
FG 58/C250	15	23,90€
FG 59XT/S3	15	49,90€
FG 59XT/S3B	15	59,90€
FG 59IS/S3	16	69,90€
FG 68/SP	16	21,90€
FG 68/SP2	16	11,90€
FG 68U/S439	16	179,00€
FG 70/S110	20	199,00€
FG 75CO/S25	20	149,00€
FG 77/PVC4	21	29,90€
FG 81HSS/S3	20	159,00€
FG 85/175-S9	15	59,90€
FG 85/175-S10	15	59,90€
FG 88/25-S31	14	59,00€
FG 92/PM	23	12,90€
FG 92/PM4	23	14,90€
FG 92/GR	23	16,90€
FG 92/PF	23	15,90€
FG 93/M50	23	18,90€
FG 93/M95	23	18,90€
FG 95/DG	22	57,90€
FG 95/CA	22	29,90€
FG 96/DG	17	119,00€
FG 96/SS36	24	39,90€
FG 97/DG	17	79,00€
FG 97/LT	118	149,00€
FG 98/DG	17	199,00€
FG 98/GAS	24	85,00€
FG 98/LT	24	115,00€
FG 98/B	118	349,00€
FG 98/C	118	699,00€
FG 98/A1.5	119	39,90€
FG 98/A5	119	69,90€
FG 98/A15	119	169,00€
FG 98/A25	119	199,00€
FG 98/A160	119	849,00€
FG 99/DG	17	149,00€
FG 100V/5T	56	519,00 €
FG 100B/5T	56	519,00 €
FG 100D/5T	56	519,00 €
FG 100R/5T	56	519,00 €
FG 100W/5T	56	519,00 €
FG 100V/6T	56	549,00 €
FG 100B/6T	56	549,00 €
FG 100D/6T	56	549,00 €
FG 100R/6T	56	549,00 €

CODICE	PAGINA	€/Pz
FG 100W/6T	56	549,00 €
FG 100V/7T	56	569,00 €
FG 100B/7T	56	569,00 €
FG 100D/7T	56	569,00 €
FG 100R/7T	56	569,00 €
FG 100W/7T	56	569,00 €
FG 122V/AS212	64	1.099,00€
FG 122B/AS212	64	1.099,00€
FG 122R/AS212	64	1.099,00€
FG 122D/AS212	64	1.099,00€
FG 100V/AS183	65	1.199,00€
FG 100B/AS183	65	1.199,00€
FG 100R/AS183	65	1.199,00€
FG 100D/AS183	65	1.199,00€
FG 100W/AS183	65	1.199,00€
FG 100V/AS371	66	1.399,00€
FG 100B/AS371	66	1.399,00€
FG 100R/AS371	66	1.399,00€
FG 100D/AS371	66	1.399,00€
FG 100W/AS371	66	1.399,00€
FG 100V/AS224	73	1.199,00€
FG 100B/AS224	73	1.199,00€
FG 100R/AS224	73	1.199,00€
FG 100D/AS224	73	1.199,00€
FG 100W/AS224	73	1.199,00€
FG 122V/AS413	74	1.399,00€
FG 122B/AS413	74	1.399,00€
FG 122R/AS413	74	1.399,00€
FG 122D/AS413	74	1.399,00€
FG 100V/AS230	75	1.399,00€
FG 100B/AS230	75	1.399,00€
FG 100R/AS230	75	1.399,00€
FG 100D/AS230	75	1.399,00€
FG 100W/AS230	75	1.399,00€
FG 100VD/AS355	77	1.599,00€
FG 100VW/AS355	77	1.599,00€
FG 100BW/AS355	77	1.599,00€
FG 100BD/AS355	77	1.599,00€
FG 100RD/AS355	77	1.599,00€
FG 100RY/AS355	77	1.599,00€
FG 100CW/AS355	77	1.599,00€
FG 100MA/AS355	77	1.599,00€
FG 100RW/AS355	77	1.599,00€
FG 100RB/AS355	77	1.599,00€
FG 100DP/AS355	77	1.599,00€
FG 100DW/AS355	77	1.599,00€

CODICE	PAGINA	€/Pz
FG 100BY/AS355	77	1.599,00€
FG 100GW/AS355	77	1.599,00€
FG 100V/AS56	131	1.299,00€
FG 100B/AS56	131	1.299,00€
FG 100R/AS56	131	1.299,00€
FG 100D/AS56	131	1.299,00€
FG 100W/AS56	131	1.299,00€
FG 100/03G	80	95,00€
FG 100/03G-A	80	99,90€
FG 100/03L	80	95,00€
FG 100/03L-A	80	99,90€
FG 100/03H	80	189,00€
FG 100/03H-A	80	195,00€
FG 100/03E	80	59,90€
FG 100/03F	80	64,90€
FG 100/07C	80	65,90€
FG 100/07D	80	97,90€
FG 100/08C	80	149,00€
FG 100/10C	80	239,00€
FG 100/10D	81	349,00€
FG 100/17	81	85,00€
FG 100/17E	81	175,00€
FG 100/18	81	179,00€
FG 100/19	81	145,00€
FG 100/21B	81	149,00€
FG 100/21C	81	149,00€
FG 100/21M	81	99,00€
FG 100/21D	81	99,00€
FG 100/21H	81	269,00€
FG 100/21TX	81	159,00€
FG 100/81F	81	119,00€
FG 100/23C	82	135,00€
FG 100/23B	82	219,00€
FG 100/39XT	82	66,90€
FG 100/41C	82	67,90€
FG 100/42C	82	71,90€
FG 100/65B	82	54,90€
FG 100/65C	82	82,90€
FG 100/45D	82	41,90€
FG 100/45E	82	49,90€
FG 100/45F	82	42,90€
FG 100/45G	82	42,90€
FG 100/45I	83	51,90€
FG 100/45T	83	52,90€
FG 100/45H	83	49,00€
FG 100/48G	83	79,90€

CODICE	PAGINA	€/Pz
FG 100/51H	83	89,00€
FG 100/50F	83	54,90€
FG 100/50G	83	54,90€
FG 100/56C	83	82,90€
FG 100/54	83	109,00€
FG 100/76C	83	169,00€
FG 100/03M	84	279,00€
FG 100/21F	86	599,00€
FG 100/81G	86	499,00€
FG 100/39E	85	259,00€
FG 100/39F	85	249,00€
FG 100/45R	84	159,00€
FG 100/56D	87	219,00€
FG 100/95B	87	399,00€
FG 100/95C	87	469,00€
FG 100/PR	54	37,90€
FG 101V/3G	59	249,00€
FG 101D/AS165	60	699,00€
FG 101D/AS196	61	799,00€
FG 102/03G	68	85,00€
FG 102/03L	68	89,00€
FG 102/03H	68	149,00€
FG 102/03E	68	51,90€
FG 102/03F	68	59,90€
FG 102/07C	68	59,90€
FG 102/07D	68	83,90€
FG 102/08C	68	149,00€
FG 102/10C	68	209,00€
FG 102/13C	68	115,00€
FG 102/17	69	79,90€
FG 102/17E	69	169,00€
FG 102/19	69	119,00€
FG 102/19B	69	119,00€
FG 102/21B	69	149,00€
FG 102/21C	69	149,00€
FG 102/21E	69	99,00€
FG 102/21D	69	99,00€
FG 102/21TX	70	149,00€
FG 102/21H	69	129,00€
FG 102/21R	69	139,00€
FG 102/25	69	239,00€
FG 102/25B	69	239,00€
FG 102/23C	70	89,00€
FG 102/51H	70	79,90€
FG 102/39XT	70	59,90€
FG 102/39D	70	45,90€

CODICE	PAGINA	€/Pz
FG 102/41C	70	59,90€
FG 102/42C	70	65,00€
FG 102/45D	70	28,90€
FG 102/45E	70	34,90€
FG 102/45F	70	32,90€
FG 102/45G	70	32,90€
FG 102/45U	70	59,90€
FG 102/45I	71	39,90€
FG 102/45L	71	39,90€
FG 102/45T	71	45,90€
FG 102/48G	71	72,90€
FG 102/50F	71	45,90€
FG 102/50G	71	45,90€
FG 102/56C	71	76,90€
FG 102/60D	71	29,90€
FG 102/62B	71	57,90€
FG 102/65B	71	39,90€
FG 102/VA1	71	8,90€
FG 102V/AS205	62	999,00€
FG 102B/AS205	62	999,00€
FG 102R/AS205	62	999,00€
FG 102D/AS205	62	999,00€
FG 104V/AS284	129	1.599,00€
FG 104D/AS284	129	1.599,00€
FG 104B/AS284	129	1.599,00€
FG 104R/AS284	129	1.599,00€
FG 106/B	91	179,00 €
FG 106/C	91	199,00 €
FG 107/A	91	79,00 €
FG BEST 108	8	139,00 €
FG 108/B	59	69,00 €
FG 109/L3	27	139,00 €
FG 111/AS104	25	329,00 €
FG 111/A	25	32,90 €
FG 111/B	25	39,90 €
FG 111/C	25	49,90 €
FG 113/A	25	119,00€
FG 113/B	25	129,00€
FG 113/C	25	149,00€
FG 113/D	25	199,00€
FG 117/PVC-1	95	12,90€
FG 117/PVC-2	95	4,90€
FG 117/PVC-3	95	2,90€
FG 117PVC/S5	95	129,00€
FG 117PVC/S6	95	149,00€
FG 117/CO2V	99	1.799,00€

CODICE	PAGINA	€/Pz
FG 117/CO2D	99	1.799,00€
FG 117/CO2B	99	1.799,00€
FG 117/CO2R	99	1.799,00€
FG 117/CO2V-60	99	1.999,00€
FG 117/CO2B-60	99	1.999,00€
FG 117/CO2D-60	99	1.999,00€
FG 117/CO2R-60	99	1.999,00€
FG 117/CO3V	99	2.199,00€
FG 117/CO3D	99	2.199,00€
FG 117/CO3B	99	2.199,00€
FG 117/CO3R	99	2.199,00€
FG 117/CO3V-60	99	2.399,00€
FG 117/CO3B-60	99	2.399,00€
FG 117/CO3D-60	99	2.399,00€
FG 117/CO3R-60	99	2.399,00€
FG 117/CO25V	100	2.349,00€
FG 117/CO25D	100	2.349,00€
FG 117/CO25B	100	2.349,00€
FG 117/CO25R	100	2.349,00€
FG 117/CO25V-60	100	2.549,00€
FG 117/CO25B-60	100	2.549,00€
FG 117/CO25D-60	100	2.549,00€
FG 117/CO25R-60	100	2.549,00€
FG 117/CO24D	100	2.499,00€
FG 117/CO24V	100	2.499,00€
FG 117/CO24B	100	2.499,00€
FG 117/CO24R	100	2.499,00€
FG 117/CO24V-60	100	2.699,00€
FG 117/CO24B-60	100	2.699,00€
FG 117/CO24D-60	100	2.699,00€
FG 117/CO24R-60	100	2.699,00€
FG 117/CO26D	104	2.699,00€
FG 117/CO26V	104	2.699,00€
FG 117/CO26B	104	2.699,00€
FG 117/CO26R	104	2.699,00€
FG 117/CO26V-60	104	2.899,00€
FG 117/CO26B-60	104	2.899,00€
FG 117/CO26D-60	104	2.899,00€
FG 117/CO26R-60	104	2.899,00€
FG 117D/AS266	102	2.999,00€
FG 117V/AS266	102	2.999,00€
FG 117B/AS266	102	2.999,00€
FG 117R/AS266	102	2.999,00€
FG 117D/AS266-60	102	3.199,00€
FG 117R/AS266-60	102	3.199,00€
FG 117B/AS266-60	102	3.199,00€

CODICE	PAGINA	€/Pz
FG 117V/AS266-60	102	3.199,00€
FG 117/CO16V	101	1.699,00€
FG 117/CO16D	101	1.699,00€
FG 117/CO16B	101	1.699,00€
FG 117/CO16R	101	1.699,00€
FG 117/CO16V-60	101	1.859,00€
FG 117/CO16B-60	101	1.859,00€
FG 117/CO16D-60	101	1.859,00€
FG 117/CO16R-60	101	1.859,00€
FG 117/CO30V	101	3.499,00€
FG 117/CO30D	101	3.499,00€
FG 117/CO30B	101	3.499,00€
FG 117/CO30R	101	3.499,00€
FG 117/CO30V-60	101	3.899,00€
FG 117/CO30B-60	101	3.899,00€
FG 117/CO30D-60	101	3.899,00€
FG 117/CO30R-60	101	3.899,00€
FG 117V/68LVA	105	799,00€
FG 117D/68LVA	105	799,00€
FG 117R/68LVA	105	799,00€
FG 117B/68LVA	105	799,00€
FG 117V/68LVA-60	105	849,00€
FG 117D/68LVA-60	105	849,00€
FG 117R/68LVA-60	105	849,00€
FG 117B/68LVA-60	105	849,00€
FG 117V/68LVB	105	599,00€
FG 117D/68LVB	105	599,00€
FG 117R/68LVB	105	599,00€
FG 117B/68LVB	105	599,00€
FG 117V/68LVB-60	105	649,00€
FG 117D/68LVB-60	105	649,00€
FG 117R/68LVB-60	105	649,00€
FG 117B/68LVB-60	105	649,00€
FG 118/CO2V	93	2.499,00€
FG 118/CO2D	93	2.499,00€
FG 118/CO2B	93	2.499,00€
FG 118/CO2R	93	2.499,00€
FG 118/CO3V	93	2.899,00€
FG 118/CO3D	93	2.899,00€
FG 118/CO3B	93	2.899,00€
FG 118/CO3R	93	2.899,00€
FG 118/CO30V	94	3.299,00€
FG 118/CO30D	94	3.299,00€
FG 118/CO30B	94	3.299,00€
FG 118/CO30R	94	3.299,00€
FG 118V/AS351	96	4.699,00€

INDICE ANALITICO

CODICE	PAGINA	€/Pz
FG 118D/AS351	96	4.699,00€
FG 118B/AS351	96	4.699,00€
FG 118R/AS351	96	4.699,00€
FG 119V/CO16	106	899,00€
FG 119B/CO16	106	899,00€
FG 119R/CO16	106	899,00€
FG 119V/CO12	107	1.199,00€
FG 119B/CO12	107	1.199,00€
FG 119R/CO12	107	1.199,00€
FG 119V/CO25	107	989,00€
FG 119B/CO25	107	989,00€
FG 119R/CO25	107	989,00€
FG 119V/CO33	108	1.599,00€
FG 119B/CO33	108	1.599,00€
FG 119R/CO33	108	1.599,00€
FG 119V/CO18	108	999,00€
FG 119B/CO18	108	999,00€
FG 119R/CO18	108	999,00€
FG 119V/CO27	109	1.099,00€
FG 119B/CO27	109	1.099,00€
FG 119R/CO27	109	1.099,00€
FG 119M/CO13	109	599,00€
FG 119M/CO28	109	699,00€
FG 120/CO1V	58	1.199,00€
FG 120/CO1D	58	1.199,00€
FG 120/CO1B	58	1.199,00€
FG 120/CO1R	58	1.199,00€
FG 120/CO2V	58	1.249,00€
FG 120/CO2D	58	1.249,00€
FG 120/CO2B	58	1.249,00€
FG 120/CO2R	58	1.249,00€
FG 122V/5G	54	499,00€
FG 122B/5G	54	499,00€
FG 122D/5G	54	499,00€
FG 122R/5G	54	499,00€
FG 122V/6G	54	529,00€
FG 122B/6G	54	529,00€
FG 122D/6G	54	529,00€
FG 122R/6G	54	529,00€
FG 122V/7G	54	549,00€
FG 122B/7G	54	549,00€
FG 122D/7G	54	549,00€
FG 122R/7G	54	549,00€
FG 122V/AS217	72	1.099,00€
FG 122B/AS217	72	1.099,00€
FG 122D/AS217	72	1.099,00€

CODICE	PAGINA	€/Pz
FG 122R/AS217	72	1.099,00€
FG 122V/AS170	63	1.099,00€
FG 122B/AS170	63	1.099,00€
FG 122R/AS170	63	1.099,00€
FG 122D/AS170	63	1.099,00€
FG 122V/AS402	76	1.499,00€
FG 122D/AS402	76	1.499,00€
FG 122B/AS402	76	1.499,00€
FG 122R/AS402	76	1.499,00€
FG 122/PC	54	49,00€
FG 122/PL	54	34,90€
FG 123V/5G	56	699,00€
FG 123B/5G	56	699,00€
FG 123D/5G	56	699,00€
FG 123R/5G	56	699,00€
FG 123V/6G	56	729,00€
FG 123B/6G	56	729,00€
FG 123D/6G	56	729,00€
FG 123R/6G	56	729,00€
FG 123V/7G	56	749,00€
FG 123B/7G	56	749,00€
FG 123D/7G	56	749,00€
FG 123R/7G	56	749,00€
FG 124V/6G	55	619,00 €
FG 124B/6G	55	619,00 €
FG 124D/6G	55	619,00 €
FG 124R/6G	55	619,00 €
FG 124V/7G	55	659,00 €
FG 124B/7G	55	659,00 €
FG 124D/7G	55	659,00 €
FG 124R/7G	55	659,00 €
FG 124D/AS257	67	1.499,00€
FG 124V/AS257	67	1.499,00€
FG 124B/AS257	67	1.499,00€
FG 124R/AS257	67	1.499,00€
FG 124V/AS322	78	1.599,00€
FG 124D/AS322	78	1.599,00€
FG 124B/AS322	78	1.599,00€
FG 124R/AS322	78	1.599,00€
FG 125/S3	23	39,90€
FG 125V/5G	55	729,00€
FG 125B/5G	55	729,00€
FG 125D/5G	55	729,00€
FG 125R/5G	55	729,00€
FG 125V/6G	55	749,00€
FG 125B/6G	55	749,00€

CODICE	PAGINA	€/Pz
FG 125D/6G	55	749,00€
FG 125R/6G	55	749,00€
FG 125V/7G	55	769,00 €
FG 125B/7G	55	769,00 €
FG 125D/7G	55	769,00 €
FG 125R/7G	55	769,00 €
FG 125/LV	116	11,90€
FG 125/SB	117	39,00€
FG 126/S3	23	19,90€
FG 126V/6G	55	849,00 €
FG 126B/6G	55	849,00 €
FG 126D/6G	55	849,00 €
FG 126R/6G	55	849,00 €
FG 126V/7G	55	899,00 €
FG 126B/7G	55	899,00 €
FG 126D/7G	55	899,00 €
FG 126R/7G	55	899,00 €
FG 127V/A	59	299,00 €
FG 127V/B	59	359,00 €
FG 128/S11	22	72,90€
FG 128C/S6	22	28,90€
FG 128/2	88	349,00 €
FG 128/D2	88	479,00 €
FG 128/B2	88	479,00 €
FG 128/R2	88	479,00 €
FG 129/2	88	449,00 €
FG 129/D2	88	579,00 €
FG 129/B2	88	579,00 €
FG 129/R2	88	579,00 €
FG 129/1	89	289,00 €
FG 129/D1	89	359,00 €
FG 129/B1	89	359,00 €
FG 129/R1	89	359,00 €
FG 129/1.5	89	339,00 €
FG 129/D1.5	89	419,00 €
FG 129/B1.5	89	419,00 €
FG 129/R1.5	89	419,00 €
FG 130AL/S5	124	22,90€
FG 130/S10	124	399,00€
FG 131/D2	90	899,00€
FG 131/B2	90	899,00€
FG 131/R2	90	899,00€
FG 132/D2	90	1.249,00€
FG 132/B2	90	1.249,00€
FG 132/R2	90	1.249,00€
FG 137/D1.5	90	739,00€

CODICE	PAGINA	€/Pz
FG 137/B1.5	90	739,00€
FG 137/R1.5	90	739,00€
FG 138/BP	14	36,90€
FG 138/M	14	37,90€
FG 138	14	32,90€
FG 138/B	14	19,90€
FG 138/C	14	19,90€
FG 139/B	13	9,90€
FG 139/C	13	14,90€
FG 139/LM	13	33,90€
FG 139	13	22,90€
FG 139/L	13	24,90€
FG 142/S9	13	76,90€
FG 143TX/S6	14	49,90€
FG 150TX/S32	9	119,00€
FG 150M/S26	10	99,00€
FG 150H/S30	10	99,00€
FG 152/RTXS10	11	99,00€
FG 152RH/S9	11	69,00€
FG 152RM/S9	11	69,00€
FG 159/PM	117	139,00€
FG 162/S3	42	219,00€
FG 162V/14P	57	1.699,00€
FG 162B/14P	57	1.699,00€
FG 162D/14P	57	1.699,00€
FG 162R/14P	57	1.699,00€
FG 162B/14L	57	1.699,00€
FG 162D/14L	57	1.699,00€
FG 162R/14L	57	1.699,00€
FG 162V/14L	57	1.699,00€
FG 162V/AS308	79	2.799,00€
FG 162B/AS308	79	2.799,00€
FG 162R/AS308	79	2.799,00€
FG 162D/AS308	79	2.799,00€
FG 163/S2B	42	159,00€
FG 165/IE1	42	199,00€
FG 165/IE2	42	459,00€
FG 165/MB1	43	99,00€
FG 165/MB2	43	199,00€
FG 165/S26	117	429,00€
FG 165BC/S6	128	139,00€
FG 166/S28	117	279,00€
FG 166/DS19	128	39,90€
FG 166/DS24	128	39,90€
FG 168/EF1	42	209,00€
FG 168/EF2	42	215,00€

CODICE	PAGINA	€/Pz
FG 168SD/S4	43	99,00€
FG 168A/S5	43	69,00€
FG 168A/S13	43	129,00€
FG 168EP/S5	43	21,00€
FG 168/S25	43	89,00€
FG 168/S9	43	109,00€
FG 168/GA	117	38,90€
FG BEST 171	8	179,00€
FG 171/FL	123	29,90€
FG 171/N	123	17,90€
FG 172/BS	116	129,00€
FG 172/FA	122	41,90€
FG 172/PA	122	43,90€
FG 172/MA	122	59,90€
FG 172/AS2	122	69,00€
FG 172/TC	122	19,90€
FG 172/TG	122	21,90€
FG 172/RL2	123	14,90€
FG 172/GO2	123	63,90€
FG 172/OT	123	33,90€
FG 172/CA	123	35,90€
FG 174/SC	114	72,90€
FG 175/S30	110	129,00€
FG 175/PR	110	23,90€
FG 175PF/S4	110	45,90€
FG 175/S114	111	129,00€
FG 175/S15	111	79,90€
FG 175/S4	111	39,90€
FG 176/S13	112	269,00€
FG 178/UF	110	35,90€
FG 178/UF83	111	19,90€
FG 178/FL	111	26,90€
FG 178/UF110	111	69,00€
FG 178/UF145	111	99,00€
FG 178/BF	115	149,00€
FG 178/S6	115	189,00€
FG 179/SF	115	929,00€
FG 179/ST	122	14,90€
FG 180/SP9	3	129,00€
FG 181RE/S2	114	49,90€
FG 181/C14	114	19,90€
FG 181/PM2	122	54,90€
FG 182/S5B	43	289,00€
FG 182/S14	43	149,00€
FG 182/S16	114	309,00€
FG 182/RG10	126	12,90€

CODICE	PAGINA	€/Pz
FG 182/RG24	126	16,90€
FG 183/S5	114	69,00€
FG 183/RV1	126	12,90€
FG 183/CM	127	29,90€
FG 183/CK250	127	12,90€
FG 183/CK450	127	19,90€
FG 183/CK600	127	24,90€
FG 183/RA1	127	15,90€
FG 184/S5	119	99,00€
FG 184/S4	123	59,90€
FG 184P/S3	124	15,90€
FG 184R/S3	125	28,90€
FG 184/R1	125	12,90€
FG 184/R2	125	13,90€
FG 185P/S4	120	17,90€
FG 185B/S2	125	25,90€
FG 185/S5	125	59,90€
FG 185/CR	126	6,90€
FG 185/OM	126	18,90€
FG 185/RM	126	19,90€
FG 186P/S4	116	14,90€
FG 186P/S5	125	19,90€
FG 186/S5	125	59,90€
FG 186/AL1	125	15,90€
FG 186/S4	125	16,90€
FG 186/S3	126	5,90€
FG 186/S3B	126	6,90€
FG 187/GU	127	17,90€
FG 187/S7	127	129,00€
FG 187/GR	127	18,90€
FG 187/GU2	127	17,90€
FG 187/K40	127	119,00€
FG 187/S2	128	459,00€
FG 187/PN	128	159,00€
FG 188/P1	124	12,90€
FG 188P/S2	124	25,90€
FG 188P/S4	128	39,90€
FG 189/PO1	126	13,90€
FG 189/PO2	126	24,90€
FG 190/RI	113	34,90€
FG 190/IP	113	28,90€
FG 190/OP	113	26,90€
FG 190/RE	113	99,00€
FG 190/S8	113	49,00€
FG 190/S6B	114	99,00€
FG 191/S22	113	369,00€

CODICE	PAGINA	€/Pz
FG 191/S24	113	279,00€
FG 191/S14	114	95,00€
FG 198/PE	116	35,90€
FG 198/S11	117	82,90€
FG 198/S7	117	49,90€
FG 198/DF	117	219,00€
FG 199/PF	116	139,00€
FG 201	30	29,90€
FG 201/S7	112	199,00€
FG 202	28	33,90€
FG 202/PV	111	139,00€
FG 203	28	9,90€
FG 203/S20	112	219,00€
FG 203/BW1	112	22,90€
FG 203/FO1	112	22,90€
FG 203/FO2	112	22,90€
FG 203/FT1	112	27,90€
FG 203/OP1	112	22,90€
FG 203/TO1	112	22,90€
FG 203/S7	112	99,00€
FG 204	28	19,90€
FG 205/C	31	69,00€
FG 205/B	31	49,90€
FG 206	30	33,90€
FG 207	29	38,90€
FG 207/B	29	59,90€
FG 209	33	149,00€
FG 210/C	32	99,00€
FG 210/W	32	39,90€
FG 210/B	33	39,90€
FG 211	29	59,90€
FG 212	29	43,90€
FG 213/B	30	79,00€
FG 213/L480	30	39,90€
FG 213/LT	138	175,00€
FG 213/SM	138	429,00€
FG 214/L600	28	42,90€
FG 215/S40	120	879,00€
FG 217/B	31	179,00€
FG 219/S	120	1.999,00€
FG 220/BT	121	249,00€
FG 220/EN	121	259,00€
FG 221	32	159,00€
FG 222/A	32	49,00€
FG 222/B	32	169,00€
FG 224/SU	33	49,00€

CODICE	PAGINA	€/Pz
FG 224/L5200	33	129,00€
FG 225/SK1.5	35	149,00€
FG 225/SK2.5	35	179,00€
FG 234	34	59,00€
FG 235	34	79,00€
FG 236	35	199,00€
FG 236/SU	35	59,00€
FGA 290	46	119,00€
FGA 291/D	46	109,00€
FGA 292/B	46	129,00€
FG 305/LT2	38	399,00€
FGA 307	44	149,00€
FGA 307/AN	44	189,00€
FGA 309	44	179,00€
FG 310/LT2	38	469,00€
FGA 312	44	199,00€
FG 315/LT2	38	529,00€
FGA 316	45	459,00€
FGA 316/L	45	519,00€
FGA 319	45	659,00€
FGA 319/L	45	719,00€
FG 320/LT2	39	569,00€
FGA 321	45	589,00€
FGA 321/B	45	649,00€
FGA 321/C	45	699,00€
FGA 322	46	85,00€
FG 325/LT2	39	349,00€
FG 330/LT2	37	399,00€
FGA 330	49	179,00€
FGA 332	49	89,00€
FGA 334	50	89,00€
FGA 334/AN115	50	109,00€
FGA 334/AN	50	109,00€
FGA 334/L	50	109,00€
FG 335/LT2	37	439,00€
FGA 335	49	119,00€
FGA 336	49	369,00€
FGA 337	49	79,00€
FGA 338	50	75,00€
FGA 338/AN	50	99,00€
FGA 338/L	50	99,00€
FGA 339	49	199,00€
FGA 340	48	169,00€
FGA 340/B	48	169,00€
FGA 342/B	48	169,00€
FGA 342	48	139,00€

INDICE ANALITICO

CODICE	PAGINA	€/Pz
FGA 343/N10	48	139,00€
FGA 343/N20	48	189,00€
FGA 344	48	149,00€
FGA 346/B	50	139,00€
FGA 348/A	51	99,00€
FGA 348/B	51	119,00€
FGA 348/C	51	149,00€
FGA 348/D	51	159,00€
FG 360/LT1	40	259,00€
FG 363/LT1	40	269,00€
FG 366/LT1	40	279,00€
FG 370/LT1	41	319,00€
FG 373/LT1	41	319,00€
FG 380/LT1	41	269,00€
FG 383/LT1	41	279,00€
FGA 383/AR15	47	139,00€
FGA 385/AR15	47	179,00€
FGA 390	46	99,00€
FGA 416	47	12,90€
FGA 419	47	13,90€
FG 491/200	112	22,90€
FG 491/1500	112	51,90€
FG 491/DF1500	112	79,90€
FG 493/AL	24	28,90€
FG 493/N	24	23,90€
FG 494/S12	24	32,90€
FG 494/A180	24	99,00€
FG 531	18	129,00€
FG 533/2	18	145,00€
FG 536/1	18	145,00€
FG 536/2	18	149,00€
FG 536/3	18	169,00€
FG 538/1	18	489,00€
FG 538/2	18	539,00€
FG 539/1	18	699,00€
FG 540/1	18	639,00€
FG 540/2	18	729,00€
FG 540/3	18	849,00€
FG 543/DG1	19	399,00€
FG 543/DG2	19	469,00€
FG 544/1	19	119,00€
FG 544/2	19	129,00€
FG 544/3	19	139,00€
FG 544/4	19	169,00€
FG 546/DG	19	199,00€
FG 547/DG	19	129,00€

CODICE	PAGINA	€/Pz
FG 581/A	19	529,00€
FG 581/B	19	799,00€
FG 600/SC16	2	139,00€
FG 600/SC25	2	219,00€
FG 600A/SC16	2	149,00€
FG 600A/SC25	2	229,00€
FG 600L/SC10	2	99,00€
FG 600XL/SC7	3	129,00€
FG 600TW/S12	3	119,00€
FG 600E/S4	3	33,90€
FG 602/SC13	3	89,00€
FG 603/S28A	130	559,00€
FG 603/S28B	130	559,00€
FG 603/TA1	131	149,00€
FG 605/ST11-B	5	139,00€
FG 606/SP9	5	85,00€
FG 610FL/SP9	5	149,00€
FG 615/SC8	3	69,00€
FG 615A/S6	5	79,00€
FG 618/S7B	4	159,00€
FG 618/S7	4	175,00€
FG 618/S10	4	249,00€
FG 621H/S8C	4	99,00€
FG 621TX/S13	4	149,00€
FG 622A/S2	5	49,00€
FG 623H/S6	4	72,00€
FG 623H/S8	4	105,00€
FG 623H/S14	4	209,00€
FG 624/S25	6	49,00€
FG 625/S15	6	59,00€
FG 625/S110	7	259,00€
FG 625/S27	7	99,00€
FG 625TX/S77	9	179,00€
FG 628/S6	11	59,00€
FG 628/S12	11	79,00€
FG 628/S7	116	69,00€
FG 628/R17.5	116	12,90 €
FG 628/R18.5	116	12,90 €
FG 628/R21.5	116	13,90 €
FG 628/R22.5	116	13,90 €
FG 628/R27.5	116	15,90 €
FG 629A/S15	10	339,00€
FG 629B/S15	10	339,00€
FG 629C/S10	11	179,00€
FG 630A/S14	11	499,00€
FG 718/2.5T	136	249,00 €

CODICE	PAGINA	€/Pz
FG 718/3.5T	136	299,00 €
FG 719/2T	137	369,00 €
FG 721/2T	137	399,00 €
FG 722/5T	137	759,00 €
FG 725/3T	138	52,90 €
FG 725/6T	138	89,00 €
FG 725/12T	138	159,00 €
FG 735/4T	138	45,00 €
FG 735/6T	138	52,00 €
FG 735/10T	138	75,00 €
FG 735/16T	138	89,00 €
FG 735/20T	138	109,00 €
FG 738/1T	138	579,00 €
FG 740/0.6T	137	319,00 €
FG 742/20TP	134	1.099,00 €
FG 742/30TP	134	1.399,00 €
FG 742/50TP	135	2.499,00 €
FG 745/CMR	135	499,00 €
FG 745/CMF	135	249,00 €
FG 748/0.5T	138	132,00 €
FG 750/A	138	229,00 €
FG 750/1P	133	1.599,00 €
FG 750/2P	133	1.899,00 €
FG 752/1P	133	1.799,00 €
FG 752/2P	133	2.099,00 €
FG 1425	27	59,90€
FG 1426	27	72,90€
FG 1427	27	99,00€
FG 1433	27	99,00€
FG 1434	27	89,00€
FG 1440	27	29,90€
FG 1445	27	24,90€
FG 1450	26	79,90€
FG 1452	26	85,90€
FG 1454	26	109,00€
FG 1456	26	139,00€
FG 1460	26	89,00€
FG 1465	26	119,00€
FG 1009/M	139	32,90€
FG 1009/L	139	32,90€
FG 1009/XL	139	32,90€
FG 1010/M	139	15,90€
FG 1010/L	139	15,90€
FG 1010/XL	139	15,90€
FG 1020/M	139	79,00€
FG 1020/L	139	79,00€

CODICE	PAGINA	€/Pz
FG 1020/XL	139	79,00€
FG 1022/M	139	99,00€
FG 1022/L	139	99,00€
FG 1022/XL	139	99,00€
FG 1015	139	7,90€
FG 1016	139	17,90€
FG 1014	139	12,90€
FG 1012	139	32,90€



DISTRIBUTORE UFFICIALE

FASANGAS S.r.l.

SEDE LEGALE E LOGISTICA

Viale Grecia 3, lotto 18
- 73100 Zona Ind.le LECCE - ITALY

SEDE PRODUTTIVA

Viale Irlanda 3 - 73100
Zona Ind.le LECCE - ITALY
(+39) 0832.362097/364265

info@fasanotools.com



8 054341 830781

VALIDITA':
02-02-2026 / 31-01-2027

FASANOTOOLS.COM



FASANO
TOOLS

