



THE
ONYX
COLLECTION

Elegance for your bath

Showers – Lavatories – Tub Surround & Shower Walls – Other Bath Accessories
– Yes! Guaranteed Forever –

About The Onyx Collection

The Onyx Collection manufactures shower bases, shower wall panels, lavatories, tub surrounds, shower seats, accessories and trim to your specifications in almost any color, shape and size. Founded in 1985, the Onyx Collection now employs over 500 in Northeast Kansas. Quality products, our "Yes! Guaranteed Forever" guarantee, quick delivery, ease of installation and our unique chemistry and design have made us legends in the industry.



Yes! Guaranteed Forever

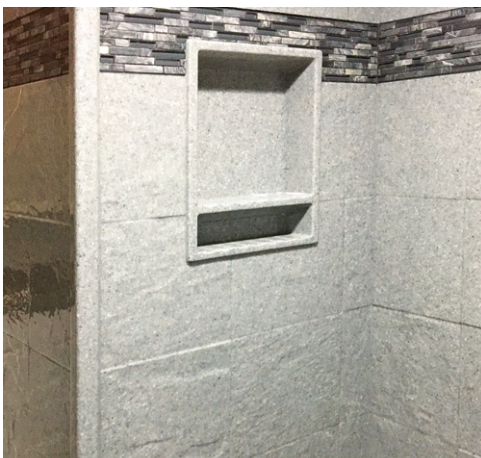
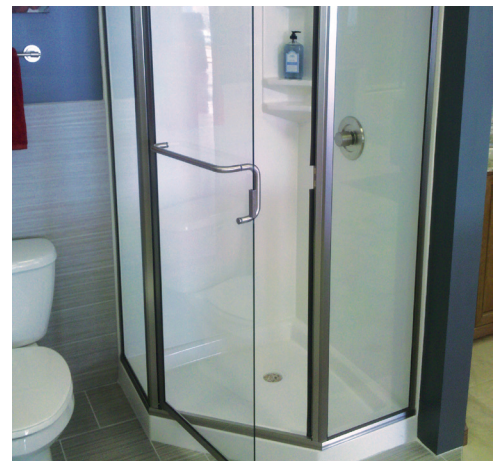



Lavatories - Rectangle

All Rectangular Lavatories have at least one integral (molded in) bowl. All rectangular lavatories have an integral backsplash and are based on standard cabinet sizes. Our standard depths are 19", 22" and 22 1/2".



Non Recessed Royale Bowl



Venetian Bowl



Atlantic Bowl

Edge Styles



Flat

Ogee

Beveled

Double Eased Edge

Bowl Styles

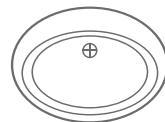

Recessed Oval

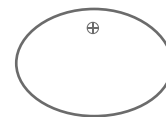

Non-Recessed Oval

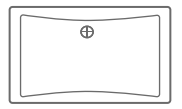

Venetian

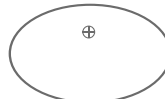

Tuscan

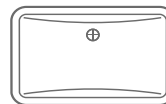

Wave



Non-Recessed Royale

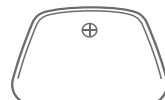

ADA



Daytona



Olympic

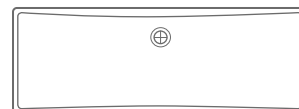

Atlantic

Multiple Colors

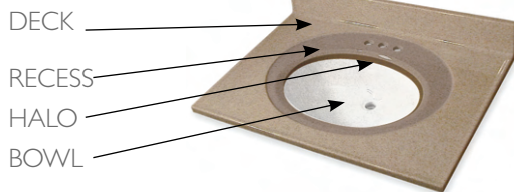

Lavatory Measuring Hints

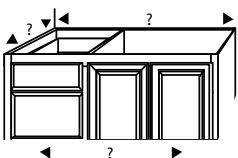

- Start with cabinet dimensions
- For each end that is not against a wall, add 1/2" for overhang
- Add 1" for overhang in the front, (add 1 1/2" for cabinets with full overlay doors)
- Center bowl between cabinet doors

Lavatories - Custom Shape

Custom shape lavatories can be any length, depth, thickness, or shape and can incorporate any of our bowl styles and edge styles. Please specify faucet hole spacing when ordering: 4" is typical for a one-piece faucet set; 8" is used for three piece sets. We can also do single holes, and even add an extra hole for a soap dispenser if requested. Common depths for custom shape lavatories are 19", 22", 22 1/2", 25" & 25 5/8".



Wave Bowl



Non Recessed Oval Bowl



Non Recessed Oval Bowl



Wave Bowl

Edge Styles & Thickness Options

Edge



Thickness



Bowl Styles

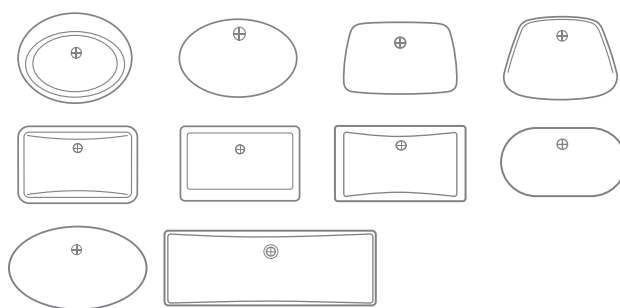

Shape Options

Custom lavatories can be ordered in almost any shape, size and configuration. The possibilities are endless...If you can dream it, we can make it.



Recessed Oval Bowl



Recessed Oval Bowl

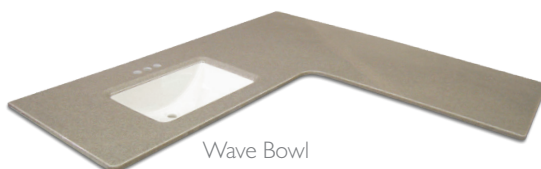

Wave Bowl



Atlantic Bowl

Shower Wall Panels

Available in 5 finishes: Gloss, Stone Tile, Subway Tile, 8"x24" Wavy Tile, and Shiplap. Onyx wall panels are 3/8" thick and come standard with 2 finished edges.

Shower kits are commonly 78", 84", 90", 96", 102" or 108" high.

Gloss

Our most popular finish, the smooth Gloss Finish gives a classic appearance with an easy to clean smooth surface. All colors are available in the Gloss Finish. Also, Inlay Stripes and Picture Inlays are available in the Gloss Finish.

Max Panel Size: 144 $\frac{1}{2}$ " x 100 $\frac{7}{8}$ "



Stone Tile

Our production mold was made from natural 12" x 12" stone tiles which gives each wall panel the look of stone tile without the worry of leaking grout seams. All colors are available in Stone Tile Finish.

Max Panel Size: 104 $\frac{7}{8}$ " x 93 $\frac{1}{4}$ "



Shower Wall Panels

Subway Tile

Subway Tile Wall Panel Finish is a smooth, flat tile design with faux grout lines. -- The size of the "tile" is 3" x 9 5/8" and the 1/4" wide grout groove is 1/32" deep. Subway Tile panels are priced the same as Smooth Gloss.

Max Panel Size: 105 3/4" x 87 1/2"



8" x 24" Wavy Tile

The Wall Panel Finish is a glossy tile design with faux grout lines. The size of the tiles are 8" high and 24" wide. Wavy panels are priced the same as Smooth Gloss.

Max Panel Size: 104 7/8" x 96"



Shiplap Finish

Smooth panel with 1/4" wide recessed groove. The spacing between the grooves is 5".

Max Panel Size: 109 3/4" x 96"



Shower Bases - Standard

A typical Onyx Collection "Standard" shower consists of a shower base and 3 wall panels (2 for Neo-Angle & Dual Curb). A ceiling panel may also be added. All the standard size shower bases and curb styles are listed in this section, along with shower kits which include the wall panels and adhesive & color match silicone for installation.

Curb Style Options

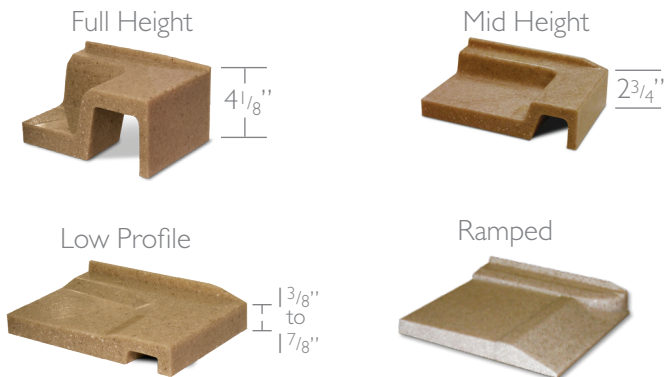

Shape Options

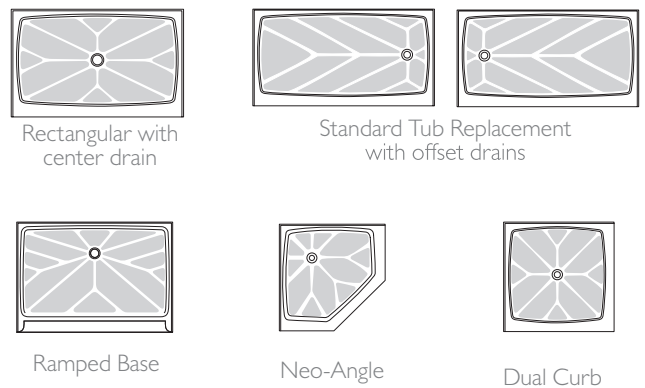



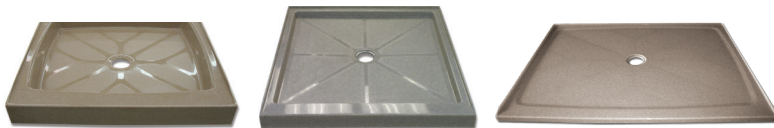

Center Drains

Available in many sizes, center drain standard shower base options will fit almost any bathroom design. A standard size will work for most remodels and can be matched with our wall panels, shower accessories and shower seats.

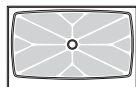

Available Styles & Sizes



	Width x Depth			
Full Height 	32 x 32	42 x 34	48 x 36	60 x 32
	36 x 32	42 x 36	48 x 42	60 x 34
	36 x 34	42 x 42	48 x 48	60 x 36
	36 x 36	42 x 48	54 x 32	60 x 42
	36 x 42	48 x 30	54 x 36	60 x 38
	36 x 48	48 x 32	54 x 42	
	42 x 32	48 x 34	60 x 30	
Mid Height 	36 x 36	48 x 34	60 x 32	
	38 x 37	48 x 36	60 x 34	
	42 x 36	48 x 42	60 x 36	
	42 x 42	48 x 48	60 x 42	
	48 x 32	54 x 36	60 x 48	
Low Profile 	36 x 36	48 x 42	60 x 36	
	42 x 36	48 x 48	60 x 42	
	48 x 32	54 x 36	60 x 48	
	48 x 34	60 x 32		
	48 x 36	60 x 34		
Add-on ramp available for all low profile bases				
Ramped 	60 x 42			
	60 x 60			

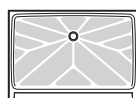

Standard Base, Shiplap Walls, with Floating Corner Shelf

Shower Bases - Standard

Offset Drain Sizes

These shower bases are commonly used to replace bath tubs with offset drains and are available in full height 4 1/8", low profile 1 3/8", and now mid height 2 3/4".

There are several unique sizes to fulfill the needed flexibility in the tub-to-shower remodels.



Low Profile Base With Offset Drain, & Corner Caddies

Available Styles & Sizes

Full Height

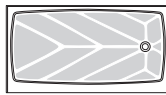
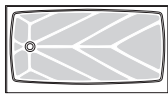
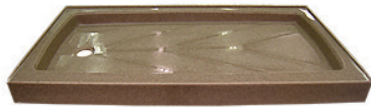

Left Drain

Right Drain

54 x 30
60 x 30
60 x 32
60 x 34
60 x 36

54 x 30
60 x 30
60 x 32
60 x 34
60 x 36

Mid Height

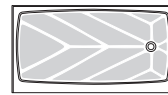
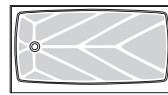

Left Drain

Right Drain

60 x 30
60 x 32
60 x 34
60 x 36
60 x 42

60 x 30
60 x 32
60 x 34
60 x 36
60 x 42

Low Profile

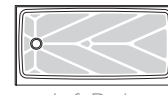

Left Drain

Right Drain

48 x 32
60 x 30
60 x 32
60 x 34
60 x 36
60 x 42

48 x 32
60 x 30
60 x 32
60 x 34
60 x 36
60 x 42



Shower Bases - Standard

Neo-Angle

A typical Onyx Collection "Standard" Neo-Angle Shower consists of a Neo-Angle Shower Base and two Wall Panels. A ceiling panel may also be added.

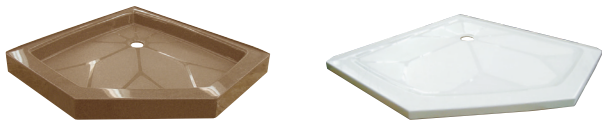

Available Styles & Sizes



Standard Neo-Angle with Semi-Frameless Glass

Dual Curb

We have one Standard Dual Curb shower base. It is a Mid Height 36" x 36" with a center drain. For other sizes or configurations, see the Custom Showers section of this catalog, where you will discover endless possibilities.

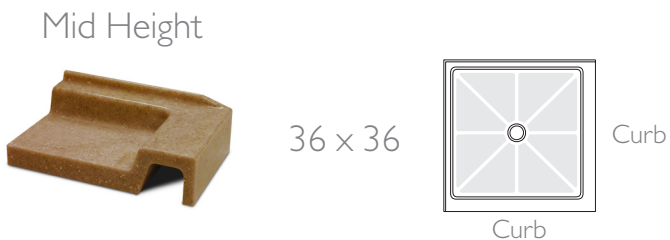

(Dual Curb with Frameless Door)

Installed Showers

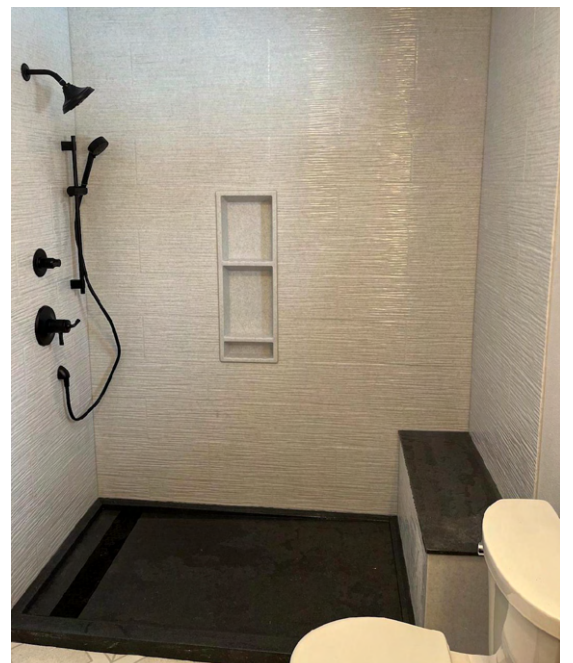
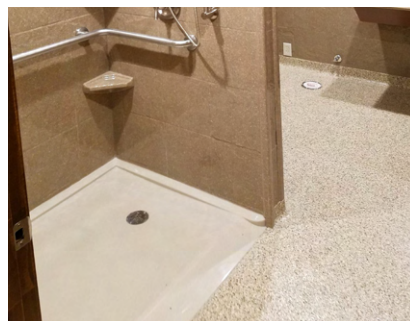
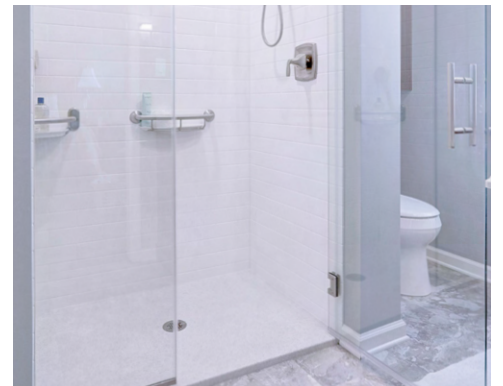

Shower Bases - Custom

A typical Onyx Collection "Custom" Shower consists of a shower base and one panel for each wall. An endless variety of custom configurations are possible from traditional designs to elaborate walk-in designs. Any design can be enhanced with wider curbs for glass block walls, ceiling panels and even specially designed components for accessibility including ramped curbs, and low profile curbs.

Curb Options

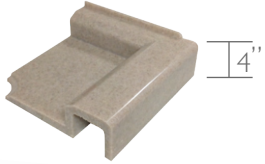

The Custom Full Height Curb height is 4" tall. This curb height works well with both shower doors and curtains. All curbs have a slope back into the shower area and the shower area has a 1/4" per foot slope towards the drain.

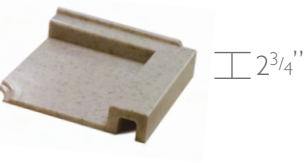

The Custom Mid Height Curb height is 2 3/4" tall. The Mid Height is designed with a more modern, straight line look and a lower, narrower curb for easier access and to give a little more room in the shower. It also has the benefit of working well with shower doors and curtains. The shower area has a 1/4" per foot slope towards the drain.



The Custom Low Profile Curb height may be as low as 1 3/8" and as tall as 2 1/4" depending on shower size. This lower curb height is good for easy access, adding a ramp, or for recessing into the floor for a curbless entry. The low profile curb has a slope back into the shower area and the shower area has a 1/4" per foot slope towards the drain.

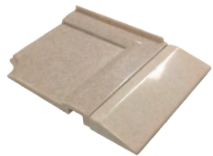

The add-on ramp can be used with any low profile shower base. It can be made to any length to accommodate your custom shower design and can be removed if not needed.



The integral add-on ramp is a clean one piece design that makes easy access with wheel chairs. This ramp can be built into any of our shower bases.

Shape Options

With unlimited custom shapes available, all of our custom shower bases are cast in pieces to your specifications and then chemically bonded into a single unit for easy, worry-free installation.

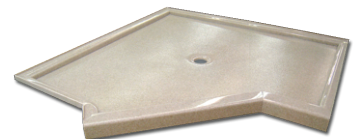

Neo Angle offset base with tile walls



Walk-In Base



Curved base with ceramic tile walls



Walk-In with Frameless Door

Shower Bases - Custom



Custom walk-in designs with offset curb and rear corner clip



Low Profile 3-Sided Base

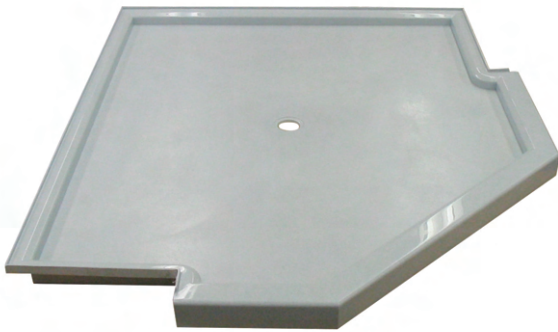

Custom neo-angle base with dual return walls



Full Height Custom Corner Base With Bench



Custom Walk-In, Clipped Corner With Tile Walls

Shower Doors

Fully Frameless - Hinged Doors

8" Pull Handles are standard
Finish Options: Silver, Brushed Nickel, Oil Rubbed Bronze & Black
3/8" thick: Clear, Obscure, & Tinted Glass
Door Height: 72"
Door must hinge on wall side
There must be wood in walls where glass attaches

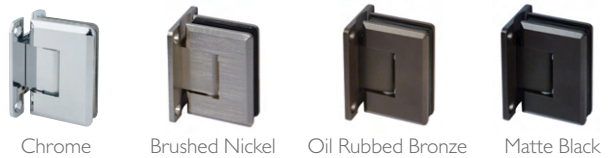

Fully Frameless - Barn Doors

Available in 3/8" clear, obscure & tinted glass
Standard height is 74"
Chrome, Brushed Nickel, Oil Rubbed Bronze & Black

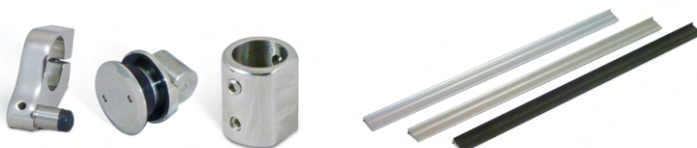

Shower Doors

Bypass Slider Doors - 1/4" Thick

Available in 1/4" Clear, Obscure, & Tinted Glass

Towel bar on inside & outside

Standard height is 73 3/4"

Silver, Brushed Nickel, or Oil Rubbed Bronze



Semi-Frameless - Hinged Doors

Available in 3/8" clear, obscure & tinted glass

Standard height is 71 1/2"

Finishes: Chrome, Brushed Nickel, & Oil Rubbed Bronze



Glass



Clear (1/4" Thick)
or 3/8" for Fully Frameless



Obscure Aquatex (1/4" Thick)
or 3/8" for Fully Frameless



Satin (1/4" Thick)
or 3/8" for Fully Frameless



Rain (1/4" Thick)
or 3/8" for Fully Frameless

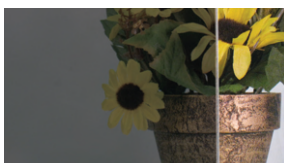

Smoke Gray (1/4" Thick)
or 3/8" for Fully Frameless

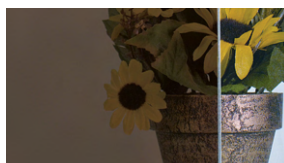

Smoke Bronze (1/4" Thick)
or 3/8" for Fully Frameless



Pattern 62 (1/4" Thick)
or 3/8" for Fully Frameless

Accessories

Caddies & Shower Accessories

We offer various sizes and styles of bathroom shower soap or shampoo caddies, grab bars, robe hooks and foot rests.



Shower Seats

Wall Mount

Corner Wall Mount seats Come in 3 sizes, 14", 18" and 26" Extended. When ordering the extended, please specify right or left. These are available in any of our colors and can be installed on Onyx or tile.



18" Diamond Corner Seat



16" x 26" Diamond Extended Seat (Right Shown)



18" Diamond Enclosed Corner Seat



14" & 18" Pearl Corner Seat



18" x 26" Pearl Extended Seat (Right Shown)



18" Pearl Enclosed Corner Seat



Extended Corner Seat - Pearl Shown

Built-In Bench

Bench seats can be installed with either standard or custom shower bases. A bench seat is 5/8" thick with 1/4" x 1/2" flange on wall sides & has a rounded front edge for comfort.

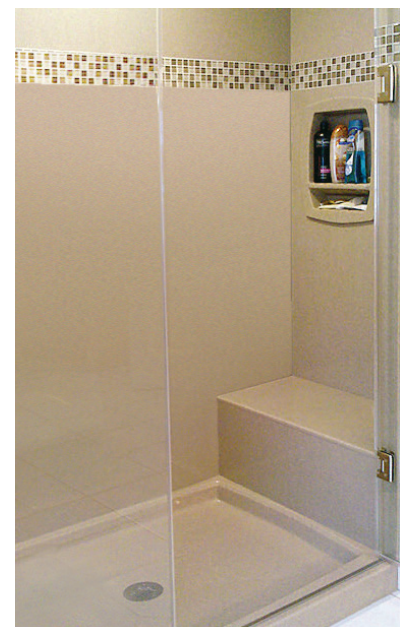
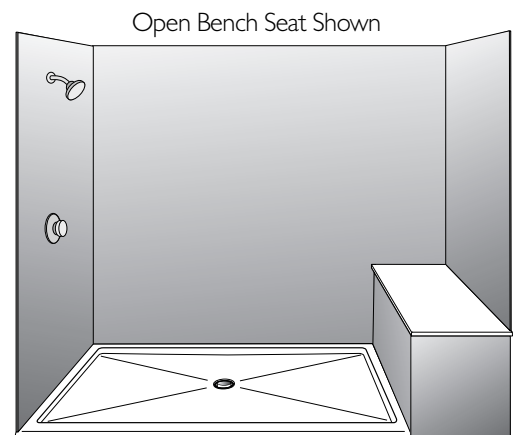
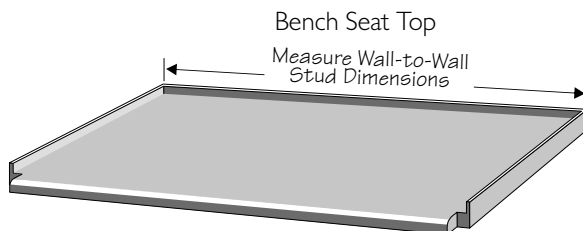

Shower Trim

Decorative Trim

To accent your bathroom and shower, choose from our many styles and sizes of decorative trim.

Crown Molding & Corner Block

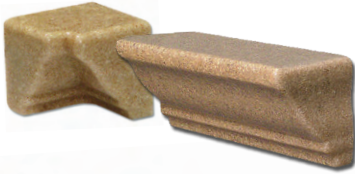

Casing - Windows & Doors



Chair Rail



Baseboard with Base Shoe



Base Shoe

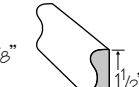
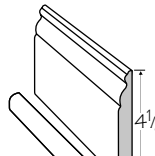
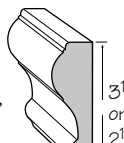
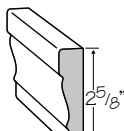
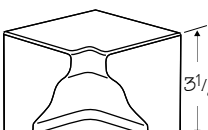
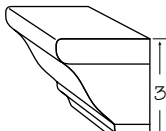
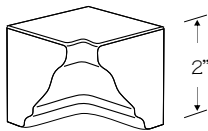
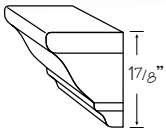

Crown Molding

Crown Corner Block

Case Molding

Chair Rail Molding

Baseboard & Shoe Molding

Cove Molding



Corner & Flat Trim

Inside Corner Trim



Flat Smooth Trim (3/8" Thick)



Available in: 2", 3", 4", 5", 5 1/2", 6", 8", & 12" widths. Custom widths also available.

Edge Cap Trim



Tile Trim



Available in:
4" x 4" pattern
4" x 6" pattern
6" x 12" pattern

Outside Corner Trim

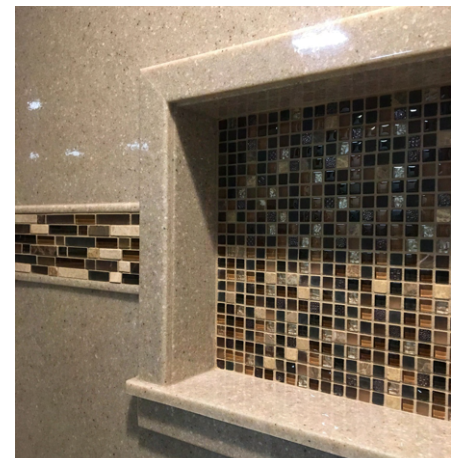

Edge Cap Trim

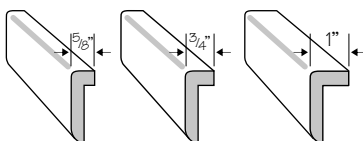

Outside Corner Trim

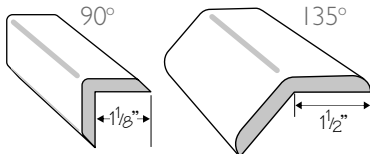

Inside Corner Trim

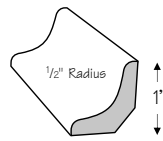

Shower Trim

Mosaic Tile and Recessed Trim

The Mosaic Tile and Installation Kit work well with the Onyx Recessed Trim for Mosaic Tile. The Tile is custom designed to match Onyx Color tones and is made in the USA. The installation kit includes: Grout, drop cloth, squeegee, tape, silicone, sponge & bucket.



Recessed Trim for Mosaic Tile



Installation Kit

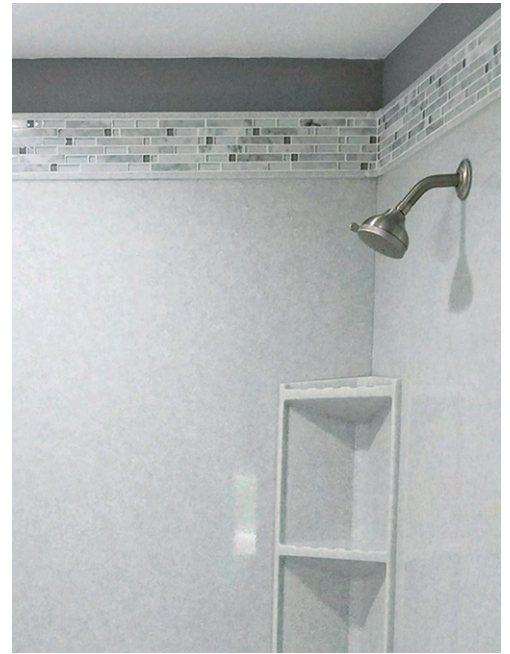

Colors and Styles Available

White / Gray
- Linear-



White / Gray
- 2 Row Combo -

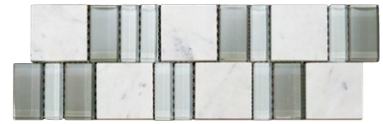

Black /Charcoal
- Linear-



Black /Charcoal
- 2 Row Combo -

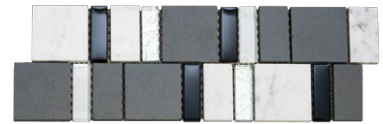

Light Neutral
- Linear-



Light Neutral
- 2 Row Combo -



Medium Neutral
- Linear-



Medium Neutral
- 2 Row Combo -



Dark Neutral
- Linear-



Dark Neutral
- 2 Row Combo -



The Onyx Collection
105 Broadway St. Belvue, KS 66407
800-669-9867 (phone) 785-456-8604 (phone)
800-393-6699 (fax) 785-456-8204 (fax)
www.onyxcollection.com