



EARN SCHIEDEL
INSTALLER REWARDS!

SCHIEDEL

ICS

80-300mm Diameter Range
Twin Wall Insulated System Chimney for
Gas, Oil, Wood and Multi-fuel Applications



DON'T FORGET TO REGISTER YOUR INSTALLATIONS
AND START EARNING SCHIEDEL INSTALLER REWARDS
See inside for more details

www.schiedel.com/uk

SAP 940002245 - October 2021

Application

ICS is a twin wall insulated chimney system for use on open and closed stoves, open fires, residential and small commercial multi-fuel appliances, with continuous operating temperatures up to 450°C.

ICS Plus ICS is converted into ICS Plus by adding a lip seal to each component with a male form on the liner (see ICS Plus diagram below). This creates a twin wall insulated chimney system designed for the new generation of condensing gas and oil appliances, with continuous operating temperatures up

to 200°C and positive pressure up to 200Pa at the appliance outlet.

Other ICS Ranges For larger commercial and industrial applications of ICS in diameters 350mm to 700mm please refer to our separate sales brochure. For higher pressure applications up to 5000Pa e.g. generators, combustion and process equipment, please see the commercial brochure.

Product Description

ICS PRODUCT FEATURES

- Simple push-fit jointing system, secured by locking band.
- Advanced corrosion resistant design and construction uses laser welded 316L stainless steel inner liners and stainless steel case. The only stainless steel system to have passed the internationally recognised GASTEC corrosion test.
- The jointing system increases rigidity and ensures easy drain-down of any condensate in the flue.
- Capillary break prevents moisture being drawn through the joint.
- Because of the sleeve joint, the insulation in the pipe is able to be continuous over the length of the system ensuring no hot spots.
- The 25mm high efficiency Superwool™ blanket maintains flue gas temperature, maximising efficiency, improving flue draught on start up and minimises condensation.
- Low external case temperature.
- The assembly method allows the inner liner to expand and contract with temperature at the female end. The flue can withstand the temperatures of a soot fire without losing the integrity of the joints.
- Generous lead-in edges on liner and case for ease of jointing.

ICS PLUS PRODUCT FEATURES

- ICS Plus for condensing appliances is created by adding a lip seal gasket that can maintain positive pressure up to 200Pa. All the design and construction benefits of ICS apply.

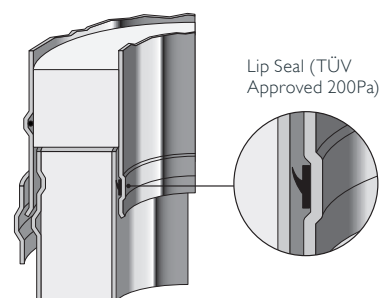
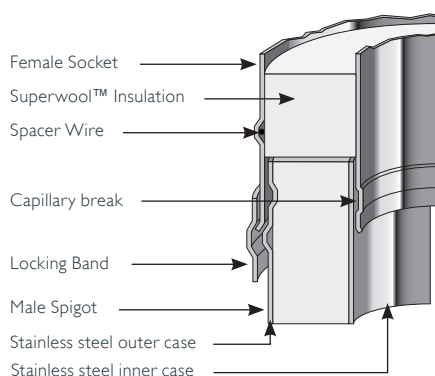

Technical Data

	ICS	ICS Plus
Fuel	Gas, Oil, Wood, Coal	Gas, Oil
Firing Temp	450°C	200°C
Thermal Shock	1000°C	-
Mode of Operation	Zero & Negative Pressure	Positive Pressure
Pressure Capabilities	40Pa	200Pa
Fire Rating	4 Hour Fire Rating to BS 476 Part 20	
Outer Case (Standard)	Stainless Steel	
Outer Case (Option)	Painted	
Outer Case Thickness	0.6mm	
Seam	Laser or inert gas welded	
Liner	316L : 1.4404 : X2CrNiMo 17-12-2	
Liner Thickness (mm)	0.5mm	
Seam	Laser or inert gas welded	
Insulation	High Performance Mineral Fibre	
Insulation Thickness	25mm	
Average Thermal Resistance (200°C)	0.4m ² kW	

Approvals

ICS is CE Certified to EN1856-1 TÜV 0036 CPR 9195 001 with designations:
 ICS is CE Certified to EN1856-2 TÜV 0036 CPR 9195 041 with designations:



System Chimney EN1856-1		
T450 N1 W V2 L50050 G60 T450 N1 D V3 L50050 G60 60mm Distance to combustibles in a combustible shaft*	T450 N1 W V2 L50050 G50 T450 N1 D V3 L50050 G50 50mm Distance to combustibles in a non combustible shaft or in free air*	T200 P1 W V2 L50050 O00 Zero distance to combustibles*
Connecting Flue Pipe EN1856-2		
T450 N1 D V2 L50050 G100 M		

* For full information refer to p.29

Schiedel has recently successfully carried out fire resistance tests according to the latest European standard EN 1366-13:2019 "Fire resistance tests for service installations, Part 13: Chimneys" and has reached EI 120 classification for our Double Wall Insulated System Chimney ICS in a closed scenario (type A) for both vertical and horizontal set-ups.

Schiedel is the first European chimney manufacturer to have performed the tests according to this latest fire resistance standard for chimneys.

- Manufactured under a Quality Management Scheme approved to BS EN ISO 9001
- 4 Hour Fire Rating to BS476 Part 20
- Certified for corrosion resistance on gas, oil and solid fuel by Gastec, MPA and TÜV
- HETAS listed for use on solid fuel applications.

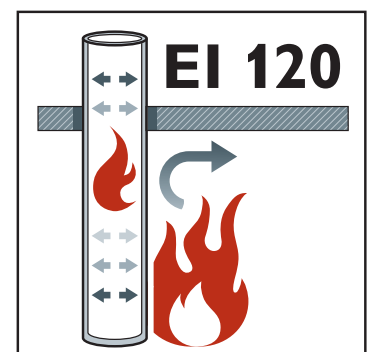

Corrosion Resistance

Chimneys are subject to significant corrosion attack by flue gas condensates, particularly from solid fuel and condensing appliances. ICS is specifically designed and manufactured to resist

this corrosion. It is the only stainless steel chimney system in the world to have passed the internationally recognised Gastec corrosion test.

Flue Size Selection Guide

The chimney size should be as recommended by the appliance manufacturer. Where there is a requirement for a flue diameter smaller than the appliance spigot, then the operational requirements of the appliance and the configuration of the flue must satisfy the flue sizing requirements of 13384-1 (single appliances) and 13384-2 (multi appliances). For more information contact the helpline (0191 4161150). The information and sizes below are provided as a nominal guide only. Flue sizing for

appliances, particularly commercial/industrial applications, will vary depending on siting details and appliance manufacturer's instructions and design criteria. These will override the sizing guide and reference must be made to appliance manufacture. For Inglenook and non-standard openings, the diameter of the flue must be at least 15% of the cross sectional area of the fireplace opening.

	80 mm	100 mm	130 mm	150 mm	180-300 mm
Gas - Atmospheric Boiler Input up to 25kW Input 25kW to 40kW Input 40kW to 60kW		●	●	●	
Gas - Commercial/ Industrial Boiler Input up to 50kW to 70kW					●2
Gas Fires 'Radiant' to BS7977-1 2002 'Inset' to BS7977-1 2002 'Backboiler' to BS7977-2 2003			●1 ●1 ●1		●1
Gas Water Heaters Input up to 25kW Input 25kW to 55kW Input 55kW to 60kW Input over 60kW	●	●	●	●	●2
Gas Warm Air Units Input up to 18kW Input 18kW to 35kW Input 35kW to 60kW Input over 60kW		●	●	●	●2
Gas Stove Cooker		●2	●2	●2	
Kerosene (28 sec Class C2) Heating Boiler Output up to 25kW Input 25kW to 45kW Input 45kW to 70kW		●	●	●	
Kerosene Stove/Cooker		●3	●3	●3	
Kerosene Water Heater Input up to 41kW				●	
Kerosene Visual Effect Stove Output up to 17kW		●3	●3		

NOTES:

- 1 Subject to appliance manufacturer's testing criteria.
- 2 Subject to manufacturer's input rating and chimney height.
- 3 Subject to manufacturer's output rating and chimney height.
- 4 Min 300mm depending on opening, chimney size and height.
- S Smokeless fuel only.
- SC Smokeless fuel or coal.

	100 mm	130 mm	150 mm	180 mm	200 mm	230 mm	250 mm	300 mm
Gas Boiler - Forced Draught Input up to 25kW Input 25kW to 45kW Input 45kW to 50kW Input 50kW to 75kW Input 75kW to 100kW Input over 100kW	●	●	●	●	●	●	●2	
Gas Fires 'Inset' to BS7977-1 2002 'Decorative' to BSEN 509:2000				●1 ●				
Gas Oil (35 sec Class D) Heating Boiler Output up to 25kW Output 25kW to 45kW Output 45kW to 70kW Output 70kW to 100kW Output over 100kW	●	●	●	●	●3	●3	●3	
Solid Fuel Heating Boiler Input up to 20kW Input 20kW to 30kW Input 30kW to 60kW			●S	●SC				
Open Fires (Standard Opening) 500mm x 550mm				●S	●SC	●SC	●SC	
'Avant Garde' Feature Open Fires								
Room Heaters					●	●	●	
Wood burning Stoves/ Cookers. Use only seasoned wood	●S						●4	
Inglenook or non-standard opening. Flue size dependant on cross-sectional area of fireplace opening.	●1	●	●	●	●	●	●	●

NOTES:

- 1 Subject to appliance manufacturer's testing criteria.
- 2 Subject to manufacturer's input rating and chimney height.
- 3 Subject to manufacturer's output rating and chimney height.
- 4 Min 300mm depending on opening, chimney size and height.
- S Smokeless fuel only.
- SC Smokeless fuel or coal.

System Design

OUTLET SITING

Flue terminations for solid fuel & oil are subject to BS EN 152. Figures A and B illustrate recommendations for the most commonly encountered outlet terminations. Flue terminations for gas in domestic situations are governed by BS EN 152 Section 4.2. Figure C illustrates recommendations for the most common siting situations encountered. Adjacent taller structures may require increased height. The minimum flue projection through the roof is 600mm to the underside of the terminal.

LOCATION OF OUTLET

Fig. A
Outlet siting for Oil Appliances (<45kW)

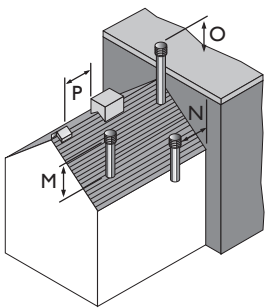
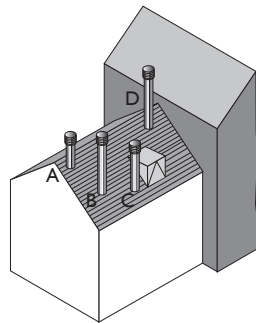

Fig. B
Outlet siting for Solid Fuel Appliances (<50kW)



FLUE ROUTING

The chimney should remain as straight as possible through its vertical run to assist flow. Should it be necessary to offset a chimney run the following guidelines should be adhered to: It is recommended that a vertical rise of 600mm should be allowed immediately above the appliance before any change of direction.

Within a system on solid fuels, there should be no more than 4 changes of direction of maximum 45°.

90° Factory made bends or tees within the system may be treated as being equal to two 45° bends (see Document J of the Building Regulations).

TERMINAL TYPES

On solid fuel appliances, an open termination is normally recommended. However in certain conditions, rain caps or anti-downdraught terminals may be used.

Rain caps and anti-downdraught terminals are available in two versions, with mesh/spark guard and without mesh. Where a terminal with mesh is used, there is a risk of soot build up, and therefore regular cleaning is required to avoid blockage, particularly when using oil or solid fuel.

PROVISION FOR SWEEPING, CLEANING AND MAINTENANCE

Provision should be made for inspecting and cleaning the chimney. To aid cleaning, sufficient distance should be left between changes of direction to permit the safe passage of cleaning brushes within the system. This is particularly important on solid fuel applications. It is recommended that chimneys serving solid fuel appliances be swept as frequently as necessary but at least twice a year. Choose an access component suitable for your installation unless cleaning/inspection can be done through the appliance.

OUTLET SITING FOR OIL APPLIANCES (<45KW)

Location of outlet		Pressure Jet Burner	Vapourising Burner
M	Above the highest point of an intersection with the roof	600mm	1000mm
N	From a structure to the side of the terminal	750mm	2300mm
O	Above a vertical structure which is less than 750mm (pressure jet burner) or 2300mm (vapourising burner) horizontally from the side of the terminal	600mm	1000mm
P	From a ridge terminal to a vertical structure on the roof	1500mm	Should not be used

System Design

OUTLET SITING FOR SOLID FUEL APPLIANCES (<50KW)

Point where flue passes through weather surface (Notes 1, 2)		Clearance to flue outlet
A	At or within 600mm of the ridge	At or within 600mm above the ridge
B	Elsewhere on the roof (whether pitched or flat (Note 2))	At least 2300mm horizontally from the nearest point on the weather surface (1) and: a) at least 1000mm above the highest point of intersection of the chimney and the weather surface; or b) at least as high as the ridge
C	Below (on a pitched roof) or within 2300mm horizontally to an openable roof-light, dormer window or other opening (Note 3)	At least 1000mm above the top of the opening
D	Within 2300mm of an adjoining or adjacent building, whether or not beyond the boundary (Note 3)	At least 600mm above any part of the adjacent building within 2300mm

1. The weather surface is the building external surface, such as its roof, tiles or external walls.
2. A flat roof has a pitch less than 10°.
3. The clearance for A or B, as appropriate, will also apply.
4. A vertical flue fixed to an outside wall should be treated as equivalent to an internal flue emerging at the nearest edge of the roof.

Fig. C
BS 5440-1 Outlet siting for
Gas Appliances (<70kW)

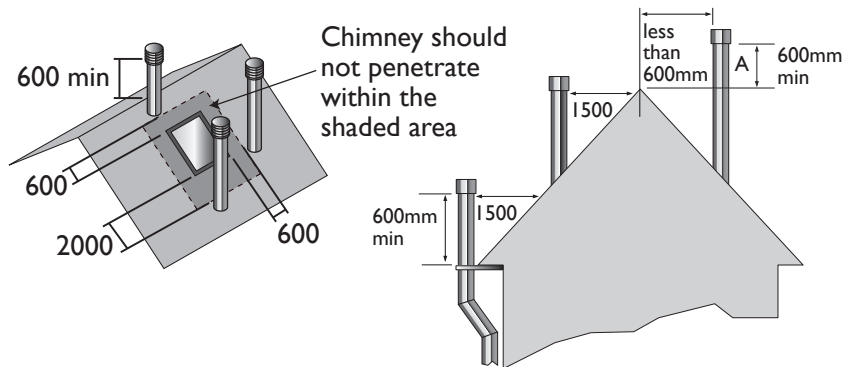

ROOM VENTILATION

The room carrying the appliance should have an air vent either direct to an external air source or vented into a room that has an external vent direct to an air source. This is required to provide adequate air supply to allow the appliance and flue to operate efficiently. These requirements are specified in the Building Regulations (Document J) also by CIBSE and BS5440.

COMMERCIAL INSTALLATIONS

Schiedel Rite-Vent can provide a full design & flue sizing advice service for commercial installations, using both ICID Plus and our ICS product ranges.

PROVISION FOR CONDENSATE DISPOSAL

(subject to appliance manufacturer recommendations)

Normally solid fuel and atmospheric gas and oil appliances will not need a drain unless rain ingress is significant. Most condensing appliances however need provision for drainage. As a rule of thumb a condensing boiler produces 1 to 1.5 litres of condensate per hour per 10kW of input.

This is a significant amount of acidic liquid which must be drained from the system. Choose appropriate flue drainage components, normally fitted at the base of the stack and close to the appliance outlet.

On high efficiency or on condensing systems, a 3° slope on horizontal runs is advised, using the appropriate 87° bend and 93° tee.

Typical Installations

TYPICAL CONDENSING BOILER INSTALLATION USING ICS PLUS

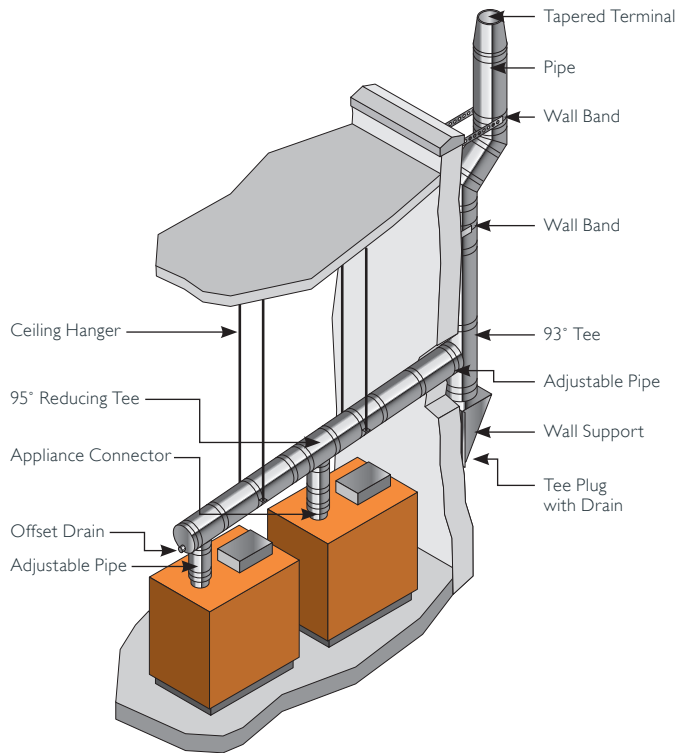

TYPICAL INSTALLATION USING ICS PLUS

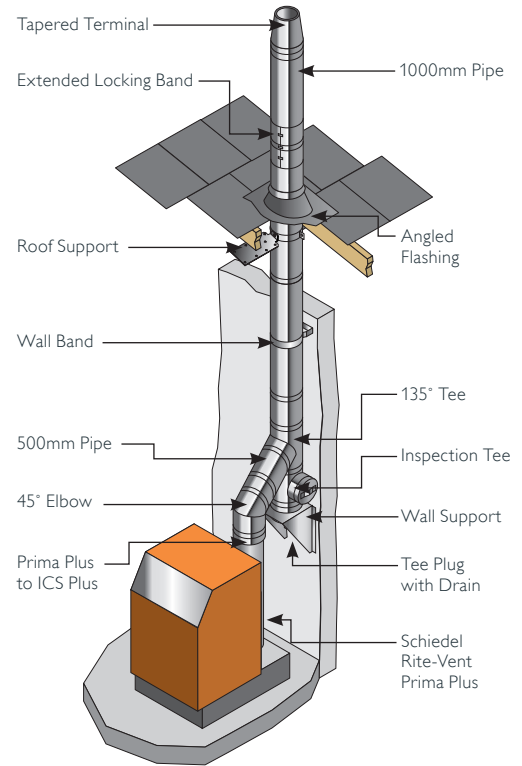

WOOD/MULTI-FUEL INSTALLATION

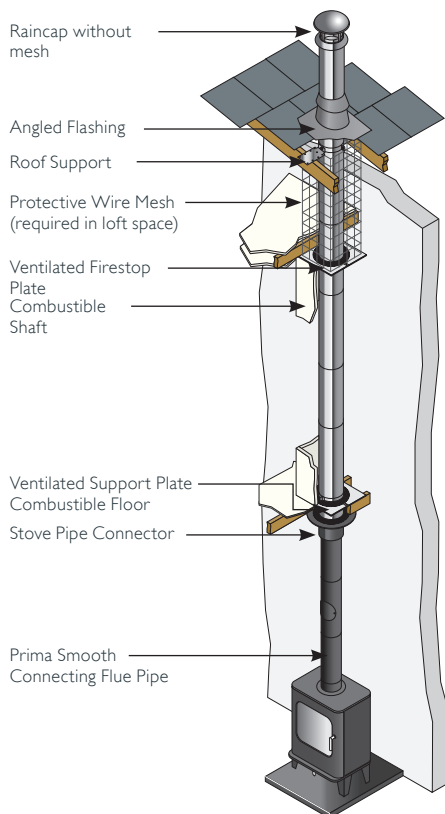

OPEN FIRE INSTALLATION

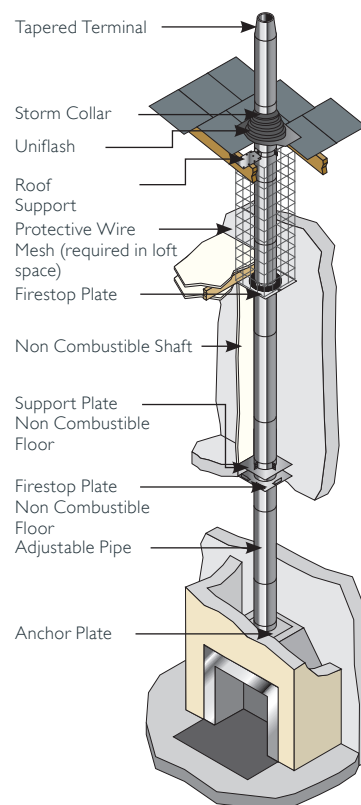

Typical Installations

TYPICAL BIOMASS INSTALLATION FROM TOP OUTLET USING ICS SYSTEM CHIMNEY

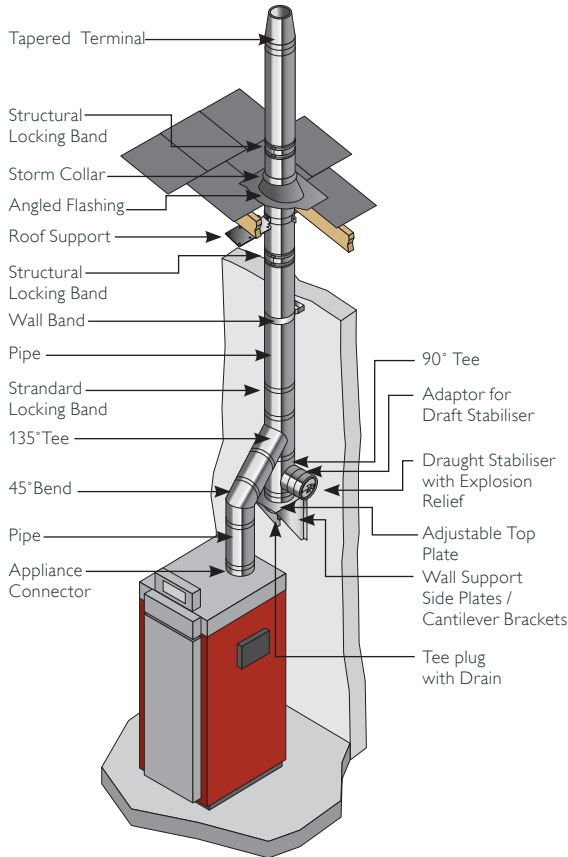

TYPICAL BIOMASS INSTALLATION FROM REAR OUTLET USING ICS SYSTEM CHIMNEY WITH 90° TEE SOLUTION

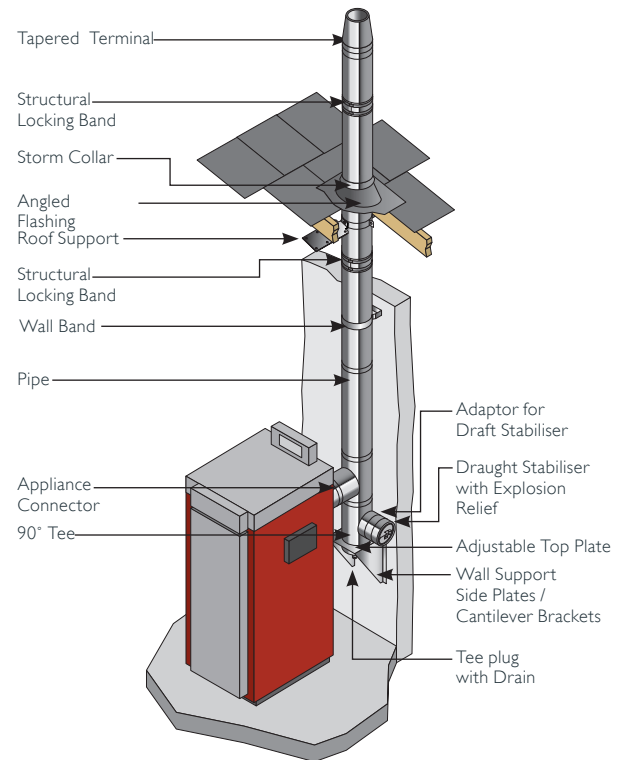

Product Ordering

The SAP codes shown in the tables next to each component should be used to order materials.

ICS Plus

ICS components are converted to ICS Plus components by adding a gasket to each component. When ordering ICS Plus, order the internal diameter sized gasket for each component. Some components are specifically manufactured for condensing appliances.

Finish

ICS & ICS Plus can be supplied painted in any RAL colour (additional costs apply).

Biomass Base Starter Kits

STARTER PACK 1

with 135° Tee for appliances with top or rear outlet

Ext Ø mm	150
Int Ø mm	200
SAP Code	128252

	ICS 45 Bend + Locking Band		ICS Wall Band 60mm		ICS 135° Tee + 2 Locking Bands
	ICS Wall Band Extensions Bracket		ICS 90° Tee + 2 Locking Bands		Roof Support
	ICS Plug Tee and Drain		Uniflashing		ICS Wall Support Top Plate + Locking Band
	Tapered Terminal + Locking Band				

STARTER PACK 2

with 90° Tee for appliances with rear outlet only

Ext Ø mm	150
Int Ø mm	200
SAP Code	138253

	ICS 90° Tee + 2 Locking Bands		ICS 90° Tee + 2 Locking Bands		ICS Wall Band 60mm
	ICS Plug Tee and Drain		ICS Wall Support Top Plate + Locking Band		ICS Wall Band Extensions Bracket
	Roof Support		Uniflashing		Tapered Terminal + Locking Band

Starting Components

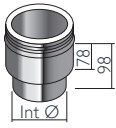

Appliance Connector										ICS J2147
Int Ømm	80	100	130	150	180	200	230	250	300	
Ext Ømm	130	150	180	200	230	250	280	300	350	
SAP Code	148384	148385	110916	111158	111468	111593	111960	112147	112636	

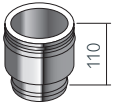

Connector - Prima Plus to ICS										ICS S068
Int Ømm	80	100	130	150	180	200	230	250	300	
Ext Ømm	130	150	180	200	230	250	280	300	350	
SAP Code	148399	149400	101178	101179	101180	101181	101360	101182	101183	

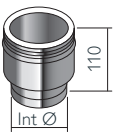

Connector - Prima Smooth to ICS										ICS PS068
Increasing Connector Prima Smooth to ICS*										ICS PS068
Int Ømm	80	100	125	125*	150	180	200	230	250	300
Ext Ømm	130	150	180	200	200	230	250	280	300	350
SAP Code	-	-	125388	145505	126291	134132	144449	-	-	-

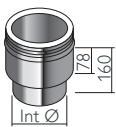

Biomass Appliance Connector										ICS J21F8
Int Ømm	80	100	130	150	180	200	230	250	300	
Ext Ømm	130	150	180	200	230	250	280	300	350	
SAP Code	-	-	125610	126139	-	-	-	-	-	-

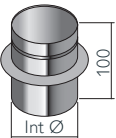

Starting Connector										ICS J2169
Int Ømm	80	100	130	150	180	200	230	250	300	
Ext Ømm	130	150	180	200	230	250	280	300	350	
SAP Code	148382	148383	110293	110509	110771	110921	111325	111519	112111	



Adaptor - ICS to Prima Plus										ICS J2178
Int Ømm	80	100	130	150	180	200	230	250	300	
Ext Ømm	130	150	180	200	230	250	280	300	350	
SAP Code	148397	148398	101192	101193	101194	101195	101361	101196	101197	



Adaptor - ICS to TecnoFlex Plus Screw Fit										ICS J2179
Int Ømm	80	100	130	150	180	200	230	250	300	
Ext Ømm	130	150	180	200	230	250	280	300	350	
SAP Code	130561	124814	111031	111281	111535	111743	112043	112255	112770	

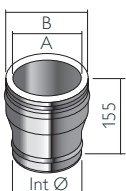

Increaser										ICS J2171
Int Ømm	80	100	130	150	180	200	230	250	300	
Ext Ømm	130	150	180	200	230	250	280	300	350	
A	100	130	150	180	200	230	250	300	-	
B	150	180	200	230	250	280	300	350	-	
SAP Code	148386	148387	101892	101893	101894	101895	101896	101897	-	

Starting Components

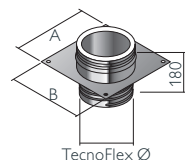
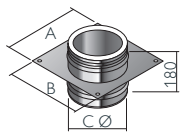

Anchor Plate - Plain Anchor Plate - TecnoFlex Plus Screw Fit Connection ICS J21D6

Int Ømm	80	100	130	150	180	200	230	250	300
Ext Ømm	130	150	180	200	230	250	280	300	350
A	250	270	300	300	320	350	370	400	420
B	220	240	270	270	290	320	340	370	390
C Ø	80	100	125	150	180	200	230	250	300
TecnoFlex Plus Ø	80	100	125	155	180	200	230	250	300
SAP Code Plain	148380	148381	101002	101003	101004	101005	101336	101006	101007
SAP Code Flex	-	-	142630	142631	142632	142633	-	-	-

Order code for Increaser Anchor Plate from 125 to 130mm is 125626

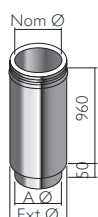

Stove Starter Pipe ICS J2175

Int Ømm	80	100	130	150	180	200
Ext Ømm	130	150	180	200	230	250
A	-	-	125	150	175	200
SAP Code	-	-	125640	126204	126908	127506

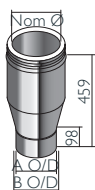

SW-DW Adjustable Starter Pipe Increasing SW-DW Adjustable Starter Pipe*

Int Ømm	80	100	130	130*	150	180	200
Ext Ømm	130	150	180	200	200	230	250
A O/D	-	-	122.7	122.7	147.6	176.5	197.5
B O/D	-	-	130	130	154.5	183.5	204.5
SAP Code	-	-	133653	143702	133654	133655	133656

This component MUST only be fitted to stove pipe and NOT directly to appliance.

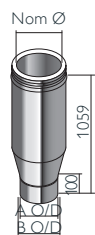

SW-DW Adjustable Starter Pipe 1200mm

Int Ømm	80	100	130	150	180	200
Ext Ømm	130	150	180	200	230	250
A O/D	-	-	122.8	147.7	179.6	197.6
B O/D	-	-	130	154.5	183.5	204.5
SAP Code	-	-	149567	149568	149569	149570

This component MUST only be fitted to stove pipe and NOT directly to appliance.

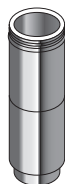

DW Adjustable Starter Section 1025mm Eff. Length

Int Ømm	80	100	130	150	180	200
Ext Ømm	130	150	180	200	230	250
SAP Code Plain	-	-	152239	152240	152241	152242
SAP Code Black	-	-	-	152247	-	-



DW Adjustable Starter Section 600mm Eff. Length

Int Ømm	80	100	130	150	180	200
Ext Ømm	130	150	180	200	230	250
SAP Code Plain	-	-	152243	152244	152245	152246
SAP Code Black	-	-	-	152248	-	-

Pipes

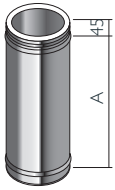

Effective Length			A		955	750	455	205	150	
			Part ref.		ICS	J2101	J21F9	J2102	J2103	J2104
Int Ømm	80	100	130	150	180	200	230	250	300	
Ext Ømm	130	150	180	200	230	250	280	300	350	
SAP Code 955	116493	117091	117623	117960	118311	118468	118713	113605	100691	
SAP Code 750	-	-	-	126161	126877	-	-	-	-	
SAP Code 455	113542	114693	115393	115902	116368	116715	117086	117321	100691	
SAP Code 205	111569	111980	112593	112909	113364	114271	114610	114926	100677	
SAP Code 150	111160	111471	111949	112244	112673	112961	113282	113516	100663	

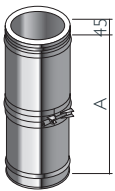

Adjustable Pipe			A		585-1005	375-585	270-375	195-250	
			Part ref.		ICS	J2154	J2153	J2109	J2152
Int Ømm	80	100	130	150	180	200	230	250	300
Ext Ømm	130	150	180	200	230	250	280	300	350
SAP Code 585-1005	124592	124572	125622	126175	126888	127484	127976	128391	128899
SAP Code 375-585	148378	148379	116882	117207	117556	117873	118141	118305	118639
SAP Code 270-375	148376	148377	100715	100716	100717	100718	101289	100719	100720
SAP Code 195-250	148393	148394	114523	114975	115450	115885	116270	116481	117047

To change into ICS Plus a total of 3 gaskets are required on adjustable pipes.

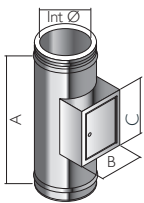

Inspection Length - ICS									ICS J2111
Int Ømm	80	100	130	150	180	200	230	250	300
Ext Ømm	130	150	180	200	230	250	280	300	350
A	-	-	292	292	292	292	411	411	411
B	-	-	114	114	114	114	202	202	202
C	-	-	173	173	173	173	292	292	292
SAP Code	-	-	113207	115319	115429	116120	117404	117515	117871

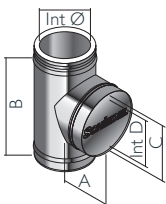

Inspection Length - ICS Plus									ICS Plus DF21E6
Int D	130	150	180	200	230	250	250	250	250
Int Ømm	80	100	130	150	180	200	230	250	300
Ext Ømm	130	150	180	200	230	250	280	300	350
A	125	135	150	160	175	185	180	210	238
B	255	275	305	325	355	375	375	375	375
C	145	155	170	180	195	205	205	205	205
SAP Code	148403	148404	100895	100896	100897	100898	101304	100899	100900

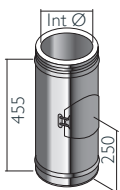

Inspection Pipe - ICS									ICS J21A4
Int Ømm	80	100	130	150	180	200	230	250	300
Ext Ømm	130	150	180	200	230	250	280	300	350
SAP Code	130550	124795	115391	115905	116364	116717	117046	117323	117693

Pipes

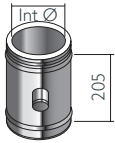

Measure Pipe									ICS J2195
Int Ømm	80	100	130	150	180	200	230	250	300
Ext Ømm	130	150	180	200	230	250	280	300	350
SAP Code	148401	148402	101142	101143	101144	101145	101343	101146	101147

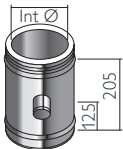

Vertical Drain Pipe									ICS J21A5
Int Ømm	80	100	130	150	180	200	230	250	300
Ext Ømm	130	150	180	200	230	250	280	300	350
SAP Code	148405	148406	101156	101157	101158	101159	101359	101160	101161



Locking Band									ICS J2183
Int Ømm	80	100	130	150	180	200	230	250	300
Ext Ømm	130	150	180	200	230	250	280	300	350
SAP Code	104464	104465	104420	104421	104468	104423	104424	104470	104471
Supplied with components (as standard) with female form.									

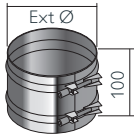

Structural Locking Band									95850
Int Ømm	80	100	130	150	180	200	230	250	300
Ext Ømm	130	150	180	200	230	250	280	300	350
SAP Code	101124	101125	101126	101127	101128	101129	101130	101131	101132
For static loading information please see p.40 of the Installation Instructions									

Gasket to convert ICS to ICS Plus

Fit into the groove form on all female socket (liners) and into grooves on adjustable pipe liner.

Refer to our YouTube TV Channel to see a conversion demonstration.



Silicon Gasket (Gas Only)									S000
Int Ømm	80	100	130	150	180	200	230	250	300
Ext Ømm	130	150	180	200	230	250	280	300	350
SAP Code	124582	120423	120421	120419	126611	127185	127750	119581	128693
For use on condensing gas applications with a pressure rating of up to 200Pa.									



Viton Gasket (Gas & Oil)									V000
Int Ømm	80	100	130	150	180	200	230	250	300
Ext Ømm	130	150	180	200	230	250	280	300	250
SAP Code	124618	124919	125721	119577	119575	127653	128059	128521	129009
For use on condensing gas and oil applications with a pressure rating of up to 200Pa.									

Bends

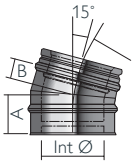

15° Bend										ICS J2118
Int Ømm	80	100	130	150	180	200	230	250	300	
Ext Ømm	130	150	180	200	230	250	280	300	350	
A	95	95	95	95	100	100	100	105	105	
B	55	55	55	55	60	60	60	65	65	
SAP Code	111089	111396	111830	112167	112623	112584	113177	113431	100734	

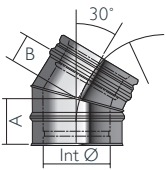

30° Bend										ICS J2119
Int Ømm	80	100	130	150	180	200	230	250	300	
Ext Ømm	130	150	180	200	230	250	280	300	350	
A	95	100	108	110	115	120	120	125	130	
B	55	60	68	70	75	80	80	85	90	
SAP Code	111091	111398	111793	112174	113242	113543	114518	114815	100748	

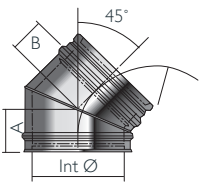

45° Bend										ICS J2117
SAP Code	111522	111937	112487	112806	113246	114388	114968	115303	100762	
Int Ømm	80	100	130	150	180	200	230	250	300	
Ext Ømm	130	150	180	200	230	250	280	300	350	
A	110	115	120	125	130	135	145	145	155	
B	70	75	80	85	90	95	105	105	115	

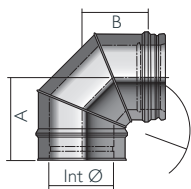

90° Bend										ICS J2115
Int Ømm	80	100	130	150	180	200	230	250	300	
Ext Ømm	130	150	180	200	230	250	280	300	350	
A	168	178	192	201	216	228	244	252	281	
B	132	140	156	165	180	192	208	216	237	
SAP Code	112105	112748	114190	114761	115710	116033	116429	117015	100817	

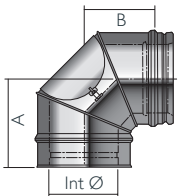

Inspection Bend										ICS J21A2
Int Ømm	80	100	130	150	180	200	230	250	300	
Ext Ømm	130	150	180	200	230	250	280	300	350	
A	-	136	152	161	176	188	204	212	237	
B	-	180	196	205	220	232	248	256	281	
SAP Code	-	148409	109585	109586	109587	109588	116425	109589	117563	

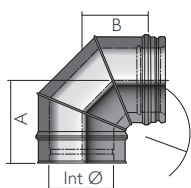

87° Bend										ICS J21F3
Int Ømm	80	100	130	150	180	200	230	250	300	
Ext Ømm	130	150	180	200	230	250	280	300	350	
A	166	173	189	198	213	225	-	248	271	
B	130	137	153	162	177	189	-	212	232	
SAP Code	130566	124825	125614	126163	126879	127468	-	128377	128884	

Offsets

(made by assembling 2 bends)

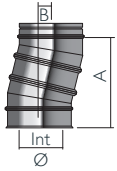

15° Offset										
Int Ømm	80	100	130	150	180	200	230	250	300	
Ext Ømm	130	150	180	200	230	250	280	300	350	
A	295	295	295	295	315	315	315	334	334	
B	39	39	39	39	41	41	41	44	44	

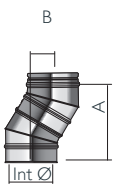

30° Offset										
Int Ømm	80	100	130	150	180	200	230	250	300	
Ext Ømm	130	150	180	200	230	250	280	300	350	
A	280	299	327	336	355	373	373	392	411	
B	75	80	88	90	95	100	100	105	110	

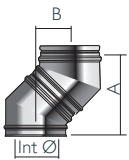

45° Offset										
Int Ømm	80	100	130	150	180	200	230	250	300	
Ext Ømm	130	150	180	200	230	250	280	300	350	
A	307	324	341	358	376	393	427	427	461	
B	127	134	141	148	156	163	177	177	191	

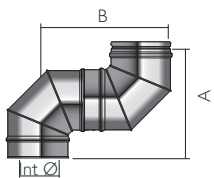

90° Offset										
Int Ømm	80	100	130	150	180	200	230	250	300	
Ext Ømm	130	150	180	200	230	250	280	300	350	
A	300	316	348	366	396	420	452	468	518	
B	300	316	348	366	396	420	452	468	518	

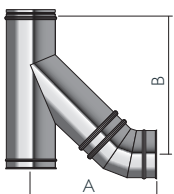

Offsets for 135° Tee & 45° Bend										
Int Ømm	80	100	130	150	180	200	230	250	300	
Ext Ømm	130	150	180	200	230	250	280	300	350	
A	343	370	437	445	452	496	523	537	592	
B	305	324	404	406	415	473	475	499	556	

Typical Offsets

(made by assembling 2 bends and a standard pipe section)

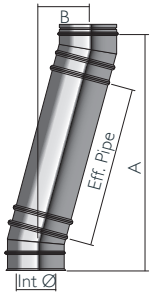

15° Bend Offset with Standard Pipe Length

Int Ømm		80	100	130	150	180	200	230	250	300
Ext Ømm		130	150	180	200	230	250	280	300	350
Effective Pipe 955	A	1218	1218	1218	1218	1238	1238	1238	1257	1257
	B	286	286	286	286	288	288	288	291	291
Effective Pipe 455	A	735	735	735	735	755	755	755	774	774
	B	157	157	157	157	159	159	159	162	162
Effective Pipe 205	A	493	493	493	493	513	513	513	532	532
	B	92	92	92	92	94	94	94	97	97
Effective Pipe 150	A	445	445	445	445	465	465	465	484	484
	B	79	79	79	79	81	81	81	84	84

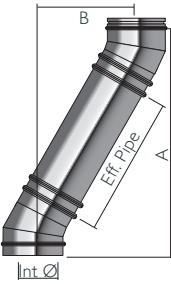

30° Bend Offset with Standard Pipe Length

Int Ømm		80	100	130	150	180	200	230	250	300
Ext Ømm		130	150	180	200	230	250	280	300	350
Effective Pipe 955	A	1107	1126	1154	1163	1182	1200	1200	1219	1238
	B	553	558	566	568	573	578	578	583	588
Effective Pipe 455	A	674	693	721	709	765	765	765	784	793
	B	303	308	316	318	323	328	328	333	338
Effective Pipe 205	A	458	477	505	514	533	551	551	570	589
	B	178	183	191	193	198	203	203	208	213
Effective Pipe 150	A	414	433	461	470	489	507	507	526	545
	B	153	158	166	168	173	178	178	183	188

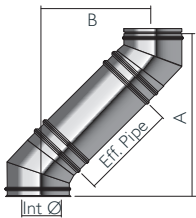

45° Bend Offset with Standard Pipe Length

Int Ømm		80	100	130	150	180	200	230	250	300
Ext Ømm		130	150	180	200	230	250	280	300	350
Effective Pipe 955	A	982	999	1016	1033	1051	1068	1102	1102	1136
	B	802	809	816	823	831	838	852	852	866
Effective Pipe 455	A	629	646	663	680	698	715	749	749	783
	B	449	456	463	470	478	485	499	499	513
Effective Pipe 205	A	452	469	486	503	521	538	572	572	606
	B	272	279	286	293	301	308	322	322	336
Effective Pipe 150	A	417	434	451	468	486	503	537	537	571
	B	237	244	251	258	266	273	287	287	301

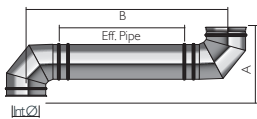

90° Bend Offset with Standard Pipe Length

Int Ømm		80	100	130	150	180	200	230	250	300
Ext Ømm		130	150	180	200	230	250	280	300	350
Effective Pipe 955	A	296	315	345	366	415	414	445	464	518
	B	1251	1270	1300	1321	1370	1369	1400	1419	1473
Effective Pipe 455	A	296	315	345	366	415	414	445	464	518
	B	751	770	800	821	870	869	900	919	973
Effective Pipe 205	A	296	315	345	366	415	414	445	464	518
	B	501	520	550	571	620	619	650	669	723
Effective Pipe 150	A	296	316	345	366	415	414	445	464	518
	B	446	466	495	516	565	564	595	614	673

Tees

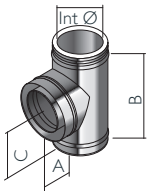

90° Tee										ICS J2120
Int Ømm	80	100	130	150	180	200	230	250	300	
Ext Ømm	130	150	180	200	230	250	280	300	350	
A	145	155	170	180	195	205	220	230	258	
B	250	270	305	325	355	375	405	425	480	
C	145	155	170	180	195	205	220	230	258	
SAP Code	112880	113386	114584	115231	116187	116706	117416	117805	100886	

To change into ICS Plus a total of 2 gaskets are required on tee sections - refer to our YouTube TV Channel to see a conversion demonstration

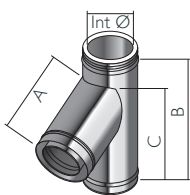

135° Tee										ICS (Dry System) J2121	ICS Plus (Wet System) DF2121
Int Ømm	80	100	130	150	180	200	230	250	300		
Ext Ømm	130	150	180	200	230	250	280	300	350		
A	-	262	298	322	358	382	419	443	509		
B	-	327	375	403	445	474	516	544	622		
C	-	262	298	322	358	382	419	443	509		
SAP Code ICS (Dry)	-	114914	116671	117052	117406	100856	118345	118527	100858		
SAP Code ICS + (Wet)	-	124794	125612	126146	126865	127451	127968	128359	128861		

To change into ICS Plus a total of 2 gaskets are required on tee sections - refer to our YouTube TV Channel to see a conversion demonstration

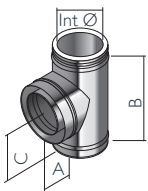

93° Tee										J21F2
Int Ømm	80	100	130	150	180	200	230	250	300	
Ext Ømm	130	150	180	200	230	250	280	300	350	
A	-	162	178	189	206	216	233	244	264	
B	-	278	309	329	359	379	405	455	490	
C	-	166	178	189	206	216	233	257	268	
SAP Code	-	124827	125651	126217	126922	127523	127997	128433	128933	

To change into ICS Plus a total of 2 gaskets are required on tee sections - refer to our YouTube TV Channel to see a conversion demonstration

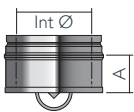

Tee Plug										ICS J2125
Int Ømm	80	100	130	150	180	200	230	250	300	
Ext Ømm	130	150	180	200	230	250	280	300	350	
A	35	32	38	41	44	44	48	48	48	
SAP Code	148395	148396	101106	101107	101108	101109	101342	101110	101111	

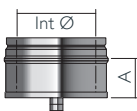

Tee Plug with Drain										ICS J2129
Int Ømm	80	100	130	150	180	200	230	250	300	
Ext Ømm	130	150	180	200	230	250	280	300	350	
A	35	32	38	41	44	44	48	48	48	
SAP Code	148407	148408	101030	101031	101032	101033	101338	101034	101035	



Draught Stabiliser Econ.										ICS J2126
Draught Stabiliser with Explosion Relief										-
Int Ømm	80	100	130	150	180	200	230	250	300	
Ext Ømm	130	150	180	200	230	250	280	300	350	
SAP Code Econ.	-	124800	101204	101205	101206	101207	101208	101209	101210	
SAP Code with Ex.R.	-	-	148410	148411	148412	-	-	148413	-	

Firestop Components

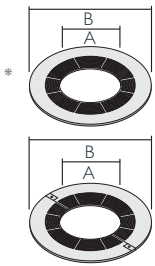

Combustible Floor									
Round Ventilated Firestop Plate - 1 Piece*									
Round Ventilated Firestop Plate - 2 Piece									
Int Ømm	80	100	130	150	180	200	230	250	
Ext Ømm	130	150	180	200	230	250	280	300	
A	133	153	183	203	233	253	283	303	
B	330	350	380	400	430	450	480	500	
SAP Code 1PC Plain	125501	125902	126661	127227	128117	128601	128639	128715	
SAP Code 1PC Black	125499	125900	126659	127225	128115	128599	128637	128713	
SAP Code 1PC White	125500	125901	126660	127226	128116	128600	128638	128714	
SAP Code 2PC Plain	125504	125905	126664	127230	128120	128604	128642	128718	
SAP Code 2PC Black	125502	125903	126662	127228	128118	128602	128640	128716	
SAP Code 2PC White	125503	125904	126663	127229	128119	128603	128641	128717	

*One piece firestop available for use exclusively with stove starter pipe

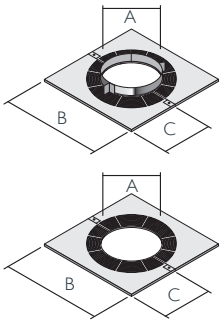

Combustible Floor									
Ventilated Support Plate - 2 Piece									
Rectangular Ventilated Firestop Plate - 2 Piece									
Int Ømm	80	100	130	150	180	200	230	250	
Ext Ømm	130	150	180	200	230	250	280	300	
A	133	153	183	203	233	253	283	303	
B	330	350	380	400	430	450	480	500	
C	165	175	190	200	215	225	240	250	
SAP Code Support P	125507	125908	126667	127234	127778	128219	128645	128721	
SAP Code Firestop P	125506	125907	126666	127232	127777	128218	128644	128720	

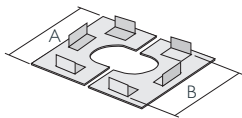

Non Combustible Floor									
Firestop Plate									
Int Ømm	80	100	130	150	180	200	230	250	300
Ext Ømm	130	150	180	200	230	250	280	300	350
A	300	300	330	350	380	400	430	450	500
B	230	250	280	300	330	350	380	400	450
SAP Code	125489	125891	126624	127200	127755	128197	128625	128698	129131

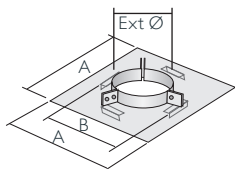

Non Combustible Floor									
Support Plate									
Int Ømm	80	100	130	150	180	200	230	250	300
Ext Ømm	130	150	180	200	230	250	280	300	350
A	300	300	330	350	380	400	430	450	500
B	230	250	280	300	330	350	380	400	450
SAP Code	1255495	125896	126646	127210	127762	128203	128631	128705	129138

Support Components

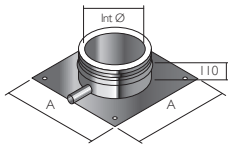

Base Support Plate with Drain ICS J2191

Int Ømm	80	100	130	150	180	200	230	250	300
Ext Ømm	130	150	180	200	235	230	250	300	350
A	230	250	280	300	330	350	380	400	450
SAP Code	148390	148391	104557	104558	100989	100990	101322	104559	104560

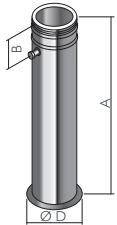

Base Drain Plug Support Refer to SAP code

Int Ømm	80	100	130	150	180	200	230	250	300
Ext Ømm	130	150	180	200	230	250	280	300	350
A	1045	1045	1045	1045	1045	1045	1045	1045	1045
B	160	160	160	160	160	160	160	160	160
D Ø	179	196	226	246	276	296	326	346	401
SAP Code	-	-	100994	100995	100996	100997	101330	100998	100999

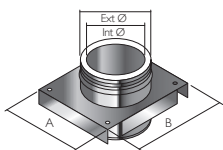

Adjustable Top Plate J21D3

Int Ømm	80	100	130	150	180	200	230	250	300
Ext Ømm	130	150	180	200	230	250	280	300	350
A	188	208	238	258	278	285	315	335	385
B	256	276	306	326	356	353	383	403	453
SAP Code	130555	124805	125636	126194	126900	127496	127984	128406	128910

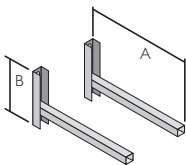

Cantilever Support Type 325 - 95420001 Type 475 - 95420002

Type	325	475
Int Ømm Range	80-150	80-300
A	325	475
B	242	242
SAP Code Plain	101742	101743
SAP Code Black	130686	130687

Used in combination with Adjustable Top Plate.

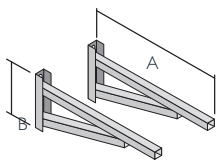

Cantilever Support Type 570 - 95420003

Type	570
Int Ømm Range	80-300
A	570
B	330
SAP Code Plain	101744
SAP Code Black	130688

Used in combination with Adjustable Top Plate.

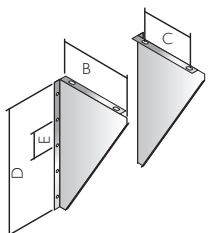

Wall Support Side Plates J21D2

Int Ømm	80	100	130	150	180	200	230	250	300
Ext Ømm	130	150	180	200	230	250	280	300	350
B	215	2355	265	285	315	335	365	385	440
C	145	165	195	215	245	265	295	315	370
D	470	470	470	470	470	470	470	470	470
E	100	100	100	100	100	100	100	100	100
SAP Code	101042	101043	101044	101045	101046	101047	101339	101048	101049

Used in combination with Adjustable Top Plate.



NEW

Retrofit Wall Supports

Int Ømm	100	130	150
Ext Ømm	150	180	200
A	300	315	325
SAP Code Black 60-200mm	169696	169697	169698
SAP Code Plain 60-200mm	169699	169700	169701
SAP Code Black 200-375mm	170318	170319	170320
SAP Code Plain 200-375mm	170321	170322	170323

Support Components

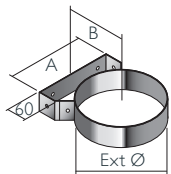

Wall Band (60mm)									92930
Int Ømm	80	100	130	150	180	200	230	250	300
Ext Ømm	130	150	180	200	235	256	280	300	350
A	128	148	178	198	228	248	278	298	350
B	125	135	150	160	175	180	200	210	235
SAP Code	125497	125898	126648	127213	127764	128205	128633	128707	129140

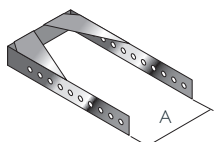

Adjustable Back Bracket for Wall Band 60 - 300mm									95950
Int Ømm	80	100	130	150	180	200	230	250	300
Ext Ømm	130	150	180	200	230	250	280	300	350
A	131	151	181	201	231	251	281	301	351
SAP Code	125488	125890	126623	127199	127754	128196	128624	128697	129130

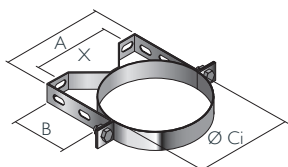

Structural Wall Band (50mm)									95430
Int Ømm	80	100	130	150	180	200	230	250	300
Ext Ømm	130	150	180	200	230	250	280	300	350
A	138	158	188	208	238	258	288	308	358
B	116	126	141	151	166	176	191	201	225
Ø Ci	131	151	181	201	231	251	281	301	350
X	100	120	150	170	200	220	250	270	320
SAP Code	101263	101264	101265	101266	101267	101268	101402	101269	101270

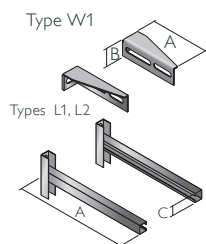

Structural Wall Band Extension		W1 - 95440001 L1 - 95440004 L2 - 95440005		
Type and Adj.		W1 55-100	L1 100-250	L2 100-440
A		130	300	450
B		36	-	-
C		-	32	32
SAP Code		101735	143846	143847

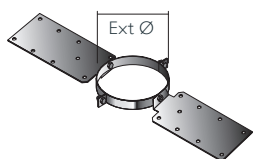

Roof Support									94640
Int Ømm	80	100	130	150	180	200	230	250	300
Ext Ømm	130	150	180	200	235	256	280	300	350
SAP Code	100960	100961	100962	100963	100964	100965	100966	100967	129146

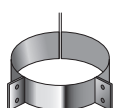

Guy Wire Bracket									95900
Int Ømm	80	100	130	150	180	200	230	250	300
Ext Ømm	130	150	180	200	235	256	280	300	350
SAP Code	100639	100640	100641	100642	100643	100644	128627	100646	129134



Telescopic Roof Stays									95750
Ext Ømm	130	150	180	200	230	250	280	300	350
SAP Code	170140	170141	170142	170143	170144	170146	170147	170148	170149

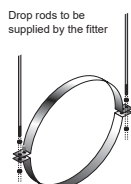

Ceiling Hanger									95750
Int Ømm	80	100	130	150	180	200	230	250	300
Ext Ømm	130	150	180	200	230	250	280	300	350
SAP Code	110118	110199	110392	112037	112279	112503	128623	112870	129129

Support Components

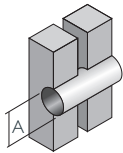

Wall Sleeve 90°									
					Masonry - 94980				
					Timber Frame - 94810				
Int Ømm	80	100	130	150	180	200	230	250	300
Ext Ømm	130	150	180	200	230	250	280	300	350
A Masonry	180	200	230	250	280	300	330	350	400
A Timber	250	270	300	320	350	370	200	420	470
SAP Code Masonry	125493	COA	126642	127206	127760	128201	COA	128703	129137
SAP Code Timber F	125496	125897	126647	127212	127763	128204	128632	128706	129139

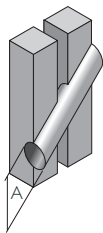

Wall Sleeve 45°									
					Masonry - 94620				
					Timber Frame - 94910				
Int Ømm	80	100	130	150	180	200	230	250	
Ext Ømm	130	150	180	200	230	250	280	300	
A Masonry	180	200	230	250	280	300	330	350	
A Timber	250	270	300	320	350	370	200	420	
SAP Code Masonry	125492	125894	126641	127205	127759	128200	128629	128702	
SAP Code Timber F	125494	125895	126642	127207	127761	128202	128630	128704	

Supplied as a 1m long mitred tube to be cut to length on site.

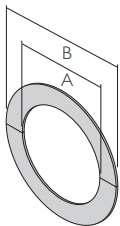

2 - Piece Trim Collar 90°									
9599									
Int Ømm	80	100	130	150	180	200	230	250	
Ext Ømm	130	150	180	200	230	250	280	300	
A	134	154	184	204	234	254	284	304	
B	280	300	330	350	380	400	430	450	
SAP Code Plain	125719	126338	127040	127644	128057	128512	128649	129007	
SAP Code Black	125720	126339	127041	127645	128058	128513	128650	129008	

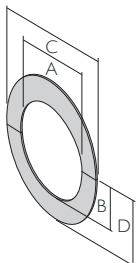

2 - Piece Trim Collar 45°									
9579									
Int Ømm	80	100	130	150	180	200	230	250	
Ext Ømm	130	150	180	200	235	256	280	300	
A	134	154	184	204	234	254	284	304	
B	94	108	130	144	165	179	200	214	
C	280	300	330	350	380	400	430	450	
D	192	206	227	242	263	277	298	312	
SAP Code Plain	125717	126335	127035	127639	128055	128510	128647	129004	
SAP Code Black	125718	126336	127036	127640	128056	128511	128648	129005	

Loft Guard



Loft Guard									
Int Ømm	80	100	130	150	180	200	230	250	300
Ext Ømm	130	150	180	200	230	250	280	300	350
Ø A	-	-	300	320	350	370	-	-	-
SAP Code	-	-	137464	137464	137465	137465	-	-	-



Loft Guard - for Scottish Regulations		
Int Ømm	180	200
Ø A	300	320
Ø B	400	420
SAP Code Plain	158404	158405

Ignis-Protect

Designed specifically for Air Tight, Energy Efficient and Timber Framed Buildings



In order to meet the latest European building regulations, specific leakage and performance criteria have to be met, which are much more stringent than in the past. These criteria are key in relation to chimney products passing through combustible walls.



Protected in accordance with European patent specification EP 1 878 849 B1

Schiedel Chimney Systems have invested heavily to provide tested and approved solutions to resolve these challenges and are proud to introduce their latest cutting edge product.



IGNIS-PROTECT,
Winner of Best Product Award
Hearth & Home Exhibition.

Product Description

PRODUCT FEATURES

- Suitable for SW and DW connecting flue pipes passing through interior or exterior walls made of combustible materials
- Available in two versions:
 - **For exterior walls** (with aluminium laminate on inside face)
 - **For interior walls** (without aluminium laminate and with an extended removable core)
- Available in both 90° and 45° versions
- For flue gas temperature up to:
 - 450 °C for SW connecting flue pipes (T450)
 - 600 °C for DW connecting flue pipes(T600)
- Max. 100 °C surface temperature during soot fire
- Monolithic component made of mineral wool, density 120 kg/m³, building material class A1
- Internal face finished with aluminium laminate
- External face made with textured surface to facilitate facade rendering
- Removable pipe sections DN 130, 150, 180, 200 mm
IGNIS-PROTECT can be used without any additional protection
- Available in a range of standard wall thickness's between 100mm -500mm

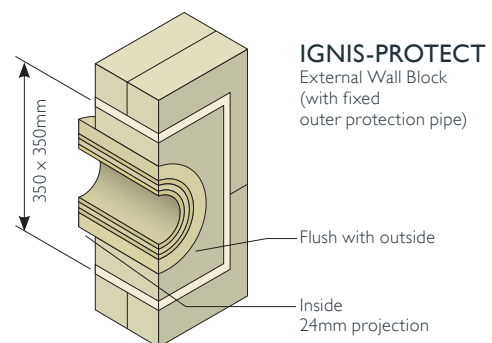
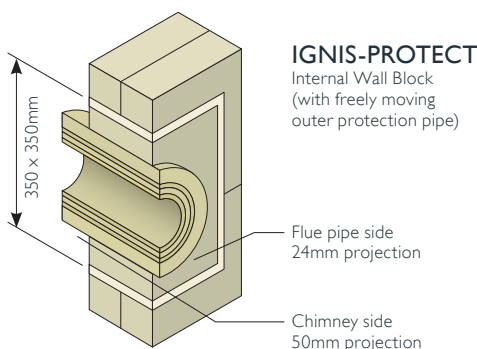

Approvals

DIBt
Zulassungs Nr. Z-7.4-3372 Deutsches Institut für Batechnik

- Z-7.4-3372 relating to T450 designated products
- Z-7.4-3402 relating to T600 designated products

Ignis-Protect

(for air tight wall penetration)

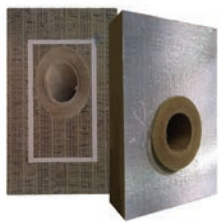

SAP Code	Thickness (mm)	Height (mm)	Width (mm)	Pallet Quantity
Ignis-Protect 90° Version				
101841	150	700	565	12
101842	200	700	565	9
101843	250	700	565	6
101844	300	700	565	4
101845	350	700	565	4
101846	400	700	565	2
Ignis-Protect 45° Version				
149530	100	1020	565	18
149531	150	1020	565	12
149532	200	1020	565	9
149533	250	1320	565	6
149534	300	1320	565	4
149535	350	1320	565	4
149536	400	1320	565	2
144032	450	1320	565	2
144033	466	1320	565	2
144034	500	1320	565	2

IGNIS-PROTECT 45° VERSION

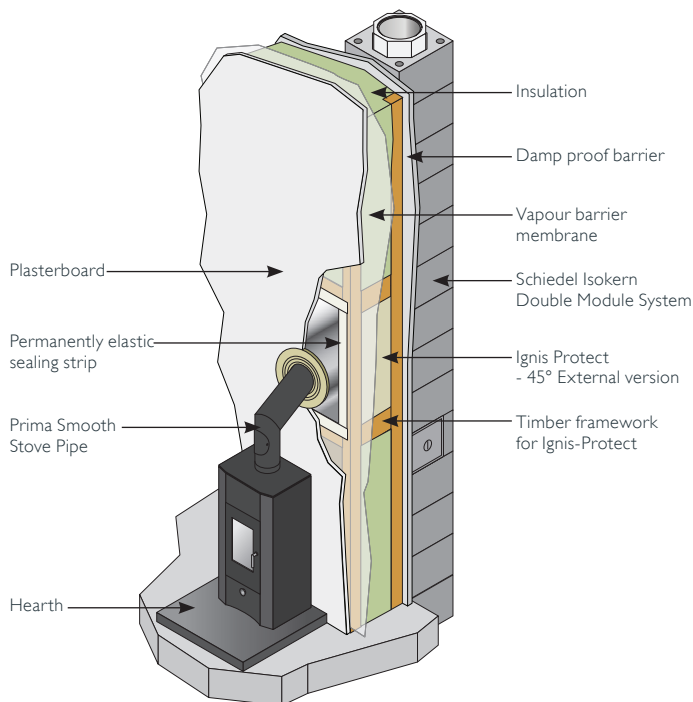

IGNIS-PROTECT ICS ON TRADITIONAL TIMBER FRAME WALL

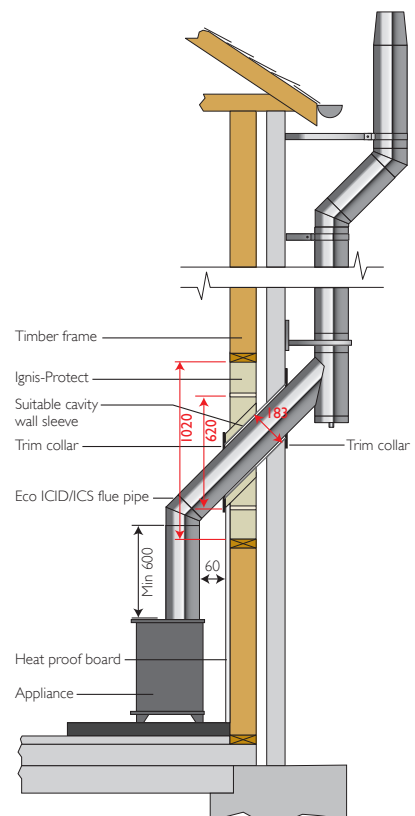

Protect Box

Engineered to meet the key challenges of modern houses...

- Ever more air tight construction
- Increasing depth of loft insulation



Schiedel Protect Box is the proven solution to safeguard distance to combustibles in low energy and passive houses.

PRODUCT FEATURES

- Designed to meet blower door test.
- Constructed using a high temperature resistant rock wool insulation with an aluminium laminate outer surface to give zero distance to combustibles.
- An EPDM kit is available to allow for the chimney to pass through an air tight membrane at ceiling level in a cold roof construction or at roof level in a warm roof construction.
- Standard height 700 mm to meet new roof insulation requirements.

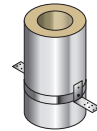

Protect Box

SAP Code 121342

EPDM Seal

SAP Code 136939

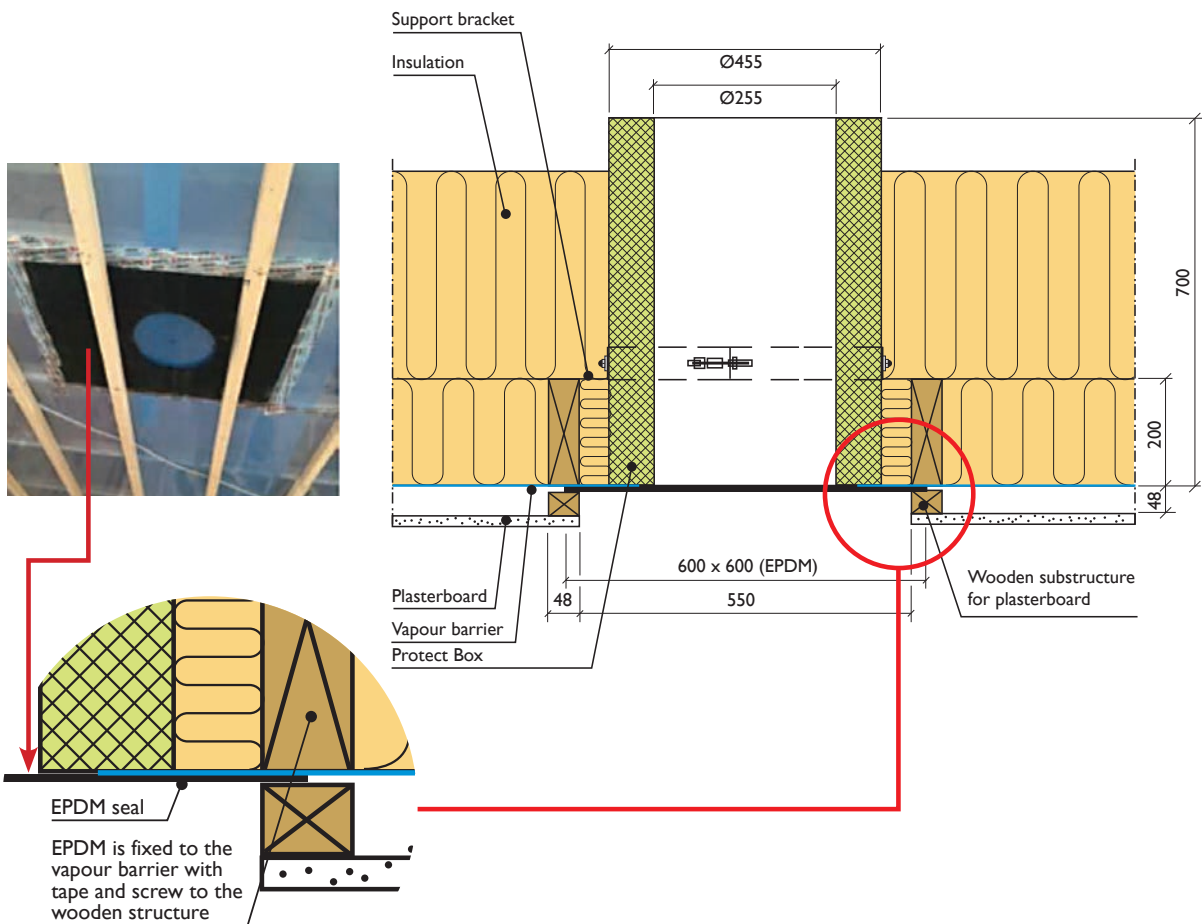

Protect Box and Accessories

(for air tight ceiling/roof penetration)

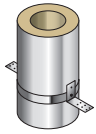

Protect Box	
Int Ømm	251
Ext Ømm	451
SAP Code	121342

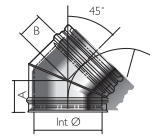

Bends	
Int Ømm	150
Ext Ømm	250
SAP Code 45° Bend	104804

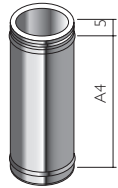

Pipes	
Int Ømm	150
Ext Ømm	250
SAP Code 1000 mm	104784
SAP Code 500 mm	104779
SAP Code 250 mm	104774

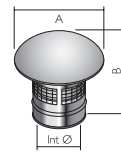

Raincaps	
Int Ømm	150
Ext Ømm	250
SAP Code No Mesh	126241
SAP Code With Mesh	126240



EPDM Seal	
SAP Code	136939

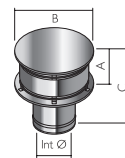

Anti Drawdraught Term. With Mesh	
Int Ømm	150
Ext Ømm	250
SAP Code	115244



Roof Support	
Int Ømm	150
Ext Ømm	250
SAP Code	100965

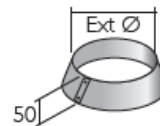

Storm Collar	
Int Ømm	150
Ext Ømm	250
SAP Code	106143

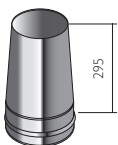

Tapered Terminal	
Int Ømm	150
Ext Ømm	250
SAP Code	114311

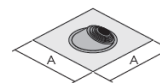

Uniflash	
Int Ømm	150-300
A	685
SAP Code	112197

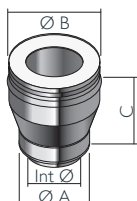

ICS25 - ICS50 Adaptor	
Int Ømm	150
Ø A	201
Ø B	251
C	195
SAP Code Plain	114484

Typical Installations

PROTECT BOX IN SITU

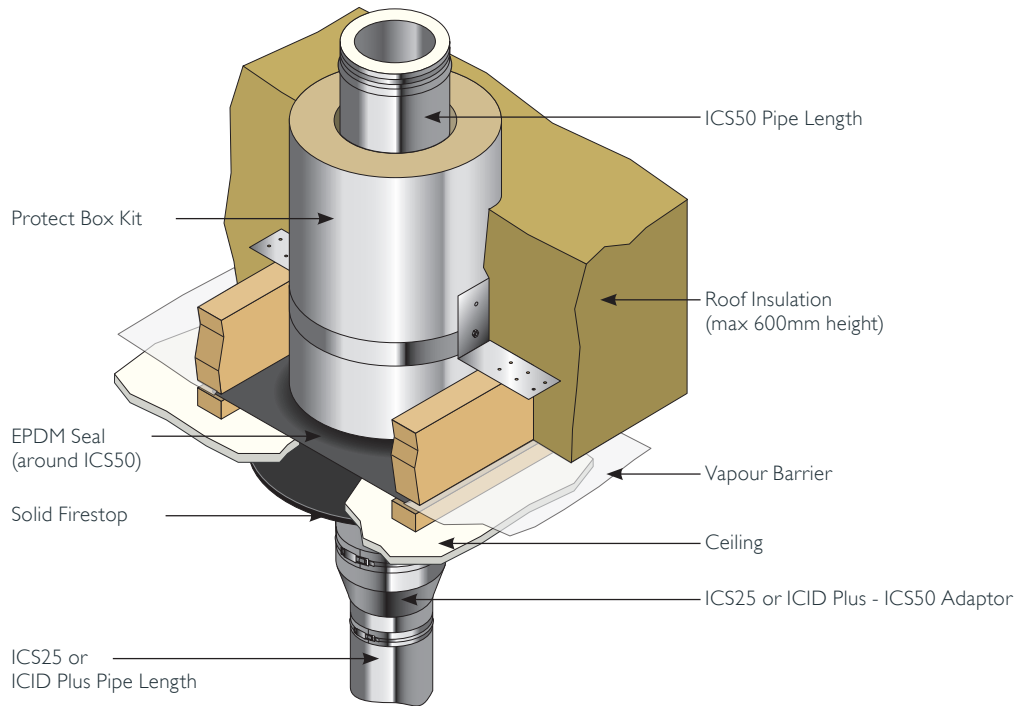

SCHIEDEL PROTECT BOX THROUGH PITCHED ROOF

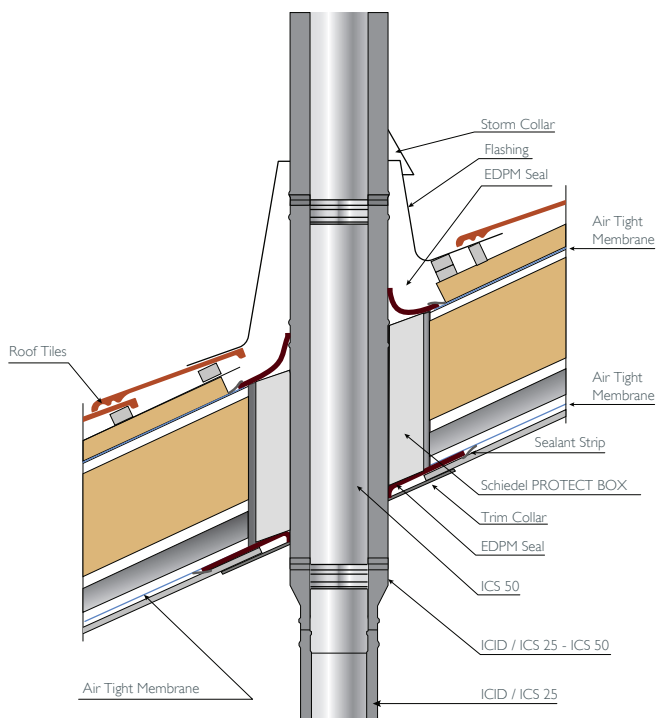

Flashings

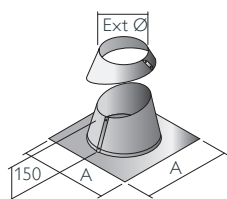

Angled Flashing Kit 5° - 45°										95510
Int Ømm	80	100	130	150	180	200	230	250	300	
Ext Ømm	130	150	180	200	230	250	280	300	350	
Ø A	610	610	610	700	700	700	800	800	860	
SAP Code	125487	125889	126621	127197	127753	128195	128622	120884	129128	

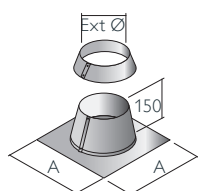

Flat Flashing Kit										95530
Int Ømm	80	100	130	150	180	200	230	250	300	
Ext Ømm	130	150	180	200	230	250	280	300	350	
Ø A	610	610	610	610	610	610	610	610	800	
SAP Code	125490	125892	126625	127201	127756	128192	128626	128699	129132	

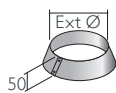

Storm Collar										95560
Int Ømm	80	100	130	150	180	200	230	250	300	
Ext Ømm	130	150	180	200	230	250	280	300	350	
SAP Code	106136	106138	106140	106141	106142	106143	100975	106144	106145	

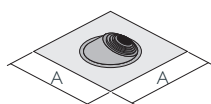

Uniflash			
Product Code	94540001	94540002	94540003
Ext Ømm	80-200	150-300	250-450
A	500	685	800
SAP Code	112198	112197	114341
Universal EPDM rubber/aluminium flashing. Just pull the required diameter tab on the rubber seal.			

Terminals

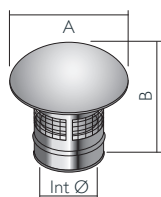

Raincap										with 15mm mesh ICS J2137	without mesh ICS J2156
Ext Ømm	80	100	130	150	180	200	230	250	300		
Int Ømm	130	150	180	200	230	250	280	300	350		
A	266	266	266	362	362	362	362	362	490		
B	210	213	219	213	217	220	225	229	271		
SAP Code with mesh	112769	113085	113534	114970	115364	115702	116037	116222	117060		
SAP Code without mesh	112499	112795	113183	114575	115005	115242	115729	115942	116792		

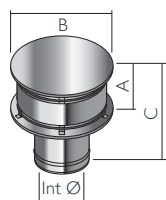

Anti-splash Anti-downdraught Terminal (Gastec Approved)										with 15mm mesh ICS J2144	without mesh ICS J2143
Ext Ømm	80	100	130	150	180	200	230	250	300		
Int Ømm	130	150	180	200	230	250	280	300	350		
A	-	-	130	175	200	200	250	275	330		
B	-	-	254	304	359	409	459	509	609		
C	-	-	220	265	290	290	340	365	420		
SAP Code with mesh	-	-	114904	115166	116258	116970	117466	118025	118645		
SAP Code without mesh	-	-	1143552	114830	115893	116496	117167	117700	118432		

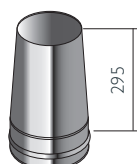

Insulated Tapered Terminal										ICS J2138
Int Ømm	80	100	130	150	180	200	230	250	300	
Ext Ømm	130	150	180	200	235	256	280	300	350	
SAP Code	120565	148392	101214	101215	101216	101217	114420	114704	115212	

Installation

These notes should be read in conjunction with the detailed ICS Installation Instructions.

MANDATORY REQUIREMENTS

Connection to an appliance which is not connected to the fuel supply, may be carried out by a competent person. However, connection to an appliance that is connected to the fuel supply must be carried out by a GAS SAFE (gas) or OFTEC (oil) registered installer. We recommend the use of HETAS approved installers for solid fuel applications.

The flue system must be installed to comply with Building Regulations Document J (in England, Wales & Northern Ireland). Separate Building Regulations apply in Scotland. The installation must also comply with BS EN15287 Parts 1 & 2 and BS5440 pt 1: 2000 for gas flues up to 70kW.

JOINTING

Pipes, bends, tees and flue gas carrying components are joined together by a simple push fit. The joint is then secured by fitting a locking band. The male spigot should be uppermost and pointing in the direction of the terminal as indicated on the product label. All components with a female form will be supplied with a locking band.

Gaskets must be used for ICS Plus (ordered separately and are required for high efficiency and condensing applications) and should be fitted dry and lubrication applied to the internal of the female liner socket.

Joints are not permitted within wall and ceiling spaces. Any flue pipe (i.e. single wall) connection to the chimney must be made in the same room as the appliance. The chimney must project at least 425mm below the ceiling. Where a chimney passes through a wall, a wall sleeve must be used to prevent damage to the chimney and the building.

ADJUSTABLE LENGTH

The ICS range of adjustable pipes provides flexibility during installation. Assembly is achieved by the removal of the insulation (if necessary) to the desired length, and is then secured using the jointing band supplied. The adjustable length is not load-bearing, therefore adequate support must be provided immediately above.

CONNECTION TO APPLIANCE

Use the appropriate appliance connector, sealing with fire rope and fire cement or high temperature sealant on solid fuel appliances and the appropriate lip seal in the case of condensing appliances. The inner liner should not project below the appliance outlet spigot and can be cut to length if required.

APPLIANCE REMOVAL

Use of the SW-DW Adjustable Starter pipe or one of the DW Adjustable Starter Sections immediately above the appliance enables removal of the appliance later without dismantling the full system.

PAINTING

If required to be painted, simply clean the surface with a solvent cleaner (White Spirit), apply a coat of primer and a top coat of high temperature paint e.g. enamel. Extreme care must be taken when cleaning with solvent to ensure that it does not come into contact with the insulation within the cavity or gasket if fitted.

ENCLOSURES/SHAFTS

With the exception of the room containing the appliance, where the chimney passes through any part of the building, where there is a risk of accidental human contact, i.e. a bedroom etc., or where there is a risk of contact with combustible materials stored in a cupboard or in the roof-space, the chimney must be enclosed in an appropriate way to meet Building Regulations. This can be achieved by boxing in the chimney in habitable rooms, or by the use of a protective wire mesh frame in roof spaces etc. In all cases the minimum distance to any combustible material, including loft insulation, must be respected according to the table on p.3, and any enclosure should be ventilated using the appropriate ventilated fire stops (see p.18).

SUPPORT COMPONENTS

The weight of a chimney system is considerable and requires independent support. Minimal weight should be taken by the appliance. The weight of the chimney can be supported from floor level using a Base support plate or Telescopic floor support; from the wall by using the Retrofit Wall Support or wall support top plates together with side plates or cantilever brackets; or from first floor level using a support plate and clamp fixed to the floor/ceiling joist.

Wall brackets and roof brackets are not load bearing and provide lateral support only.

Refer to load bearing tables on p.29 for full details of maximum loadings.

STRUCTURAL LOCKING BAND

Where the flue is free standing above the roof and its height exceeds 1.5m beyond the last support or the roof, a guy wire bracket must be used, and every 1.5m thereafter. Alternatively, a height of up to 3m can be achieved unsupported with the use of a structural locking band at the joint immediately below the last support and on every joint above the roof level.

Installation

DISTANCE TO COMBUSTIBLES

In accordance with building regulations it is essential that the correct distance to combustible material is maintained. On solid fuel applications, where there is a risk of soot fire, a distance of 60mm to combustibles must be maintained within a combustible floor and within a combustible shaft (see Fig.1). There is no need to line the area within the floor cavity with plasterboard; however the ventilated fire stop plate and ventilated support plate must be used.

On gas and oil applications, a distance of 50mm to combustibles must be maintained within a combustible floor and within a combustible shaft. The ventilated fire stop plate and ventilated support plate must be used.

Where the chimney penetrates a non combustible floor and where a non combustible shaft is used, a distance of 50mm to the shaft is sufficient. In this case, non ventilated fire stops and non ventilated support plates may be used at first floor level with a ventilated fire stop being used where the chimney penetrates into the roof space.

On condensing appliances, where temperatures will not exceed 200°C, the tested and approved distance to combustibles is zero mm.



For a direct link to the ICS Installation Instructions scan the QR code.

TYPICAL INSTALLATION OF ICS25 THROUGH A COMBUSTIBLE FLOOR & SHAFT

Fig. 1
Distance to combustibles from outer case of chimney

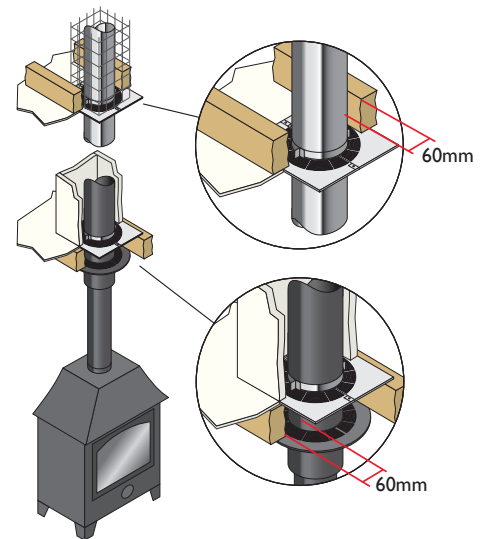

Load Bearing Data

Maximum Load Bearing (metres of pipe)				
Internal Diameter (mm)	80-130	150-180	200-250	300
Base Drain Section	22	18	18	18
Drain Plug Support	18	18	18	18
Telescopic Floor Support	18	18	18	18
Retrofit Wall Support	10	10*	-	-
Adjustable Top Plate + Locking Band	15	15	15	15
Pair of Side Plates (see diagram A)	15	15	15	15
Pair of Side Plates (see diagram B)	10	10	10	10
Cantilever Support	22	18	18	18
Extension Support (Anchor Plate)	1.5	1.5	1.5	1.5
Ventilated Support Plate (All types)	12	12	9	-
Support Plate	12	12	9	-
Ceiling Hanger	1.5	1.5	1.5	15
Wall Band 50/60mm	3	3	3	3
Adjustable Wall Band 60-300mm	3	3	3	3
Structural Wall Band	4	4	4	4
Extension for Structural Wall Band	4	4	4	4
Guy Wire Bracket	1.5	1.5	1.5	1.5
Roof Support (above truss)	6	6	6	5
Roof Support (below truss)	4	4	4	3
90° Tee + Locking Band	22	18	18	18
93° Tee + Locking Band	22	18	18	18
135° Tee + Locking Band	15	10	10	10
Inspection Tee (Round)	22	18	18	18
Inspection Tee (Rectangular)	22	18	18	18

Approximate Weights of Products (Kg)				
Internal Diameter Length(mm)	1000	500	250	195
80	4.32	2.13	1.09	0.85
100	5.14	2.53	1.29	1.01
130	6.35	3.14	1.60	1.24
150	7.18	3.54	1.86	1.41
180	8.40	4.14	2.11	1.65
200	9.22	4.55	2.31	1.80
230	10.44	5.13	2.62	2.03
250	11.24	5.53	2.81	2.19
300	15.08	7.58	3.44	2.47

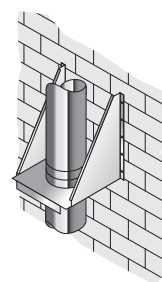

Diagram A

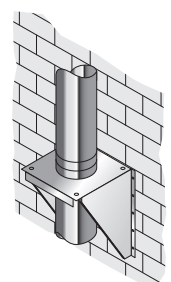

Diagram B

* Retrofit Wall Support available diameters 80 - 150 only

After Installation

TESTING BEFORE USE

This is carried out using a flue flow test as described in BS EN 15287 parts 1 & 2, with reference to the appropriate appliance type.

MAINTENANCE

It is essential that the flue way be kept clear at all times in the interest of good practice and health, safety and appliance performance. The system should be checked regularly during the appliance maintenance.

(Refer to appliance manufacturer's instructions).

Product Guarantee

Under normal operating conditions and providing the system is installed correctly, it should last the lifetime of the appliance which is normally 10 years. ICS carries a 10 year conditional guarantee.

The conditions are that the chimney is:

- Correctly sized and installed in accordance with the Schiedel Rite-Vent and appliance manufacturer's instructions.
- Properly maintained.
- Burning only approved fuels.

For recommended fuels listings, please refer to the HETAS guide (www.hetas.co.uk), or appliance manufacturer's instructions. Warranty registration details are provided with installation instructions for completion and registration with Schiedel Rite Vent.

Every effort is made to ensure accuracy at time of going to press. However, as part of our policy of continual product development, we reserve the right to alter specifications without prior notice. All installation drawings are graphical representations. Building regulations and relevant British standards must be adhered to.

Schiedel Installer Rewards

Exciting news from Schiedel Chimney Systems for Stove and Chimney Installers! Whenever you register an installation with our easy to use, online guarantee registration portal, you will now accrue points based on the number of installations and installation type.

Once you have reached a minimum of 25 points, you can begin to redeem them for £25 Love2Shop vouchers.

So head on over to the portal and start to register your installations to take full advantage of our guarantees and also to start earning points!



Useful Guides

THE SCHIEDEL INSTALLATION APP

This handy mobile guide can be used on mobile devices and touch-screen tablets.

It offers a number of very useful guides on all aspects of installing an appliance using Schiedel Chimney Systems, including:

- Quick and straightforward reference for installers.
- Video breakdowns of each stage of the installation process, from connection to the appliance through to termination.
- Highlighting the safety critical areas where the chimney penetrates the floors, ceilings, roof and walls.
- Incorporates frequently asked questions information at each stage of the installation process, in line with building regulations.
- An easy-to-use system for downloading full product information and installation instructions.
- Register your Guarantee in the App.

Download the iPhone and iPad version in the App Store and Android version in the Google Play Store.

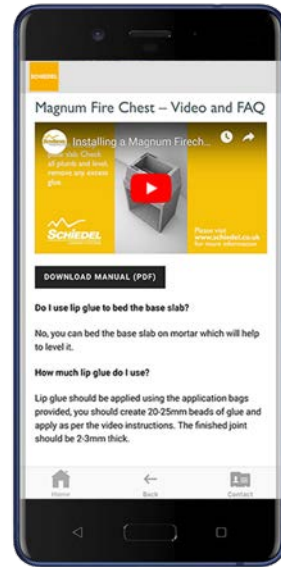

YOUTUBE TV CHANNEL

The Schiedel YouTube TV Channel contains a number of videos showing installation examples in easy to understand 3D diagrams.

Visit the channel today to learn more
Search for "Schiedel UK" in YouTube to find us.

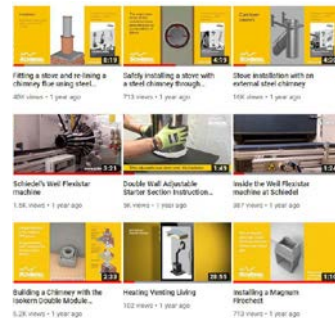

DOWNLOADS SPECIALIST CENTRE

We have a comprehensive range of CAD cells, typical installations using Isokern Pumice components and other diagrams, which are ideal resources for architects and builders when designing a chimney system for a new build or renovation.

SCHIEDEL BIM CATALOGUE AND APP

A range of Schiedel Products for Commercial and Residential are now available within our new 3D BIM (Building Information Modelling) Catalogue. All BIM and AEC CAD formats, like Autodesk Revit, Nemetschek Allpan and Grafisoft Archicad for the respective CAD systems are available to engineers, planners and purchasers for free.

You can visit the Google, Apple and Windows App Stores and search for Cadenas to download the 3D CAD Models and then within the App, search for "Schiedel"

All this information is also available when you visit our website and head over to the **SPECIALIST CENTRE** which can be found under the **SCHIEDEL WORLD** menu. Or contact us and we will send a USB stick with all the relevant information and downloads on.

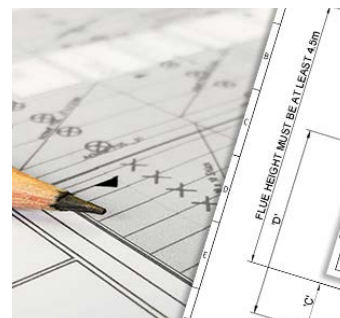

Complementary Products And Services From Schiedel Chimney Systems



ICS

Twin Wall Insulated System Chimney for gas, oil and multi-fuel applications.

- Capillary break prevents moisture being drawn through the joint
- 80-300mm Diameter range



PRIMA PLUS

Single Wall Stainless Steel Flue System

- Prima Plus available 0,6mm or 1mm options for domestic multi-fuel stoves
- Prima Plus for large residential & commercial condensing gas & oil appliances & chimney relining
- 80-300mm Diameter range

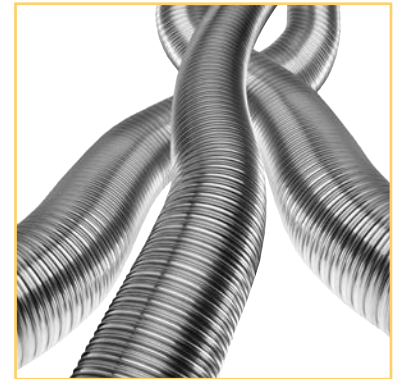

TECNOFLEX PLUS

For relining existing chimneys to take gas, oil, wood, multi-fuel appliances and open fires.

- Twin skin TecnoFlex Plus available in 316L or 904L options
- 80-300mm Diameter range



PRIMA SMOOTH

Single Wall Stainless Steel Connecting Flue Pipe for use on wood and multi-fuel applications.

- 316L Grade stainless steel
- Available in matt black or steel finish
- 125-200mm internal diameters

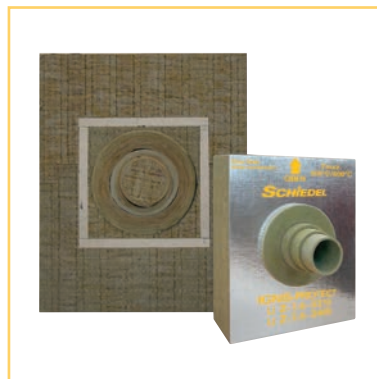

IGNIS-PROTECT

Designed specifically for Air Tight, Energy Efficient and Timber Framed Buildings



DM & LINERS

Pumice System Chimneys, Firechests and Liners.

- Pumice is a natural insulator, able to maintain the temperature of flue gases
- Lightweight – allowing one person to lift and build the chimney units
- Pumice expands and contracts less with temperature change than other chimney systems.



Schiedel Chimney Systems
Crowther Estate
Washington
Tyne & Wear NE38 0AQ
Tel. +44 (0)191 416 1150

sales.uk@schiedel.com
schiedel.com/uk

SCHIEDEL INSTALLER REWARDS

Exciting news from Schiedel Chimney Systems! Whenever you register an installation with our easy to use, online guarantee registration portal, you will now accrue points based on the number of installations and installation type to redeem for Love2Shop vouchers!

Follow us on Social Media @SchiedelUK



A standard
INDUSTRIES COMPANY