

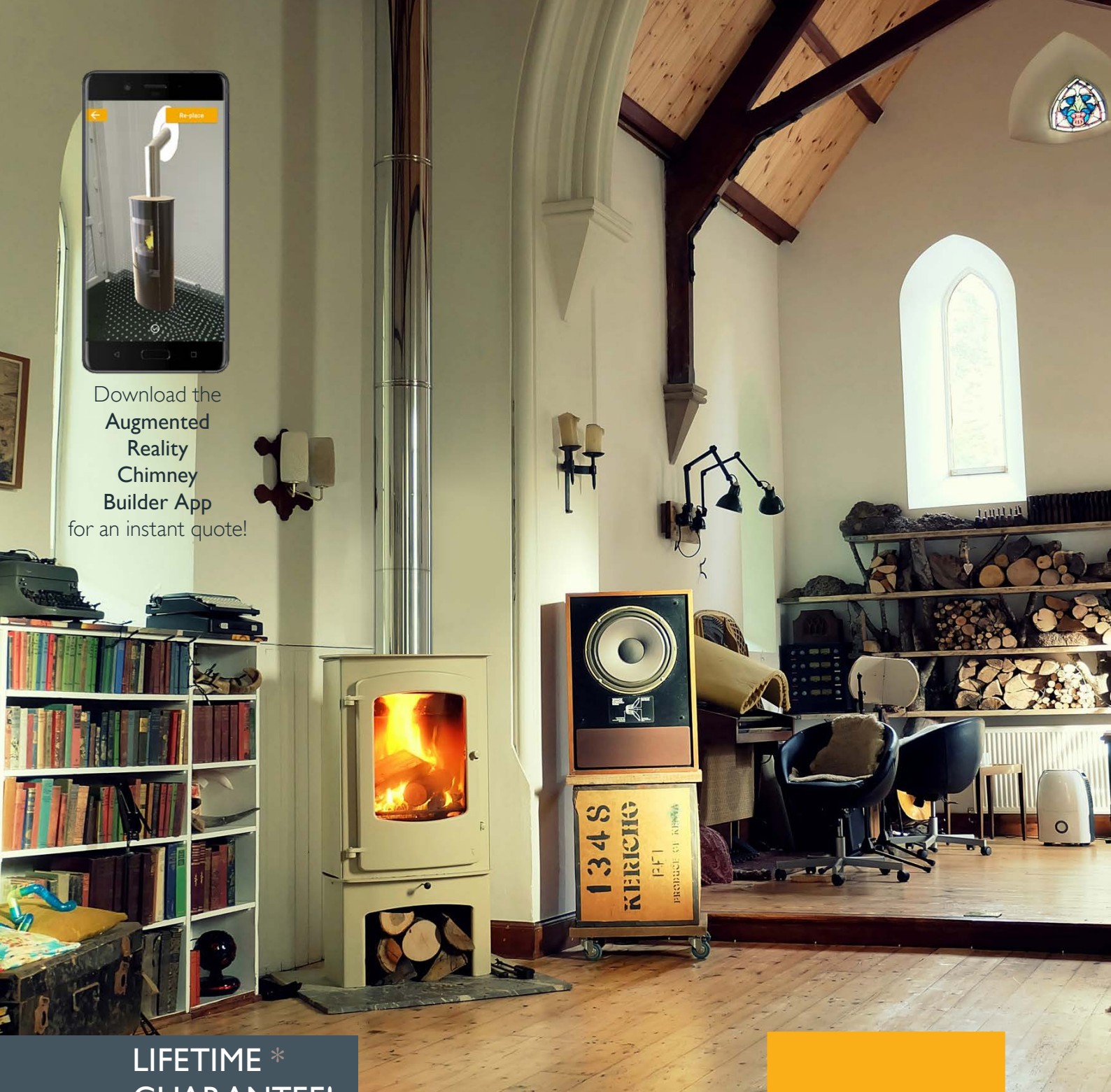

Download the
Augmented
Reality
Chimney
Builder App
for an instant quote!



LIFETIME *
GUARANTEE!

ICID Plus

100-200mm Diameter Range
Twin Wall Insulated System Chimney
for Gas, Oil, Wood and Multi-fuel



DON'T FORGET TO REGISTER YOUR INSTALLATIONS
AND START EARNING SCHIEDEL INSTALLER REWARDS
See inside for more details

SCHIEDEL

Product Description

Our ICID range has evolved into a multi-application system adaptable for Dry (D), Fu (W) and even Positive Pressure (P) applications.

At Schiedel, we pride ourselves on our technology and innovation and this heating season introduce our evolutionary 3-in-1 system:

ICID Plus Ideal not only for traditional stoves but also for pellet stoves, biomass appliances, mini/micro CHP and even condensing boilers capable of withstanding positive pressure.

The system is designed so that the outer case is load bearing and the inner liner is free to expand independently, therefore thermal expansion is accommodated within each and every joint of the system.

Available in two versions with a choice of either a bright annealed or a matt black painted stainless steel outer case, ICID Plus is available in the following range of diameters:- 100, 125, 150, 180 and 200mm.

Front cover image courtesy of Charlotte Smith from St. Mary's Space showing an ICID system installed by Backwoodsman.

Joint Design

ICID PLUS PRODUCT FEATURES

- Twist-lock bayonet jointing system. Secured by locking band.
- Advanced corrosion resistant design and construction uses laser welded 316L stainless steel inner liner and stainless steel case.
- The 25mm of high density mineral wool insulation maintains flue gas temperature, maximising efficiency, improving flue draught on start up and minimising condensation.
- Low external case temperature.
- The inner liner is free to expand through the female collar, allowing for maximum thermal expansion even during a soot fire.
- The inner liner has an engineered design with an inward bead at the female end which acts as a capillary break preventing moisture being drawn through the joint.
- Lip seal packs are available containing a quick fit female lip seal with a grease sachet to allow product to be easily adapted for use in Positive Pressure (P) applications for use on condensing positive pressure appliances.

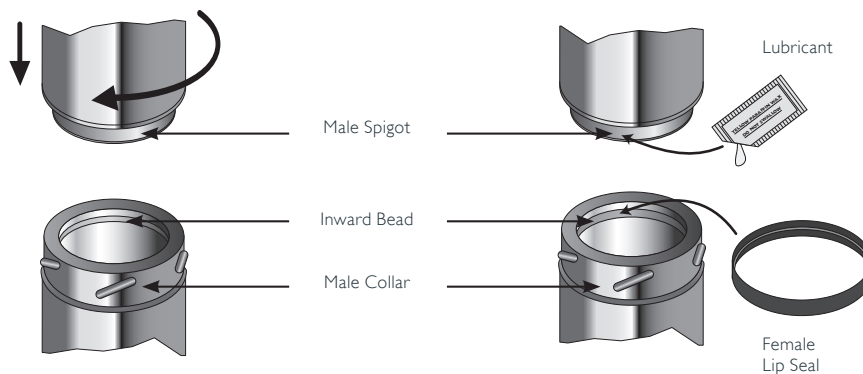

WITHOUT LIP SEAL
ICID Plus for N rated Negative
Pressure Applications
(i.e. Stoves)

WITH LIP SEAL
ICID Plus for P rated Positive
Pressure Applications
(i.e. Condensing Boilers)

Technical Data

	ICID (without Lip Seal)	ICID Plus (with Lip Seal)
Fuel	Wood, solid fuel	Gas, Oil
Firing Temp	450°C	200°C
Short Firing Temp	550°C	250°C
Thermal Shock	1000°C	-
Mode of Operation	Zero & Negative Pressure	Positive Pressure
Pressure Capabilities	40Pa	200Pa
Fire Rating	4 Hour Fire Rating to BS 476 Part 20	
Outer Case (Standard)	Stainless Steel	
Outer Case (Option)	Painted matt black	
Outer Case Thickness	0.5mm	
Seam	Laser or inert gas welded	
Liner	316L : 1.4404 : X2CrNiMo 17-12-2	
Liner Thickness (mm)	0.5mm	
Seam	Laser or inert gas welded	
Insulation	High performance mineral fibre	
Insulation Thickness	25mm	
Average Thermal Resistance (200°C)	0.4m ² k/W	

CORROSION RESISTANCE

Chimneys are subject to significant corrosion attack by flue gas condensates, particularly from solid fuel. ICID Plus is specifically designed and manufactured to resist this corrosion.

CHIMNEY DIAMETER

The chimney size should be as recommended by the appliance manufacturer. Where there is a requirement for a flue diameter smaller than the appliance spigot, then the operational requirements of the appliance and the configuration of the flue must satisfy the flue sizing requirements of EN13384-1 for single appliances, and EN13384-2 for multi appliances.

Approvals

ICID is CE Certified to EN1856-1 TÜV 0036 CPR 9195 010 with designations:

ICID is CE Certified to EN1856-2 TÜV 0036 CPR 9195 042 with designations:



System Chimney EN1856-1		
T450 N1 W V2 L50050 G60 T450 N1 D V3 L50050 G60 60mm Distance to combustibles running through a combustible floor using G60 round firestop	T450 N1 W V2 L50050 G50 T450 N1 D V3 L50050 G50 50mm Distance to combustibles a) running through a combustible floor using G50 ventilated fire stops b) In a ventilated shaft using G50 or G60 round ventilated fire stops in combination with G50 ventilated support plate at base and G50 ventilated fire stop plate at top of shaft. c) In free air	T200 P1 W V2 L50050 O00 Zero distance to combustibles*
Connecting Flue Pipe EN1856-2		
T450 N1 D V2 L50050 G100 M		* For full information refer to p.22 and p.24

- Manufactured under a Quality Management Scheme approved to BS EN ISO 9001
- 4 Hour Fire Rating to BS476 Part 20
- Certified for corrosion resistance on gas, oil and solid fuel by Gastec, MPA and TÜV
- HETAS listed for use on solid fuel applications.

Typical Installations for Solid Fuel Applications

INTERNAL HOUSE Combustible Floors

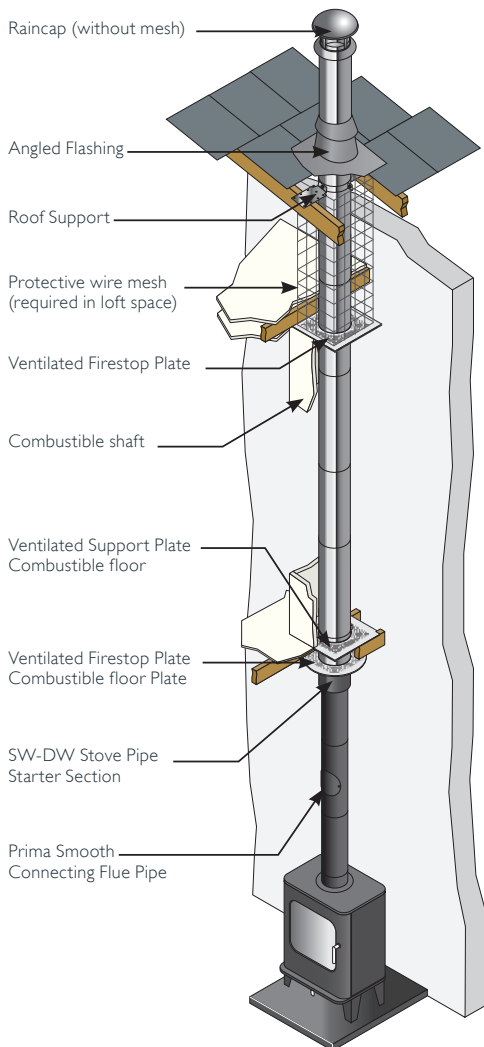

INTERNAL HOUSE Non Combustible Floors

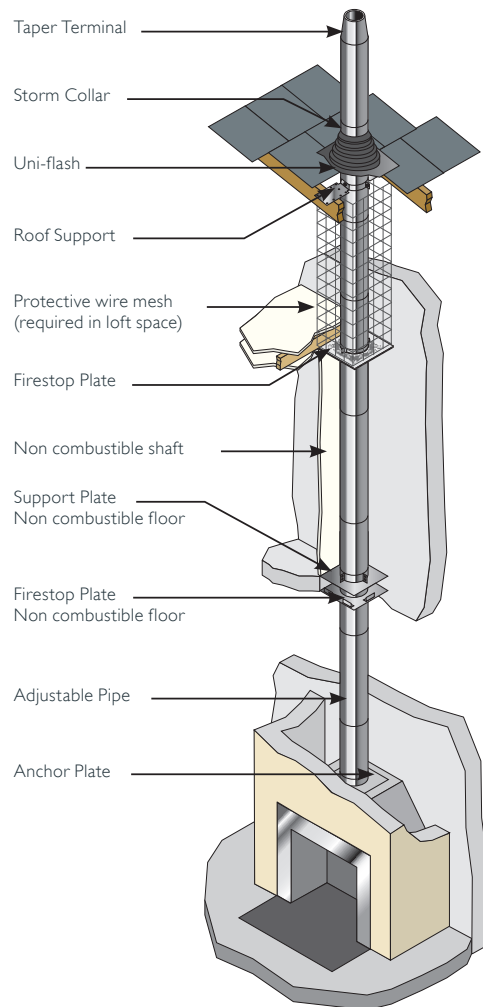

Typical Installations for Solid Fuel Applications

INTERNAL BUNGALOW (VENTILATED LOFT SPACE)

Combustible and Non-Combustible floors

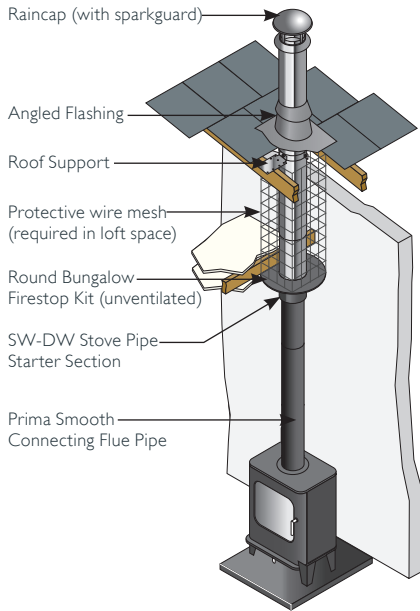

EXTERNAL

System Chimney

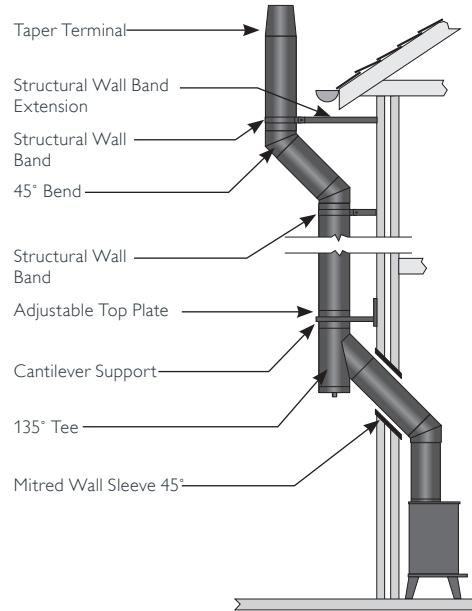

Typical Installations

TYPICAL CONDENSING BOILER INSTALLATION

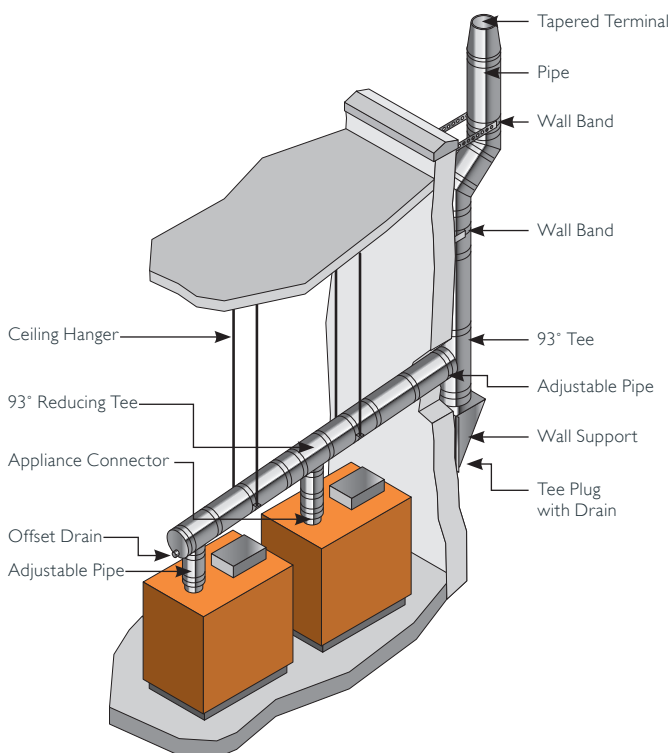

TYPICAL BIOMASS INSTALLATION

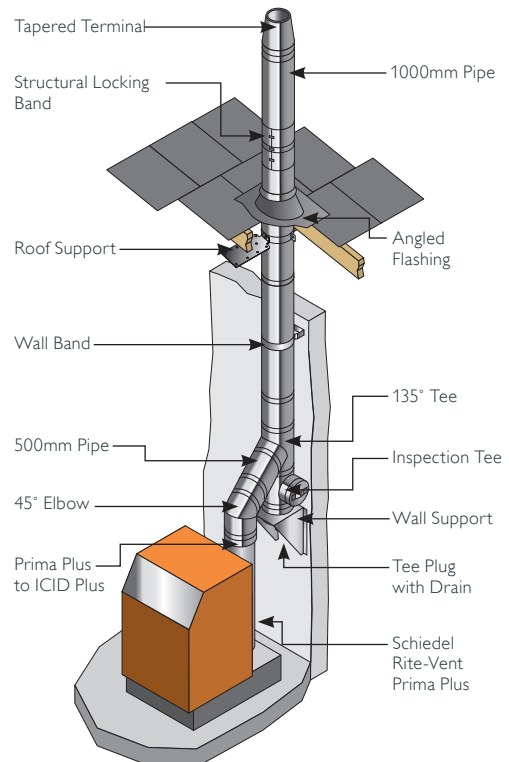

Gasket kits

(for use in P rated positive pressure applications)



Female Viton Lip Seal Kit

Int Ømm	100	125	150	180	200
Ext Ømm	150	180	200	230	250
SAP Code	147322	147323	147324	147325	147326

This female lip seal must be used on wet positive pressure applications and fits into the inward bead on the female socket on the inside of the liner immediately below the male collar.



Adjustable Pipe Seal Kit

Int Ømm	100	125	150	180	200
Ext Ømm	150	180	200	230	250
SAP Code	152135	152136	152137	152138	152139

This kit consists of a female viton seal which fits into the inward bead on the female socket on the inside of the liner immediately below the male collar and a male viton lip seal which must be fitted into the inward bead of the liner, which is situated in the top half of the 2-piece adjustable pipe, and at the bottom of the liner on the 1-piece adjustable pipe.

Dimensions

The dimensions of the flue are:

Int Ømm	100	125	150	180	200
Ext Ømm	150	180	200	235	256

Finish

Paint - ICID Plus can be supplied painted in any RAL colour (additional costs apply).

The standard finish for ICID Plus is satin. The option of a matt finish is available on request.

The photo shows an installation from Heatsource with the ICID flue painted to match the appliance colour.

Twitter @heatsourcerer



Starting Components

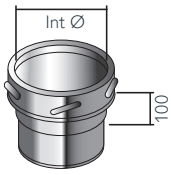

SW - DW Connector (Open) DN8A047				
Int Ømm	125	150	180	200
Ext Ømm	180	200	235	256
This component MUST only be fitted to stove pipe and NOT directly to appliance.				
SAP Code Plain	125307	126082	126827	127410
SAP Code Black	125308	126079		

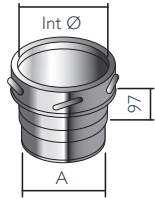

SW - DW Connector (Closed) DN8A144					
Int Ømm	100	125	150	180	200
Ext Ømm	150	180	200	235	256
A	97	123	148	177	198
This component MUST only be fitted to stove pipe and NOT directly to appliance.					
SAP Code Plain	147329	125287	126060	126810	127393
SAP Code Black	147330	125288	126059	COA	COA

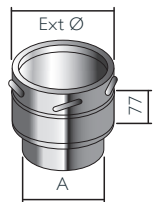

Insulated Appliance Connector					
Int Ømm	100	125	150	180	200
Ext Ømm	150	180	200	235	256
A	97	123	148	177	198
SAP Code Plain	147406	146418	146419	146420	146421
SAP Code Black	147405	146414	146415	146416	146417

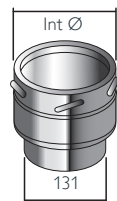

Insulated Adaptor for Sirius Stove				
Int Ømm	125			
Ext Ømm	180			
SAP Code Plain	176051			
SAP Code Black	176052			

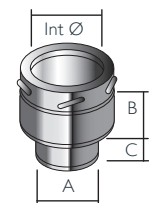

Insulated Increasing Adaptor DN8A136				
Int Ømm	125	150	180	200
Ext Ømm	180	200	235	256
A	98	123	148	178
B	100	118	116	116
C	50	50	50	50
SAP Code Plain	125305	126077	126824	127408
SAP Code Black	144438	126078	COA	COA

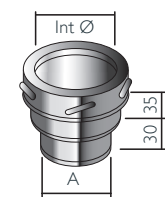

Uninsulated Increasing Adaptor (SW - DW) DN8A143					
Int Ømm	100	125	150	180	200
Ext Ømm	150	180	200	235	256
A	-	98	123	148	178
SAP Code Plain	-	125320	125321	COA	COA
SAP Code Black	-	144439	125319	COA	COA

* used on appliances with rear outlet

Starting Components

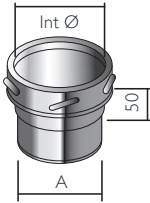

Adaptor Prima Plus to ICID Plus S027

Int Ømm	125	150		
Ext Ømm	180	200		
A	130	150		
SAP Code Plain	125688	126278		

This component MUST only be fitted to stove pipe and NOT directly to appliance.

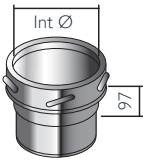

Adaptor Prima Smooth to ICID Plus (Dry Applications only) PS027

Int Ømm	125	150	180	200
Ext Ømm	180	200	235	256
SAP Code Plain	109992	110270	126981	127588
SAP Code Black	109991	110268	126980	127587

This component MUST only be fitted to stove pipe and NOT directly to appliance.

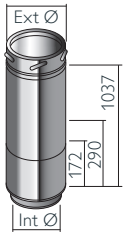

Double Wall Adjustable Starter Section (1037mm)

Int Ømm	100	125	150	180	200
Ext Ømm	150	180	200	235	256
SAP Code Plain	-	149644	149645	149646	149647
SAP Code Black	-	149648	149649	149650	149651



Double Wall Adjustable Starter Section (600mm)

Int Ømm	100	125	150	180	200
Ext Ømm	150	180	200	235	256
SAP Code Plain	-	152214	152215	152216	152217
SAP Code Black	-	152218	152219	152220	152221



Sirius Stove Double Wall Adjustable Starter Section (600mm)

Int Ømm	125
Ext Ømm	180
SAP Code Black	175710

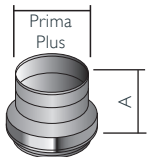

Adaptor ICID Plus to Prima Plus DN8A113

Int Ømm	100	125	150	180	200
Ext Ømm	150	180	200	235	256
A	132	132	132	134	134
SAP Code Plain	147331	125292	126062	126813	127396

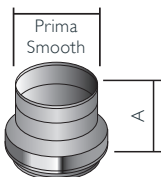

Adaptor ICID Plus to Prima Smooth (Dry Applications only)

Int Ømm	100	125	150	180	200
Ext Ømm	150	180	200	235	256
A	-	132	132	134	134
SAP Code Plain	-	145516	145517	145518	145519

Black painted Starting Components are finished using high temperature paint | COA : Code on application

Starting Components

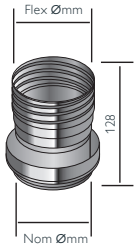

Screwfit adaptor from ICID Plus to TecnoFlex Plus

Int Ømm	100	125	150	150	180	200
Flex Ømm	100	125	150	155	180	200
SAP Code Plain	174081	174082	174083	174084	174085	174086

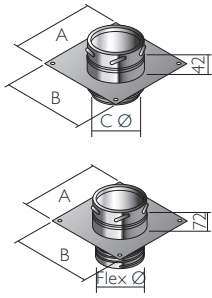

Anchor Plate (Dry Applications only)

DN8A0D6

Int Ømm	100	125	150	180	200
Ext Ømm	150	180	200	235	256
A	250	300	320	355	375
B	270	280	300	335	356
C	97	123	148	178	198
Flex Ømm	125	125	155	180	200
SAP Code Plain	-	125300*	126072*	126774*	127344*
SAP Code Flex	147336	142587	142595	142589	142590
SAP Code Black	147337	142591	142596	142593	142594

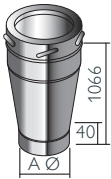

SW-DW Adjustable Starter Section (Long) (Dry Applications only)

Int Ømm	125	150
Ext Ømm	180	200
A	123	148
B	1066	1066
SAP Code Plain	148503	148504
SAP Code Black	148507	148508

This component MUST only be fitted to stove pipe and NOT directly to appliance.

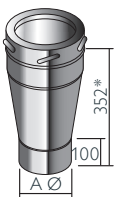

SW-DW Adjustable Starter Section (Short) (Dry Applications only)

DN8A159

Increasing SW-DW Adjustable Starter Section* (Short) (Dry Applications only)

DN8A161

Int Ømm	125	125*	150	180	200
Ext Ømm	180	200	200	235	256
A	123	123	148	178	198
B	352	434	352	352	352
SAP Code Plain	125340	126096	126118	126850	127435
SAP Code Black	125339	131148	126117	126849	127434

This component MUST only be fitted to stove pipe and NOT directly to appliance.

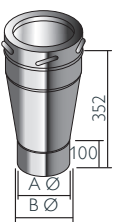

UE to ICID Adjustable Starter Section

Int Ømm	125	150
Ext Ømm	180	200
A	123	152
B	147	172
SAP Code Plain	175405	175406
SAP Code Black	175408	175409

Pipes

NOTE: Black product MUST not be connected directly to the stove.
Refer to stove starting components

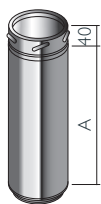

1460mm Pipe (1454mm Effective Length)					DN8A128
Int Ømm	100	125	150	180	200
Ext Ømm	150	180	200	238	256
A	1454	1454	1454	1454	1454
SAP Code Plain		125253	126019	126780	127350
SAP Code Black		125251	126017	126778	

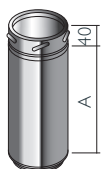

960mm Pipe (954mm Effective Length)					DN8A001
Int Ømm	100	125	150	180	200
Ext Ømm	150	180	200	235	256
A	954	954	954	954	954
SAP Code Plain	147343	125285	126058	126808	127392
SAP Code Black	147338	125286	126056	126809	127388

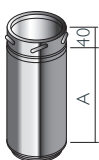

750mm Pipe (744mm Effective Length)					DN8A157
Int Ømm	100	125	150	180	200
Ext Ømm	150	180	200	235	256
A	744	744	744	744	744
SAP Code Plain	147347	125273	126045	126797	127380
SAP Code Black	147342	125274	126046	126798	127379

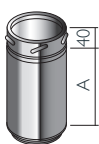

460mm Pipe (454mm Effective Length)					DN8A002
Int Ømm	100	125	150	180	200
Ext Ømm	150	180	200	235	256
A	454	454	454	454	454
SAP Code Plain	147344	125269	126039	126793	127376
SAP Code Black	147339	125270	126037	129794	127372

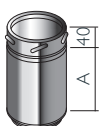

293mm Pipe (287mm Effective Length)					DN8A003
Int Ømm	100	125	150	180	200
Ext Ømm	150	180	200	235	256
A	287	287	287	287	287
SAP Code Plain	147345	125261	126030	126786	127362
SAP Code Black	147340	125262	126028	COA	127358

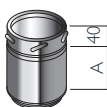

160mm Effective Length					DN8A004
Int Ømm	100	125	150	180	200
Ext Ømm	150	180	200	235	256
A	160	160	160	160	160
SAP Code Plain	147346	125258	126025	126784	127357
SAP Code Black	147341	125259	126023	COA	COA



Adjustable Pipe - 1 Piece 50-230mm					DN8A009
Int Ømm	100	125	150	180	200
Ext Ømm	150	180	200	235	256
SAP Code Plain	147351	125298	126071	126819	127402
SAP Code Black	147348	125294	126064	126815	COA
This item is converted for use on wet positive pressure applications by using the Lip Seal Kit for adjustable pipes - see page 6					

Pipes

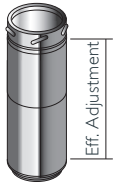

Telescopic Pipe - 2 Piece 215-310mm					DN8A151
Int Ømm	100	125	150	180	200
Ext Ømm	150	180	200	235	256
SAP Code Plain	147352	125295	126066	126816	127399
SAP Code Black	147349	144441	126068	COA	COA

This item is converted for use on wet positive pressure applications by using the Lip Seal Kit for adjustable pipes - see page 6

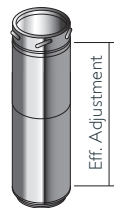

Telescopic Pipe - 2 Piece 350-570mm					DN8A150
Int Ømm	100	125	150	180	200
Ext Ømm	150	180	200	235	256
SAP Code Plain	147353	125297	126069	126818	127401
SAP Code Black	147350	141888	126065	COA	127398

This item is converted for use on wet positive pressure applications by using the Lip Seal Kit for adjustable pipes - see page 6



Locking Band					DN8A083
Int Ømm	100	125	150	180	200
Ext Ømm	150	180	200	235	256
SAP Code Plain	147354	125330	126106	126842	127426
SAP Code Black	147355	125331	126107	COA	COA

Supplied as standard with all components with a female collar

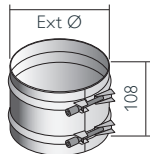

Structural Locking Band					DN8A092
Int Ømm	100	125	150	180	200
Ext Ømm	150	180	200	235	256
SAP Code Plain	147356	125317	126092	126835	127419
SAP Code Black	147357	125318	126093	COA	COA

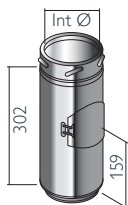

Inspection Pipe with Test Point (Dry and Condensing)					
Int Ømm	100	125	150	180	200
Ext Ømm	150	180	200	235	256
SAP Code Dry Plain	-	148484	148485	148486	148487
SAP Code Dry Black	-	148488	148489	-	-
This component incorporates a locking plug with a spring gasket suitable for high temperature T450 rated dry applications only					
SAP Code Condensing	152142	148492	148493	148494	148495
This component incorporates a locking plug with a lip seal gasket suitable for low temperature, max T200 rated applications only.					

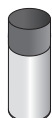

ICID Touch Up Paint	
SAP Code Plain	175867
Schiedel have now introduced a black touch up spray paint for use with the standard Black satin RAL 9005 BLDP paint spec, used on ICID Plus. This is available in 400ml spray cans.	

Tees

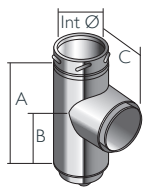

90° Tee including Drain Cap (Dry Applications only)						DN8A135
Int Ømm	100	125	150	180	200	
Ext Ømm	150	180	200	235	256	
A	282	301	329	354	394	
B	150	154	162	176	195	
C	120	133	142	160	170	
SAP Code Plain	147360	125282	126054	126805	127387	
SAP Code Black	147359	125283	126055	COA	COA	

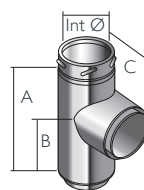

93° Tee including Drain Cap (Condensing and Dry Applications)					
Int Ømm	100	125	150	180	200
Ext Ømm	150	180	200	235	256
A	285	297	322	356	396
B	155	158	166	180	201
C	121	136	147	167	177
SAP Code Plain	151975	148110	148112	148114	148117

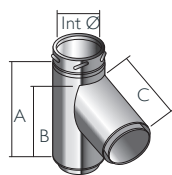

135° Tee including Drain Cap (Condensing and Dry Applications)					
Int Ømm	100	125	150	180	200
Ext Ømm	150	180	200	235	256
A	325	336	365	414	444
B	254	259	283	326	351
C	254	259	283	326	351
SAP Code Plain	147362	125248	126014	126776	127346

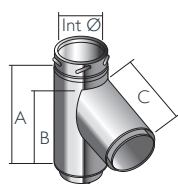

135° Tee including Drain Cap (Dry Applications only)						DN8A137
Int Ømm	100	125	150	180	200	
Ext Ømm	150	180	200	235	256	
A	325	336	365	414	444	
B	254	259	283	326	351	
C	254	259	283	326	351	
SAP Code Plain	147364	125249	126015	126777	127347	
SAP Code Black	147365	125250	126016	148190	131796	

Tees

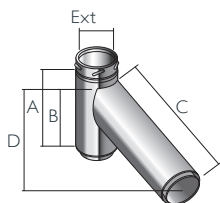

135° Long Tee - Adjustable (Dry Applications only)

Int Ømm	125	150
Ext Ømm	180	200
A	336	365
B	259	283
C Min/Max	815/1193	841/1219
D Min/Max	576/844	844/862
SAP Code Plain	154662	154663
SAP Code Black	154664	154665



Tee Plug

Int Ømm	100	125	150	180	200
Ext Ømm	150	180	200	235	256
SAP Code Plain	COA	125343	126121	126853	127438
SAP Code Black	COA	COA	126122	COA	COA

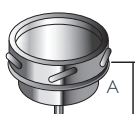

Tee Plug with Drain

DN8A138

Int Ømm	100	125	150	180	200
Ext Ømm	150	180	200	235	256
A	61	119	119	119	119
SAP Code Plain	147366	125312	126088	126831	127415
SAP Code Black	147367	144440	126089	COA	COA

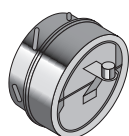

Draught Stabiliser

Int Ømm	100	125	150	180	200
Ext Ømm	150	180	200	235	256
SAP Code Plain	-	138143	138145	149525	138147
SAP Code Black	-	COA	COA	COA	COA

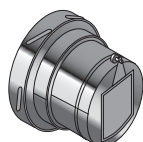

Draught Stabiliser with Explosion Relief

Int Ømm	100	125	150	180	200
Ext Ømm	150	180	200	235	256
SAP Code Plain	-	149521	138148	138144	149526
SAP Code Black	-	COA	COA	COA	COA

Bends

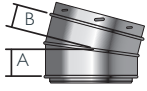

15° Bend						DN8A018
Int Ømm	100	125	150	180	200	
Ext Ømm	150	180	200	235	256	
A	60	63	63	63	64	
B	56	55	56	56	57	
SAP Code Plain	147372	125256	126022	126782	127353	
SAP Code Black	147368	125254	126020	COA	COA	

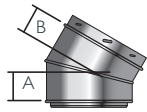

30° Bend						DN8A019
Int Ømm	100	125	150	180	200	
Ext Ømm	150	180	200	235	256	
A	63	66	70	73	77	
B	59	57	61	64	68	
SAP Code Plain	147373	125264	126033	126788	127366	
SAP Code Black	147369	144442	126031	COA	COA	

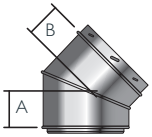

45° Bend						DN8A017
Int Ømm	100	125	150	180	200	
Ext Ømm	150	180	200	235	256	
A	76	79	83	91	95	
B	74	70	74	82	86	
SAP Code Plain	147374	125267	126036	126791	127371	
SAP Code Black	147370	125265	126034	126789	127367	



Structural Locking Band for Bends						DN8A155
Int Ømm	100	125	150	180	200	
Ext Ømm	150	180	200	235	256	
A	56	56	56	56	56	
SAP Code Plain	147376	125342	126120	126852	127437	
SAP Code Black	147377	125341	126119	126851	127436	

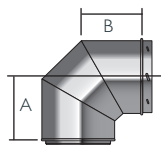

90° Bend						DN8A015
Int Ømm	100	125	150	180	200	
Ext Ømm	150	180	200	235	256	
A	131	146	156	174	184	
B	122	137	147	165	175	
SAP Code Plain	147375	125277	126049	126800	127382	
SAP Code Black	147371	125275	126047	COA	COA	

Bends

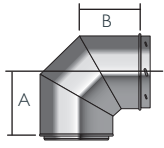

87° Bend					
Int Ømm	100	125	150	180	200
Ext Ømm	150	180	200	235	256
A	125	141	151	196	179
B	122	138	147	164	175
SAP Code Plain	151971	148023	148024	148025	148026

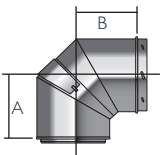

90° Inspection Bend (Dry Systems only)126803					DN8A0A2
Int Ømm	100	125	150	180	200
Ext Ømm	150	180	200	235	256
A	-	184	194	209	219
B	-	139	149	164	174
SAP Code Plain	-	125280	126052	126803	127385
SAP Code Black	-	COA	COA	COA	COA

Typical Offsets (made by assembling 2 bends)

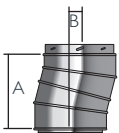

15° Offset					
Int Ømm	100	125	150	180	200
Ext Ømm	150	180	200	238	256
A	228	232	234	234	238
B	30	31	31	31	31

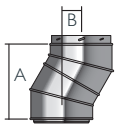

30° Offset					
Int Ømm	100	125	150	180	200
Ext Ømm	150	180	200	238	256
A	228	230	244	256	271
B	61	62	65	69	73

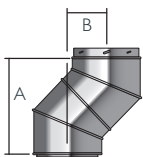

45° Offset					
Int Ømm	100	125	150	180	200
Ext Ømm	150	180	200	238	256
A	256	254	268	295	309
B	106	105	111	122	128

Typical Offsets

(made by assembling 2 bends and a standard pipe section)

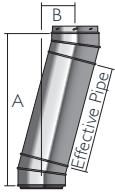

15° Bend offset with Standard Pipe Length						
Int Ømm		100	125	150	180	200
Ext Ømm		150	180	200	238	256
1454 Effective Pipe	A	1633	1636	1638	1638	1642
	B	406	407	407	407	408
954 Effective Pipe	A	1150	1153	1155	1155	1159
	B	277	277	278	278	278
744 Effective Pipe	A	947	951	953	953	957
	B	223	223	223	223	224
454 Effective Pipe	A	667	671	672	672	676
	B	148	148	148	148	149
287 Effective Pipe	A	505	509	511	511	515
	B	104	105	105	105	106
160 Effective Pipe	A	383	387	388	388	392
	B	71	72	72	72	73

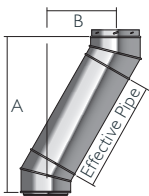

30° Bend offset with Standard Pipe Length						
Int Ømm		100	125	150	180	200
Ext Ømm		150	180	200	238	256
1454 Effective Pipe	A	1487	1489	1504	1515	1530
	B	788	789	793	796	800
954 Effective Pipe	A	1054	1056	1071	1082	1097
	B	538	539	543	546	550
744 Effective Pipe	A	872	874	889	900	915
	B	433	434	438	441	445
454 Effective Pipe	A	621	623	638	649	664
	B	288	289	293	296	300
287 Effective Pipe	A	476	478	493	504	519
	B	205	205	209	212	216
160 Effective Pipe	A	366	368	383	394	409
	B	141	142	146	149	153

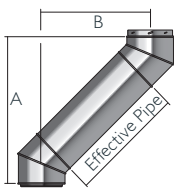

45° Bend offset with Standard Pipe Length						
Int Ømm		100	125	150	180	200
Ext Ømm		150	180	200	238	256
1454 Effective Pipe	A	1284	1282	1296	1323	1337
	B	1134	1133	1139	1150	1156
954 Effective Pipe	A	931	929	943	970	984
	B	781	780	786	797	803
744 Effective Pipe	A	782	780	794	821	835
	B	632	631	637	648	654
454 Effective Pipe	A	577	576	590	616	630
	B	427	427	433	443	449
287 Effective Pipe	A	459	457	471	498	512
	B	309	308	314	325	331
160 Effective Pipe	A	369	367	381	408	422
	B	219	218	224	235	241

Typical Offsets

(made by assembling 2 bends and a standard pipe section)

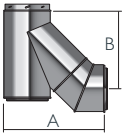

Offsets for 135° Tee and 45° Bend					
Int Ømm	100	125	150	180	200
Ext Ømm	150	180	200	238	256
A	383	402	435	497	532
B	303	310	334	376	402



Offsets for 135° Tee and 45° Bend					
Int Ømm	100	125	150	180	200
Ext Ømm	150	180	200	238	256
A	232	233	252	288	309

G50 Firestop Components

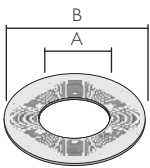

Combustible Floor G50 Round Ventilated Firestop Plate 1 Piece		
Int Ømm	125	150
Ext Ømm	180	200
A	183	241
B	380	400
SAP Code Plain	175701	175702
SAP Code Black	175703	175704

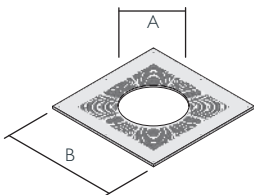

Combustible Floor G50 Square Ventilated Firestop Plate 1 Piece		
Int Ømm	125	150
Ext Ømm	180	200
A	183	241
B	380	400
SAP Code Plain	175705	175706

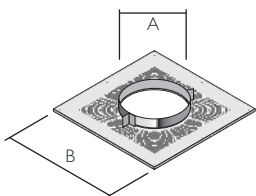

Combustible Floor G50 Square Ventilated Support Plate 1 Piece		
Int Ømm	125	150
Ext Ømm	180	200
A	183	241
B	380	400
SAP Code Plain	175707	175708

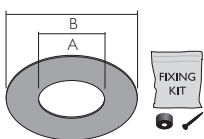

Magnetic Firestop Cover Plate Kit					9509
Int Ømm	100	125	150	180	200
Ext Ømm	150	180	200	235	256
A	154	183	203	241	259
B	370	380	400	430	450
SAP Code Plain	147378	126945	127552	128127	128611
SAP Code Black	147379	126946	127553	128128	128612
SAP Code White	147380	126947	127554	128129	128613

G60 Firestop Components

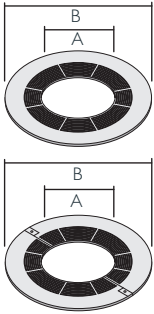

Combustible Floor					
Round Ventilated Firestop Plate - 1 Piece*					9423
Round Ventilated Firestop Plate - 2 Piece					9424
Int Ømm	100	125	150	180	200
Ext Ømm	150	180	200	235	256
A	153	183	203	241	259
B	350	380	400	430	450
SAP Code 1PC Plain	125902	126661	127227	128117	128601
SAP Code 1PC Black	125900	126659	127225	128115	128599
SAP Code 1PC White	125901	126660	127226	128116	128600
SAP Code 2PC Plain	125905	126664	127230	128120	128604
SAP Code 2PC Black	125903	126662	127228	128118	128602
SAP Code 2PC White	125904	126663	127229	128119	128603

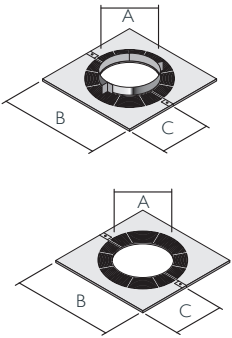

Combustible Floor G60 Ventilated Support Plate - 2 Piece						95260
Combustible Floor G60 Rectangular Ventilated Firestop Plate - 2 Piece						94250
Int Ømm	100	125	150	180	200	
Ext Ømm	150	180	200	235	256	
A	153	183	203	241	259	
B	350	380	400	430	450	
C	175	190	200	215	225	
SAP Code Support Plate	125908	126667	127234	128124	128607	
SAP Code Firestop Plate	125907	126666	127232	128122	128606	

Bungalow Firestop Kits

All Unventilated Bungalow Firestop Kits may only be used on a combustible ceiling in a bungalow where there is a minimum 50mm distance to combustibles where the chimney penetrates the ceiling area and where the roof space above the ceiling is open and ventilated. Within the roof space, a protective wire mesh framework must be built around the chimney to ensure the minimum 50mm distance to combustibles is maintained.

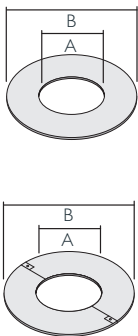

Unventilated Bungalow Round Firestop Plate - 1 Piece and 2 Piece 9428 9429					
Int Ømm	100	125	150	180	200
Ext Ømm	150	180	200	235	256
A	153	183	203	241	259
B	350	380	400	430	450
SAP Code Plain 1 PC	147381	126526	127108	128084	128571
SAP Code Black 1 PC	147382	126528	127110	128086	128572
SAP Code White 1 PC	147383	126529	127111	128087	128573
SAP Code Plain 2 PC	147384	126527	127109	128085	131123
SAP Code Black 2 PC	147385	131122	127106	-	-
SAP Code White 2 PC	147386	-	127107	-	-

Support Components

NEW!

Retrofit Wall Supports



Int Ømm	100	125	150
Ext Ømm	150	180	200
SAP Code Plain 60mm - 200mm	169699	169700	169701
SAP Code Black 60mm - 200mm	169696	169697	169698
SAP Code Plain 200 - 375mm	170321	170322	170323
SAP Code Black 200 - 375mm	170318	170319	170320

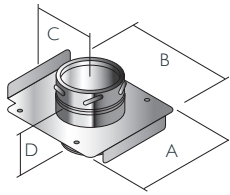

Top Plate

DN8A0D3

Int Ømm	100	125	150	180	200
Ext Ømm	150	180	200	235	256
A	266	276	296	334	352
B	247	287	307	342	363
C	127	142	152	170	180
D	106	106	106	105	108
SAP Code Plain	147387	125140	125833	126572	127151
SAP Code Black	147388	125141	125834	COA	COA

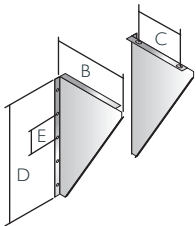

Wall Support Side Plates

DN8A0D2

Int Ømm	100	125	150	180	200
Ext Ømm	150	180	200	235	256
A	235	275	295	325	345
B	165	160	180	210	230
C	470	470	470	470	470
D	100	100	100	100	100
SAP Code Plain	101043	125357	126136	126862	127445
SAP Code Black	-	125355	126133	-	-

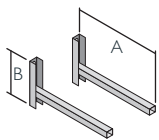

Cantilever Support

Type 325 - 95420001
Type 475 - 95420002

Type	325	475
Int Ømm Range	00-150	100-200
A	325	475
B	242	242
SAP Code Plain	101742	101743
SAP Code Black	130686	130687

Used in combination with Adjustable Top Plate.

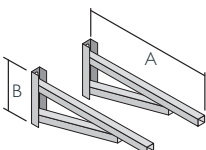

Cantilever Support

Type 570 - 95420003

Type	570
Int Ømm Range	100-200
A	570
B	330
SAP Code Plain	101744
SAP Code Black	130688

Used in combination with Adjustable Top Plate.

Support Components

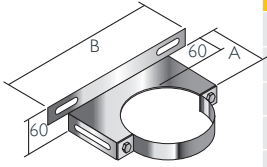

Retrofit Wall Band						95600
Int Ømm	100	125	150	180	200	
Ext Ømm	150	180	200	235	256	
A	136	151	161	180	189	
B	300	330	350	388	406	
SAP Code Plain	147389	126657	127223	128113	128597	
SAP Code Black	147390	126658	127224	128114	128598	

COA : Code on application

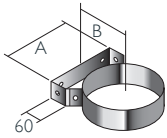

Wall Band (60mm)						92930
Int Ømm	100	125	150	180	200	
Ext Ømm	150	180	200	235	256	
A	148	180	200	238	256	
B	135	140	150	168	178	
SAP Code Plain	125898	126648	127213	128110	128594	
SAP Code Black	131170	126620	127196	128095	128580	

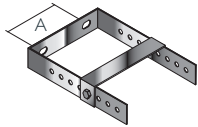

Adjustable Back Bracket for Wall Band 60-300mm						95950
Int Ømm	100	125	150	180	200	
Ext Ømm	150	180	200	235	256	
A	83	112	132	162	186	
SAP Code Plain	125890	126623	127199	128098	128583	
SAP Code Black	-	126622	127198	128097	128582	

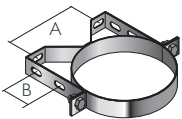

Structural Wall Band (50mm)						95430
Int Ømm	100	125	150	180	200	
Ext Ømm	150	180	200	235	256	
A	126	144	164	194	214	
B	55	55	55	55	55	
SAP Code Plain	101264	101265	101266	128112	128596	
SAP Code Black	-	126654	127218	-	-	

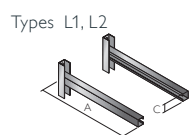
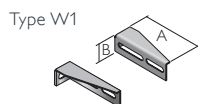

Structural and Retrofit Wall Band Extensions				W1 - 95440001	L1 - 95440004	L2 - 95440005
Type	W1	L1	L2			
Adj.	55-100	100-250	100-440			
A	130	300	450			
B	36	-	-			
C	-	32	32			
SAP Code Plain	101735	143846	143847			
SAP Code Black	130824	144655	144656			

COA : Code on application

Support Components

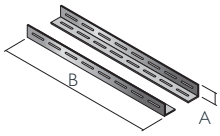

Ceiling Joist Support Arms (Pair)		9459001
Type		570
Int Ømm Range		125-200
A		39
B		700
SAP Code Plain		130694

Used in combination with Ceiling Joist Support.

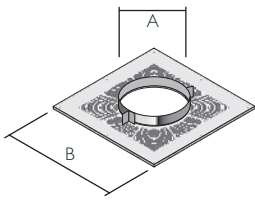

Ceiling Joist Support					
Int Ømm	100	125	150	180	200
Ext Ømm	150	180	200	238	256
A	291	321	341	379	397
SAP Code Plain G60 Ceiling Joist Support	147391	126669	127238	128125	128609
Plain G50 Ceiling Joist Support	-	COA	COA	-	-

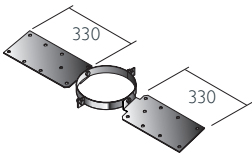

Roof Support						94640
Int Ømm	100	125	150	180	200	
Ext Ømm	150	180	200	235	256	
SAP Code Plain	100961	100962	100963	128126	128610	

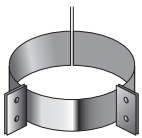

Guy Wire Bracket						95900
Int Ømm	100	125	150	180	200	
Ext Ømm	150	180	200	235	256	
SAP Code Plain	100640	100641	100642	128101	128586	
SAP Code Black	-	131808	127202	-	-	

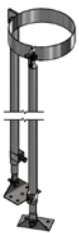

Telescopic Roof Stays					
Ext Ømm	150	180	200	235	256
SAP Code Black	170141	170142	170143	170145	170147

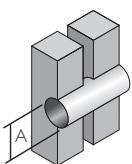

Wall Sleeve 90°	Masonry - 94980					Timber Frame - 94810
	Int Ømm	100	125	150	180	200
Ext Ømm	150	180	200	235	256	
A Masonry	200	230	250	288	306	
A Timber F	270	300	320	358	376	
SAP Code Masonry	147392	126642	127206	-	-	
SAP Code Timber	125897	126647	127212	128108	128592	

Support Components

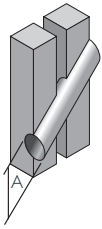

Wall Sleeve 45°	Masonry - 94620					Timber Frame - 94910
	Int Ømm	100	125	150	180	200
Ext Ømm	150	180	200	235	256	
A Masonry	200	230	250	288	306	
A Timber F	270	300	320	358	376	
SAP Code Masonry	125894	126641	127205	128102	128587	
SAP Code Timber	125895	126643	127207	128103	128588	

Supplied as a 1m long mitred tube to be cut to length on site

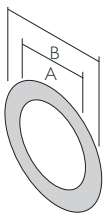

1 Piece Trim Collar 90°	9580				
Int Ømm	100	125	150	180	200
Ext Ømm	150	180	200	235	256
A	154	184	204	242	260
B	300	330	350	388	406
SAP Code Plain	-	127038	127642	128133	128618
SAP Code Black	126337	127039	127643	128134	128619

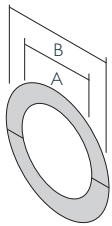

2 Piece Trim Collar 90°	9599				
Int Ømm	100	125	150	180	200
Ext Ømm	150	180	200	235	256
A	154	184	204	242	260
B	300	330	350	388	406
SAP Code Plain	126338	127040	127644	-	--
SAP Code Black	126339	127041	127645	-	COA

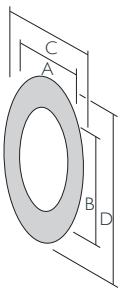

1 Piece Trim Collar 45°	9589				
Int Ømm	100	125	150	180	200
Ext Ømm	150	180	200	235	256
A	154	184	204	242	260
B	216	259	287	341	366
C	300	330	350	388	406
D	412	454	483	536	562
SAP Code Plain	147393	126612	127186	128089	128575
SAP Code Black	147394	126613	127187	128090	128576
SAP Code White	147395	126614	127188	128091	128577

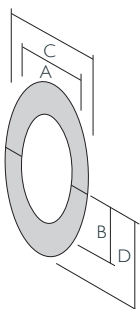

2 Piece Trim Collar 45°	9579				
Int Ømm	100	125	150	180	200
Ext Ømm	150	180	200	235	256
A	154	184	204	242	260
B	108	130	144	171	183
C	300	330	350	388	406
D	206	227	242	268	281
SAP Code Plain	126335	127035	127639	128130	128615
SAP Code Black	126336	127036	127640	128131	128616
SAP Code White	-	127037	127641	128132	128617

COA : Code on application

Support Components

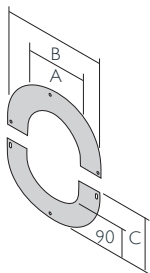

Adjustable Trim Collar 35-45°					
Int Ømm	100	125	150	180	200
Ext Ømm	150	180	200	235	256
A	-	187	204	242	260
B	-	364	384	422	440
C	-	204.5	214.5	238.5	247.5
SAP Code Plain	-	126513	127093	128071	128558
SAP Code Black	-	126511	127091	128069	128556
SAP Code White	-	126512	127092	128070	128557

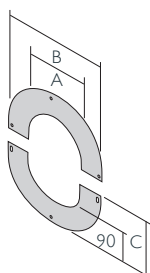

Adjustable Trim Collar 0-20°					
Int Ømm	100	125	150	180	200
Ext Ømm	150	180	200	235	256
A	-	187	204	242	260
B	-	364	384	422	440
C	-	204.5	214.5	238.5	247.5
SAP Code Plain	-	126507	127087	128065	128552
SAP Code Black	-	126505	127085	128063	128550
SAP Code White	-	126506	127086	128064	126512

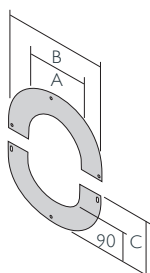

Adjustable Trim Collar 20-35°					
Int Ømm	100	125	150	180	200
Ext Ømm	150	180	200	235	256
A	-	187	204	242	260
B	-	364	384	422	440
C	-	204.5	214.5	238.5	247.5
SAP Code Plain	-	126510	127090	128068	128555
SAP Code Black	-	126508	127088	128066	128553
SAP Code White	-	128067	127089	128067	128554

Loft Guard

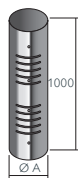

Loft Guard					
Int Ømm	100	125	150	180	200
Ext Ømm	150	180	200	235	256
Ø A	-	300	320	350	376
SAP Code Plain	-	137464	137464	137465	137465

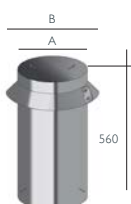

Loft Guard - for Scottish Regulations			
Int Ømm		180	200
Ø A		300	320
Ø B		400	420
SAP Code Plain		158404	158405

Ignis-Protect

Designed specifically for Air Tight, Energy Efficient and Timber Framed Buildings



In order to meet the latest European building regulations, specific leakage and performance criteria have to be met, which are much more stringent than in the past. These criteria are key in relation to chimney products passing through combustible walls.



Protected in accordance with European patent specification EP 1 878 849 B1

Schiedel Chimney Systems have invested heavily to provide tested and approved solutions to resolve these challenges and are proud to introduce their latest cutting edge product.



IGNIS-PROTECT,
Winner of Best Product Award
Hearth & Home Exhibition 2015.

Product Description

PRODUCT FEATURES

- Suitable for SW and DW connecting flue pipes passing through interior or exterior walls made of combustible materials
- Available in two versions:
 - **For exterior walls** (with aluminium laminate on inside face)
 - **For interior walls** (without aluminium laminate and with an extended removable core)
- Available in both 90° and 45° versions
- For flue gas temperature up to:
 - 450 °C for SW connecting flue pipes (T450)
 - 600 °C for DW connecting flue pipes(T600)
- Max. 100 °C surface temperature during soot fire
- Monolithic component made of mineral wool, density 120 kg/m³, building material class A1
- Internal face finished with aluminium laminate
- External face made with textured surface to facilitate facade rendering
- Removable pipe sections DN 125, 130, 150, 180, 200 mm
IGNIS-PROTECT can be used without any additional protection
- Available in a range of standard wall thicknesses between 100mm -500mm

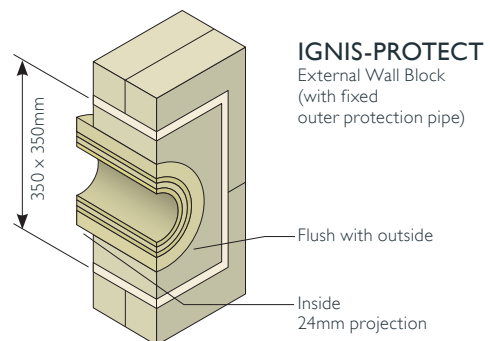
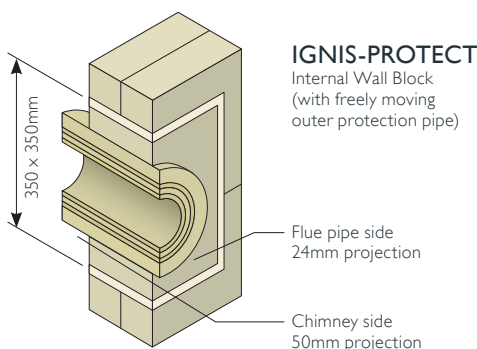

Approvals

DIBt
Zulassungs Nr. Z-7.4-3372 Deutsches Institut für Batechnik

- Z-7.4-3372 relating to T450 designated products
- Z-7.4-3402 relating to T600 designated products

Ignis-Protect

(for air tight wall penetration)

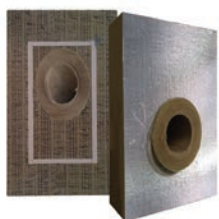
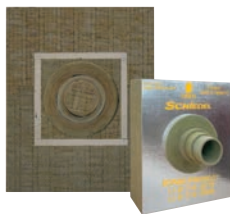

SAP Code	Thickness (mm)	Height (mm)	Width (mm)	Pallet Quantity
Ignis-Protect 90° Version				
101841	150	700	565	12
101842	200	700	565	9
101843	250	700	565	6
101844	300	700	565	4
101845	350	700	565	4
101846	400	700	565	2
Ignis-Protect 45° Version				
149530	100	1020	565	18
149531	150	1020	565	12
149532	200	1020	565	9
149533	250	1320	565	6
149534	300	1320	565	4
149535	350	1320	565	4
149536	400	1320	565	2
144032	450	1320	565	2
144033	466	1320	565	2
144034	500	1320	565	2

For more information on IGNIS-PROTECT 90° and 45° please refer to p.30

IGNIS-PROTECT 45° VERSION

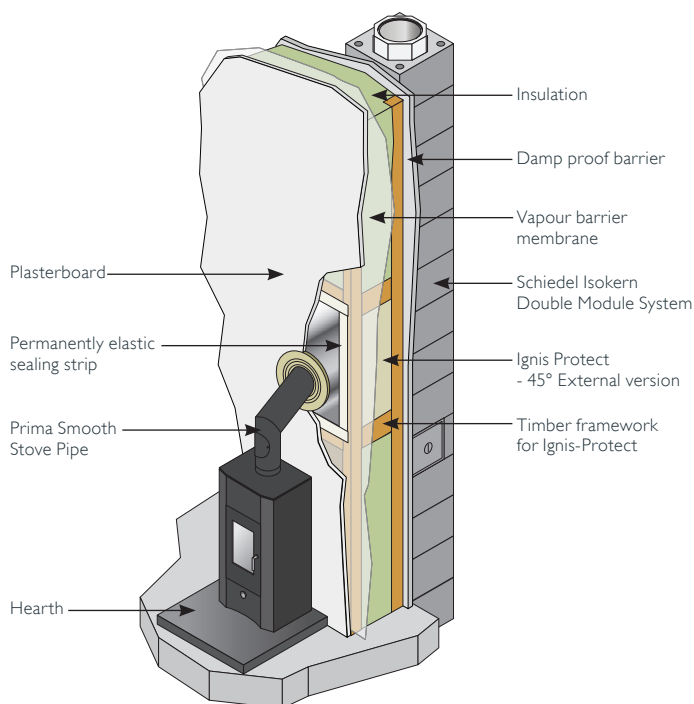

IGNIS-PROTECT ICID PLUS ON TRADITIONAL TIMBER FRAME WALL

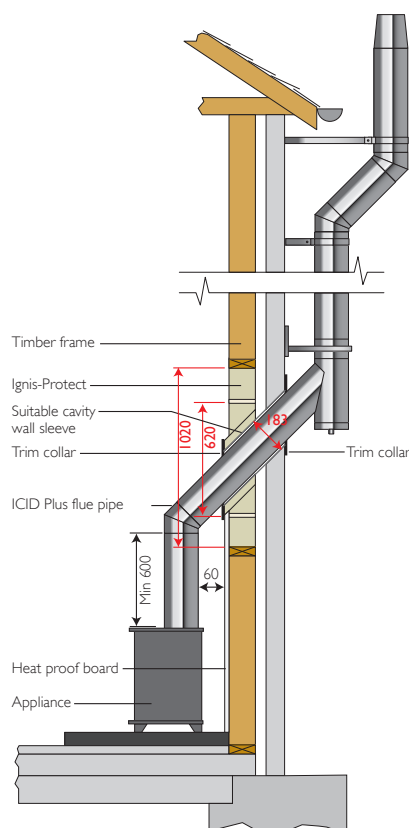

Protect Box

Engineered to meet the key challenges of modern houses...

- Ever more air tight construction
- Increasing depth of loft insulation



Schiedel Protect Box is the proven solution to safeguard distance to combustibles in low energy and passive houses.

PRODUCT FEATURES

- Designed to meet blower door test.
- Constructed using a high temperature resistant Rockwool insulation with an aluminium laminate outer surface to give zero distance to combustibles.
- An EPDM kit is available to allow for the chimney to pass through an air tight membrane at ceiling level in a cold roof construction or at roof level in a warm roof construction.
- Standard height 700 mm to meet new roof insulation requirements.

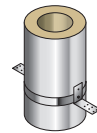

Protect Box	
SAP Code	121342



EPDM Seal	
SAP Code	136939

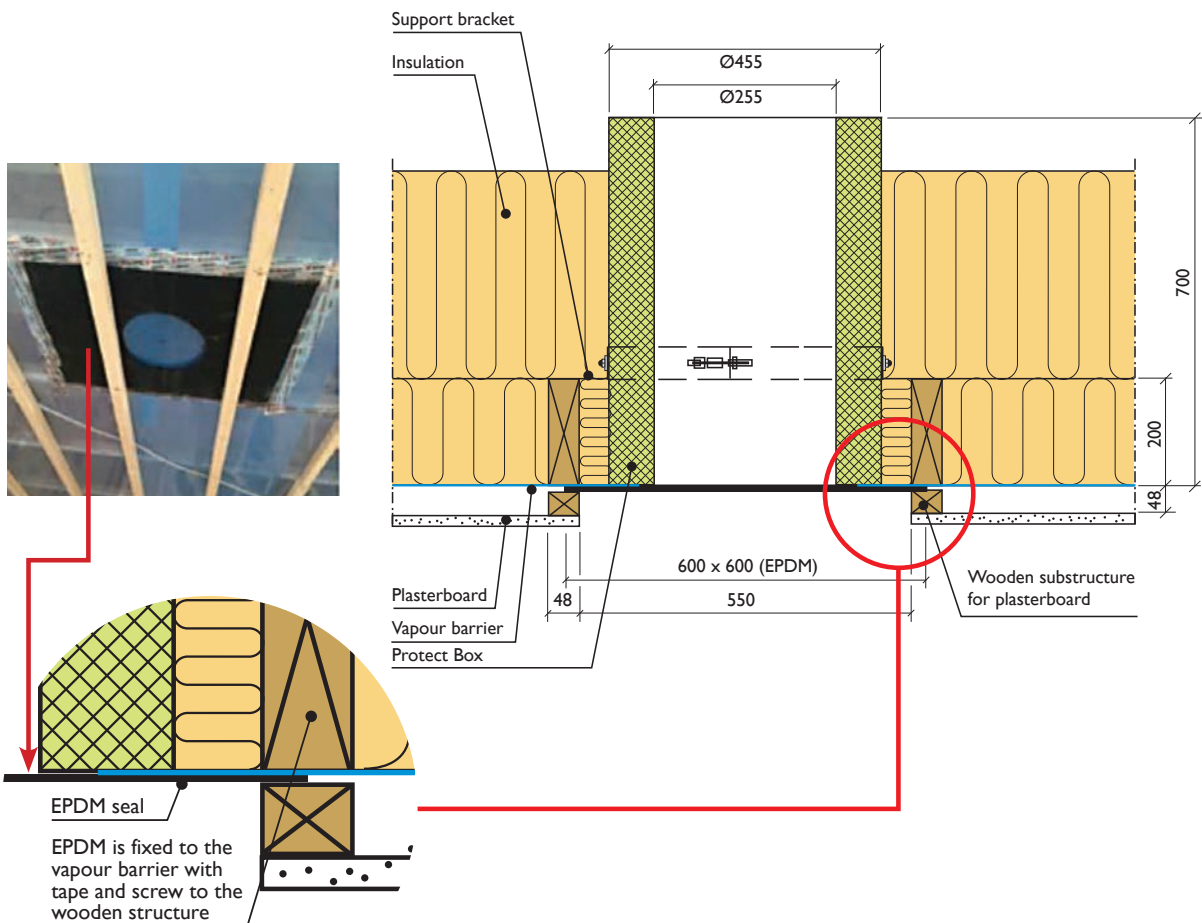

Protect Box and Accessories

(for air tight ceiling/roof penetration)

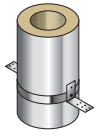

Protect Box	
Int Ømm	251
Ext Ømm	451
SAP Code	121342

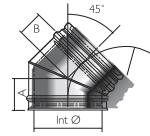

Bends	
Int Ømm	150
Ext Ømm	250
SAP Code 45° Bend	104804

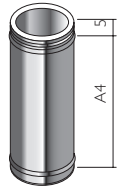

Pipes	
Int Ømm	150
Ext Ømm	250
SAP Code 1000 mm	104784
SAP Code 500 mm	104779
SAP Code 250 mm	104774

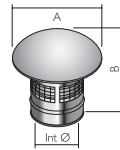

Raincaps	
Int Ømm	150
Ext Ømm	250
SAP Code No Mesh	126241
SAP Code With Mesh	126240



EPDM Seal	
SAP Code	136939

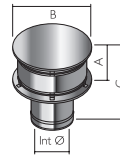

Anti Draught Term. With Mesh	
Int Ømm	150
Ext Ømm	250
SAP Code	115244



Roof Support	
Int Ømm	150
Ext Ømm	250
SAP Code	100965

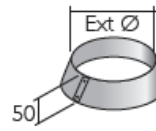

Storm Collar	
Int Ømm	150
Ext Ømm	250
SAP Code	106143

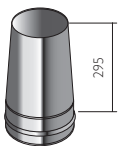

Tapered Terminal	
Int Ømm	150
Ext Ømm	250
SAP Code	114311

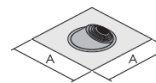

Uniflash	
Int Ømm	150-300
A	685
SAP Code	112197

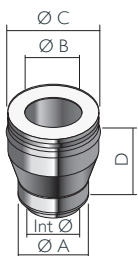

ICID Plus - ICS50 Adaptor		
Int Ømm	125	150
Ø A	180	200
Ø B	150	150
Ø C	251	250
D	195	195
SAP Code Plain	171864	148919
SAP Code Black	171863	148920

Typical Installations

PROTECT BOX IN SITU

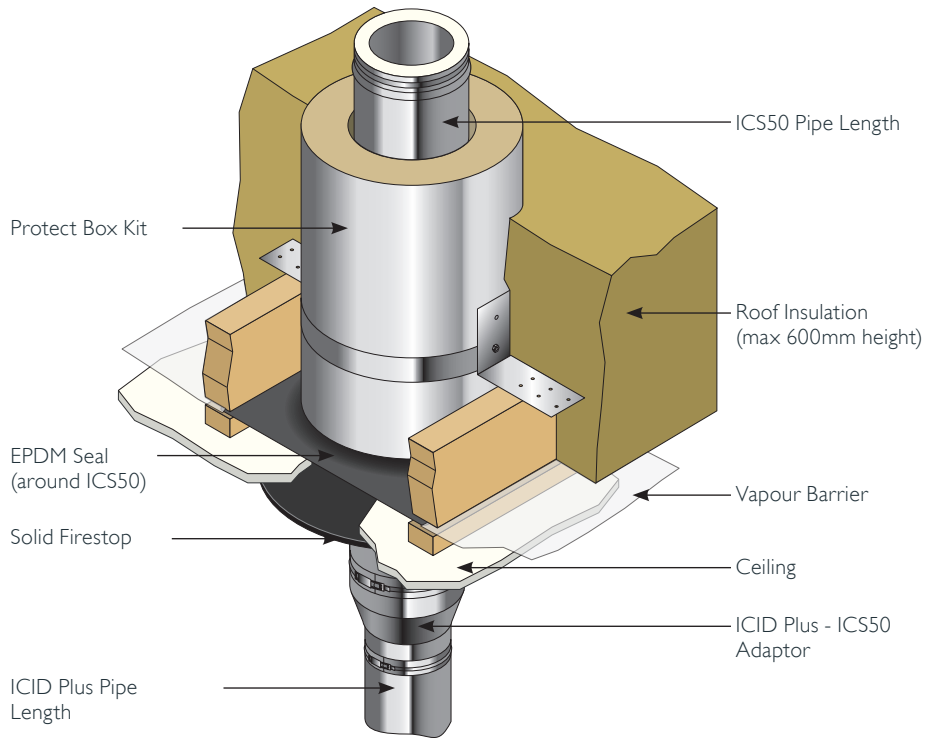

SCHIEDEL PROTECT BOX THROUGH PITCHED ROOF

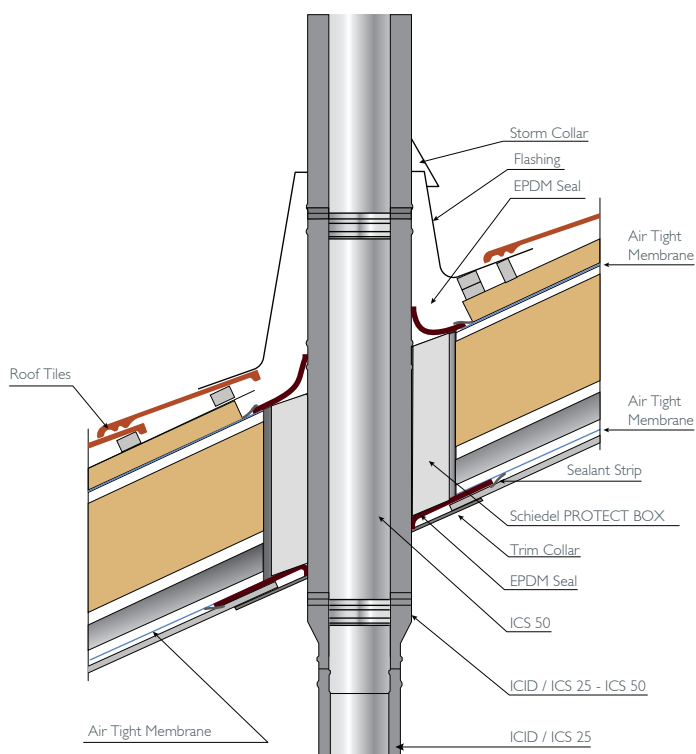

Flashings

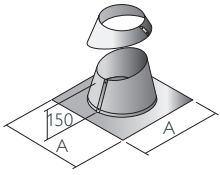

Angled Flashing Kit 5° - 45°					95510
Int Ømm	100	125	150	180	200
Ext Ømm	150	180	200	235	256
A	610	610	700	700	800
SAP Code Plain	125889	126621	127197	128088	128574
SAP Code Black	-	-	130662	-	-

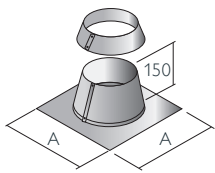

Flat Flashing Kit					95530
Int Ømm	100	125	150	180	200
Ext Ømm	150	180	200	235	256
A	610	610	610	610	610
SAP Code Plain	125892	126625	127201	128100	128585
SAP Code Black	-	-	131807	-	-

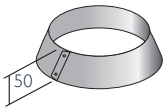

Storm Collar					
Int Ømm	100	125	150	180	200
Ext Ømm	150	180	200	235	256
SAP Code Plain	106138	106140	106141	128106	128590
SAP Code Black	-	126645	127209	128105	-

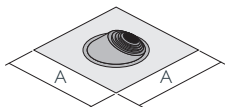

Uniflash		
Product Code	94540001	94540002
Ext Ømm	80-200	150-300
A	500	685
SAP Code	112198	112197
Universal EPDM rubber/aluminium flashing. Just pull the required diameter tab on the rubber seal.		

Terminals

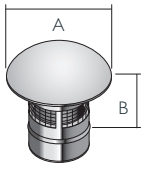

Raincap		with 10mm sparkguard DN8A145				
Int Ømm		100	125	150	180	200
Ext Ømm		150	180	200	235	256
A		266	266	310	362	362
B		70	90	90	90	115
SAP Code Plain		147397	125336	126112	126846	127430
SAP Code Black				133925		

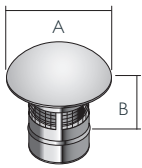

Raincap		with 25mm anti-bird mesh DN8A140				
Int Ømm		100	125	150	180	200
Ext Ømm		150	180	200	235	256
A		266	266	310	362	362
B		70	90	90	90	115
SAP Code Plain		147399	125337	133921	126847	127431
SAP Code Black		147400	125335	133924	126845	127432

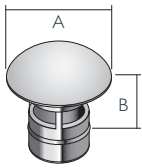

Raincap		without mesh DN8A142				
Int Ømm		100	125	150	180	200
Ext Ømm		150	180	200	235	256
A		266	266	310	362	362
B		70	90	90	90	115
SAP Code Plain		147401	125144	133923	126574	127153
SAP Code Black		147402	125145	133926	126575	-

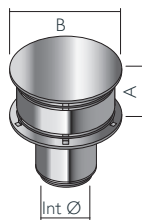

Anti-splash Anti-downdraught Terminal (Gastec Approved)						
Int Ømm		100	125	150	180	200
Ext Ømm		150	180	200	230	250
A		-	142	170	204	204
B		-	254	304	354	404
SAP Code with mesh Plain		-	125302	126074	126821	127406
SAP Code with mesh Black		-	-	-	-	-
SAP Code without mesh Plain		-	125303	126075	126822	127406
SAP Code without mesh Black		-	125301	126073	-	131797

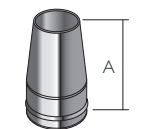

Insulated Tapered Terminal		DN8A038				
Int Ømm		100	125	150	180	200
Ext Ømm		150	180	200	235	256
A		204	200	200	204	240
SAP Code Plain		147403	125351	126130	126857	127441
SAP Code Black		147404	125352	126129	126858	-

Distance to Combustibles on high temperature

(T450) applications (see p.17)

INTERNAL HOUSE Fig. 1
Combustible Floors

Ventilated G60 Fire stop and G60 Support Plate combination

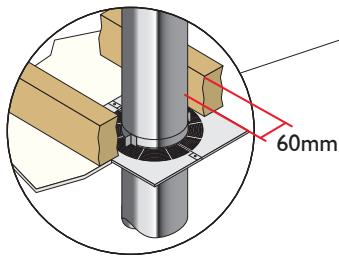

60mm

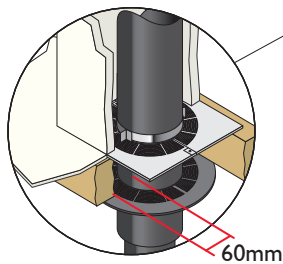

60mm

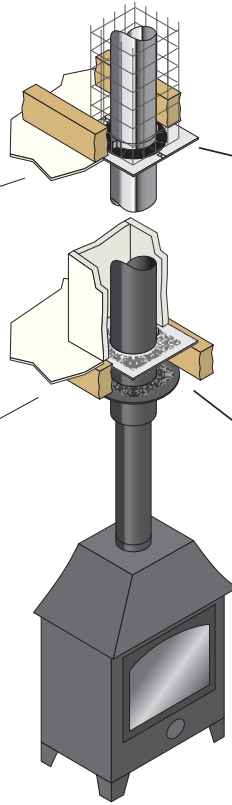

Ventilated G50 Fire Stop and G50 Support Plate Combination

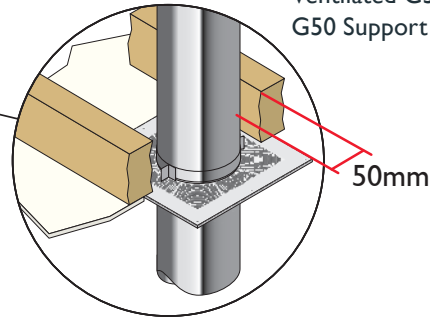

50mm

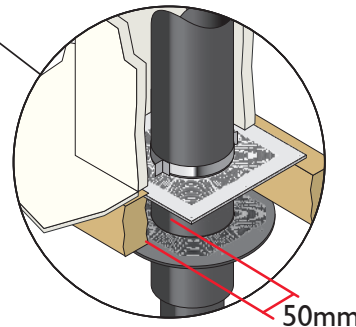

50mm

INTERNAL BUNGALOW (VENTILATED LOFT SPACE) Fig. 2
Combustible and Non-Combustible Floors

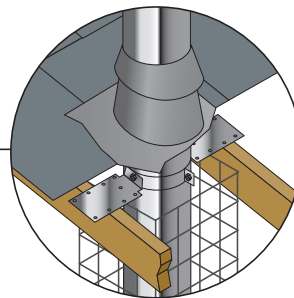
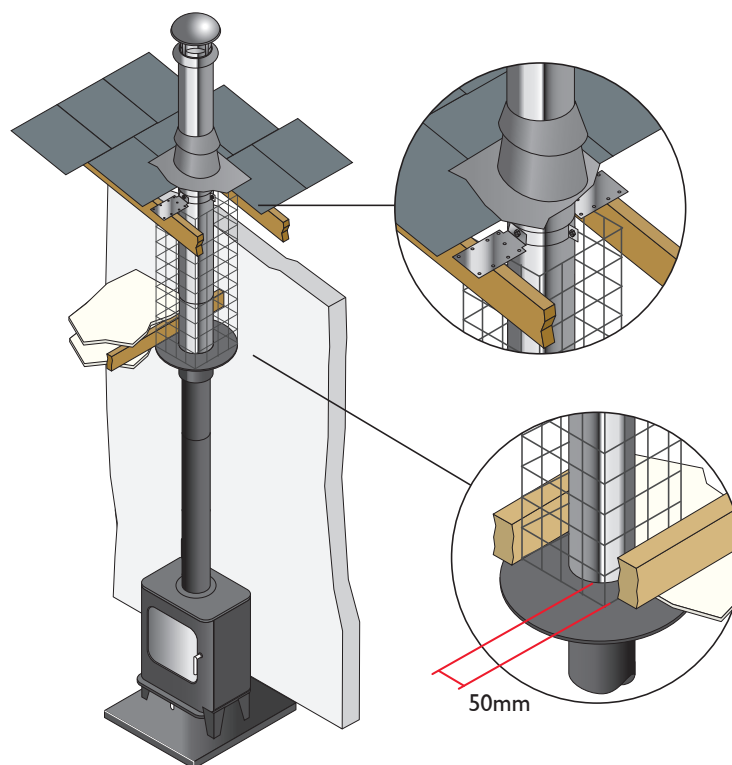

50mm

System Design

OUTLET SITING

Flue terminations for solid fuel & oil are subject to EN15287-1 2007. Figures A and B illustrate recommendations for the most commonly encountered outlet terminations. Flue terminations for gas in domestic situations are governed by the BS5440-1 2008 Section 4.2. Figure C illustrates recommendations for the most common siting situations encountered. Adjacent taller structures may require increased height. The minimum flue projection through the roof is 600mm to the underside of the terminal.

FLUE ROUTING

The chimney should remain as straight as possible through its vertical run to assist flow. Should it be necessary to offset a chimney run the following guidelines should be adhered to: It is recommended that a vertical rise of 600mm should be allowed immediately above the appliance before any change of direction.

Within a system, on all fuels, there should be no more than 4 changes of direction of maximum 45°.

90° Factory made bends or tees within the system may be treated as being equal to two 45° bends (see Document J of the Building Regulations issued October 1st 2010).

LOCATION OF OUTLET

Fig. A
Outlet siting for Oil Appliances (<45kW)

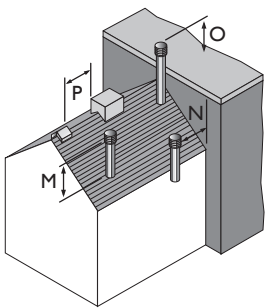
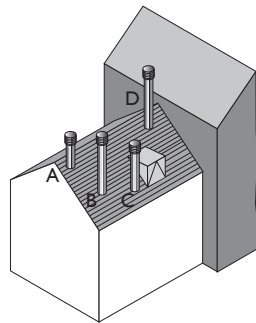

Fig. B
Outlet siting for Solid Fuel Appliances (<50kW)



TERMINAL TYPES

On solid fuel appliances, an open termination is normally recommended. However in certain conditions, rain caps or anti-downdraught terminals may be used.

Rain caps and anti-downdraught terminals are available in two versions, with mesh/spark guard and without mesh. Where a terminal with mesh is used, there is a risk of soot build up, and therefore regular cleaning is required to avoid blockage, particularly when using oil or solid fuel.

PROVISION FOR SWEEPING, CLEANING AND MAINTENANCE

Provision should be made for inspecting and cleaning the chimney. To aid cleaning, sufficient distance should be left between changes of direction to permit the safe passage of cleaning brushes within the system. This is particularly important on solid fuel applications. It is recommended that chimneys serving solid fuel appliances be swept as frequently as necessary but at least twice a year. Choose an access component suitable for your installation unless cleaning/inspection can be done through the appliance.

OUTLET SITING FOR OIL APPLIANCES (<45KW)

Location of outlet	Pressure Jet Burner	Vapourising Burner
M Above the highest point of an intersection with the roof	600mm	1000mm
N From a structure to the side of the terminal	750mm	2300mm
O Above a vertical structure which is less than 750mm (pressure jet burner) or 2300mm (vapourising burner) horizontally from the side of the terminal	600mm	1000mm
P From a ridge terminal to a vertical structure on the roof	1500mm	Should not be used

OUTLET SITING FOR SOLID FUEL APPLIANCES (<50KW)

Point where flue passes through weather surface (Notes 1, 2)	Clearance to flue outlet
A At or within 600mm of the ridge	At or within 600mm above the ridge
B Elsewhere on the roof (whether pitched or flat)	At least 2300mm horizontally from the nearest point on the weather surface and: a) at least 1000mm above the highest point of intersection of the chimney and the weather surface; or b) at least as high as the ridge
C Below (on a pitched roof) or within 2300mm horizontally to an openable roof-light, dormer window or other opening (Note 3)	At least 1000mm above the top of the opening
D Within 2300mm of an adjoining or adjacent building, whether or not beyond the boundary (Note 3)	At least 600mm above any part of the adjacent building within 2300mm

System Design

1. The weather surface is the building external surface, such as its roof, tiles or external walls.
2. A flat roof has a pitch less than 10°.
3. The clearance for A or B, as appropriate, will also apply.
4. A vertical flue fixed to an outside wall should be treated as equivalent to an inside flue emerging at the nearest edge of the roof.

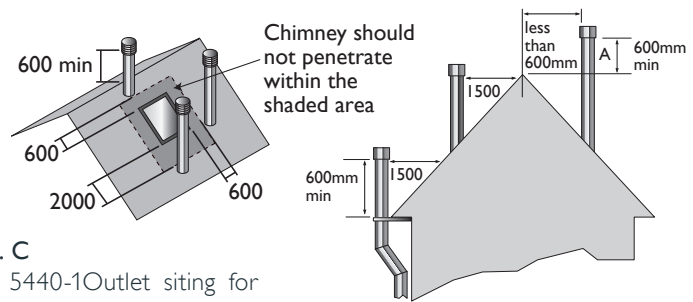

Fig. C
BS 5440-1 Outlet siting for Gas Appliances (<70kW)

ROOM VENTILATION

The room carrying the appliance should have an air vent either direct to an external air source or vented into a room that has an external vent direct to an air source. This is required to provide adequate air supply to allow the appliance and flue to operate efficiently. These requirements are specified in the Building Regulations (Document J) also by CIBSE and BS5440.

COMMERCIAL INSTALLATIONS

Schiedel Rite-Vent can provide a full design & flue sizing advice service for commercial installations, using both ICID Plus and our ICS product ranges.

PROVISION FOR CONDENSATE DISPOSAL

(subject to appliance manufacturer recommendations)

Normally solid fuel and atmospheric gas and oil appliances will not need a drain unless rain ingress is significant. Most condensing appliances however need provision for drainage. As a rule of thumb a condensing boiler produces 1 to 1.5 litres of condensate per hour per 10kW of input.

This is a significant amount of acidic liquid which must be drained from the system. Choose appropriate flue drainage components, normally fitted at the base of the stack and close to the appliance outlet.

On high efficiency or on condensing systems, a 3° slope on horizontal runs is advised, using the appropriate 87° bend and 93° tee.

Load Bearing Data

Maximum Load Bearing (metres of pipe)			
Internal Diameter (mm)	80-130	150-180	200-250
Base Drain Section	22	18	18
Retrofit Wall Support	10	10*	-
Drain Plug Support	18	18	18
Adjustable Top Plate + Locking Band	15	15	15
Telescopic Floor Support	18	18	18
Pair of Side Plates (see diagram A)	15	15	15
Pair of Side Plates (see diagram B)	10	10	10
Cantilever Support	22	18	18
Extension Support (Anchor Plate)	1.5	1.5	1.5
Ventilated Support Plate (All types)	12	12	9
Support Plate	12	12	9
Ceiling Hanger	1.5	1.5	1.5
Wall Band 50/60mm	3	3	3
Adjustable Wall Band 60-300mm	3	3	3
Structural Wall Band	4	4	4
Extension for Structural Wall Band	4	4	4
Guy Wire Bracket	1.5	1.5	1.5
Roof Support (above truss)	6	6	6
Roof Support (below truss)	4	4	4
90° Tee + Locking Band	22	18	18
93° Tee + Locking Band	22	18	18
135° Tee + Locking Band	15	10	10
Inspection Tee (Round)	22	18	18
Inspection Tee (Rectangular)	22	18	18

Approximate Weights of Products (Kg)				
Internal Diameter Length(mm)	1000	500	250	195
80	4.32	2.13	1.09	0.85
100	5.14	2.53	1.29	1.01
130	6.35	3.14	1.60	1.24
150	7.18	3.54	1.86	1.41
180	8.40	4.14	2.11	1.65
200	9.22	4.55	2.31	1.80
230	10.44	5.13	2.62	2.03
250	11.24	5.53	2.81	2.19
300	15.08	7.58	3.44	2.47

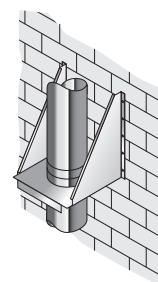

Diagram A

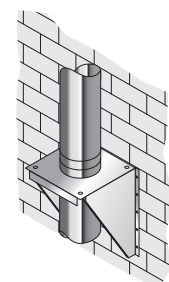

Diagram B

* Retrofit Wall Support available diameters 80 - 150 only

Installation

These notes should be read in conjunction with the detailed ICID Plus Installation Instructions.

MANDATORY REQUIREMENTS

Connection to an appliance that is connected to the fuel supply must be carried out by a GAS SAFE (gas) or OFTEC (oil) registered installer. We recommend the use of HETAS approved installers for solid fuel applications. For full design and installation details the key referral documents are:

- BS EN 1856-1: Chimneys - System Chimney Products
- BS EN 1859: Metal Chimneys - Testing Methods
- BS EN 1443: Chimneys - General Requirements
- BS EN 15287-1: Chimneys. Design, installation and commissioning of chimneys. Chimneys for non-room sealed heating appliances.
- BS 5440-1: Flueing and ventilation for gas appliances of rated input not exceeding 70kW net (1st, 2nd and 3rd family gases)
- Specification for installation of gas appliances to chimneys and for maintenance of chimneys.
- Approved Document J: - Combustion appliances and fuel storage systems (England & Wales)
- DFP Technical Booklet L: - Combustion appliances and fuel storage systems (NI)
- Technical Handbook (Domestic & Non Domestic), Section 3 - Environment (Scotland)
- Appliance Installation Instructions and related standards. Other standards covering specific applications will also be relevant and must be adhered to.
- Planning permission may be required, and reference should be made to the local Building Control Department.

ENCLOSURE/SHAFTS

With the exception of the room containing the appliance, where the chimney passes through any part of the building, where there is a risk of accidental human contact, i.e a bedroom etc., or where there is a risk of contact with combustible materials stored in a cupboard or in the roof-space, the chimney must be enclosed in an appropriate way to meet Building Regulations. This can be achieved by boxing in the chimney in habitable rooms, or by the use of a protective wire mesh frame in roof spaces etc. In all cases the minimum distance to any combustible material, including loft insulation, must be respected according to the table on p.3, and any enclosure should be ventilated using the appropriate ventilated fire stops (see p.17).

DISTANCE TO COMBUSTIBLES

In accordance with building regulations it is essential that the correct distance to combustible material is maintained. On solid fuel applications, where there is a risk of soot fire, a distance of 60mm to combustibles must be maintained within a combustible floor and within a combustible shaft, where the old G60 ventilated fire stop plates and G60 ventilated support plate are used (see Fig.1 p.31). Where the new G50 ventilated firestop plates and G50 ventilated support plates are used, then this distance to combustibles is reduced to 50mm both within the floor space and within the shaft. There is no need to line the area within the floor cavity with plasterboard; however the ventilated fire stop plate and ventilated support plate must be used.

On gas and oil applications, a distance of 50mm to combustibles must be maintained within a combustible floor and within a combustible shaft. The ventilated fire stop plate and ventilated support plate must be used.

Where the chimney penetrates a non combustible floor and where a non combustible shaft is used, a distance of 50mm to the shaft is sufficient. In this case, non ventilated fire stops and non ventilated support plates may be used at first floor level with a ventilated fire stop being used where the chimney penetrates into the roof space.

On bungalow applications where the chimney runs through either a combustible or non-combustible ceiling, an unventilated bungalow fire stop plate kit can be used. Please note that an unventilated support plate can not be used above the ceiling in this case. The weight of the chimney should be supported using the roof support (see p.21). Distance to combustibles must be respected within the ceiling space (see Fig. 2 p.31) and mesh frame should be used within the loft space, which must be ventilated (see Fig. 2 p.31).

JOINTING SYSTEM

All joints in the ICID Plus chimney range, which require a locking band, are made by means of a simple twist lock jointing method. This is achieved by pushing together the male and female collars on each end of the main chimney components and twisting the components through 1/6 of a turn to lock the collars into place. It should be noted that the female collars on elbows and tees are not fluted in order to allow for these items to be positioned according to requirements on site. In all cases the joints should be held securely in place using the locking band, which is supplied with all components with a female collar.

Where a system is to be used on a positive pressure condensing appliance, then components, which are not designated as dry only, can be converted for this application by the addition of the lip seal or in the case of adjustable pipes, lip seals. Please refer to p.6.

Joints are not permitted within wall and ceiling spaces. Any flue pipe (i.e. single wall) connection to the chimney must be made in the same room as the appliance. The chimney must project at least 425mm below the ceiling. Where a chimney passes through a wall, a wall sleeve must be used to prevent damage to the chimney and the building.

CONNECTION TO APPLIANCE

Use the appropriate appliance connector, sealing with fire rope and fire cement or high temperature sealant on solid fuel. The length of the inner liner can be trimmed where required to allow for thermal expansion within the appliance outlet spigot.

APPLIANCE REMOVAL

Use of an adjustable length immediately above the appliance enables removal of the appliance later without dismantling the full system.

Installation

INSPECTION

To conform to Building Regulations, provisions should be made to enable a chimney to be inspected and cleaned. An inspection length or an insulated 90° or 135° Tee can form a suitable inspection point. To aid cleaning, sufficient distance should be left between changes of direction to permit the safe passage of cleaning brushes within the system. This is particularly important on solid fuel applications. It is recommended that chimneys serving solid fuel appliances be swept as frequently as necessary, but at least twice a year.

CHIMNEY DIAMETER

The chimney size should be as recommended by the appliance manufacturer and must satisfy the flue sizing requirements of EN13384-1 for single appliances, and EN13384-2 for multi appliances.

Guarantee

LIFE EXPECTANCY AND GUARANTEE

We are confident in our products and so offer you (the owner) a generous guarantee in relation to the ICID Plus system (the System). Provided that you comply with the conditions stated below, the system will be free from defects for whichever is the greater of:

- a period equal to the guarantee period of the appliance to which the Liner is first connected; or
- 20 years.

The conditions of the guarantee are:

- Correctly sized and installed in accordance with the manufacturer's instructions, current Building Regulations and relevant British and European standards.
- Maintained correctly by a qualified and competent person and maintenance records kept updated for both appliance and chimney/chimney liner.
- Used in combination with an appliance burning only approved fuels in accordance with Schiedel Chimney Systems and the appliance manufacturer's instructions.
- Register your product within 30 days of installation at www.schiedel.com/uk and provide us with any evidence we reasonably request to prove that your System has been fitted by a HETAS approved installer or if not, has been signed off by a Building Control Inspector prior to use.

- Familiarise yourself with the installation instructions and comply with its provisions in full during the lifetime of your usage of the product (including by keeping the required records safe). Failure to do so will invalidate any guarantee claim.

For more details about the guarantee visit our website.

For recommended fuels listings, please refer to the HETAS Guide www.hetas.co.uk

In the event of a fault developing in the product due to defective materials or faulty manufacture Schiedel Chimney Systems undertake to replace the product only. Schiedel Chimney Systems cannot accept liability nor take any responsibility for the installation, building or redecorating costs or any other consequential losses arising. If any complaint is found to be a result of faulty installation, non-compliance with or abuse contrary to these conditions, the cost of site investigation is chargeable.

Schiedel Installer Rewards

Exciting news from Schiedel Chimney Systems for Stove and Chimney Installers! Whenever you register an installation with our easy to use, online guarantee registration portal, you will now accrue points based on the number of installations and installation type.

Once you have reached a minimum of 25 points, you can begin to redeem them for £25 Love2Shop vouchers.

So head on over to the portal and start to register your installations to take full advantage of our Lifetime Guarantee on ICID, and also to start earning points!





Download the **Augmented Reality Chimney Builder**, which allows you to see a stove within a room and generate a quote on your mobile device

SCHIEDEL

Schiedel Chimney Systems
Crowther Estate
Washington
Tyne & Wear NE38 0AQ
Tel. +44 (0)191 416 1150
Fax. +44 (0)191 415 1263

sales.uk@schiedel.com

SCHIEDEL INSTALLER REWARDS

Exciting news from Schiedel Chimney Systems! Whenever you register an installation with our easy to use, online guarantee registration portal, you will now accrue points based on the number of installations and installation type to redeem for Love2Shop vouchers!



Follow us on Social Media @SchiedelUK



A **stañdard**
INDUSTRIES COMPANY