

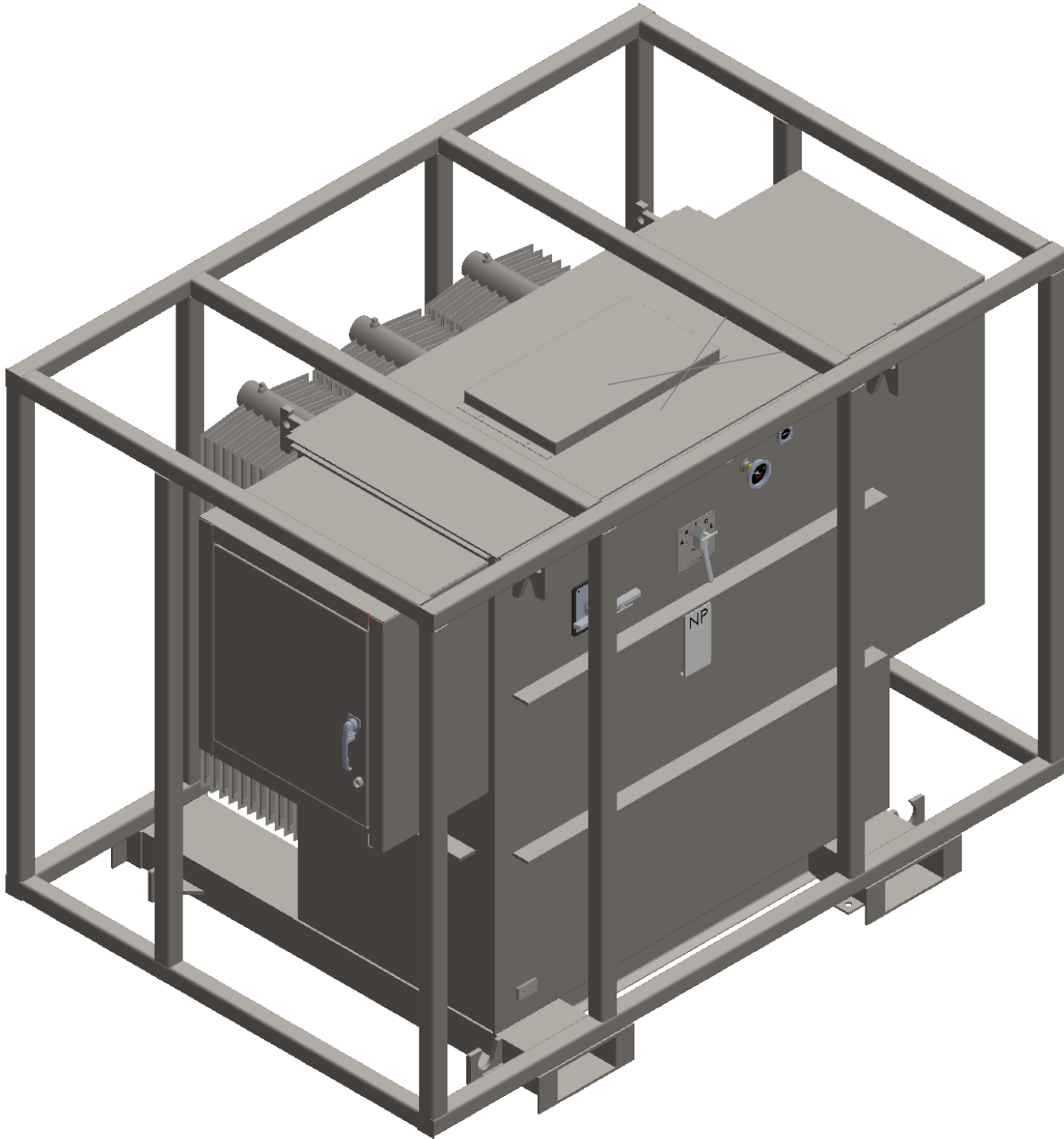

**HIGH TO LOW**  
**RENTALS**

(866) 840 7634 | 8075 Pontiac Street Commerce City, CO 80022



**TRANSFORMER DESCRIPTION: SUBSTATION TRANSFORMER 3 PHASE MINERAL OIL FILLED ONAN 65°C RISE 60 HZ**

**1 EA 5000 kVA-2400 DELTA X 4160Y/2400 X 7200 DELTA X 12470Y/7200-480Y/277 X 480Y/277  
WITH TAPS AT 8320-7970-7620-7200-6928-14400Y-13800Y-13200Y-12470Y-12000Y**

**DIMENSIONS**  
120 X 120

**TRANS.IZ: 5.75%**  
95 kV-B.I.L.

**TOTAL WEIGHT**  
19,000 LBS

**GAL. OIL**  
780