

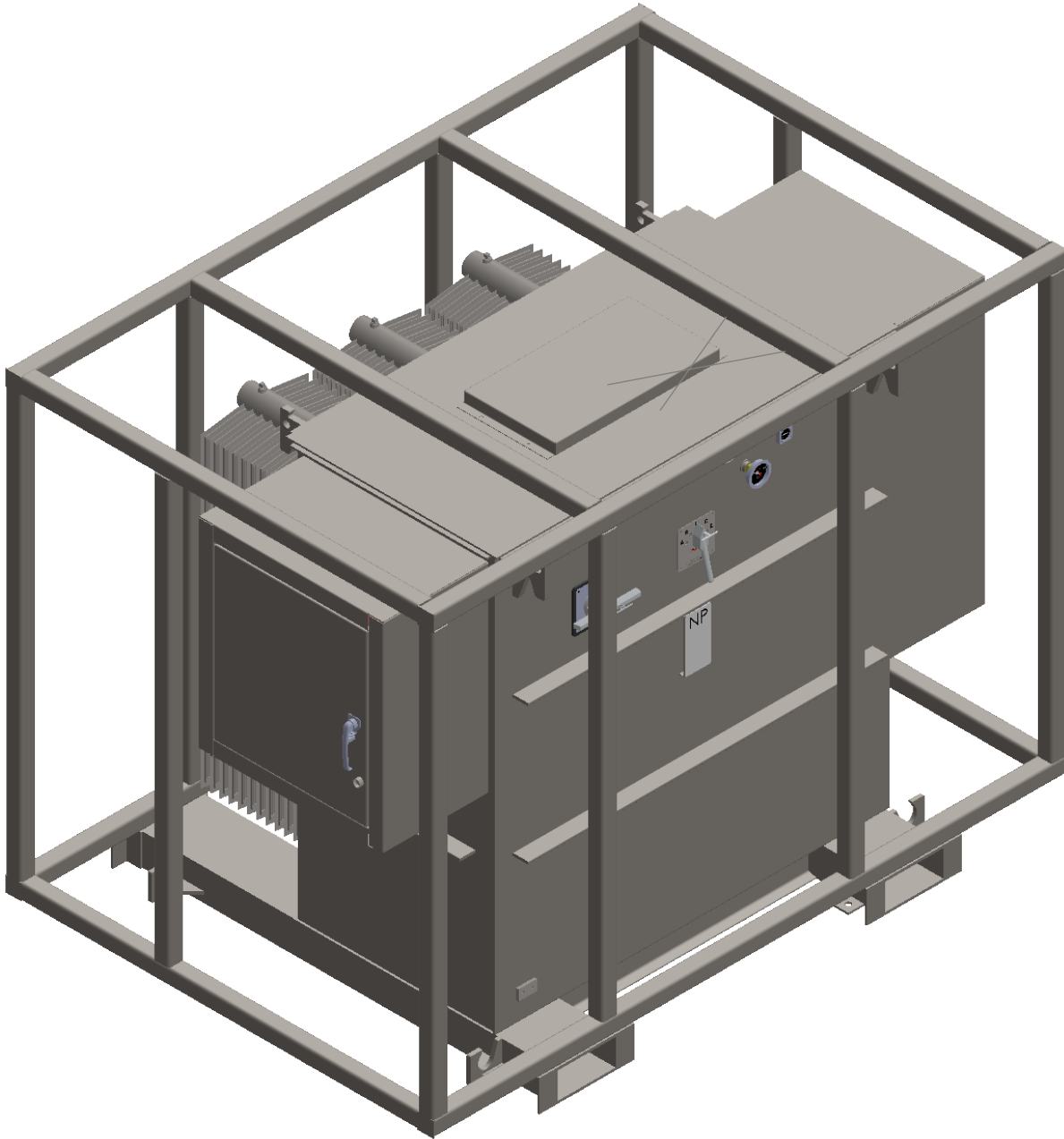

HIGH TO LOW
RENTALS

(866) 840 7634 | 8075 Pontiac Street Commerce City, CO 80022



TRANSFORMER DESCRIPTION: SUBSTATION TRANSFORMER 3 PHASE MINERAL OIL FILLED ONAN 65°C RISE 60 HZ

1 EA 4000 kVA-600Y/347-480Y/277

DIMENSIONS
120 X 120

TRANS.IZ: 5.75%
95 kV-B.I.L.

TOTAL WEIGHT
19,000 LBS

GAL. OIL
780