

QUICK EASY DONE.

For over 50 years, our team has been designing, manufacturing, and delivering the best stage and seating equipment the industry has to offer. Headquartered in Las Vegas, Nevada, our team can quickly support regional rentals throughout Arizona, California, and Nevada. We're ready to help make your next venue great!

STAGES

PORTABLE STAGE KITS (PAGES 4-6)
CROWD CONTROL (PAGE 8)
STAGE COMPONENTS (PAGES 9-10)
STAIRS & ADA RAMPS (PAGE 11)
STAGE CARTS (PAGES 13-14)

REVOLVES

REVOLVING STAGES (PAGES 16-18)

TRUSS

BOX TRUSS (PAGES 21-26)
TRUSS COMPONENTS (PAGE 28)
CIRCLE TRUSS (PAGES 30-33)

INFO

ADDITIONAL INFO (PAGES 35-36)



Portable Stage Kits



STAGE



24' x 12' x 2'-3' STAGE KIT



DESCRIPTION

Our 24' x 12' Portable Stage Kit is a popular configuration for smaller events or where space is the primary limiting factor. As with all of our Stage Kits, this model offers modular design flexibility and rapid deployment with a minimal crew.

IDEAL FOR

- Speaker Conference
- Public Speaking Events
- Small 5-piece band

INCLUDES

- Four 4' x 8' variable-height FastFold Frames
- Nine 4' x 8' stage platforms (stage decks)
- One variable-height stair with stair handrails
- Locator plates and hardware
- Stage guardrail and ADA ramp available by request





VIEW ONLINE

DOWNLOADS

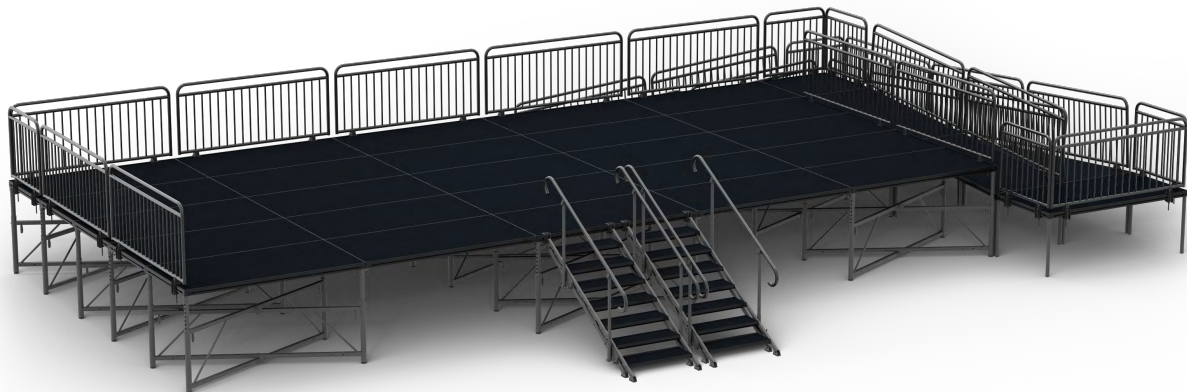

40' x 20' x 3'-5' STAGE KIT



DESCRIPTION

Our 40' x 20' Portable Stage Kit strikes the perfect balance between smaller and larger event requirements. As with all of our Stage Kits, this model offers modular design flexibility and rapid deployment with a minimal crew.

IDEAL FOR

- Corporate Event
- Festival Side Stage
- Small Concert in the Park

INCLUDES

- Nine 4' x 8' variable-height FastFold Frames
- Twenty-five 4' x 8' stage platforms (stage decks)
- Two variable-height stairs with stair handrails
- Locator plates and hardware
- Stage guardrail and ADA ramp available by request





VIEW ONLINE

DOWNLOADS

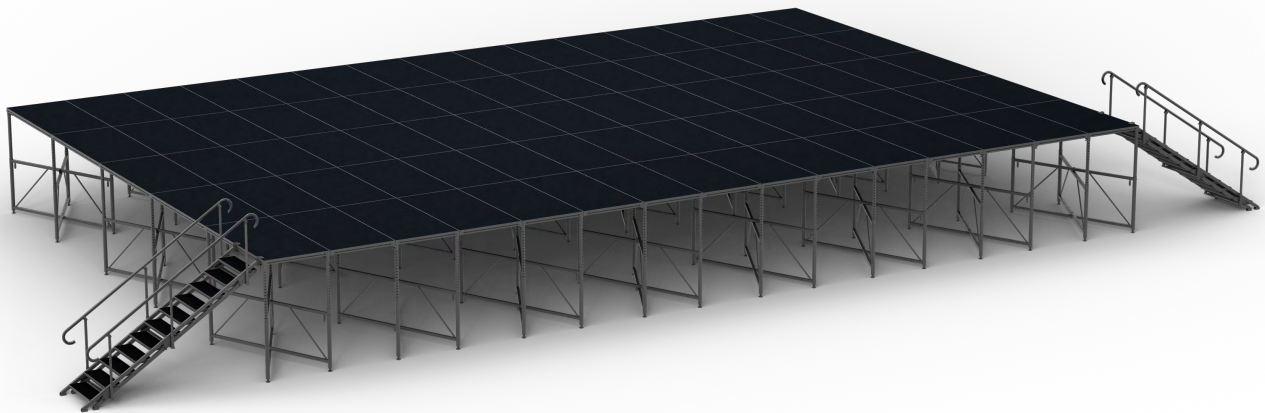

60' x 40' x 4' - 7' STAGE KIT



DESCRIPTION

Our 60' x 40' Portable Stage Kit provides maximum real estate coverage for larger events requiring more space. As with all of our Stage Kits, this model offers modular design flexibility and rapid deployment with a minimal crew.

IDEAL FOR

- Main Stage
- Concert Venue
- Awards Events

INCLUDES

- Twenty-four 4' x 8' variable-height FastFold Frames
- Seventy-five 4' x 8' stage platforms (stage decks)
- Two variable-height stairs with stair handrails
- Locator plates and hardware
- Stage guardrail and ADA ramp available by request



VIEW ONLINE



DOWNLOADS



Stage Components



MORE



CROWD CONTROL



BARRICADES (SKU: SCBC480S)

Smartstage forward-facing aluminum barricades are sleek, rugged, and comfortable to grip. They line up end-to-end for maximum coverage, fold for easy transport / storage, and have a built-in security step for crowd management.

FEATURES

- Designed for rapid, two-person folding setup
- Interlocking mechanism seamlessly links lineups
- Designed with large grips for safety and comfort
- Integrated step for quick crowd management
- Constructed of strong, yet light Aluminum
- Folds for easy transport and storage



CORNER BARRICADES (SKU: SCBC90CB)

Smartstage aluminum corner barricades are constructed of the same rugged material that makes the standard (forward-facing) barricade popular for events, and interlocks snugly with the forward-facing barricades to create a corner.

FEATURES

- Designed for rapid, two-person folding setup
- Interlocking mechanism seamlessly links lineups
- Designed with large grips for safety and comfort
- Integrated step for quick crowd management
- Constructed of strong, yet light Aluminum
- Folds for easy transport and storage

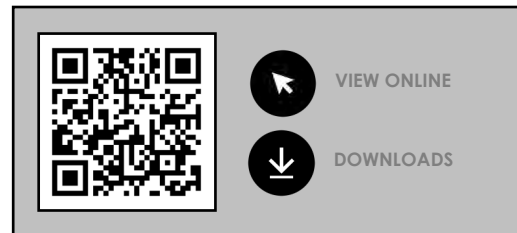
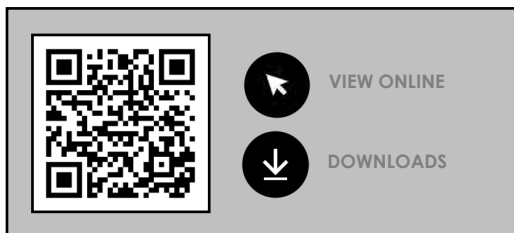

STAGE COMPONENTS



STAGE DECKS (SKU: STD4X8HB)

Designed to be strong and light, our stage decks offer fast, modular configuration without tools and with minimum crew. Featuring sleek, anti-slip Hexigrip laminate coating, Smartstage decks are ready to rock and roll.

FEATURES

- Available in 3'x4' / 3'x8' / 4'x4' / 4'x8'
- Engineered for max load / min carry weight
- Designed for indoor and outdoor events
- Black, anti-slip laminate Hexigrip surface
- Exceeds industry standards of 125 psf
- Changes configuration easily without tools



FASTFOLD FRAMES (SKU: STF4810X)

Smartstage FastFold Frames offer the freedom to build your stage up at any height, in any direction, and over any terrain with a finite leveling foot. They are simple and quick to use - requiring only one person to assemble a frame.

FEATURES

- Available in 2'-3' / 3'-5' / 4'7' (4'x'8' spread)
- Variable-height legs lock in place every 2"
- Folding design for easy storage and quick assembly
- Can install over uneven terrain and bridge obstacles
- Weather-resistant for indoor / outdoor applications
- Load-tested to support 6,600 lbs

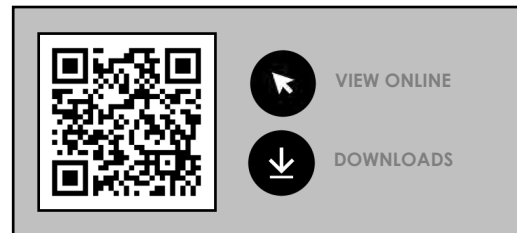
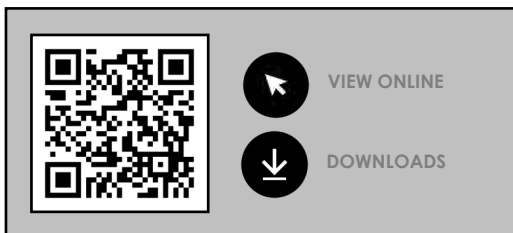

STAGE COMPONENTS



STAGE SKIRTING (SKU: STSKXXXX)

Our flame-resistant black velour skirting is designed to hide the understructure of multi-level stages and adheres quickly with the attached Velcro stripping. Made from thick, light-absorbing material, focus is always highlighted upward.

FEATURES

- Available in multiple standard heights / lengths
- Beautiful, light-absorbing black material
- Thick, durable fabric for outdoor conditions
- Designed smart for Smartstage / most other stages
- Built-in hidden Velcro stripping for fast assembly
- Flame-resistant (FR / IFR) to meet most fire codes





STAGE GUARDRAILS (SKU: STGRXXXX)

Our stage guardrails help keep performers and guests safe while providing a sleek and comfortable design. Smartstage guardrails quickly and easily adjust to all Smartstage decks as well as most other decks.

FEATURES

- Available in 3' / 4' / 8' lengths at 42" height
- Clean radius design with large, comfortable grip
- Secures quickly with proprietary Smartclamp
- Black surface keeps stairs hidden from house
- Clamps to all Smartstage and other standard decks
- Specialized storage / transport carts available





VIEW ONLINE

DOWNLOADS



VIEW ONLINE

DOWNLOADS



STAIRS & ADA RAMPS



STAGE STAIRS (SKU: STSTXXXX)

Smartstage stage stairs automatically adjust to meet a wide range of stage heights while keeping treads horizontal at all times, firmly gripping terrain with specialized feet, providing sturdy yet flexible configurations.

FEATURES

- Available in 2'-3' / 3'-5' / 4' - 7' variable heights
- Single and double step fixed height also available
- Outdoor weather-resistant
- Hexigrip tread surface for maximum traction
- Collapses for easy folding, transport, and storage
- Can be installed on uneven terrain



ADA STAGE RAMPS (SKU: HARPST4B)

Smartstage loading / ADA ramps are supremely modular, offering the freedom to build at any height, in any direction, and over uneven terrain. Compact for storage and shipping, light for easy loading, and quick and easy assembly.

FEATURES

- Layout and height can be adjusted
- Includes four 4' x 8' black Hexigrip decks
- Includes two variable-height FastFold Frames
- Includes eight 8' x 3' guardrails
- Includes single legs, nodes, and clamps
- Optional stairs with handrails available

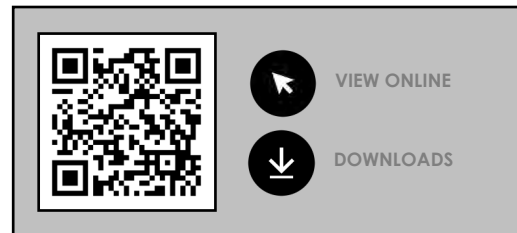
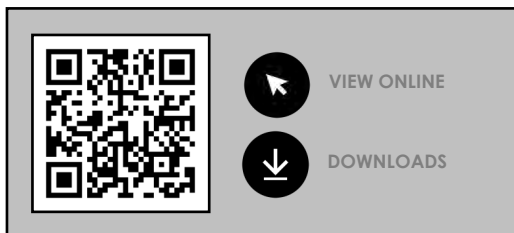

Product Highlight



SCENIC / CREATIVE / DECOR

Smartstage has an array of custom scenic / creative décor solutions for your next event - such as our Smartstage HighBoy tabletop featured here... a perfect addition for indoor / outdoor networking and social events). Just another reason to connect with your Smartstage logistics team!



STAGE CARTS



MINI BIG CART (SKU: TSCTCM0B)

Big things do come in small packages and our Mini Big Cart delivers. Designed to handle most Smartstage (and other manufacturer) products, the Mini Mig Cart provides smooth transport for large stage hardware through tight corridors.

FEATURES

- Large carrying capacity (ideal for 9 stage decks)
- Heavy load capacity (up to 2,400 lbs)
- Large durable swivel casters for smooth transport
- Soft, non-marking, skid-resistant wheels
- Latching foot brakes to secure cart in position
- Constructed of solid tubular steel



TOURING CART (SKU: 12345678)

The best engineering often comes in simple designs. Our Smartstage Touring Cart was designed for rapid in and out setup / breakdown for the maximum type of stage hardware and by the minimum number of crew.

FEATURES

- Designed to move stage hardware as a kit
- Large durable swivel casters for easy rolling
- Engineered for hand rolling or forklift transport
- Able to roll on truck and stage ramps
- Convenient under stage storage
- Baked on rugged black finish

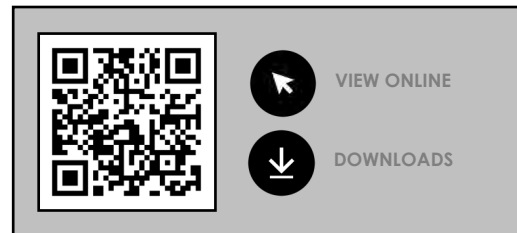
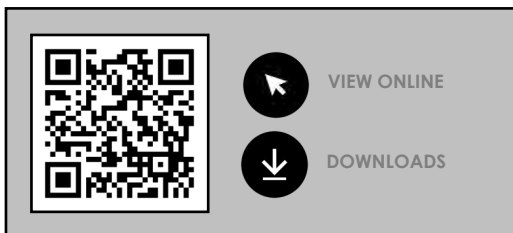

STAGE CARTS



TRUSS DOLLY (SKU: 12345678)

Successful events and touring venues require rapid, nimble movement of heavy stage gear like truss and other bulky, heavy-load items. Our trusty touring cart helps move large, heavy items through often tight corridors and stage ramps.

FEATURES

- Specifically engineered for box truss of all sizes
- Swiveling casters for easy navigation in tight spaces
- Low profile for convenient under-stage storage
- Engineered for hand rolling or forklift transport
- Able to roll on truck and stage ramps
- Heavy-duty construction for indoor / outdoor use



BARRICADE CART (SKU: 12345678)

Smartstage Barricade Carts are specially-built transport carts for our folding aluminum crowd control barricades and corner barricades. Each cart holds up to 12 barricade sections and are designed to offload product from all four sides.

FEATURES

- Holds up to 12 barricade sections
- Carts accessible from all four side
- Truck-ramp-ready locking casters for quick loading
- Low profile for convenient under-stage storage
- Designed to be pushed and forklifted
- Constructed of light yet strong aluminum 6061 alloy

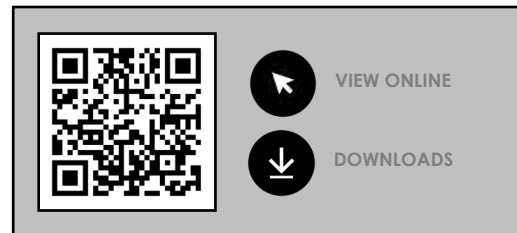
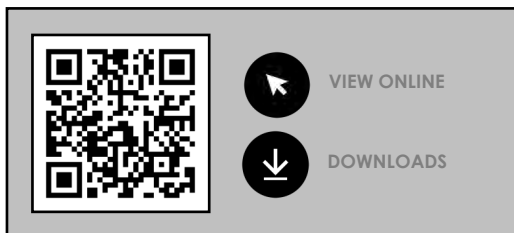

Revolving Stages



REVOLVES



1.5M REVOLVE



1.5M TURNTABLE (SKU: RV15MHDB)

Our small, yet robust 5ft display is perfect for single-person performers and smaller product demos that still require a heavy-duty, road-ready display platform that will securely and safely carry a heavy load.

FEATURES

- Low-profile with solid load capacity
- All-in-one unit for rapid deployment
- Quick and easy storage / transport
- Self-contained drive unit
- 3-prong power cable
- Wireless infrared remote
- Variable speed / reversing drive

SPECIFICATIONS

- Size: 4' 11" (1.5 m)
- Height: 5.96" (15 cm)
- Gross spread load: 2,000 lbs (907.19 kg)
- Load per square foot: 175 lbs (80 kg)
- Surface: Plywood with black, anti-slip surface

INTERNAL CONSTRUCTION

[VIEW ONLINE](#)

[DOWNLOADS](#)

3M REVOLVE



3M TURNTABLE (SKU: RV3MHD0B)

Our mid-sized, heavy-duty 9ft display is perfect for large revolving product displays working in tight exhibit real estate. The 3 meter revolve provides a smooth, consistent ride controlled locally or via a wireless remote.

FEATURES

- Low-profile with solid load capacity
- All-in-one unit for rapid deployment
- Quick and easy storage / transport
- Self-contained drive unit
- 3-prong power cable
- Wireless infrared remote
- Variable speed / reversing drive

SPECIFICATIONS

- Size: 9' 10" (3 m)
- Height: 11.42" (29 cm)
- Gross spread load: 6,600 lbs (2,993 kg)
- Load per square foot: 1,500 lbs (680 kg)
- Surface: Plywood with black, anti-slip surface

INTERNAL CONSTRUCTION

[VIEW ONLINE](#)

[DOWNLOADS](#)

6M REVOLVE



6M TURNTABLE (SKU: RV6MHD0B)

When it comes to the perfect exhibit, calculating the ideal stage space is key. This 19 foot revolving stage allows for more larger showcase space while still keeping the overall real estate in check.

FEATURES

- Low-profile with solid load capacity
- All-in-one unit for rapid deployment
- Quick and easy storage / transport
- Self-contained drive unit
- 3-prong power cable
- Wireless infrared remote
- Variable speed / reversing drive

SPECIFICATIONS

- Size: 19' 8" (6 m)
- Height: 11.42" (29 cm)
- Gross spread load: 6,600 lbs (2,993 kg)
- Load per square foot: 1,500 lbs (680 kg)
- Surface: Plywood with black, anti-slip surface

INTERNAL CONSTRUCTION



VIEW ONLINE



DOWNLOADS



Product Highlight



WIRELESS REMOTE

Our larger, heavy-duty revolves offer not only unique showcasing opportunities and new audience experiences, but also smooth, wireless remote control with advanced, programmable position presets. These along with included surface-mount power and DMX / RJX cabling connection options mean that your team remains in complete control of your audience experience. Ask about our wireless remote options (included in our 6 meter revolve package).

Box / Lighting Truss

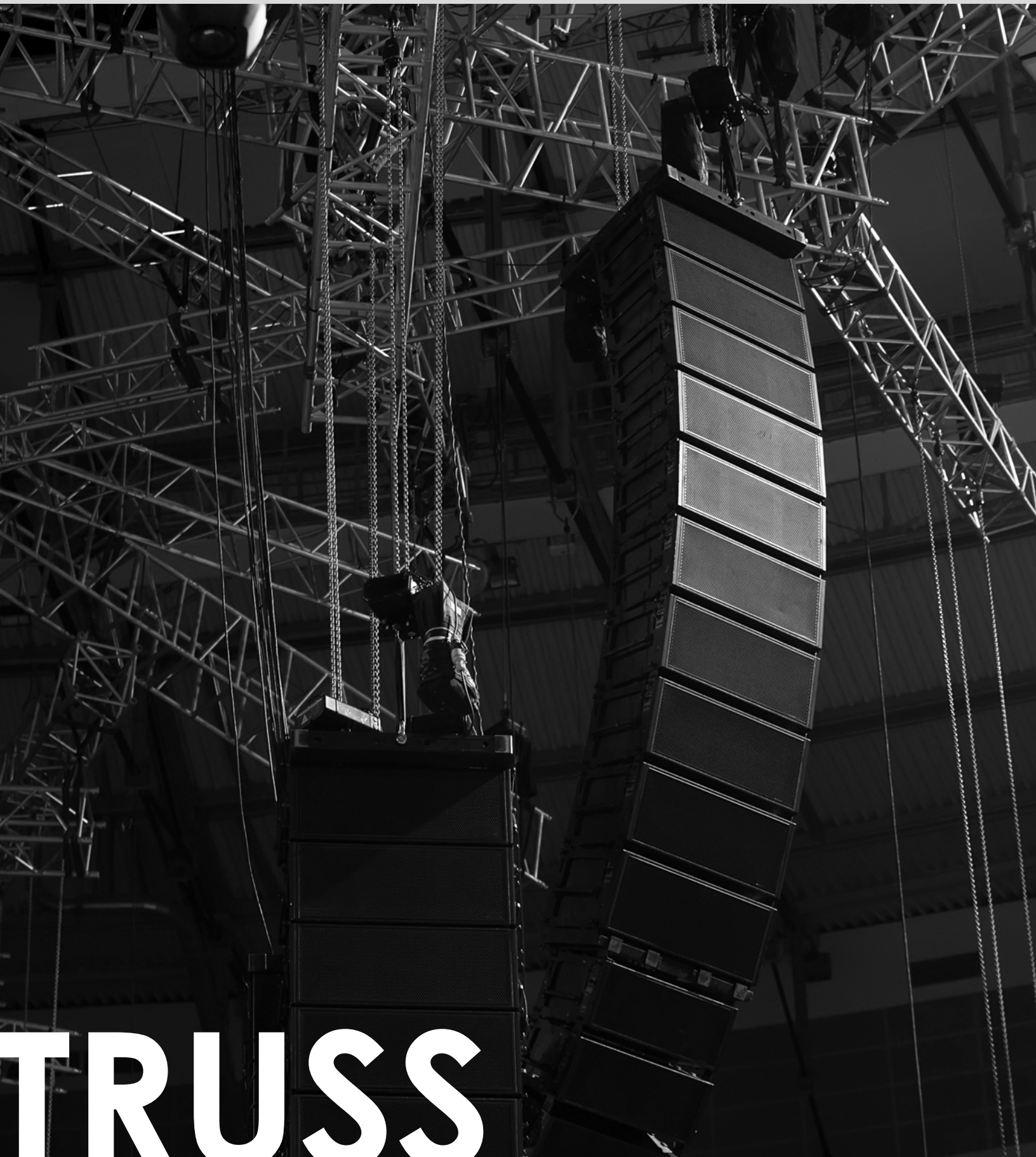

TRUSS



12" TRUSS



12" CORNERBLOCK (SKU: TRB12CBS)

Our 12" aluminum truss cornerblocks bolt together with ease while holding your stage structures firm. This 12" model allows for unique structures in just about any direction for all Smartstage 12" truss and most industry 12" truss.

FEATURES

- High load capacity 6061 T6 alloy Aluminum
- Life dependable welds
- 2" main chord 1" diagonals
- Fits all Smartstage 12" truss and most other brands
- TUV – SGS Certified with years of proven durability
- Load tested and inspected



12" x 12" TRUSS (SKU: TRB12XXS)

Our 12" aluminum truss bolts together with ease while holding your stage structures firm. Available in 1'-10' segments, our 12" truss connects with all Smartstage 12" truss as well as most industry-standard 12" truss.

FEATURES

- High load capacity 6061 T6 alloy Aluminum
- Life dependable welds
- 2" main chord 1" diagonals
- Fits all Smartstage 12" truss and most other brands
- TUV – SGS Certified with years of proven durability
- Load tested and inspected

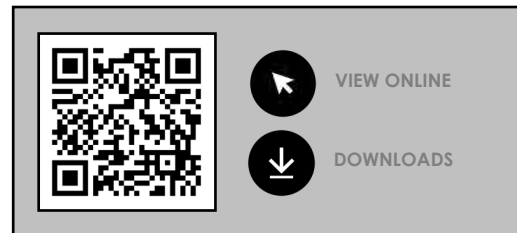
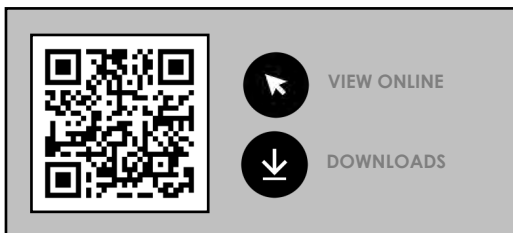

16" TRUSS

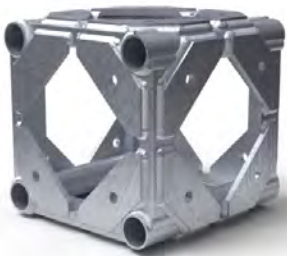

16" CORNERBLOCK (SKU: TRB16CBB)

Our 16" aluminum truss cornerblocks bolt together with ease while holding your stage structures firm. This 16" model allows for unique structures in just about any direction for all Smartstage 16" truss and most industry 16" truss.

FEATURES

- High load capacity 6061 T6 alloy Aluminum
- Life dependable welds
- 2" main chord 1" diagonals
- Fits all Smartstage 16" truss and most other brands
- TUV – SGS Certified with years of proven durability
- Load tested and inspected



16" x 16" TRUSS (SKU: TRB16XXS)

Our 16" aluminum truss bolts together with ease while holding your stage structures firm. Available in 14"-10' segments, our 16" truss connects with all Smartstage 16" truss as well as most industry-standard 16" truss.

FEATURES

- High load capacity 6061 T6 alloy Aluminum
- Life dependable welds
- 2" main chord 1" diagonals
- Fits all Smartstage 16" truss and most other brands
- TUV – SGS Certified with years of proven durability
- Load tested and inspected

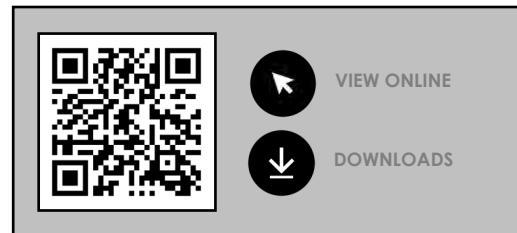
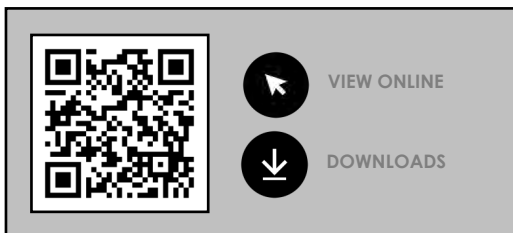

20.5" TRUSS

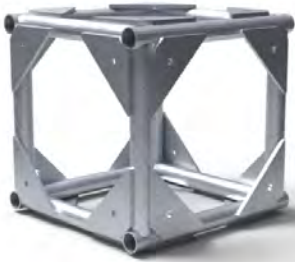

20.5" CORNERBLOCK (SKU: TRB20CBS)

Our 20.5" aluminum truss cornerblocks bolt together with ease while holding your stage structures firm. This 20.5" model allows for unique structures in just about any direction for all Smartstage 20.5" truss and most industry 20.5" truss.

FEATURES

- High load capacity 6061 T6 alloy Aluminum
- Life dependable welds
- 2" main chord 1" diagonals
- Fits all Smartstage 20.5" truss and most other brands
- TUV – SGS Certified with years of proven durability
- Load tested and inspected



20.5 x 20.5" TRUSS (SKU: TRB20XXS)

Our 20.5" aluminum truss bolts together with ease while holding your stage structures firm. Available in 2'-10' segments, our 20.5" truss connects with all Smartstage 20.5" truss as well as most industry-standard 20.5" truss.

FEATURES

- High load capacity 6061 T6 alloy Aluminum
- Life dependable welds
- 2" main chord 1" diagonals
- Fits all Smartstage 20.5" truss and most other brands
- TUV – SGS Certified with years of proven durability
- Load tested and inspected

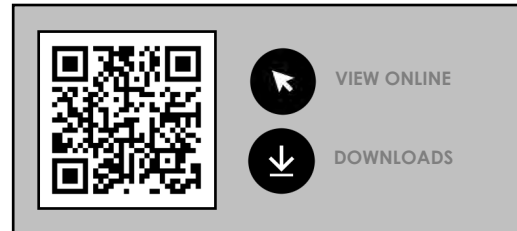
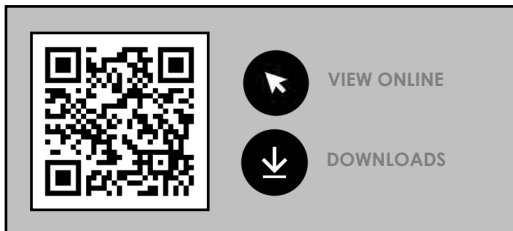

Truss Load Data

12" TRUSS LOAD DATA

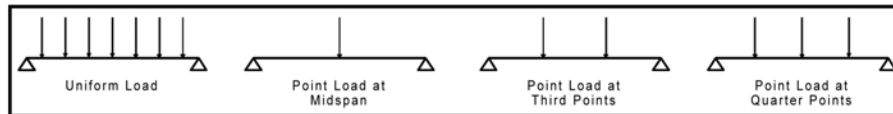

No. of Sections	Span ^{1, 8} (ft)	Uniform Load ²		Maximum Allowable Point Loads ^{3, 4, 6}						
				Center Point		Third Point		Quarter Point		
		Load (plf)	Total Load (lbs)	Deflection (in)	Load (lbs)	Deflection (in)	Load (lbs)	Deflection (in)	Load (lbs)	Deflection (in)
1	8	420	3360	0.12	845 ⁵	0.04	2 x 500 ⁵	0.02	3 x 360 ⁵	0.07
2	16	105	1680	0.49	845	0.32	2 x 500	0.10	3 x 360	0.47
3	24	47	1128	0.60	560	0.56	2 x 420	0.54	3 x 240	0.59
4	32	25	800	0.72	420	0.70	2 x 300	0.70	3 x 180	0.67
5	40	12	480	0.80	250	0.90	2 x 150	0.86	3 x 100	0.85

- 1) Span indicates distance between truss supports.
- 2) Max uniformly distributed load that may be supported by a single horizontal 2" pipe is 270 plf. Uniform load shall be distributed equally to bottom chord and/or top chord members to the greatest extent possible.
- 3) Max single concentrated point load that may be supported by a single horizontal 2" pipe is 500 lbs.
- 4) Concentrated loads shall be hung from chord members only. Each concentrated load shall have two or four truss support points, equally distributed over both bottom chords.
- 5) Allowable concentrated point loads for 8'-0" span truss may be doubled provided the load is hung from 4 unique support points equally distributed over both bottom chords.
- 6) For point loads at intervals not indicated, use equivalent uniform load to determine capacity.
- 7) Truss sections shall be spliced together using (4) 5/8" diameter grade 8 thru bolts or a Truss Corner Block with (8) 5/8" diameter grade 8 thru bolts. The 22.5, 30, and 45 degree truss corner blocks shall be located no more than 8'-0" from a support point on both sides.
- 8) Truss lengths of 1'-0", 2'-0", 3'-0", 4'-0" and 6'-0" have a load rating equal to the 8'-0" truss span, and are subject to the uniform and concentrated loading restrictions of footnotes 2, 3, 4 and 5.
- 9) Capacity of additional support structures, components or connections are outside the scope of this analysis.



Truss Load Data

16" TRUSS LOAD DATA

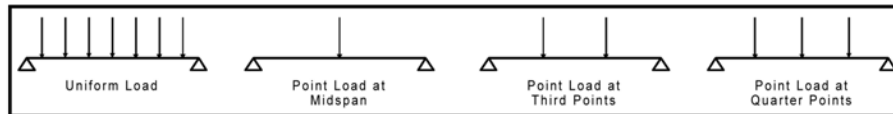

Number of Sections	Span ¹ (ft)	Uniform Load ^{2, 3, 4, 6}		Maximum Allowable Point Loads ^{4, 5, 6}						
				Center Point			Third Point		Quarter Point	
				Load (plf)	Total Load (lbs)	Deflection (in)	Load (lbs)	Deflection (in)	Load (lbs)	Deflection (in)
1	8	820 bc	6560	0.14"	6400	0.21"	2 x 3300	0.21"	3 x 2200	0.21"
		770 tc	6160	0.14"						
2	16	240	3840	0.3"	1925	0.26"	2 x 1430	0.3"	3 x 960	0.3"
3	24	120	2880	0.6"	1800	0.77"	2 x 900	0.77"	3 x 725	0.77"
4	32	60	1920	1.1"	940	0.86"	2 x 700	1.1"	3 x 470	1.1"
5	40	40	1600	1.6"	900	1.64"	2 x 550	1.64"	3 x 400	1.64"
6	48	25	1200	2.26"	600	1.85"	2 x 450	2.26"	3 x 300	2.26"

- Span indicates distance between truss supports.
- Uniform loads shall be distributed evenly across both truss chords and can be applied to top or bottom chords.
- Values at single span truss labeled "bc" are for uniform loads applied to truss bottom chord. Values at single span truss labeled "tc" are for uniform loads applied to truss top chord.
- Maximum point load that may be applied to truss chords between panel points is 250 Lbs at each chord member simultaneously.
- For truss to support the loads indicated, point loads shall be hung from truss panel points only. Truss shall be oriented to ensure load is applied at panel points.
- For point loads at intervals not indicated, use equivalent uniform load to determine capacity.
- Loads shown require trusses to be connected at end supports to each chord member (i.e. 4 connections each end of truss).
- Capacity of additional support structures, components or connections are outside the scope of this analysis.



20.5" TRUSS LOAD DATA

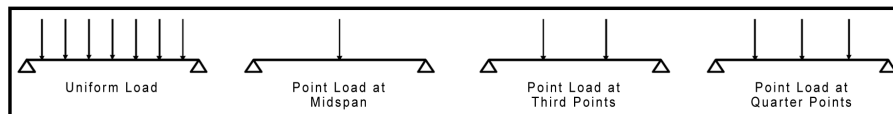

TRUSS SPAN	UNIFORMLY DISTRIBUTED LOAD		CENTER POINT LOAD		THIRD POINT LOAD		QUARTER POINT LOAD		FIFTH POINT LOAD	
	LOAD	DEFLECTION	LOAD	DEFLECTION	LOAD	DEFLECTION	LOAD	DEFLECTION	LOAD	DEFLECTION
8'-0"	714 lb/ft	0.126 in	3,081 lbs	0.082 in	2,168 lbs	0.101 in	1,496 lbs	0.100 in	1,309 lbs	0.104 in
16'-0"	179 lb/ft	0.336 in	1,488 lbs	0.325 in	1,084 lbs	0.338 in	723 lbs	0.333 in	595 lbs	0.330 in
24'-0"	85 lb/ft	0.702 in	1,296 lbs	0.700 in	680 lbs	0.665 in	574 lbs	0.700 in	404 lbs	0.676 in
32'-0"	38 lb/ft	1.109 in	638 lbs	0.994 in	468 lbs	1.136 in	319 lbs	1.129 in	255 lbs	1.131 in
40'-0"	21 lb/ft	1.687 in	531 lbs	1.623 in	340 lbs	1.726 in	234 lbs	1.706 in	170 lbs	1.611 in
48'-0"	13 lb/ft	2.420 in	319 lbs	2.199 in	234 lbs	2.500 in	157 lbs	2.392 in	132 lbs	2.457 in

- Span indicates distance between truss supports.
- Max uniformly distributed load that may be supported by a single horizontal 2" pipe is 270 plf. Uniform load shall be distributed equally to bottom chord and/or top chord members to the greatest extent possible.
- Max single concentrated point load that may be supported by a single horizontal 2" pipe is 500 lbs.
- Concentrated loads shall be hung from chord members only. Each concentrated load shall have two or four truss support points, equally distributed over both bottom chords.
- Allowable concentrated point loads for 8'-0" span truss may be doubled provided the load is hung from 4 unique support points equally distributed over both bottom chords.
- For point loads at intervals not indicated, use equivalent uniform load to determine capacity.
- Truss sections shall be spliced together using (4) 5/8" diameter grade 8 thru bolts or a Truss Corner Block with (8) 5/8" diameter grade 8 thru bolts. The 22.5, 30, and 45 degree truss corner blocks shall be located no more than 8'-0" from a support point on both sides.
- Truss lengths of 1'-0", 2'-0", 3'-0", 4'-0" and 6'-0" have a load rating equal to the 8'-0" truss span, and are subject to the uniform and concentrated loading restrictions of footnotes 2, 3, 4 and 5.
- Capacity of additional support structures, components or connections are outside the scope of this analysis.



RELIABLE
INNOVATIVE
BOLD.

We're not just a reseller, we're also the design and manufacturing team behind most of our staging hardware, including our lineup of box truss and truss accessories. Smartstage truss is well known for its innovative, reliable, and bold design, offering unique truss configurations that are not otherwise available to event planners.



TRUSS COMPONENTS



16" TRUSS FACEPLATE (SKU: TRB16FPS)

The 16" x 16" truss faceplate adapts most node / bolt truss connections, allowing 16" x 16" box truss of one standard to reliably connect with 16" x 16" box truss of another standard. Welded to TUV standards of 6061-T6 alloy, the truss faceplate is built to last.

FEATURES

- High load capacity 6061 T6 alloy Aluminum
- Life dependable welds
- 2" main chord 1" diagonals
- TUV – SGS Certified with years of proven durability
- Load tested and inspected



TRUSS HINGE (SKU: TRB12HPS)

The truss hinge is a game-changer when it comes to offering unique options for design configurations. Remember, you're not limited to 90 degree setups with the truss hinge and creating 45 degree or 15 degree truss connection points can open up all sorts of creative stage layouts.

FEATURES

- High load capacity 6061 T6 alloy Aluminum
- Life dependable welds
- 2" main chord 1" diagonals
- TUV – SGS Certified with years of proven durability
- Load tested and inspected

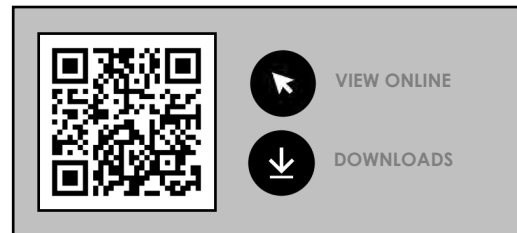
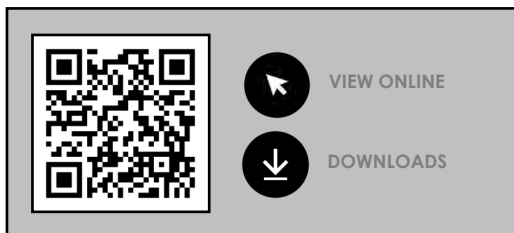

Product Highlight

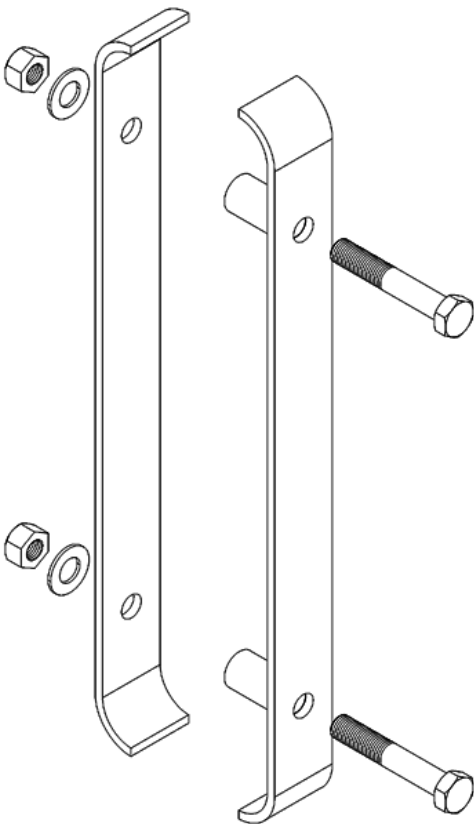
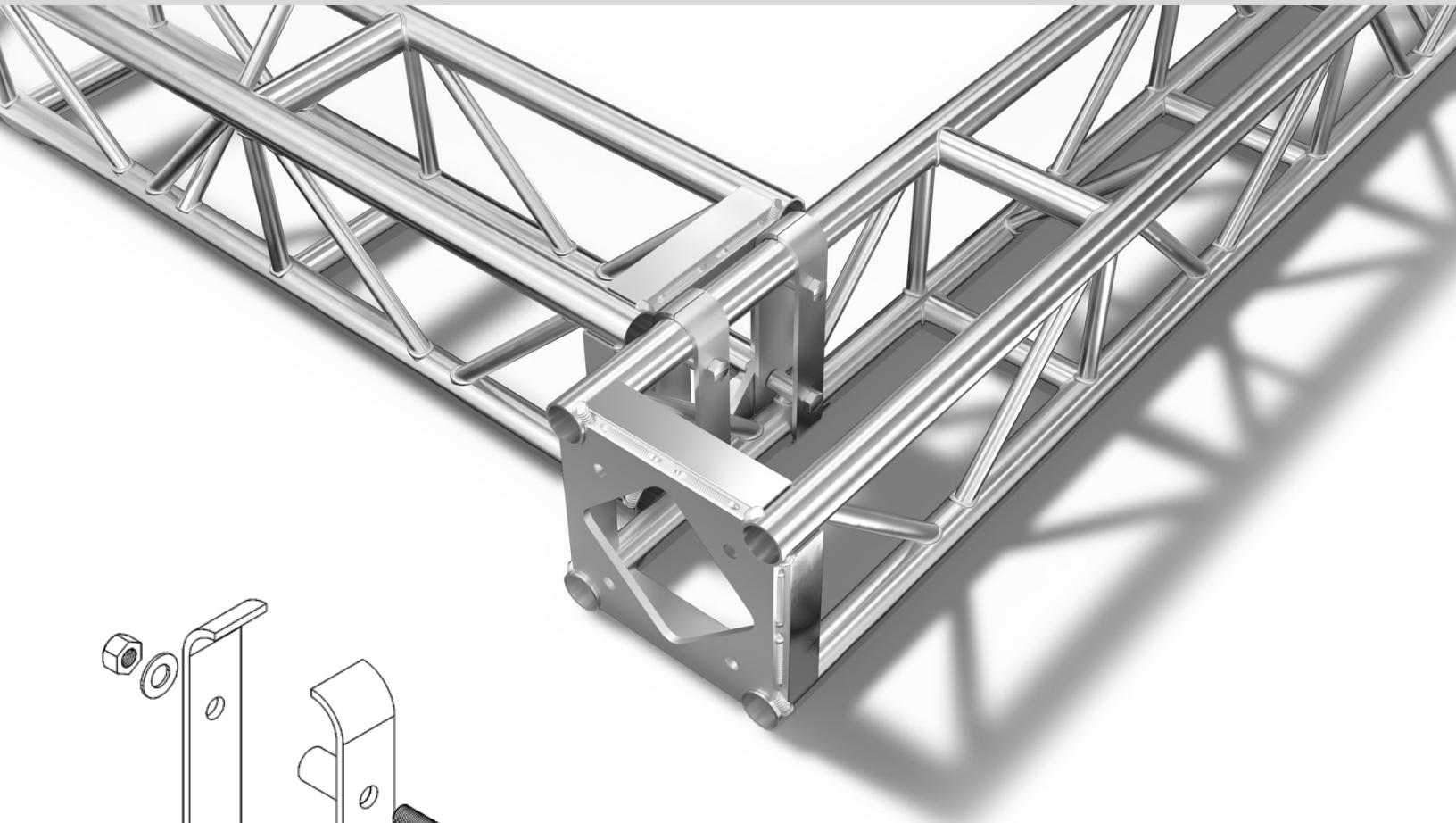

The Truss Grapple

Our proprietary Truss Grapple allows for unique truss design layouts. The low-profile design of our innovative hardware allows for new and interesting, mid-truss connections that nevertheless deliver 75% load capacity of the truss itself.

[VIEW ONLINE](#)
[DOWNLOADS](#)



Circle Truss

12" x 12' CIRCLE TRUSS



12" x 12" x 12' CIRCLE TRUSS (SKU: TRC1212S)

Smartstage circle truss combines the structural reliability of our standard box truss with the aesthetics of partial and full circle configurations. Our 12" circle truss fits all Smartstage 12" truss and most industry 12" truss.

FEATURES

- High load capacity 6061 T6 alloy Aluminum
- Life dependable welds
- 2" main chord 1" diagonals
- Fits all Smartstage 12" truss and most other brands
- TUV – SGS Certified with years of proven durability
- Load tested and inspected

INDIVIDUAL SEGMENTS

Our circle truss is made available in single segments that combine together to make half, semi, or full circles. While available individually, the Smartstage 12" x 12" x 12' circle requires four segments to make the complete 12' circle.



VIEW ONLINE



DOWNLOADS



Circle Truss

12" x 18' CIRCLE TRUSS



12" x 12" x 18' CIRCLE TRUSS (SKU: TRC1224S)

Smartstage circle truss combines the structural reliability of our standard box truss with the aesthetics of partial and full circle configurations. Our 12" circle truss fits all Smartstage 12" truss and most industry 12" truss.

FEATURES

- High load capacity 6061 T6 alloy Aluminum
- Life dependable welds
- 2" main chord 1" diagonals
- Fits all Smartstage 12" truss and most other brands
- TUV – SGS Certified with years of proven durability
- Load tested and inspected

INDIVIDUAL SEGMENTS

Our circle truss is made available in single segments that combine together to make half, semi, or full circles. While available individually, the Smartstage 12" x 12" x 18' circle requires six segments to make the complete 18' circle.



VIEW ONLINE



DOWNLOADS



Circle Truss

16" x 24' CIRCLE TRUSS



16" x 16" x 24' CIRCLE TRUSS (SKU: TRC1624S)

Smartstage circle truss combines the structural reliability of our standard box truss with the aesthetics of partial and full circle configurations. Our 16" circle truss fits all Smartstage 16" truss and most industry 16" truss.

FEATURES

- High load capacity 6061 T6 alloy Aluminum
- Life dependable welds
- 2" main chord 1" diagonals
- Fits all Smartstage 16" truss and most other brands
- TUV – SGS Certified with years of proven durability
- Load tested and inspected

INDIVIDUAL SEGMENTS

Our circle truss is made available in single segments that combine together to make half, semi, or full circles. While available individually, the Smartstage 16" x 16" x 24' circle requires eight segments to make the complete 24' circle.



VIEW ONLINE



DOWNLOADS

16" x 32' CIRCLE TRUSS



16" x 16" x 32' CIRCLE TRUSS (SKU: TRC1632S)

Smartstage circle truss combines the structural reliability of our standard box truss with the aesthetics of partial and full circle configurations. Our 16" circle truss fits all Smartstage 16" truss and most industry 16" truss.

FEATURES

- High load capacity 6061 T6 alloy Aluminum
- Life dependable welds
- 2" main chord 1" diagonals
- Fits all Smartstage 16" truss and most other brands
- TUV – SGS Certified with years of proven durability
- Load tested and inspected

INDIVIDUAL SEGMENTS

Our circle truss is made available in single segments that combine together to make half, semi, or full circles. While available individually, the Smartstage 16" x 16" x 32' circle requires twelve segments to make the complete 32' circle.





VIEW ONLINE

DOWNLOADS





RENTAL REGIONS



We support the Arizona, California, and Nevada region for staging rentals (which helps us keep a close eye on logistics support). However, we are a global brand and can deliver hardware nearly anywhere in the world. If your event is outside our rental region, we will still be able to support your event with purchasable items.

LET'S TALK GEAR.

You've got a lot on your plate, so let's get right to it and lock your gear down. With our stocked inventory of stage equipment already in the Las Vegas area (and quickly accessible to surrounding areas), we can make sure that your team has what they need. Contact our team today and let's make your event, tour, or venue great!

