

SKEMA

INDOOR K-UNO
PAVIMENTI TECNICI TECHNICAL FLOORING



SKEMA

Superfici da vivere, dal 1992
Living surfaces, since 1992

PAVIMENTI TECNICI TECHNICAL FLOORING

I pavimenti tecnici rappresentano, storicamente, il cuore della proposta di Skema e continuano a essere la scelta migliore in molti contesti per le loro caratteristiche tecniche e il loro realismo.

Ampia la scelta di decori, dall'effetto legno al materico, e di formati, dalla dogia al tile.

L'estetica è ricercata grazie al sincroporo, che riproduce fedelmente le venature del legno, e alla superficie opaca e altamente performante.

I pavimenti tecnici sono antistatici e compatibili con il riscaldamento a pavimento.

Technical flooring have historically been the core of Skema's offer and continue to be the best choice in many contexts for their technical characteristics and realistic appearance.

There is a wide choice of patterns, from wood effect to material, and of formats, from planks to tiles.

Aesthetics are sought after thanks to the syncropore technology, which faithfully reproduces the wood grain, and the matte, high-performance surface.

Technical floors are antistatic and compatible with underfloor heating.



“Una superficie che unisce tecnica ed estetica in un equilibrio naturale. La sintesi perfetta di solidità, durevolezza e forza espressiva.”

“A surface that blends technology and aesthetics in a natural balance. The perfect synthesis of strength, durability, and expressive character.”

Vision Technic

**L'estetica di acciaio e pietra
ispira ambienti innovativi
e contemporanei.**

The aesthetics of steel and
stone inspire innovative,
contemporary spaces.

Vision Technic è la collezione di pavimenti tecnici in formato tiles (857x398x8 mm) progettata per il mondo allestitivo, contract e office, dove praticità e resistenza devono convivere con un'estetica tecnica e contemporanea. I decori, ispirati all'acciaio e alla pietra naturale, offrono superfici moderne e versatili, perfette per ambienti dinamici e professionali. I suoi punti di forza sono la rapidità e sicurezza di posa garantite dal sistema di incastro, la disponibilità della finitura anche per pavimenti sopraelevati, la resistenza all'abrasione e al calpestio e la certificazione di resistenza al fuoco. Caratteristiche che lo rendono una soluzione affidabile e funzionale, in grado di rispondere alle esigenze specifiche degli spazi pubblici e di lavoro.

Vision Technic is the technical flooring tile collection (857x398x8 mm) designed for the exhibition, contract, and office sectors, where practicality and durability must coexist with a technical and contemporary aesthetic. The décors, inspired by steel and natural stone, create modern and versatile surfaces, perfect for dynamic and professional environments. Its strengths include quick and secure installation ensured by the locking system, availability of the finish also for raised floors, high resistance to abrasion and foot traffic, and certified fire resistance. These features make it a reliable and functional solution, able to meet the specific demands of public and workspaces.



Product

Vision Technic - Pietra d'Istria 208

ACCIAIO BRUNITO/ 205

stone

857x398x8 mm

PIETRA PORTOGHESE/ 206

stone

857x398x8 mm

Dati tecnici Technical data

STRATIGRAFIA/ STRATIGRAPHY

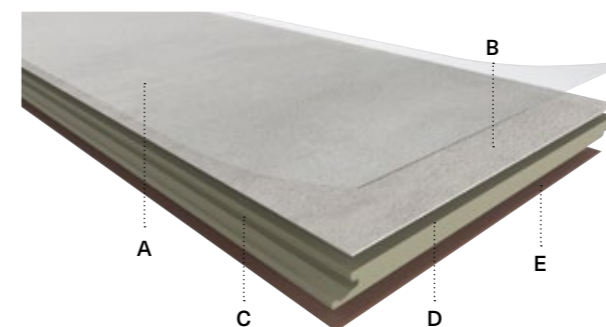









- A. Superficie High Wear**
High Wear surface
- B. Carta decorativa antistatica**
Antistatic decorative paper
- C. Strato intermedio HDF trattato**
Treated HDF intermediate layer
- D. Bordi trattati con Sigil joint**
Edges treated with Sigil joint
- E. Controilanciante**
Balancing layer

FORMATI/ FORMATS

Vision Technic
857×398×8 mm



CARATTERISTICHE TECNICHE/ TECHNICAL FEATURES

Incastro Joint		PLS	Umidità/ resistenza all'acqua Moisture/ water resistant		
Bisello Bevel		4V	Uso domestico Domestic use		23 Alto Traffico High Traffic
Reazione al fuoco* Fire reaction*		Cfl-s1	Uso commerciale Commercial use		32 Medio Traffico Medium Traffic
Riscaldamento a pavimento Radiant heating		T ≤ 27°C	Classe di abrasione Abrasion class		
Antistatico Antistatic					

* Classificazione valida con l'utilizzo dei sottopavimenti e/o modalità indicate da Skema S.p.A. (per dettagli vedi scheda tecnica del prodotto e/o istruzioni per l'installazione).
* Classification valid with the use of underlayer and/or modality specified by Skema S.p.A. (please see product technical data sheet and/or installation instructions for details).

ACCESSORI/ ACCESSORIES

Sottopavimenti Underlayer	Superior RBR, DB, ST
Profilo Profile	Kit dislivello, kit dilatazione, kit terminale Splice kit, expansion kit, terminal kit
Battiscopa Skirting board	Time trendy, Look trendy

SPECIFICHE E CONFORMITÀ/ SPECIFICATIONS AND COMPLIANCE



CONFEZIONAMENTO/ PACKAGING

Rif. formato/ Size	Pezzi Cfz/ Pieces Box	m ² Cfz/ Box	Cfz Pallet/ Box Pallet	m ² Pallet
857×398 mm	7	2,387	30	71,610

ACCESSORI
ACCESSORIES

Sottopavimenti Underlayers

SUPERIOR RBR



Alte performance; densità media 800 kg/m³; soddisfa lo standard EPLF; ottima resistenza meccanica CS a protezione dell'incastro; alta performance acustica IS per riduzione riverbero in stanza RWS; bassa resistenza termica TR, consigliato per posa su massetti radianti; barriera vapore integrata (PET/Alu); bassissima emissione VOC; posa lato PET/Alluminio verso l'alto.
High performance; average density 800 kg/m³; fulfils EPLF standards; excellent mechanical resistance CS to protect the joint; high acoustic performance IS for room reverberation reduction RWS; low thermal resistance TR, recommended for laying on radiant screeds; integrated vapour barrier (PET/Alu); very low VOC emission; PET/Alu side up laying.

Dimensioni
Size

Rotolo/ Roll 8x1 m
Sp. 2 mm | D 800 kg/mc

BARRIERA VAPORE BN MOISTURE BARRIER BN



Foglio in polietilene coestruso ultrasottile, con uno spessore di 10 micron. La funzione principale è creare una barriera antivapore, proteggendo il pavimento dall'umidità che potrebbe risalire dagli elementi costruttivi. È facile da posare e rappresenta una soluzione efficace per mantenere il pavimento asciutto e duraturo.
Ultra-thin co-extruded polyethylene sheet, 10 microns thick. Its main function is to act as a vapor barrier, isolating the floor and protecting it from moisture rising from adjacent structural elements. This product is easy to install, and provides an effective solution for keeping floors dry and long-lasting.

Dimensioni
Size

Rotolo/ Roll da 30 mq - 25x1,2 m
Sp.100 my | D 0,93g/cm³

Rotolo/ Roll da 60 mq - 50x1,2 m
Sp.100 my | D 0,93g/cm³

Rotolo/ Roll da 120 mq - 100x1,2 m
Sp.100 my | D 0,93g/cm³

DB

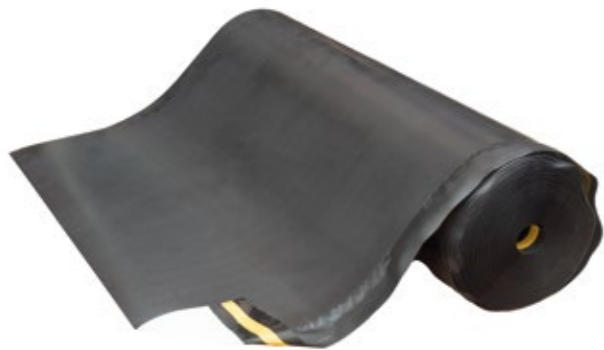

Costituito da schiuma poliolefinica a celle chiuse estrusa in modalità controllata; densità media 80kg/m³; soddisfa standard EPLF; resistenza meccanica CS; isolamento al rumore da calpestio IS; barriera vapore SD (PET) che evita diffusione di umidità di risalita, integrata con cimosa laterale dotata di nastro adesivo applicato per congiunzione materassini; senza CFC e HCFC, plastificanti e metalli pesanti; posa con lato nero con barriera vapore verso l'alto.
Consisting of closed-cell polyolefin foam extruded in a controlled mode; average density 80 kg/m³; fulfils EPLF standard; mechanical resistance CS; impact sound insulation IS; vapour barrier SD (PET) preventing diffusion of moisture, integrated with side selvage with adhesive tape applied for mattress connection; free of CFCs and HCFCs, plasticisers and heavy metals; laid with black side with vapour barrier facing upwards.

Dimensioni
Size

Rotolo/ Roll 25x1 m
Sp. 2 mm | D 80 kg/mc

ST



Costituito da schiuma poliolefinica a celle chiuse estrusa in modalità controllata; densità media 20kg/m³; soddisfa standard EPLF; resistenza meccanica CS; isolamento al rumore da calpestio IS; barriera vapore SD (PET/Alluminio) integrata che evita diffusione di umidità di risalita; senza CFC e HCFC, plastificanti e metalli pesanti; posare con lato metallizzato verso l'alto.
Consisting of closed-cell polyolefin foam extruded in a controlled manner; average density 20 kg/m³; meets EPLF standard; mechanical resistance CS; impact sound insulation IS; integrated SD vapour barrier (PET/Aluminium) that prevents the diffusion of rising damp; free of CFCs and HCFCs, plasticisers and heavy metals; lay with metallised side up.

Dimensioni
Size

Rotolo/ Roll 25x1 m
Sp. 2 mm | D 20 kg/mc

Rotolo/ Roll 150x1 m
Sp. 2 mm | D 20 kg/mc

Battiscopa Skirting boards

STAR



Battiscopa in HDF con proporzioni standard.
HDF skirting board with standard proportions.

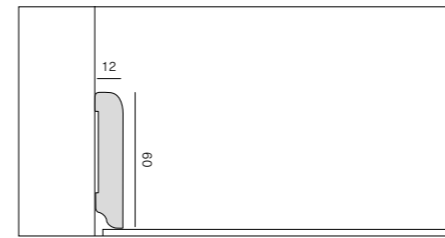

TIME



Battiscopa in HDF.
Skirting board made of HDF.

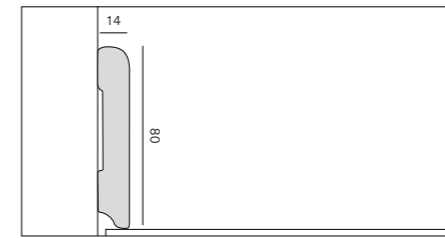

LOOK



Battiscopa in HDF con finitura poro.
Skirting board made of HDF with a pore finish.

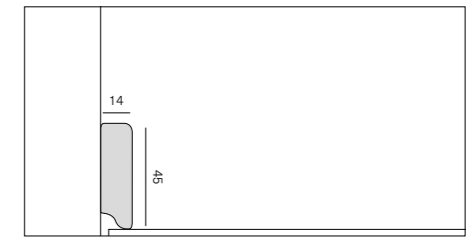

ABACO / RECAP

	STAR	TIME	LOOK
Abbinati Matching	Facile+	Prestige L Prestige Gold	Prestige L Prestige Gold Vision Technic
Abbinabili Combined	Syncro Parquet	Lumbertech	-
Tinta unita Solid colors	○ Bianco opaco/ Matt white	○ Bianco lucido/ Glossy white ○ Bianco opaco/ Matt white ○ Grigio chiaro/ Light grey ● Grigio medio/ Medium grey ● Grigio scuro/ Dark grey ● Nero opaco/ Matt black ● Carbonio/ Carbon ○ Beige ○ Avorio/ Ivory ● Metallo bronzo/ Bronze metal	● Alluminio/ Aluminum ○ Bianco lucido/ Glossy white ○ Bianco opaco/ Matt white ○ Grigio chiaro/ Light grey ● Grigio medio/ Medium grey ● Grigio scuro/ Dark grey ● Nero opaco/ Matt black ● Carbonio/ Carbon ○ Beige ○ Avorio/ Ivory ● Metallo bronzo/ Bronze metal
Dimensioni Size	h 60-2400x12 mm	h 80-2400x14 mm	h 45-2400x14 mm h 45-2200x14 mm

DROP

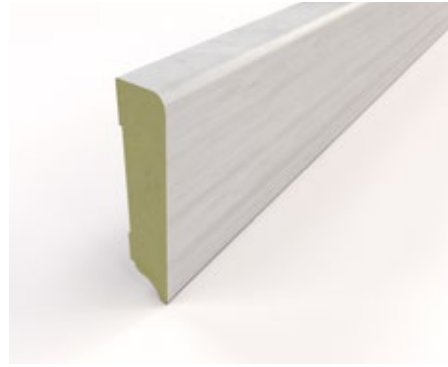

Battiscopa in HDF a bassa assorbenza con finiture poro. Con densità di 700 kg/m³ offre alta resistenza all'umidità.
HDF skirting board with low absorbency and a sealed finish. Its 700 kg/m³ density ensures high moisture resistance.

PVC ESPANSO

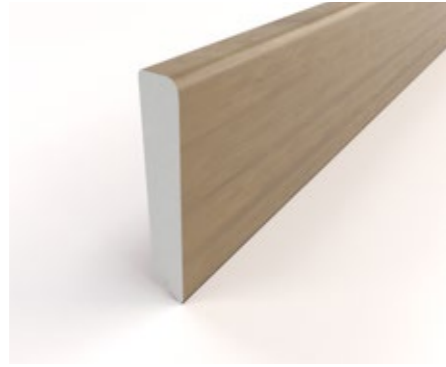

Battiscopa in PVC espanso resistente all'umidità.
Moisture-resistant expanded PVC skirting board.

F



Battiscopa realizzato con sistema folding utilizzando le relative doghe del pavimento.
Skirting board made with a folding system using the matching floor planks.

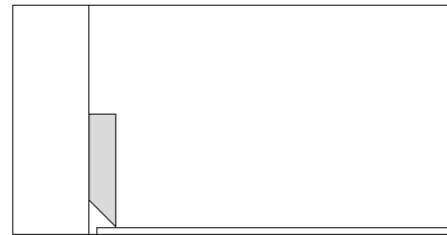
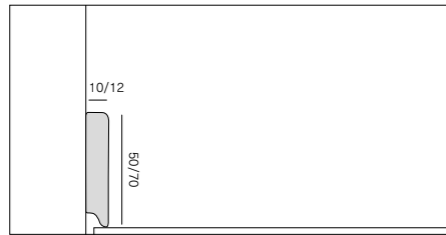
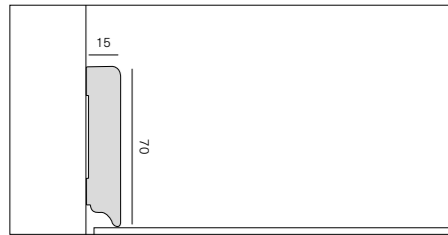

ABACO / RECAP

	DROP	PVC ESPANSO	F
Abbinati Matching	K-Uno	Star K Star KR Star KC Star KD Connex	Yes
Abbinabili Combined	-	Star KS Star Wood Star Wood Spina	-
Tinta unita Solid colors	○ Bianco/ White - RAL 9003, 9010	○ Bianco/ White - RAL 9003, 9010 ● Nero/ Black ● Alluminio/ Aluminum - RAL 9006	-
Dimensioni Size	h 70-2400x15 mm	h 50-2400x12 mm h 70-2400x12 mm	Variabile/ Variable

W45



Profilo per battiscopa realizzato in MDF rivestito di tranciato di vero legno con finiture verniciate a poro aperto (gruppo 1) e, per i colorati, con stampa digitale successivamente verniciato (gruppo 2).
Skirting board profile made of MDF and covered with real wood veneer. Two types of finishings available: open pore varnished finishing (group 1) and a coloured finishing made by digital printing process and then varnished (group 2).

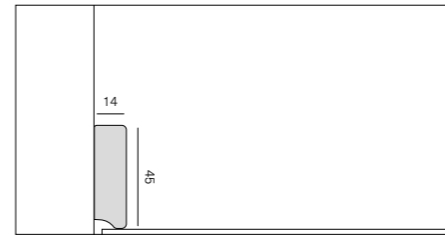

W75



Profilo per battiscopa realizzato in MDF rivestito di tranciato di vero legno con finiture verniciate a poro aperto (gruppo 1) e, per i colorati, con stampa digitale successivamente verniciato (gruppo 2).
Skirting board profile made of MDF and covered with real wood veneer. Two types of finishings available: open pore varnished finishing (group 1) and a coloured finishing made by digital printing process and then varnished (group 2).

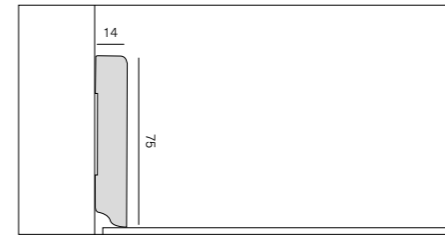

ABACO / RECAP

	W45	W75
Abbinabili Combined	Palladio Yes	Palladio Yes
Dimensioni Size	h 45-2400x14 mm	h 75-2400x14 mm

Profili

Profiles

PARAGRADINO ANTISDRUCCIOLO
NO-SLIP STAIR PROTECTOR



Paragradino antisdrucciolo in alluminio, che consente di rivestire il raccordo tra alzata e pedata di una scala.
Acquistare sempre con antiscivolo autoadesivo.
Non-slip aluminum stair nosing, used to cover the transition between the riser and tread of a staircase. Always purchase with self-adhesive non-slip tape.

ANGOLARE AD L
L-SHAPED CORNER PROFILE

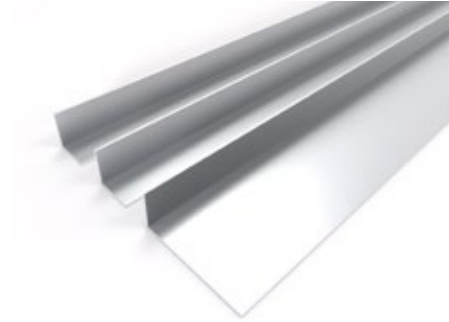

Profilo in alluminio per finiture di raccordi a muro.
Aluminium profile for finishing wall connections.

PROFILO DI BORDO
BORDER PROFILE

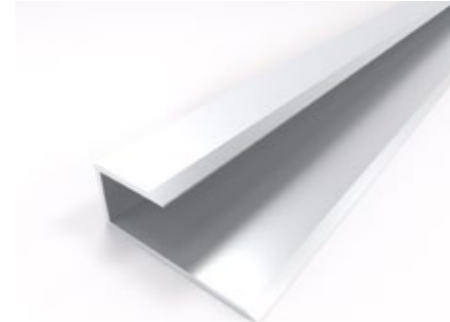

Profilo in alluminio estruso per bordature perimetrali per pavimenti.
Extruded aluminium profile for perimeter edging of floors.

PROFILO DI BORDO CURVABILE
CURVABLE BORDER PROFILE



Profilo in alluminio estruso curvabile per bordature perimetrali.
Extruded curvable aluminium profile for perimeter edging.

PROFILO SCALA 45°
45° STAIR PROFILE



Profilo paragradino in alluminio anodizzato argento per protezione e finitura arrotondata degli angoli esterni.
Silver anodized aluminum step nosing profile for protection and rounded finishing of external corners.

PROFILO SCALA LUMBERTECH
LUMBERTECH STAIR PROFILE



Profilo a L in alluminio anodizzato argentato per rivestire i gradini, utilizzando le stesse doghe utilizzate per il pavimento.
L-shaped profile in silver anodized aluminum to cover the steps, using the same slats used for the floor.

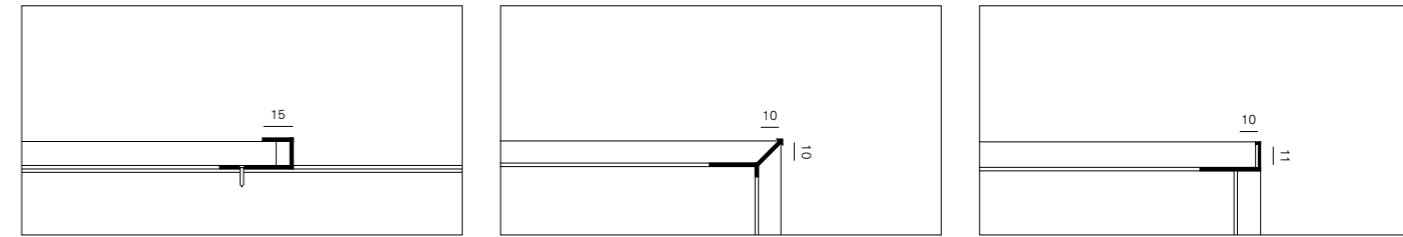
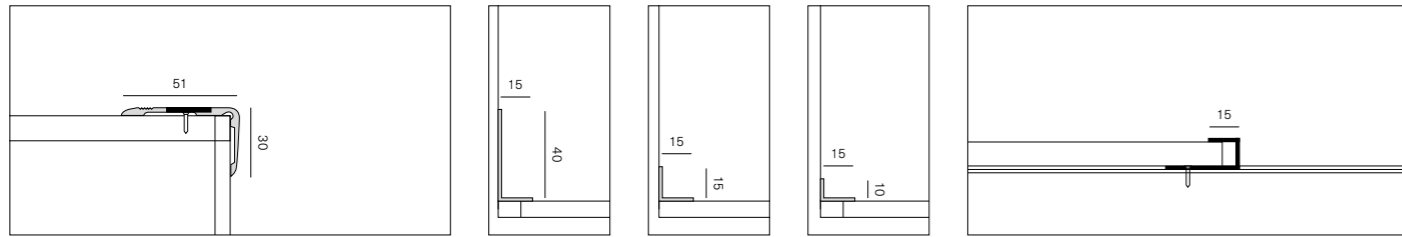

ABACO / RECAP

	PARAGRADINO ANTISDRUCCIOLO NO-SLIP STAIR PROTECTOR	ANGOLARE AD L L-SHAPED CORNER PROFILE	PROFILO DI BORDO BORDER PROFILE
Collezioni Lines	Pavimenti tecnici/ Technical flooring SPC Legni/ Wood	Pavimenti tecnici/ Technical flooring SPC Legni/ Wood	Pavimenti tecnici/ Technical flooring SPC Legni/ Wood
Tinta unita Solid colors	● Argento anodizzato/ Anodized silver ● Oro anodizzato/ Anodized gold ● Bronzo anodizzato/ Anodized bronze	● Argento/ Silver ● Bronzo/ Bronze	● Argento/ Silver ● Oro/ Gold
Dimensioni Size	3400x52x30 mm 18 m rotolo striscia antiscivolo autoadesiva/ 18 m roll self-adhesive non-slip strip	● 2000/3000x15x10 mm spessore 1,0 mm/ 1.0 mm thick ● 2000x15x15 mm spessore 1,5 mm/ 1.5 mm thick ● 2000x45x40 mm spessore 2,0 mm/ 2.0 mm thick	2700x15x6 mm 2700x15x7 mm 2700x15x9 mm 2700x15x11 mm 2700x15x15 mm

ABACO / RECAP

	PROFILO DI BORDO CURVABILE CURVABLE BORDER PROFILE	PROFILO SCALA 45° 45° STAIR PROFILE	PROFILO SCALA LUMBERTECH LUMBERTECH STAIR PROFILE
Collezioni Lines	Pavimenti tecnici/ Technical flooring SPC Legni/ Wood	-	-
Collezioni abbinate Matching lines	-	K-Uno	Lumbertech
Tinta unita Solid colors	● Argento/ Silver ● Oro/ Gold ● Bronzo/ Bronze	● Argento/ Silver	● Argento/ Silver
Dimensioni Size	Pavimenti tecnici/ Technical flooring ● 2700x15x9 mm - 2700x15x11 mm SPC ● 2700x15x7 mm Legni/ Wood ● 2700x15x11 mm ● 2700x15x13 mm - 2700x15x15 mm	3000x10 mm spessore 10 mm/ 10 mm thick	2700x11 mm spessore 11 mm/ 11 mm thick

PROFILO SCALA SINTESY
SINTESY STAIR PROFILE



Profilo scala in alluminio anodizzato argento, per rivestire i gradini con le stesse doghe utilizzate per realizzare il pavimento.
Anodized Silver anodized aluminum profile to cover the steps with the same planks used for the flooring.

TORO SCALA F
F STAIR NOSE



Toro scala realizzato con sistema folding utilizzando le relative doghe del pavimento, così da ottenere un perfetto abbinamento con lo stesso.
Verificare con ufficio tecnico la fattibilità nella finitura desiderata.
Stair nose made with folding system using the same planks of the floor, in order to obtain a perfect match with the same. Check with the technical office the feasibility in the desired finish.

TORO SCALA 30x30
STAIR NOSE 30x30



Toro scala in massello con spessori 10 mm e 15 mm; su richiesta il profilo può essere fornito anche stondato.
Solid wood stair bullnose with thicknesses of 10 mm and 15 mm; upon request, the profile can also be supplied with a rounded edge.

TORO SCALA 100x30
STAIR NOSE 100x30



Toro scala in massello con spessori 10 mm e 15 mm; su richiesta il profilo può essere fornito anche stondato.
Solid wood stair bullnose with thicknesses of 10 mm and 15 mm; upon request, the profile can also be supplied with a rounded edge.

TORO SCALA ELITE
ELITE STAIR NOSE



Toro scala in HDF, da abbinare esclusivamente alla maschiatura sul lato lungo dei pavimenti. Fissaggio con collante specifico.
HDF stair bullnose, to be combined exclusively with the tongue on the long side of the flooring. Fix with specific adhesive.

KIT DILATAZIONE
EXPANSION KIT

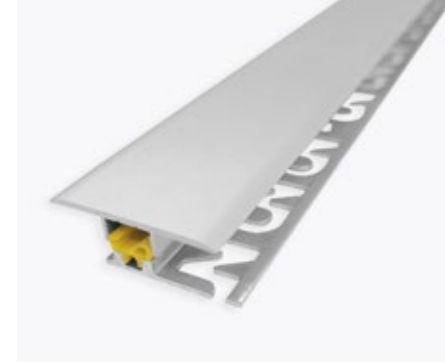

Kit dilatazione abbinabile e in alluminio con Pin Unico per pavimenti con spessore da 6 a 12,5 mm, con base femmina in alluminio.
Aluminum expansion kit with Single Pin for floorings with thickness from 6 to 12,5 mm and aluminum female base.

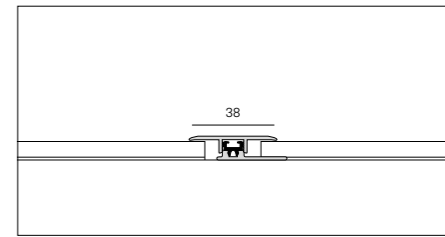
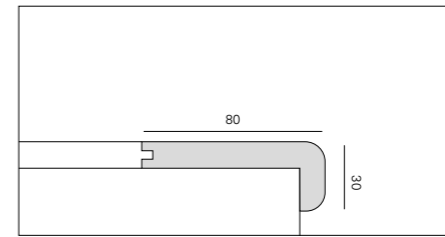
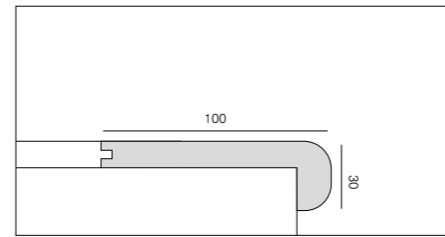
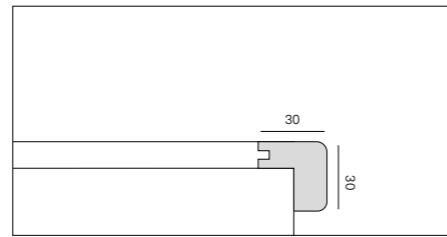
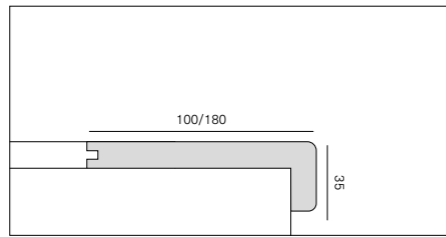
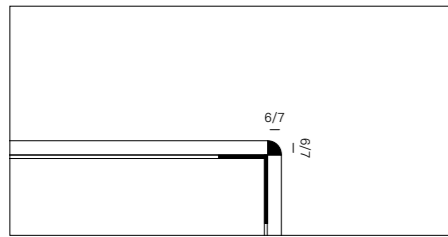

ABACO / RECAP

	PROFILO SCALA SINTESY SINTESY STAIR PROFILE	TORO SCALA F F STAIR NOSE	TORO SCALA 30x30 STAIR NOSE 30x30
Collezioni Lines	SPC	-	-
Abbinabile Combined	-	Palladio Yes	Palladio
Tinta unita Solid colors	● Argento/ Silver	-	-
Dimensioni Size	2700x6 mm Star Wood - Star Wood Spina 2700x7 mm	Palladio 1850/2150x100/135/180x35 mm Yes Variabile/ Variable	30x30x1200 mm

ABACO / RECAP

	TORO SCALA 100x30 STAIR NOSE 100x30	TORO SCALA ELITE ELITE STAIR NOSE	KIT DILATAZIONE EXPANSION KIT
Collezioni Lines	-	-	Pavimenti tecnici/ Technical flooring Legni/ Wood
Abbinati Matching	-	K-Uno Prestige L Prestige Gold	K-Uno Prestige L Prestige Gold Facile+ Vision Oxid Vision Technic Lumbertech
Abbinabili Combined	Palladio	-	Syncro Parquet
Tinta unita Solid colors	-	-	● Argento anodizzato/ Anodized silver
Dimensioni Size	100x30x1200 mm	2430x80x30 mm K-Uno spessore 10 mm/ 10 mm thick Prestige L - Prestige Gold spessore 8 mm/ 8 mm thick	2700x38 mm

KIT DILATAZIONE DA 5 A 7 MM
EXPANSION KIT 5 TO 7 MM

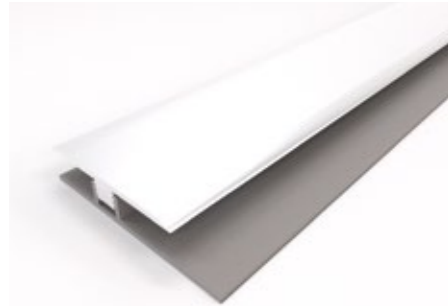

Kit dilatazione in alluminio per pavimenti con spessore da 5 a 7 mm, con base femmina in PVC. Aluminum expansion kit for floorings with thickness from 5 to 7 mm and PVC female base.

DILATAZIONE SINTESY
SINTESY EXPANSION



Profilo di dilatazione in alluminio anodizzato argenteo autoadesivo. Self-adhesive silver anodized aluminium expansion profile.

DISLIVELLO SINTESY
SINTESY SPLICE PROFILE



Profilo di dislivello in alluminio anodizzato autoadesivo per pavimenti con spessore da 4 a 6 mm. Self-adhesive anodized aluminium transition profile for 4-6 mm floors.

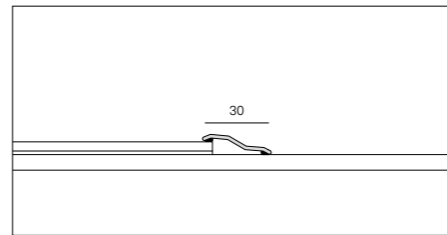
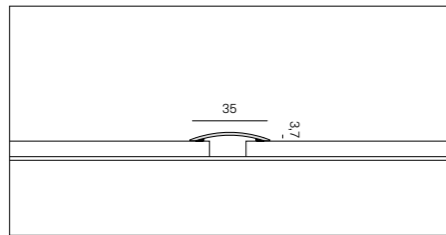
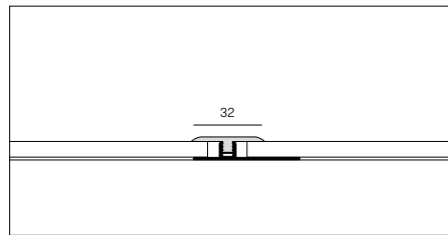

ABACO / RECAP

	KIT DILATAZIONE DA 5 A 7 MM EXPANSION KIT 5 TO 7 MM	DILATAZIONE SINTESY SINTESY EXPANSION	DISLIVELLO SINTESY SINTESY SPLICE PROFILE
Collezioni Lines	SPC	SPC	-
Abbinati Matching	Star K Star KR Star KC Star KS Star KD Connex	-	Star K Star KR Star KC Star KS Star KD Connex
Abbinabili Combined	Star KS Star Wood Star Wood Spina	-	-
Tinta unita Solid colors	● Argento anodizzato/ Anodized silver	● Argento satinato/ Satin silver	● Argento anodizzato/ Anodized silver
Dimensioni Size	2700x32 mm	2700x35 mm	2700x29 mm

KIT DISLIVELLO DA 6 A 12,5 MM
SPLICE KIT 6 TO 12,5 MM

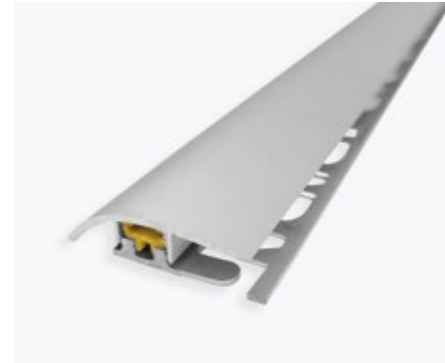

Kit dislivello in alluminio con Pin Unico per pavimenti con spessore da 6 a 12,5 mm con base femmina in alluminio. Aluminium transition kit with Single Pin for floors with thickness from 6 to 12.5 mm, with aluminium female base.

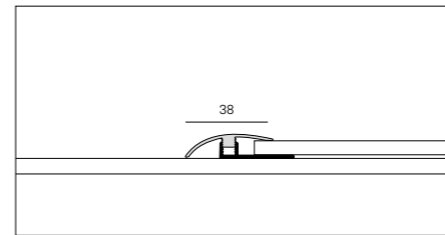

KIT DISLIVELLO DA 5 A 7 MM
SPLICE KIT 5 TO 7 MM

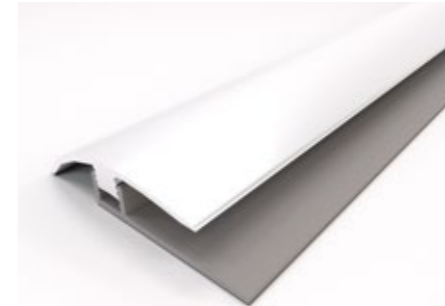

Kit dislivello in alluminio o abbinato per pavimenti con spessore da 5 a 7 mm con base femmina in PVC. Aluminum splice or matching kit for floorings with thickness from 5 to 7 mm, with PVC female base.

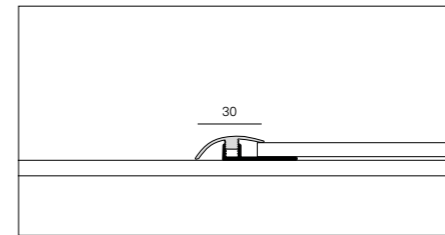

KIT TERMINALE
TERMINAL KIT



Kit terminale in alluminio con Pin Unico per pavimenti con spessore da 9 a 12,5 mm con base femmina in alluminio. Aluminium end kit with Single Pin for floors with thickness from 9 to 12.5 mm, with aluminium female base.

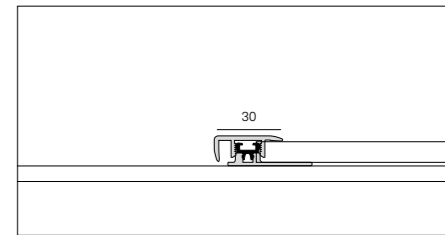

ABACO / RECAP

	KIT DISLIVELLO DA 6 A 12,5 MM SPLICE KIT 6 A 12,5 MM	KIT DISLIVELLO DA 5 A 7 MM SPLICE KIT 5 TO 7 MM	KIT TERMINALE TERMINAL KIT
Collezioni Lines	-	-	Pavimenti tecnici/ Technical flooring Legni/ Wood
Abbinati Matching	Pavimenti tecnici/ Technical flooring	Star K Star KR Star KC Star KD	-
Abbinabili Combined	-	Star KS	-
Tinta unita Solid colors	● Argento anodizzato/ Anodized silver	● Argento anodizzato/ Anodized silver	● Argento/ Silver
Dimensioni Size	2700x38 mm 2700x45 mm	2700x30 mm	2700x30 mm

Accessori per pavimenti sopraelevati Accessories for raised floors

KIT TERMINALE DA 5 A 7 MM
TERMINAL KIT FROM 5 TO 7 MM

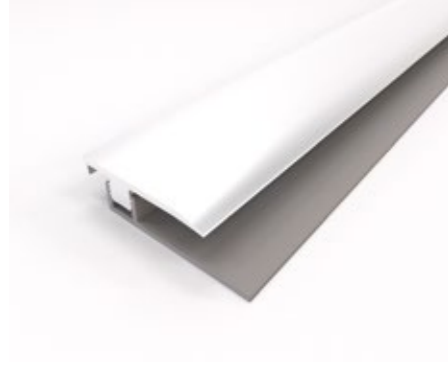

Kit terminale in alluminio per pavimenti con spessore da 5 a 7 mm con base femmina in PVC.
Aluminium end kit for floors with thickness from 5 to 7 mm, with PVC female base.

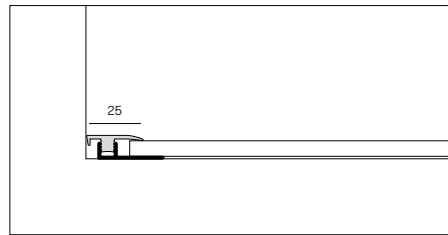

SISTEMA FOLDING PER SPC
FOLDING SYSTEM FOR SPC



L'elemento "folding" si presenta con una piega a 90°, adatto per rivestire scalini ad angolo retto. Solo per residenziale.
The "folding" element has a 90° bend, suitable for covering right-angled steps. For residential use only.

CLIP DI AGGANCIAMENTO
RETAINING CLIP



Clip di aggancio in metallo zincato nero che, con rotazione sull'omega, fissa pannelli e doghe alla struttura.
Black galvanized metal clip that, by rotating onto the omega, secures panels and slats to the structure.

COLONNA BASE FILETTATA
COLUMN WITH THREADED BASE



Altezza Min Max
Min-Max Height

40-60 mm
50-80 mm
60-100 mm
100-150 mm

COLONNA BASE INNESTATA
COLUMN WITH EMBEDDED BASE



Altezza Min Max
Min-Max Height

120-180 mm
140-190 mm
160-230 mm
190-260 mm
220-290 mm
260-330 mm
300-370 mm
340-410 mm
380-450 mm
420-490 mm
460-530 mm

TRAVERSO CON GUARNIZIONE BASIC
CROSS-PIECE WITH SEAL BASIC



Dimensioni
Size

35 mm
spessore 0,9 mm/ 0,9 mm thick

ABACO / RECAP

	KIT TERMINALE DA 5 A 7 MM TERMINAL KIT FROM 5 TO 7 MM	SISTEMA FOLDING PER SPC FOLDING SYSTEM FOR SPC	CLIP DI AGGANCIAMENTO RETAINING CLIP
Collezioni Lines	-	Star KD Star K Star KR Star KS Star KC Star KW	K-Uno Prestige L Lumbertech
Abbinati Matching	SPC	-	-
Tinta unita Solid colors	● Argento anodizzato/ Anodized silver	-	-
Dimensioni Size	2700x25 mm	Dimensione doga piegata (lunghezza x pedata x alzata) Folded plank size (length x tread x riser) Star KD 914x375x76 mm Star K 1828x140x72 mm Star KR 1500x140x74 mm 1828x150x72 mm Star KC 1500x148x74 mm Star KW Su richiesta/ On demand	44x41 mm
Confezione Packaging			200 pz/ pcs

Accessori per rivestimenti a parete e soffitto

Accessories for wall and ceiling coverings

PROFILO SPIGOLO A Y
Y-EDGE



PROFILO COMPLETAMENTO
COMPLETION KIT



PROFILO SPIGOLO QUADRATO
SQUARE EDGE



ABACO / RECAP

	PROFILO SPIGOLO A Y Y-EDGE	PROFILO COMPLETAMENTO COMPLETION KIT	PROFILO SPIGOLO QUADRATO SQUARE EDGE
Collezioni Lines	Star KW	Star KW	Star KW
Dimensioni Size	2700x4,5 mm	2700x4,5 mm	2700x4,5 mm

PROFILO SPIGOLO TONDO
ROUND EDGE



PROFILO OMEGA
OMEGA PROFILE

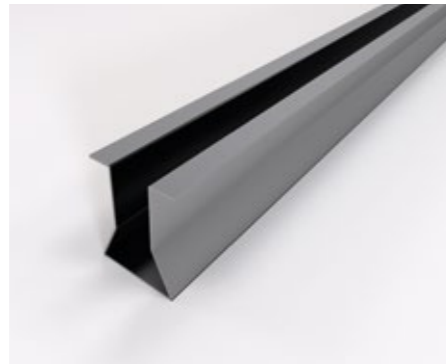

PROFILO JOLLY
JOLLY PROFILE

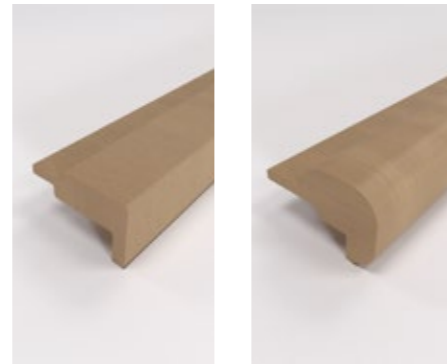

Il profilo ad omega costituisce l'elemento per il fissaggio a parete tramite viti o tasselli e deve essere montato ad una struttura portante tipo cartongesso o al muro da rivestire.
Omega cross-section profile is the element that fastens the boards to the wall. It must be installed using screws or wall plugs to a load bearing structure, such as drywall or the wall to be covered.

Profilo in MDF sagomato per tamponamento laterale del rivestimento a parete Tech Wall.
La forma squadrata è ideale per le doghe TW1 e TW2, la forma arrotondata per le doghe TW3.
Shaped MDF profile for the lateral closure of the Tech Wall cladding.
The squared shape is ideal for TW1 and TW2 slats, while the rounded shape is suitable for TW3 slats.

ABACO / RECAP

	PROFILO SPIGOLO TONDO ROUND EDGE	PROFILO OMEGA OMEGA PROFILE	PROFILO JOLLY JOLLY PROFILE
Collezioni Lines	Star KW	-	Tech Wall
Tinta unita Solid colors	-	-	<ul style="list-style-type: none"> ● Raw Oak ● Timber ● Nux ● Nero/ Black ● Paint
Dimensioni Size	2700x4,5 mm	3000x25x26 mm 3000x13x26 mm	3040x32x20 mm 3040x29,4x18,4 mm

Posa

Laying

KIT MORSETTI TELESCOPICI
TELESCOPIC CLAMP KIT



In fase di partenza il muro non è mai regolare. I morsetti permettono di registrare la distanza tra muro e pavimento in senso longitudinale, accelerando le fasi di posa di un pavimento flottante. Consigliati 2 kit per posatore.
When starting, walls are never perfect. These clamps allow you to register the horizontal distance between the wall and the flooring, for more rapid installation.
2 kits per installer are recommended.

GRIMALDELLO
PICKLOCK



È indispensabile per completare l'ultima fila di pavimento, in quanto non c'è spazio per la manovra del martello. Solo per incastri SLS e PLS (no TLS). Consigliati 1 pezzo per posatore.
This tool is required for finishing the last row of the flooring as there is no place enough for using the hammer.
We recommend 1 tool per installer.

TENSIONATORE CINGHIA
BELT TENSIONER



Per pavimenti con incastro a colla. Strumento per compattare le prime tre/ quattro file di doghe, fondamentali per la buona riuscita del lavoro soprattutto con colori chiari su incastri tradizionali a colla. Consigliati 6 pezzi per posatore.
For floorings with glued joints. Fundamental for good installation, especially for light colours with traditional glued joints.
6 units per installer are recommended.

Collezioni
Lines

Pavimenti tecnici/
Technical flooring
Legni/ Wood

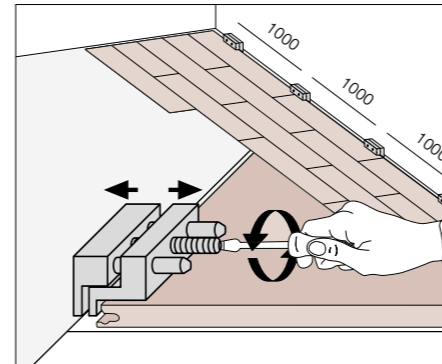

Collezioni
Lines

Pavimenti tecnici/
Technical flooring
Legni/ Wood

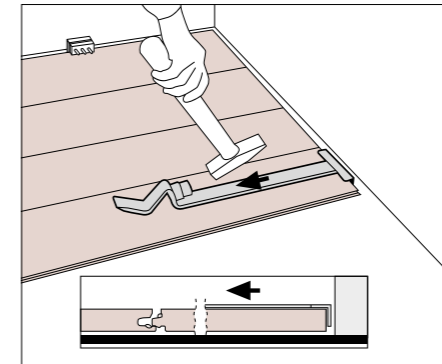

Collezioni
Lines

Pavimenti tecnici/
Technical flooring
Legni/ Wood

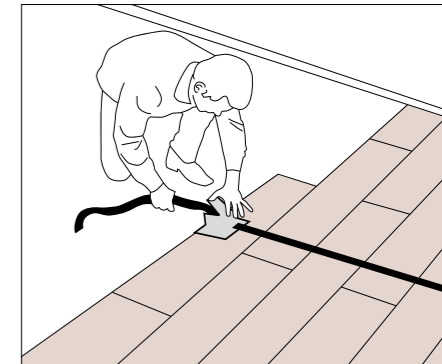

DISTANZIATORE PER PAVIMENTI FLOTTANTI
SPACER FOR FLOATING FLOORING



Nei casi in cui si debba fissare al pavimento elementi di arredo o funzionali, consente di evitare il bloccaggio delle dilatazioni del pavimento e conseguenti sollevamenti dello stesso.
If you need to fasten pieces of furniture or functional elements to the flooring, it avoids blocking the flooring expansion and its consequent raising.

Collezioni Pavimenti tecnici/
Lines Technical flooring

DISTANZIATORE PER PAVIMENTI AV2
AV2 SPACER FOR FLOORING



Distanziatore in plastica per pavimenti flottanti, regolabile 5–20 mm.
Plastic spacer for floating floors, adjustable 5–20 mm.

Collezioni Pavimenti tecnici/
Lines Technical flooring
Legni/ Wood

BATTITAVOLA PAVIMENTI TECNICI
TECHNICAL FLOORING STAVES ALIGNER



Indispensabile per raccordare le doghe. Consigliato 1 pezzo per posatore.
Avvertenza: Usare esclusivamente battitavola originali per evitare di danneggiare l'incastro in modo irreparabile.
Indispensable for aligning the edge of the panels. We recommend 1 tool per installer.
Notice: Use only original Staves Aligner to avoid irreparable damages to the joint.

Collezioni Pavimenti tecnici/
Lines Technical flooring

COLLA NUNIVIL 1008 (D3)
GLUE NUNIVIL 1008 (D3)



Adesivo acetovinilico per pavimenti flottanti con incastro M/F. Consumo medio 35–40 g/m².
Consultare la documentazione tecnica sul sito.
Special vinyl adhesive for floating floors with M/F joint. Average consumption 35–40 g/m².
Refer to the technical documentation on the website.

Collezioni Pavimenti tecnici/
Lines Technical flooring
Legni/ Wood

Confezione 500 gr
Packaging

COLLA ISOCOLL 6307 BEIGE
PER BATTISCOPA PVC ESPANSO
GLUE ISOCOLL 6307 BEIGE
FOR EXPANDED PVC SKIRTING BOARDS



Colla poliuretanica monocomponente per un ottimo fissaggio del battiscopa in PVC espanso su diverse superfici.
Single component polyurethane adhesive for excellent fastening of expanded PVC skirting board on different surfaces.

Collezioni SPC
Lines

Confezione 290 ml
Packaging

COLLA ISOCOLL ECO 6056 BIANCO
PER SCALE BATTISCOPA
GLUE ISOCOLL ECO 6056 WHITE
FOR STEPS AND SKIRTING BOARDS



Colla monocomponente per il fissaggio del battiscopa e incollaggio gradini.
Single component adhesive for fastening skirting and stair elements.

Collezioni Pavimenti tecnici/
Lines Technical flooring
Legni/ Wood

Confezione 290 ml
Packaging

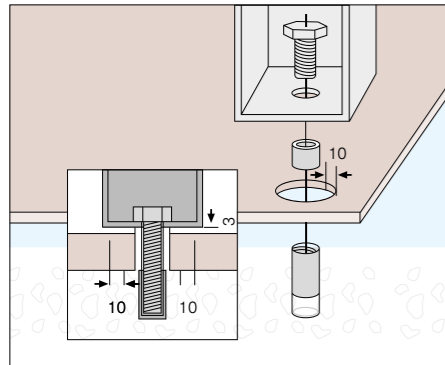

ACCESSORI DI MONTAGGIO
INSTALLATION ACCESSORIES



Accessori complementari utili per un lavoro preciso e veloce.
Accessories complementary for accurate, rapid installation.

Collezioni Pavimenti tecnici/
Lines Technical flooring

Cura e manutenzione

Care and maintenance

PULISYSTEM



Detergente igienizzante.
Sanitizing detergent.

Collezioni
Lines

Pavimenti tecnici/
Technical flooring
Lumbertech
SPC

Confezione
Packaging

1 L

SANITOTAL



Detergente decontaminante.
Attenzione: da utilizzarsi dopo aver lavato le superfici con il prodotto pulisystem.
Decontaminant detergent.
Warning: use only after cleaning surfaces with Pulisystem.

Collezioni
Lines

Pavimenti tecnici/
Technical flooring
Lumbertech
SPC

Confezione
Packaging

1 L

MULTILAYER CLEANER



Detergente antistatico sanificante adatto alla pulizia di pavimenti tecnici e vinilici.
Antistatic sanitizing cleaner for technical and vinyl flooring.

Collezioni
Lines

Pavimenti tecnici/
Technical flooring
Lumbertech
SPC

Confezione
Packaging

1 L

OLIO PER RITOCOCCO RETOUCHING OIL



Olio per ritocco e ripristino.
Touch-up and restoration oil.

Collezioni
Lines

Lumbertech 270 Oil

Confezione
Packaging

0,125 L

CLEANER STAR



Detergente intensivo multiuso per la pulizia di pavimenti in legno verniciati/ olio UV.
Intensive multipurpose cleaner for varnished and UV-oiled wooden floors.

Collezioni
Lines

Lumbertech 270
Varnish, 205, S700
Palladio

Confezione
Packaging

-

OSMO POLYX OIL 3062 MATT



Trattamento speciale di oliatura.
Special oiling treatment.

Collezioni
Lines

Lumbertech 270 Oil

Confezione
Packaging

-

WAX CARE SPRAY



Waxe care è una dispersione di cere idrorepellenti per la protezione di pavimenti in legno verniciati o oliati.
Waxe care is a dispersion of water-repellent waxes for protection of varnished or oiled wooden floors.

Collezioni
Lines

Star Wood
Star Wood Spina
Legni/ Wood

Confezione
Packaging

-

PARKETTREINIGER



Detergente per parquet a base di sapone naturale, pH neutro, ideale per la pulizia periodica di pavimenti in legno verniciati o oliati.
Parquet cleaner, natural soap-based, pH-neutral, ideal for regular cleaning of varnished or oiled wooden floors.

Collezioni
Lines

Lumbertech 270 Oil
Palladio
Yes

Confezione
Packaging

1 L

DETERGENTE MANUTENTORE CEROSO WAXY MAINTENANCE CLEANER



Prodotto di manutenzione trasparente a base di cere naturali per il rinnovo ciclico dei pavimenti in legno.
Transparent maintenance product based on natural waxes for the cyclical renewal of wooden floors.

Collezioni
Lines

Lumbertech 270 Oil
Palladio
Yes

Confezione
Packaging

1 L

**PACKAGING
E LOGISTICA**
PACKAGING
AND LOGISTICS

Pavimenti tecnici

Technical flooring

Prodotto Product	Rif. formato mm Size mm	Pezzi C fz Pieces Box	m ² C fz m ² Box	Dimensioni scatola mm Box dimensions mm	Kg per scatola Kg per box	C fz pallet Box pallet	m ² pallet m ² pallet	Dimensione pallet (mm) Pallet dimensions (mm)	Kg pallet al m ² Pallet kg per m ²	Peso lordo pallet Pallet Weight
K-UNO	2052x248x10	4	2,035	2070x260x40	18,38	42	85,494	2110x830x750	9,03	787
SYNCRO PARQUET	1184x293x8	6	2,081	1210x305x50	16,14	51	106,3	1220x930x1000	7,75	839
	1182x293x8	6	2,078	1210x305x50	17,08	51	106,02	1220x930x1000	8,22	886
	1183x601x8	3	2,132	1210x610x25	18,32	68	145.40.00	1220x1230x1030	8,59	1261
PRESTIGE GOLD	1288x198x8	10	2,55	1302x210x80	18,9	40	102,01	1305x850x960	7,4	770
PRESTIGE L	2052x220x8	6	2,708	2069x236x48	20,12	36	97,511	2120x930x585	7,43	740
FACILE+	1288x198x8	10	2,55	1302x210x80	18,44	40	102,01	1305x850x960	7,23	753
VISION OXID	1183x396x8	5	2,34	1210x405x45	19,82	42	98,295	1220x830x1020	8,46	848
	1184x601x8	3	2,135	1210x610x25	17,02	68	145,163	1220x1230x1030	7,98	1172
VISION TECHNIC	857x398x8	7	2,387	870x410x55	17,65	30	71,61	1240x880x700	7,4	546

Skema S.p.A.

Via dell'Artigianato, 8
31047 Ponte di Piave (TV) - Italy

Ph. (+39) 0422 858511
info@skema.eu
www.skema.eu

A.D.

arch. paolo pampanoni

Concept & Graphic

d+a srl

Set design, rendering

virtual design
nudesign srl

Photo

studio antiorario

Printed

grafiche antiga

La riproduzione dei colori è approssimativa.

Skema S.p.A. ha la facoltà esclusiva di modificare e sostituire, anche solo parzialmente, i componenti dei sistemi illustrati in questo folder, senza l'obbligo di darne preavviso.

The reproduction of colors is approximate. Skema S.p.A. has the exclusive right to modify and replace, even only partially, the components of the systems illustrated in this folder, without the obligation to give prior notice.

© Copyright by Skema S.p.A.
All rights reserved

