









NOME CLASSE DATA

AGRICOLTURA

1. COME SI CHIAMA? SCRIVI IL NOME.

			
.....
			
.....

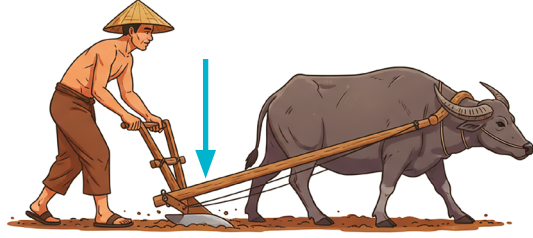

2. COMPLETA LA PAROLA.



	
_ O _ _ A _ _ N _	_ R _ T _ _

NOME CLASSE DATA

ARTIGIANATO

1. COME SI CHIAMA? SCRIVI IL NOME.

	→		→	
.....	

	→		→	
.....	

	→		→	
.....	

NOME CLASSE DATA

COLTIVARE, ALLEVARE, CREARE

1. COME SI CHIAMA? SCRIVI IL NOME.

.....

.....

.....

.....

.....

NOME CLASSE DATA

VERBI E LUOGHI

1. COME SI CHIAMA? SCRIVI IL NOME.

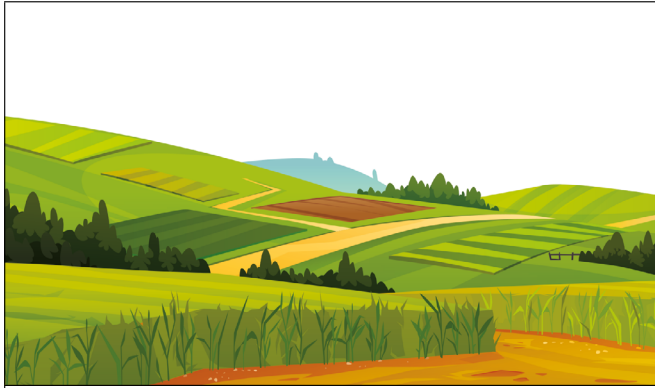

.....

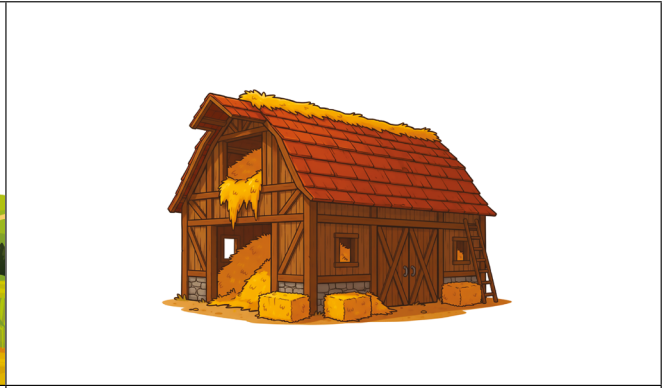

.....

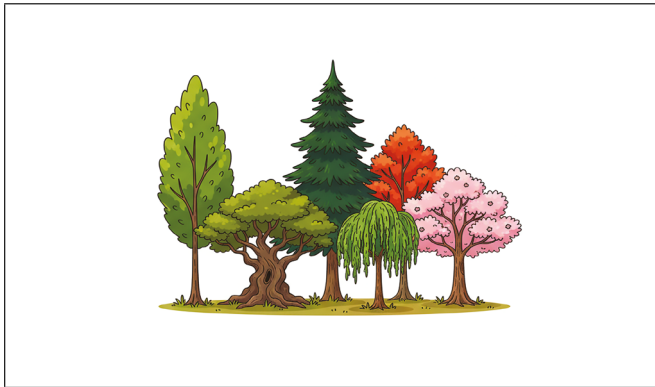

.....



.....

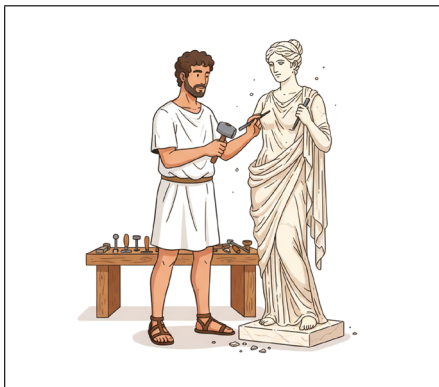

__ R __ _ _ _ _ _



__ O __ _ _ _ _ _





__ LL __ _ _ _ _ _

NOME CLASSE DATA

COMMERCIARE

1. COME SI CHIAMA? SCRIVI IL NOME

		
.....



		
.....



	
.....

NOME CLASSE DATA

VIAGGIARE

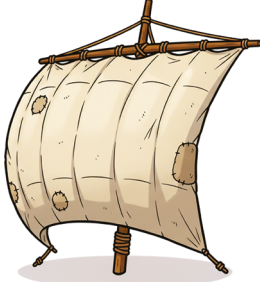
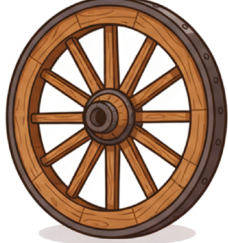
1. COME SI CHIAMA? SCRIVI IL NOME.

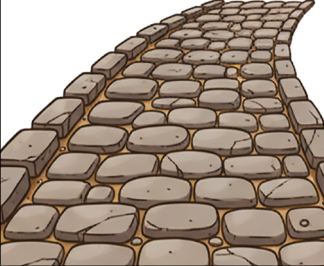
			
.....

			
.....

.....



NOME CLASSE DATA

MERCE E VERBI PRIMA PARTE

1. COME SI CHIAMA? SCRIVI IL NOME.

			
.....

			
.....

	
.....



NOME CLASSE DATA

MERCE E VERBI SECONDA PARTE

1. COME SI CHIAMA? SCRIVI IL NOME.

			
.....
			
.....

2. SCRIVI LE LETTERE MANCANTI.

	
__ V __ _ R __	__ C __ M __ _ _ _



NOME CLASSE DATA

MATERIALI ED EDIFICI

1. COME SI CHIAMA? SCRIVI IL NOME.

			
<p>.....</p>	<p>.....</p>	<p>.....</p>	<p>.....</p>
			
<p>.....</p>	<p>.....</p>	<p>.....</p>	<p>.....</p>

2. COMPLETA LA PAROLA.

		
<p>__ B _ _ _ Z _ _ _ _</p>		

NOME CLASSE DATA

LUOGHI

1. COME SI CHIAMA? SCRIVI IL NOME.



SI CHIAMA



SI CHIAMA



SI CHIAMA



SI CHIAMA

2. COMPLETA LA PAROLA.





__ TT __ G __



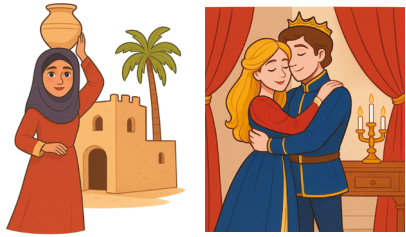

NOME CLASSE DATA

PERSONE E AZIONI

1. COME SI CHIAMA? SCRIVI IL NOME.

CHI		CHE COSA FA
		
.....



CHI		CHE COSA FA
		
.....



CHI		CHE COSA FA	
			
.....

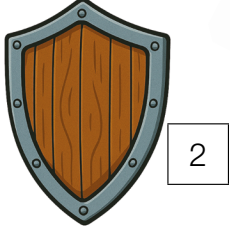
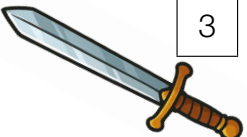

NOME CLASSE DATA

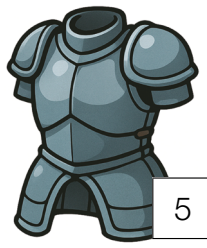
LE ARMI

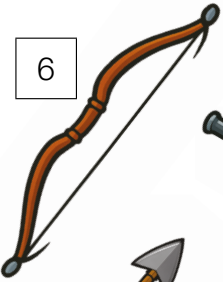
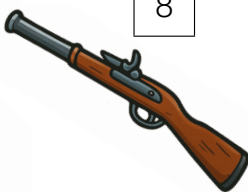
1. COME SI CHIAMA? SCRIVI IL NOME ACCANTO AL NUMERO GIUSTO.

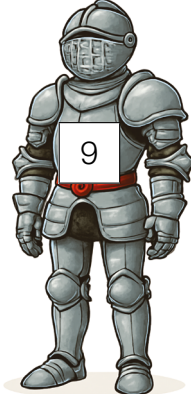
    	1. 2. 3. 4. 5.
---	---



   	6. 7. 8. 9.
---	--

 	10. 11.
---	----------------------

NOME CLASSE DATA

PERSONE E MACCHINE DA GUERRA

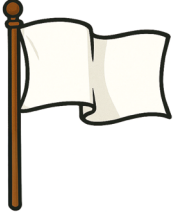

1. COME SI CHIAMA? SCRIVI IL NOME.

			
.....

2. COMPLETA LA TABELLA.

		
.....



		
.....

NOME CLASSE DATA

LUOGHI E AZIONI

1. COME SI CHIAMA? SCRIVI IL NOME.

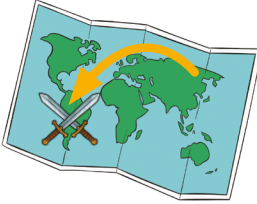
			
<p>.....</p>	<p>.....</p>	<p>.....</p>	<p>.....</p>

2. COME SI CHIAMA? SCRIVI IL NOME ACCANTO AL NUMERO GIUSTO.

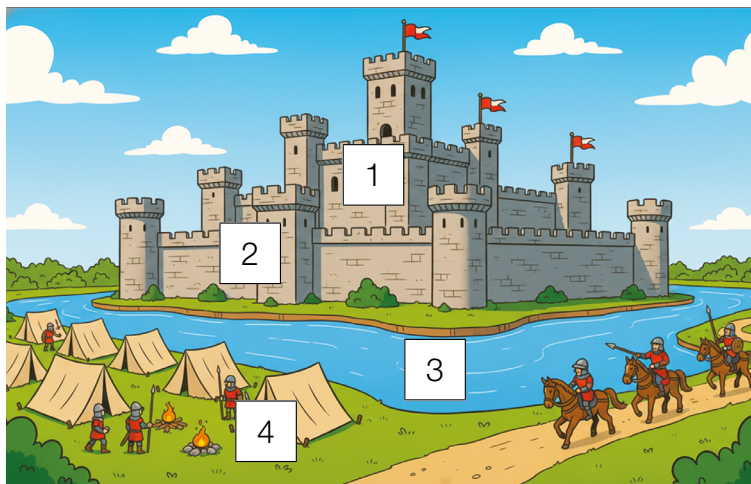

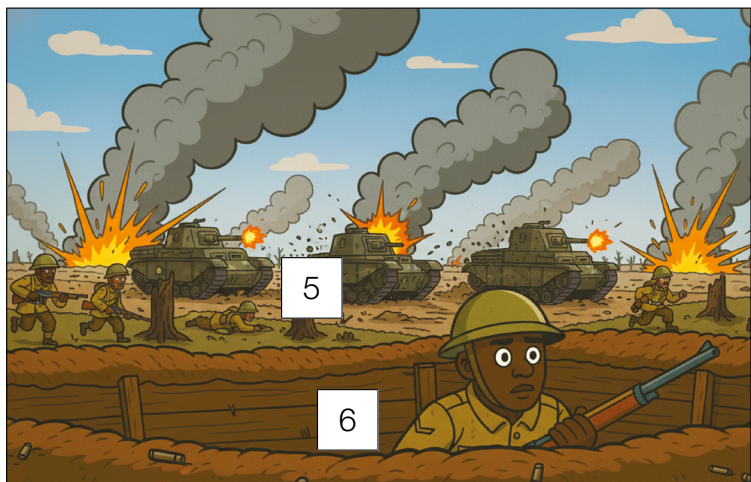
	<p>1.</p> <p>2.</p> <p>3.</p> <p>4.</p>
---	---

	<p>5.</p> <p>6. DI</p>
---	--

NOME CLASSE DATA

LUOGHI, PERSONE E OGGETTI

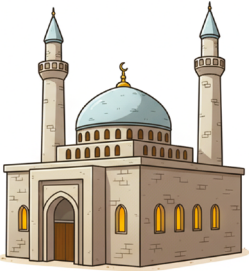
1. COME SI CHIAMA? SCRIVI IL NOME.

		
.....





		
.....





			
.....

NOME CLASSE DATA

AZIONI E DIVINITÀ

1. COME SI CHIAMA? SCRIVI IL NOME.

			
<p>.....</p>	<p>.....</p>	<p>.....</p>	<p>.....</p>

			
<p>.....</p>	<p>.....</p>	<p>.....</p>	<p>.....</p>



2. SCRIVI LE LETTERE MANCANTI.





	
<p>— — — — T — — — —</p>	<p>— — L — — — — — —</p>



NOME CLASSE DATA

CHI E DOVE

1. COME SI CHIAMA? SCRIVI IL NOME.

		
.....



			
.....	P



		
.....



NOME CLASSE DATA

LUOGHI E AZIONI

1. COME SI CHIAMA? SCRIVI IL NOME.

		
.....

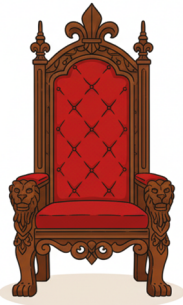





		
.....

		
.....

NOME CLASSE DATA

FORME DI GOVERNO

1. SCRIVI LE LETTERE MANCANTI.

GOVERNARE		
		
		
_____ A	_____ R _____	_____ Z _____

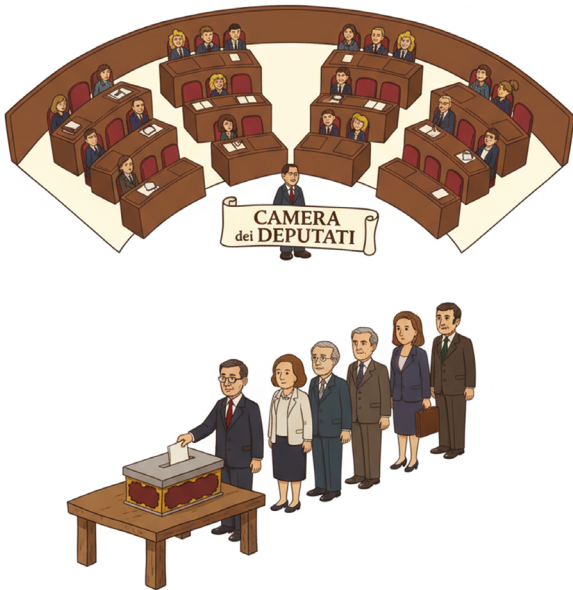
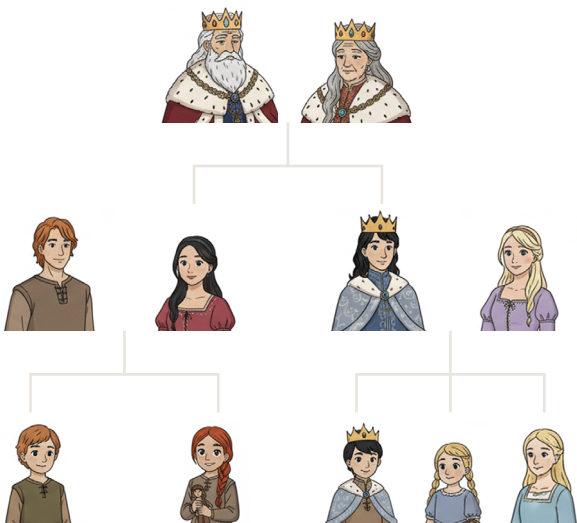
	
_____ L _____	_____ R _____