

Eljen GSF Geotextile Sand Filter

PASSIVE ADVANCED TREATMENT TECHNOLOGY

The Eljen GSF (Geotextile Sand Filter) is an alternative for onsite septic leachfield systems. The system is made up of geotextile fabric and a plastic core material that work together to provide vertical surface area throughout each Module and aids in oxygen transfer. The GSF applies treated effluent to the soil, increasing the soil's long term acceptance rate. A Specified Sand layer provides additional filtration, and prevents saturated conditions.



- Treatment and disposal in the same footprint
- Smaller installation area than conventional systems
- Reduced site impact
- Made from recycled materials
- Lightweight and easy to handle

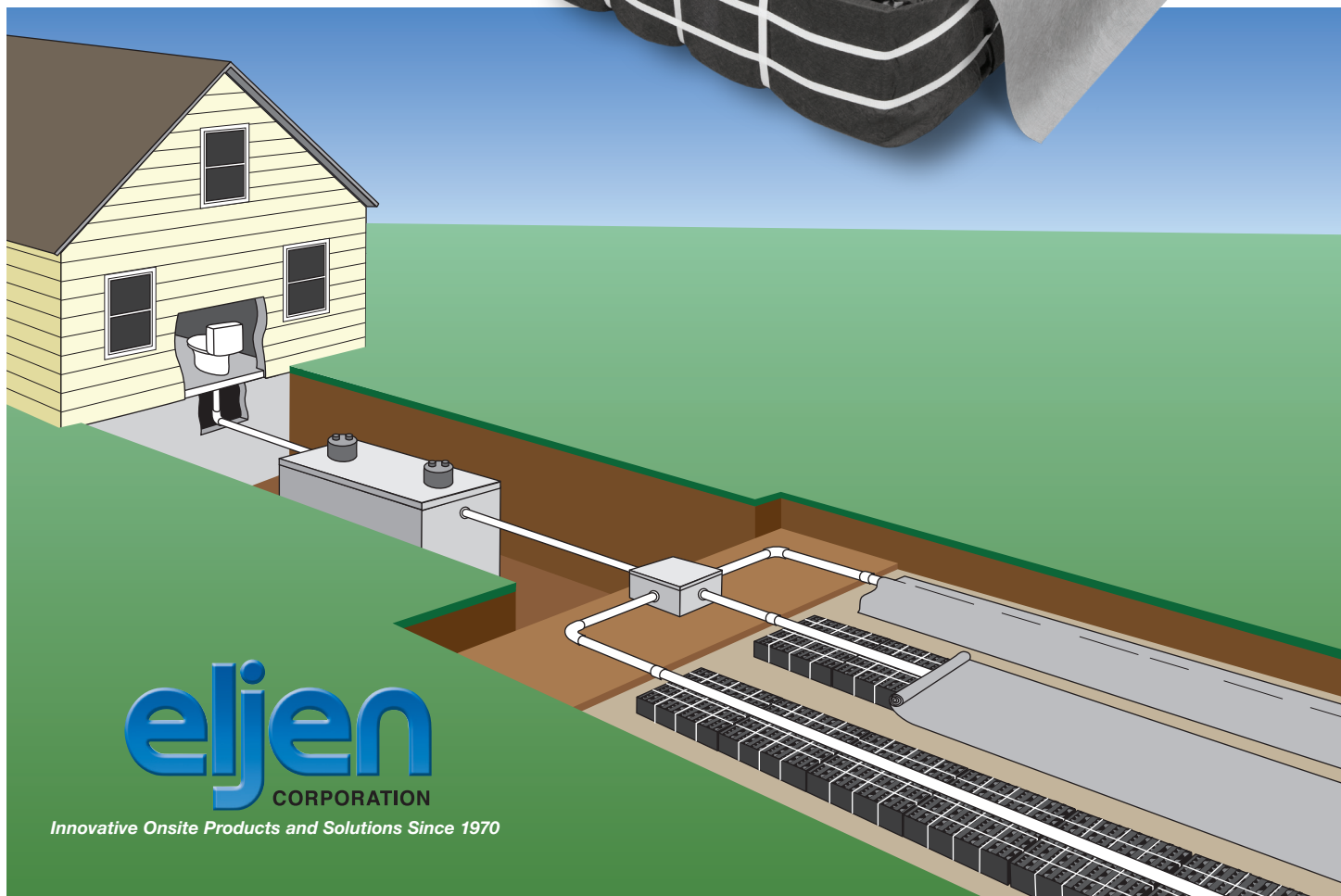

eljen
CORPORATION

Innovative Onsite Products and Solutions Since 1970

Flexible Site Installation

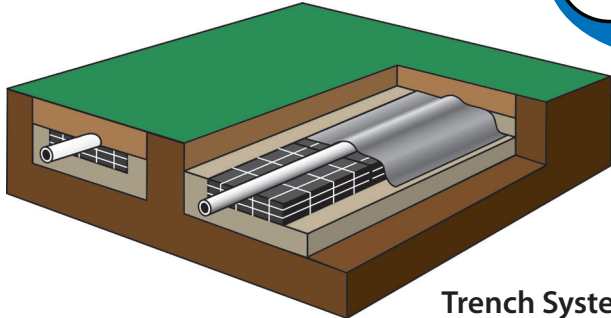

Trench System

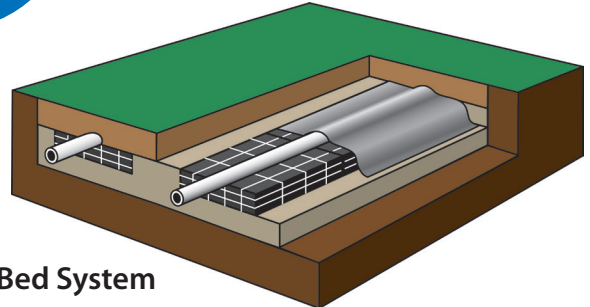

Bed System

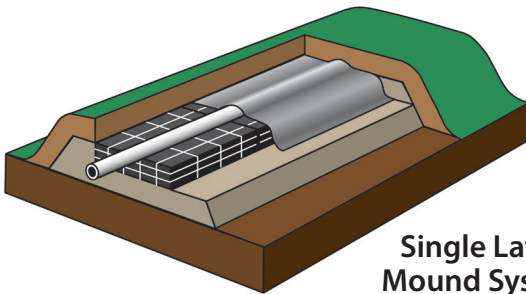

Single Lateral Mound System

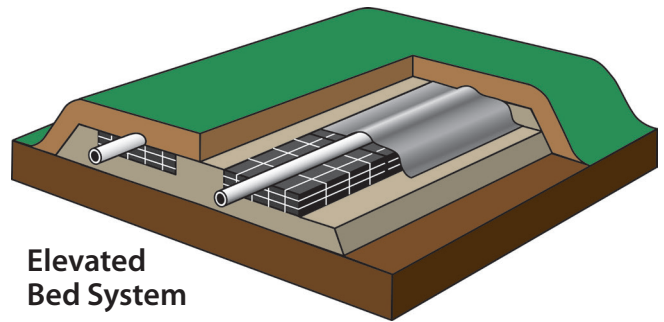

Elevated Bed System

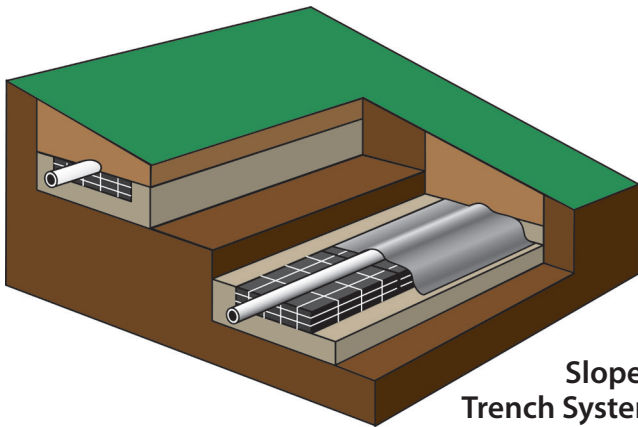

Sloped Trench System

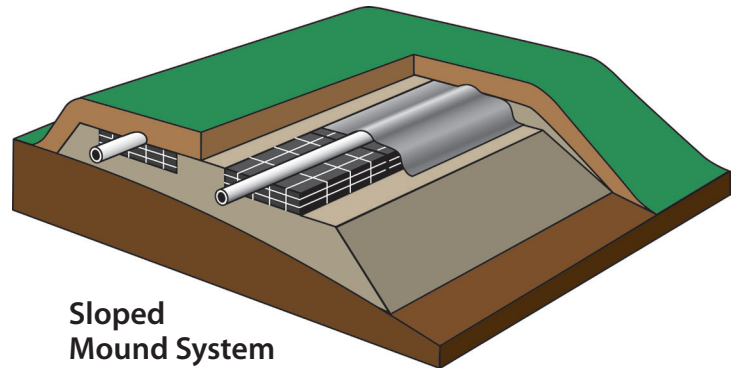

Sloped Mound System

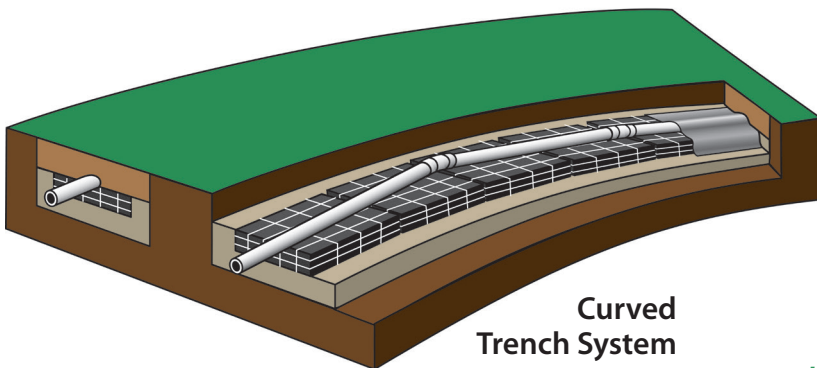

Curved Trench System

NOTE: Approved layouts vary by state. Please consult your appropriate Design and Installation Manual and local regulations for guidance.



Innovative Onsite Products and Solutions Since 1970

800-444-1359 • Email: info@eljen.com

Website: eljen.com



Printed on recycled paper

Patented ©2018 Eljen Corporation 1828A-06/18