

ELITE

Garden Rooms

Price List



CONTENTS:

Pages 3-5: Composite Denby and Dalbury

Dalbury/Denby Partition

Dalbury/Denby Canopy

Dalbury Roof Overhang and Wings

Pages 6-7: Dalbury Everframe

Page 8: Kingsley

Composite Harrington

Huntington

Walton

Pages 9-10: Walton

Walton Partition

Dukesbury

Page 11: Dukesbury

Pages 12-15: All door and window options and optional extras

	COMPOSITE DENBY	DALBURY (Internally complete)				OPTIONAL EXTRAS FOR DENBY OR DALBURY						
6ft Gable		Factory Painted	Composite	Cedar	Fluted	Guttering & Downpipe (Black/White)	Insulated Floor	Bearers	Plastic Bearers	Plinth Kit		
										Painted	Composite	Cedar
8' x 6' (2.43m x 1.82m)	£3,715	£4,745	£6,605	£7,825	£8,215	£125	£250	£115	£145	£155	£230	£310
10' x 6' (3.04m x 1.82m)	£4,440	£5,725	£7,955	£9,440	£9,910	£145	£295	£140	£165	£170	£265	£345
12' x 6' (3.65m x 1.82m)	£5,260	£6,700	£9,320	£11,050	£11,600	£160	£345	£180	£220	£195	£295	£385
14' x 6' (4.26m x 1.82m)	£5,890	£7,675	£10,680	£12,655	£13,290	£175	£385	£180	£220	£215	£325	£425
16' x 6' (4.87m x 1.82m)	£6,755	£8,645	£12,045	£14,265	£14,980	£200	£430	£255	£300	£230	£360	£460
18' x 6' (5.48m x 1.82m)	£7,490	£9,625	£13,400	£15,880	£16,670	£215	£475	£255	£300	£250	£390	£500
20' x 6' (6.09m x 1.82m)	£8,230	£10,600	£14,760	£17,485	£18,360	£230	£520	£255	£300	£270	£425	£540
22' x 6' (6.70m x 1.82m)	£8,965	£11,570	£16,120	£19,095	£20,055	£255	£565	£295	£360	£290	£455	£580
24' x 6' (7.31m x 1.82m)	£9,700	£12,550	£17,480	£20,710	£21,740	£275	£610	£400	£480	£315	£490	£615
Additional 2ft	£735	£975	£1,360	£1,610	£1,695	£20	£50	£35	£40	£20	£35	£45
8ft Gable		Factory Painted	Composite	Cedar	Fluted	Guttering & Downpipe (Black/White)	Insulated Floor	Bearers	Plastic Bearers	Plinth Kit		
										Painted	Composite	Cedar
8' x 8' (2.43m x 2.43m)	£4,740	£5,275	£7,350	£8,705	£9,140	£125	£290	£155	£185	£180	£285	£375
10' x 8' (3.04m x 2.43m)	£5,620	£6,335	£8,830	£10,455	£10,980	£145	£330	£155	£195	£210	£315	£415
12' x 8' (3.65m x 2.43m)	£6,495	£7,405	£10,310	£12,205	£12,815	£160	£380	£220	£265	£225	£345	£450
14' x 8' (4.26m x 2.43m)	£7,260	£8,470	£11,790	£13,960	£14,660	£175	£425	£220	£265	£240	£380	£490
16' x 8' (4.87m x 2.43m)	£8,145	£9,530	£13,275	£15,715	£16,500	£200	£470	£270	£330	£260	£415	£530
18' x 8' (5.48m x 2.43m)	£8,975	£10,600	£14,755	£17,460	£18,335	£215	£515	£270	£330	£285	£445	£565
20' x 8' (6.09m x 2.43m)	£9,810	£11,665	£16,240	£19,215	£20,180	£230	£560	£270	£330	£300	£475	£605
22' x 8' (6.70m x 2.43m)	£10,650	£12,725	£17,720	£20,965	£22,015	£255	£605	£315	£385	£325	£505	£645
24' x 8' (7.31m x 2.43m)	£11,485	£13,795	£19,200	£22,715	£23,855	£275	£650	£425	£510	£340	£540	£675
Additional 2ft	£835	£1,060	£1,485	£1,755	£1,960	£20	£50	£35	£40	£20	£35	£45
10ft Gable		Factory Painted	Composite	Cedar	Fluted	Guttering & Downpipe (Black/White)	Insulated Floor	Bearers	Plastic Bearers	Plinth Kit		
										Painted	Composite	Cedar
8' x 10' (2.43m x 3.04m)	£6,310	£6,330	£8,815	£10,450	£10,970	£125	£320	£170	£205	£225	£340	£450
10' x 10' (3.04m x 3.04m)	£7,240	£7,485	£10,410	£12,330	£12,945	£145	£370	£170	£205	£240	£375	£490
12' x 10' (3.65m x 3.04m)	£8,265	£8,640	£12,010	£14,205	£14,915	£160	£415	£225	£275	£265	£400	£530
14' x 10' (4.26m x 3.04m)	£8,955	£9,795	£13,605	£16,095	£16,895	£175	£455	£225	£275	£285	£435	£565
16' x 10' (4.87m x 3.04m)	£9,940	£10,955	£15,210	£17,970	£18,865	£200	£500	£285	£350	£300	£470	£605
18' x 10' (5.48m x 3.04m)	£10,875	£12,105	£16,800	£19,850	£20,840	£215	£545	£285	£350	£325	£500	£645
20' x 10' (6.09m x 3.04m)	£11,805	£13,260	£18,400	£21,730	£22,820	£230	£595	£285	£350	£340	£535	£675
22' x 10' (6.70m x 3.04m)	£12,740	£14,415	£19,990	£23,605	£24,785	£255	£640	£325	£400	£360	£565	£720
24' x 10' (7.31m x 3.04m)	£13,670	£15,570	£21,595	£25,485	£27,530	£275	£675	£435	£530	£380	£595	£760
Additional 2ft	£930	£1,155	£1,600	£1,875	£1,970	£20	£50	£35	£40	£20	£35	£45

Our internally complete Elite garden rooms include 50mm insulation in the walls and ceiling, MDF internal cladding, and laminate flooring.

12ft Gable	COMPOSITE DENBY	DALBURY (Internally complete)				OPTIONAL EXTRAS FOR DENBY OR DALBURY						
		Factory Painted	Composite	Cedar	Fluted	Guttering & Downpipe (Black/White)	Insulated Floor	Bearers	Plastic Bearers	Plinth Kit		
										Painted	Composite	Cedar
8' x 12' (2.43m x 3.65m)	£7,820	£9,140	£12,720	£15,080	£15,835	£125	£350	£195	£235	£250	£380	£500
10' x 12' (3.04m x 3.65m)	£9,135	£10,560	£14,695	£17,390	£17,535	£145	£395	£195	£235	£270	£415	£540
12' x 12' (3.65m x 3.65m)	£10,465	£11,975	£16,675	£19,700	£19,855	£160	£445	£240	£295	£290	£445	£580
14' x 12' (4.26m x 3.65m)	£11,725	£13,395	£18,650	£22,005	£23,105	£175	£490	£240	£295	£310	£475	£615
16' x 12' (4.87m x 3.65m)	£12,880	£14,815	£20,625	£24,320	£25,535	£200	£535	£295	£375	£325	£505	£655
18' x 12' (5.48m x 3.65m)	£14,140	£16,230	£22,600	£26,630	£27,960	£215	£580	£295	£375	£345	£540	£695
20' x 12' (6.09m x 3.65m)	£15,400	£17,650	£24,575	£28,940	£30,390	£230	£620	£295	£375	£370	£570	£730
22' x 12' (6.70m x 3.65m)	£16,655	£19,070	£26,555	£31,250	£32,815	£255	£665	£340	£430	£395	£605	£770
24' x 12' (7.31m x 3.65m)	£17,915	£20,480	£28,530	£33,555	£35,235	£275	£715	£450	£555	£420	£640	£810
Additional 2ft	£1,260	£1,420	£1,980	£2,310	£2,425	£20	£50	£35	£40	£20	£35	£45
14ft Gable	COMPOSITE DENBY	DALBURY (Internally complete)				OPTIONAL EXTRAS FOR DENBY OR DALBURY						
		Factory Painted	Composite	Cedar	Fluted	Guttering & Downpipe (Black/White)	Insulated Floor	Bearers	Plastic Bearers	Plinth Kit		
										Painted	Composite	Cedar
8' x 14' (2.43m x 4.26m)	£9,690	£11,255	£15,655	£18,570	£19,500	£125	£390	£210	£255	£285	£425	£565
10' x 14' (3.04m x 4.26m)	£11,395	£13,100	£18,050	£21,650	£22,940	£145	£435	£210	£260	£300	£455	£605
12' x 14' (3.65m x 4.26m)	£13,135	£14,965	£20,450	£24,725	£25,960	£160	£480	£270	£330	£320	£490	£645
14' x 14' (4.26m x 4.26m)	£14,870	£16,815	£22,855	£27,795	£29,190	£175	£530	£270	£330	£340	£520	£675
16' x 14' (4.87m x 4.26m)	£16,610	£18,665	£25,250	£30,885	£32,430	£200	£570	£315	£395	£360	£550	£720
18' x 14' (5.48m x 4.26m)	£18,315	£20,520	£27,650	£33,960	£35,660	£215	£615	£315	£395	£380	£585	£760
20' x 14' (6.09m x 4.26m)	£20,020	£22,375	£30,050	£37,040	£38,895	£230	£660	£315	£395	£395	£615	£800
22' x 14' (6.70m x 4.26m)	£21,775	£23,555	£32,450	£40,115	£42,125	£255	£710	£375	£475	£420	£650	£830
24' x 14' (7.31m x 4.26m)	£23,430	£26,080	£34,850	£43,200	£45,365	£275	£750	£470	£585	£435	£675	£875
Additional 2ft	£1,705	£1,855	£2,400	£3,075	£3,230	£20	£50	£35	£40	£20	£35	£45

Partition for Denby Combination (Please note only one side is timber boarded)									
6'ft (1.82m)	£435	8'ft (2.43m)	£520	10'ft (3.04m)	£665	12ft (3.65m)	£825	14ft (4.26m)	£975
Door not included									

Partition for Dalbury Combination (Please note doors are not included)									
6'ft (1.82m)	£535	8'ft (2.43m)	£700	10'ft (3.04m)	£870	12ft (3.65m)	£1,060	14ft (4.26m)	£1,200
Internal Door £345									

Our internally complete Elite garden rooms include 50mm insulation in the walls and ceiling, MDF internal cladding, and laminate flooring.

Price for Composite Denby/Dalbury Canopy - Includes Rear Panel As Standard

Standard (Per 2ft)			Half Return			Full Return			
Gable	Painted	Composite	Cedar	Painted	Composite	Cedar	Painted	Composite	Cedar
6ft (1.82m)	£370	£725	£1,025	£275	£695	£1,045	£535	£1,380	£2,090
8ft (2.43m)	£500	£875	£1,160	£340	£870	£1,310	£665	£1,715	£2,610
10ft (3.04m)	£630	£1,025	£1,305	£400	£1,040	£1,575	£805	£2,060	£3,130
12ft (3.65m)	£770	£1,170	£1,440	£470	£1,210	£1,780	£940	£2,400	£3,650
14ft (4.26m)	£900	£1,315	£1,585	£535	£1,380	£2,095	£1,065	£2,740	£4,170

Dalbury Wings		
	2ft	4ft
Painted	£640	£1,275
Composite	£1,605	£2,240
Cedar	£3,200	£4,800

Dalbury Front Roof Overhang		
	2ft	4ft
Painted	£60 per 2ft	£155 per 2ft
Composite	£100 per 2ft	£230 per 2ft
Cedar	£145 per 2ft	£350 per 2ft

DALBURY EVERFRAME

Includes: Entire steel frame, steel frame base, Kingspan floor, Kingspan roof, plastered interior, Klasse insulation boards, guttering, and plinth kit.

6ft Gable	Composite	Fluted
8' x 6' (2.43m x 1.82m)	£9,895	£10,635
10' x 6' (3.04m x 1.82m)	£11,545	£12,410
12' x 6' (3.65m x 1.82m)	£13,195	£14,185
14' x 6' (4.26m x 1.82m)	£14,845	£15,960
16' x 6' (4.87m x 1.82m)	£16,495	£17,730
18' x 6' (5.48m x 1.82m)	£18,145	£19,505
20' x 6' (6.09m x 1.82m)	£19,795	£21,280
22' x 6' (6.70m x 1.82m)	£21,445	£23,055
24' x 6' (7.31m x 1.82m)	£23,095	£24,825
Additional 2ft	£1,865	£2,005
8ft Gable	Composite	Fluted
8' x 8' (2.43m x 2.43m)	£11,545	£12,410
10' x 8' (3.04m x 2.43m)	£13,195	£14,185
12' x 8' (3.65m x 2.43m)	£14,845	£15,960
14' x 8' (4.26m x 2.43m)	£16,495	£17,730
16' x 8' (4.87m x 2.43m)	£18,145	£19,505
18' x 8' (5.48m x 2.43m)	£19,795	£21,280
20' x 8' (6.09m x 2.43m)	£21,445	£23,055
22' x 8' (6.70m x 2.43m)	£23,095	£24,825
24' x 8' (7.31m x 2.43m)	£24,745	£26,600
Additional 2ft	£2,065	£2,220
10ft Gable	Composite	Fluted
8' x 10' (2.43m x 3.04m)	£13,195	£14,185
10' x 10' (3.04m x 3.04m)	£14,845	£15,960
12' x 10' (3.65m x 3.04m)	£17,135	£18,420
14' x 10' (4.26m x 3.04m)	£19,245	£20,690
16' x 10' (4.87m x 3.04m)	£21,445	£23,055
18' x 10' (5.48m x 3.04m)	£23,645	£25,420
20' x 10' (6.09m x 3.04m)	£25,845	£27,785
22' x 10' (6.70m x 3.04m)	£28,045	£30,150
24' x 10' (7.31m x 3.04m)	£30,245	£32,515
Additional 2ft	£2,230	£2,395

12ft Gable	Composite	Fluted
8' x 12' (2.43m x 3.65m)	£14,845	£15,960
10' x 12' (3.04m x 3.65m)	£16,495	£17,730
12' x 12' (3.65m x 3.65m)	£20,345	£21,870
14' x 12' (4.26m x 3.65m)	£24,745	£26,600
16' x 12' (4.87m x 3.65m)	£28,045	£30,150
18' x 12' (5.48m x 3.65m)	£29,990	£32,240
20' x 12' (6.09m x 3.65m)	£32,995	£35,470
22' x 12' (6.70m x 3.65m)	£35,745	£38,425
24' x 12' (7.31m x 3.65m)	£38,495	£41,380
Additional 2ft	£2,745	£2,950
14ft Gable	Composite	Fluted
8' x 14' (2.43m x 4.26m)	£17,045	£18,325
10' x 14' (3.04m x 4.26m)	£20,345	£21,870
12' x 14' (3.65m x 4.26m)	£24,745	£26,600
14' x 14' (4.26m x 4.26m)	£29,695	£31,920
16' x 14' (4.87m x 4.26m)	£33,545	£36,060
18' x 14' (5.48m x 4.26m)	£37,945	£40,790
20' x 14' (6.09m x 4.26m)	£41,795	£44,930
22' x 14' (6.70m x 4.26m)	£43,995	£47,295
24' x 14' (7.31m x 4.26m)	£45,645	£49,070
Additional 2ft	£3,295	£3,540

The Kingsley (Includes Felt Tiled Roof & MDF Internals)										
Size	Factory Painted	Cedar	Insulated Floor	Guttering & Downpipe (Black/White)	Bearers	Plastic Bearers	Plinth Kit		Cedar Slats	Cedar Shingles/ Slate Eco Tiles
							Painted	Cedar		
8'x8' (2.43m x 2.43m)	£10,530	£17,385	£290	£460	£155	£185	£195	£385	£1,495	£1,940*(no eco tiles)
10'x10' (3.04m x 3.04m)	£14,045	£23,185	£350	£500	£210	£205	£210	£415	£1,745	£2,465
12'x12' (3.65m x 3.65m)	£17,565	£28,985	£420	£540	£255	£295	£220	£435	£1,970	£2,980

* Eco Slate Tiles - not available on an 8x8 Kingsley

Size	COMPOSITE HARRINGTON	HUNTINGTON (Internally complete)			OPTIONAL EXTRAS FOR HARRINGTON OR HUNTINGTON						
		Factory Painted	Composite	Cedar	Insulated Floor	Guttering & Downpipe (Black/White)	Bearers	Plastic Bearers	Plinth Kit		
									Painted	Composite	Cedar
8'x8' (2.43m x 2.43m)	£6,745	£6,925	£9,635	£11,420	£290	£175	£155	£185	£110	£170	£230
9'x9' (2.74m x 2.74m)	£8,265	£7,895	£11,810	£14,005	£330	£220	£170	£205	£130	£210	£270
10'x10' (3.04m x 3.04m)	£9,370	£10,045	£13,980	£16,575	£380	£255	£170	£205	£145	£235	£310
11'x11' (3.35m x 3.35m)	£11,315	£11,605	£16,165	£18,055	£425	£295	£240	£295	£155	£270	£345
12'x12' (3.65m x 3.65m)	£12,835	£13,160	£18,335	£20,710	£470	£330	£240	£295	£165	£300	£385

The Walton (Includes Felt Tiles & MDF Internals)												
6ft Gable	Factory Painted	Composite	Cedar	Insulated Floor	Guttering & Downpipe (Black/White)	Bearers	Plastic Bearers	Plinth Kit			Cedar Slats	Cedar Shingles/ Slate Eco Tiles
								Painted	Composite	Cedar		
8'x6' (2.43m x 1.82m)	£5,985	£7,930	£9,880	£250	£235	£115	£145	£155	£230	£310	£665	£1,130
10'x6' (3.04m x 1.82m)	£7,140	£9,460	£11,785	£295	£270	£140	£165	£170	£265	£345	£780	£1,495
12'x6' (3.65m x 1.82m)	£8,295	£10,995	£13,690	£340	£300	£180	£220	£195	£295	£385	£955	£1,860
14'x6' (4.26m x 1.82m)	£9,450	£12,525	£15,595	£385	£330	£180	£220	£215	£325	£425	£1,110	£2,230
16'x6' (4.87m x 1.82m)	£10,605	£14,055	£17,500	£430	£370	£255	£300	£230	£360	£460	£1,265	£2,590
18'x6' (5.48m x 1.82m)	£11,760	£15,585	£19,405	£475	£395	£255	£300	£250	£390	£500	£1,425	£2,960
20'x6' (6.09m x 1.82m)	£12,915	£17,110	£21,310	£520	£430	£255	£300	£270	£425	£540	£1,585	£3,320
22'x6' (6.70m x 1.82m)	£14,060	£18,645	£23,220	£565	£460	£295	£360	£290	£455	£580	£1,745	£3,690
24'x6' (7.31m x 1.82m)	£15,225	£20,175	£25,120	£610	£495	£400	£480	£315	£490	£615	£1,905	£4,060
Additional 2ft	£1,155	£1,535	£1,910	£50	£35	£35	£40	£20	£35	£45	£160	£370

Our internally complete Elite garden rooms include 50mm insulation in the walls and ceiling, MDF internal cladding, and laminate flooring.

8ft Gable	Factory Painted	Composite	Cedar	Insulated Floor	Guttering & Downpipe (Black/White)	Bearers	Plastic Bearers	Plinth Kit			Cedar Slats	Cedar Shingles/ Slate Eco Tiles
								Painted	Composite	Cedar		
8' x 8' (2.43m x 2.43m)	£6,865	£9,100	£11,330	£290	£235	£155	£185	£180	£285	£375	£780	£1,475
10' x 8' (3.04m x 2.43m)	£8,105	£10,745	£13,380	£330	£270	£155	£195	£210	£315	£415	£955	£1,845
12' x 8' (3.65m x 2.43m)	£9,355	£12,395	£15,440	£380	£300	£220	£265	£225	£345	£450	£1,155	£2,210
14' x 8' (4.26m x 2.43m)	£10,600	£14,040	£17,490	£2,770	£425	£330	£265	£240	£380	£490	£1,355	£2,575
16' x 8' (4.87m x 2.43m)	£11,845	£15,690	£19,540	£3,020	£470	£270	£330	£265	£415	£530	£1,490	£2,945
18' x 8' (5.48m x 2.43m)	£13,085	£17,340	£21,595	£3,245	£510	£270	£330	£285	£445	£565	£1,700	£3,300
20' x 8' (6.09m x 2.43m)	£14,335	£18,990	£23,645	£3,485	£560	£270	£330	£300	£475	£605	£1,910	£3,675
22' x 8' (6.70m x 2.43m)	£15,575	£20,640	£25,700	£3,725	£605	£315	£385	£325	£505	£645	£2,160	£4,030
24' x 8' (7.31m x 2.43m)	£16,825	£22,285	£27,755	£3,960	£650	£425	£510	£340	£540	£675	£2,390	£4,400
Additional 2ft	£1,250	£1,650	£2,055	£145	£50	£35	£40	£20	£255	£45	£160	£370
10ft Gable	Factory Painted	Composite	Cedar	Insulated Floor	Guttering & Downpipe (Black/White)	Bearers	Plastic Bearers	Plinth Kit			Cedar Slats	Cedar Shingles/ Slate Eco Tiles
								Painted	Composite	Cedar		
8' x 10' (2.43m x 3.04m)	£8,260	£10,955	£13,640	£320	£235	£170	£205	£225	£340	£450	£955	£1,845
10' x 10' (3.04m x 3.04m)	£9,580	£12,700	£15,820	£370	£270	£170	£205	£240	£375	£490	£1,105	£2,210
12' x 10' (3.65m x 3.04m)	£10,905	£14,455	£17,995	£415	£300	£225	£275	£265	£400	£530	£1,320	£2,575
14' x 10' (4.26m x 3.04m)	£12,225	£16,205	£20,185	£455	£330	£225	£275	£285	£435	£565	£1,540	£2,945
16' x 10' (4.87m x 3.04m)	£13,545	£17,960	£22,365	£500	£370	£285	£350	£300	£470	£605	£1,700	£3,300
18' x 10' (5.48m x 3.04m)	£14,865	£19,705	£24,545	£545	£395	£285	£350	£325	£500	£645	£2,130	£3,670
20' x 10' (6.09m x 3.04m)	£16,190	£21,460	£26,725	£590	£430	£285	£350	£340	£535	£675	£2,475	£4,030
22' x 10' (6.70m x 3.04m)	£17,510	£23,210	£28,905	£640	£460	£325	£400	£360	£565	£720	£2,755	£4,400
24' x 10' (7.31m x 3.04m)	£18,840	£24,965	£31,090	£675	£495	£435	£530	£380	£595	£760	£3,035	£4,765
Additional 2ft	£1,320	£1,755	£2,180	£50	£35	£35	£40	£20	£35	£45	£160	£370
12ft Gable	Factory Painted	Composite	Cedar	Insulated Floor	Guttering & Downpipe (Black/White)	Bearers	Plastic Bearers	Plinth Kit			Cedar Slats	Cedar Shingles/ Slate Eco Tiles
								Painted	Composite	Cedar		
8' x 12' (2.43m x 3.65m)	£10,375	£13,745	£17,110	£350	£235	£195	£235	£250	£380	£500	£995	£2,180
10' x 12' (3.04m x 3.65m)	£12,040	£15,955	£19,870	£395	£270	£195	£235	£270	£415	£540	£1,260	£2,545
12' x 12' (3.65m x 3.65m)	£13,710	£18,165	£22,620	£445	£300	£240	£295	£290	£445	£580	£1,490	£2,910
14' x 12' (4.26m x 3.65m)	£15,380	£20,370	£25,370	£490	£330	£240	£295	£310	£475	£615	£1,720	£3,280
16' x 12' (4.87m x 3.65m)	£17,050	£22,590	£28,125	£535	£370	£295	£375	£325	£505	£655	£1,940	£3,640
18' x 12' (5.48m x 3.65m)	£18,710	£24,795	£30,875	£580	£395	£295	£375	£345	£540	£695	£2,185	£4,010
20' x 12' (6.09m x 3.65m)	£20,380	£27,005	£33,625	£620	£430	£295	£375	£370	£570	£730	£2,485	£4,380
22' x 12' (6.70m x 3.65m)	£22,050	£29,220	£36,380	£665	£460	£340	£430	£385	£605	£770	£2,790	£4,740
24' x 12' (7.31m x 3.65m)	£23,715	£31,425	£39,130	£715	£495	£450	£555	£400	£640	£810	£3,110	£5,110
Additional 2ft	£1,665	£2,210	£2,750	£50	£35	£35	£40	£20	£35	£45	£160	£370

















14ft Gable	Factory Painted	Composite	Cedar	Insulated Floor	Guttering & Downpipe (Black/White)	Bearers	Plastic Bearers	Plinth Kit			Cedar Slats	Cedar Shingles/ Slate Eco Tiles
								Painted	Composite	Cedar		
8' x 14' (2.43m x 4.26m)	£12,825	£16,995	£21,165	£390	£235	£210	£255	£285	£425	£565	£1,045	£2,540
10' x 14' (3.04m x 4.26m)	£14,680	£19,455	£24,220	£435	£270	£210	£260	£300	£455	£605	£1,385	£2,905
12' x 14' (3.65m x 4.26m)	£16,535	£21,905	£27,280	£2,230	£480	£300	£330	£320	£490	£645	£1,665	£3,275
14' x 14' (4.26m x 4.26m)	£18,385	£24,365	£30,345	£2,370	£530	£330	£330	£340	£520	£675	£1,905	£3,635
16' x 14' (4.87m x 4.26m)	£20,240	£26,825	£33,405	£2,510	£570	£370	£395	£360	£550	£720	£2,190	£4,005
18' x 14' (5.48m x 4.26m)	£22,100	£29,280	£36,465	£2,650	£615	£395	£395	£380	£585	£760	£2,485	£4,365
20' x 14' (6.09m x 4.26m)	£23,940	£31,735	£39,525	£2,795	£660	£430	£395	£395	£615	£800	£2,765	£4,735
22' x 14' (6.70m x 4.26m)	£25,805	£34,200	£42,585	£2,935	£710	£460	£475	£420	£650	£830	£3,110	£5,105
24' x 14' (7.31m x 4.26m)	£27,655	£36,650	£45,645	£3,070	£750	£495	£585	£435	£675	£875	£3,455	£5,465
Additional 2ft	£1,855	£2,460	£3,060	£145	£50	£35	£40	£20	£35	£45	£160	£370

Partition for Walton (please note doors are not included)										
6ft (1.82m)	£645	8ft (2.43m)	£845	10ft (3.04m)	£1,060	12ft (3.65m)	£1,280	14ft (4.26m)	£1,500	
Internal Door £345										

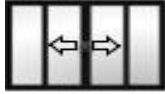

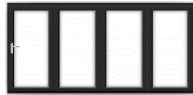





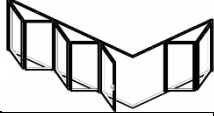
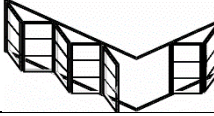
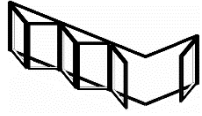
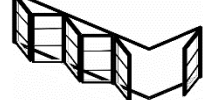





The Dukesbury (Includes Felt Tiled Roof & MDF Internals)												
6ft Gable	Factory Painted	Composite	Cedar	Insulated Floor	Guttering & Downpipe (Black/White)	Bearers	Plastic Bearers	Plinth Kit			Cedar Slats	Cedar Shingles/ Slate Eco Tiles
								Painted	Composite	Cedar		
8' x 6' (2.43m x 1.82m)	£7,905	£10,480	£13,045	£250	£415	£110	£145	£155	£230	£310	£780	£1,220
10' x 6' (3.04m x 1.82m)	£8,790	£11,645	£14,500	£295	£470	£140	£165	£170	£260	£345	£920	£1,570
12' x 6' (3.65m x 1.82m)	£9,675	£12,815	£15,955	£340	£530	£180	£220	£195	£290	£385	£1,130	£1,915
14' x 6' (4.26m x 1.82m)	£10,560	£13,985	£17,410	£385	£585	£180	£220	£215	£320	£425	£1,290	£2,255
16' x 6' (4.87m x 1.82m)	£11,445	£15,160	£18,865	£430	£645	£255	£300	£230	£345	£460	£1,480	£2,600
18' x 6' (5.48m x 1.82m)	£12,330	£16,330	£20,320	£475	£700	£255	£300	£255	£380	£500	£1,660	£2,955
20' x 6' (6.09m x 1.82m)	£13,215	£17,500	£21,780	£515	£755	£255	£300	£275	£405	£540	£1,850	£3,295
22' x 6' (6.70m x 1.82m)	£14,100	£18,670	£23,240	£565	£815	£295	£360	£295	£440	£580	£2,035	£3,640
8ft Gable	Factory Painted	Composite	Cedar	Insulated Floor	Guttering & Downpipe (Black/White)	Bearers	Plastic Bearers	Plinth Kit			Cedar Slats	Cedar Shingles/ Slate Eco Tiles
								Painted	Composite	Cedar		
8' x 8' (2.43m x 2.43m)	£9,495	£12,580	£15,665	£290	£450	£155	£185	£180	£280	£375	£920	£1,570
10' x 8' (3.04m x 2.43m)	£10,460	£13,860	£17,260	£330	£505	£155	£195	£210	£315	£415	£1,130	£1,920
12' x 8' (3.65m x 2.43m)	£11,435	£15,145	£18,860	£380	£565	£220	£265	£225	£340	£450	£1,360	£2,270

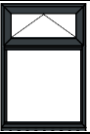









14' x 8' (4.26m x 2.43m)	£12,385	£16,425	£20,460	£425	£620	£220	£265	£240	£370	£490	£1,590	£2,625
16' x 8' (4.87m x 2.43m)	£13,370	£17,715	£22,055	£470	£675	£285	£330	£265	£395	£530	£1,755	£2,975
18' x 8' (5.48m x 2.43m)	£14,340	£18,995	£23,655	£510	£735	£285	£330	£285	£430	£565	£1,995	£3,335
20' x 8' (6.09m x 2.43m)	£15,305	£20,280	£25,250	£560	£800	£285	£330	£300	£455	£605	£2,245	£3,685
22' x 8' (6.70m x 2.43m)	£16,170	£21,510	£26,850	£605	£860	£345	£385	£320	£485	£645	£2,540	£4,035
10ft Gable	Factory Painted	Composite	Cedar	Insulated Floor	Guttering & Downpipe (Black/White)	Bearers	Plastic Bearers	Plinth Kit			Cedar Slats	Cedar Shingles/ Slate Eco Tiles
								Painted	Composite	Cedar		
8' x 10' (2.43m x 3.04m)	£11,065	£14,670	£18,265	£320	£505	£170	£205	£225	£340	£450	£1,130	£1,920
10' x 10' (3.04m x 3.04m)	£12,210	£16,180	£20,150	£370	£565	£170	£205	£240	£370	£490	£1,305	£2,275
12' x 10' (3.65m x 3.04m)	£13,365	£17,710	£22,050	£415	£620	£225	£275	£265	£395	£530	£1,550	£2,640
14' x 10' (4.26m x 3.04m)	£14,510	£19,230	£23,940	£455	£675	£225	£275	£285	£430	£565	£1,810	£2,990
16' x 10' (4.87m x 3.04m)	£15,660	£20,745	£25,835	£500	£735	£285	£350	£300	£455	£605	£1,995	£3,355
18' x 10' (5.48m x 3.04m)	£16,810	£22,270	£27,725	£545	£800	£285	£350	£325	£485	£645	£2,500	£3,715
20' x 10' (6.09m x 3.04m)	£17,960	£23,790	£29,620	£590	£855	£285	£350	£340	£510	£675	£2,690	£4,075
22' x 10' (6.70m x 3.04m)	£19,100	£25,305	£31,510	£640	£910	£325	£400	£360	£540	£720	£2,910	£4,435
12ft Gable	Factory Painted	Composite	Cedar	Insulated Floor	Guttering & Downpipe (Black/White)	Bearers	Plastic Bearers	Plinth Kit			Cedar Slats	Cedar Shingles/ Slate Eco Tiles
								Painted	Composite	Cedar		
8' x 12' (2.43m x 3.65m)	£13,010	£17,240	£21,470	£350	£570	£195	£235	£250	£375	£500	£1,170	£2,275
10' x 12' (3.04m x 3.65m)	£14,335	£18,990	£23,645	£395	£625	£195	£235	£270	£405	£540	£1,480	£2,625
12' x 12' (3.65m x 3.65m)	£15,655	£20,740	£25,825	£445	£690	£240	£295	£290	£435	£580	£1,755	£2,970
14' x 12' (4.26m x 3.65m)	£16,980	£22,490	£27,995	£490	£745	£240	£295	£310	£460	£615	£2,025	£3,315
16' x 12' (4.87m x 3.65m)	£18,295	£24,235	£30,170	£535	£805	£295	£375	£325	£490	£655	£2,280	£3,665
18' x 12' (5.48m x 3.65m)	£19,620	£25,980	£32,345	£580	£865	£295	£375	£345	£520	£695	£2,570	£4,010
20' x 12' (6.09m x 3.65m)	£20,940	£27,730	£34,520	£620	£915	£295	£375	£370	£555	£730	£2,925	£4,355
22' x 12' (6.70m x 3.65m)	£22,265	£29,480	£36,695	£665	£975	£340	£430	£385	£580	£770	£3,285	£4,700



DOOR OPTIONS

Single Glazed Door (890mm W x 2008mm H)		Single Solid Door (890mm W x 2008mm H)		Single Transom Door (890mm W x 2008mm H)		Single Door (with side panel) (1233mm W x 2008mm H)	
							
Aluminium	£1,475	Aluminium	N/A	Aluminium	£1,735	Aluminium	N/A
UPVC	£755	UPVC	£965	UPVC	N/A	UPVC	£1,135
Blinds	£475	Blinds	N/A	Blinds	N/A	Blinds	N/A
4ft Double Door (1233mm W x 2008mm H)		4ft Transom Double Door (1233mm W x 2008mm H)		5ft Double Door (1653mm W x 2008mm H)		5ft Transom Double Door (1653mm W x 2008mm H)	
							
Aluminium	£2,300	Aluminium	£2,810	Aluminium	£2,425	Aluminium	£2,945
UPVC	£1,530	UPVC	N/A	UPVC	£1,625	UPVC	N/A
Blinds	£690	Blinds	N/A	Blinds	£770	Blinds	N/A
2.4M Patio Doors (Sliders) (2400mm W x 1970mm H)		3M Patio Doors (Sliders) (3000mm W x 1970mm H)		3.6M Patio Doors (Sliders) (3600mm W x 1970mm H)		3M Bi-Fold Doors (3000mm W x 2000mm H)	
							
Aluminium	£3,245	Aluminium	£4,225	Aluminium	£7,115	Aluminium	£3,705
UPVC	£2,465	UPVC	£2,630	UPVC	£5,250	UPVC	N/A
Blinds	£1,135	Blinds	£1,665	Blinds	£1,985	Blinds	£1,465
4M Bi-Fold Doors (4000mm W x 2000mm H)		5M Bi-Fold Doors (5000mm W x 2000mm H)		3M Transom Bi-Fold Doors (3000mm W x 2000mm H)		4M Transom Bi-Fold Doors (4000mm W x 2000mm H)	
							
Aluminium	£5,120	Aluminium	£6,400	Aluminium	£4,475	Aluminium	£6,150
Blinds	£1,945	Blinds	£2,435	Blinds	N/A	Blinds	N/A

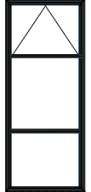
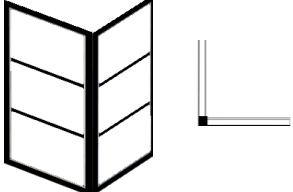
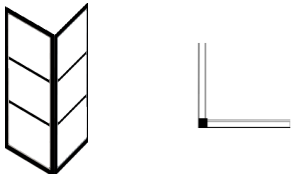
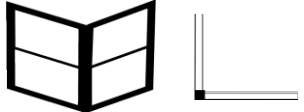
5M Transom Bi-Fold Doors (5000mm W x 2000mm H)		Corner Bi-Fold Doors (3m x 2m)		Transom Corner Bi-Fold Doors (3m x 2m)		Corner Bi-Folds (3m x 1m)		Transom Corner Bi-Folds (3m x 1m)	
									
Aluminium Bi-folds	£7,685	Aluminium Bi-Fold Doors (Only available in 14/16' gable)	£9,500	Aluminium Bi-Fold Doors (Only available in 14/16' gable)	£10,680	Aluminium Bi-Fold Doors (Only available from 10' Gable)	£9,500	Aluminium Bi-Fold Doors (Only available from 10' gable)	£10,680
Blinds	N/A	Blinds	£2,435	Blinds	N/A	Blinds	£2,435	Blinds	N/A

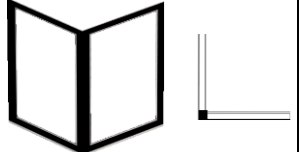
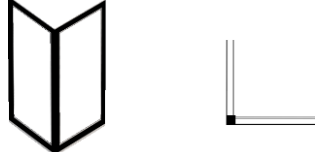
WINDOW OPTIONS									
T1 Casement Window (585mm W x 1200mm H)		A1 Transom Casement Window (585mm W x 1200mm H)		T1 LEA Casement Window (585mm W x 1200mm H)		A1 LEA Transom Casement (585mm W x 1200mm H)		T2 Casement Window (795mm W x 1200mm H)	
									
Aluminium (A1)	£500	Aluminium (A1)	£585	Aluminium (A1 LEA)	£965	Aluminium (A1LEA)	£1,090	Aluminium (A2)	£500
UPVC (T1)	£240	UPVC	N/A	UPVC (T1LEA)	£365	UPVC	N/A	UPVC (T2)	£270
Blinds	£330	Blinds	N/A	Blinds	£615	Blinds	N/A	Blinds	£360
A2 Transom Casement Window (795mm W x 1200mm H)		T2 LEA Casement Window (795mm W x 1200mm H)		A2 LEA Transom Casement Window (795mm W x 1200mm H)		T3 LEA Casement Window (1200mm W x 795mm H)		T8 Casement Window (585mm W x 1530mm H)	
									
Aluminium (A2)	£640	Aluminium (A2LEA)	£1,020	Aluminium (A2 LEA)	£1,140	Aluminium	N/A	Aluminium (A8)	£540
UPVC	N/A	UPVC (T2LEA)	£395	UPVC	N/A	UPVC (T3LEA)	£395	UPVC (T8)	£270
Blinds	N/A	Blinds	£640	Blinds	N/A	Blinds	£640	Blinds	£345
T8 LEA Casement Window (585mm W x 1530mm H)		T8 Full Opening Casement Window (585mm W x 1530mm H)		T10 Casement Window (585mm W x 2008mm H)		T10 LEA Casement Window (585mm W x 2008mm H)		A10 Transom Casement Window (585mm W x 2008mm H)	
									
Aluminium (A8LEA)	£1,050	Aluminium (A8FO)	£950	Aluminium (A10)	£630	Aluminium (A10LEA)	£1,140	Aluminium (A10)	£885
UPVC (T8LEA)	£375	UPVC (T8FO)	£475	UPVC (T10)	£275	UPVC (T10LEA)	£435	UPVC	N/A
Blinds	£625	Blinds	£325	Blinds	£380	Blinds	£660	Blinds	N/A
				Panoramic Blinds	£545				

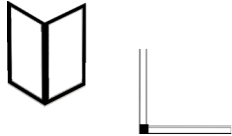
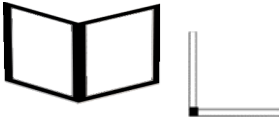
A10 LEA Transom Casement Window (585mm W x 2008mm H)		T12 Casement Window (795mm W x 1530mm H)		T12 LEA Casement Window (795mm W x 1530mm H)		T12 Full Opening Casement Window (795mm W x 1530mm H)		Top Hopper Casement Window (795mm W x 440mm H)	
									
Aluminium (A10LEA)	£1,395	Aluminium (A12)	£625	Aluminium (A12LEA)	£1,140	Aluminium (A12FO)	£1,010	Aluminium(ATOP)	£755
UPVC	N/A	UPVC (T12)	£310	UPVC (T12LEA)	£475	UPVC (T12FO)	£435	UPVC (TTOP)	£225
Blinds	N/A	Blinds	£385	Blinds	£660	Blinds	£360	Blinds	£310
T15 Casement Window (795mm W x 2008mm H)		T15LEA Casement Window (795mm W x 2008mm H)		A15 Transom Casement Window (795mm W x 2008mm H)		A15 LEA Transom Casement Window (795mm W x 2008mm H)		C15 Corner Transom Window (Full Length) (795mm W x 2008mm H)	
									
Aluminium (A15)	£730	Aluminium (A15LEA)	£1,250	Aluminium (A15)	£985	Aluminium (A15LEA)	£1,530	Aluminium	£2,405
UPVC (T15)	£295	UPVC (T15LEA)	£510	UPVC	N/A	UPVC	N/A	Per Additional Top opener	+£510
Blinds	£495	Blinds	£785	Blinds	N/A	Blinds	N/A	Blinds	N/A
Panoramic Blinds	£555								
C10 Corner Transom Window (Full Length) (585mm W x 2008mm H)		C2 Corner Transom Window (Half Length) (795mm W x 1195mm H)		C1 Corner Transom Window (Half Length) (585mm W x 1195mm H)		C15 Corner Window (Full Length) (795mm W x 2008mm H)		C10 Corner Window (Full Length) (585mm W x 2008mm H)	
									
Aluminium	£2,170	Aluminium	£1,660	Aluminium	£1,535	Aluminium	£1,920	Aluminium	£1,790
Per Additional Top Opener	+£510	Per Additional Top Opener	+£510	Per Additional Top Opener	+£510	Per Additional Top Opener	+£510	Per Additional Top Opener	+£510
Blinds	N/A	Blinds	N/A	Blinds	N/A	Blinds	£1,010	Blinds	£760
						Blinds Per Top Opener	+£280	Blinds Per Top Opener	+£280

C1 Corner Window (Half Length) (585mm W x 1195mm H)		C2 Corner Window (Half Length) (795mm W x 1195mm H)		Flat Roof Lights 1400mm x 1000mm approx.		INFORMATION	
						Corner Aluminium Bi-Fold Doors (3m x 2m)	Only available in 14'/16' gable
						Corner Aluminium Bi-Fold Doors (3m x 1m)	Unavailable on 6' or 8' gable
						Panoramic Blinds (T10 and T15)	Require a joining transom bar due to the width of the casement
Aluminium	£1,275	Aluminium	£1,410	Aluminium	£2,695	*Additional Bi-Fold Cost	Bi-folds on selected models (Walton and Dukesbury) add 5% of the building cost
Additional Top Opener	+£510	Additional Top Opener	+£510				
Blinds	£665	Blinds	£995	(Electric) Blinds	Included	* Transoms are the horizontal bars which divide the unit into smaller panes for decorative purposes	
Blinds Per Top Opener	+£280	Blinds Per Top Opener	+£280				

EXTRAS	
Frosted Glass	5% on top of Windows or Door Cost
UPVC Georgian Bars	5% on top of Windows or Door Cost
Internal Wall Panelling	£140 per 2ft
Teknos Paint	£30 per litre
Cedar Oil	£30 per litre
Timber frame bases – suitable for hardstanding areas ONLY	£5 per SQF (fitted)
Composite Decked Area	£15 per SQF (fitted)
Split Sections	7% of building cost
Boards Higher	1 board – 5% on top of building cost 2 boards – 9% on top of building cost 3 boards – 12% on top of building cost
Concealed Nailing (Painted timber only)	16% on top of building cost
Plastered Interior	Painted - 28% on top of building cost Composite - 20% on top of building cost Cedar - 15% on top of building cost
Timber Tongue & Groove Internals	5% on top of building cost