

Cub Cadet



**YOUR BEST
LAWN AWAITS.**

2026 CUB CADET CATALOGUE

A LAWN OF POSSIBILITIES.

Cub Cadet equipment delivers the ultimate in productivity through a combination of sustained power, detailed precision and control. Innovation drives the design, engineering and function of every Cub Cadet and we've been backing this up for decades by building products that work hard at maintaining your lawn and garden.

We pride ourselves on providing our customers with quality products that are comfortable to use and exceed your expectations.

Want to experience the ultimate and control for yourself? Book a test drive with your local Cub Cadet Dealer today.

Visit cubcadet.com.au to learn more.



TABLE OF CONTENTS

Residential Riders Advantages	4-5
CC30 Mini Series	6-7
XT1 Enduro Series™	8-9
XT2 Enduro Series™	10-11
Ultima Series™	12-13
Ultima Series™ Advantages	14-15
Ultima ZT™ Series	16-17
Ultima ZTS™ Series	18-19
Ultima ZTX™ Series	20-21
Ultima ZTXS™ Series	22-23
Commercial PRO Series	24-25
PRO Z™ Series	26-27
PRO Z™ 700 S & 900 S Series	28-29
PRO Z™ 900 SD & 900 SDL Series	30-31
PRO Z™ Comfort	32-33
PRO Z™ Strength	34-35
PRO Z™ Performance	36-37
Attachments & Accessories	38-39
Full Specifications	40-47

STRENGTH BUILT INTO EVERY DETAIL.

From the moment you buy to the moment you mow, Cub Cadet is committed to providing an excellent experience that comes with our Residential Rider range.

From our compact CC30 Mini Series to our feature packed XT Enduro Series™, we have a ride on to suit your needs.

Take a look at our Cub Cadet Rider's advantages, all tailored to help you achieve your best lawn yet.

VERSATILE, DURABLE RIDING MOWERS

Cub Cadet ride on lawn mowers range from small riders to lawn tractors, each engineered to deliver the strength and durability to tackle your yard with ease.



CC30 MINI SERIES

Cub Cadet small riding lawn mowers are designed to deliver a premium cut but in a compact size to fit through and be stored in small spaces.

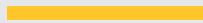

Mostly Flat



Low back or high-open back seat

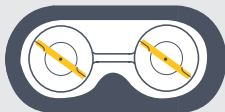

Stamped decks



Up to 6.4km/h

XT1 ENDURO SERIES™

The value model of the Enduro Series, the XT1 range of ride on mowers XT1 models are loaded from the start to deliver excellent mowing results.



Mostly Flat



High back seat

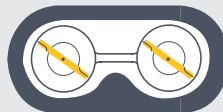

Stamped decks



Up to 8.6km/h

XT2 ENDURO SERIES™

The Enduro XT2 offers a more premium experience with higher levels of power, performance and comfort.



Slight hills, mostly Flat

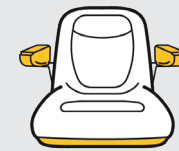

High back seat w/armrests



Up to 8.6km/h



Fabricated decks



Front bumper

COMPACT YET POWERFUL.

Designed to deliver a premium cut without the large size, the CC30's frame is the ideal choice for those with limited storage space such as garages or small sheds. It allows for easier manoeuvrability in tight areas, helping to provide efficient lawn care even in challenging corners or narrow spaces.

These compact mowers are specifically engineered to fit through standard-sized garden gates and doors, eliminating the hassle of removing fences or other obstacles for storage.

The CC30 range is light and manoeuvrable, allowing for easy navigation and convenient storage, making them a practical and space-saving solution for homeowners with limited outdoor space.

▶ Compact Deck

With a smaller 76cm (30") deck, the CC30 Mini Series is ideal for fitting into smaller spaces, ideal for those with smaller yards and limited storage areas.

▶ Added Extras and Comfort

The CC30 Mini Series comes standard with LED headlights that provide better visibility in low light conditions, as well as telescopic steering designed to suit different user heights. The CC30 HX also features a high-open back seat for added comfort, front bumper bar to help protect the front of the rider, and a standard mulch kit.

▶ Strong Warranties

- Unit: 6-year domestic & 90 day commercial warranty.
- Engine: 6-year domestic & 90 day commercial warranty.

CC 30 MINI SERIES



• CC30 H



• CC30 HX





A CUT ABOVE.

The XT1 is the industry benchmark with power, comfort and control for the ultimate mowing experience. Packed with features, the XT1 Enduro Series is ideally equipped for easy mowing and towing around the yard.

▶ Power On A Whole New Level

Choose between a 547cc Cub Cadet engine with IntelliPower™ technology or powerful Kawasaki® engines that power the responsive, automotive-inspired handling.

▶ Advanced Cutting Performance

A muscular cutting system featuring a 107cm (42") stamped decks built with heavy-duty material and an advanced belt design ensures durability and reliability.

▶ Responsive Handling

With a tight 16" turning circle that enables you to manoeuvre around obstacles on your lawn, the XT1's steering system delivers optimised command and control at every turn.

▶ Added Comfort

High-back seats, comfort-grip steering and overall ergonomics are designed to keep you comfortable for extended periods.

▶ Strong Warranties

- Unit: 6-year domestic & 90 day commercial warranty.
- Engine: 6-year domestic & 90 day commercial warranty.

XT1™

ENDURO SERIES™



• **XT1 42 IP**
IntelliPower™



• **XT1 18/42**



• **XT1 21/42**



INTELLIPOWER™

OPTIMIZED PERFORMANCE

The XT1 42 IP with IntelliPower™ Technology delivers up to 18% more available power*, resulting in less bogging down when mowing in challenging conditions like tall, thick, or wet grass.

*When compared to a Cub Cadet 547cc engine without the INTELLIPOWER™ feature. Improvements vary depending on engine models and specific operating conditions.



PREMIUM AND POWERFUL.

The XT2 Enduro Series range is ideal for more challenging terrain with the addition high-back seats with armrests for added comfort, and greater front end protection with a standard front bumper or brush guard (XT2 54 K).

▶ Excellent Comfort

Soft-Touch steering wheel plus a high-back seat and armrests for additional comfort.

▶ Powerful Engines

Choose from a 679cc Cub Cadet engine or 21.5HP through to 24HP Kawasaki® engines.

▶ Improved Traction

Multi-Trac tyres designed to minimise slippage.

▶ Durability

Front wheel bearings for low-friction tyre and wheel rotation, as well as front bumper or brush guard (available on the XT2 54 K).

▶ Premium Cut

A lineup of heavy-duty fabricated AeroForce™ decks engineered for optimal airflow and suction that helps prevent clumping during discharge and provides excellent bagging performance.

▶ High Lift Blades

Provides optimal side-discharge grass dispersion and bagging performance.

▶ Strong Warranties

- Unit: 6-year domestic & 90 day commercial warranty.
- Engine: 6-year domestic & 90 day commercial warranty.

XT2™

ENDURO SERIES™



- XT2 42 EFI
- XT2 42 K



- XT2 46 K



- XT2 54 K



ULTIMA



SERIES™



STEP UP TO A MOWING
EXPERIENCE UNLIKE ANY OTHER:
THE ULTIMA SERIES™

ULTIMA SERIES

THE ULTIMATE ALL-AROUND MOWING EXPERIENCE.



Forged for Strength and Durability

- A:** Continuous tubular steel frame
- B:** Premium Cub Cadet® or Kawasaki® Engine options



All Around Comfort

- C:** Spring seat suspension
- D:** Ample legroom on all units
- E:** Lap bars or intuitive Soft-Touch steering wheel with adjustable steering column
- F:** Automotive-inspired, comfortable and adjustable high-back seat

STEERING OPTIONS DESIGNED TO MEET YOUR NEEDS



Lap Bars

Moulded and adjustable rubber hand grips designed to generate less vibration.



Steering Wheel

Cub Cadet's exclusive Synchro-Steer™ technology offers professional-grade precision, control, and stability, providing a familiar user experience even on hills up to 20 degrees.



Cut Quality

- G:** Stamped & fabricated steel deck options available
- H:** 15 quarter-inch deck height adjustments

- I:** Offset front axle on all lap bar units designed for precise trimming
- J:** Turf Master® rear tyres, designed for stability and traction

Maintain With Ease

- K:** Maintenance-free spindles
- L:** Hinged floor pan for maintenance needs
- M:** Strong warranty, including deck shell and frame

RESHAPING THE LANDSCAPE.

Step up to the ultimate all-around mowing experience with unrivalled strength, comfort and performance bringing you one step closer to your best lawn yet.

▶ **Tough Build**

A continuous 5cm x 5cm tubular steel frame with protective e-coat on its lower end gives you optimal durability and strength with automotive-grade corrosion resistance for long-lasting use.

▶ **Redefined Comfort**

An automotive-inspired, high-back seat (armrests available on the ZT2 54), ergonomic hand grips and a rubber floor mat let you comfortably cut at a maximum forward speed of up to 11km/h.

▶ **Excellent Cut**

Independently tested and proven, stamped or fabricated decks in combination with 15-position deck height adjustment options and an offset front axle, deliver a best-in-class cut with fewer clumps, finer clippings and increased evenness.

▶ **Easy Maintenance**

Highly accessible hinged floor pan for easy deck access and maintenance-free spindles make routine servicing quick and simple.

▶ **Strong Warranties**

- Unit: 3-year domestic & 90 day commercial warranty.
- Engine: 3-year domestic & 90 day commercial warranty.
- Deck: 5-year fabricated deck shell domestic warranty (ZT1 42, ZT1 46 & ZT2 54 only).

ULTIMA ZT™ SERIES



• **ZT1 42 IP**



• **ZT1 42 V**



• **ZT1 42**
• **ZT1 46**



• **ZT2 54**





RESIDENTIAL: ULTIMA ZT™ SERIES

Cub Cadet

STEER IT TO BELIEVE IT.

The Ultima ZTS brings Cub Cadet's innovative and proprietary Synchro-Steer™ technology to the proven Ultima Series™ platform. Engineered for precision and confident control on hills - all backed by the strength, comfort and cut quality of a Cub Cadet zero-turn.

▶ Excellent Control

Step up your control from traditional lap bars with Synchro-Steer™ technology. The familiar steering wheel experience plus four-wheel control makes for precision, manoeuvrability and stability on a variety of terrains including hills of up to 20 degrees.

▶ Tougher Than Tough

A continuous 5cm x 5cm tubular steel frame designed for strength and corrosion defense with e-coat is built for durability for years to come.

▶ Powerful Performance

Power through tasks with twin-cylinder Cub Cadet or Kawasaki® engines.

▶ First-Class Comfort

Enjoy easy steering and single-handed operation with Synchro-Steer™ technology and a soft-touch steering wheel with adjustable steering column for intuitive control. Plus, an automotive-inspired high-back seat.

▶ Strong Warranties

- Unit: 3-year domestic & 90 day commercial warranty.
- Engine: 3-year domestic & 90 day commercial warranty.
- Deck: 5-year fabricated deck shell domestic warranty (ZTS1 42 & ZTS 46 only).

ULTIMA ZTS™ SERIES



• ZTS1 42



• ZTS1 42 V



• ZTS1 46



STEP UP TO THE CHALLENGE.

The professional-grade build of the Ultima ZTX range of zero turns deliver enhanced strength and durability so you can comfortably cut at maximum speed through the most challenging conditions.

► Strength On Deck

Built on a 3.8cm x 7.6cm tubular frame and featuring a 10-gauge steel fabricated AeroForce Max™ deck with side, top and leading-edge reinforcements and bagging capabilities, you will be equipped with the right amount of strength and rigidity for consistent, productive mowing.

► Powerful Performance

The professional-grade Kawasaki® engines are backed by a strong 3-year domestic warranty and service support from our extensive dealer network nationwide to assure the extended lifetime of your machine.

► Command With Comfort

Polymer seat isolators, isolated front caster suspension and an automotive class high-back seat with padded armrests deliver a smooth, quiet ride with minimal vibration.

► Versatility

Standard LED headlights, rollover protection and rear tow hitch paired with premium attachments, build the perfect zero turn package to tackle all of your needs.

► Strong Warranties

- Unit: 3-year domestic & 2-year commercial warranty.
- Engine: 3-year domestic & 2-year commercial warranty.
- Deck: 5-year fabricated deck shell domestic warranty.

ULTIMA ZTX™ SERIES



• ZTX5 48



• ZTX5 54



• ZTX5 60



RESIDENTIAL: ULTIMA ZTX5™ SERIES

Cub Cadet®

STEP UP TO STEERING.

The Ultima ZTXS is engineered for precision and confident control on varying terrain and challenging hills - all backed by the strength, comfort and cut quality of a Cub Cadet zero turn. The commercial-grade features are designed for fast turning and efficient manoeuvrability through challenging conditions.

▶ Excellent Control

Step up your control from traditional lap bars with Synchro-Steer™ technology. The familiar steering wheel combined with four-wheel control makes for precision, manoeuvrability and stability on a variety of terrains including hills up to 20 degrees.

▶ Strength on Deck

Built on a 3.8cm x 7.6cm tubular frame featuring a 10-gauge steel fabricated AeroForce Max™ deck with side, top and leading-edge reinforcements and bagging capabilities, you're equipped with the right amount of strength and rigidity for precise cut quality.

▶ Versatility

With a full lineup of attachments and LED headlights as well as a standard rollover protection system (ROPS) plus rear tow hitch, you can build the ideal zero-turn to tackle your needs.

▶ Command With Comfort

Polymer seat isolators, isolated front caster suspension and a high-back seat with padded armrests designed for a smooth and quiet ride with minimal vibration.

▶ Strong Warranties

- Unit: 3-year domestic & 2-year commercial warranty.
- Engine: 3-year domestic & 2-year commercial warranty.
- Deck: 5-year fabricated deck shell domestic warranty.

ULTIMA ZTXS™ SERIES



- ZTXS4 48
- ZTXS4 54



- ZTXS5 54
- ZTXS5 60



RESIDENTIAL: ULTIMA ZTXS™ SERIES

Cub Cadet



PRO SERIES

It's easy to stick with what you know.

But real progress starts with doing something **different**.

Different isn't afraid to stand out.

Different doesn't back down from an uphill battle.

Different pushes the limits of what's possible.

Different is the beating heart of innovation.

The Pro Series by Cub Cadet.

BUILT DIFFERENT

cubcadet.com.au/commercial-mowers





PRO Z™ SERIES

Your difference maker.

It takes a different kind of person to do what you do. And a different kind of machine. The PRO Z™ Series was built for exactly that. Maintenance-free spindles and commercial-grade engine options amp up your productivity, while fully welded frames and tough fabricated decks were engineered to stand up to tough demands for years to come.

The PRO Z™ Series offers category-exclusive steering systems engineered to tackle challenging terrain with up to a 25-degree incline (PRO Z™ 900 SD/SDL models). Add it to your crew and see the PRO Z™ difference for yourself.



What makes the PRO Z™ Series?

CATEGORY-EXCLUSIVE STEERING SYSTEMS
STEERING WHEEL CONTROL

COMMERCIAL-GRADE STRENGTH
7-GAUGE STEEL DECK

EASY AND QUICK DECK ADJUSTMENTS
ELECTRONIC POWER DECK LIFT SYSTEM*

HILLSIDE STABILITY
REAR DUAL-WHEEL TRACTION#

ADDED SAFETY
ROLLOVER PROTECTION

*Available on the PRO Z™ 900 Series. #Standard on the PRO Z™ 972 SD and PRO Z™ 972 SDL.
Product images are for illustration purposes. Product specifications may change at anytime without prior notice.

HEAVY-DUTY STRENGTH AND DURABILITY.





PRO Z™ 700 S

ENGINE:
27HP* or 31HP* Kawasaki®

TRANSMISSION:
Dual Hydro-Gear™ ZT-4400 Commercial Transmissions

DECK SIZE:
137cm (54") or 152cm (60"), fabricated steel decks

TYRES (FRONT / REAR):
15.00 x 6.00 (Kenda Performance) / 24.00 x 12.00 (Kenda Performance)

WARRANTY:
Unit: 3-year domestic & 3 year commercial.
Engine: 3-year domestic & 3 year commercial.



PRO Z™ 900 S

ENGINE::
35HP* Kawasaki®

TRANSMISSION:
HTG Parker 16cc pumps and 310cc wheel motors

DECK SIZE:
183cm (72"), fabricated steel

TYRES (FRONT / REAR):
16.00 x 6.50 (Kenda K505) / 25.00 x 9.00 (Kenda Performance Tread)

WARRANTY:
Unit: 3-year domestic & 3 year commercial.
Engine: 3-year domestic & 3 year commercial.

PRO Z™ ATTACHMENTS

Attachments Sold Separately



PRO PCS 1900 THREE BAG COLLECTION SYSTEM

Quick and easy to install, the PCS 1900 features a 12-bushel, three bag collection system that performs well under tough conditions (PRO Z™ 700 S only).



Mulch Kit

Mulching your lawn clippings allows for quick decomposition and returns essential nutrients back to the yard.

*Engine HP is set by the engine manufacturer.
Product images are for illustration purposes. Product specifications may change at anytime without prior notice.

PRO Z™ DUAL-WHEEL SERIES

Hillside stability solved.

You never back down from a challenge. That's why the PRO Z SD and SDL are dual-wheel commercial zero-turns specifically engineered to tackle challenging terrain with up to a 25-degree slope. And with up to 30 degrees of self-leveling air-ride seat comfort (exclusive to the SDL), these mowers are built to tackle properties with hilly and varying terrain.



DUAL REAR WHEELS

Oversized dual rear wheels provide stability, traction and precision on the 972 SD and SDL.



PRO Z™ 972 SD

HORSEPOWER:
35HP* Kawasaki®

SEAT SWIVEL:
-

WARRANTY:
Unit: 3-year domestic & 3 year commercial.
Engine: 3-year domestic & 3 year commercial.



PRO Z™ 972 SDL

HORSEPOWER:
35HP* Kawasaki®

SEAT SWIVEL:
Self-leveling air-ride seat

WARRANTY:
Unit: 3-year domestic & 3 year commercial.
Engine: 3-year domestic & 3 year commercial.

MAXIMISED COMFORT



The self-leveling air-ride seat on the PRO Z™ 972 SDL lets you operate with up to 15 degrees of self-leveling from side to side.

HILLSIDE CONFIDENCE

Four-wheel steering control with power steering increases productivity and hillside confidence for the ultimate in manoeuvrability.

- A** Up to a 25-degree slope
- B** Category exclusive steering wheel control with power steering
- C** Dual wheel traction control

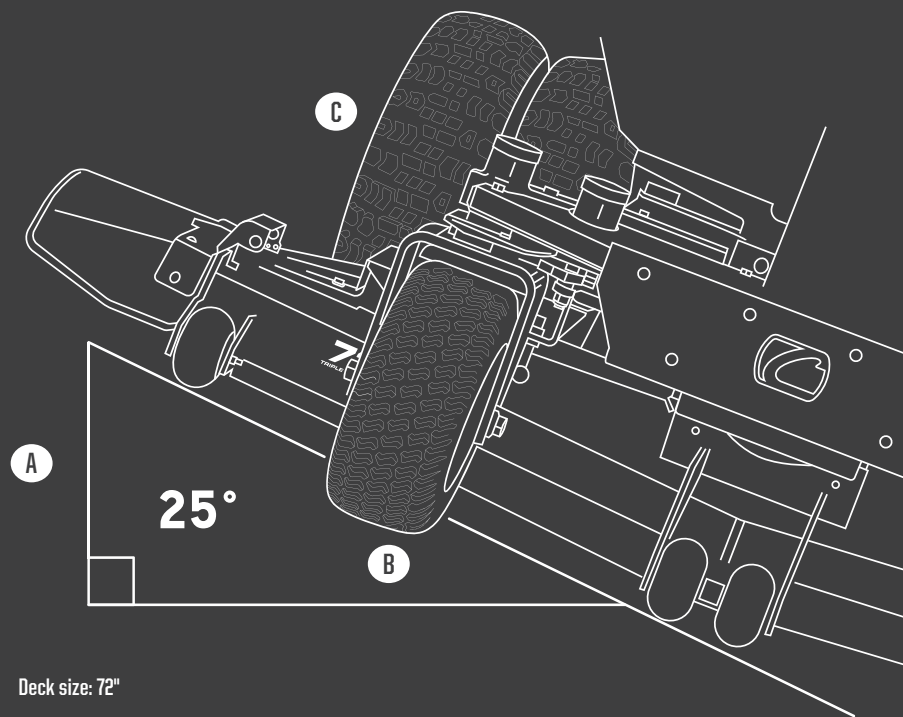

Deck size: 72"

*Engine HP is set by the engine manufacturer.
Product images are for illustration purposes. Product specifications may change at anytime without prior notice.

PRO Z™ COMFORT

A different level of comfort.

When days are as long as yours, comfort isn't just nice to have—it's necessary. That's why we designed the PRO Z Series to be a smooth ride. Innovative features like the isolation dampening system and air-ride suspension help absorb impacts of the job, while adjustable seat firmness (PRO Z 900 Series only), lumbar support and padded armrests provide additional comfort so you'll be able to go the distance.



PRO Z AIR-RIDE SEAT

Our air-ride seat allows riders to adjust seat firmness to their personal preference. Standard on the PRO Z 900.

- A** Air-ride control
- B** EVC cushion (elastic vibration control)
- C** Isolation-dampening system
- D** Angle-back adjustment
- E** Adjustable padded armrests
- F** Adjustable lumbar support

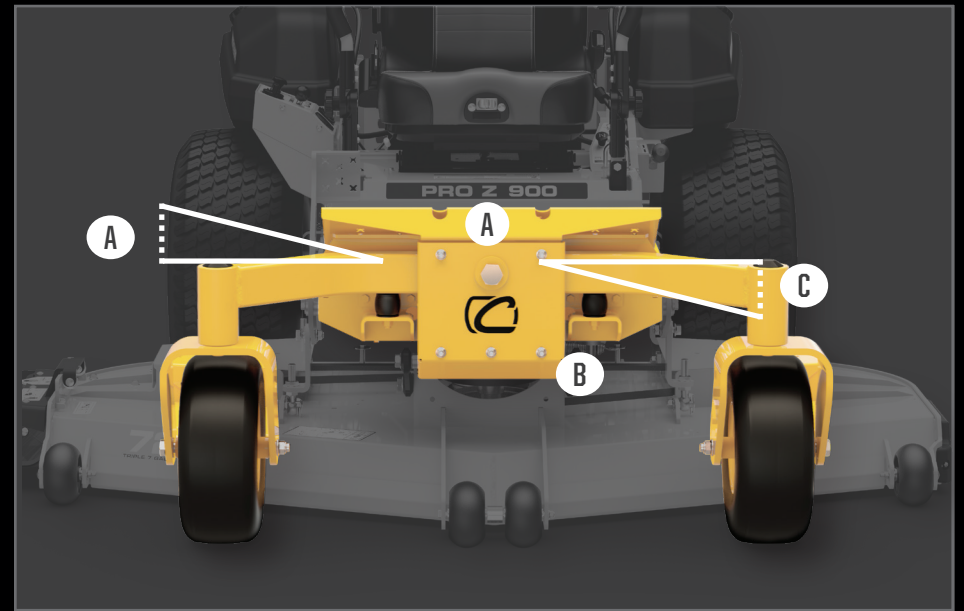

PIVOTING FRONT AXLE WITH ISOLATION-DAMPENING SYSTEM MOUNTS

A pivoting front axle allows the front end of the PRO Z to ride across uneven terrain while helping protect the quality of the cut.

The frame and axle float as the PRO Z moves, allowing the deck to follow the shape of the terrain and help avoid scalping.

- A** 2 1/4" of travel
(4 1/2" of total travel)
- B** Isolation-dampening system.
Standard on the PRO Z 900 Series.
- C** Maximum angle of travel up to 6 degrees

PRO Z™ STRENGTH

Strength without compromise.

You expect the best and the PRO Z Series deck delivers. Fully fabricated and triple plated steel thickness with top and bottom reinforcements so you can power through the rigors of your job, day in and day out.



DECKS BUILT TO LAST

Tackle tough conditions with a triple-7-gauge steel cutting deck: a 7-gauge deck shell with 7-gauge top and bottom reinforcements.

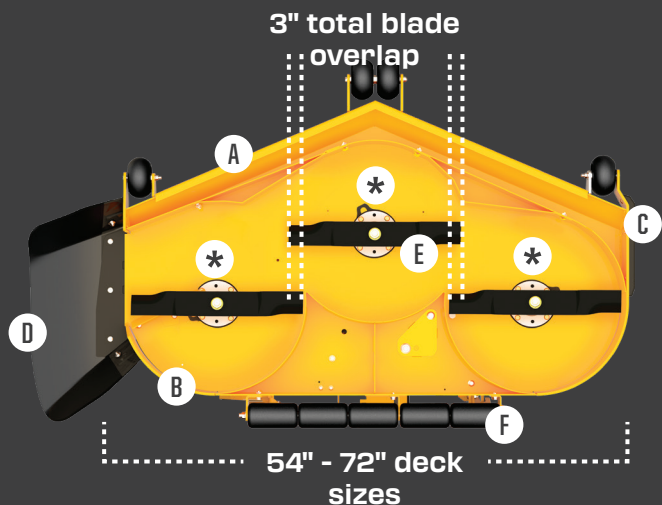

Durability

- A** 1/4" leading rolled edge
- B** 5/16" steel side reinforcements
- C** 3/4" wear guard
- *** Maintenance-free spindle assembly

Quality Cut

- D** Flexible rubber discharge chute
- E** High-lift Marbain® blades (with blade tip speed up to 18,500 fpm)
- F** Adjustable rear striping roller
Standard on the PRO Z 900 Series.

HARD-WORKING FRONT END

Help absorb the impact of rough terrain with new front-end construction featuring a combination of axle, hub and yoke size.

- A** 2" x 3" pivoting front axle
- B** Isolation-dampening system
Standard on the PRO Z 900 Series.
- C** 5" steel hubs
- D** 1/2" thick steel front yokes
- *** Sealed maintenance-free ball bearings



PRO Z™ PERFORMANCE

Built to meet high standards.

High standards like yours need high performance. That's why the PRO Z™ Series was engineered for consistent cut quality, in varying conditions. Featuring high-torque, commercial transmissions and high-horsepower, commercial-grade engines for optimal blade tip speed—and precise, single passes through thick grass.

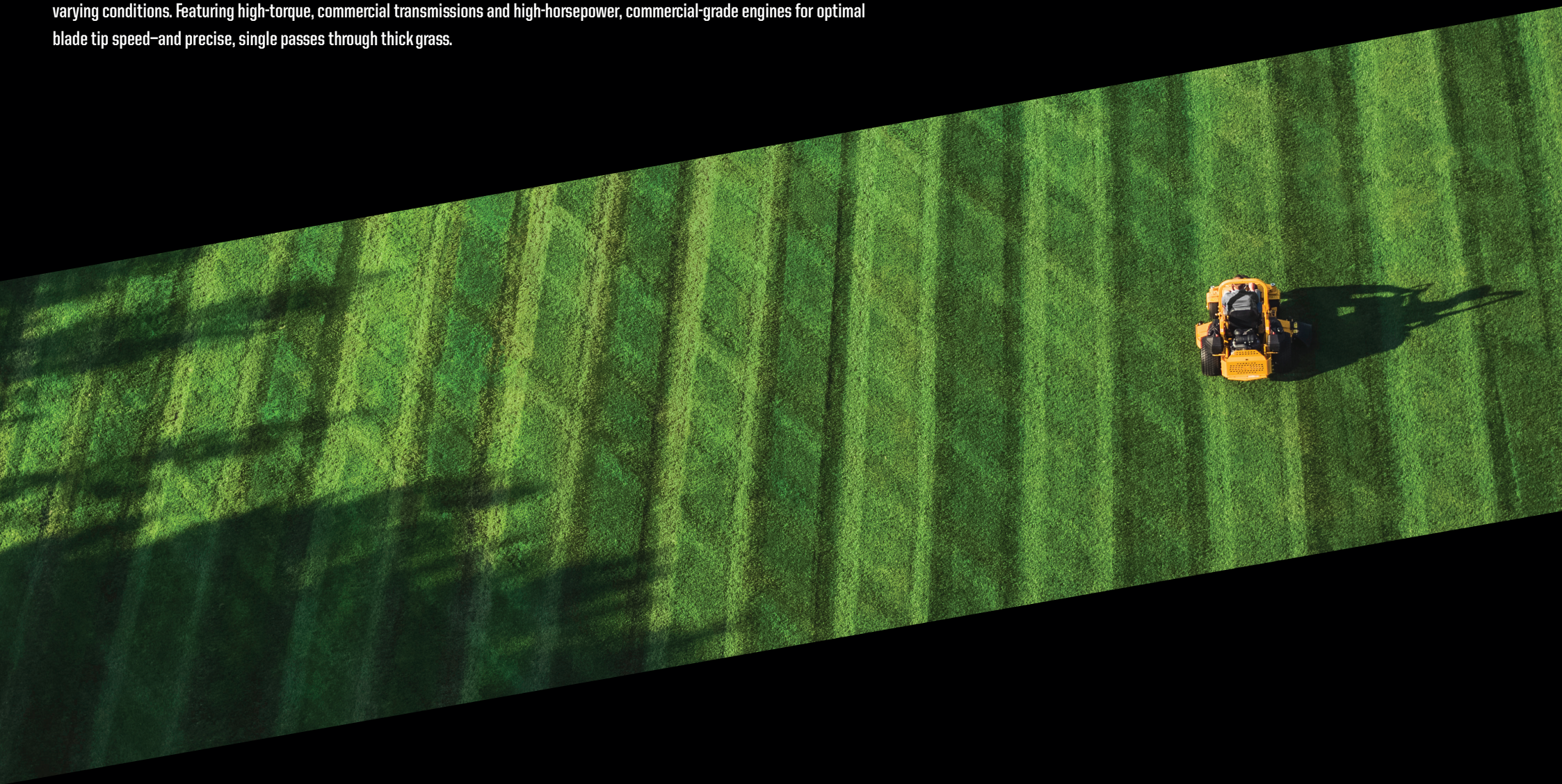

POWERFUL KAWASAKI® ENGINES



- Designed to deliver excellent horsepower
- Optimal balance of torque and power
- Maximum blade tip speed up to 18,500 fpm

Shown above:
Kawasaki® FX Series 35HP* (999cc).

MAX SPEED

PRO Z™ 700



16-19 km/h

PRO Z™ 900



22.5 km/h

Maximum forward speeds.

COMMERCIAL-QUALITY CUT AT HIGH SPEEDS

High-lift Marbain® blades with blade tip speed up to 18,500 fpm

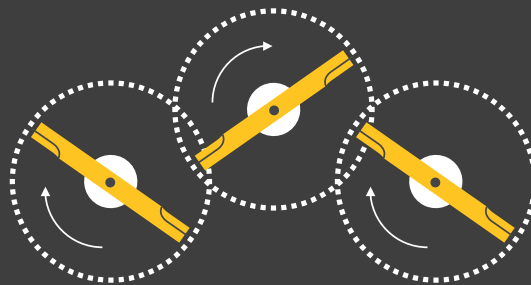

3" total blade overlap
Helps save time by cutting more grass in one pass.

COMMERCIAL ENGINE HORSEPOWER AND TORQUE

▨ Horsepower [hp]

● Torque [ft-lb]

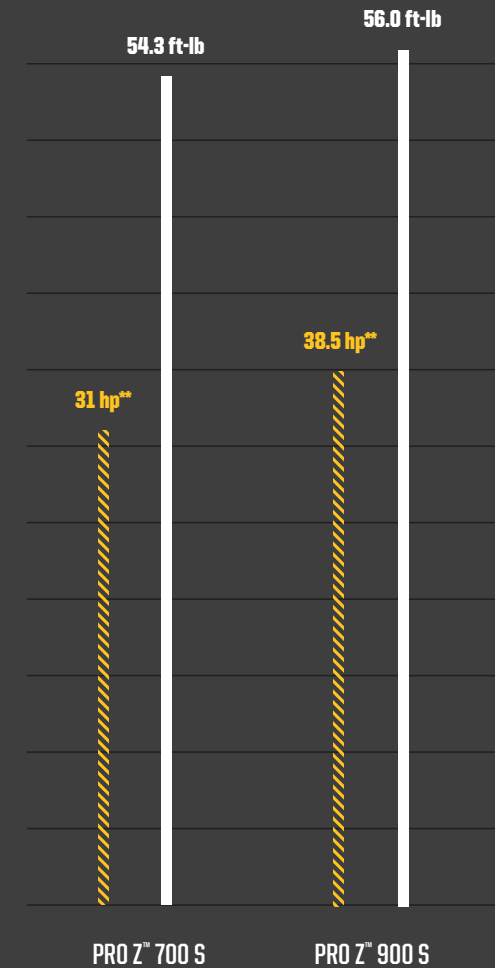

*Engine HP is set by the engine manufacturer.
Product images are for illustration purposes. Product specifications may change at anytime without prior notice.

YEAR-ROUND VERSATILITY.

Get more done and dial up the versatility of your rider with a selection of accessories and hardworking attachments designed to help you tackle your lawn, garden or landscape with confidence year after year.



Double Bag Catcher System

Designed for excellent bagging performance, Cub Cadet double baggers feature a top hinged hood that allows the bags to be emptied without having to pivot the seat forward.

Suits CC 30, XT1, XT2 42/46 & ZT2 54 models.



Triple Bag Catcher System

Designed for excellent bagging performance for larger areas, Cub Cadet triple baggers also feature a top hinged hood that allows the bags to be emptied without pivoting the seat forward.

Suits XT2 54 K, ZT2 54, ZTX5 48/54/60, ZTXS4 48/54 & ZTXS5 54/60 models.



Mulch Kit

Ideal for finely cutting grass clippings and redistributing them back into your lawn, providing essential nutrients.

Suits CC 30, XT1, XT2, ZT1, ZT2, ZTS1, ZTX, ZTXS, PRO Z™ models.



GENUINE PARTS. GENUINE ADVANTAGE.

Cub Cadet® Genuine Parts are the only parts designed and engineered to meet Cub Cadet® original equipment standards.

ATTACHMENTS & ACCESSORIES

See full specification pages for more attachments and accessories per Cub Cadet model range on pages 40-47.

See the full range at: www.cubcadet.com.au/parts-accessories



XT sun shade.

Sun Shade

Mow in comfort with a spacious sun shade.

Suits XT, Ultima & PRO Z™ 700 models.



Front Bumper

Helps to protect the hood and grille, preventing damage from trees, shrubs and other obstacles around your garden.

Suits XT models.



Fast Attach Brush Guard

Offers greater protection to the front of your ride on mower. Easily attaches with Cub Cadet's Fast Attach connection system - no tools required.

Suits XT models.



Fast Attach Cargo Carrier

Add versatility to your rider by adding the Fast Attach Rear Cargo Carrier. Easily carry mulch, dirt, tools, plants and more. The carrier is hinged to fold and stay in an upright position for easy storage.

Suits XT models.



Striping Kit

The Cub Cadet lawn striper helps give your lawn a well-manicured appearance, creating different patterns to set your lawn apart.

Suits ZTX, ZTXS & PRO Z™ models.



Cub Cadet

**CC30 /
ENDURO SERIES XT1**
CC 30 H
CC 30 HX
XT1 42 IP
XT1 18/42
XT1 21/42
ENGINE

Engine Type	382cc Cub Cadet Single OHV	547cc Cub Cadet Single OHV w/IntelliPower™	18HP Kawasaki® V-Twin OHV	21.5HP Kawasaki® V-Twin OHV
Fuel Tank Capacity	4.92 litres		11.4 litres	

DRIVE SYSTEM

Transmission	Hydro, Foot (Tuff Torq)			
Forward / Reverse Speeds	6.4km/h / 3.2km/h		8.6km/h / 4.8km/h	

CONTROLS

Start Type	Key			
Mow In Reverse	Standard			

CUTTING DECK

Deck Construction	14-gauge, pressed steel		13-gauge, pressed steel	
Cutting Width / Blades	76cm (30") / single blade		107cm (42") / twin blade	
Height Adjustment	5-positions / 3.8cm - 10.2cm (1" - 4")		12-positions / 2.5cm - 10cm (1" - 4")	
Deck Blade Engagement	Manual, lever		Electronic fingertip engagement	
Deck Wash	Patented SmartJet™ high-pressure deck washing system			

CHASSIS

Frame	Fully robotically welded frame			
Front / Rear Tyres	13.00 x 5.00 (Turf Saver) / 16.00 x 6.50 (Turf Saver)		15.00 x 6.00 (Turf Saver) / 20.00 x 8.00 (Turf Saver)	15.00 x 6.00 (Multi-Trac) / 20.00 x 8.00 (Multi-Trac)

COMFORT

Seat	Medium-back	High-open back	High-back comfort seat	
------	-------------	----------------	------------------------	--

ADDITIONAL FEATURES

Additional Features	Turning radius 45cm (18")		Turning radius 41cm (16")	
---------------------	---------------------------	--	---------------------------	--

WARRANTY

Warranty	Unit: 6-year domestic and 90 day commercial / Engine: 6-year domestic and 90 day commercial			
----------	---	--	--	--

ACCESSORIES

Mulch Kit 30" Deck
Suits CC 30 models
Part # 19A300130EM



Mulch Kit 42" Deck
Suits XT1 models
Part # 19A300460EM



Double Bag 30" Catcher
Suits CC 30 models
Part # 19A300140EM



Double Bag 42" Catcher
Suits XT1 models
Part # 19B300310EM



Arm Rest Kit
Suits CC30 models
Part # 759-04252



Arm Rest Kit
Suits XT1 models
Part # 757-06093



Front Bumper
Suits XT1 models
Part # 19A30020100 (yellow)
Part # 19A300200EM (black)



Fast Attach Brush Guard
Suits XT1 models
Part # 19A30038100

**ENDURO SERIES:
XT2**

XT2 42 EFI

XT2 42 K

XT2 46 K

XT2 54 K

ENGINE			
Engine Type	679cc Cub Cadet EFI V-Twin OHV	21.5HP Kawasaki® V-Twin OHV	24HP Kawasaki® V-Twin OHV
Fuel Tank Capacity	11.4 litres		
DRIVE SYSTEM			
Transmission	Auto-Diff Hydro, Foot		
Forward / Reverse Speeds	8.6km/h / 4.8km/h		
CONTROLS			
Start Type	Key		
Mow In Reverse	Standard		
CUTTING DECK			
Deck Construction	11-gauge, fabricated steel		
Cutting Width / Blades	107cm (42") / twin blade	117cm (46") / twin blade	137cm (54") / twin blade
Height Adjustment	12-positions / 2.5cm - 10cm (1" - 4")		
Deck Blade Engagement	Electronic fingertip engagement		
Deck Wash	Patented SmartJet™ high-pressure deck washing system		
CHASSIS			
Frame	Fully robotically welded frame		
Front / Rear Tyres	15.00 x 6.00 (Multi-Trac) / 20.00 x 8.00 (Multi-Trac)		
COMFORT			
Seat	High-back comfort seat with armrests		
ADDITIONAL FEATURES			
Additional Features	Turning radius 41cm (16")		
WARRANTY			
Warranty	Unit: 6-year domestic and 90 day commercial / Engine: 6-year domestic and 90 day commercial		

ACCESSORIES



Mulch Kit 42" Fab Deck
Suits XT2 42 models
Part # 19B30054100



Mulch Kit 46" Fab Deck
Suits XT2 46 K
Part # 19A30047100



Mulch Kit 54" Fab Deck
Suits XT2 54 K
Part # 19A30051100



Double Bag 42/46" Catcher
Suits XT2 42/46 models
Part # 19B300310EM



Triple Bag 54" Catcher
Suits XT2 54 K
Part # 19A30018100



Sun Shade
Suits XT models
Part # 490-900-0067



Fast Attach Brush Guard
Suits XT2 models
Part # 19A30038100

ULTIMA SERIES™
ZT1™ & ZT2™

	ZT1 42 IP	ZT1 42 V	ZT1 42	ZT1 46	ZT2 54
ENGINE					
Engine Type	547cc Cub Cadet Single OHV w/IntelliPower™	679cc Cub Cadet V-Twin OHV	21.5HP Kawasaki® FR651V V-Twin	23HP Kawasaki® FR691V V-Twin	
Fuel Tank Capacity	13.2 litres, centre mounted				
DRIVE SYSTEM					
Transmission	Dual Hydro-Gear® ZT-2200			Dual Tuff-Torq TZ-350	
Forward / Reverse Speeds	Up to 11.3km/h / 5.6km/h				
CONTROLS					
Steering Control	Foam grip lap bars w/integrated parking brake system		Over-molded soft-touch ergo grip lap bars w/integrated parking brake system		
CUTTING DECK					
Deck Construction	13-gauge, pressed steel		11-gauge AeroForce™, fabricated steel		11-gauge, fabricated flat top deck
Cutting Width / Blades	107cm (42") / twin blade		117cm (46") / twin blade		137cm (54") / triple blade
Deck Blade Engagement	Electronic fingertip engagement				
Deck Lift / Height	Foot-operated / 15-position / dial adjust / 2.5cm - 11.4cm (1" - 4.5")				
CHASSIS					
Frame / Front Castor Mounts	Square 5cm x 5cm (2" x 2") tubular upper and lower frame structure / Rectangular 5cm x 6cm (2" x 2.5") square frame / offset				
ROPS	N/A				
Front / Rear Tyres	11.00 x 6.00 (Smooth) / 20.00 x 8.00 (Turf Master/Multi-Trac)				13.00 x 6.50 (Smooth) / 20.00 x 12 (TurfMaster/Multi-Trac)
COMFORT					
Seat	High-back comfort seat		High-back adjustable seat w/suspension		High-back seat w/armrests & seat slide
ADDITIONAL FEATURES					
Additional Features	Cup holder, multi-tool and removable floor pan		Dual LED headlights, multi-tool and removable floor pan		
WARRANTY*					
Warranty	Unit: 3-year domestic and 90 day commercial / Engine: 3-year domestic and 90 day commercial. 5-year fabricated deck shell.				

ACCESSORIES



Mulch Kit 42" Deck
Suits ZT1 42 IP/V
Part # 19A300460EM



Mulch Kit 42" Fab Deck
Suits ZT1 42
Part # 19B30054100



Mulch Kit 46" Fab Deck
Suits ZT1 46
Part # 19A30047100



Mulch Kit 54" Fab Deck
Suits ZT2 54
Part # 19A30051100



Double Bag 42"/46" Catcher
Suits ZT1 42/46
Part # 19B70054100



Double Bag 54" Catcher
Suits ZT2 54
Part # 19B70055100



Triple Bag 54" Catcher
Suits ZT2 54
Part # 19A70056100

ULTIMA SERIES™
ZTS1™

ZTS1 42 V

ZTS1 42

ZTS1 46

ENGINE		
Engine Type	679cc Cub Cadet V-Twin OHV	
Fuel Tank Capacity	13.2 litres	
DRIVE SYSTEM		
Transmission	Dual Hydro-Gear® ZT-2200	
Forward / Reverse Speeds	Up to 11.3km/h / 5.6km/h	Up to 11.3km/h / 5.6km/h
CONTROLS		
Steering Control	Steering wheel with Synchro-Steer™ technology	
CUTTING DECK		
Deck Construction	13-gauge, pressed steel	11-gauge AeroForce™, fabricated steel
Cutting Width / Blades	107cm (42") / twin blade	117cm (46") / twin blade
Deck Blade Engagement	Electronic fingertip engagement	
Deck Lift / Height	Foot-operated / 15-position / dial adjust / 2.5cm - 11.4cm (1" - 4.5")	
CHASSIS		
Frame / Front Castor Mounts	Square 5cm x 5cm (2" x 2") tubular upper and lower frame structure / Rectangular 5cm x 6cm (2" x 2.5") square frame / offset	
ROPS	N/A	
Front / Rear Tyres	13.00 x 6.50 (Turf Master) / 20.00 x 8.00 (Turf Master/Multi-Trac)	
COMFORT		
Seat	High-back comfort seat	High-back adjustable seat with armrests
ADDITIONAL FEATURES		
Additional Features	Cup holder, multi-tool, removable floor pan	Dual LED headlights, multi-tool and removable floor pan
WARRANTY*		
Warranty	Unit: 3-year domestic and 90 day commercial / Engine: 3-year domestic and 90 day commercial. 5-year fabricated deck shell.	

ACCESSORIES



Mulch Kit 42" Deck
Suits ZTS1 42 V
Part # 19A300460EM



Mulch Kit 42" Fab Deck
Suits ZTS1 42
Part # 19B30054100



Mulch Kit 46" Fab Deck
Suits ZTS1 46
Part # 19A30047100



Double Bag 42"/46" Catcher
Suits ZTS1 models
Part # 19B70054100



Catcher Adaptor Kit
Suits ZTS models - required when fitting a catcher
Part # 490-950-C062

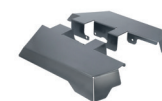

Fender Kit
Suits ZTS1 42 V/42/46
Part # 19A70062100









Striping Kit
Suits ZT1 42 IPV / ZT1 46 / ZT2 54 / ZTS1 42 V/46
Part # 19A700610EM

ULTIMA SERIES™
ZTX™

	ZTX5 48	ZTX5 54	ZTX5 60
ENGINE			
Engine Type	23HP Kawasaki® FR691v V-Twin OHV	24HP Kawasaki® FR730v V-Twin OHV	
Fuel Tank Capacity	Fuel Tank 20.8 litres, centre mounted		
DRIVE SYSTEM			
Transmission	Dual Hydro-Gear® ZT-3200		
Forward / Reverse Speeds	Up to 13km/h / 5km/h	Up to 13km/h / 6km/h	
CONTROLS			
Steering Control	Over-molded soft-touch ergo grip lap bars with integrated parking brake system		
CUTTING DECK			
Deck Construction	10-gauge AeroForce Max™ fabricated steel deck with 2-gauge reinforcement and 7-gauge side wraps plus skid plate		
Cutting Width / Blades	122cm (48") / triple blade	137cm (54") / triple blade	152cm (60") / triple blade
Deck Blade Engagement	Electronic fingertip engagement		
Deck Lift / Height	Foot operated / 16-position / dial adjust / transport mode / 2.5cm - 12cm (1" - 4.7")		
CHASSIS			
Frame / Front Castor Mounts	Rectangular 4cm x 8cm (1.5" x 3") tubular upper and lower frame structure / Rectangular 4cm x 8cm tubular frame / offset		
ROPS	Foldable, Roll Over Protection System designed to keep you safe when mowing on difficult terrain		
Front / Rear Tyres	13.00 x 6.50 (Smooth) / 23.00 x 12.00 (Turf Master)		
COMFORT			
Seat	Premium automotive class high-back adjustable seat w/cushioned armrests, ball-bearing seat slide and patented suspension system		
ADDITIONAL FEATURES			
Additional Features	Cup holder, dual LED headlights and removable floor pan		
WARRANTY			
Warranty	Unit: 3-year domestic and 2-year commercial / Engine: 3-year domestic and 2-year commercial. 5-year fabricated deck shell.		

ACCESSORIES

 <p>Mulch Kit 48" Fab Deck Suits ZTX5 48 Part # 19B70064100</p>	 <p>Mulch Kit 54" Fab Deck Suits ZTX5 54 Part # 19B70065100</p>	 <p>Mulch Kit 60" Deck Suits ZTX5 60 Part # 19B70066100</p>	 <p>Triple Bag 48" Catcher Suits ZTX5 48 Part # 49A70001100</p>	 <p>Triple Bag 54"/60" Catcher Suits ZTX5 54/60 Part # 49A70002100</p>	 <p>Striping Kit Suits ZTX models Part # 59C30052150</p>
---	---	--	---	--	--

**ULTIMA SERIES™
ZTXS™**

	ZTXS4 48	ZTXS4 54	ZTXS5 54	ZTXS5 60
ENGINE				
Engine Type	23HP Kawasaki® FR961v V-Twin OHV	24HP Kawasaki® FR730v V-Twin OHV		25.5HP Kawasaki® FX801v V-Twin OHV
Fuel Tank Capacity	Fuel Tank 20.8 litres, centre mounted			
DRIVE SYSTEM				
Transmission	Dual Hydro-Gear® ZT-3100		Dual Hydro-Gear® ZT-3200	
Forward / Reverse Speeds	Up to 12.9km/h / 5.6km/h		Up to 13.7km/h / 5.6km/h	
CONTROLS				
Steering Control	Steering wheel with Synchro-Steer™ technology			
CUTTING DECK				
Deck Construction	10-gauge AeroForce Max™ fabricated steel deck with 2-gauge reinforcement and 7-gauge side wraps plus skid plate			
Cutting Width / Blades	122cm (48") / triple blade	137cm (54") / triple blade		152cm (60") / triple blade
Deck Blade Engagement	Electronic fingertip engagement			
Deck Lift / Height	Foot operated / 16-position / dial adjust / transport mode / 2.5cm - 12cm (1" - 4.7")			
CHASSIS				
Frame / Front Castor Mounts	Rectangular 4cm x 8cm (1.5" x 3") tubular upper and lower frame structure / Rectangular 4cm x			
ROPS	Foldable, Roll Over Protection System designed to keep you safe when mowing on difficult terrain			
Front / Rear Tyres	13.00 x 6.50 (Turf Master) / 23.00 x 12.00 (Turf Master / Multi-Trac)			
COMFORT				
Seat	Premium automotive class 50.8cm (20") high-back adjustable seat w/ cushioned armrests, ball-bearing seat slide and suspension system		Premium automotive class 61cm (24") high-back adjustable seat w/ cushioned armrests, ball-bearing seat slide and suspension system	
ADDITIONAL FEATURES				
Additional Features	Cup holder, dual LED headlights and removable floor pan			
WARRANTY				
Warranty	Unit: 3-year domestic and 2-year commercial / Engine: 3-year domestic and 2-year commercial. 5-year fabricated deck shell.			

ACCESSORIES







 <p>Mulch Kit 48" Fab Deck Suits ZTXS4 48 Part # 19B70064100</p>	 <p>Mulch Kit 54" Fab Deck Suits ZTXS4 54 / ZTXS5 54 Part # 19B70065100</p>	 <p>Mulch Kit 60" Deck Suits ZTXS5 60 Part # 19B70066100</p>	 <p>Triple Bag 48" Catcher Suits ZTXS4 48 Part # 49A70001100</p>	 <p>Triple Bag 54"/60" Catcher Suits ZTXS4 54 / ZTXS5 54/60 Part # 49A70002100</p>	 <p>Adaptor Kit Suits ZTXS4 48/54 / ZTXS5 54/60 Part # 490-950-C062</p>	 <p>Striping Kit Suits ZTXS models Part # 59C30052150</p>
--	---	--	---	--	---	---

ALSO AVAILABLE

TRIMMER	WHEELED STRING TRIMMER
ENGINE	
Engine Type	159cc Cub Cadet Engine, 4-stroke
CUTTING DECK	
Cutting Width / Height	56cm (22") / adjustable, 4.1cm (1.6") - 7.6cm (3")
WHEELS	
Wheel Type	35.6cm (14") ball bearing wheels
HANDLE	
Handle Type	Loop
WARRANTY	
Warranty	Unit: 2-year domestic and 90 day commercial / Engine: 2-year domestic and 90 day commercial



PRO Z™ 700 S / 900 S	PRO Z™ 754 S	PRO Z™ 760 S	PRO Z™ 972 S	PRO Z™ 972 SD	PRO Z™ 972 SDL
ENGINE					
Engine Type	27HP Kawasaki® FX850v V-Twin 852cc	31HP Kawasaki® FX921v V-Twin 999cc	35HP Kawasaki® FX1000v V-Twin OHV		
Fuel Capacity	Twin 28 litre fuel tanks - 56 litres in total to keep you mowing longer				
DRIVE SYSTEM					
Transmission	Dual Hydro-Gear™ ZT-4400 commercial transmissions, with 12cc pumps and 16cc motors.		Dual Hydro-Gear™ ZT-5400 commercial transmissions, with 16cc pumps and 21.8cc motors.		
Forward / Reverse Speeds	Up to 16km/h	Up to 19km/h / 9.5km/h	Up to 22.5 km/h / 9.5km/h		
CONTROLS					
Steering Control	High performance steering wheel with electronic power steering and foot-pedal control				
Mow In Reverse	Standard				
CUTTING DECK					
Deck Construction	Floating, fabricated 7-gauge top plate, 7-gauge bottom reinforcements, 1/4" rolled leading edge				
Cutting Width	137cm (54") / triple blade	152cm (60") / triple blade	16-position / 2.5cm - 12.7cm (1" - 5") foot pedal with spring assist		183cm (72") / triple blade
Height Adjustment	16-positions / 2.5cm - 12.7cm (1" - 5")		16-position / 2.5cm - 12.7cm (1" - 5") with electronic power deck lift system		
Deck Blade Engagement	Warner® PTO Clutch		Warner® PTO Clutch with Soft-Start		
CHASSIS					
Frame	Fully-welded, full-length 3/8 x 5" laser cut steel / integrated tie-down slots				
Front / Rear Tyres	15.00 x 6.00 (Kenda K505) / 24.00 x 12.00 (Kenda Performance Tread)		16.00 x 6.50 (Kenda K505) / 26.00 x 12.00 (Kenda Performance Tread)	16.00 x 6.50 (Kenda K505) / 25.00 x 9.00 HD Traction Tread (Kenda Performance Tread)	
ROPS	Foldable, 3-position Roll Over Protection System designed to keep you safe when mowing on difficult terrain				
COMFORT					
Seat	Extra high-back seat with premium suspension, ISO pucks, lumbar angle back and EVC cushion		Extra high-back seat with Air Susp, ISO pucks, lumbar angle back and EVC cushion		Extra high-back seat with swivel platform, air suspension, ISO pucks, lumbar angle back and EVC cushion
ADDITIONAL FEATURES					
Additional Features	Rear hitch standard				
WARRANTY					
Warranty	Unit: 3-year domestic and 3-year commercial / Engine: 3-year domestic and 3-year commercial. 5-year fabricated deck shell.				

ACCESSORIES					
					
Mulch Kit 54" Fab Deck Suits PRO Z™ 754 S Part # 59A30065150	Mulch Kit 60" Fab Deck Suits PRO Z™ 760 S Part # 59A30066150	Mulch Kit 72" Deck Suits PRO Z™ 900 S models Part # 59C30053150	PRO PCS Catcher Suits PRO Z™ 700 S 54"/60" Part # 59A30060150	Electric Deck Lift Suits PRO Z™ 700/900 models Part # 59A30050150	Stripping Kit Suits PRO Z™ 700/900 models Part # 59C30052150

*Deck Mounting Kit (PRO Z 754 S # 59A30061150 & PRO Z 760 S # 59A30062150) and Fan-Assist Kit (PRO Z 754/760 S # 59A30063150) are required when fitting a catcher to a PRO Z 700 S model.

Cub Cadet®

Get the Cub Cadet Dealer Advantage.

Cub Cadet dealers know their equipment. And they know how to take care of it and their customers. You'll get exceptional financing, great offers and the expertise you can only find from professionals who sell and service Cub Cadet equipment every day.

INDEPENDENT DEALER
Cub Cadet

SUPPORT AS STRONG AS OUR MACHINES

Visit cubcadet.com.au or call 1300 951 594.

 [facebook.com/cubcadetaus](https://www.facebook.com/cubcadetaus)

 [@cubcadetaus](https://www.instagram.com/cubcadetaus)

 [cubcadetaustralia](https://www.youtube.com/cubcadetaustralia)

For more information, please call **1300 951 594** or visit **www.cubcadet.com.au**

Images are for illustration purposes and may not reflect current dealer inventory or unit specifications. Product specifications may change at any time without prior notice. Please confirm product specifications in-store with your Cub Cadet Dealer prior to purchase. Not all products available at all dealers. A failure by a supplier to deliver in accordance with sample description or not at all or other unintentional causes may result in some products being unavailable. Engine descriptions, warranty and horsepower (HP) are by the engine manufacturer. *For more information on our warranty, please contact your local Cub Cadet Dealer.

2026 Cub Cadet - MAR26 | PART# CUBCADETCAT

WITH YOU FOR **EVERY PART** OF THE RIDE

VISIT OUR CUB CADET® DEALERSHIP TODAY

