

CVi42[®]

v.6.4.3

Client Server Installation and Configuration Guide

cvi42

CLIENT SERVER INSTALLATION AND CONFIGURATION GUIDE

April 2026



Manufactured by
Circle Cardiovascular Imaging Inc.
Suite 1800, 707 – 8th Ave SW
Calgary, Alberta
Canada T2P 1H5

Telephone: 1 (403) 338-1870

Support: support@circlecvi.com

<http://www.circlecvi.com>



© Copyright 2026 Circle Cardiovascular Imaging Inc.

cvi42 is a registered trademark of Circle International Corporation in Canada and/or other countries.

The information contained herein is subject to change without notice. The only warranties for Circle products and services are set forth in the express warranty statements accompanying such products and services. Nothing herein should be constructed as constituting an additional warranty. Circle shall not be liable for technical or editorial errors or omissions contained herein.

1.	<i>Installing and configuring cvi42 Server</i>	6
1.1.	Acquire a TLS certificate	7
1.2.	Server Installation	7
1.2.1.	Services Installed	19
1.3.	Optimizing System Performance	20
1.4.	Activating cvi42 Licensing	20
1.4.1.	Activating Your Installation	20
1.5.	Server Configuration	24
1.6.	Enabling TLS in cvi42	24
1.7.	User Management	25
1.7.1.	Local user management	25
1.7.2.	AD/LDAP user management	27
1.7.3.	Windows Authentication	28
1.7.4.	Role management	29
1.7.5.	User Account Linking	31
1.7.6.	Assigning ADAS 3D User Role	31
1.7.6.	Assigning the TruPlan User Role	32
1.8.	Configure Antivirus Software	32
1.9.	Configure DICOM Networking (PACS Connections)	33
1.10.	Server Configuration (<i>cvi42serverconfig.ini</i> explained)	35
1.11.	General Properties	35
1.12.	PPU Properties	38
1.13.	DICOM Network	38
1.14.	AD/LDAP Integrated Password Authentication	39
1.15.	OpenID Connect Integrated Authentication	40
1.16.	Server-side processing configuration (Node42)	42
1.17.	Gateway Configuration (<i>cvi42_gateway.ini</i>)	43
1.18.	Webclient Service Configuration (<i>cvi42_webclient_service.ini</i>)	44
1.19.	Webclient Manager Configuration (<i>cvi42_worker_manager.ini</i>)	44
2.	<i>cvi42 Configuration Portal</i>	45
3.	<i>Housekeeping</i>	50
3.1.	Overview	50
3.1.1.	Rule matching	50
3.1.2.	Rule execution	50
3.2.	Rules	51

3.2.1.	Criteria	51
3.2.2.	Actions	53
3.2.3.	Recurrence.....	55
3.3.	Rule Editor	55
3.3.1.	Simulation	56
3.4.	Settings	58
3.5.	Log and Control	60
4.	<i>cvi42 Default Roles.....</i>	61
5.	<i>cvi42 Network Communications Matrix</i>	62
6.	<i>cvi42 and TruPlan client installation</i>	63
6.1.	Silent installation of cvi42 client.....	63
6.2.	Client Installation (including TruPlan).....	64
6.3.	Configure cvi42 client to connect to the Server.....	69
7.	<i>cvi42 Web Module</i>	72
7.1.	Overview.....	72
7.2.	Setting up TLS support.....	73
8.	<i>Command-line Integration</i>	73
8.1.	Overview.....	73
8.2.	Client and Server Integration Workflow	74
8.3.	Command Line Parameters for cvi42	76
8.4.	Launching cvi42	76
8.5.	Command Line Parameters for TruPlan	77
9.	<i>Security Considerations</i>	77
9.1	Secure Decommissioning	77
9.2	Logging and Event Capture.....	77
9.2.1	Relevant Security Logs	78
9.2.2	Relevant Security Related User Notices.....	80



IMPORTANT: **cvi42** is software designed to be deployed and run within a secure environment. The security of the software and the environment in which it is run is the responsibility of the customer. Please ensure that the server and clients where **cvi42** is deployed are up to date with security patches, behind a secure firewall, and contain up to date antivirus software. The responsibility for data encryption at rest on installing and configuring a full disk encryption system such as Microsoft BitLocker.

1. Installing and configuring **cvi42** Server

This guide is designed for a fresh installation and activation of **cvi42** Server.



IMPORTANT: For all updates from 5.14 or earlier, customers will need to schedule a guided update with Circle's Customer Support Team at support@circlecvi.com



PRE-REQUISITE: When installing **cvi42** on Windows N, you should have **Media Feature Pack** installed on your Windows before installing **cvi42**.

There are two methods to install **Media Feature Pack**:

1. From Windows Settings:
<https://support.microsoft.com/en-us/windows/media-feature-pack-for-windows-n-8622b390-4ce6-43c9-9b42-549e5328e407>
2. Downloading and installing it manually:
<https://www.microsoft.com/en-us/software-download/mediafeaturepack>

After installation, you should restart your PC to install **cvi42**.

1.1. Acquire a TLS certificate

A TLS certificate should be requested from the site IT department before installing **cvi42**. The certificate will be validated by each client system, so the certificate must be trusted by each host system. Internal certificate management procedures will vary from site to site, we suggest providing the following information:

- The fully qualified host name of the server where **cvi42** will be installed. It is critical that this hostname is used as the server address for clients connecting to **cvi42**.
- The generated certificate should be in PEM (.crt and .key) or P12/PFX format (.p12, .pfx, and .pkcs12).
- The certificate should support TLS 1.3, as it is currently the most secure version of TLS and the only version supported.
- Both RSA and Elliptical Curve algorithms for key exchange are supported
- We suggest at that the certificate is valid for at least a year to minimize the need to renew it more often than that.

Note that certificates have a set period where they are valid and a new certificate will need to be generated and installed before the existing certificate reached the end of its validity.

Some P12/PFX files have passwords. This will need to be supplied when uploading the certificate.

1.2. Server Installation



IMPORTANT: By accessing the Circle Support website at <https://www.circlecvi.com/technical-support> you can find the Minimum System Requirements for a **cvi42** Server Installation with up to 4 concurrent users. For advice on larger deployments please contact Circle's Technical Support Team at support@circlecvi.com.



IMPORTANT: Before starting installation of **cvi42** Server, please make sure you exclude ports used by the **cvi42** Server from Microsoft Windows dynamic range by running the command as administrator:

```
netsh int ipv4 add excludedportrange startport=49696 numberofports=2  
protocol=tcp store=persistent
```

For the **cvi42** Server Installation, you may select **cvi42 Server** option during installation, where you can select from a list of components to install:

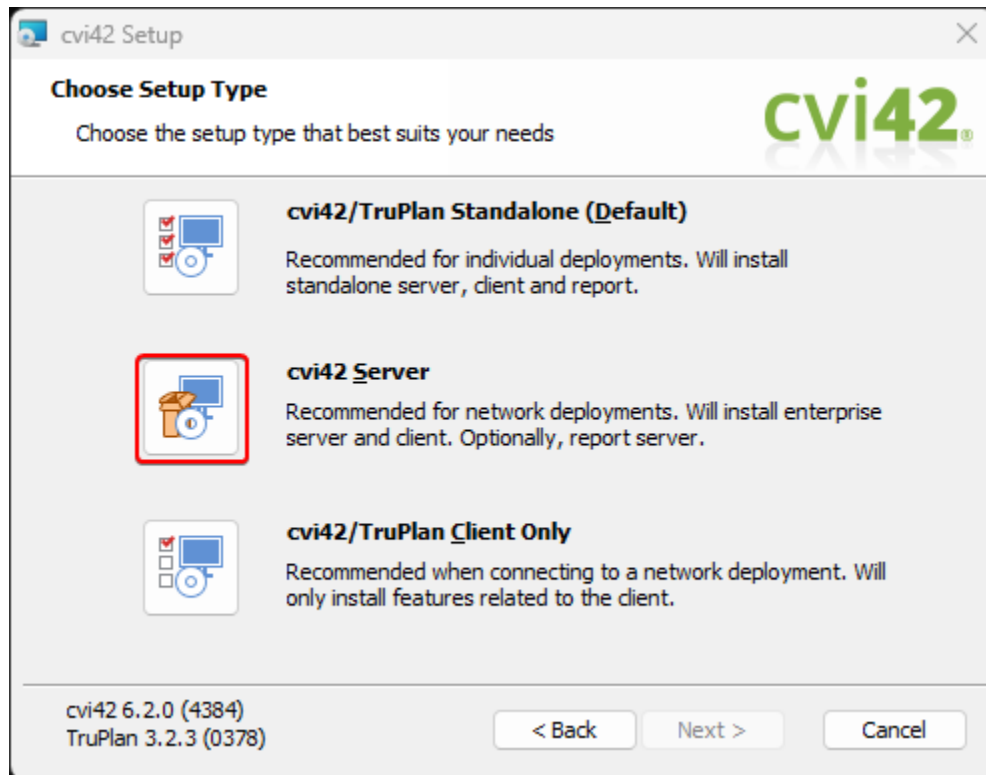

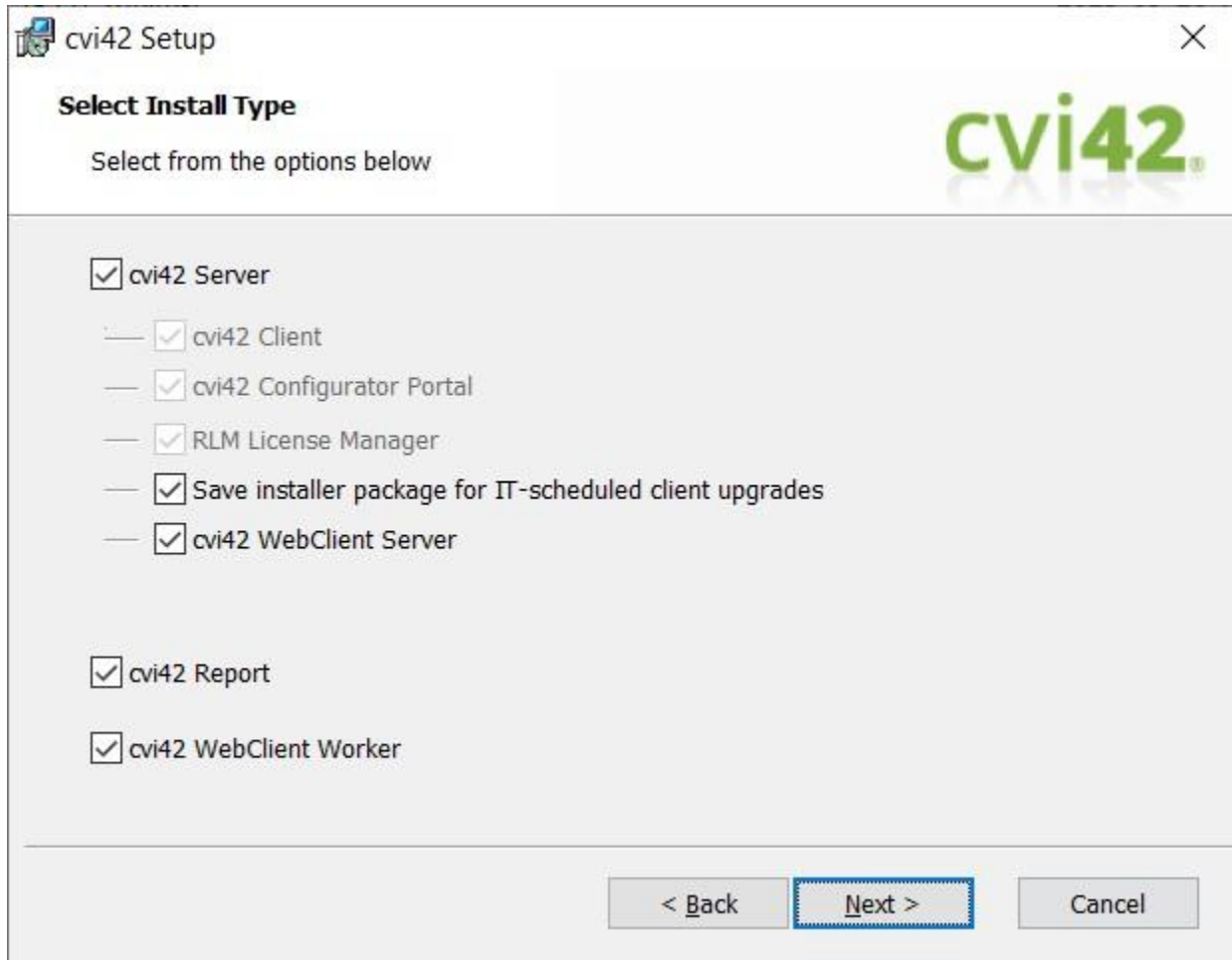

Save installer package for IT-scheduled client upgrades, when checked, the installer will copy the installation package (.msi) to a specific sub-folder on the **cvi42 Server Data** folder (UpgradeAgentService\installer) , so the IT Administrator can trigger client upgrades.

cvi42 WebClient Server is to support the **cvi42 Web Viewer**. When selected, this component is installed on the same machine as **cvi42 Server**. In the current architecture, there is only one instance of **cvi42 WebClient Server** to one or more instances of **cvi42 WebClient Worker** (explained below).

cvi42 WebClient Worker works in conjunction with **cvi42 WebClient Server** to support **cvi42 Web Viewer**. When selected, during the installation of **cvi42 Server**, this component is installed on the same machine as **cvi42 Server**.



IMPORTANT: *IT-scheduled client upgrades* feature allows IT Administrators to update clients remotely. If you have already an automated method for updating clients, this feature is not recommended for you. Please contact Circle's Customer Support Team at support@circlevi.com to obtain more information about ***IT-scheduled client upgrades***.

When **cvi42** is installed, the Server-side processing component (Node42), is installed together, on the same machine.

click **Next**.

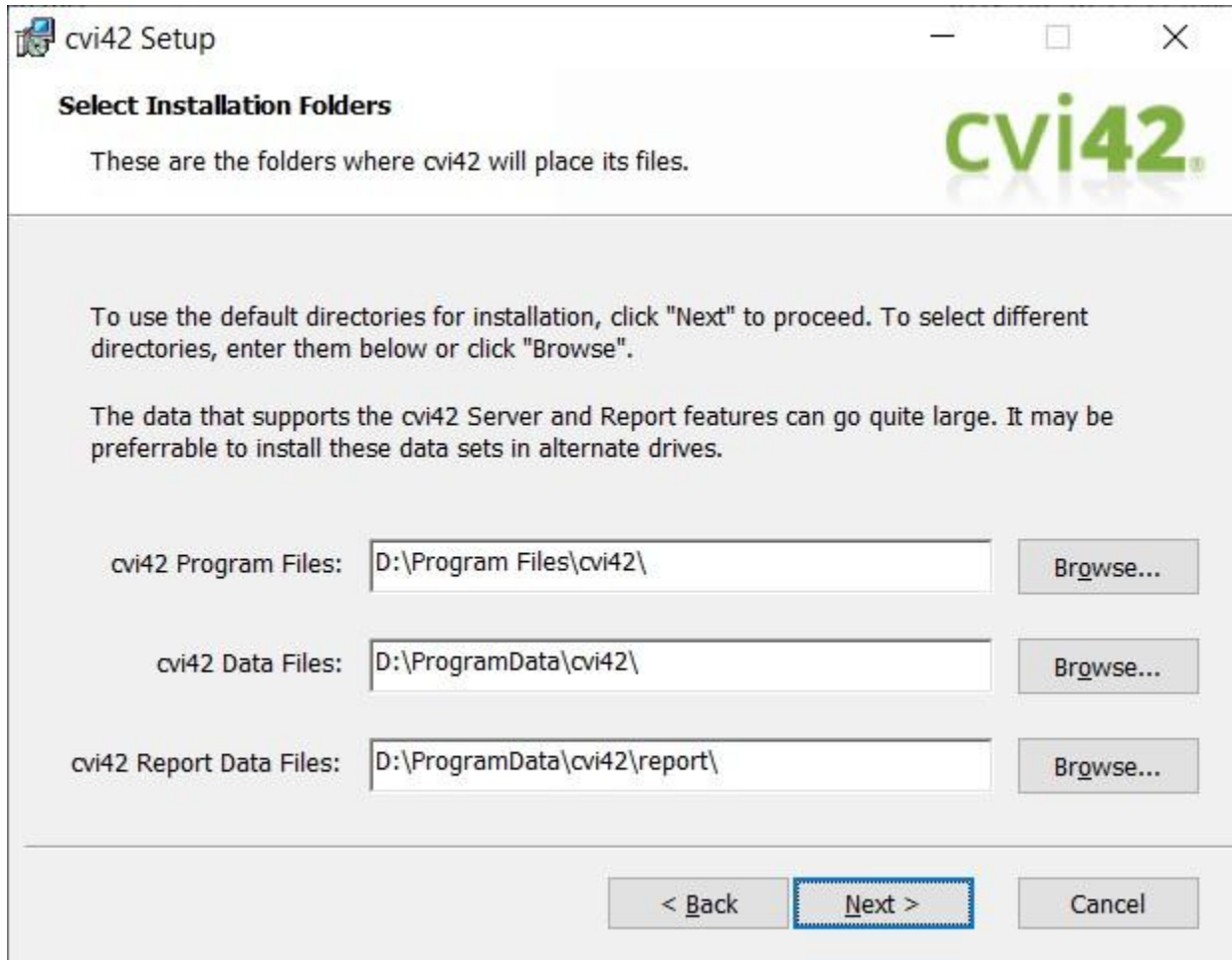

cvi42 Setup

Select Installation Folders

These are the folders where cvi42 will place its files.

To use the default directories for installation, click "Next" to proceed. To select different directories, enter them below or click "Browse".

The data that supports the cvi42 Server and Report features can go quite large. It may be preferable to install these data sets in alternate drives.

cvi42 Program Files:

cvi42 Data Files:

cvi42 Report Data Files:

< Back Cancel

Select the installation and data folders and then click **Next**.

When **cvi42 WebClient Server** or **cvi42 WebClient Worker** is selected, this dialogue will be presented:

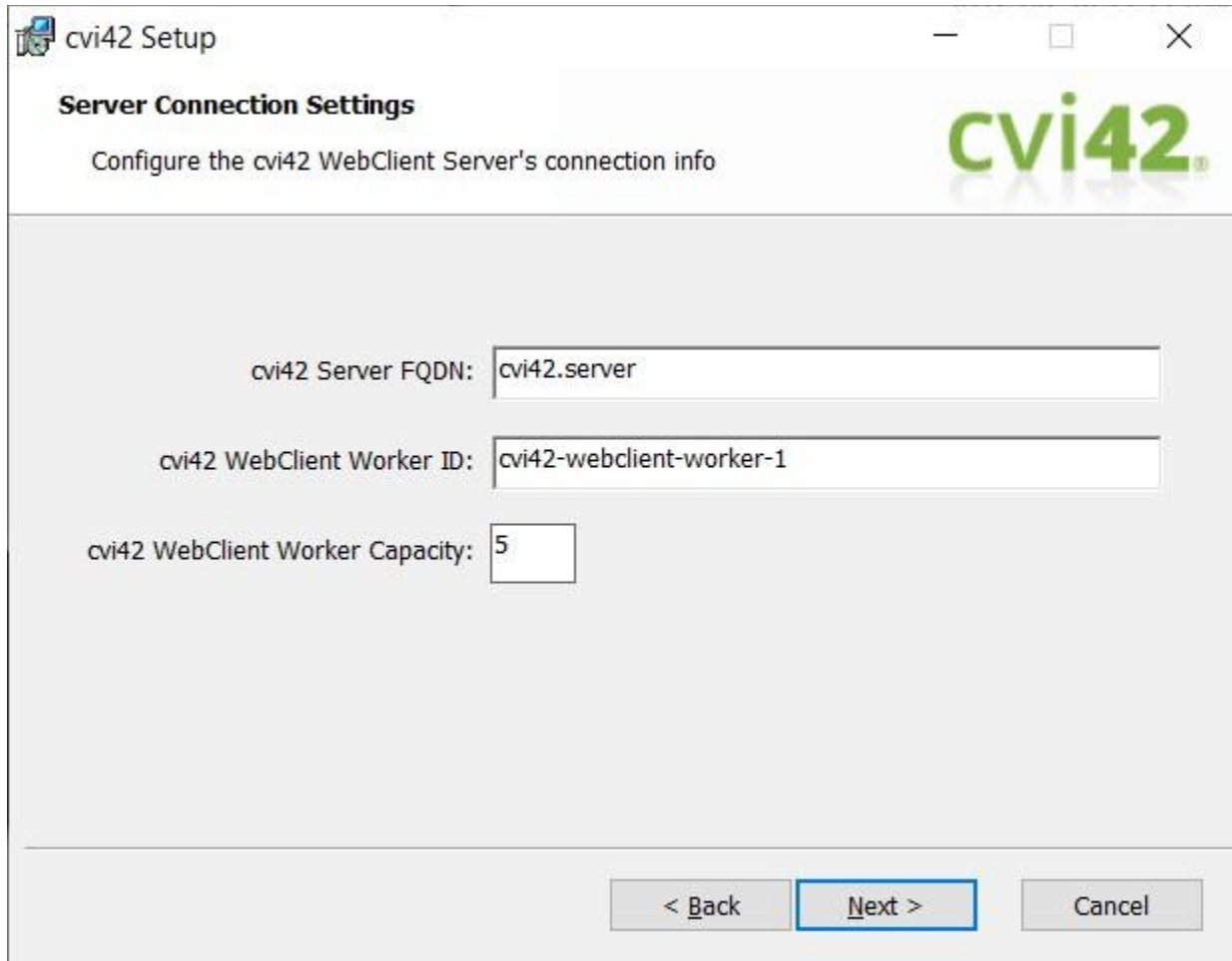

The screenshot shows a window titled "cvi42 Setup" with a standard Windows title bar (minimize, maximize, close). The window content is titled "Server Connection Settings" and includes the instruction "Configure the cvi42 WebClient Server's connection info" and the "cvi42" logo. There are three input fields: "cvi42 Server FQDN:" with the value "cvi42.server", "cvi42 WebClient Worker ID:" with the value "cvi42-webclient-worker-1", and "cvi42 WebClient Worker Capacity:" with the value "5". At the bottom, there are three buttons: "< Back", "Next >" (highlighted with a blue border), and "Cancel".

cvi42 Server FQDN should be the IP/FQDN of the machine where **cvi42 Server** is being installed.

cvi42 WebClient Worker ID can be any alphanumeric identification for the **cvi42 WebClient Worker** instance. This ID is used by the **cvi42 WebClient Server** when communicating to the **cvi42 WebClient Worker**.

cvi42 WebClient Worker Capacity is an internal setting for future functionality, it should be left as the default for now.

cv42 Setup

Server Connection Settings

Configure the cv42 Enterprise Server's connection info



Reporting Server Port:	<input type="text" value="4280"/>
cv42 Server Client Port:	<input type="text" value="49696"/>
cv42 Server Admin Port:	<input type="text" value="49697"/>
cv42 Configurator Port:	<input type="text" value="4299"/>
cv42 Server Side Processing Port:	<input type="text" value="4298"/>
cv42 WebClient HTTP Port:	<input type="text" value="4293"/>
cv42 WebClient Service Listener Port:	<input type="text" value="4289"/>
cv42 WebClient Worker Manager Port:	<input type="text" value="4292"/>

< Back **Next >** Cancel



IMPORTANT: If you intend to change any of **cv42** Server ports, please be aware that this needs to be aligned in the **cv42** client deployment.

Ensure that all ports are available on the computer, otherwise services will fail to start.

To check if a port is being used on Windows the *Resource Monitor* can be used:

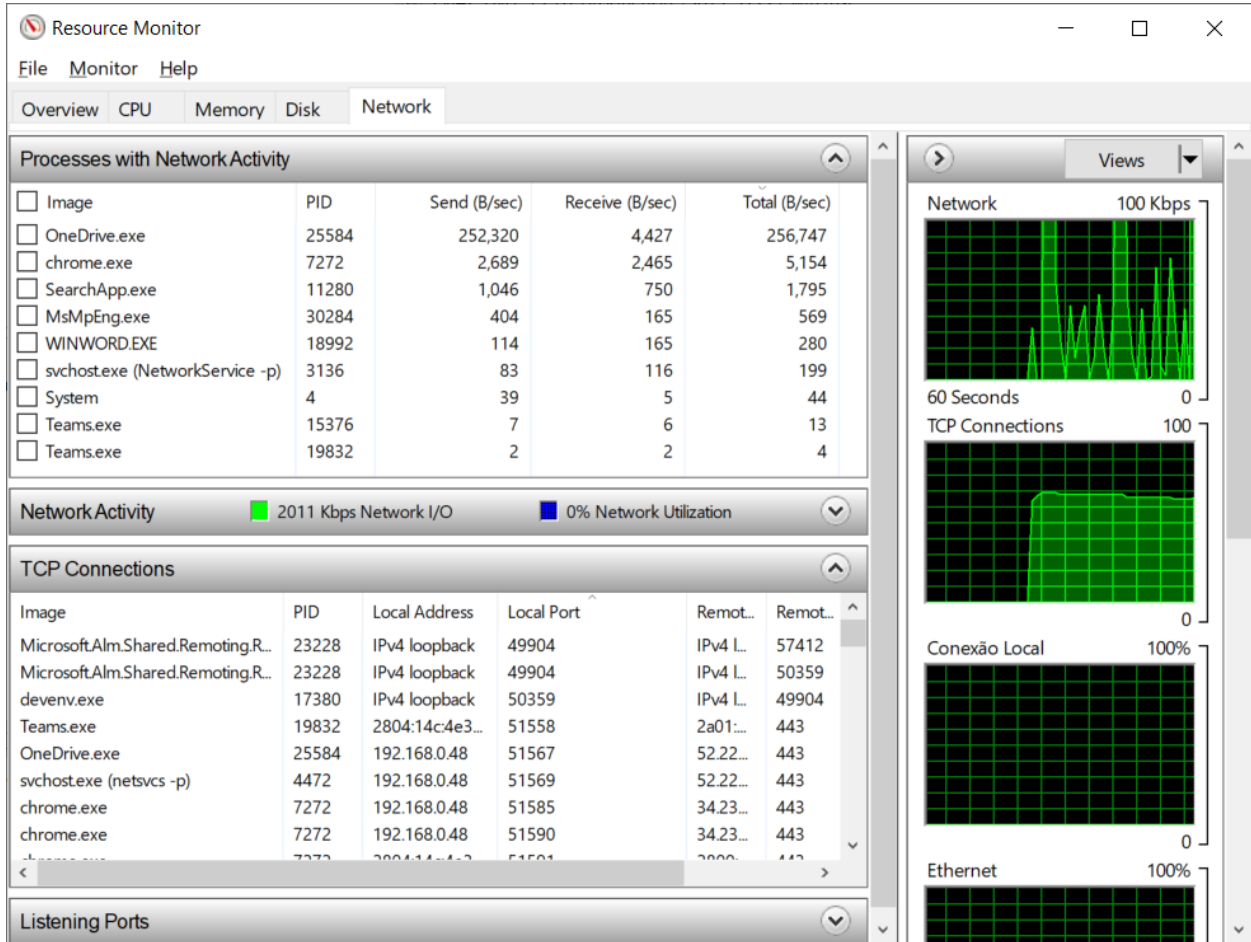

The screenshot shows the Windows Resource Monitor application with the Network tab selected. It displays several sections:

- Processes with Network Activity:** A table listing processes and their network activity.
- Network Activity:** A summary bar showing 2011 Kbps Network I/O and 0% Network Utilization.
- TCP Connections:** A table listing active TCP connections with columns for Image, PID, Local Address, Local Port, Remote Address, and Remote Port.
- Listening Ports:** A section for viewing listening ports (partially visible).
- Views Panel:** On the right, there are three graphs: Network (100 Kbps), TCP Connections (100), and Conexão Local (100%).

Image	PID	Send (B/sec)	Receive (B/sec)	Total (B/sec)
Image				
OneDrive.exe	25584	252,320	4,427	256,747
chrome.exe	7272	2,689	2,465	5,154
SearchApp.exe	11280	1,046	750	1,795
MsMpEng.exe	30284	404	165	569
WINWORD.EXE	18992	114	165	280
svchost.exe (NetworkService -p)	3136	83	116	199
System	4	39	5	44
Teams.exe	15376	7	6	13
Teams.exe	19832	2	2	4

Image	PID	Local Address	Local Port	Remot...	Remot...
Microsoft.Alm.Shared.Remoting.R...	23228	IPv4 loopback	49904	IPv4 L...	57412
Microsoft.Alm.Shared.Remoting.R...	23228	IPv4 loopback	49904	IPv4 L...	50359
devenv.exe	17380	IPv4 loopback	50359	IPv4 L...	49904
Teams.exe	19832	2804:14c:4e3...	51558	2a01:...	443
OneDrive.exe	25584	192.168.0.48	51567	52.22...	443
svchost.exe (netsvcs -p)	4472	192.168.0.48	51569	52.22...	443
chrome.exe	7272	192.168.0.48	51585	34.23...	443
chrome.exe	7272	192.168.0.48	51590	34.23...	443
chrome.exe	7372	192.168.0.48	51591	34.23...	443

The ports can be found on Network tab, by looking at the Local Port column under TCP connections.

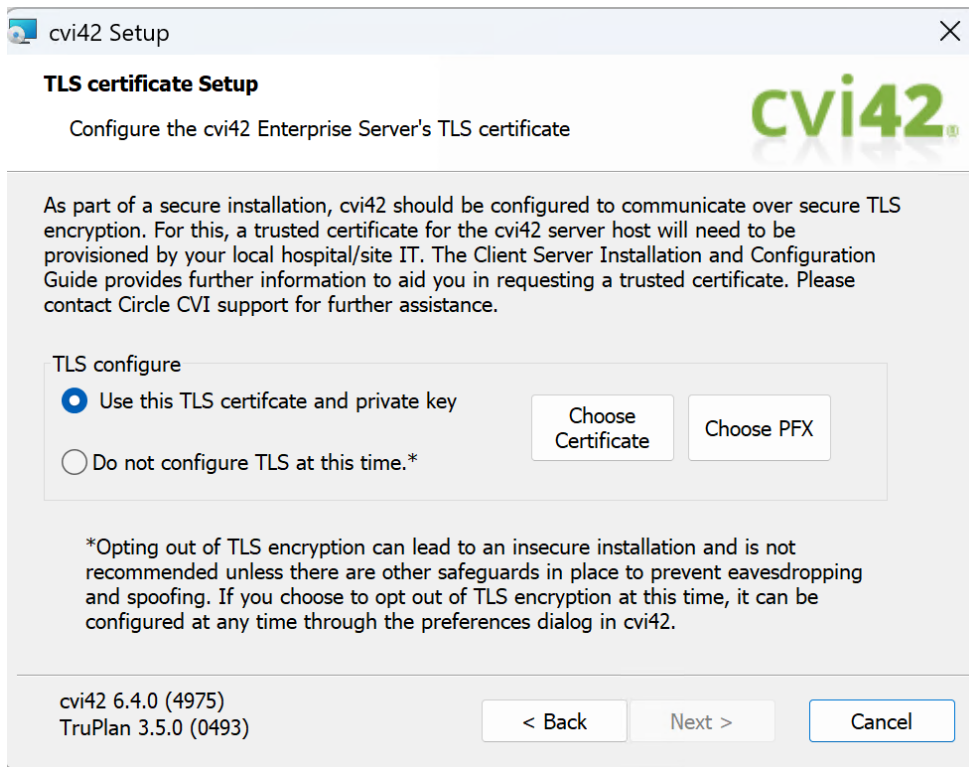

There will be an opportunity to install a TLS certificate as part of the installer. This is strongly recommended as it significantly improves the security of **cvi42**.

If you have a PEM certificate (.key, .crt, .pem) click on "Choose Certificate" and enter the certificate and key. If you have a P12/PFX file (.p12, .pfx, .pkcs12) click on the "Choose PFX" button and upload the file and enter the password if one exists. Once a valid certificate has been entered, the "Next >" button will become available and you may continue.

Once this is done, the server will only listen on the TLS ports (default 4390 and 4391) except on the localhost adapter where you will also be able to connect to the non-TLS ports. This is useful to update the certificate if it expires.

If the network has otherwise been secured against eavesdropping and spoofing, or you chose to install the TLS certificate at a later date you may click the "Do not configure TLS at this time" radio button and click next.



IMPORTANT: In order to protect against eavesdropping and spoofing, it is highly recommended that TLS be used on the server. Failure to do so could result in data being read through man in the middle attacks, or untrusted servers being used.

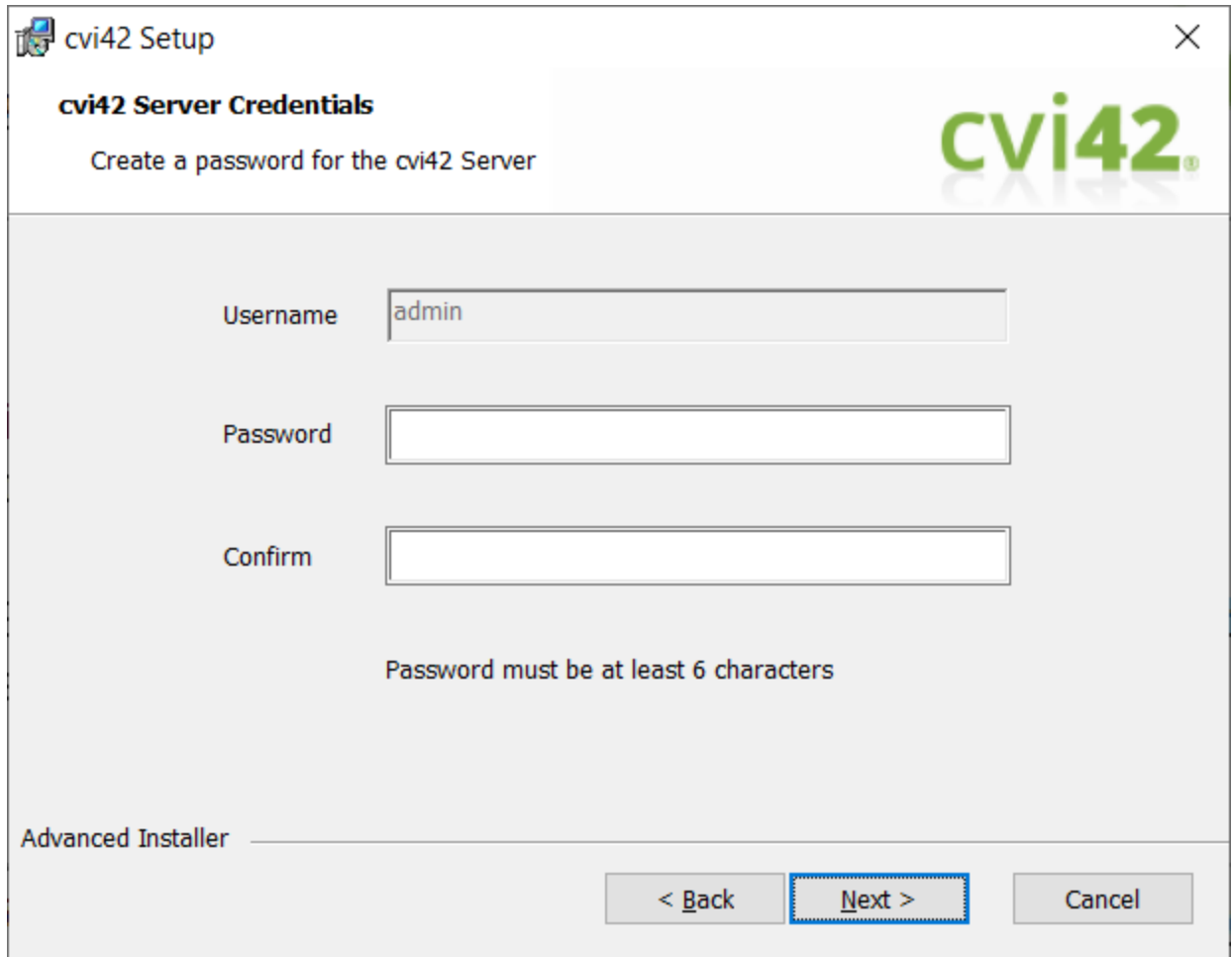

cvi42 Setup

cvi42 Server Credentials

Create a password for the cvi42 Server

Username

Password

Confirm

Password must be at least 6 characters

Advanced Installer

< Back **Next >** Cancel

The admin password must be set during the installation, enter it and click **Next**.

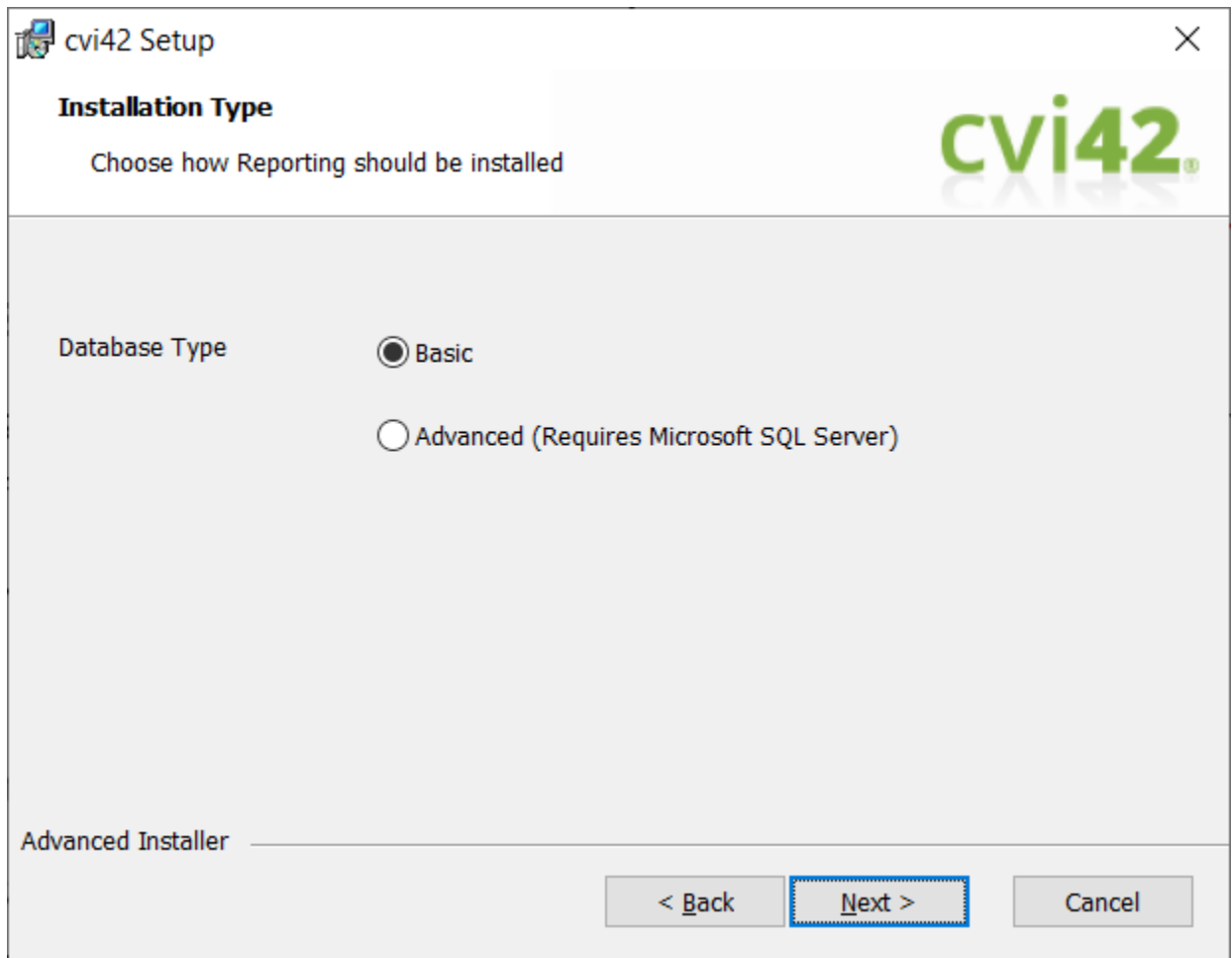

When **cvi42 | Report** is selected for installation, installer will prompt for additional configuration.

Basic (SQLite database) requires no additional configuration.

Advanced, requires to setup a a Microsoft SQL database connection.

The SQL scripts that will be required to install the Microsoft SQL database will be created during installation and will be stored in the **cvi42** Program Files folder that you defined in the **Select Installation Folder** part of this setup, e.g. **C:\Program Files\cvi42\report\scripts**

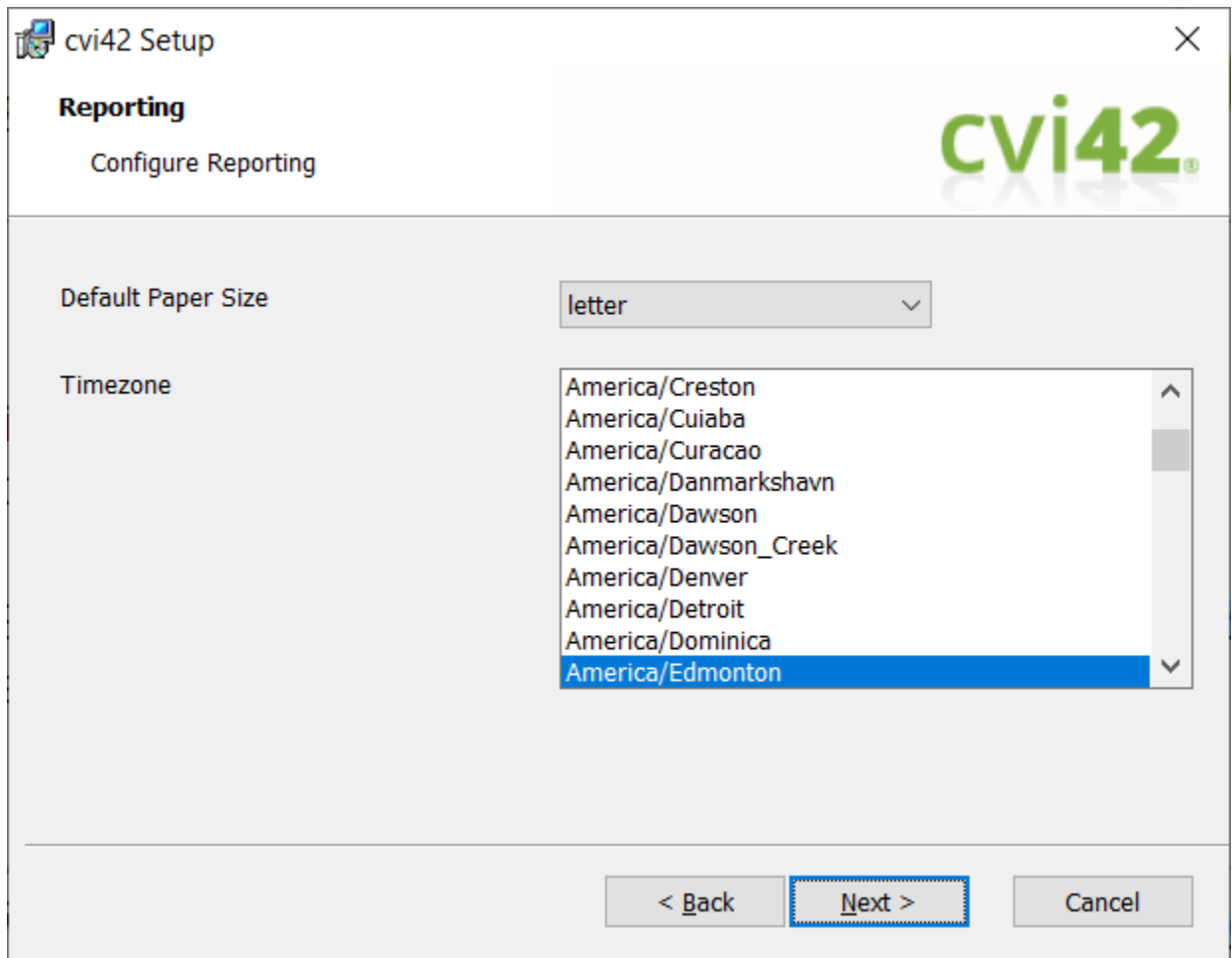

Select the **Default Paper Size** and **Timezone** for the **cvi42 | Report**, and click **Next**.

If **Advanced (Requires Microsoft SQL Server)** is selected, the installer will prompt for **Microsoft SQL Server** connection configuration:

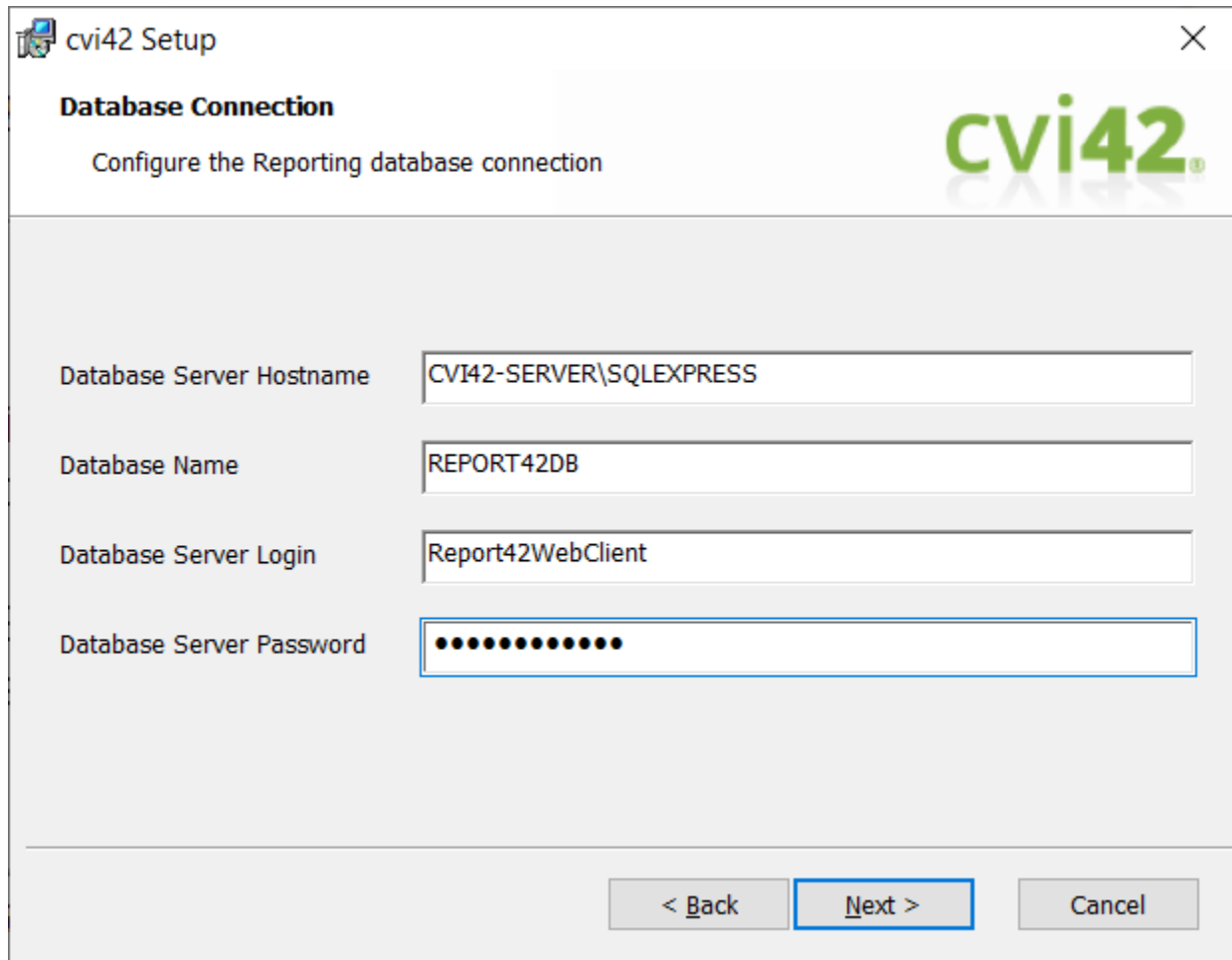

cv42 Setup

Database Connection

Configure the Reporting database connection

Database Server Hostname: CVI42-SERVER\SQLEXPRESS

Database Name: REPORT42DB

Database Server Login: Report42WebClient

Database Server Password: [Masked]

< Back Next > Cancel

click **Next**.



IMPORTANT: While **cv42** works with Microsoft SQLEXPRESS, Circle recommends to use a fully licensed and supported Microsoft SQL Server.

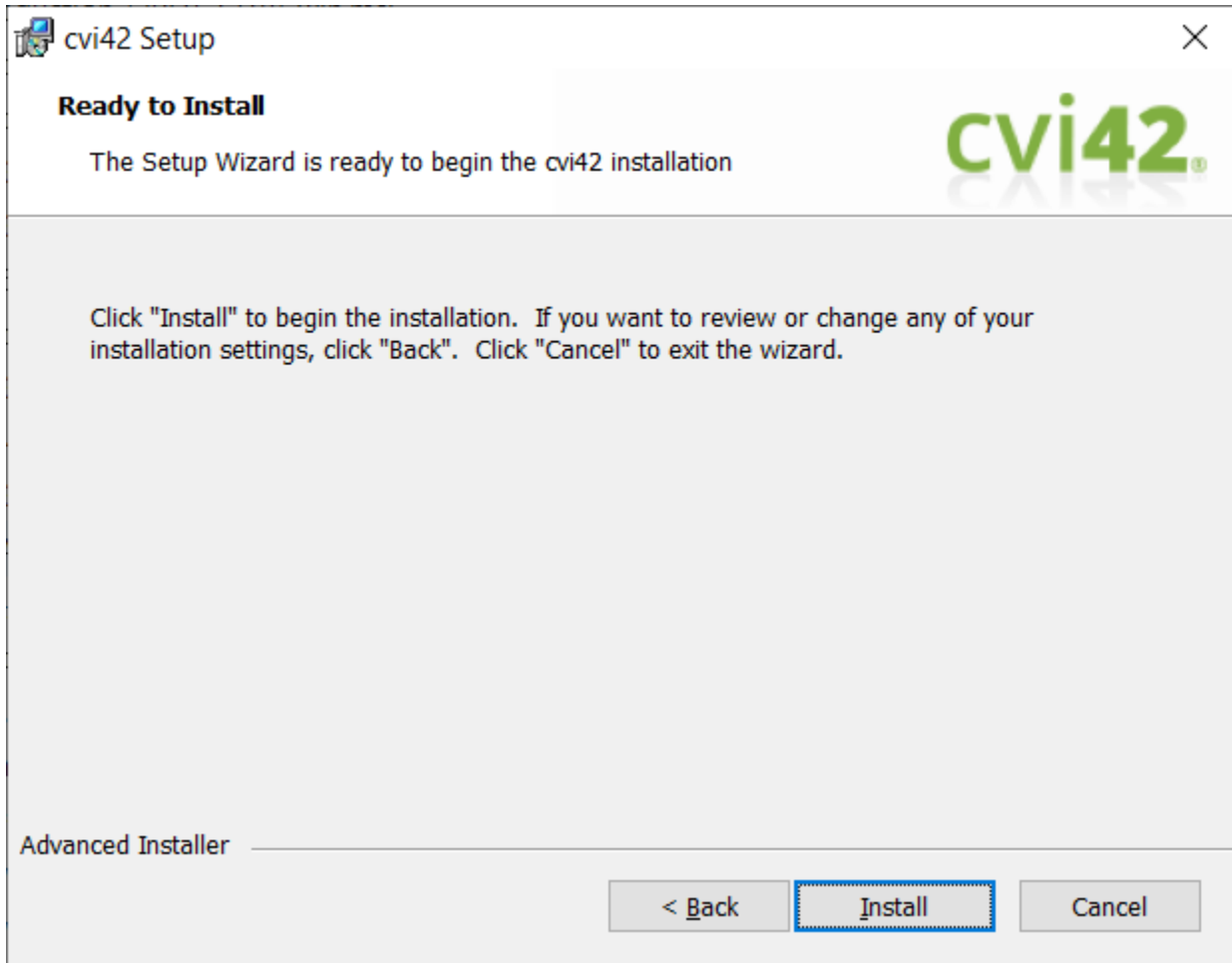

Click **Install** to complete the installation.

1.2.1. Services Installed

When all server components are installed, the following services will be running:

Service Display Name	Role
cv42 Gateway	Server configuration web interface
cv42 License Server	License management
cv42 Report Go Server	Report service layer
cv42 Report Server	Report UI (Apache Web Server)
cv42 Server	Service layer
cv42 Webclient Manager	Web Module service layer
cv42 Webclient Service	Web Module User Interface

1.3. Optimizing System Performance



IMPORTANT: In order to protect patient information, any drive directory which receives DICOM data should not be indexed.

Open the Start menu and type "Indexing", select indexing Options.

Select the "Modify" option and untick any drive directory which receives DICOM data.

1.4. Activating cvi42 Licensing

The typical way to activate **cvi42** is by obtaining an Activation Key from Circle CVI Support Team.

1.4.1. Activating Your Installation

Launch **cvi42** client on the server machine:

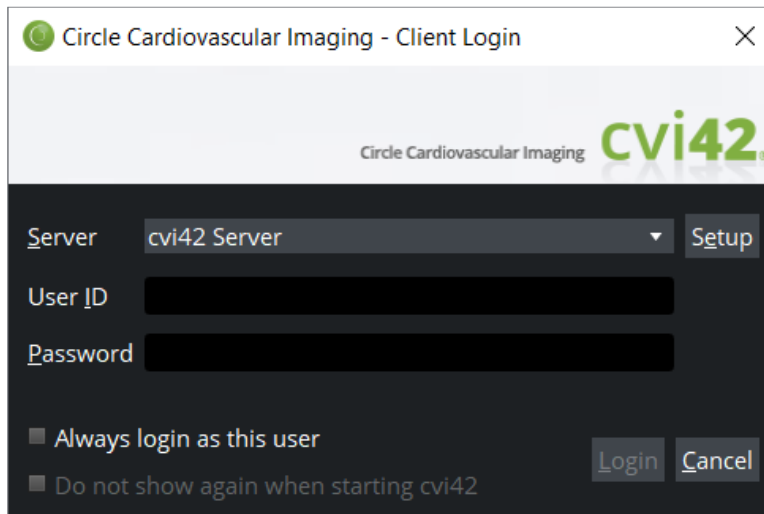

- The default **User ID** is "admin", and the password has been setup during installation.
- Enter the User ID/Password information and click **Login**. **cvi42** will proceed to check for a valid license and display the license request dialogue.

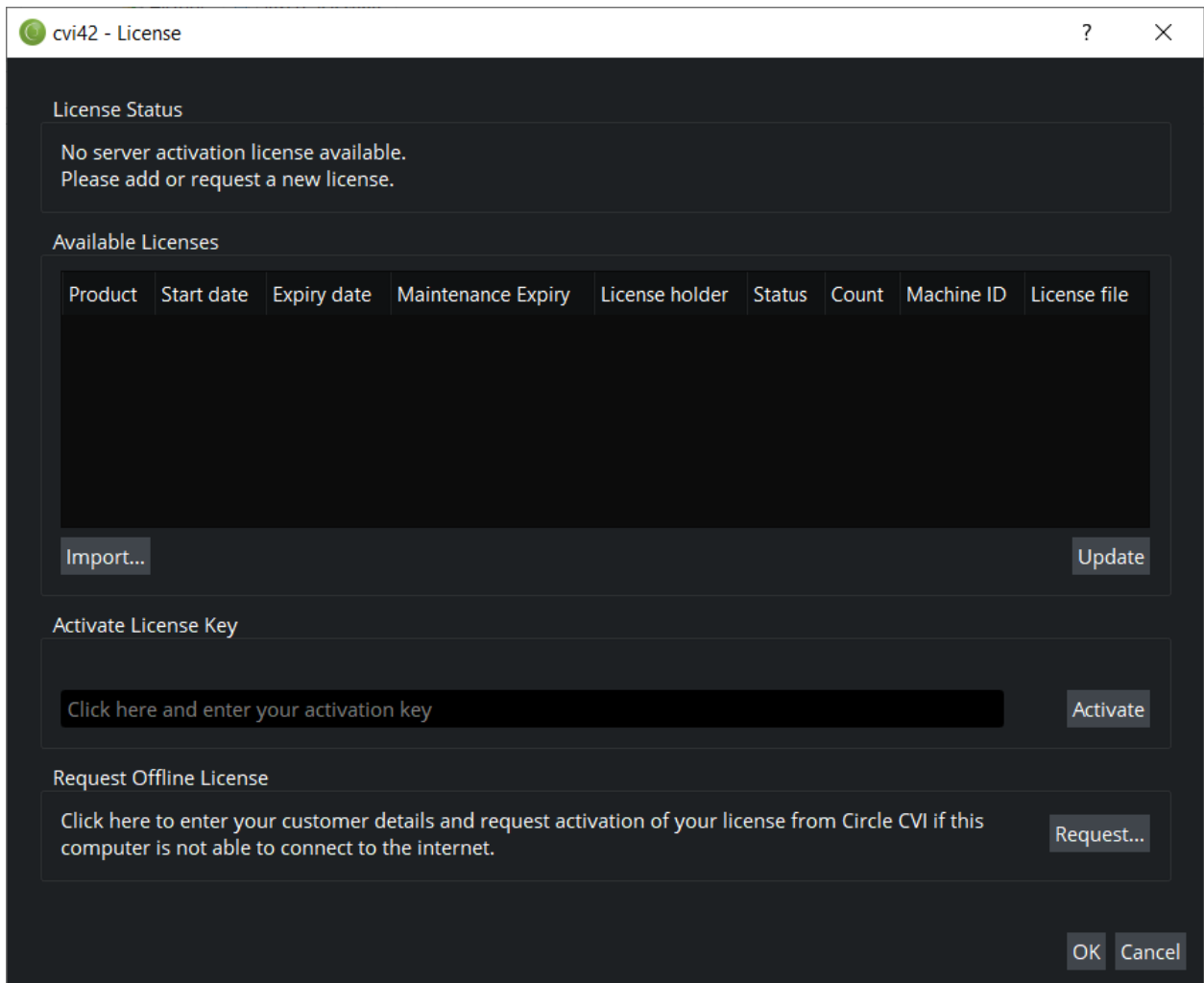

- Enter the Activation Key in the field **Activate License Key** and click **Activate**. If you are connected to the internet, you will see the list of Available Licenses filled in with all the licenses associated with your Activation Key:

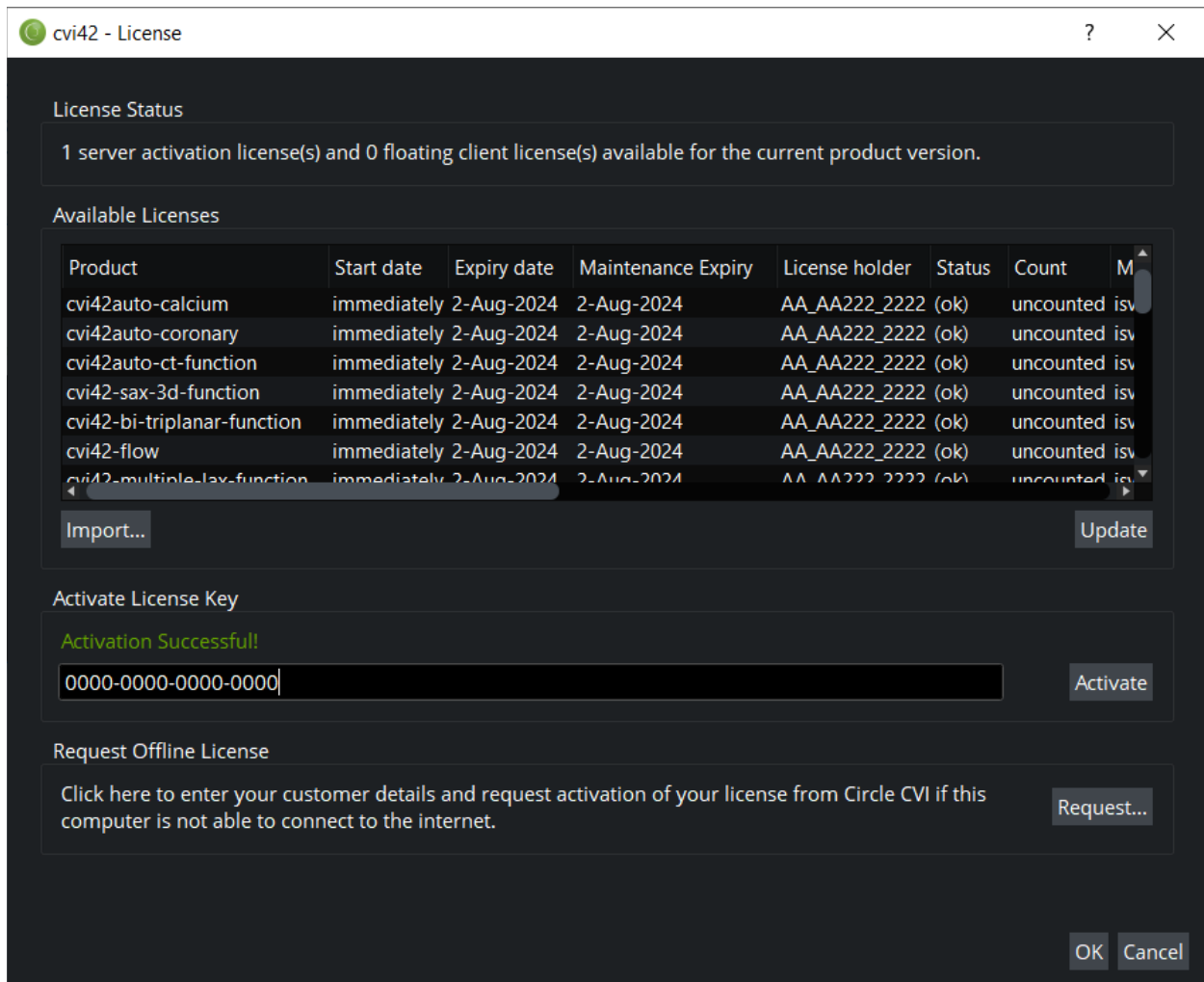

If activation is successful, you should get a confirmation message.

By clicking **OK**, the application will open.

For any error during the activation, an error message will be presented in red color. The error message should be reported to Circle CVI Support Team, who can assist you with the problem:

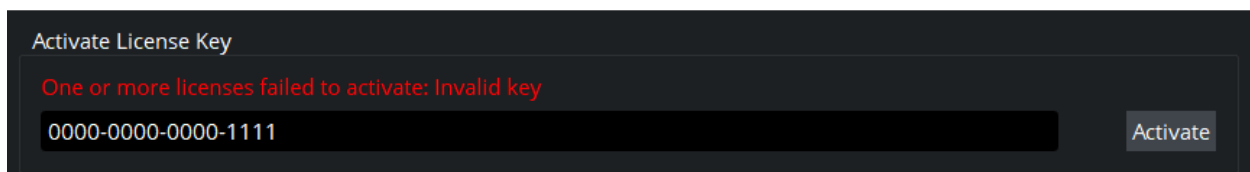



IMPORTANT: If you are logged into Windows with a non-Administrator account, try to start the **cvi42** client as an administrator, by right-click on **cvi42.exe** and choose *Run As Administrator*. When you have successfully imported the license, exit the **cvi42** client, and restart **cvi42.exe** by double-clicking, as usual.



IMPORTANT: For Pay-Per-Use (PPU) licensing a reliable connection to Circle's PPU servers is required. The connection to Circle's PPU servers will be encrypted, all data will be hashed and salted, and no PHI will be transferred.

1.4.1.1. Offline Activation Method

When access to the internet is restricted, offline license can be requested to Circle CVI Support Team by sending a license request file. After installing **cvi42**, request file can be generated by log into **cvi42** and clicking Request in the License dialogue:

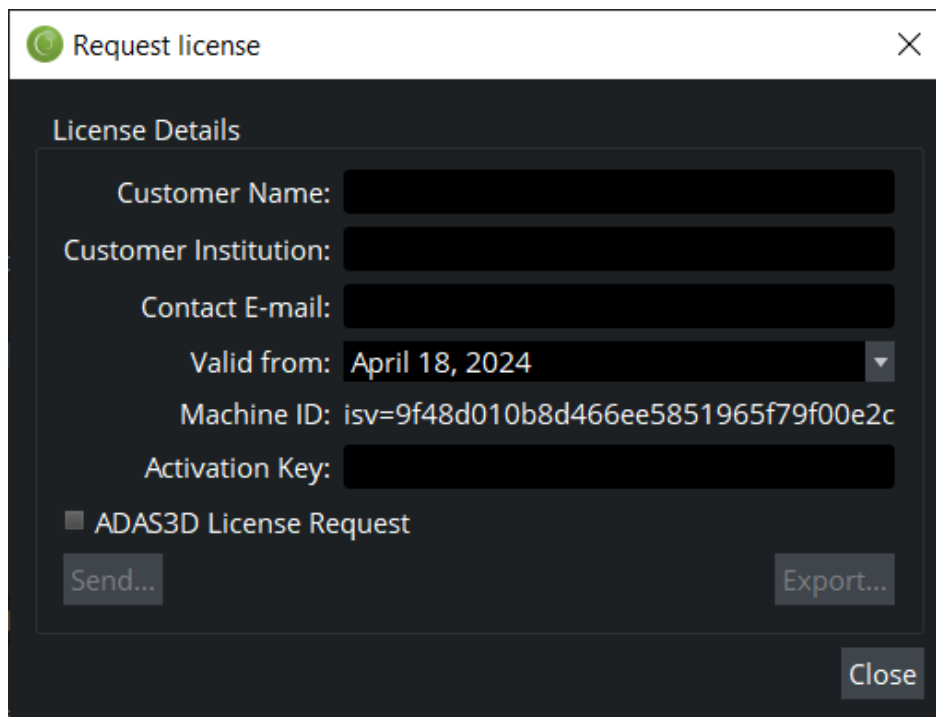

Add license details, Activation Key field is not mandatory.

Check **ADAS3D License Request** if you need a license for ADAS3D as well.

Click **Export...** button to export the request file to disk. Close the dialog box afterwards.

Click **Import...** when receiving the license file from Circle Support Team to activate **cvi42**.

1.5. Server Configuration

To access **cvi42** Server Configuration options, you must login as an admin on the admin port (49697) and access Preferences -> Config from the menu bar (or press F12).

1.6. Enabling TLS in cvi42



IMPORTANT: **cvi42** accepts PEM (.pem, .crt, and .key) and PKCS #12 (.p12 and .pfx) formatted certificates and private keys.

Acquiring TLS keys

Please see section 1.1 to get instructions on how to request a valid key.

Importing Key Pair

Before using an encrypted connection for the first time in **cvi42**, you must install a valid certificate/private key pair to the server. This can either be achieved by:

- *Importing Key Pair using cvi42* client user interface connecting to **cvi42** Server on the admin port
- Or manually placing the required files in the %PROGRAMDATA%\cvi42 folder of the **cvi42** Server

The file will need to be partitioned into separate certificate and private key files.

1. Log into a **cvi42** client with **cvi42** administrator credentials through the administrative port and open the preferences menu
2. Select **Server Admin**
3. Import both certificate and private key files using the client UI, as shown below



IMPORTANT: All certificates used by **cvi42** must be valid and trusted by the operating system.

4. Next, select **Send Keypair to Server**. If this operation is successful, you will see a dialogue box confirming the files have been saved to the server.
5. Once a certificate is setup, the server will only listen on the TLS ports for external connections (default 4390 and 4391). The non-TLS ports will only be accessible from localhost.

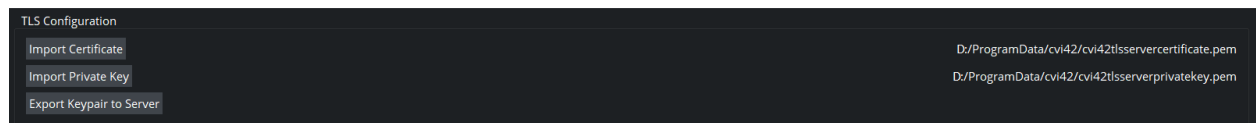



IMPORTANT: When a new Keypair is sent to the server, **cvi42** Server **must** be restarted in order to load the imported keypair. Clicking in Export Keypair to Server, does not restart the **cvi42** Server.



IMPORTANT: If **cvi42** Server has been setup for secure connection, please make sure the **cvi42** client is configured for secure connections.

Configuring an Encrypted Connection

Once TLS has been enabled on the **cvi42** Server, a secure server connection can be configured. Follow the steps outlined in section 6.3, to either add a new connection or modify an existing one.

1. Select "Connect as TLS". This will disable the Server Port field and enable the TLS Server Port field.
2. Specify the TLS Server Port. NOTE the default TLS Server Port is 4391.
3. Once saved, if successful the following dialogue box will be displayed.

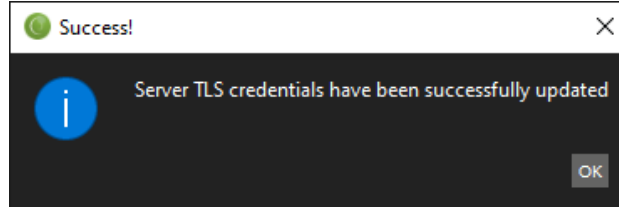

1.7. User Management

There are multiple user management options in **cvi42**:

- Local user management
- AD/LDAP user management
- Windows Authentication
- OpenID connect

1.7.1. Local user management

From the **cvi42** Server Configuration options, select `Server Admin` option.

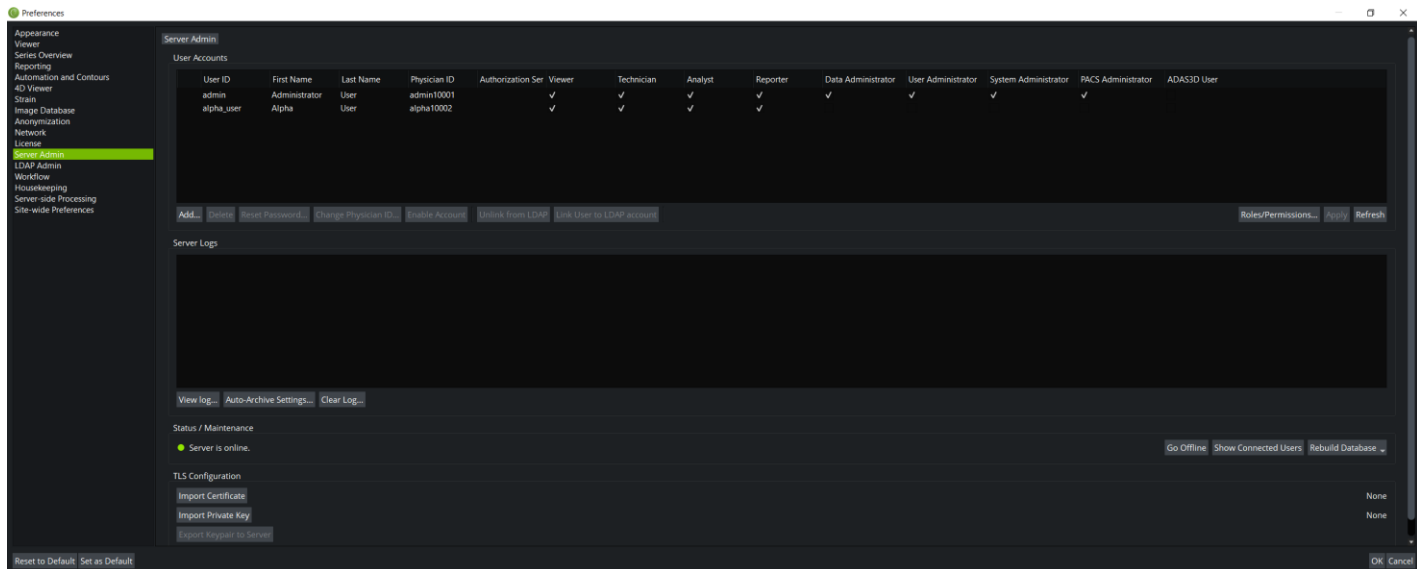

- Click the "Add..." button, to add a new account. The *New user* dialogue will be displayed.

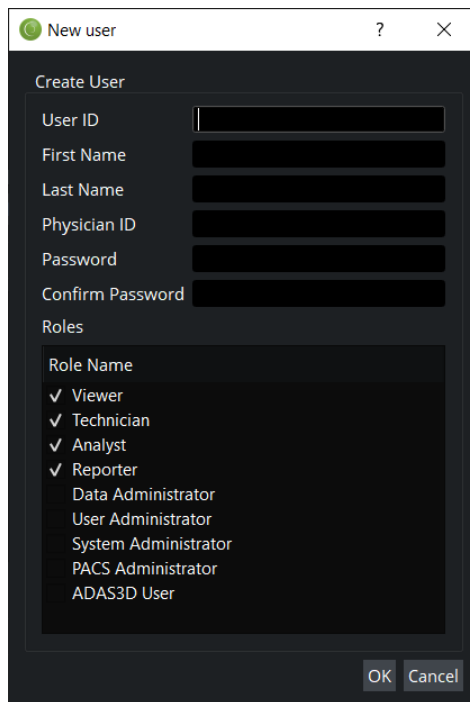

- Fill in all the user details and check the roles to be assigned to the new user.
- Click *OK* to finish.

1.7.2. AD/LDAP user management

From the **cvi42** Server Configuration options, select **LDAP Admin** option for setting up the configuration for Active Directory (AD) or LDAP integrated password authentication. This feature allows users to log into **cvi42** with their existing user credentials assigned by their organization's IT team.

To connect to an AD or LDAP server, **cvi42** needs the following information.

- **Enable LDAP**– When checked this checkbox enables the configured LDAP for user authentication and authorization.
- **Primary Server, Secondary Server** – IP address or fully qualified domain name for the AD or LDAP server.
- **Use TLS/SSL to connect**– When checked, the LDAP connection will be made over TLS (LDAPS). Contact the site IT or AD/LDAP server administrator for certificate files and configuration steps).
- **Username** – The username of the LDAP Bind account used by the **cvi42** Server to communicate with the integrated AD or LDAP server.
 - **Active Directory:** When configuring the username value for AD, it will be a userPrincipalName(CVI42-BIND-ACCOUNT-NAME@DOMAIN-NAME) or sAMAccountName (DOMAIN-NAME\CVI42-BIND-ACCOUNT-NAME).
 - **LDAP:** When configuring the username value for LDAP integrations, the format of the username will be an LDAP distinguished name: (uid=<CVI42-BIND-ACCOUNT>,ou=<specify each OU layer>,dc=<specify each DC layer>,dc=com)
- **Password** – The password of the AD/LDAP Bind account.
- **Anonymous connection** – When set, this will enable anonymous LDAP access.
- **Use Bind Account for Study Request URL Authentication**– (This is only applicable if the “shareURL” API is configured) When checked, study requests from URLs will be authenticated using the LDAP Bind Account. The LDAP Bind Account will be remembered and used to bind to an integrated AD/LDAP server for querying user accounts for each Study Request URL.
- **Check Name**– Use this button to verify that the configured AD/LDAP Bind Account authenticates.
- **Base DN** – Distinguished name of the location to search for AD or LDAP users.
- **Fetch DNs** – Use this button to fetch the DNs from the Base DN.
- **Username Attribute** – Specifies the AD/LDAP attribute used to indicate unique users.
 - **Active Directory:** When configuring the username attribute value for AD integrations, use a unique parameter, such as sAMAccountName.
 - **LDAP:** When configuring the username value for LDAP integrations, use the uid parameter.
- **Advanced** – This is an optional setting. It allows you to specify additional LDAP query syntax. For example, users may be required to be a member of a specific group to access **cvi42**, as an example:
 - memberOf=CN=cvi42, CN=Users, DC=example, DC=com
- **Use AD/LDAP groups for cvi42 role mapping** – This setting determines whether **cvi42** should use the integrated AD/LDAP server for user authentication and authorization (role mapping) or just for authentication. If this option is disabled, users logging in need to be listed in the **cvi42** user list and user permissions are determined using **cvi42**.

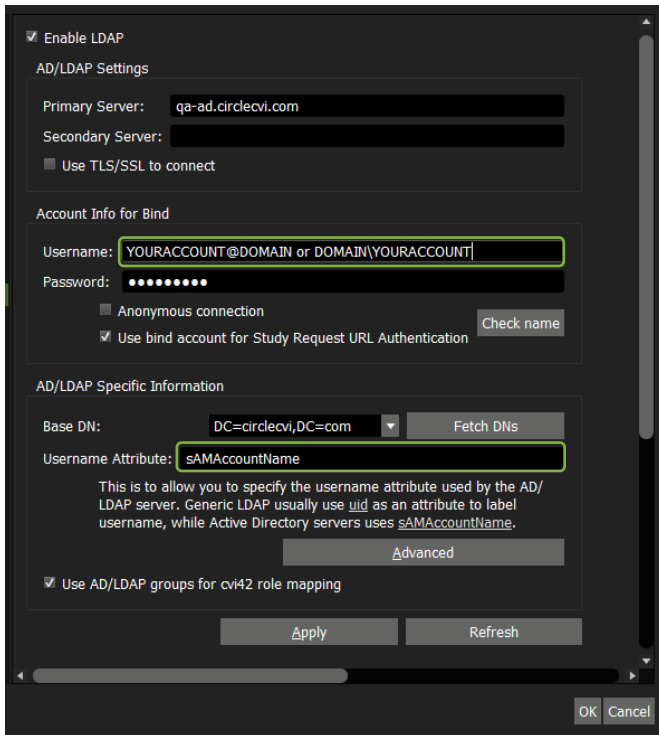

Configuration for AD

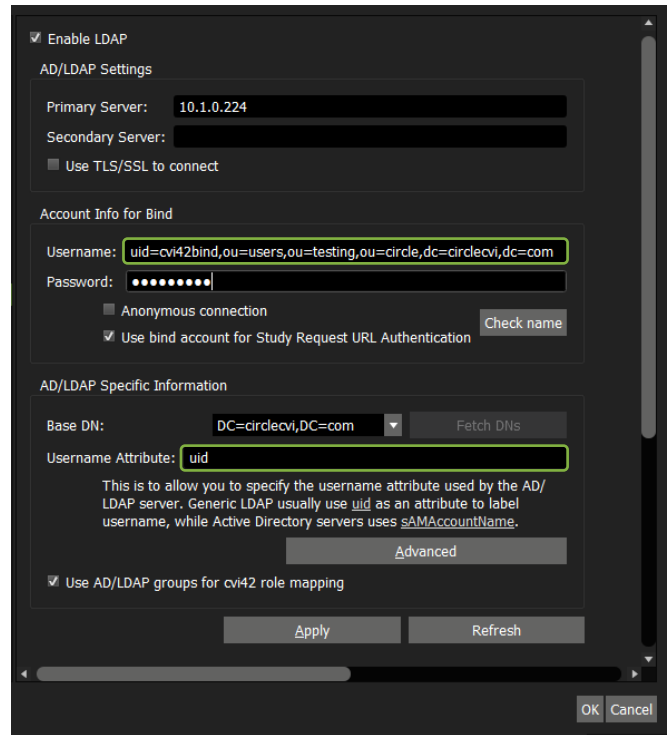

Configuration for LDAP

Once you are satisfied with the configuration click *Apply* to save the changes.

1.7.3. Windows Authentication

Windows authentication allows users using the **cv42** client applications to login to **cv42** using their current Windows domain credentials. For this to work the “Enable Windows Authentication” checkbox must be checked in the Server Admin section of the preferences. On the login dialog, the user can then click the “Login with Windows Authentication” checkbox and they will be able to login without specifying a username or password.

The “Enable Windows Authentication” option needs to be enabled in the Preferences in order to show the option on the login dialog. By default the option is off and the Windows Authentication login option is not shown.

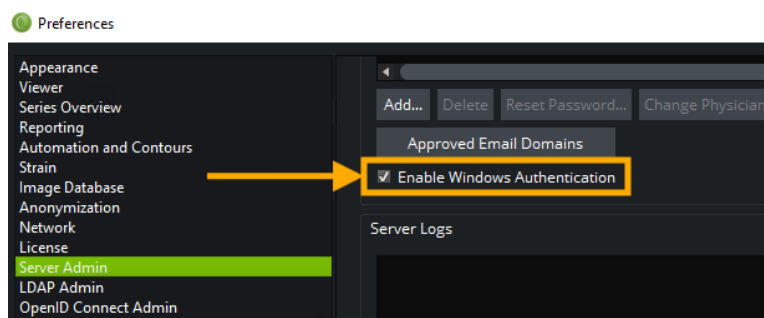

1.7.4. Role management

From the **cvi42** Server Configuration options, select `Server Admin -> Roles/Permission` button.

For more information on how user accounts are linked between the local **cvi42** authorization/authentication methods and an integrated AD/LDAP server refer to section 1.7.5 User Account Linking.

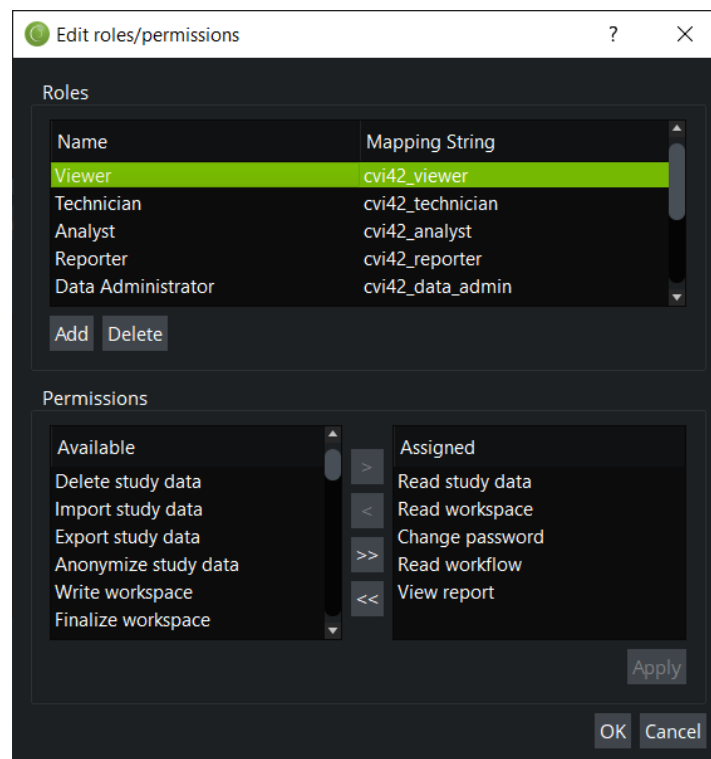

cvi42 defines a set of default roles that can be assigned to user accounts. The set of roles can be customized to meet your institution's needs.

By double-clicking the cell, Roles Name and Mapping String can be edited. Mapping String is pre-populated when **cvi42** is installed.

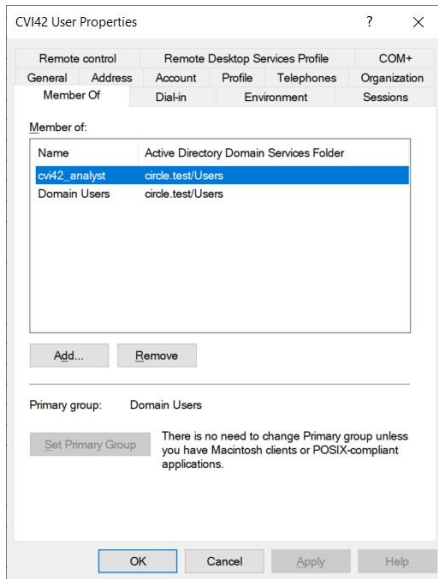

As an example, in case user is an Analyst: **cvi42_analyst** group should be assigned to the user on the AD, so when he logs in, the group the user belongs to on the AD translates to the **Analyst** role on **cvi42**. User can have multiple groups assigned to him on the AD translating to roles on **cvi42**.

If `Mapping String` is changed on **cvi42** configuration, then AD group name should be changed accordingly to correspond to **cvi42**.

Mapping String is only used when you have AD/LDAP integration enabled server and option **Use AD/LDAP groups for cvi42 role mapping** checked (check section 1.7.2).

- To edit the permissions of an existing role, select a role from the Roles list. The Assigned box in the bottom right half of the dialogue will display the permissions assigned the selected role:
 - Select permissions from either the **Available** list or **Assigned** list.
 - Click on the > or < buttons to assign or un-assign the selected permissions. The >> will assign all permissions to the role, and the << will un-assign all permissions from the role.
 - Click **Apply** to save the changes.
- To add a new role, click the **Add** button and enter a name for the new role. Proceed to assign the desired permissions to the new role.
- To delete a role, select a role and click the **Delete** button. A confirmation dialogue will be displayed. Click **Yes** to delete the role, or **No** to go back.



IMPORTANT: When roles/permissions of a particular user are changed, the settings will not take effect until the next time the user logs into **cvi42**.

1.7.5. User Account Linking

Below is a table outlining the User Account linking behaviour. For more information on configuring user accounts and user roles refer to section 1.7.

User in AD/LD AP	User in cvi42	User Account Linked	Password Used	Comments
Y	Y	Y	AD/LDAP	User is in both the cvi42 user list and in the integrated AD/LDAP server; uses the AD/LDAP password and is provided access.
Y	N	Y	AD/LDAP	User is <i>only</i> in the integrated AD/LDAP server and uses the AD/LDAP password to log into cvi42 . The user will be provided access and a New User is created in the cvi42 user list and the user account is linked to the AD/LDAP user account.
Y	Y	N	AD/LDAP	User will then be converted to an AD/LDAP account
Y	Y	N	Local	This will not convert user to AD/LDAP user
N	Y	N	Local	
Y	Y	Y	Local	Needs to authenticate with AD/LDAP password
Y	N	N	Wrong	Needs to authenticate with correct AD/LDAP password
N	N	N	Any	

1.7.6. Assigning ADAS 3D User Role



IMPORTANT: ADAS 3D is *only* available for Windows platform.

If purchased, the ADAS 3D application will be installed when installing **cvi42**. To enable user access to the ADAS 3D application, add the specific `ADAS3D User` role to each applicable user account as depicted in the following screenshot:

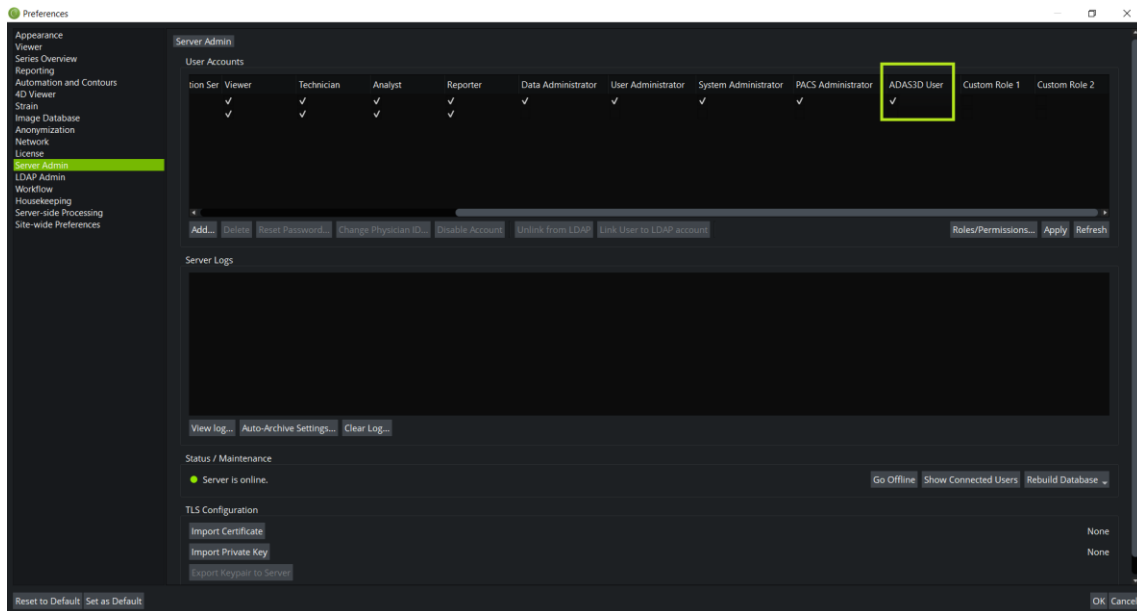

1.7.6. Assigning the TruPlan User Role

The TruPlan User role is a convient group of permissions required to access TruPlan if a TruPlan license is present. It is not required to access TruPlan but includes all the relevant permissions.

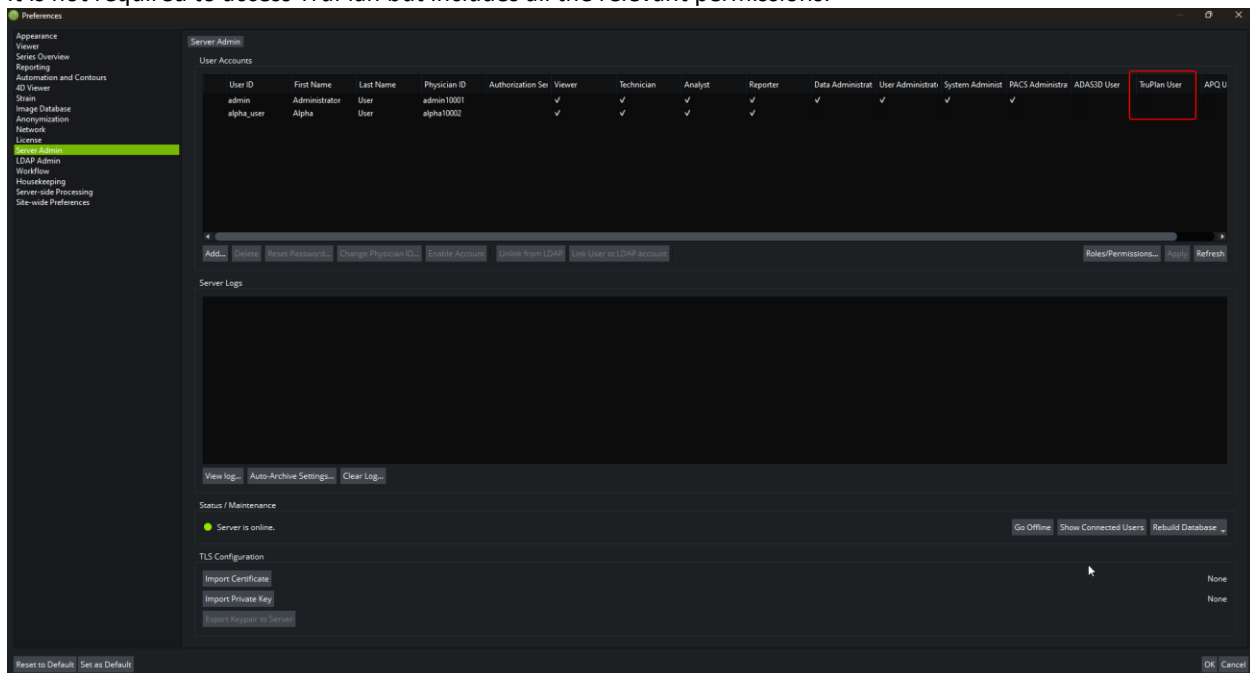

1.8. Configure Antivirus Software

Antivirus scanning can have a significant, detrimental effect on the performance of the **cvi42** application. Typical studies can contain thousands of individual image files and the time needed to scan each of those files can be significant. Folder exclusion or process/filetype profiling should be configured to exclude these files from any antivirus on both the **cvi42** Server and client.

The paths configured in `C:\ProgramData\cvi42\cvi42serverconfig.ini` should be considered for exclusion from the designated Antivirus Software Solution in favor of system performance.

However, the recommendation is to not exclude the `\cvi42imagedb\incoming_DcmStorage\` folder as incoming DICOM traffic may not be trusted.

1.9. Configure DICOM Networking (PACS Connections)

Users with 'PACS Administrator' permissions can set up the configuration for DICOM Networking/PACS connections. The admin port (default is 49697) must be used to access the Network section of the Preferences Menu.

A remote DICOM node will need to be aware of the **cvi42** Server's DICOM AE Title, the Storage SCP Port as well as the IP address of the **cvi42** Server.

The following list presents only the most important settings of this section:

Network Settings

- **AE Title** – The Application Entity Title, is used by **cvi42** to identify itself and needs to be configured on both **cvi42** and the integrated repository. By default, the AE Title is **cvi42**. This field is case sensitive.
- **Storage SCP Port** – The network port of the **cvi42** product; this value must be defined in both **cvi42** and the integrated repository.
- **Storage SCP TLS Port** – The network port of the **cvi42** product that supports Transport Layer Security (TLS) encryption; this value must be defined in both **cvi42** and the integrated repository.
- **Database update interval** – This is the interval (measured in seconds) before **cvi42** will check for updates of incoming images. By default, **cvi42** will check for updates to the image database every 10 seconds.
- **Storage Commitment Retries** – The number of attempts to send a Storage Commitment request.
- **Storage Commitment Retry Delay (sec)** - The amount of time (in seconds) to wait between each Storage Commitment request attempts.
- **Optional fields - Default MPPS Server, Default Modality Worklist Server and Default Q/R Server**

These are optional fields that can be set depending on your needs. *Default MPPS (Modality Performed Procedure Step) Server:* When a study is opened, **cvi42** reaches out to this server to obtain the Scheduled Procedure Step attributes for the study.

MWL (Modality Worklist) Server: **cvi42** sends a message to the *Default MPPS Server* with the appropriate *Performed Procedure Step* attributes.

Default Q/R Server: When **cvi42** is opened from a third-party application, the study identifier is passed to **cvi42**. If the study is not on **cvi42** Server, it reaches out to the *Default Q/R Server* to query, retrieve and import the study

Network Options

- **Enable Storage SCP** – Configuration option that enables **cvi42** to act as a Storage SCP. **cvi42** will listen for incoming DICOM C-STORE connections on the configured **Storage SCP Port** and **AE Title**.
- **Enable Q/R SCP** – Configuration option that enables **cvi42** to act as a DICOM Query/Retrieve SCP. **cvi42** will be able to be queried on image data by remote DICOM nodes.
- **Accept Unknown AE-Titles** – Configuration option that allows **cvi42** to operate in Promiscuous Mode and accept valid DICOM associations from any AE Title / IP address. It is recommended to configure all remote DICOM nodes properly instead of using this setting. This setting can also help when testing new connections.
- **Enable Low-Level Debug Log** – Configuration option that increases the logging level/details written to the application logs. This option is disabled by default and can generate large files.
- **Enable Storage Commitment SCP and SCU** – Configuration option that enables Storage Commitment Push Model SOP Class.
- **Enable MPPS SCU** – Configuration that enables the AE to log or track procedures performed by a modality.
- **Allow anonymous TLS connection** – Configuration option that enables the acceptance of anonymous Transport Layer Security (TLS) connections without requiring client authentication. This option is disabled by default and should be used with caution as it may introduce potential security risks

Remote DICOM Nodes

Used to configure the necessary DICOM connection information for any remote DICOM node.

Minimum required information: Remote Node IP address, Remote TCP Port, Remote AE Title.

Connections to remote nodes supporting TLS encryption is supported. This can be enabled by selecting the TLS option for the node. A red "x" icon will appear next to the checkbox. Clicking on the icon will bring up a dialog to select a certificate in PEM format. Once a valid certificate has been added the icon will change to a green check icon. Clicking on the green check icon will allow the certificate to be removed or reimported.

Fields Description

- **Address** - TCP Address or HostName of remote PACS.
- **AE-Title** - Application Entity Title of remote PACS (a single server might have several stores).
- **Port** - TCP port of remote PACS.
- **Description** - Pretty name for the cvi42 client UI.
- **Timeout** - Maximum wait time for a reply from Remote DICOM node.

- **Connect-As AE-Title** - Who we identify ourselves as (usually the same as the one you set above).
- **Restrict to Role** - Which user roles should be allowed to interact with this PACS.
- **TLS** - This feature allows the user to enable or disable remote node TLS support. Additionally, a button is provided to allow the user to install the CA (Certificate Authority) certificate of the remote node. The button's status indicates whether the certificate has been installed
- **Send** - Permit users to send to this PACS.
- **Anonymized Send** - Only send studies after anonymizing them (for research or consultant PACS).
- **Send Original Study** - When sending a study to a PACS, send the whole study, not just the images generated by **cvi42**.
- **Send Workspaces** - Send **cvi42** workspaces when sending whole studies.
- **Send Reports** - Send **cvi42** | Report secondary captures when sending whole studies.
- **Report DICOM Type** - Instructs report42 whether to output DICOM reports as Secondary Capture Image Series or a DICOM Encapsulated PDF document, which is rarely supported.
- **Q/R** - Allow users to query this PACS and receive from it.
- **C-GET** - Use the older C-GET protocol for receiving images, which is better when you're using a VPN or you are behind some kind of NAT router.
- **Character Encoding** - language you claim to use when interacting with the PACS.



WARNING: It is the site's responsibility to make sure TLS is enabled on the DICOM nodes for a secure environment.

1.10. Server Configuration (`cvi42serverconfig.ini` explained)

On Windows, the `cvi42serverconfig.ini` file is stored in `C:\ProgramData\cvi42`.

This file contains a list of configuration parameters for the **cvi42** Server.

Whenever changing the `cvi42Serverconfig.ini` file, the **cvi42** Server should be stopped, a backup taken of the file and changes made before restarting **cvi42** Server.

The parameters should only be edited by a server administrator, who needs to change the defaults of a particular server installation.

A description of each parameter is given below.

1.11. General Properties

Use a text editor to change the following parameters when configuring a **cvi42** Server.

- **DataFilePath** - Path to the folder containing the data for your **cvi42** system.
example: `DataFilePath=D:/ProgramData/cvi42`
- **ImageDBPath** - Path to the folder containing the image data for your **cvi42** system.
example: `ImageDBPath=D:/ProgramData/cvi42/cvi42imagedb`
- **SqlDatabasePath** - Path to the **cvi42server** database.
example: `SqlDatabasePath=D:/ProgramData/cvi42/cvi42sqldb/cvi42Db.sqlite`
- **ConnectionTimeout** - The number of seconds that a connection can be idle (no activity on the server connection) before it will be automatically closed. The default is 86400 seconds (24 hours).
example: `ConnectionTimeout=86400`
- **FailedLoginsBeforeTempLock** - Specifies the allowable number of failed login attempts before the account is temporarily locked-out. Default is 3. The lock-out duration is specified by the `FailedLoginTempLockDuration` parameter described below. If this parameter is set to -1 then the user will be locked out of the system until the administrator re-enables their account in the Server Admin preferences page. So, the lock-out duration parameter will be ignored in this case.
example: `FailedLoginsBeforeTempLock=3`
- **FailedLoginTempLockDuration** - Specifies the lock-out duration in seconds when an account is temporarily locked due to exceeding the maximum number of failed login attempts. The default is 60 seconds.
example: `FailedLoginTempLockDuration=60`
- **ClientPort** - Specifies the port that the server listens on for incoming connections. Default is 49696.
example: `ClientPort=49696`
- **AdminPort** - Specifies the port that should be used when connecting to the server to perform administrative functions. Default is 49697. Users with administrator permissions have exclusive access on this port.
example: `AdminPort=49697`
- **ClientPortIPv6** - Specifies the port the server listens on for incoming connections when using IPv6 addresses. Default is 48696.
example: `ClientPortIPv6=48696`
- **AdminPortIPv6** - Specifies the port that should be used when connecting to the server to perform administrative functions when using IPv6 address. Default is 48697.
example: `AdminPortIPv6=48697`
- **ThreadPoolSize** - Specifies the number of threads the server uses to handle incoming requests. Default is 10.
example: `ThreadPoolSize=10`
- **UseSystemProxyConfiguration** - Enables the **cvi42** Server to use the platform-specific proxy settings. Default is `false`.

- **BackgroundTaskThreadCount** – Specifies the number of threads the server uses for background task processing. Default is 4.
example: BackgroundTaskThreadCount=4
- **LogFilesPath** – Path to the folder containing the log files for the server.
example: LogFilesPath=D:/ProgramData/cvi42/ServerLogs
- **LogArchiveIntervalType** – Specifies the automatic archive interval type. Default type is 1 (daily archive). Possible values are:
 - 1 - daily (archive of logs is created daily)
 - 2 - weekly (archive of logs is created weekly)
 - 3 - monthly (archive of logs is created monthly)
 - 4 - custom interval (archive of logs is created after a custom number of days)

example: LogArchiveIntervalType=1

- **LogArchiveCustomInterval** – Specifies the number of days that will elapse before the server logs are archived. Default interval 1. The custom interval is used only when the LogArchiveIntervalType is 4.
example: LogArchiveCustomInterval=1
- **PasswordRulesEnforced** – Specifies whether the server shall enforce password length and character requirements. Default is false.
example: PasswordRulesEnforced=false

If you set this parameter to `true`, then the system will check that passwords:

- Must be at least 6 characters in length
 - Must contain at least one lower case alpha character
 - Must contain at least one upper case alpha character
 - Must contain at least one numeric character
- **PasswordExpiryThreshold** – Specifies the number of days that will elapse before users are prompted to change their password. Default is 0 days. Users will not be prompted to change the password when the PasswordExpiryThreshold is 0.
 - **RecentPasswordListSize** – Specifies the number of recent passwords that cannot be re-used when selecting a new password. Default is 0. The system will allow users to re-use any password when the RecentPasswordList size is 0.
 - **PasswordChangeRequiredAfterReset** – Indicates whether users must change their password the first time they login after an administrator has assigned (or reset) the password. Default is false.
example: PasswordChangeRequiredAfterReset=false
 - **DebugLog** – Specifies where debugging output from the server is to be captured. Default is 0 (debug output disabled). Possible values are:
 - 0 - none (debug output disabled)
 - 1 - save to file
 - 2 - console (displayed only if server is running in a command window)

example: DebugLog=0

- **ConfigBackupInterval** – Specifies how often the server config file will be backed up in seconds.
example: ConfigBackupInterval=1200
- **TrustedHosts** – Specifies a comma separated list of trusted host servers. When configuring this value provide the IP or fully qualified hostname.
example: TrustedHosts=server1.abc.com, server2.abc.com
- **EnableLdap** – A Boolean value used specifies whether or not **cvi42** should use the configured LDAP settings for user authentication/authorization. Default value is `false`.
example: EnableLdap=false
- **ForceTrustedUrlLogin** – A Boolean value parameter used to enable/disable the authentication/authorization of non-admin users with the **cvi42** user list. Default value is `false`.
example: ForceTrustedUrlLogin=true

1.12. PPU Properties

- **HostName** – Specifies the pay-per-use server to connect to when using pay-per-use licensing.
example: HostName=ppu-z01.circlecvi.com
- **Port** – Specifies the port to use for connecting to a pay-per-use server.
example: Port=443
- **Scheme** – Specifies the scheme to use for connecting to a pay-per-use server
example: Scheme=https

1.13. DICOM Network

- **CompressionScpEnabled** – This identifies whether the **cvi42** provides compressed transfer syntaxes for requests. Default is `true`.
example: CompressionScpEnabled=true
- **CompressionScuEnabled** – If configured, **cvi42** will ask for the supported compressed transfer syntaxes from the integrated repositories. Default is `true`. Some PACS require this to be set to `false`.
example: CompressionScuEnabled=true
- **RemoteDicomNodes\N\<parameter>** – This entry defines the connections for DICOM nodes (entities) that the server can interact with.
example:
RemoteDicomNodes\1\SendReports=true RemoteDicomNodes\1\AeTitle=HOROS
RemoteDicomNodes\1\CharacterEncoding=Unicode
RemoteDicomNodes\1\SendOriginalStudy=true
RemoteDicomNodes\1\ConnectAsAeTitle=CVI2019_2
RemoteDicomNodes\1\Id=@Variant (\0\0\0\x7f\0\0\0\x6Q\0\0\0\xaf\xc7\xbc\x92\x44\xa1L\xf9\x99\xdb\xe6\xb4\xdd\x99\x8f\xbf)
RemoteDicomNodes\1\RestrictToRole= RemoteDicomNodes\1\Send=true
RemoteDicomNodes\1\SendAnonymized=false

```
RemoteDicomNodes\1\ReportDicomType=Encapsulated PDF
RemoteDicomNodes\1\Description=PACS RemoteDicomNodes\1\QueryRetrieve=true
RemoteDicomNodes\1\Port=11112 RemoteDicomNodes\1\AnonymizeName=Anonymized
RemoteDicomNodes\1\Timeout=30 RemoteDicomNodes\1\SendWorkspaces=true
RemoteDicomNodes\1\CGet=false RemoteDicomNodes\1\Address=10.211.55.2
```

- **LocalPacsAETitle** – Specifies the AE Title when **cvi42** Server is configured to accept study data via DICOM push.
example: LocalPacsAETitle=CVI42
- **LocalPacsPort** – Specifies the port to use when **cvi42** Server is configured to accept study data via DICOM push.
example: LocalPacsPort=104
- **IncomingDirMonitorInterval** – The interval, specified in seconds, that the **cvi42** Server will check for incoming study data that is sent to the **cvi42** Server, and update the study list. Default is 10 seconds. This does not apply to the **cvi42** client causing the change of the study list (e.g. study import, DICOM retrieve). Its study list display will be updated instantaneously.
example: IncomingDirMonitorInterval=10
- **EnableStoreScp** – Indicates whether the server will accept study data via DICOM push.
example: EnableStoreScp=true
- **EnableQueryScp** – The server acts as a Query/Retrieve SCP for study level queries.
example: EnableQueryScp=true
- **EnableCGet** – Allows the use of C-GET instead of C-MOVE DICOM protocol for supported PACS.
example: EnableCGet=false
- **AcceptUnknownAeTitles** – Enables promiscuous mode for DICOM operations.
example: AcceptUnknownAeTitles=true
- **EnableLowLevelDebug** – Enables the DICOM debug log.
example: EnableLowLevelDebug=false
- **MaximumQueryResults** – Specifies the maximum number of results accepted from DICOM queries. Default value is 1000.
example: MaximumQueryResults=1000
- **MaximumConnections** – Specifies the maximum simultaneous number of DICOM associations that **cvi42** will allow. Default value is 10.
example: MaximumConnections=10

1.14. AD/LDAP Integrated Password Authentication

- **PrimaryServer** – Specifies the location of the Active Directory/LDAP server. **cvi42** will initially contact this server when authenticating users using Active Directory/LDAP.
example: PrimaryServer=ad-master.srclookup.com

- **SecondaryServer** – Specifies the location of the Active Directory/LDAP server. **cvi42** authenticates users using Active Directory/LDAP against the server specified by primary server. When the authentication against the primary server fails, **cvi42** will authenticate users using a secondary server, specified by this parameter.
example: `Secondaryserver=second.ad-master.srclookup.com`
- **TLSSSLConnection** – Instructs **cvi42** to construct a secure communication channel when connecting to an Active Directory/LDAP server using TLS/SSL.
example: `TLSSSLConnection=true`
- **DomainName** – Specifies the domain name, if necessary, that the user would use during login. It is important to note that Active Directory accepts two types of domain names. Firstly, define a domain name with a trailing backslash "\\\" (for example, `srclookup\\`). Secondly define a domain name with a prepended "@" (for example `@srclookup`).
example: `DomainName=srclookup\\`
- **BaseDN** – Specifies the location of the Active Directory/LDAP tree to use for user authentication, searching for users, and looking up user information.
example: `BaseDN="DC=srclookup,DC=com"`
- **UserAttribute** – Instructs what Active Directory/LDAP attribute to use when searching for users. This is important during authentication, as Active Directory/LDAP needs to identify whether the user exists on the system.
example: `UserAttribute=sAMAccountName`
- **AdditionalUserAttribute** – Specifies an additional restriction that needs to be accounted for when authenticating against Active Directory/LDAP server. For example, the Active Directory/LDAP server administrator has created a group called "cvi42", and only users in this group are permitted access to **cvi42**. In order for **cvi42** to enforce this, this parameter needs to be specified.
example: `AdditionalUserAttribute="memberOf=CN=cvi42,CN=Users,DC=srclookup,DC=com"`

1.15. OpenID Connect Integrated Authentication

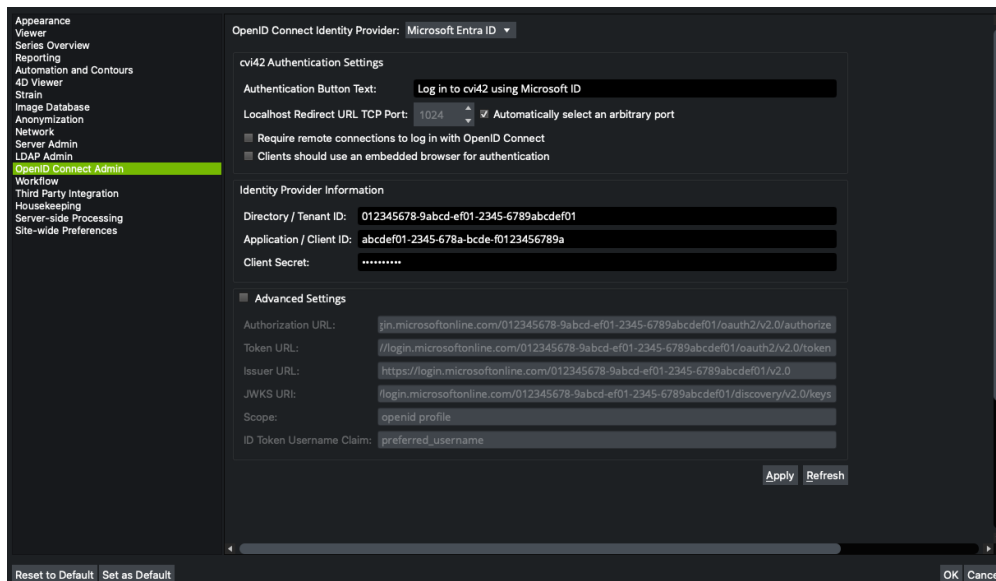

- **OpenID Connect Identity Provider** – Specifies the Identity Provider (IdP) to integrate with for OpenID Connect authentication
- **cvi42 Authentication Settings**
 - **Authentication Button Text** – Specifies the text for the login dialog button or checkbox allowing the user to authenticate with OpenID Connect. This should be a term or short sentence familiar to users when using single-sign-on with this Identity Provider, in the preferred language for the organization.
example: Log in with Microsoft
 - **Localhost Redirect URL TCP Port** – Specifies the port on user workstations to use when sending redirect information to the OpenID Connect Identity Provider during an authentication. This is an ephemeral connection and does not start a persistent service. If the Identity Provider supports arbitrary ports for localhost authentication (example: Microsoft Entra ID), it is recommended to check the *Automatically select an arbitrary port* option, which will select an open TCP port on the user workstation automatically.
 - **Require remote connections to log in with OpenID Connect** – When enabled, users connecting to the cvi42 Server over the network will only have the option to log in using OpenID Connect, blocking other modes of integrated or built-in authentication. Note that standalone installations are not affected by this setting, and neither are localhost connections so that an administrator may always log in with their preferred account on the cvi42 Server's host
 - **Clients should use an embedded browser for authentication** – When enabled, users logging in with OpenID Connect will not do so in an external web browser (possibly enabling fast single-sign-on with an existing account login), but in an embedded browser window with no cookies or cache of any kind. This option is desirable for workstations where users share a single desktop account since the user will *always* be prompted for credentials.

- **Identity Provider Information**
 - **Directory / Tenant ID:** Specifies the directory or tenant identifier for the organization in their Identity Provider. This frequently takes the form of a UUID.
example: 3a62a077-e567-48b0-b61a-d51dcf3c6094
 - **Application / Client ID:** Specifies the application or client identifier for the cvi42 application in the Identity Provider. This frequently takes the form of a UUID.
example: 3a62a077-e567-48b0-b61a-d51dcf3c6094
 - **Client Secret:** Specifies a secret generated for this installation of cvi42 in the Identity Provider. *Note that client secrets are frequently set up to expire after a certain date, so it is recommended that the administrators be made aware of this necessary maintenance and set a reminder for themselves to renew the client secret and re-enter it here.*
- **Advanced Settings** – This section provides overrides for advanced configuration of the identity provider. Identity Providers change their APIs over time, which may necessitate changes here to maintain connectivity with the identity provider. These settings are tailored to suit the selected Identity Provider at the time of the software version release and normally should not require customization. The option to customize is provided as insurance against unforeseen changes in the Identity Provider's APIs.
 - **Important Note:** *Customization of the advanced settings is not recommended without specific instructions from cvi42 product maintainers.*
 - **Authorization URL** – Specifies the URL used during OpenID Connect authorization code negotiation, per the Identity Provider's specifications.
 - **Token URL** – Specifies the URL used during OpenID Connect identity and access token negotiation, per the Identity Provider's specifications.
 - **Issuer URL** – Specifies the expected issuer URL for the Identity Provider's identity tokens, per the Identity Provider's specifications.
 - **JWKS URL** – Specifies the expected issuer URL for acquiring Identity Provider JSON Web Key Set (JWKS) data, per the Identity Provider's specifications.
 - **Scope** – Specifies the OAuth 2.0 scope(s) requested during OpenID Connect authentication, per the Identity Provider's specifications.
 - **ID Token Username Claim** – Specifies the property in the Identity Provider's identity tokens containing the username to display in cvi42, per the Identity Provider's specifications.

1.16. Server-side processing configuration (Node42)

- **MaxNumberOfThreads** – Max number of threads available for the Machine Learning processing. The default value when the server creates the server config is $\min(\max(\text{system_threads} - 2, 1), 4)$. When Node42 is started, it will take the number from the cvi42Serverconfig.ini.

If the configured number of threads is less than 1, it will be set to the default.

Log message that the value has been overridden, logNode.txt: *UNKNOWN: Using default number of threads "4", available system threads "12"*.

If it is more than max(system_threads - 2, 1) then it will use system_threads - 2.

Log message that the value has been overwritten, logNode.txt: *WARNING: Too many threads configured "50", using maximum "10"*.

You can check the number of system threads available in Windows by opening Task Manager:

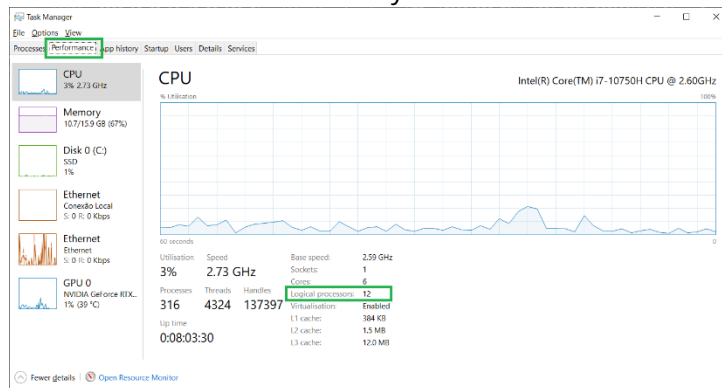

If Node42 is already running, you should kill node42 process in the Task Manager to reload configuration. **cvi42** Server starts a new node42 process if it's killed.

- **MaxProcessingTimeSeconds** – This is the maximum number of seconds node42 will process a series before timing out, and has a default value of 600 seconds (10 minutes). When processing times out, any in progress processing will be cancelled and no server side processing data will be stored for that series. If study has other series, node42 will continue processing the remaining series.
- **ContourDetectionTriggerDelay** – This is the time it takes, in seconds, for server-side processing to be triggered, after a DICOM study is completely imported into **cvi42** or a DICOM study is completely pushed from the scanner to **cvi42** Server. By completely, it means that the last image from the DICOM study is transferred to the **cvi42** Server. Default value for this parameter is 30 seconds.

1.17. Gateway Configuration (cvi42_gateway.ini)

On Windows, the `cvi42_gateway.ini` file is stored in `C:\ProgramData\cvi42.`

This file contains a list of configuration parameters for the **cvi42** Gateway.

Whenever changing the configuration file, the **cvi42** Gateway should be restarted.

Section **[cvi42server]**:

- **cvitokenpubkey** – This is the path to the **cvi42** Server public key. This key is used to validate auth tokens generated by **cvi42** Server

Section **[cvi42_gateway]**:

- **webport** – Server configuration web interface port
- **webcvi42installerpath** – Path to the **cvi42** installer packages used by **cvi42 Client Upgrade Agent**

1.18. Webclient Service Configuration (`cvi42_webclient_service.ini`)

On Windows, the `cvi42_webclient_service.ini` file is stored in `C:\ProgramData\cvi42`.

This file contains a list of configuration parameters for the **cvi42** Webclient Service.

Whenever changing the configuration file file, the **cvi42** Webclient Service should be restarted.

Section **[webclient_service]**:

- **webfqdn** – **cvi42** Web Module UI FQDN
- **webport** – non-secure port for the **cvi42** Web Module UI
- **webtlsport** – secure port for the **cvi42** Web Module UI
- **recruiterport** – port where **cvi42** Webclient Service will listen to requests coming from **cvi42** Webclient Manager
- **rpcport** – port where **cvi42** Webclient Service will listen to requests coming from a **cvi42** worker (a **cvi42** worker is a component managed by **cvi42** Webclient Manager that handles one user session. So, for instance, if there are 5 users connected to the **cvi42** Web Module, there should be 5 instances of **cvi42** worker running)

To setup HTTPS connection to the **cvi42** Web Module, these properties must be set:

- **webtls** – (true|false), to enable/disable HTTPS connection to the **cvi42** Web Module, when setting this parameter to true, you need to setup the certificate and private key:
 - **webtls-cert** – path to the TLS certificate
 - **webtls-key** – path to the TLS private key
- **webforcehttps** – (true|false), when true, will redirect the user to HTTPS connection when user tries to log into **cvi42** Web Module in the HTTP mode

1.19. Webclient Manager Configuration (`cvi42_worker_manager.ini`)

On Windows, the `cvi42_worker_manager.ini` file is stored in `C:\ProgramData\cvi42`.

This file contains a list of configuration parameters for the **cvi42** Webclient Manager.

Whenever changing the configuration file file, the **cvi42** Webclient Manager should be restarted.

Section **[worker_manager]**:

- **webclientservicehost** – FQDN of **cvi42** Webclient Service
- **webclientservicerecruiterport** – port that **cvi42** Webclient Service will be listen for connections (should be the same as **recruiterport** in the **cvi42** Webclient Service)

2. cvi42 Configuration Portal

In 5.16 and later releases we are introducing a new method to configure the **cvi42** Server named **cvi42 Configuration Portal**.



IMPORTANT: **cvi42** Configurator Portal is the web interface to configure **cvi42** Server properties. It still limited in terms of functionality; administrators can experiment it however the preferable way to configure the server is by login in the **cvi42** Server admin port.

You can access **cvi42 Configuration Portal** via a browser by the url: `http(s)://<IP or FQDN>:4299`

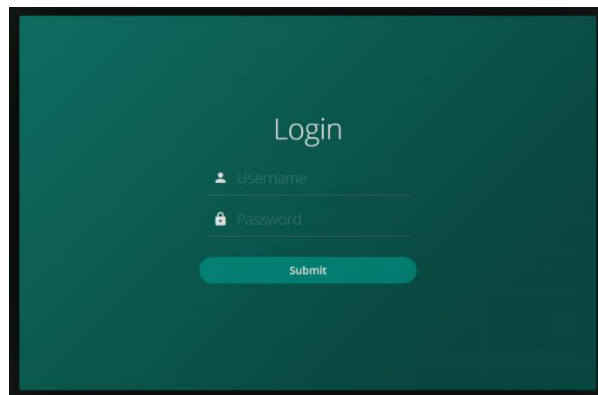

Default credentials: **admin / (password changed during installation)**

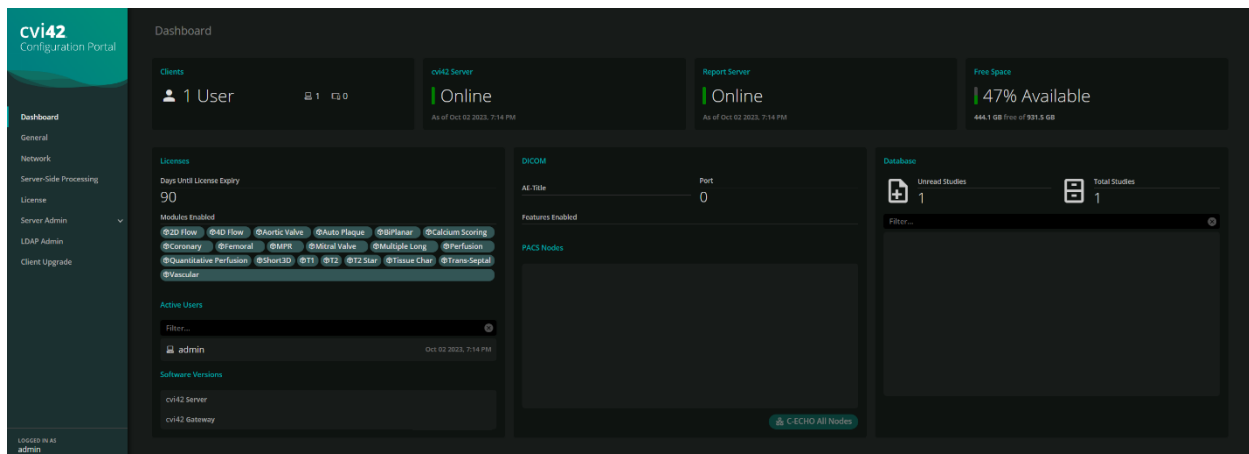

The interface is very intuitive, in the Dashboard you can check the status of the **cvi42** Server components, check licenses available, etc.

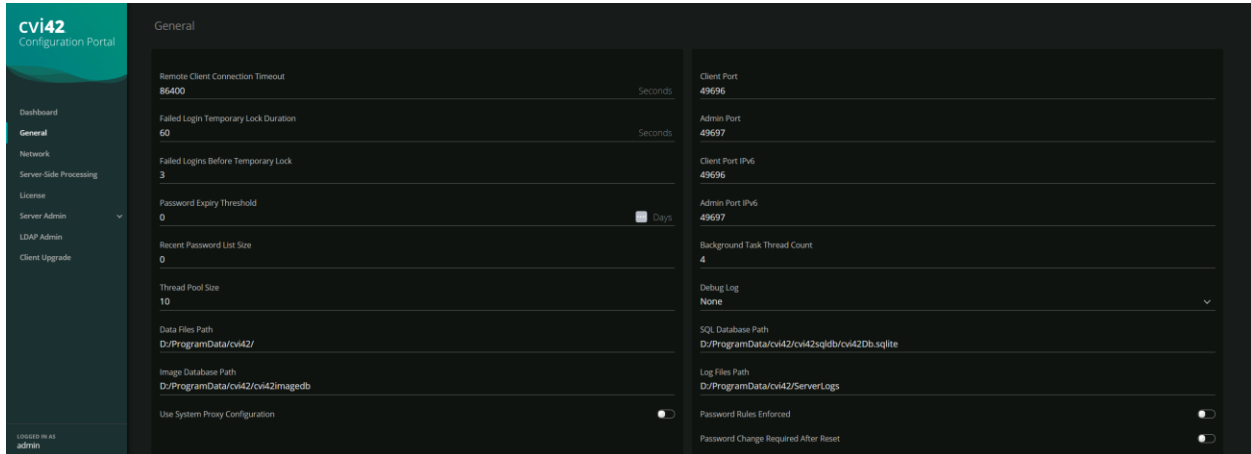

In the General option, you can change some of the server parameters, paths of data and database folders, ports, etc. You should restart the **cvi42** Server whenever these configs are changed.

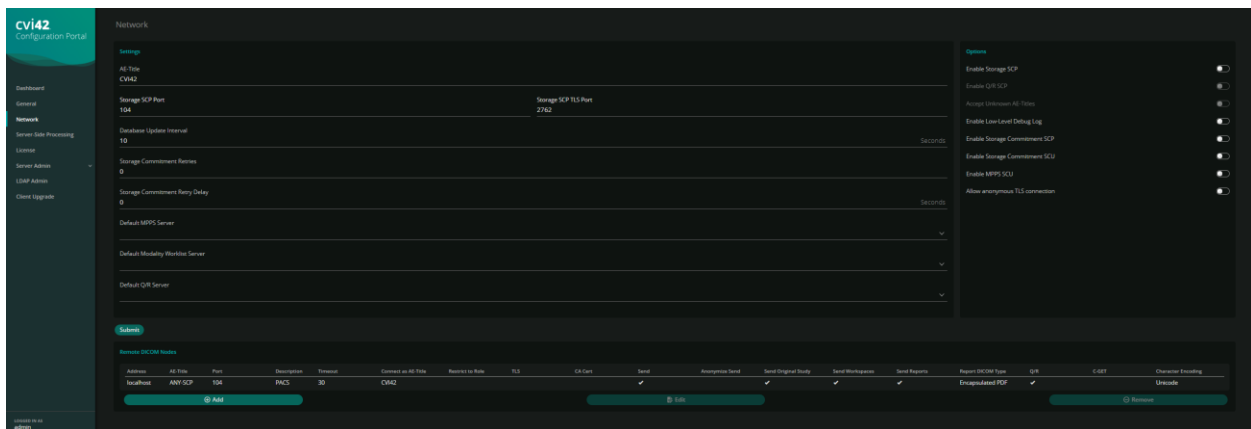

This interface has similar functionality described in section 1.9

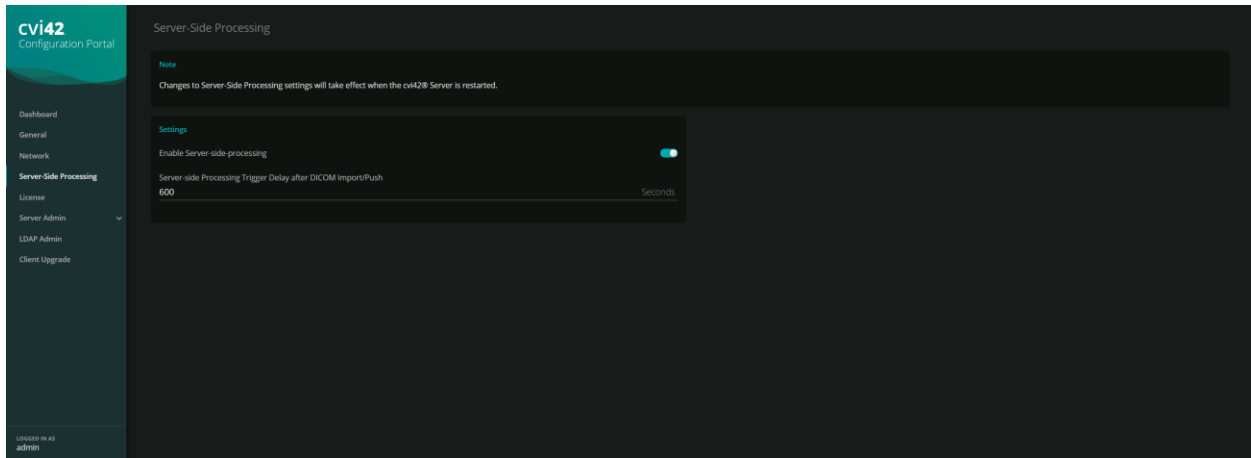

Server-side processing enables the server to perform AI on imported studies. To enable, toggle the **Enable Server-side-processing** switch. Server-side Processing Trigger Delay after DICOM Import/Pushes the time to wait since last image for a study was received before triggering AI processing on that study.

IMPORTANT: If **cv42** Server is installed on a separate machine, you should open TCP/4298 port on this machine, so **cv42** client can communicate to the server-side processing component. You should open the *Windows Defender Firewall*.

For the remaining steps of the configuration, just use the defaults and in the final screen give a name for the rule.

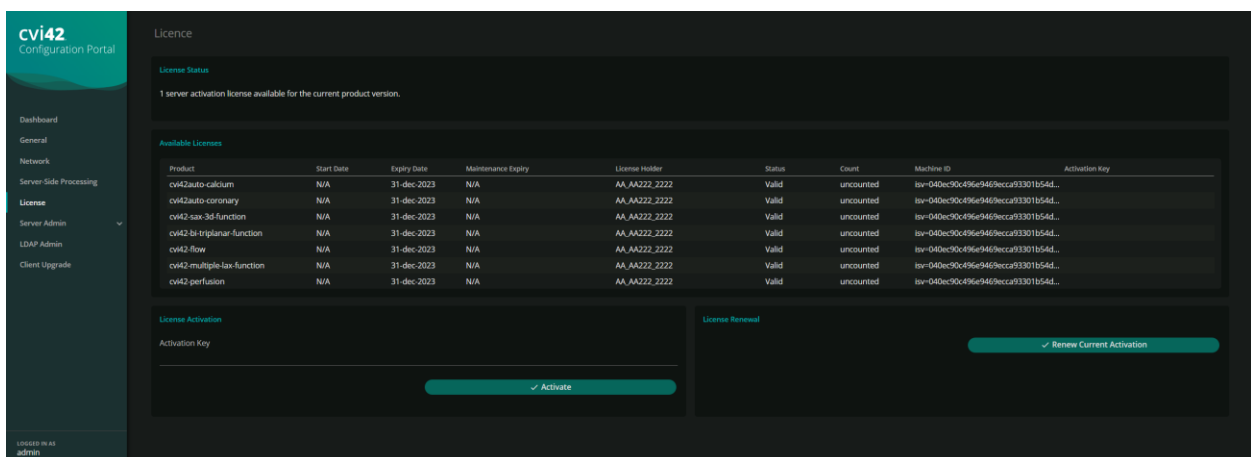

The License page can be used to activate your licenses by entering an activation key or renew current activation.

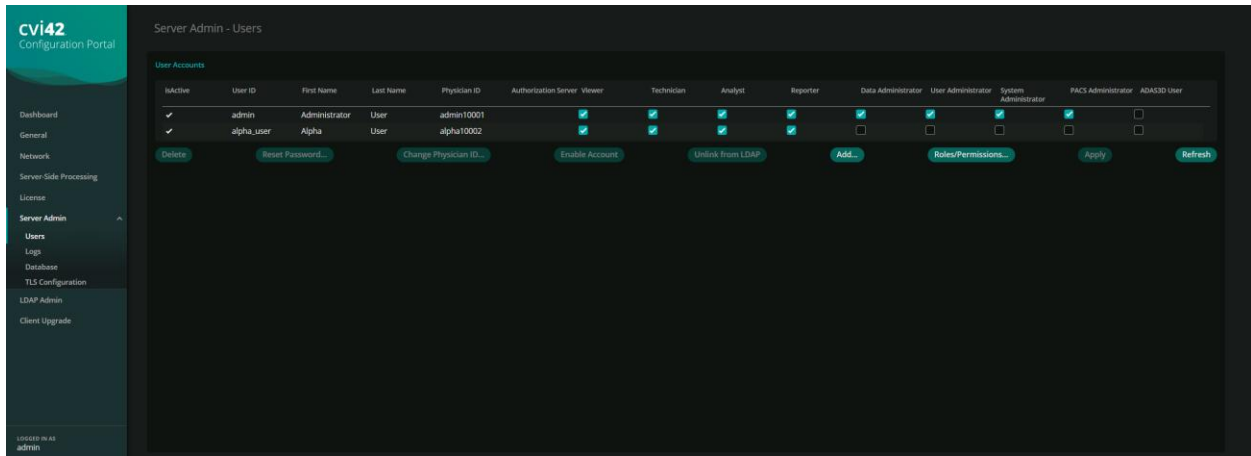

The **Server Admin->Users** page can be used to manage users, roles and permissions.

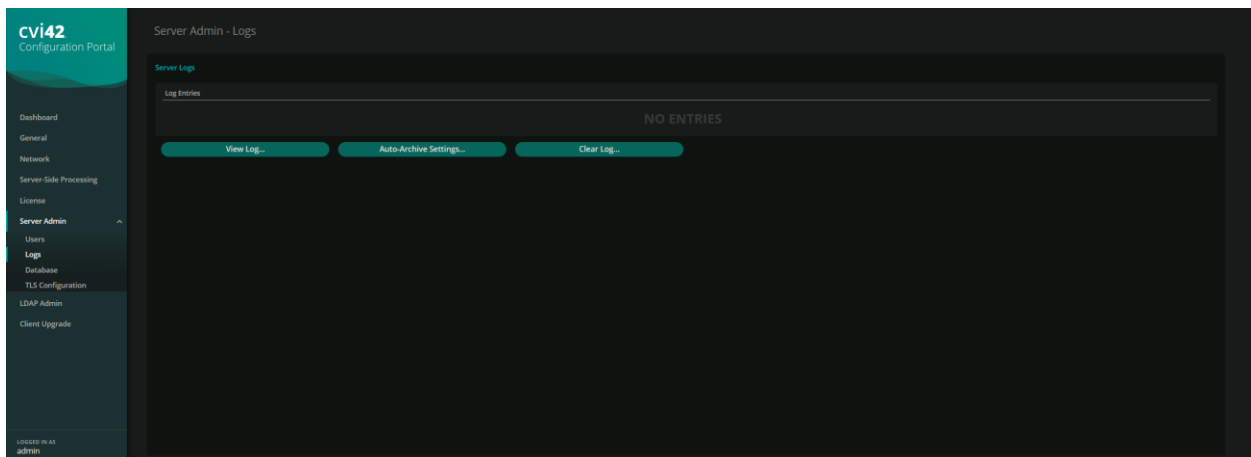

The **Server Admin->Logs** page can be used to view and manage the **cvii42** Server logs.

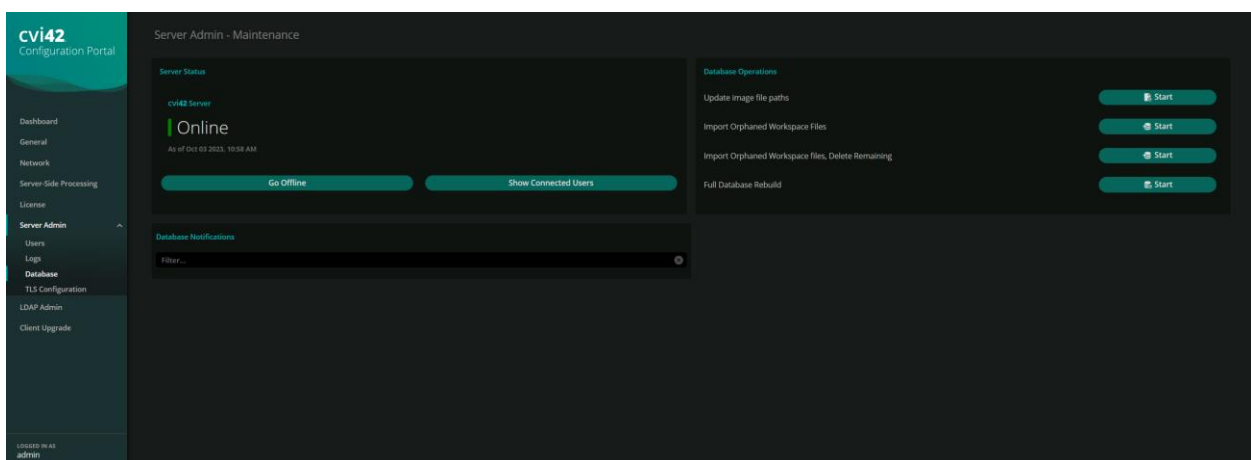

You also have several functions to manage the **cvii42** Server database.

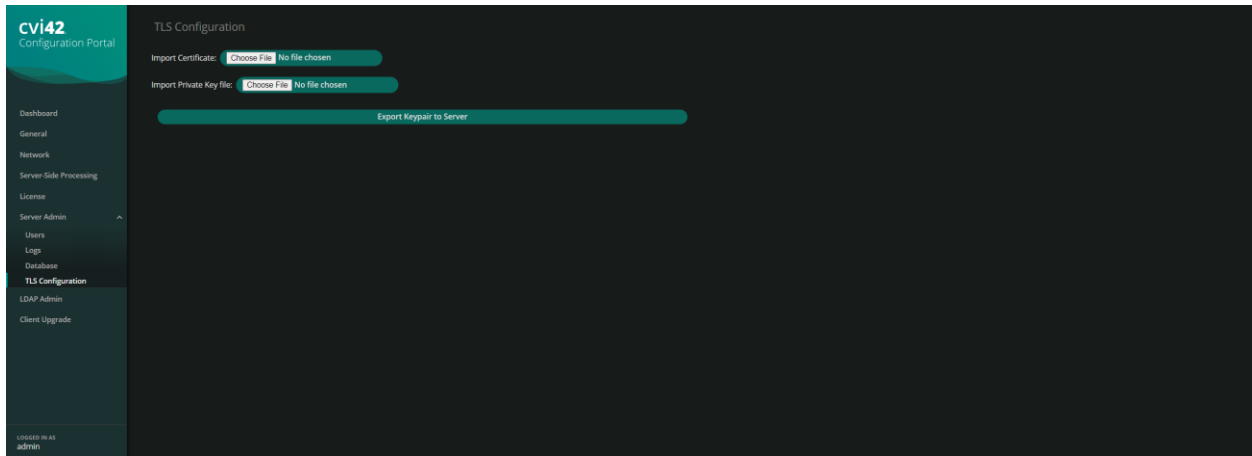

You can setup certificate for TLS connection, this setup is also available in **cv42** Client.

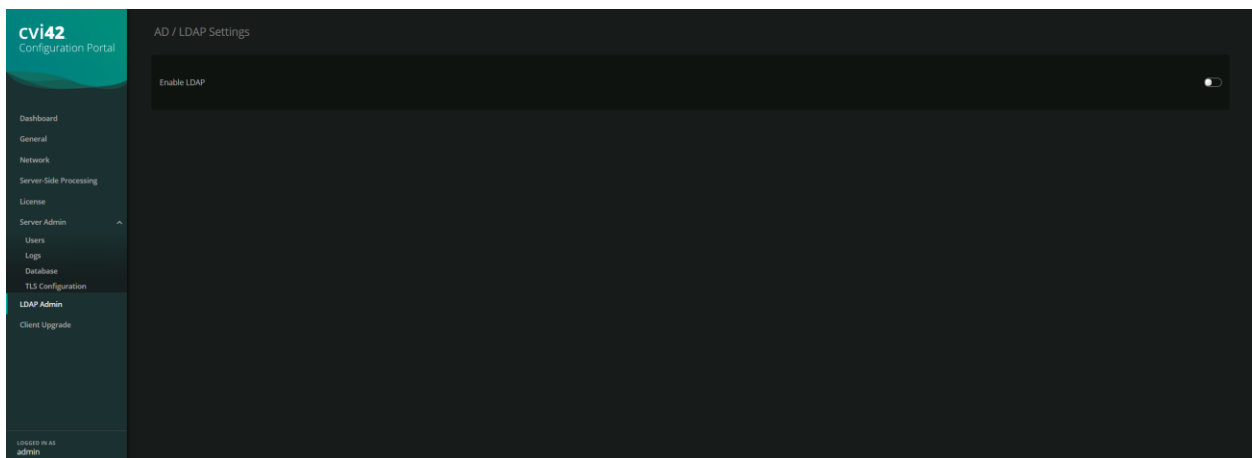

You can setup connection to AD/LDAP, this setup is also available in **cv42** Client.

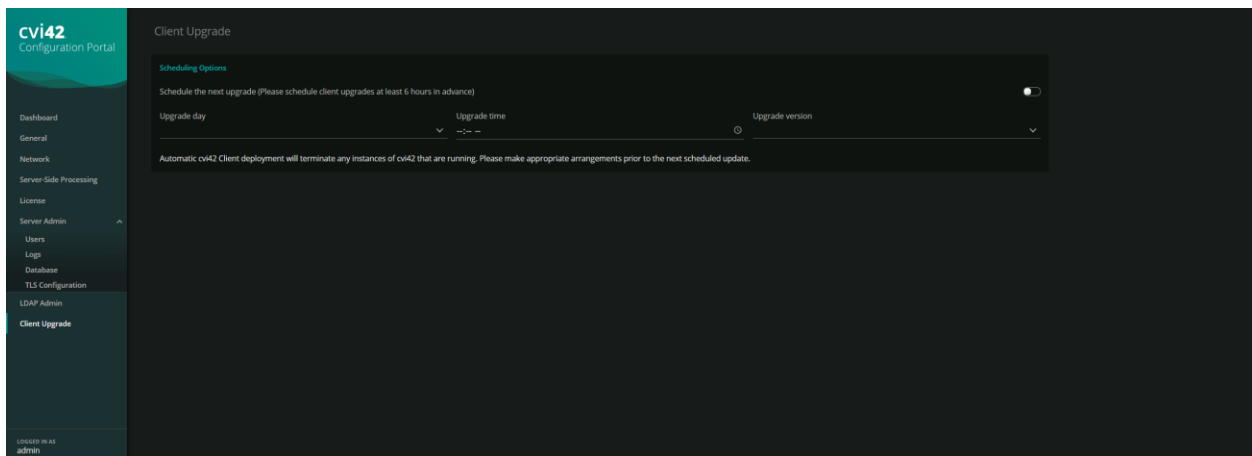

The **Client Upgrade** page can be used to schedule the deployment of installer packages saved during the install process with the **Save installer package for IT-scheduled client upgrades** server install option. When an upgrade is scheduled, client machines that have been configured with the **cvi42 Client Upgrade Agent** install option will download the selected installer package before installing a newer version of **cvi42** at the set time.



IMPORTANT: IT-scheduled client upgrades feature allows IT Administrators to update clients remotely. If you have already an automated method for updating clients, this feature is not recommended for you. Please contact Circle's Customer Support Team at support@circlevi.com to obtain more information about **IT-scheduled client upgrades**.

3. Housekeeping

The housekeeping system is a rule-based system to automate maintenance of the **cvi42** DICOM study database. Typical use-cases are archival, routing and workflow.

3.1. Overview

All actions of the housekeeping system are defined by a list of rules. Each rule consists of a set of criteria and a list of actions. All criteria must be satisfied in order for a rule to apply to a specific DICOM study.

The housekeeping system is active according to a weekly schedule specified by the administrator. When the housekeeping system is active, it matches the list of rules against the **cvi42** DICOM study database periodically and executes resulting housekeeping actions. The matching interval is specified by the administrator.

3.1.1. Rule matching

The housekeeping system will periodically process the list of rules and match it against the studies present in the **cvi42** DICOM study database. For this, the system considers each study and matches its properties against the list of rules in order from top to bottom. When the criteria in a rule match, the actions specified in the rule are queued for execution. Subsequent rules will be matched against the study under consideration once the actions of the applying rule have been executed. After a rule has matched or all rules have been considered for a specific study, the next study is matched against the rule list until all studies have been processed.

Once matching has completed, the queued housekeeping actions are executed.

3.1.2. Rule execution

All queued actions are processed in order of queuing. All actions are logged. Depending on the specific action, a failed action results in the execution of the whole rule to either fail or to be suspended for retry at the point of failure. Retry is supported for actions that are likely to succeed when retried such as DICOM study export (which may fail due to temporary lack of disk space) or DICOM network transmission (which may fail due to intermittent network problems or PACS server downtime).

After all queued rules have been executed, another rule matching run is invoked because rules in general depend on study attributes that are changed by rule execution, for example, assignment/removal of study tags.

3.2. Rules

Housekeeping rules consist of:

- a name (for reference)
- a flag for enabling/disabling a rule (temporarily or permanently)
- the recurrence definition:
 - "once" or "periodically" with an interval in days, weeks, months or years
- a list of criteria
- a list of actions

3.2.1. Criteria

3.2.1.1. *Study Date*

This criterion filters studies by the DICOM study-date attribute. Studies are filtered by their age, i.e. as "older than" or "newer than" a specified number of days, weeks, months or years.

Studies that lack the DICOM study-date are treated as "in the future" which means that rules that select studies that are i.e. "older than one year" will never match. It may make sense to use the "import date" criterion instead.

3.2.1.2. *Study Description*

This criterion filters studies by the DICOM "study description" attribute. The description is matched against either:

- a fixed string
- a fixed substring
- a wildcard pattern:

- "?" matches any character
- "*" matches zero or more arbitrary characters
- "[...]" matches any of the characters listed inside the brackets
- any other character matches only itself
- a regular expression:
 - Please see <http://qt-project.org/doc/qt-4.8/qregexp.html#introduction>.

Matching is set to be either case-sensitive or case-insensitive.

3.2.1.3. Institution Name

This criterion filters studies by the DICOM "institution name" attribute. The matching is done as described in section 3.2.1.2 Study Description.

3.2.1.4. Manufacturer

This criterion filters studies by the DICOM "manufacturer" attribute. The matching is done as described in section 3.2.1.2 Study Description.

3.2.1.5. Model

This criterion filters studies by the DICOM "model" attribute. The matching is done as described in section 3.2.1.2 Study Description.

3.2.1.6. Modality

This criterion filters studies by the DICOM "modality" attribute. The matching is done as described in section 3.2.1.2 Study Description.

3.2.1.7. Study Size

This criterion filters studies by their size (in MB). The studies are filtered by comparing the study size against a given size.

When upgrading from an earlier version of **cvi42** Server, the study size database field is only initialized at first use. The first run of a housekeeping rule list that contains the study size criterion will thus take significantly more time than subsequent runs because aggregating the study size from the DICOM image database causes high disk activity.

3.2.1.8. Import Date

This criterion filters studies by the import-date attribute. Studies are filtered by the age of the import date, i.e. as "older than" or "newer than" a specified number of days, weeks, months or years.

The import date is always present and is updated whenever new DICOM image data is added to a study.

3.2.1.9. Date of Last Read

This criterion filters studies by the date-of-last-read attribute. Studies are filtered by the age of this date, i.e. as "older than" or "newer than" a specified number of days, weeks, months or years.

The date of last read is initially empty and treated as "in the future" in this case. It is updated whenever the study is opened or closed. Display of the study in the patient list does not update the date of last read.

3.2.1.10. Date of Last Write

This criterion filters studies by the date-of-last-write attribute. Studies are filtered by the age of this date, i.e. as "older than" or "newer than" a specified number of days, weeks, months or years.

The date of last write is updated when the study is initially imported, images are added to or removed from the study or workspace data is saved.

3.2.1.11. Study Tags

This criterion filters studies by the tags assigned to the study. Studies are selected when the assigned tags "contain any of" or "miss any of" a given set of tags. Rules that require a study to "contain all of" or "miss all of" a given set of tags can be built by using multiple "Study Tags" criteria.

3.2.1.12. Available Disk-Space

This criterion relates to the available disk-space (in MB) of the storage media in which the DICOM image database file system resides. This value is not a study attribute and therefore enables or disables the rule altogether depending on the available disk-space. The available disk-space is compared to a specified value.

3.2.2. Actions

3.2.2.1. Assign Study Tags

This action assigns a given set of tags to the study. Assigning a tag that is already present is not an error. Other tags that are assigned to the study are kept.

3.2.2.2. Remove Study Tags

This action removes a given set of tags from the study. Removing a tag that is not present is not an error.

3.2.2.3. Convert Workspace Data to DICOM

This action converts all workspace data of the study to DICOM workspace format. Workspace data of all users is converted. This action is useful to run before 3.2.2.4 Store DICOM Data on PACS or 3.2.2.5 Export DICOM Data to filesystem such that the corresponding workspace data is transferred alongside the DICOM image data.

This action has the option to use the "Secondary Capture Image Storage" DICOM SOP class instead of "Multiframe Grayscale Byte Secondary Capture Image Storage" or "Multiframe True Color Secondary Capture Image Storage" DICOM SOP class if necessary.

3.2.2.4. Store DICOM Data on PACS

This action stores DICOM data of the study on a specific DICOM node. This action can either store all DICOM data or can be limited to only store DICOMs generated by **cvi42**. In the latter case, the action can be further limited to only store workspace DICOMs, report DICOMs and/or other DICOMs generated by **cvi42** (i.e. reformatted images).

As this action can potentially cause data to be sent to unintended destinations, special care must be taken when using this action. Please, refer to section 3.3.1 Simulation for steps on verifying that the rule matches only the desired studies.

Please note that if PACS names have been changed or added in the configuration dialogue but not yet saved to the server, the Housekeeping configuration UI will still show the names as configured on the server.

3.2.2.5. Export DICOM Data to filesystem

This action exports DICOM data to filesystem. The type of DICOM data that is exported can be limited as described in section 3.2.2.4 Store DICOM Data on PACS. The directory path specified as export target may contain the following placeholders which allow to automatically build up a chronological directory structure:

- "{YYYY}" is replaced by the 4-digit year
- "{YY}" is replaced by the 2-digit year
- "{MM}" is replaced by the 2-digit month
- "{DD}" is replaced by the 2-digit day of the month

Placeholders may occur multiple times. Example: "E:\DicomArchive\{YYYY}\{YYYY}-{MM}\" will export to:

- "E:\DicomArchive\2014\2014-12\"

- "E:\DicomArchive\2015\2015-01\"
- "E:\DicomArchive\2015\2015-02\"
- ...

Each study will be placed into an individual sub-directory of the specified export directory.

3.2.2.6. Delete Study

This action removes all DICOM data and workspaces of the given study from the database. As this action is not revertible, special care must be taken when using this action. Please, refer to section 3.3.1 Simulation for steps on verifying that the rule matches only the desired studies.

Alternatively, refer to section 3.2.2.1 Assign Study Tags in order to assign a "trash bin" tag instead of directly deleting the studies. This allows to review which studies are assigned to the "trash bin" tag and then delete those manually from the patient list.

3.2.2.7. Stop processing subsequent rules

This action causes the subsequent rules in the rule list not to be considered for the matched study. The stop is active as long as the study still matches the criteria, i.e. independently of rule recurrence.

3.2.3. Recurrence

Recurrence defines whether a rule is applied repeatedly to the same study. Recurrence is defined as either of:

- "once" – the rule is only applied once to each matching study. Even if the rule criteria/actions are changed later, studies that have been processed by the rule once, are not considered again. (If it is intended that the rule shall be applied again to all matching studies once, i.e. because the criteria or actions have been changed, the rule can be duplicated, and the original rule be deleted. The duplicated rule is considered unrelated by the Housekeeping system and all studies will be considered for the rule again.)
- "periodically every N days/weeks/months/years" – the rule is considered again for a previously processed study after the specified time has elapsed after queuing of the last rule execution on the study.

Rule recurrence can be changed later. After switching from "once" to "periodically", studies that have been processed before are considered again (after elapse of the period interval). Likewise, after switching from "periodically" to "once" all studies that have ever been processed are not considered anymore.

3.3. Rule Editor

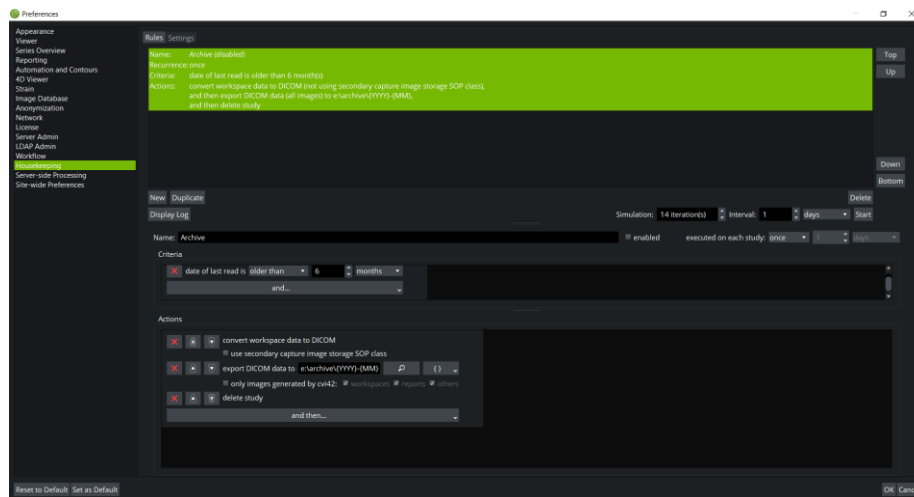

The rule editor is located in the **Rules** tab of the Housekeeping section of the configuration dialogue. The Housekeeping section is only enabled when connected to the server administrator port. In the upper part of the rule editor, the rule list is displayed. For each rule, the name, recurrence, criteria and actions are listed. The names of disabled rules are written in *italic*.

The top/up/down/bottom buttons to the right of the rule list are used to move the currently selected rule to the top/bottom or up/down in the list. The new/duplicate/delete buttons below the rule list are used to create, duplicate or delete rules.

The "display log" button is used to open the log and control interface (refer to section 3.5 Log and Control). To the right of the "display log button", the effect of the edited (unsaved) rule list can be simulated, refer to section 3.3.1 Simulation.

In the lower part of the rule editor, the currently selected rule can be edited. This section starts with the field for the rule name, the "enabled" checkbox and the specification of the recurrence. Below, there are two panes in which the criteria and actions are composed.

The criteria are composed by clicking "and . . ." and selecting the desired criterion (repeatedly). For each criterion, a line is added to the criteria pane for editing the specific properties of the criterion. A criterion can be removed again by clicking the "x" button at the start of the line. As all criteria are combined by a logical "and", the order is insignificant and cannot be changed.

The actions are composed by clicking "and then . . ." and selecting the desired action (repeatedly). For each action, a line is added to the actions pane for editing the specific properties of the action. An action can be removed again by clicking the "x" button at the start of the line. As the order of actions is significant, actions can be reordered using the "move up" and "move down" buttons next to the "x" button.

Please note that new rules are initially set as "disabled" such that the "enabled" checkbox needs to be ticked manually after the rule has been composed.

Please note that when a rule is deleted, executions of the rule which have already been queued but have not yet been processed are cancelled.

3.3.1. Simulation

The currently edited rule list can always be simulated against the current **cvi42** DICOM study database. Only rules that are marked as "enabled" are active in simulation as in execution. A simulation is started by specifying a number of simulation iterations, a time interval for each iteration and clicking the "start" button. As many rules include ages (i.e. age since study import, age since last read, ...) it is important to cover a relevant time-span for simulation. For example, when working on a rule that archives data after a year, selecting a simulation of 24 iterations with an interval of one month would be appropriate while in contrast 10 iterations with an interval of one day wouldn't give meaningful results.

Apart from the effect of the lapsed time, simulation also handles the effects of tag assignment/removal and the stop action. This can be used to simulate workflow rule sets. Simulation also handles study deletion and will not match rules against studies that are simulated as deleted again.

Other actions are merely logged for the simulation results, i.e. when simulating "convert workspace data to DICOM", "store DICOM data on PACS" or "export DICOM data to filesystem" actions, no further simulation such as checking DICOM node connectivity or checking for available disk-space is carried out.

While simulation is running, a progress indicator is shown in the "simulation" section of the rule editor. Once finished, the results are displayed in a separate "Housekeeping simulation results" window.

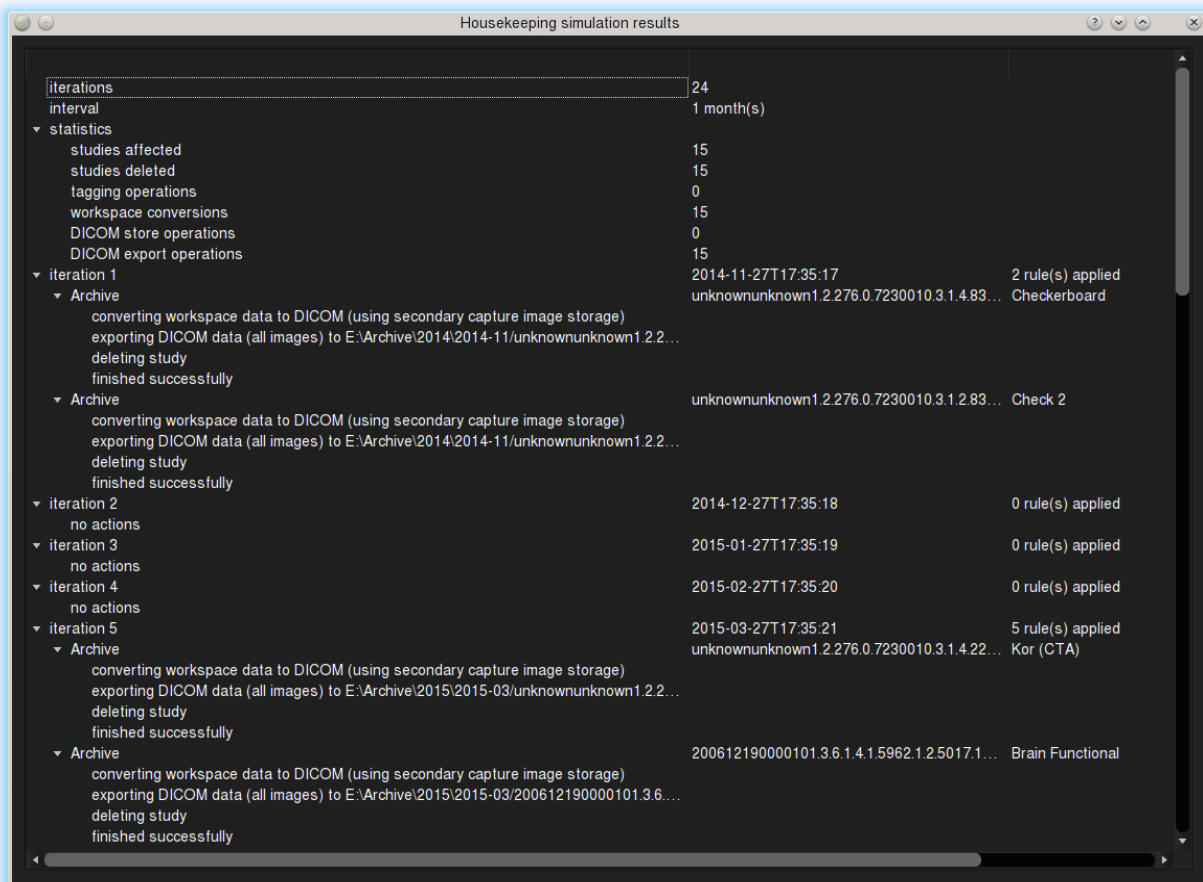

The result first lists the selected number of iterations and interval. Then a statistical summary of the simulation is given, counting the total number of affected studies and how often actions of different classes were executed (studies deleted, tagging operations, workspace conversions, DICOM store operations, DICOM export operations).

Next, the individual simulation iterations are listed: The first line lists the simulated date and how many rules applied in total. Then, each rule application is listed by the rule name, the study that the rule applied to (including the DICOM study instance UID and the patient name for reference) and the list of actions that were simulated.

Please take care to review the simulation results carefully to make sure the rule list behaves as intended. This is particularly important for rule lists that include the "delete study" action which can lead to irrevocable data loss and for rule lists that include the "store DICOM data on PACS" action which can potentially lead to sending data to unintended destinations.

3.4. Settings

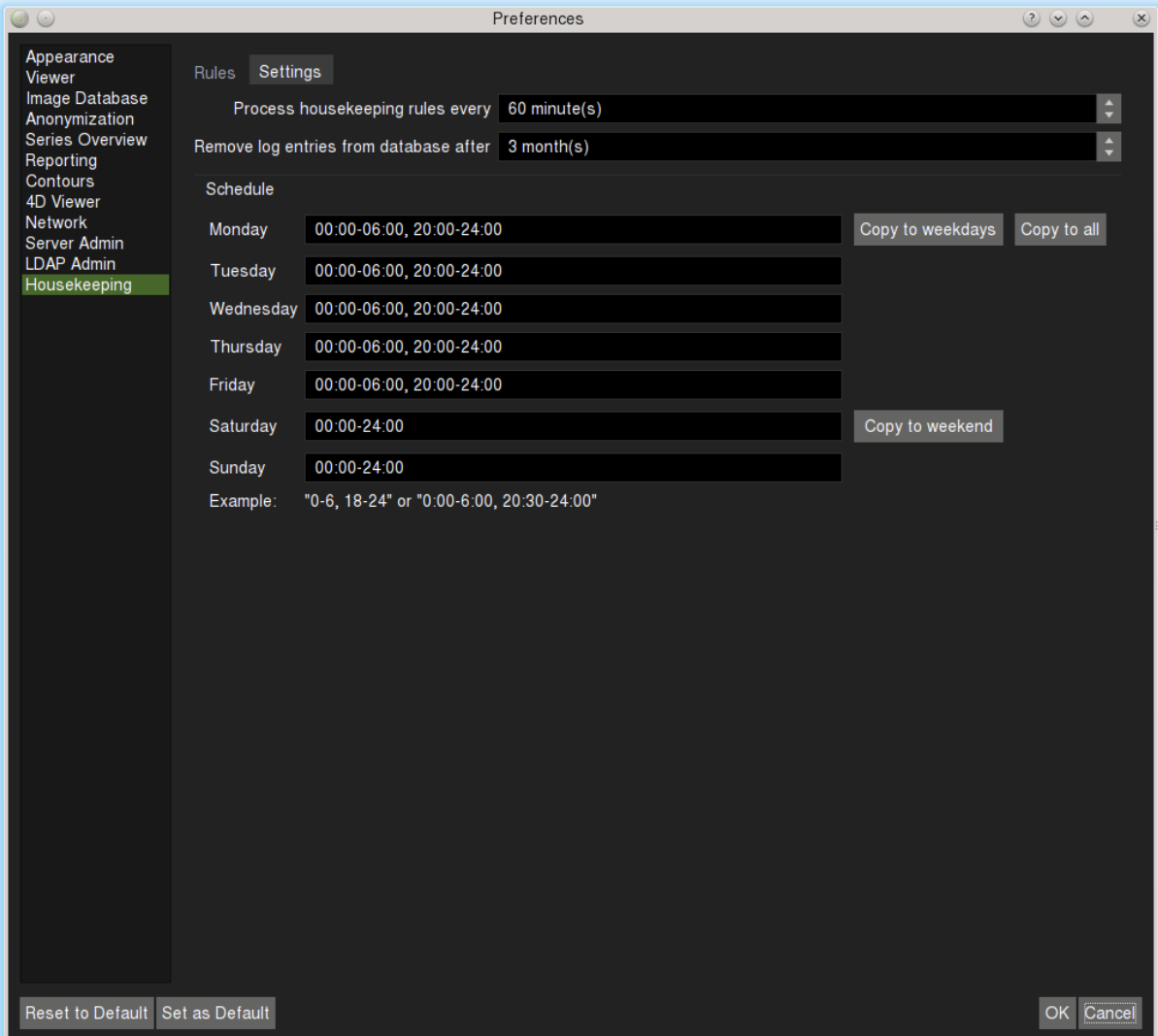

In the "Settings" tab of the Housekeeping section in the configuration dialogue, parameters for the overall behaviour of the Housekeeping system are specified.

The first setting is the interval in which the housekeeping system processes its rule list during hours of operation. Smaller values put a higher load on the server but may be desirable when using rule lists for workflow organization.

The second setting specifies how long the server will retain log entries inside the database. These log entries are displayed in the 3.5 Log and Control. Only log entries that are not needed for the system anymore (i.e. for keeping track of which studies a rule has already been applied to) are removed from the database after the specified period of time. Apart from the logs kept in the database, the Housekeeping system also logs all actions to the `logHousekeeping.txt` file to which this setting does not apply.

Below this, the Housekeeping system schedule can be defined as a list of timespans per weekday. Buttons are provided to copy the data entered for Monday to all week or all weekdays and to copy the data entered for Saturday to all weekend. The schedule can be used to ensure, the Housekeeping system activities do not interfere with day-time usage of the system.

3.5. Log and Control

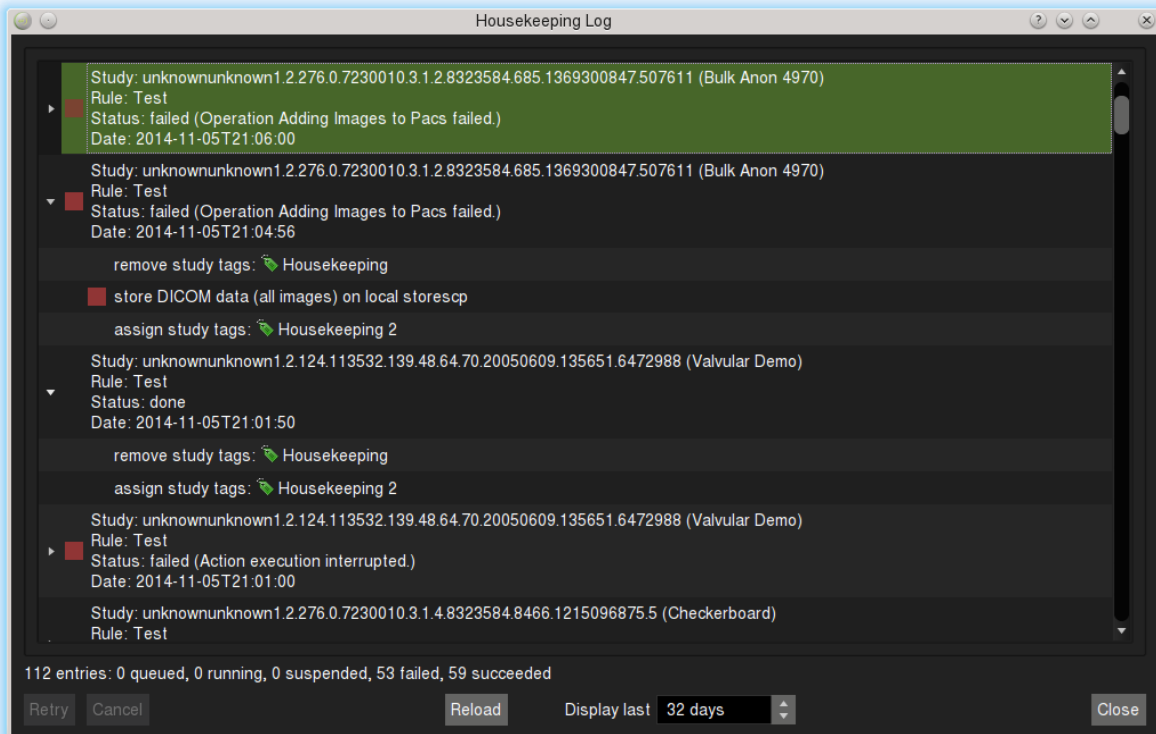

The log and control interface displays the most recent activities of the Housekeeping system. For each applied rule, the study (including DICOM study instance UID and patient name for reference), the rule name, the status and the date of the entry are displayed.

While the rule is queued for execution, it is marked with a blue button. If rule execution has failed, it is marked with a red button. If it is suspended for retry, it is marked with a yellow button. Each entry can be expanded by clicking on the triangle icon to the left in order to display the specific actions.

At the bottom of the window, the retry/cancel buttons can be used to retry or cancel selected suspended rules. As studies that have a suspended rule are not considered for other rules, it is important to review the log periodically. Queued rule executions cannot be cancelled manually but are cancelled when the rule is deleted.

The reload button reloads the log from the server. The spin-box next to it is used to specify the timespan to display the log for. After changing the timespan, the list is reloaded automatically.

4. cvi42 Default Roles

Role	Permissions
Viewer	Able to view study data and existing workspaces.
Technician	Able to import study data and enter patient biometric data.
Analyst	Able to save analysis on study data in workspaces or copy other user workspaces.
Reporter	Able to report on study data.
Data Administrator	Able to clean up the database and unlock user accounts.
User Administrator	Able to create, edit, and delete users accounts.
System Administrator	Able to alter system properties and administrate logs.
PACS Administrator	Able to manage PACS server connection properties
ADAS3D User	Able to open studies in ADAS3D

5. cvi42 Network Communications Matrix

Category	Source	Destination	Default Port	Comment
Mandatory	cvi42 clients	cvi42 Server	tcp/49696	User port with no encryption - If TLS certificate is present this will only listen on localhost
Mandatory	cvi42 clients	cvi42 Report Server	tcp/4280 (http, websocket)	Report Web Interface
Mandatory	cvi42 clients	cvi42 Server	tcp/4298 (http)	Server-side processing
Mandatory	cvi42 clients	cvi42 Server	tcp/4299 (http)	Server configuration web interface
Mandatory	PACS / Scanners	cvi42 Server	tcp/104 (DICOM)	DICOM listener
Mandatory	cvi42 Server	https://rlm.circlecvi.com	tcp/443 (https)	Online License Activation
Mandatory	cvi42 Web Viewer	cvi42 WebClient Service	tcp/4293 (http ws)	User port with no encryption
Mandatory	cvi42 Web Viewer	cvi42 WebClient Service	tcp/4287 (http ws)	Web reverse-proxy port to cvi42 report webserver (Apache)
Optional	PACS / Scanners	cvi42 Server	tcp/2762 (DICOM)	DICOM listener with TLS encryption
Optional	cvi42 clients	cvi42 Server	tcp/49697	Admin port with no encryption
Optional	cvi42 clients	cvi42 Server	tcp/4390	User port with TLS encryption
Optional	cvi42 clients	cvi42 Server	tcp/4391	Admin port with TLS encryption
Optional	cvi42 Server	https://ppu-a02.circlecvi.com	tcp/443 (https)	Pay Per Use (PPU) license only
Optional	cvi42 Server	https://ppu-d01.circlecvi.com (EMEA region)	tcp/443 (https)	Pay Per Use (PPU) license only
Optional	cvi42 clients	cvi42 Server	tcp/5053	ADAS floating license only
Optional	cvi42 clients	cvi42 Server	tcp/5117	ADAS floating license only
Optional	cvi42 Web Viewer	cvi42 WebClient Service	tcp/443 (https wss)	User port with TLS encryption
Optional	cvi42 Web Viewer	cvi42 WebClient Service	tcp/4288 (https wss)	Web reverse-proxy port to cvi42 report webserver (Apache)
Optional	cvi42 Worker Manager	cvi42 WebClient Service	tcp/4292	
Optional	cvi42 Worker	cvi42 WebClient Service	tcp/4289	

6. cvi42 and TruPlan client installation

6.1. Silent installation of cvi42 client

You can install **cvi42** client silently via command line.

First, make sure you open the command prompt on Windows with administrative privileges.

To install **cvi42** with all default options, you can run this command:

```
msiexec /I "<msi file>" CVI42_LICENSE_AGREEMENT=true APPDIR="C:\Program Files\cvi42"  
SERV_ADDR=<IP or FQDN where cvi42 Server is installed> SERV_NAME="cvi42 Server"  
SERV_PORT=49696 /qn /Li tmp.log
```

- /i - installs the product
- /qn - installs the product in quiet mode with no user interaction
- /Li <logfile> - outputs the progress in a file name



IMPORTANT: Besides /i /qn /Li commands to instrument MSI installation, you can consult this link for additional options:

<https://learn.microsoft.com/en-us/windows-server/administration/windows-commands/msiexec>

To see if installation completed, you can check in the log file for the text: *Windows Installer installed the product.*

You can also uninstall the product through command line:

```
msiexec /uninstall "<msi file>" /qn /Li tmp.log
```

To see if product has been uninstalled, look for this text in the log file: *Windows Installer removed the product.*

6.2. Client Installation (including TruPlan)



IMPORTANT: System Requirements can be accessed from this link:
https://www.circlecvi.com/docs/product-support/cvi42_System_Requirements_6.1.pdf



IMPORTANT: If you are upgrading **cvi42** client on a macOS environment from a 5.x version, you should first uninstall **cvi42** before installing the new version. This rule does not apply for Windows environment.

To install **cvi42**, you should download and run the setup program, which will automatically perform all the necessary configuration steps.

You will need to log in to an account with administrator privileges on the machine you are installing to.



The included cvi42 and TruPlan build and versions numbers are shown on each installer page. Click **Next** to continue.



You should read, accept the **License Agreement**, and click **Next** to continue.

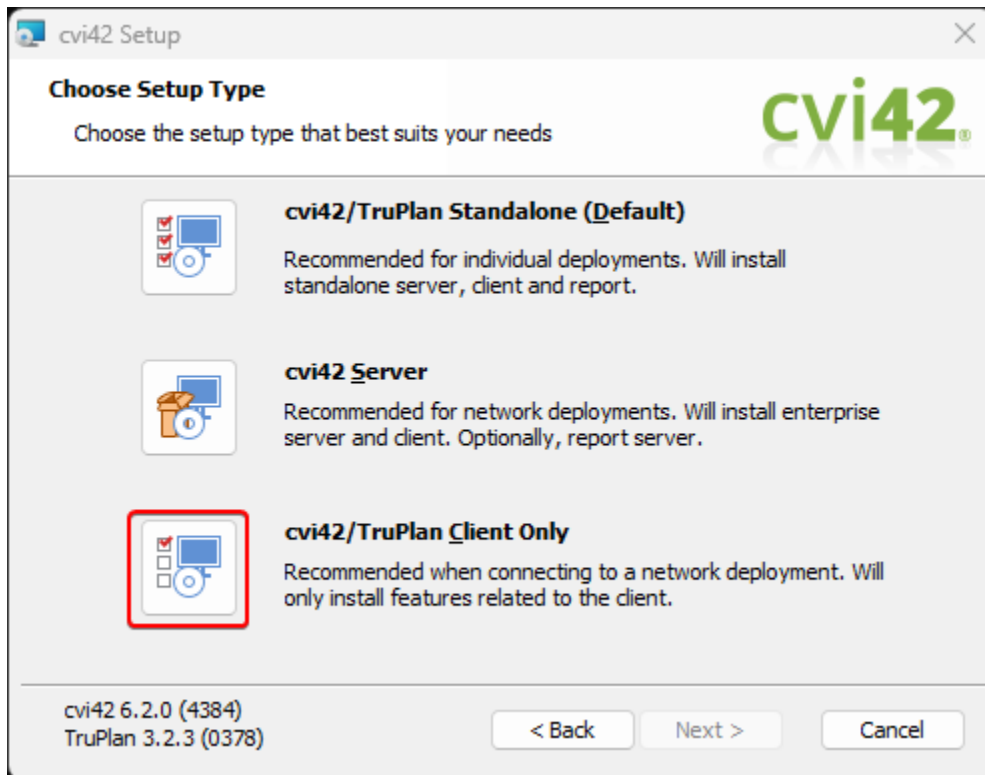

Select **cv42 Client Only** option and click **Next** to continue.

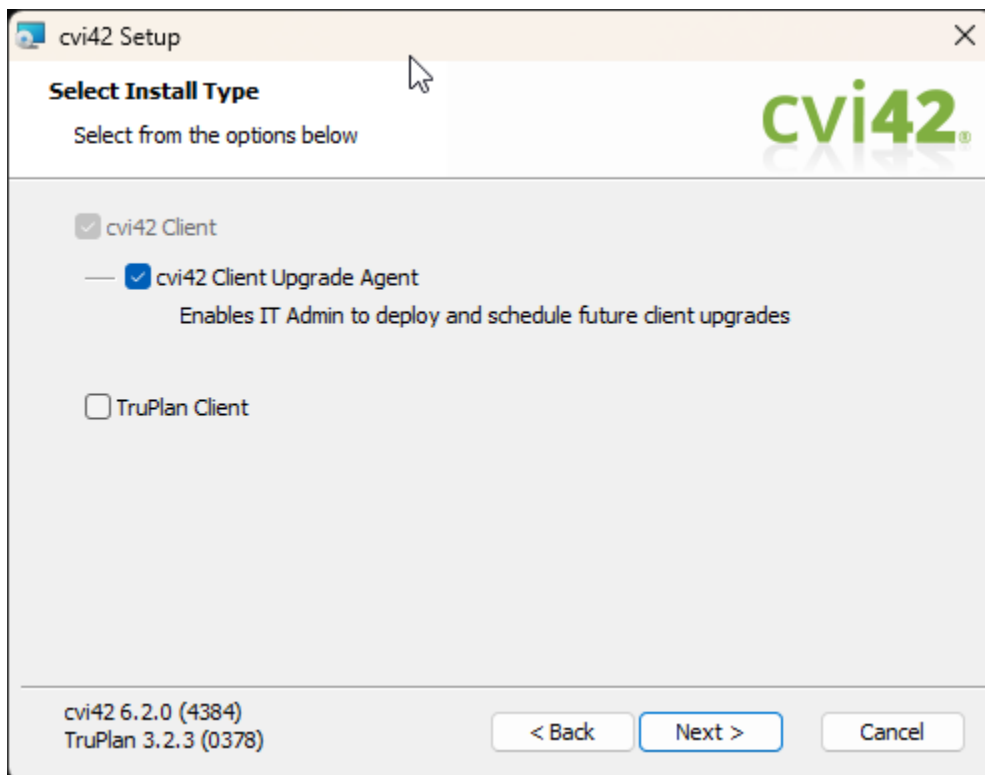

The TruPlan client can be optionally installed, accessing TruPlan will require an additional license. TruPlan clients before version 3.2.3 cannot connect to the **cvi42** Server, previous TruPlan 2.x and 3.x installations should be uninstalled before proceeding with the **cvi42** 6.2.x install. Image data from previous TruPlan installations can be imported to the **cvi42** Server with the SendTo Utility or the client image import features.

Leave **cvi42 Client Upgrade Agent** checked if you want to use **IT-scheduled client upgrades** feature, and click **Next**



IMPORTANT: *IT-scheduled client upgrades* feature is newly introduced in 5.17, it allows IT Administrators to update clients remotely. If you have already an automated method for updating clients, this feature is not recommended for you. Please contact Circle's Customer Support Team at support@circlecvi.com to obtain more information about ***IT-scheduled client upgrades***.

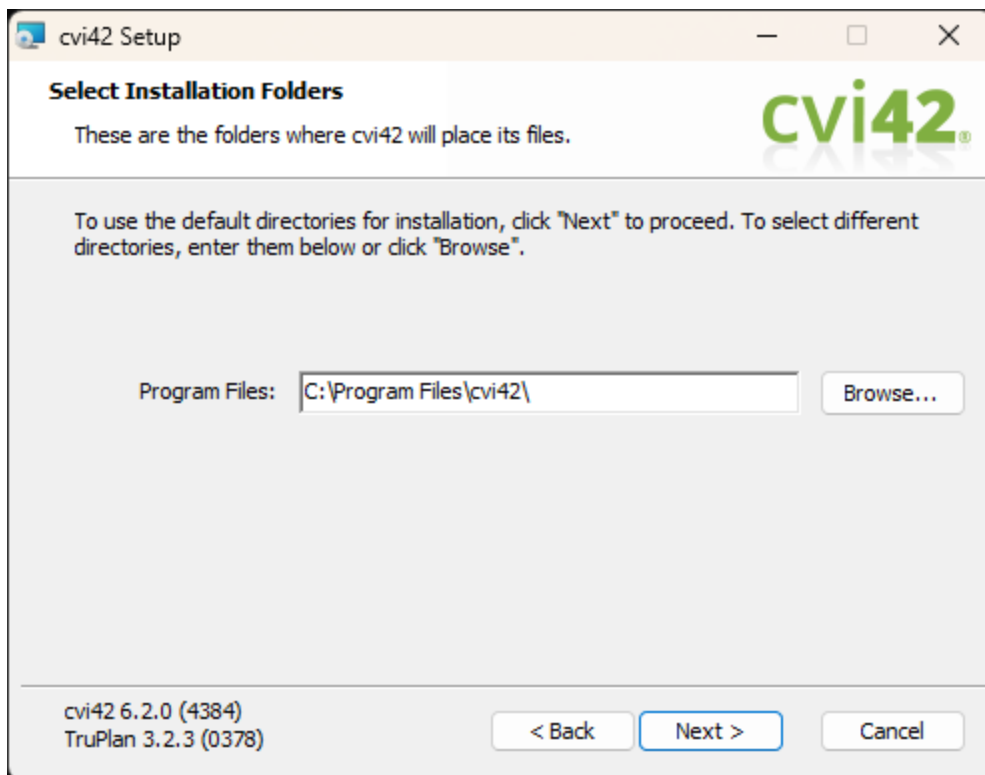

Select the installation folder and click **Next**

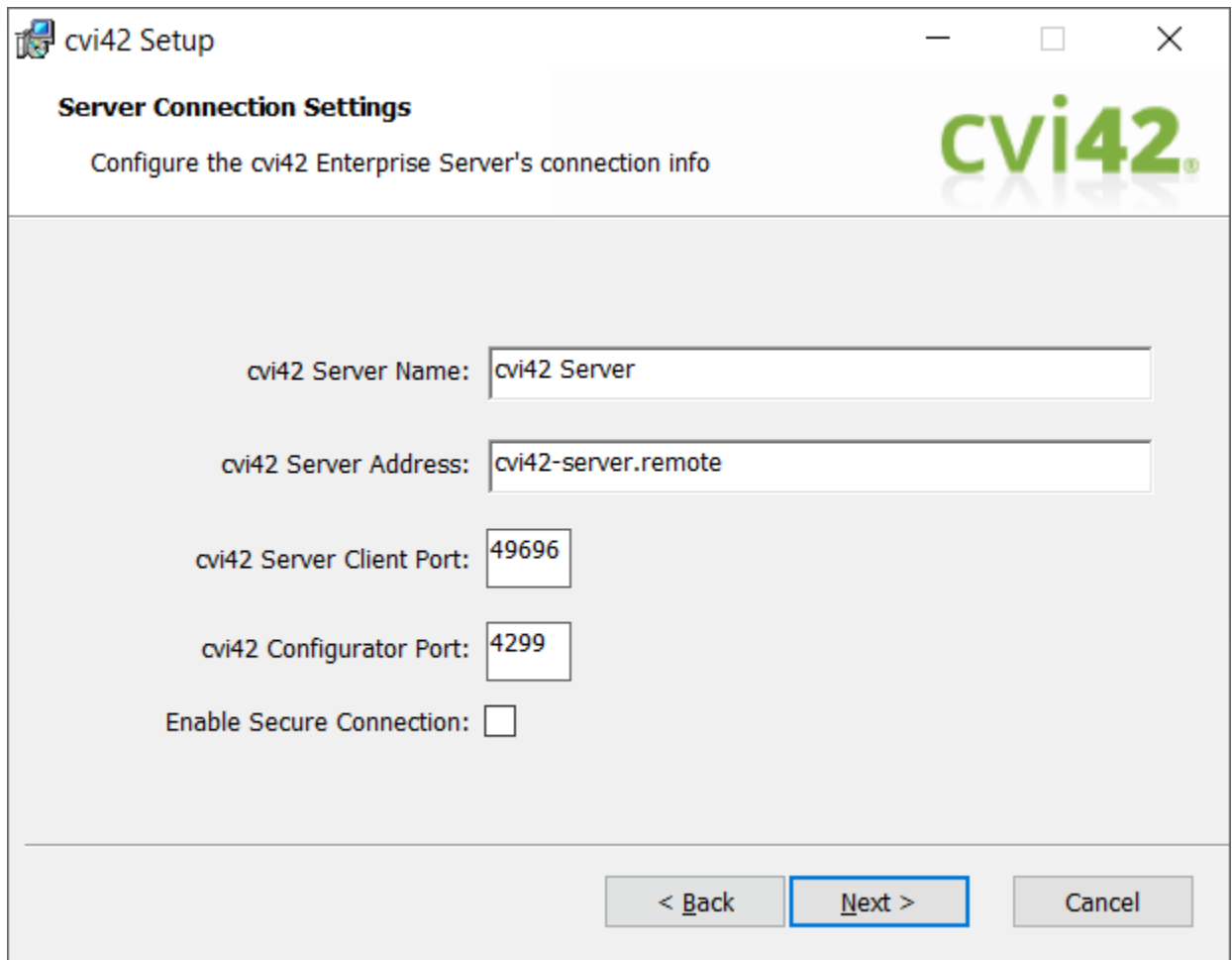

The screenshot shows a Windows-style window titled "cvi42 Setup". The window has a title bar with standard minimize, maximize, and close buttons. The main content area is titled "Server Connection Settings" and includes the instruction "Configure the cvi42 Enterprise Server's connection info". In the top right corner of the window, there is a "cvi42" logo. Below the instruction, there are four input fields and one checkbox:

- "cvi42 Server Name:" with a text box containing "cvi42 Server".
- "cvi42 Server Address:" with a text box containing "cvi42-server.remote".
- "cvi42 Server Client Port:" with a text box containing "49696".
- "cvi42 Configurator Port:" with a text box containing "4299".
- "Enable Secure Connection:" with an unchecked checkbox.

At the bottom of the window, there are three buttons: "< Back", "Next >" (which is highlighted with a blue border), and "Cancel".

Configure the **cvi42** remote server connection.

You can now access **cvi42** from Windows Start menu:

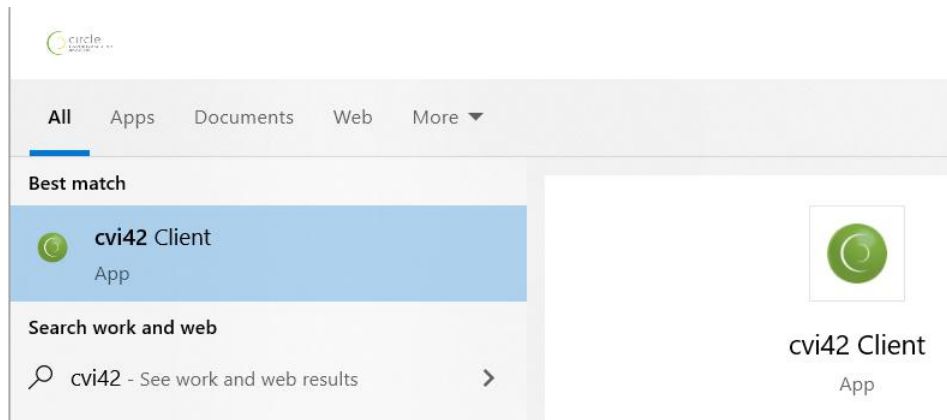

If the TruPlan client was selected, it will also be available in the start menu:

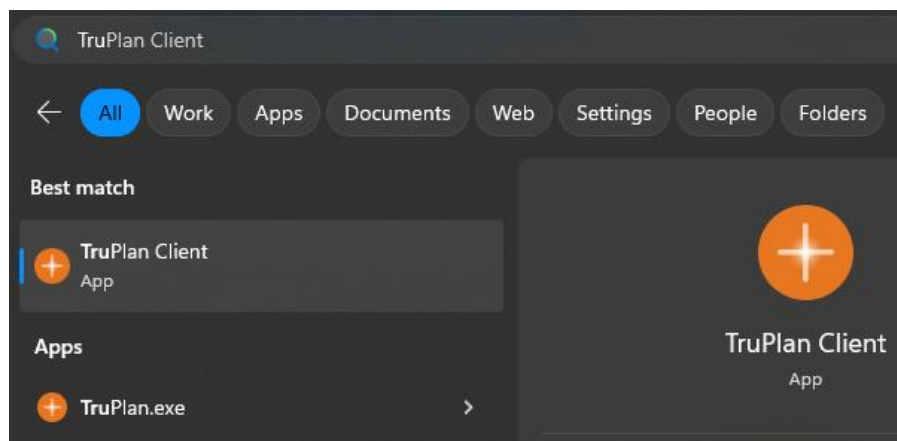

6.3. Configure cvi42 client to connect to the Server

The login dialogue will be configured by default to connect to a local server. This information will be shared with the TruPlan client if it's installed. Additional connection setup can also be done from the TruPlan client.

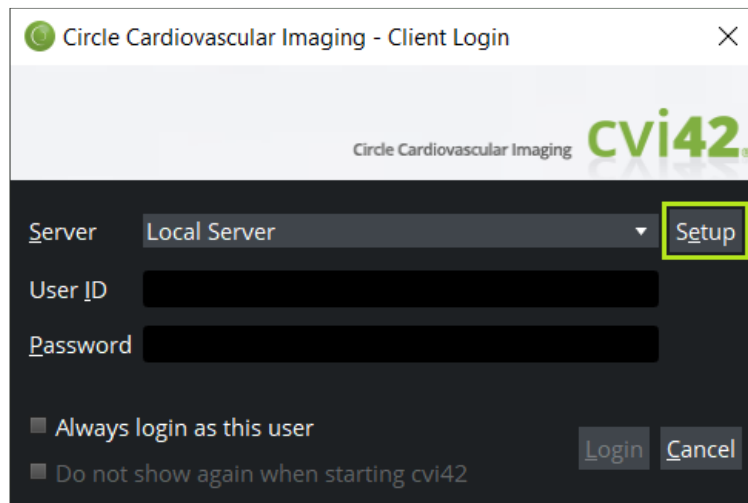

To configure additional servers, click the **Setup** button.

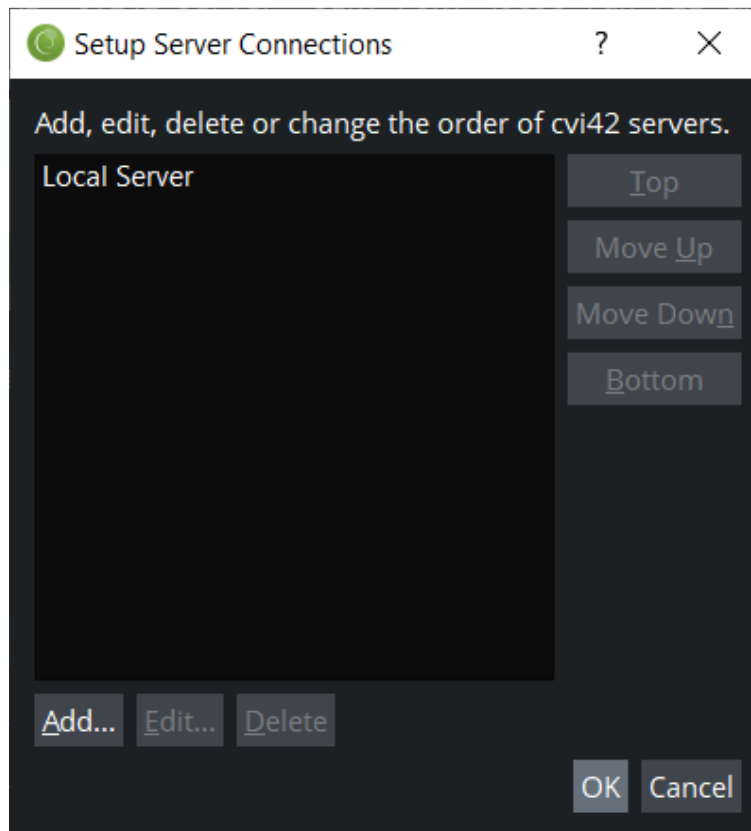

Initially there will only be a Local Server connection in the list. Click **Add...** to add a new server connection.

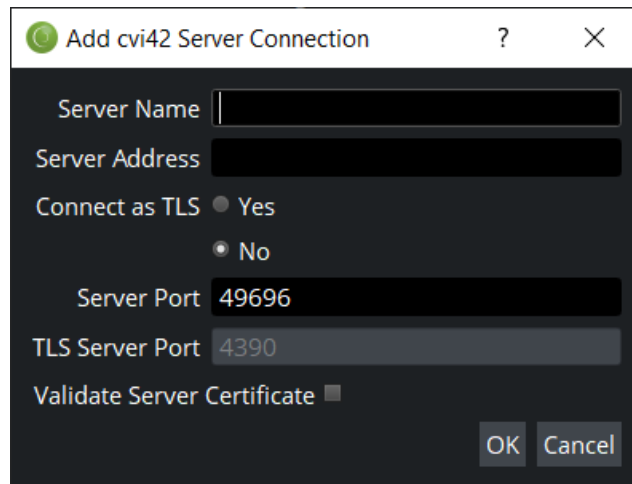

In the Add **cvi42** Server Connection dialogue, fill in the necessary fields.

- **Server Name** – This is any name you choose to identify the server.
- **Server Address** – This is the IP address or host name of the **cvi42** Server you are connecting to.
- **Server Port** – This is the communication port the server uses for connections. The default port is 49696. If the target server is configured to listen on a different port, enter the new value here.



IMPORTANT: Before configuring a secure server connection, the certificate and private keys must first be imported to the **cvi42** Server. For more information on Enabling TLS in **cvi42** refer to section 1.5 below.

- **Server Port for Administration** – If you are required to administrate **cvi42** Server, e.g. setup DICOM nodes, you will need to create a server connection pointing to port 49697. For setting up a secure connection, the default port is 4931 (secure). You will also need to log in as an admin user.



IMPORTANT: The Server Port and TLS Server Port values specified here must match the port number that is configured for the server that you want to connect to.

- **Connect as TLS** – This configuration option allows a user to connect to a secure port on the server. If enabled, the TLS Server Port field will be editable and used to specify the secure port. If disabled, the Server Port field will be editable and used to specify an unsecure port.
- **TLS Server Port** – This is the communication port the server uses for secure connections. The default port is 4390. If the target server is configured to listen on a different port, enter the new value here.

For most deployments, you can now click **OK** to finish.

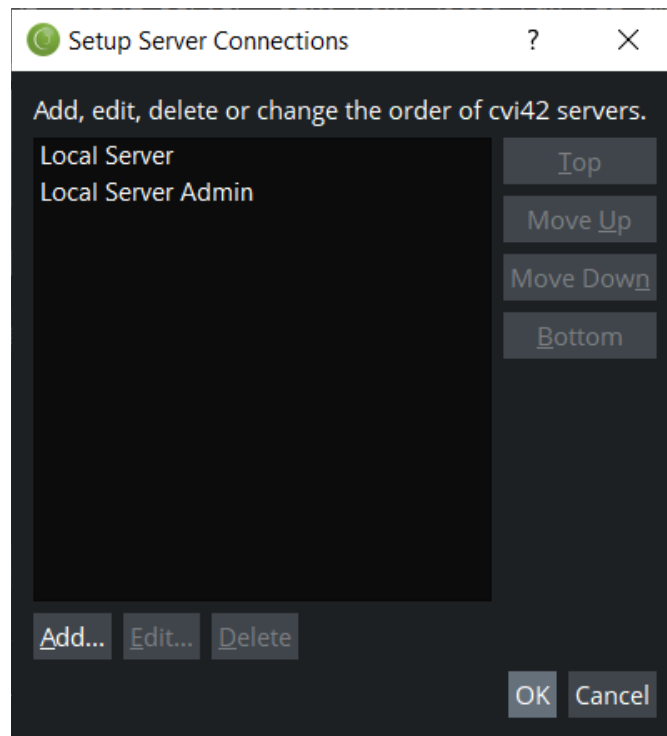

To change the parameters of an existing server connection definition, select the desired server from the list and click the **Edit...** button.

To delete an existing server connection definition, select the desired server from the list and click the **Delete** button.

The **Top**, **Move Up**, **Move Down** and **Bottom** buttons are used to change the order of the servers in the list. This affects the order of the servers listed in the drop-down box in the Login Dialogue.

7. cvi42 Web Module

7.1. Overview

cvi42 includes a browser-based client that allows a user to review images and reports when logged in on a browser without client software installed.

This **cvi42** Web Module workflow requires the **cvi42 Gateway**, **cvi42 Webclient Manager**, and **cvi42 Webclient Service** services to be installed and configured in addition to the regular **cvi42** Server components. The **cvi42 WebClient Worker** component must also be installed during the setup process. The reporting connection settings for the **cvi42** Web Module should be configured through the installer, but can also be changed through the editing of configuration files (see sections 1.17, 1.18, and 1.19) for advanced configurations.

By default the **cvi42** Web Module can be accessed via the url: `http(s)://<IP or FQDN>:4293`. Using a supported web browser (latest Edge, Chrome, or Safari), go the URL for your **cvi42** Server and enter your **cvi42** account username and password.

7.2. Setting up TLS support

By default, the webviewer will listen on port 4293 using standard HTTP. It is recommended that it be configured to use TLS. To do this a certificate and keypair will be required in crt/key format matching the hostname of the **cvi42** Server. Please get this from your system administrator.

1. Certificate files should be placed into the **cvi42** data directory
2. The following lines should be set in the `cvi42_webclient_service.ini`:
webtls=true
webtlscompatibility=intermediate
webtlsport=443
webtlscert=C:/ProgramData/cvi42/<name of crt file.crt>
webtlskey=C:/ProgramData/cvi42/<name of key file.key>
3. Ensure that port 443 is allowed through the firewall.
4. Connections will now be allowed with HTTPS on port 443, or the port set in `webtlsport`.

To improve security of the TLS enabled web connection, HTTP Strict Transport Security (HSTS) can be enabled. This prevents man-in-the-middle attacks by ensuring that only TLS secured resources can be interacted with. This mode will also allow connections to the report server to be proxied through the same HTTPS connection. This is enabled by setting `webforcehttps=true` in `cvi42_webclient service.ini`.

Please consult the User Manual for more details.

8. Command-line Integration

8.1. Overview

The Client & Server-based **cvi42** integration model provides an interface for integrating **cvi42** into third party products, using command line arguments. **cvi42** shall access studies from its own DICOM database or via DICOM Q/R to PACS/VNA. The TruPlan client supports a limited set of command line arguments for third party integration in a similar setup.

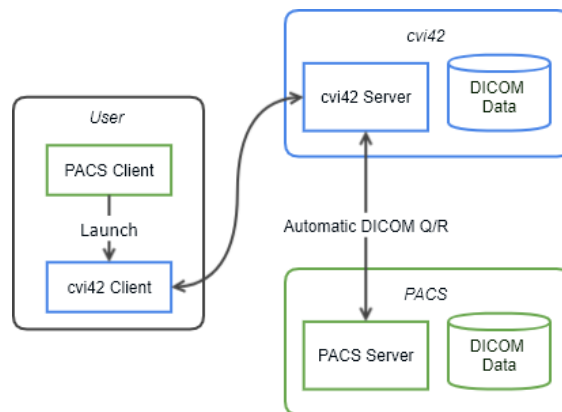

8.2. Client and Server Integration Workflow

In a **cvi42** client and server-based integration, the expected user workflow is as follows:

1. User opens a study on a 3rd party vendor application (e.g., PACS, workstation etc.).
2. User launches **cvi42** within the application. **cvi42** is launched with command line arguments (e.g., Study Instance UID, Accession Number, Username, full screen etc.) provided by the application.
3. User logs on to **cvi42**.



IMPORTANT: Username is populated into the login dialogue. For security reasons, password is never passed as an argument.

4. **cvi42** client requests to **cvi42** Server to load the study with a specific Study Instance UID or Accession Number.
 - a. If the study does not exist in **cvi42** Server, the server sends a DICOM Q/R request to a designated DICOM Q/R SCP. A progress bar indicates study loading status to the user.
 - b. Once the study is retrieved and imported, the server sends back a signal that triggers the client to load the study.
 - c. If the study does not exist and cannot be retrieved, the user is prompted with a message and returned to the patient list, allowing them to continue to use **cvi42** with regular workflow.
5. User generates reports or secondary captures in **cvi42**.
 - a. **cvi42** client uploads generated DICOM files to **cvi42** Server.
 - b. All files that are uploaded can then be sent to the third-party system via DICOM Storage operation either manually or using housekeeping rules.
6. User closes study and returns to patient list, or user closes **cvi42**.

The TruPlan client can be configured similarly, launching with command line parameters for the study instance UID and optionally windows authentication as described below.

8.3. Command Line Parameters for cvi42

Command Line	Activity	Argument
-accession <accession_number>	Load study that matches <accession_number>	Accession Number
-studyuid <study_instance_uid>	Load study that matches <study_instance_uid>	Study Instance UID
-unload-study	Unloads the current study	None
-username <username>	Sets <username> in login dialogue.	Username
-app-name <appname>	Launches <appname> after login to cvi42 *Only applicable when used together with - disable-patient-liat	"CORECT"
-disable-quit-dialog	Disables dialogue message box when exiting cvi42	None
-disable-patient-list	Disables patient list. (cvi42 is locked to the current study)	None
-single-instance	Forces to run only a single instance of cvi42	None
-multi-instance	Forces to run multiple instances of cvi42	None
-quit	Closes cvi42 application immediately	None
-quit-with-delay	Closes cvi42 application after a 15 second timeout *This is not applicable if cvi42 was launched with -disable-quit-dialog	None
-study-request-url <URL>	Attempts to authenticate and load a study from the given URL (Cannot be used with "-accession" or "- studyuid" parameters)	URL that provides Username and Study identifier (Accession Number or Study Instance UID) as a response object

8.4. Launching cvi42

In order to launch **cvi42** from a third-party software, the vendor shall run **cvi42** with proper command line arguments.

As an example, the following command will launch **cvi42**, set username in the login dialogue with "-username" argument value and load the appropriate study with "accession" argument. If **cvi42** has already been launched, **cvi42** will close the current study and switch to the study specified in "accession". Also, if a different username is passed as an argument, **cvi42** will close the current study, disconnect from current session, and present a login dialogue.

```
>> cvi42.exe -username="admin" -accession="ABC123456" -single-instance
```

If a study was closed or patient was changed in the vendor’s software, it can pass the following arguments to **cvi42**.

```
>> cvi42.exe -unload-study -single-instance
```

This command will launch a **cvi42** process in the background, pass the arguments to the existing **cvi42** process and terminate itself. It is recommended to always pass “-single-instance” to avoid popup messages asking for launching **cvi42** in multi-instance mode.

8.5. Command Line Parameters for TruPlan

Command Line	Activity	Argument
-studyuid <study_instance_uid>	Load study that matches <study_instance_uid>	Study Instance UID
-auth=windows	Login on TruPlan client startup	Only windows authentication is supported for startup login

9. Security Considerations

9.1 Secure Decommissioning

cvi42 can be removed using the standard application uninstall method. However since PHI has been written to the disk, it is recommended that once **cvi42** has been removed, the system should not be reused without fully clearing all data from the disk. If operating system full disk encryption (FDE) is enabled as recommended in this document, no further action is required aside from resetting the encryption keys and reinstalling the operating system. If this has not been done, running an application that securely overwrites all data on the disk is required. On Windows the “cypher” command can be used.

9.2 Logging and Event Capture

As all security events go through the **cvi42** server, the server logs contain all relevant security events. These log events contain information relevant to security and can be used to detect anomalous behaviour both within the application itself, or across the network with centralized monitoring such as IDS or SIEM products. These logs are kept locally, but are available to be read and processed by a IDP or SIEM system through a local process or agent.

The default format for logging is JSON structured logging which is easily parsable. Each log message is a JSON object containing at least the following keys:

- "time" - ISO8601 timestamp
- "type" - The log type, usually SystemLog - each type has specific keys
- "level" - The log level, DEBUG, INFO, WARNING, ERROR.
- "pid" - The process ID of the process making the log
- "msg" - The actual log message

Other keys include:

- "op" - The operation that is being executed as part of the log
- "latencymys" - The time in milliseconds that the operation waited before executing
- "client" - The IP or hostname of the client making the request
- "user" - The user making the request
- "status" - The status of an operation or request

By default logs are stored in the "ServerLogs" directory in the **cvi42** data directory, by default rotated nightly, and are not deleted without user intervention. These attributes can be each adjusted using options detailed in section **Error! Reference source not found..**

9.2.1 Relevant Security Logs

cvi42 client establishing connection with the cvi42 Server

```
{"time":"2025-06-06T15:02:14.664-06:00","type":"TraceLog","level":"INFO","pid":10152,"client":"137.83.48.163","latencymys":"0","op":"AcceptConnection","status":"","msg":"AcceptConnection"}
```

Successful login attempt

```
{"time":"2025-06-06T15:07:50.691-06:00","type":"AccessLog","level":"INFO","pid":10152,"client":"137.83.48.163","latencymys":"1114","op":"Authenticate","status":"Success","msg":"Authenticate (ActivationAndLicense,test_user,***not displayed***)"}
```

Failed login attempt

```
{"time":"2025-06-06T15:02:15.992-06:00","type":"AccessLog","level":"INFO","pid":10152,"client":"137.83.48.163","latencymys":"1037","op":"Authenticate","status":"Fail","msg":"Authenticate (ActivationAndLicense)"}
```

```
{"time":"2025-06-06T15:02:15.992-06:00","type":"TraceLog","level":"INFO","pid":10152,"client":"137.83.48.163","latencymys":"1037","op":"Authenticate","status":"Fail","msg":"Authenticate, RequestedSessionProfile=ActivationAndLicense"}
```

```
{"time":"2025-06-06T15:02:15.993-06:00","type":"ErrorLog","level":"ERROR","pid":10152,"msg":"137.83.48.163,,,Authenticate,Invalid credentials. - Exception occurred in method"}
```

```
CvSecurityManager.AuthenticateUser, line 1259, in file
E:\\work\\30613f7e1c61c39e\\server\\src\\Managers\\CvSecurityManager.cpp"}
{"time":"2025-06-06T15:02:15.993-
06:00","type":"ErrorLog","level":"ERROR","pid":10152,"msg":"137.83.48.163,,A
uthenticate,Invalid credentials. - Exception occurred in method
CvSecurityManager.AuthenticateUser, line 1259, in file
E:\\work\\30613f7e1c61c39e\\server\\src\\Managers\\CvSecurityManager.cpp"}
```

cvi42 client application being temporarily locked out due to repeated failed login attempts

```
{"time":"2025-06-06T15:04:12.463-
06:00","type":"ErrorLog","level":"ERROR","pid":10152,"msg":"137.83.48.163,,A
uthenticate,Account is temporarily locked-out. Please try again later. -
Exception occurred in method CvSecurityManager.AuthenticateUser, line 1179,
in file
E:\\work\\30613f7e1c61c39e\\server\\src\\Managers\\CvSecurityManager.cpp"}
```

Login attempt from an already logged-in user coming from a second cvi42 client machine

```
{"time":"2025-06-06T15:09:09.007-
06:00","type":"SystemLog","level":"INFO","pid":10152,"msg":"Connection
closed. User 'test_user' has logged in from another client at 137.83.48.163
(137.83.48.163)."}
{"time":"2025-06-06T15:09:09.007-
06:00","type":"AccessLog","level":"INFO","pid":10152,"client":"137.83.48.163"
,"user":"test_user","latencymys":"1","op":"CloseDuplicateConnections","status"
:"Success","msg":"CloseDuplicateConnections(test_user)"}
{"time":"2025-06-06T15:09:09.007-
06:00","type":"TraceLog","level":"INFO","pid":10152,"client":"127.0.0.1","use
r":"test_user","latencymys":"0","op":"CloseConnection","status":"","msg":"Clos
eConnection"}
```

Adding a user role (by the IT administrator)

```
{"time":"2025-06-06T15:00:10.262-
06:00","type":"AccessLog","level":"INFO","pid":10152,"client":"137.83.48.163"
,"user":"test_admin","latencymys":"19","op":"AddUser","status":"Success","msg"
:"AddUser(test_user,Test,User,***not
displayed***,Viewer,Technician,Analyst,Reporter,Data Administrator,User
Administrator,System Administrator,PACS Administrator,ADAS3D User,TruPlan
User,Tester)"}
{"time":"2025-06-06T15:00:10.262-
06:00","type":"TraceLog","level":"INFO","pid":10152,"client":"137.83.48.163",
"user":"test_admin","latencymys":"19","op":"AddUser","status":"Success","msg":
"AddUser, UserName=test_user, FirstName=Test, LastName=User, Password=***not
displayed***, RoleIds=Viewer,Technician,Analyst,Reporter,Data
Administrator,User Administrator,System Administrator,PACS
Administrator,ADAS3D User,TruPlan User, PhysicianId=Tester"}
```

Setting configurations (preferences)

```
{"time":"2025-06-06T17:21:10.171-
06:00","type":"AccessLog","level":"INFO","pid":10152,"client":"137.83.48.163"
,"user":"test_user","latencymys":"4","op":"SaveUserPreferences","status":"Succ
ess","msg":"SaveUserPreferences(test_user,15 keys)"}

```

```
{"time":"2025-06-06T17:21:10.171-06:00","type":"TraceLog","level":"INFO","pid":10152,"client":"137.83.48.163","user":"test_user","latencymys":"4","op":"SaveUserPreferences","status":"Success","msg":"SaveUserPreferences, UserName=test_user, Payload=15 keys"}
```

Opening patient study

```
{"time":"2025-06-06T17:22:31.600-06:00","type":"AccessLog","level":"INFO","pid":10152,"client":"137.83.48.163","user":"test_user","latencymys":"3","op":"LoadStudy","status":"Success","msg":"LoadStudy(200702161252541.3.6.1.4.1.53684.1.1.2.1345746851.3448.1576973319.699348)"} {"time":"2025-06-06T17:22:31.601-06:00","type":"TraceLog","level":"INFO","pid":10152,"client":"137.83.48.163","user":"test_user","latencymys":"4","op":"LoadStudy","status":"Success","msg":"LoadStudy, StudyUID=200702161252541.3.6.1.4.1.53684.1.1.2.1345746851.3448.1576973319.699348"}
```

Exporting patient study

```
{"time":"2025-06-06T17:36:51.769-06:00","type":"AccessLog","level":"INFO","pid":10152,"client":"137.83.48.163","user":"test_user","latencymys":"0","op":"ExportStudy","status":"Success","msg":"ExportStudy(200702161252541.3.6.1.4.1.53684.1.1.2.1345746851.3448.157697319.699348,false,)" } {"time":"2025-06-06T17:36:51.769-06:00","type":"TraceLog","level":"INFO","pid":10152,"client":"137.83.48.163","user":"test_user","latencymys":"0","op":"ExportStudy","status":"Success","msg":"ExportStudy, StudyUID=200702161252541.3.6.1.4.1.53684.1.1.2.1345746851.3448.1576973319.699348, DicomStyle=false, SeriesUIDs="}
```

9.2.2 Relevant Security Related User Notices

cvi42 has specific behaviour that may happen when certain security events happen.

- When an invalid username or password is entered, the user will be notified via a pop-up that the credentials are incorrect and allows the user to attempt to log in again.
- After a configurable number of attempts (default of 3) the user will be locked out for a configurable amount of time (default 60s). The user will be notified via pop-up message that the account is locked out.
- If the client is disconnected from the server, the user will be notified via a pop-up and the user must re-authenticate once the connection is restored.
- A single user cannot be logged in more than once. If a user is successfully logged in and the same user is already logged in on another client machine, the user will be given the option to disconnect the existing connection or terminate their own connection. If a login is terminated by a new user logging in, then a message will let the user know that they have been disconnected due to a new login. This should be reported to IT security as it could be an invalid access to their account.

- If an account is suspended by an administrator, the user will be notified with a pop-up upon correctly authenticated, but the connection will not be completed.
- If system storage is below the recommended minimum for analyzing image data, the user will be notified with a pop-up.

These events will also be captured in the logs, see sections 1.11 and 9.2.1 for further details.