

IT | EN | ES | FR

Via Nolfi



outdoorkitchens

IT Via Nolfi è il modello che ha definito l'identità progettuale della collezione OF e ne rappresenta l'espressione tecnica più completa, in cui estetica e funzione sono in perfetto equilibrio. Disegnata con linee pulite e volumi rigorosi, risponde alle esigenze più evolute dell'outdoor. Ogni elemento è concepito per offrire solidità, precisione costruttiva e affidabilità nel tempo. La modularità estesa consente di sviluppare configurazioni articolate, integrando diverse tipologie di elettrodomestici e soluzioni operative. Un'ampia gamma di finiture per ante e piani permette di adattare il sistema a contesti architettonici differenti, mantenendo coerenza e rigore compositivo.

EN *Via Nolfi is the model that defined the design identity of the OF collection and represents its most complete technical expression, where aesthetics and function are in perfect balance. Designed with clean lines and rigorous volumes, it meets the most advanced requirements of outdoor living. Every element is conceived to deliver solidity, constructional precision and long-term reliability. Its extended modularity allows the development of articulated configurations, integrating different types of appliances and operational solutions. A wide range of finishes for doors and worktops allows the system to adapt to different architectural contexts while maintaining compositional coherence and rigour.*

ES Via Nolfi es el modelo que ha definido la identidad proyectual de la colección OF y representa su expresión técnica más completa, donde estética y función se encuentran en perfecto equilibrio. Diseñada con líneas limpias y volúmenes rigurosos, responde a las exigencias más avanzadas del espacio exterior. Cada elemento está concebido para ofrecer solidez, precisión constructiva y fiabilidad a lo largo del tiempo. Su modularidad ampliada permite desarrollar configuraciones articuladas, integrando distintos tipos de electrodomésticos y soluciones operativas. Una amplia gama de acabados para puertas y encimeras permite adaptar el sistema a diferentes contextos arquitectónicos, manteniendo coherencia y rigor compositivo.

FR *Via Nolfi est le modèle qui a défini l'identité de conception de la collection OF et en représente l'expression technique la plus aboutie, où esthétique et fonction sont en parfait équilibre. Conçue avec des lignes épurées et des volumes rigoureux, elle répond aux exigences les plus avancées de l'usage en extérieur. Chaque élément est pensé pour offrir solidité, précision constructive et fiabilité dans le temps. Sa modularité étendue permet de développer des configurations articulées, en intégrant différents types d'appareils et de solutions opérationnelles. Une large gamme de finitions pour les portes et les plans de travail permet d'adapter le système à des contextes architecturaux variés, tout en maintenant cohérence et rigueur de composition.*

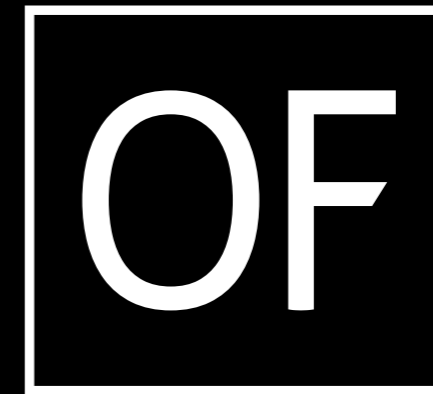

outdoorkitchens

Life is Outside

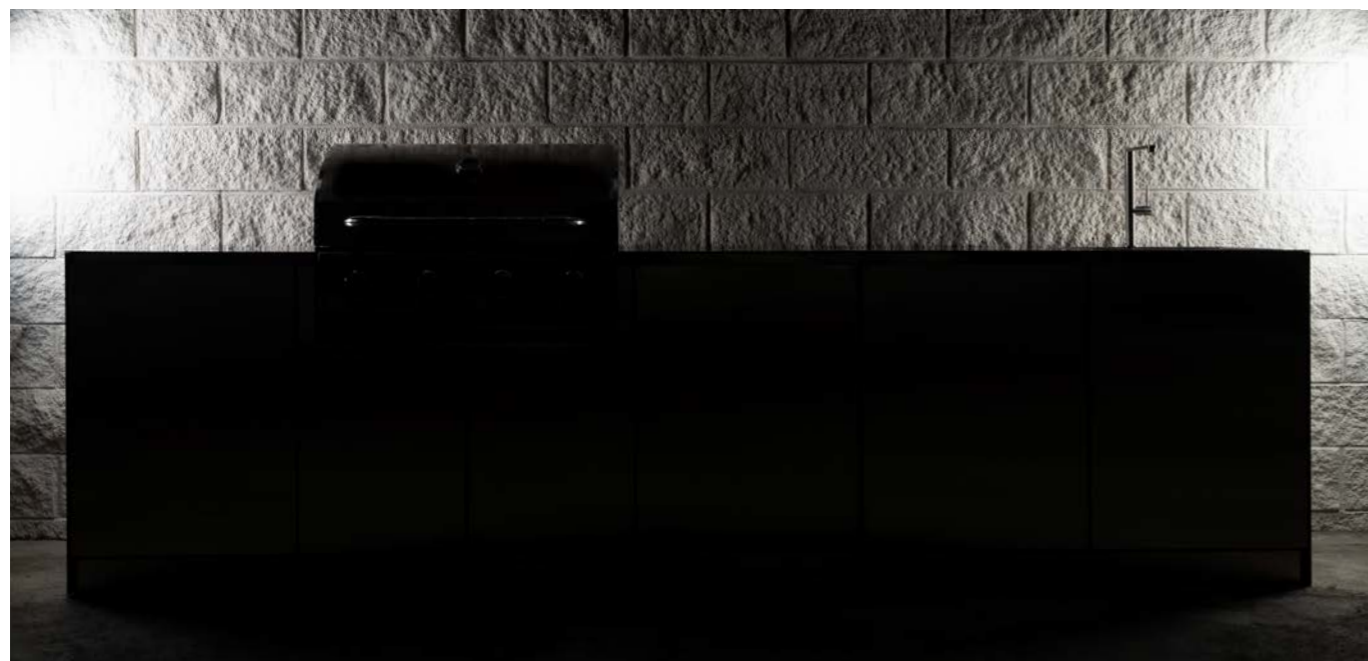

DESIGN

Design

Design
Design

IT Linea essenziale e precisa. L'acciaio inox mette in evidenza la struttura dei moduli, definendo proporzioni regolari e una presenza solida nel tempo.

EN *Essential, precise lines. Stainless steel highlights the structure of the modules, defining balanced proportions and a presence designed to endure over time.*

ES Línea esencial y precisa. El acero inoxidable resalta la estructura de los módulos, definiendo proporciones equilibradas y una presencia sólida en el tiempo.

FR *Ligne essentielle et précise. L'acier inoxydable met en valeur la structure des modules, définissant des proportions équilibrées et une présence durable dans le temps.*



LIBERTÀ

Freedom

Libertad
Liberté

IT L'utilizzo della cucina si estende all'esterno con la stessa continuità degli ambienti interni. Le finiture disponibili permettono di adattare il modello a contesti differenti, preservandone l'identità formale.

EN *The use of the kitchen extends outdoors with the same continuity as interior spaces. The available finishes allow the model to adapt to different contexts while preserving its formal identity.*

ES El uso de la cocina se extiende al exterior con la misma continuidad que los espacios interiores. Los acabados disponibles permiten adaptar el modelo a distintos contextos, preservando su identidad formal.

FR *L'usage de la cuisine s'étend à l'extérieur avec la même continuité que les espaces intérieurs. Les finitions disponibles permettent d'adapter le modèle à différents contextes, tout en préservant son identité formelle.*

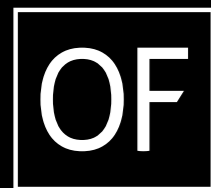

outdoorkitchens

PRODUZIONE MADE IN ITALY

Made In Italy Production
Producción Made In Italy
Production Made In Italy



Stabilimento OF Outdoor Kitchens, esterno

IT Tecnozeta S.r.l. è un'azienda specializzata nella produzione e commercializzazione di soluzioni per il settore metalmeccanico e per l'arredo residenziale. L'attività si basa sulla lavorazione della lamiera, dell'acciaio inox e dell'alluminio, sviluppata in funzione delle diverse esigenze progettuali. Il passaggio dall'industrializzazione alla realizzazione di ogni particolare caratterizza l'approccio produttivo maturato negli anni. Questa esperienza tecnica si traduce in Officine Fanesi, un brand esclusivo specializzato nella realizzazione di cucine sartoriali sia per contesti indoor che outdoor, costruite interamente in acciaio inox 304 o 316. Da questo know-how prende forma OF OutdoorKitchens, che applica agli ambienti esterni l'esperienza progettuale e la tecnologia tipiche degli interni. Il risultato è un sistema modulare con elevati standard qualitativi, progettato per rendere la cucina outdoor più accessibile e semplice da gestire.

EN Tecnozeta S.r.l. is a company specialised in the production and commercialisation of solutions for the metalworking sector and residential furnishings. Its activity is based on the processing of sheet metal, stainless steel and aluminium, developed according to different design requirements. The transition from industrialisation to the realisation of every detail characterises the production approach refined over the years. This technical experience takes shape in Officine Fanesi, an exclusive brand specialised in the creation of bespoke kitchens for both indoor and outdoor contexts, entirely built in AISI 304 or 316 stainless steel. From this know-how comes OF OutdoorKitchens, which applies to outdoor environments the design expertise and technology typical of interior kitchens. The result is a modular system with high quality standards, designed to make the outdoor kitchen more accessible and easier to manage.

ES Tecnozeta S.r.l. es una empresa especializada en la producción y comercialización de soluciones para el sector metalmeccánico y para el mobiliario residencial. Su actividad se basa en el trabajo de chapa, acero inoxidable y aluminio, desarrollado según las distintas necesidades de proyecto. El paso de la industrialización a la realización de cada detalle caracteriza el enfoque productivo desarrollado a lo largo de los años. Esta experiencia técnica se materializa en Officine Fanesi, una marca exclusiva especializada en la creación de cocinas a medida tanto para espacios interiores como exteriores, construidas íntegramente en acero inoxidable AISI 304 o 316. De este know-how nace OF OutdoorKitchens, que aplica a los espacios exteriores la experiencia de diseño y la tecnología propias de las cocinas de interior. El resultado es un sistema modular con altos estándares de calidad, diseñado para hacer que la cocina outdoor sea más accesible y fácil de gestionar.

FR Tecnozeta S.r.l. est une entreprise spécialisée dans la production et la commercialisation de solutions pour le secteur de la métallurgie et pour l'ameublement résidentiel. Son activité repose sur le travail de la tôle, de l'acier inoxydable et de l'aluminium, développé en fonction des différentes exigences de conception. Le passage de l'industrialisation à la réalisation de chaque détail caractérise l'approche productive développée au fil des années. Cette expérience technique se traduit par Officine Fanesi, une marque exclusive spécialisée dans la réalisation de cuisines sur mesure pour des contextes aussi bien intérieurs qu'extérieurs, entièrement construites en acier inoxydable AISI 304 ou 316. De ce savoir-faire naît OF OutdoorKitchens, qui applique aux environnements extérieurs l'expertise de conception et la technologie typiques des cuisines d'intérieur. Le résultat est un système modulaire aux standards de qualité élevés, conçu pour rendre la cuisine outdoor plus accessible et plus simple à utiliser.



Stabilimento OF Outdoor Kitchens, interno



INDICE

CUCINE DA ESTERNO VIA NOLFI	10
Outdoor kitchens Via Nolfi	
Cocinas de exterior Via Nolfi	
Cuisines d'extérieur Via Nolfi	
TIPOLOGIE MODULI	52
Modules typology	
Tipología de módulos	
Typologie des modules	
ELETTRODOMESTICI E ACCESSORI	72
Appliances and Accessories	
Electrodomésticos y Accesorios	
Électroménagers et Accessoires	
MATERIALI E FINITURE	84
Materials and finishes	
Materiales y acabados	
Matériaux et finitions	
COMPOSIZIONI PREDEFINITE	90
Predefined compositions	
Composiciones predefinidas	
Compositions prédéfinies	
COMPOSIZIONI MODULARI	92
Modular compositions	
Composiciones modulares	
Compositions modulables	
OF ATTENZIONE ALL'AMBIENTE	104
OF Care for the environment	
OF Respecto con el medio ambiente	
OF Respect de l'environnement	



outdoorkitchens

Via Nolfi

LA CUCINA SENZA MANIGLIA The Handleless Kitchen

La cocina sin tirador

La cuisine sans poignée

IT Via Nolfi prende il nome dalla storica strada che attraversa il centro di Fano, luogo in cui ha origine l'identità progettuale di OF. In questo contesto si sono consolidate competenze tecniche, relazioni con progettisti e una filiera radicata nel territorio, che costituisce ancora oggi la base del processo produttivo. La cucina è progettata come un volume continuo, privo di elementi applicati: l'apertura delle ante è integrata nel profilo della struttura, mantenendo superfici complanari e proporzioni regolari. L'eredità della tradizione costruttiva e lo sviluppo tecnico convergono in un sistema stabile, studiato per durare nel tempo.

EN *Via Nolfi takes its name from the historic street that runs through the centre of Fano, the place where OF's design identity originated. In this context, technical expertise, relationships with designers and a supply chain deeply rooted in the local territory have developed, forming the basis of the production process to this day. The kitchen is designed as a continuous volume, free from applied elements: the door opening is integrated into the profile of the structure, maintaining flush surfaces and regular proportions. The legacy of construction tradition and technical development converge in a stable system designed to endure over time.*

ES Via Nolfi toma su nombre de la histórica calle que atraviesa el centro de Fano, lugar donde se origina la identidad proyectual de OF. En este contexto se han consolidado competencias técnicas, relaciones con diseñadores y una cadena de suministro arraigada en el territorio, que aún hoy constituye la base del proceso productivo. La cocina está diseñada como un volumen continuo, sin elementos aplicados: la apertura de las puertas está integrada en el perfil de la estructura, manteniendo superficies enrasadas y proporciones regulares. La herencia de la tradición constructiva y el desarrollo técnico convergen en un sistema estable, concebido para perdurar en el tiempo.

FR *Via Nolfi tire son nom de la rue historique qui traverse le centre de Fano, lieu où l'identité de conception d'OF a pris forme. Dans ce contexte se sont consolidées des compétences techniques, des relations avec les concepteurs et une chaîne d'approvisionnement ancrée dans le territoire, qui constitue encore aujourd'hui la base du processus de production. La cuisine est conçue comme un volume continu, dépourvu d'éléments appliqués : l'ouverture des portes est intégrée au profil de la structure, maintenant des surfaces affleurantes et des proportions régulières. L'héritage de la tradition constructive et le développement technique convergent dans un système stable, conçu pour durer dans le temps.*

Via Nolfi



OF

outdoorkitchens

70 DIVERSE TIPOLOGIE DI MODULI

Over 70 different types of modules

Más de 70 tipologías diferentes de módulos

Plus de 70 types de modules

BASI PER L'INCASSO DI OLTRE 130 MODELLI DI BARBECUE

Base units for integrating over 130 barbecue models

Bases para el encastrado de más de 130 modelos de barbacoa

Bases pour l'encastrement de plus de 130 modèles de barbecue

INTEGRABILE CON OLTRE 150 MODELLI DI ELETTRODOMESTICI

Can be integrated with over 150 household appliance models

Integrable con más de 150 modelos de electrodomésticos

Intégrable avec plus de 150 modèles d'électroménagers

AMPIA PERSONALIZZAZIONE

Wide customization

Amplia personalización

Large personnalisation

ANTE REALIZZABILI IN 5 DIVERSE FINITURE DI ACCIAIO INOX

Doors available in 5 different Stainless Steel Finishes

Puertas disponibles en 5 acabados diferentes de acero inoxidable

Portes disponibles en 5 finitions différentes en acier inoxydable

120 COLORI LACCATI, 35 FINITURE IN PIETRA E LEGNO TEAK

120 lacquered colours, 35 finishes in Stone and Teak wood

120 colores lacados, 35 acabados en piedra y madera de teca

120 coloris laqués, 35 finitions en pierre et bois de teck

FLESSIBILITÀ DI PROGETTAZIONE CON IL CONFIGURATORE GRAFICO OF

Maximum design flexibility thanks to the of graphic configurator

Máxima flexibilidad de diseño gracias al configurador gráfico OF

Flexibilité maximale de conception grâce au configurateur graphique OF



IT Struttura: Acciaio Inox 304 Naturale
 Top: Laminam sp. 12mm
 Ante: Acciaio Inox Delabrè

EN Structure: Natural Stainless Steel 304
 Worktop: Laminam thickness 12 mm
 Doors: Delabrè Stainless Steel

ES Estructura: Acero inoxidable 304 natural
 Encimera: Laminam espesor 12 mm
 Puertas: Acero inoxidable Delabrè

FR Structure : Acier inoxydable 304 naturel
 Plan de travail : Laminam épaisseur 12 mm
 Portes : Acier inoxydable Delabrè



IT Struttura: Acciaio Inox 304 Naturale
 Top: Dekton sp. 20mm
 Ante: Anta Techno Legno Teak
 Carter: Dekton sp. 20mm

EN Structure: Natural Stainless Steel 304
 Worktop: Dekton thickness 20 mm
 Doors: Techno Wood Teak door
 Side panels: Dekton thickness 20 mm

ES Estructura: Acero inoxidable 304 natural
 Encimera: Dekton espesor 20 mm
 Puertas: Puerta Techno Madera Teca
 Paneles: Dekton espesor 20 mm

FR Structure : Acier inoxydable 304 naturel
 Plan de travail : Dekton épaisseur 20 mm
 Portes : Porte Techno Bois Teak
 Joues : Dekton épaisseur 20 mm

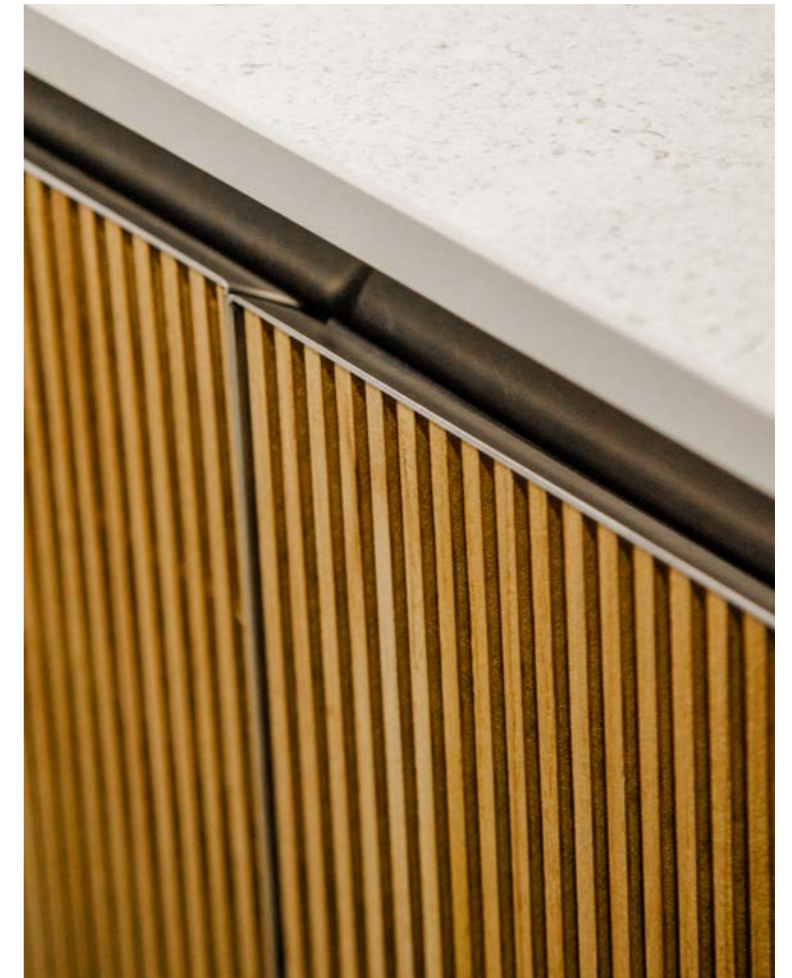



IT Struttura: Acciaio Inox 304 Naturale
 Top: Acciaio Inox 304 Naturale
 Ante: Acciaio Inox Laccato Ruggine Chiaro
 Carter: Acciaio Inox 304 Naturale

EN Structure: Natural Stainless Steel 304
 Worktop: Natural Stainless Steel 304
 Doors: Stainless Steel lacquered Light Rust
 Side panels: Natural Stainless Steel 304

ES Estructura: Acero inoxidable 304 natural
 Encimera: Acero inoxidable 304 natural
 Puertas: Acero inoxidable lacado Óxido claro
 Paneles: Acero inoxidable 304 natural

FR Structure : Acier inoxydable 304 naturel
 Plan de travail : Acier inoxydable 304 naturel
 Portes : Acier inoxydable laqué Rouille claire
 Jous : Acier inoxydable 304 naturel





IT Struttura: Acciaio Inox 304 Naturale
 Top: Laminam sp. 12mm
 Ante: Anta Techno Laminam
 Carter: Laminam sp. 12mm

EN Structure: Natural Stainless Steel 304
 Worktop: Laminam thickness 12 mm
 Doors: Techno Laminam door
 Side panels: Laminam thickness 12 mm

ES Estructura: Acero inoxidable 304 natural
 Encimera: Laminam espesor 12 mm
 Puertas: Puerta Techno Laminam
 Paneles: Laminam espesor 12 mm

FR Structure : Acier inoxydable 304 naturel
 Plan de travail : Laminam épaisseur 12 mm
 Portes : Porte Techno Laminam
 Joues : Laminam épaisseur 12 mm



IT Struttura: Acciaio Inox 304 Naturale
 Top: Acciaio Inox 304 Delabrè
 Ante: Acciaio Inox 304 Delabrè
 Carter: Acciaio Inox 304 Delabrè

EN Structure: Natural Stainless Steel 304
 Worktop: Delabrè Stainless Steel 304
 Doors: Delabrè Stainless Steel 304
 Side panels: Delabrè Stainless Steel 304

ES Estructura: Acero inoxidable 304 natural
 Encimera: Acero inoxidable 304 Delabrè
 Puertas: Acero inoxidable 304 Delabrè
 Paneles: Acero inoxidable 304 Delabrè

FR Structure : Acier inoxydable 304 naturel
 Plan de travail : Acier inoxydable 304 Delabrè
 Portes : Acier inoxydable 304 Delabrè
 Joues : Acier inoxydable 304 Delabrè

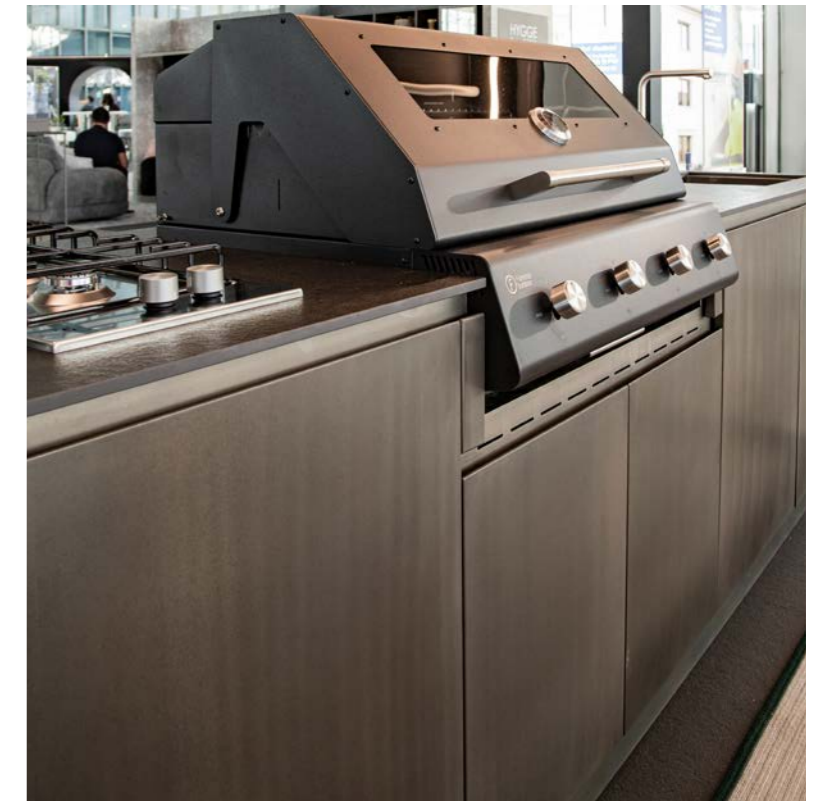

IT Struttura: Acciaio Inox 304 Naturale
 Top: Neolith sp.12mm
 Ante: Acciaio Inox Vintage
 Carter: Acciaio Inox Vintage

EN Structure: Natural Stainless Steel 304
 Worktop: Neolith thickness 12 mm
 Doors: Vintage Stainless Steel
 Side panels: Vintage Stainless Steel

ES Estructura: Acero inoxidable 304 natural
 Encimera: Neolith espesor 12 mm
 Puertas: Acero inoxidable vintage
 Paneles: Acero inoxidable vintage

FR Structure : Acier inoxydable 304 naturel
 Plan de travail : Neolith épaisseur 12 mm
 Portes : Acier inoxydable vintage
 Jous : Acier inoxydable vintage



IT Struttura: Acciaio Inox 304 Naturale
 Top: Acciaio Inox 304 Delabrè
 Ante: Acciaio Inox Laccato Ruggine Chiaro
 Carter: Acciaio Inox 304 Delabrè

EN Structure: Natural Stainless Steel 304
 Worktop: Delabrè Stainless Steel 304
 Doors: Stainless Steel lacquered Light Rust
 Side panels: Delabrè Stainless Steel 304

ES Estructura: Acero inoxidable 304 natural
 Encimera: Acero inoxidable 304 Delabrè
 Puertas: Acero inoxidable lacado Óxido claro
 Paneles: Acero inoxidable 304 Delabrè

FR Structure : Acier inoxydable 304 naturel
 Plan de travail : Acier inoxydable 304 Delabrè
 Portes : Acier inoxydable laqué Rouille claire
 Jous: Acier inoxydable 304 Delabrè



IT Struttura: Acciaio Inox 304 Naturale
 Top: Laminam
 Ante: Acciaio Inox Laccato RAL 9010
 Carter: Acciaio Inox 304 Delabrè

EN Structure: Natural Stainless Steel 304
 Worktop: Laminam
 Doors: Stainless Steel lacquered RAL 9010
 Side panels: Delabrè Stainless Steel 304

ES Estructura: Acero inoxidable 304 natural
 Encimera: Laminam
 Puertas: Acero inoxidable lacado RAL 9010
 Paneles: Acero inoxidable 304 Delabrè

FR Structure : Acier inoxydable 304 naturel
 Plan de travail : Laminam
 Portes : Acier inoxydable laqué RAL 9010
 Jous : Acier inoxydable 304 Delabrè



IT Struttura: Acciaio Inox 304 Naturale
 Top: Acciaio Inox 304 Naturale
 Ante: Acciaio Inox Vintage
 Carter: Acciaio Inox 304 Naturale

EN Structure: Natural Stainless Steel 304
 Worktop: Natural Stainless Steel 304
 Doors: Vintage Stainless Steel
 Side panels: Natural Stainless Steel 304

ES Estructura: Acero inoxidable 304 natural
 Encimera: Acero inoxidable 304 natural
 Puertas: Acero inoxidable vintage
 Paneles: Acero inoxidable 304 natural

FR Structure : Acier inoxydable 304 naturel
 Plan de travail : Acier inoxydable 304 naturel
 Portes : Acier inoxydable vintage
 Joues : Acier inoxydable 304 naturel



IT Struttura: Acciaio Inox 304 Naturale
 Top: Acciaio Inox 304 Naturale
 Ante: Acciaio Inox Laccato RAL 7030
 Filler: Acciaio Inox 304 Naturale

EN Structure: Natural Stainless Steel 304
 Worktop: Natural Stainless Steel 304
 Doors: Stainless Steel lacquered RAL 7030
 Filler: Natural Stainless Steel 304

ES Acero inoxidable 304 natural
 Encimera: Acero inoxidable 304 natural
 Puertas: Acero inoxidable lacado RAL 7030
 Filler: Acero inoxidable 304 natural

FR Structure : Acier inoxydable 304 naturel
 Plan de travail : Acier inoxydable 304 naturel
 Portes : Acier inoxydable laqué RAL 7030
 Filler : Acier inoxydable 304 naturel



IT Struttura: Acciaio Inox 304 Naturale
 Top: Acciaio Inox 304 Naturale
 Ante: Acciaio Inox 304 Naturale
 Carter: Acciaio Inox 304 Naturale

EN Structure: Natural Stainless Steel 304
 Worktop: Natural Stainless Steel 304
 Doors: Natural Stainless Steel 304
 Side panels: Natural Stainless Steel 304

ES Estructura: Acero inoxidable 304 natural
 Encimera: Acero inoxidable 304 natural
 Puertas: Acero inoxidable 304 natural
 Paneles: Acero inoxidable 304 natural

FR Structure : Acier inoxydable 304 naturel
 Plan de travail : Acier inoxydable 304 naturel
 Portes : Acier inoxydable 304 naturel
 Joues : Acier inoxydable 304 naturel



IT Struttura: Acciaio Inox 304 Naturale
 Top: Dekton 12mm
 Ante: Acciaio Inox Laccato RAL 7009
 Carter: Acciaio Inox 304 Naturale

EN Structure: Natural Stainless Steel 304
 Worktop: Dekton 12 mm
 Doors: Stainless Steel lacquered RAL 7009
 Side panels: Natural Stainless Steel 304

ES Estructura: Acero inoxidable 304 natural
 Encimera: Dekton 12 mm
 Puertas: Acero inoxidable lacado RAL 7009
 Paneles: Acero inoxidable 304 natural

FR Structure : Acier inoxydable 304 naturel
 Plan de travail : Dekton 12 mm
 Portes : Acier inoxydable laqué RAL 7009
 Joues : Acier inoxydable 304 naturel



IT Struttura: Acciaio Inox 304 Naturale
 Top: Laminam
 Ante: Acciaio Inox 304 Delabrè
 Carter: Acciaio Inox 304 Delabrè

EN Structure: Natural Stainless Steel 304
 Worktop: Laminam
 Doors: Delabrè Stainless Steel 304
 Side panels: Delabrè Stainless Steel 304

ES Estructura: Acero inoxidable 304 natural
 Encimera: Neolith espesor 12 mm
 Puertas: Acero inoxidable vintage
 Paneles: Acero inoxidable vintage

FR Structure : Acier inoxydable 304 naturel
 Plan de travail : Laminam
 Portes : Acier inoxydable 304 Delabrè
 Joues : Acier inoxydable 304 Delabrè



IT Struttura: Acciaio Inox 304 Naturale
 Top: Acciaio Inox 304 Delabrè
 Ante: Acciaio Inox Laccato Ruggine Chiaro
 Carter laterali: Acciaio inox 304 Delabrè
 Carter retro: Acciaio Inox Laccato Ruggine Chiaro

EN Structure: Natural Stainless Steel 304
 Worktop: Delabrè Stainless Steel 304
 Doors: Stainless Steel lacquered Light Rust
 Side panels: Delabrè Stainless Steel 304
 Side Panels: Stainless Steel lacquered Light Rust

ES Estructura: Acero inoxidable 304 natural
 Encimera: Acero inoxidable 304 Delabrè
 Puertas: Acero inoxidable lacado Óxido claro
 Paneles laterales: Acero inoxidable 304 Delabrè
 Panel trasero: Acero inoxidable lacado Óxido claro

FR Structure : Acier inoxydable 304 naturel
 Plan de travail : Acier inoxydable 304 Delabrè
 Portes : Acier inoxydable laqué Rouille claire
 Panneaux latéraux : Acier inoxydable 304 Delabrè
 Panneau arrière : Acier inoxydable laqué Rouille claire



IT Struttura: Acciaio Inox 304 Naturale
 Top: Laminam
 Ante: Acciaio Inox 304 Delabrè

EN Structure: Natural Stainless Steel 304
 Worktop: Laminam
 Doors: Delabrè Stainless Steel 304

ES Estructura: Acero inoxidable 304 natural
 Encimera: Laminam
 Puertas: Acero inoxidable 304 Delabrè

FR Structure : Acier inoxydable 304 naturel
 Plan de travail : Laminam
 Portes : Acier inoxydable 304 Delabrè



IT Struttura: Acciaio Inox 304 Naturale
 Ante: Acciaio Corten
 Top: Dekton
 Carter: Dekton

EN Structure: Natural Stainless Steel 304
 Worktop: Corten Steel
 Doors: Dekton
 Side panels: Dekton

ES Estructura: Acero inoxidable 304 natural
 Encimera: Acero Corten
 Puertas: Dekton
 Paneles: Dekton

FR Structure : Acier inoxydable 304 naturel
 Plan de travail : Acier Corten
 Portes : Dekton
 Jous : Dekton



IT Struttura: Acciaio Inox 304 Naturale
Ante: Acciaio Inox Vintage

EN Structure: Natural Stainless Steel 304
Doors: Vintage Stainless Steel

ES Estructura: Acero inoxidable 304 natural
Puertas: Acero inoxidable vintage

FR Structure : Acier inoxydable 304 naturel
Portes : Acier inoxydable vintage

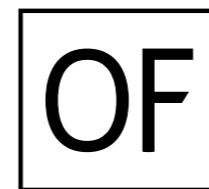

outdoorkitchens

TIPOLOGIE MODULI

Units type

Tipos de módulos

Types de modules



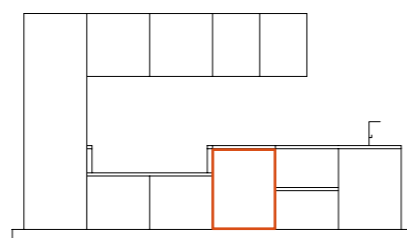

BASE ANTA

Door base unit

Base con puerta

El. bas avec porte

IT Basi ad una o due ante con cerniere in acciaio inox 304.

EN Base units with one or two doors with 304 stainless steel hinges.

ES Bases de una o dos puertas con bisagras de acero inoxidable 304.

FR *Eléments bas à une ou deux portes avec charnières en acier inoxydable 304.*



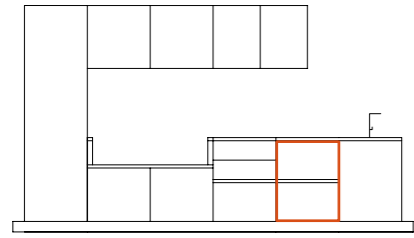

BASE CASSETTI

Drawer base unit

Base cajones

El. bas tiroirs

IT Diverse tipologie di cassettiere, un'unica costante: l'acciaio inox. Disponibili nelle varianti con uno, due cestoni oppure con due cassetti e un cestone, con la possibilità di aggiungere il kit raccolta differenziata.

EN *Different types of drawer units, one constant: stainless steel. Available with one, two baskets or with two drawers plus one basket, with the possibility of adding recycling kit.*

ES Diferentes tipos de cajoneras, una única constante: el acero inoxidable. Disponibles en las variantes con uno, dos cubos de basura o con 2 cajones + un cubo de basura, con la posibilidad de añadir set de basura.

FR *Différents types de tiroirs, une constante unique: l'acier inox. Disponibles dans les variantes avec un, deux grand tiroirs o avec 2 tiroirs + un grand tiroir, avec la possibilité d'ajouter des kits poubelle.*



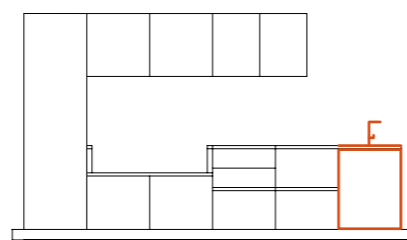

**BASE
LAVELLO**
Sink base unit
Base Fregadero
El. bas évier



IT Basi con retro o senza retro studiate appositamente per contenere lavelli di dimensioni corrispondenti.

EN Base units with or without back panels designed specifically to fit sinks of corresponding sizes.

ES Bases con o sin espaldar diseñadas específicamente para contener fregaderos de dimensiones correspondientes.

FR Bases avec arrière ou sans arrière spécialement conçues pour contenir des éviers de dimensions correspondantes.



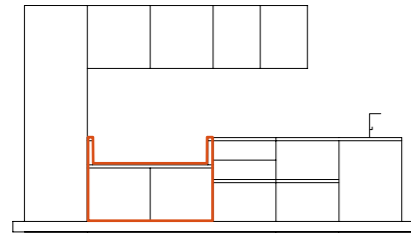

BASE BBQ

BBQ base unit
Módulos BBQ
Modules BBQ

IT Basi compatibili per l'incasso di ogni tipologia di barbecue, predisposte per bombole a gas.

EN Base units compatible for the installation of any type of barbecue, equipped for gas cylinders.

ES Bases compatibles para la instalación de cualquier tipo de barbacoa, preparadas para bombonas de gas.

FR Eléments bas compatibles pour l'encastrement de tout type de barbecue, équipées pour les bouteilles de gaz.



Barbecue a Gas
Gas Barbecue
Barbacoa de Gas
Barbecue à Gaz



Base Kamado

*Kamado base unit
Base para Kamado
El. bas pour Kamado*

IT Basi cestone con supporto per Big Green Egg, disponibili in diverse misure per ospitare differenti modelli.

EN Basket base units with holder for Big Green Egg, available in different sizes to accommodate different models.

ES Bases cesto con apoyo para Big Green Egg, disponibles en diferentes tamaños para acomodar diferentes modelos.

FR Bases grand tiroir avec soutien pour Big Green Egg, disponibles en différentes tailles pour accommoder différents modèles.

**Barbecue a Legna**

*Wood Barbecue
Barbacoa de Leña
Barbecue à Bois*

**Barbecue Elettrico**

*Electric Barbecue
Barbacoa Eléctrica
Barbecue Eléctrica*



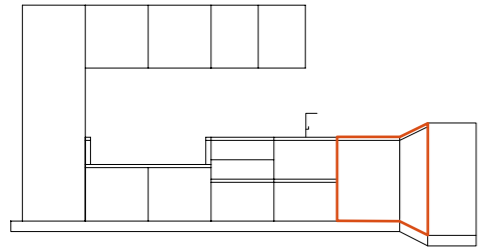

BASE ANGOLO

Corner base unit

Base angular

El. bas angle

IT Basi ad angolo in versione destra e sinistra da utilizzare come alternativa all'angolo cieco.

EN Corner base units available in left-hand and right-hand versions, to be used as an alternative to the blind corner unit.

ES Módulos bajos de esquina en versión derecha e izquierda, para utilizar como alternativa al rincón ciego.

FR Meubles bas d'angle en version droite et gauche, à utiliser comme alternative à l'angle mort.

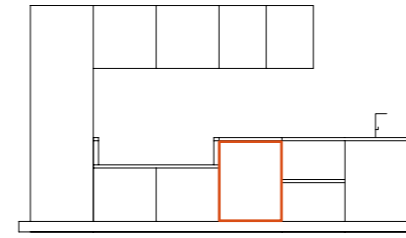

BASE PER BOMBOLE

Gas tanks base unit

Bases para botellas de gas

El. bas pour bonbonnes

IT Basi compatibili per l'incasso di ogni tipologia di barbecue, predisposte per bombole a gas.

EN Base units compatible for the installation of any type of barbecue, equipped for gas cylinders.

ES Bases compatibles para la instalación de cualquier tipo de barbacoa, preparadas para bombonas de gas.

FR Eléments bas compatibles pour l'encastrement de tout type de barbecue, équipées pour les bouteilles de gaz.



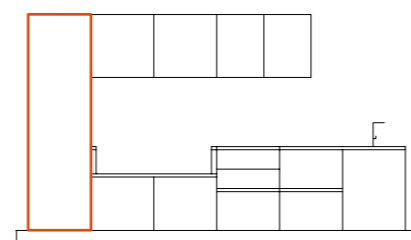

COLONNE

Tall units

Columnas

Colonnes

IT Colonne sigillate e profonde, in grado di contenere tutti gli elettrodomestici e di proteggerli dagli agenti atmosferici.

EN Sealed and deep tall units, able to hold all appliances and protect them from the weather.

ES Columnas selladas y profundas, capaces de contener todos los electrodomésticos y protegerlos de los agentes atmosféricos.

FR Des colonnes scellées et profondes, capables de contenir tous les appareils et de les protéger des intempéries.

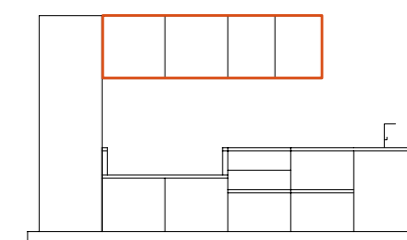

PENSILI

Wall units

Colgantes

Placards

IT Pensili con anta singola o doppia.

EN Wall units with single or double door.

ES Colgantes con puerta simple o doble.

FR Placards avec vantail simple ou double.

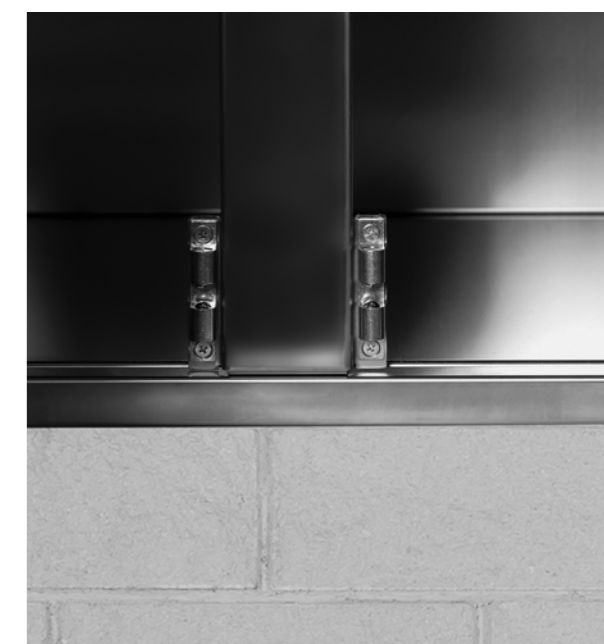

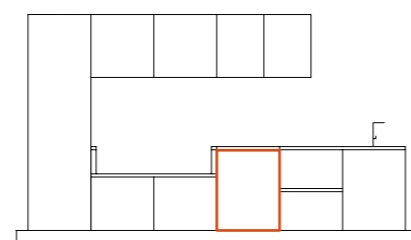

BASI A GIORNO

Open base unit

Bases abiertas

El. bas ouvertes

IT Basi a Giorno versatili e idonee al contenimento di accessori quali cantinette vino, frigoriferi, macchine del ghiaccio o legna.

EN *Versatile open modules suitable for containing accessories such as wine cooler, refrigerators, ice machines or wood.*

ES Modulos Abiertos versátiles adecuadas para contener accesorios como vinotecas, frigoríficos, máquinas de hielo o leña.

FR *Modules ouvertes polyvalentes adaptées pour contenir des accessoires tels que des caves à vin, réfrigérateurs, machines à glace ou du bois.*

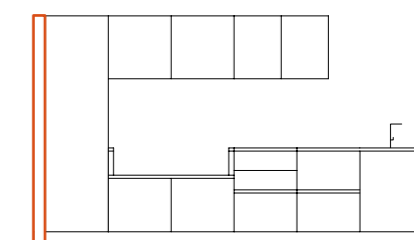
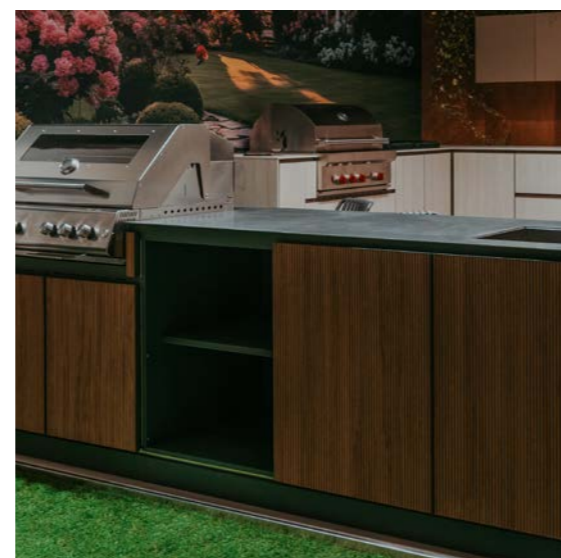

FILLER

Fillers

Regletas

Fileurs

IT Tamponamenti a filo cassa per basi, colonne e pensili, da utilizzare per il riempimento di eventuali spazi vuoti. Il range di misure è predefinito: 20mm - 300mm.

EN *Flush-mounted fillers for base units, tall units and wall units, to be used for filling any empty spaces. The range of measures is predefined: 20mm - 300mm.*

ES Rellenos enrasados para bases, columnas y colgantes, que se utilizan para rellenar cualquier hueco. El rango de medidas es predeterminado: 20mm - 300mm.

FR *Fileurs affleurants pour bases, colonnes et placards, à utiliser pour remplir des espaces vides. Le range des mesures est prédéfini: 20mm - 300mm.*



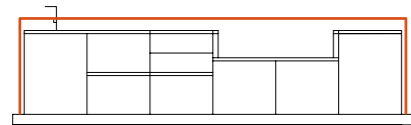

SNACK BAR

Snack bar

Snack bar
Snack bar

IT Bancone di lunghezza compresa tra 1200 mm e 3200 mm, disponibile in finitura acciaio inox naturale, acciaio inox delabrè.

EN Counter with length between 1200 mm and 3200 mm, available in natural stainless-steel finish, delabre stainless steel.

ES Barra con longitud entre 1200 mm y 3200 mm, disponible en acabado de acero inoxidable natural, acero inoxidable delabre.

FR Comptoir d'une longueur comprise entre 1200 mm et 3200 mm, disponible en finition acier inoxydable naturel, acier inoxydable Delabrè.



IT Snack bar, **variante 1 (+100mm)**. Arretrato rispetto alla parte posteriore della cucina, lo snack bar presenta due distanziali laterali che ne permettono il montaggio.

EN Snack bar, **variant 1 (+100mm)**. Set back from the rear of the kitchen, the snack bar has two side spacers that allow the installation.

ES Snack bar, **variante 1 (+100mm)**. Situado detrás de la parte trasera de la cocina, el snack bar dispone de dos separadores laterales que permiten su montaje.

FR Snack bar, **variante 1 (+100mm)**. En retrait par rapport à l'arrière de la cuisine, le snack bar est doté de deux entretoises latérales qui en permettent le montage.

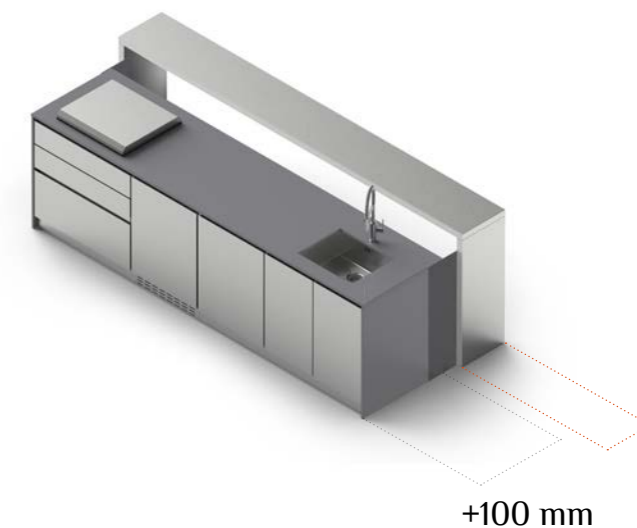

+100 mm

IT Snack bar, **variante 2 (0mm)**. In linea con il retro della cucina, lo snack bar presenta due distanziali laterali che ne permettono il montaggio.

EN Snack bar, **variant 2 (0mm)**. In line with the rear of the kitchen, the snack bar has two side spacers that allow the installation.

ES Snack bar, **variante 2 (0mm)**. En línea con la parte trasera de la cocina, el snack bar dispone de dos separadores laterales que permiten su montaje.

FR Snack bar, **variante 2 (0mm)**. En ligne avec l'arrière de la cuisine, le snack bar est doté de deux entretoises latérales qui en permettent le montage.

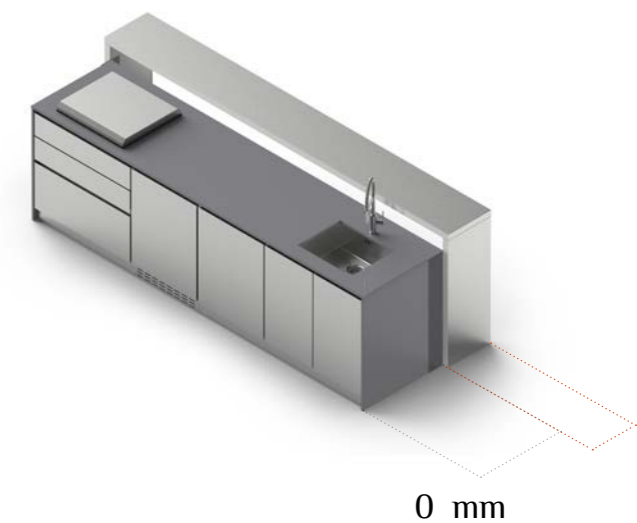

0 mm

IT Snack bar, **variante 3 (-100mm)**. Con i fianconi montati direttamente sui carter laterali della cucina, questa opzione non è attuabile in presenza di barbecue, in quanto non ne consentirebbe l'apertura.

EN Snack bar, **variant 3 (-100mm)**. With the sides installed directly on the side panels of the kitchen, this option is not feasible in the presence of barbecues, as it would not allow their opening.

ES Snack bar, **variante 3 (-100mm)**. Con los paneles montados directamente en los paneles laterales de la cocina, esta opción no es viable en presencia de barbacoas, ya que no permitiría su apertura.

FR Snack bar, **variante 3 (-100mm)**. Avec les panneaux monté directement sur les panneaux latéraux de la cuisine, cette option n'est pas réalisable en présence de barbecues, car cela ne permettrait pas de les ouvrir.

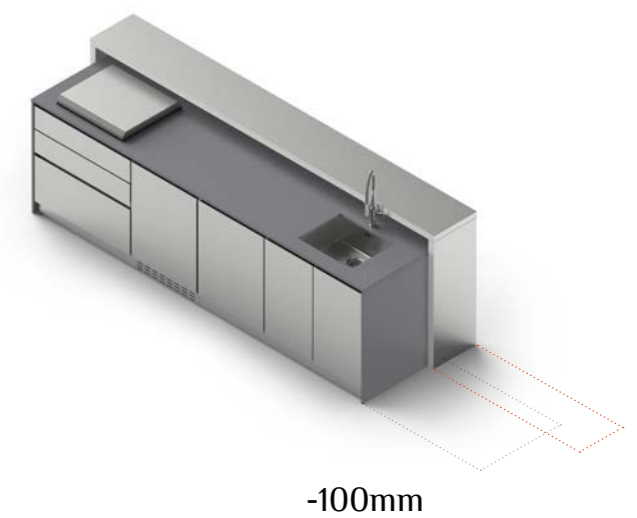

-100mm

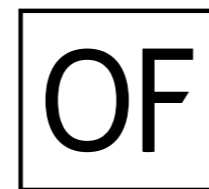

outdoorkitchens

ELETTRODOMESTICI E ACCESSORI

Appliances and Accessories

Electrodomésticos y Accesorios

Électroménagers et Accessoires



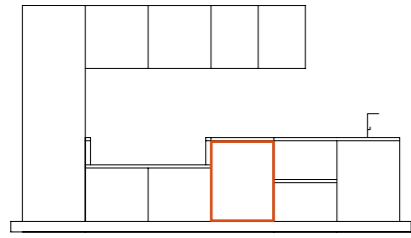

ELETTRODOMESTICI

Appliances

Electrodomesticos

Électroménagers

IT Accessori ed elettrodomestici integrati con garanzia sull'acquisto. La protezione contro gli agenti atmosferici è assicurata dall'impermeabilità della cassa in acciaio inox.

EN Accessories and appliances with purchase guarantee. Protection against atmospheric agents is ensured by the waterproofness of the stainless steel carcass.

ES Bases y puertas para electrodomésticos con garantía de compra. La protección contra los agentes atmosféricos está asegurada por la impermeabilidad de la caja de acero inoxidable.

FR Bases et vantaux pour électroménagers avec garantie sur l'achat. La protection contre les intempéries est assurée par l'étanchéité de la caisse en acier inox.



Base lavatrice
Washing machine base unit
Mueble bajo para lavadora
Meuble bas pour lave-linge



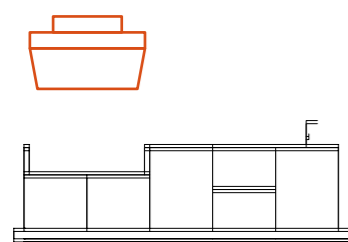

CAPPA

Cooker hood

Campana extractora

Hotte

IT Progettata e realizzata internamente la cappa filtrante unisce design, potenza ed efficienza. Disponibile nelle versioni da 120 e 150 cm, non richiede fori di aspirazione: l'aria viene filtrata e reimpressa nell'ambiente, rendendo l'installazione semplice e versatile. I filtri sono studiati per trattenere efficacemente i grassi convogliandoli nelle pratiche vaschette di raccolta, garantendo pulizia e funzionalità nel tempo. Realizzata in Inox naturale 304, è dotata di doppio motore ad alte prestazioni (1700 mc/h totali), illuminazione LED IP44 integrata e pulsantiera con 3 velocità di aspirazione per adattarsi a ogni esigenza di cottura.

EN Designed and manufactured in-house, the filter hood combines design, power and efficiency. Available in 120 cm and 150 cm versions, it does not require ducting holes: the air is filtered and recirculated into the room, making installation simple and versatile. The filters are engineered to effectively capture grease, channeling it into practical collection trays to ensure long-term cleanliness and performance. Made of natural 304 stainless steel, it features a high-performance dual motor (total output 1700 m³/h), integrated IP44-rated LED lighting and a push-button control panel with 3 extraction speeds to suit every cooking need.



ES Diseñada y fabricada internamente, la campana filtrante combina diseño, potencia y eficiencia. Disponible en versiones de 120 y 150 cm, no requiere salidas de extracción: el aire se filtra y se reintroduce en el ambiente, lo que hace que la instalación sea sencilla y versátil. Los filtros están diseñados para retener eficazmente las grasas, canalizándolas hacia prácticas bandejas de recogida, garantizando limpieza y funcionalidad a lo largo del tiempo. Fabricada en acero inoxidable natural AISI 304, cuenta con doble motor de alto rendimiento (1700 m³/h totales), iluminación LED integrada con grado de protección IP44 y botonera con 3 velocidades de aspiración para adaptarse a cualquier necesidad de cocción.

FR Conçue et fabriquée en interne, la hotte filtrante allie design, puissance et efficacité. Disponible en versions 120 cm et 150 cm, elle ne nécessite pas de conduit d'extraction : l'air est filtré puis réinjecté dans la pièce, rendant l'installation simple et polyvalente. Les filtres sont conçus pour retenir efficacement les graisses en les dirigeant vers des bacs de récupération pratiques, garantissant propreté et performance dans le temps. Réalisée en acier inoxydable naturel AISI 304, elle est équipée d'un double moteur haute performance (1700 m³/h au total), d'un éclairage LED intégré IP44 et d'un panneau de commande à 3 vitesses d'aspiration pour s'adapter à tous les besoins de cuisson.



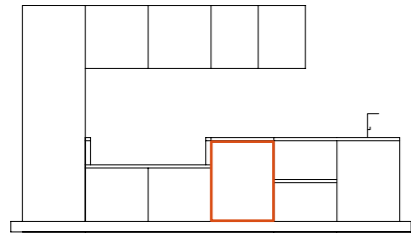

SPINATORE BIRRA

Compressed Air Beer Tap

Grifo de Cerveza

Tireuse a biere

IT Spinatore ad aria compressa installato su base da 45 o 60 cm. Portata max 25-35 litri/h.

EN Compressed air Tap installed on a 45 or 60 cm base. Max flow rate 25-35 liters/h.

ES Cerveza de aire comprimido instalado sobre base de 45 o 60 cm. Caudal máximo 25-35 litros/h.

FR Tireuse a biere à air comprimé installée sur un socle de 45 ou 60 cm. Débit maximum 25-35 litres/h.



FORNI PIZZA

Pizza oven

Horno Pizzas

Four à Pizza

IT Forni Pizza a Gas da 2 pizze

EN Gas Pizza Ovens for 2 pizzas

ES Hornos de pizza a gas para 2 pizzas

FR Fours à pizza à gaz pour 2 pizzas



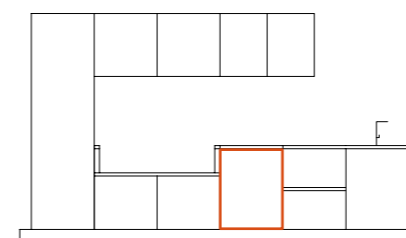

RACCOLTA DIFFERENZIATA

Waste Recycling Kit

Kit de Reciclaje basura

Kit de Recyclage déchets

IT Grazie alle sue dimensioni importanti, il Kit portarifiuti integrato all'interno di basi a cestone permette di gestire facilmente la raccolta differenziata.

EN Thanks to its large dimensions, the waste bin kit integrated inside the base units allows you to easily manage separate waste collection.

ES Gracias a sus grandes dimensiones, el kit de papelera integrado en el interior de las bases de las cestas permite gestionar fácilmente la recogida selectiva de residuos.

FR Grâce à ses grandes dimensions, le kit poubelle intégré à l'intérieur des bases permet de gérer facilement la collecte sélective des déchets.



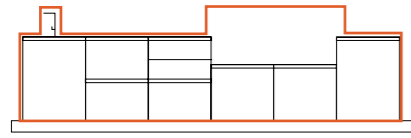

COVER

Cover

Funda

Couverture

IT Cover su misura e impermeabili, disponibili in versione ad isola e a muro, le cover proteggono le cucine da esterno da ogni agente atmosferico, in tutte le stagioni

EN Custom and waterproof Cover, available in island and wall versions, the covers protect the outdoor kitchens from any atmospheric agent, in all seasons.

ES Funda a medida e impermeables, disponibles en versión de isla y pared, las fundas protegen las cocinas de exterior de cualquier agente atmosférico, en todas las estaciones.

FR Couverture Sur mesure et imperméables, disponibles en version îlot et murale, les couvertures protègent les cuisines d'extérieurs de tous les agents atmosphérique, en toutes saisons.



IT Versione a isola. **EN** Island version. **ES** Versión de isla. **FR** Version îlot.



IT Versione a parete. Cover fissata, con strisce in velcro, su barre in acciaio avvitate al muro.

EN Wall version. Cover fixed, with velcro strips, on steel bars screwed to the wall.

ES Versión de pared. Funda fijada, con tiras de velcro, en barras de acero atornilladas a la pared.

FR Version murale. Couvercle fixé, avec des bandes velcro, sur des barres d'acier vissées au mur.

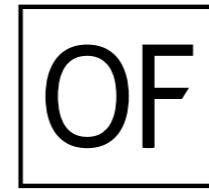

outdoorkitchens

MATERIALI E FINITURE

Materials and finishes

Materiales y Acabados

Matériaux et Finitions



MATERIALI E FINITURE

Materials and finishes

Materiales y Acabados

Matériaux et Finitions

IT Non solo acciaio inox naturale, ma una pluralità di materiali, finiture e colori per personalizzare la propria cucina da esterno in base al proprio stile di vita.

EN Not only natural stainless steel, but a plurality of materials, finishes and colours to customise their outdoor kitchen according to their lifestyle.

ES No sólo el acero inoxidable natural, sino una pluralidad de materiales, acabados y colores para personalizar su cocina de exterior según su estilo de vida.

FR Non seulement l'acier inox naturel, mais une pluralité de matériaux, de finitions et de couleurs pour personnaliser sa cuisine d'extérieur en fonction de son style de vie.

1 Acciaio inox naturale
Natural stainless steel
Acero inoxidable natural
Acier inox naturel

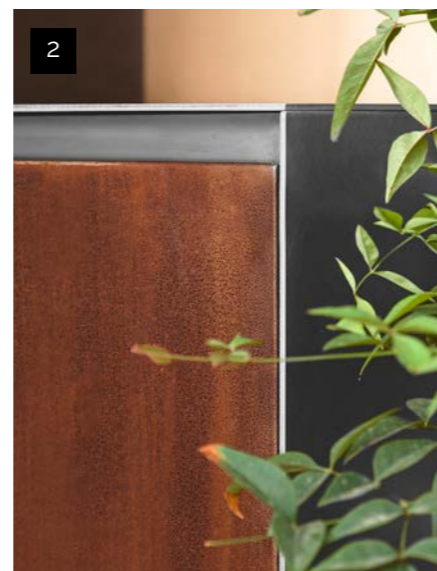

2 Acciaio corten
Corten steel
Acero corten
Acier corten

3 Acciaio Inox Laccato
Opaco Goffrato
Embossed matt lacquered stainless steel
Acero inoxidable lacado
mate gofrado
Acier laqué mate gaufré



4 Acciaio inox Delabré
Delabré stainless steel
Acero inoxidable Delabré
Acier inox Délabré

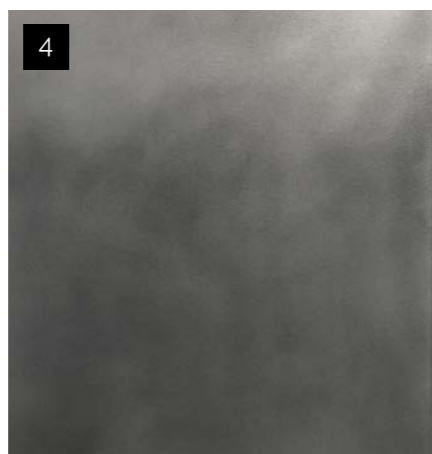

5 Acciaio inox vintage
Vintage stainless steel
Acero inoxidable vintage
Acier inox vintage

Riepilogo materiali e componenti

Materials and components

MATERIALI MATERIALS	COMPONENTI COMPONENTS	Ante Doors	Gola Groove	Casse Carcasses	Top Worktop	Zoccolo Plinth	Carter Laterali Side Panels	Carter Retro Back Panel
Acciaio inox vintage <i>Vintage stainless steel</i>		■	■			■	■	■
Acciaio Corten <i>Corten Steel</i>		■						
Acciaio inox naturale <i>Natural stainless steel</i>		■	■	■	■	■	■	■
Acciaio inox Delabré <i>Delabré stainless steel</i>		■	■		■	■	■	■
Acciaio inox laccato opaco gofrato <i>Embossed matt lacquered stainless steel</i>		■	■			■	■	■
LAMINAM		■			■		■	
DEKTON / NEOLITH					■		■	
Legno TEAK <i>Teak Wood</i>		■						

↓ Teak

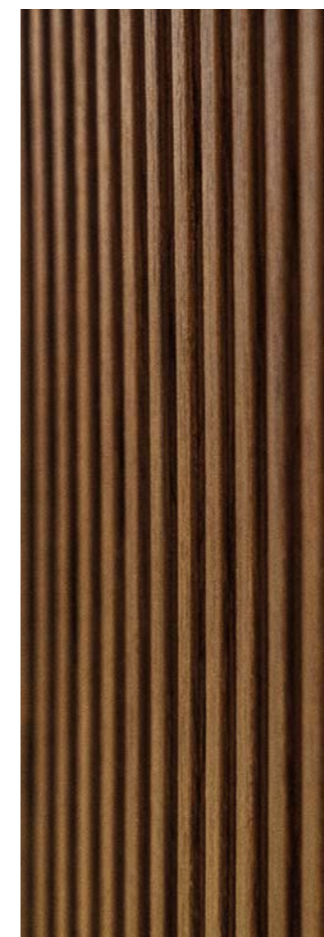

↓ Laminam



↓ Dekton



↓ Neolith



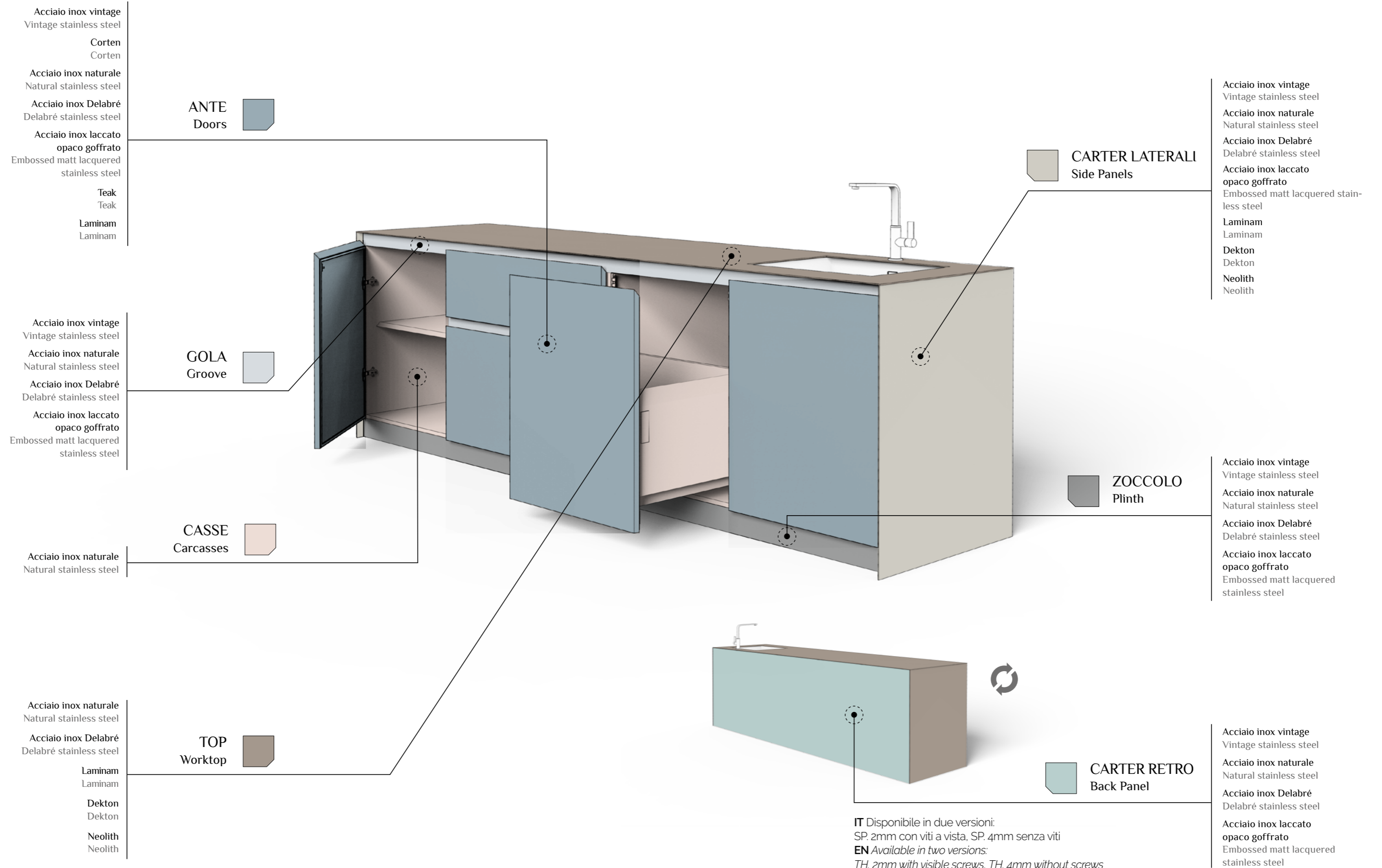

IT Disponibile in due versioni:
 SP. 2mm con viti a vista, SP. 4mm senza viti
EN Available in two versions:
 TH. 2mm with visible screws, TH. 4mm without screws
ES Disponible en dos versiones:
 ESP. 2mm con tornillos visibles, ESP. 4mm sin tornillos
FR Disponibles en deux versions:
 EP. 2mm avec vis visibles, EP. 4mm sans vis

COMPOSIZIONI PREDEFINITE

Predefined Composition
Composiciones predefinidas
Compositions prédéfinies

IT Via Nolfi è disponibile in diverse lunghezze e nelle versioni a parete o a isola. I moduli interni consentono l'integrazione di contenitori, apparecchi di cottura e lavaggio mantenendo la continuità dei frontali. Il modello può essere configurato a partire da composizioni definite oppure combinando i singoli elementi in base allo spazio e alle funzioni richieste.

EN *Via Nolfi is available in different lengths and in wall-mounted or island versions. Internal modules allow the integration of storage units, cooking and washing appliances while maintaining the continuity of the fronts. The model can be specified from a set of defined configurations or by combining individual elements according to the available space and required functions.*

ES Via Nolfi está disponible en distintas longitudes y en versiones a pared o en isla. Los módulos interiores permiten integrar almacenaje y equipos de cocción y lavado, manteniendo la continuidad de los frontales. El modelo puede configurarse a partir de composiciones definidas o combinando los distintos elementos en función del espacio y de las necesidades de uso.

FR *Via Nolfi est disponible en différentes longueurs, en version adossée au mur ou en îlot. Les modules internes permettent d'intégrer des rangements ainsi que des équipements de cuisson et de lavage, tout en préservant la continuité des façades. Le modèle peut être composé à partir de configurations définies ou en combinant les éléments selon l'espace disponible et les fonctions requises.*



VIA NOLFI 527

IT L 210,8 cm. Finitura in acciaio inox Delabré 304. Completa di piano cottura a gas, barbecue 4 fuochi, lavello sopratop, rubinetto. Disponibile anche nella versione ad isola e con lavello a sinistra.

EN *L 210,8 cm. 304 Delabre stainless steel finish. Complete with gas hob, 4-burner barbecue, in-set sink, faucet. Also available in island version and with sink on the left.*

ES L 210,8 cm. Acabado en acero inoxidable Delabre 304. Incluye placa de gas, barbacoa de 4 quemadores, fregadero sobre encimera, grifo. Disponible también en versión en isla y con fregadero a la izquierda.

FR *L 210,8 cm. Finition en acier inoxydable Delabré 304. Complète de plan de cuisson à gaz, un barbecue à 4 brûleurs, évier sur plan, robinet. Disponible également en version îlot et avec évier à gauche.*



VIA NOLFI 529

IT L 270,8 cm. Finitura in acciaio inox Delabré 304. Completa di cassetto interno, barbecue 4 fuochi, lavello sopratop, rubinetto. Disponibile anche nella versione ad isola e con lavello a sinistra.

EN *L 270,8 cm. 304 Delabre stainless steel finish. Complete with internal drawer, 4-burner barbecue, in-set sink, faucet. Also available in island version and with sink on the left.*

ES L 270,8 cm. Acabado en acero inoxidable Delabre 304. Incluye cajón interior, barbacoa de 4 quemadores, fregadero sobre encimera, grifo. Disponible también en versión en isla y con fregadero a la izquierda.

FR *L 270,8 cm. Finition en acier inoxydable Delabré 304. Complète de tiroir interne, barbecue à 4 brûleurs, évier sur plan, robinet. Disponible également en version îlot et avec évier à gauche.*



VIA NOLFI 530

IT L 270,8 cm. Finitura in acciaio inox delabré 304. Completa di piano cottura a gas, barbecue 4 fuochi, lavello sopratop, rubinetto. Disponibile anche nella versione ad isola e con lavello a sinistra.

EN *L 270,8 cm. 304 Delabre stainless steel finish. Complete with gas hob, 4-burner barbecue, in-set sink, faucet. Also available in island version and with left-sided sink.*

ES L 270,8 cm. Acabado en acero inoxidable Delabre 304. Incluye placa de gas, barbacoa de 4 quemadores, fregadero sobre encimera, grifo. Disponible también en versión en isla y con fregadero a la izquierda.

FR *L 270,8 cm. Finition en acier inoxydable Delabré 304. Complète de plaque à gaz, barbecue à 4 brûleurs, évier sur plan, robinet. Disponible également en version îlot et avec évier à gauche.*



VIA NOLFI 531

IT L 272,8 cm. Finitura in acciaio inox delabré 304. Completa di piano cottura a gas, barbecue 4 fuochi, frigorifero, lavello sopratop, rubinetto. Disponibile anche nella versione ad isola e con lavello a sinistra.

EN *L 272,8 cm. Finish 304 Delabre stainless steel finish. Complete with gas hob, 4-burner barbecue, fridge, in-set sink, faucet. Also available in island version and with sink on the left.*

ES L 272,8 cm. Acabado en acero inoxidable Delabre 304. Incluye placa de gas, barbacoa de 4 quemadores, nevera, fregadero sobre encimera, grifo. Disponible también en versión en isla y con fregadero a la izquierda.

FR *L 272,8 cm. Finition en acier inoxydable Delabré 304. Complète de plaque à gaz, barbecue à 4 brûleurs, réfrigérateur, évier sur plan, robinet. Disponible également en version îlot et avec évier à gauche.*

COMPOSIZIONI MODULARI

Modular configurations
Composiciones modulares
Compositions modulaires

IT Le cucine OF sono composte da moduli dimensionalmente coordinati tra loro. Le configurazioni possono essere ottenute partendo da soluzioni definite oppure combinando i singoli elementi in base allo spazio disponibile e alle funzioni richieste.

EN *OF Kitchens are built from modules with coordinated dimensions. Configurations can be created from defined solutions or by combining individual elements according to the available space and required functions.*

ES Las cocinas OF se componen de módulos con dimensiones coordinadas entre sí. Las configuraciones pueden obtenerse a partir de soluciones definidas o combinando los distintos elementos en función del espacio disponible y de las funciones requeridas.

FR *Les cuisines OF sont composées de modules aux dimensions coordonnées. Les configurations peuvent être réalisées à partir de solutions définies ou en combinant les différents éléments selon l'espace disponible et les fonctions requises.*

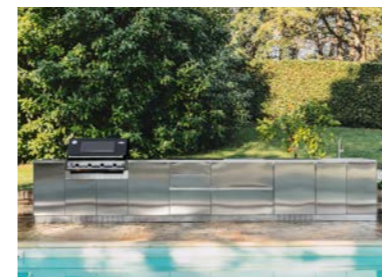

COMPOSIZIONE 1 / p. 94

Acciaio Inox Naturale
Natural stainless steel
Acero inoxidable natural
Acier inox naturel



COMPOSIZIONE 1 / p. 96

Acciaio Inox Delabré
Delabré stainless steel
Acero inoxidable delabré
Acier inox délabré



COMPOSIZIONE 1 / p. 98

Acciaio Inox Vintage
Vintage stainless steel
Acero inoxidable vintage
Acier inox vintage



COMPOSIZIONE 3 / p. 100

Acciaio Inox Laccato Opaco Goffrato RAL 7030
Embossed matt lacquered stainless steel RAL 7030
Acero inoxidable lacado mate gofrado RAL 7030
Acier inox laqué mate gaufré RAL 7030



COMPOSIZIONE 1 / p. 102

Acciaio Inox Laccato Opaco Goffrato RAL 3005
Embossed matt lacquered stainless steel RAL 3005
Acero inoxidable lacado mate gofrado RAL 3005
Acier inox laqué mate gaufré RAL 3005

COMPOSIZIONE 1

Acciaio Inox Naturale

Natural stainless steel
Acero inoxidable natural
Acier inox naturel

Elementi Elements Elementos Eléments

Cassetti interni, barbecue Beefeater, 1 cestone e 2 cassetti, 2 cestoni, piano a induzione, frigo, lavello sopratop, rubinetto *Internal drawers, Beefeater barbecue, 1 basket and 2 drawers, 2 baskets, induction hob, fridge, in-set sink, tap* Cajones interiores, barbaocia Beefeater, 1 cesto y 2 cajones, 2 cestos, placa de inducción, nevera, fregadero, grifo *Tiroirs intérieurs, barbecue Beefeater, 1 grand tiroir et 2 tiroirs, 2 grands tiroirs, plan à induction, frigo, évier, robinet*

Descrizione Description Descripción Description

Cucina da esterno in acciaio inox naturale
Natural stainless steel outdoor kitchen
Cocina de exterior de acero inoxidable natural *Cuisine pour extérieur en acier inox naturel*

Caratteristiche tecniche Technical characteristics

Modello Model	OF Via Nolfi da esterno <i>OF Via Nolfi outdoor</i>
Finitura cassa Carcass finish	Acciaio inox naturale 304 <i>304 natural stainless steel</i>
Finitura frontale Door finish	Acciaio naturale 304 (Smart) <i>304 Natural steel (Smart)</i>
Top Worktop	Spessore 4mm Acciaio inox naturale 304 <i>4mm thick 304 natural stainless steel</i>
Gola sottotop Insert groove	Orizzontale Acciaio inox naturale 304 <i>Horizontal 304 natural stainless steel</i>
Zoccolo Plinth	H100 Acciaio inox naturale 304 <i>H100 304 natural stainless steel</i>
Lavello Sink	OF / Installazione sopratop <i>OF / In-set installation</i>
Rubinetto Tap	OF / Square <i>OF / Square</i>
Pc. Induzione Induction hob	OF / Bosch bianco <i>OF / Bosch bianco</i>

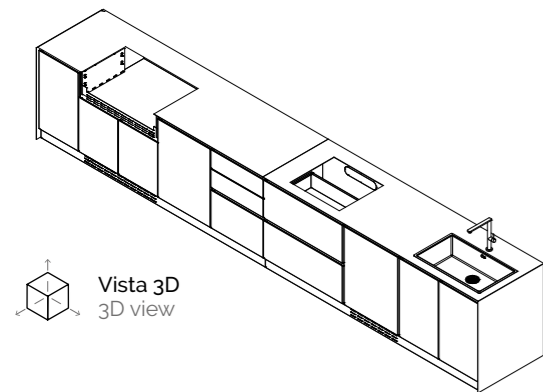

Vista 3D
3D view

Vista dall'alto Top view Vista superior Vue du haut

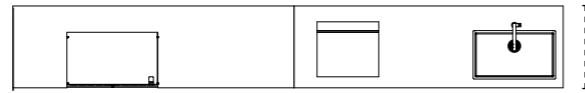

Profondità Depth Profundidad Profondeur 765 mm

Vista frontale Front view Vista frontal Vue frontale

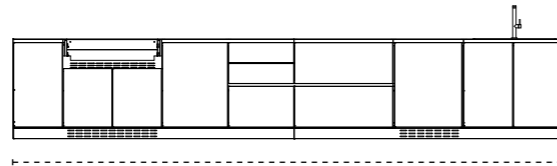

Larghezza Width Anchura Largeur 5000 mm

Vista laterale Side view Vista lateral Vue latérale

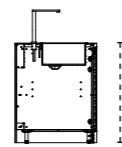

Altezza Height Altura Hauteur 904 mm



COMPOSIZIONE 2

Acciaio Inox Delabré

Delabré stainless steel
Acero inoxidable delabré
Acier inox délabré

Elementi Elements Elementos Eléments
Fornello a gas da incasso tripla corona
con coperchio inox, Plancha Planet, lavello sopratop,
rubinetto *Triple crown gas hob with steel cover,*
Plancha Planet, in-set sink, tap
Placa de gas empotrada triple corona con tapa de
acero inoxidable, Plancha Planet, fregadero sobre
encimera, grifo *Cuisinière à gaz encastrée triple*
couronne avec couvercle inox, Plancha Planet, évier
sur plan, robinet

Descrizione Description Descripción Description
Cucina da esterno in acciaio inox delabré
Delabré stainless steel outdoor kitchen
Cocina de exterior de acero inoxidable natural
Cuisine pour l'extérieur en acier inox délabré

Caratteristiche tecniche

Technical characteristics

Modello Model	OF Via Nolfi da esterno OF Via Nolfi outdoor
Finitura cassa Carcass finish	Acciaio inox naturale 304 304 natural stainless steel
Finitura frontale Door finish	Acciaio inox delabré 304 (Smart) 304 delabré stainless steel (Smart)
Top Worktop	Spessore 4mm Acciaio inox delabré 304 4mm thick 304 delabré stainless steel
Gola sottotop Insert groove	Orizzontale Acciaio inox naturale 304 Horizontal 304 natural stainless steel
Zoccolo Plinth	H100 Acciaio inox naturale 304 H100 304 natural stainless steel
Lavello Sink	OF / Installazione sopratop OF / In-set installation
Rubinetto Tap	OF / Square OF / Square
Bbq Bbq	Plancha Planet Plancha Planet
Fornello a gas Gas hob	Da incasso tripla corona Built-in triple crown

Vista 3D
3D view

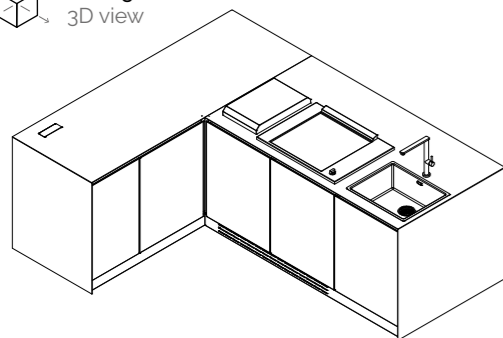

Vista dall'alto Top view Vista superior Vue du haut

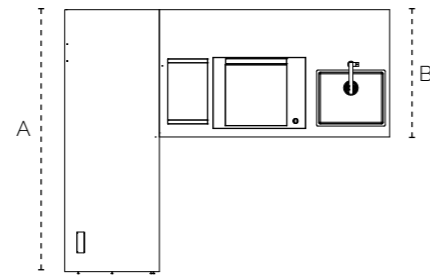

Profondità Depth Profundidad Profondeur A-2058 / B-1000 mm

Vista frontale Front view Vista frontal Vue frontale

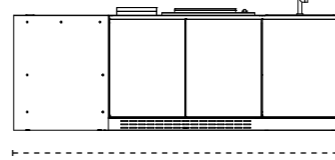

Larghezza Width Anchura Largeur 2553 mm

Vista laterale Side view Vista lateral Vue latérale

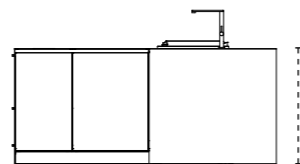

Altezza Height Altura Hauteur 904 mm



COMPOSIZIONE 3

Acciaio Inox Vintage

Vintage stainless steel
Acero inoxidable vintage
Acier inox vintage

Elementi Elements Elementos Eléments

Big Green Egg, cestone, cassetto interno, barbecue
Dolcevita, frigo, lavello sopratop, rubinetto

*Big Green Egg, basket, internal drawer, Dolcevita
barbecue, fridge, in-set sink, tap*

Big Green Egg, cesto, cajón interior, barbacoa
Dolcevita, nevera, fregadero sobre encimera, grifo
*Big Green Egg, grand tiroir, tiroir intérieur, barbecue
Dolcevita, réfrigérateur, évier sur plan, robinet*

Descrizione Description Descripción Description

Cucina da esterno in acciaio inox vintage

Vintage stainless steel outdoor kitchen

Cocina de exterior de acero inoxidable vintage

Cuisine pour extérieur en acier inox vintage

Caratteristiche tecniche

Technical characteristics

Modello Model	OF Via Nolfi da esterno <i>OF Via Nolfi outdoor</i>
Finitura cassa Carcass finish	Acciaio inox naturale 304 <i>304 natural stainless steel</i>
Finitura frontale Door finish	Acciaio inox vintage 304 (Smart) <i>304 vintage stainless steel (Smart)</i>
Top Worktop	Spessore 4mm Acciaio inox delabrè 304 <i>4mm thick 304 delabrè stainless steel</i>
Gola sottotop Undermount groove	Orizzontale Acciaio inox naturale 304 <i>Horizontal 304 natural stainless steel</i>
Zoccolo Plinth	H100 Acciaio inox naturale 304 <i>H100 304 natural stainless steel</i>
Carter laterali Side panels	Spessore 4mm Acciaio inox vintage 304 <i>4mm thick 304 vintage stainless steel</i>
Carter retro Back panel	Spessore 4mm Acciaio inox delabrè 304 <i>4mm thick 304 delabrè stainless steel</i>
Lavello Sink	OF / Installazione sopratop <i>OF / In-set installation</i>
Rubinetto Tap	OF / Square <i>OF / Square</i>
Bbq BBq	OF / Bbq Dolcevita <i>OF / Dolcevita bbq</i>

Vista 3D
3D view

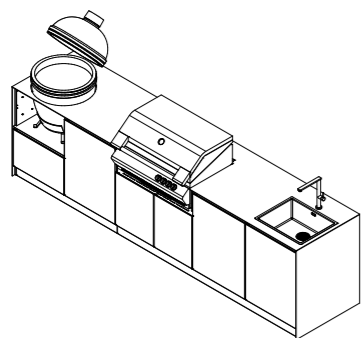

Vista dall'alto Top view Vista superior Vue du haut

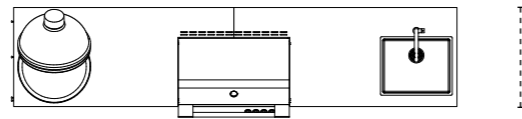

Profondità Depth Profundidad Profondeur 744 mm

Vista frontale Front view Vista frontal Vue frontale

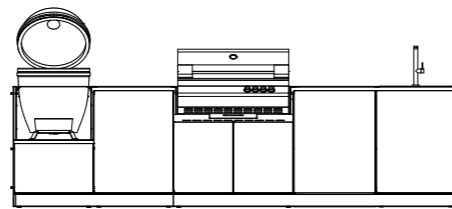

Larghezza Width Anchura Largeur 3330 mm

Vista laterale Side view Vista lateral Vue latérale

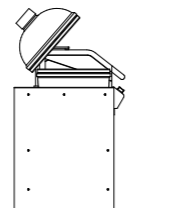

Altezza Height Altura Hauteur 904 mm



COMPOSIZIONE 4

Acciaio Inox Laccato Opaco Goffrato RAL 7030

Embossed matt lacquered stainless steel RAL 7030
Acero inoxidable lacado mate gofrado RAL 7030
Acier inox laqué mate gaufré RAL 7030

Elementi Elements Elementos Eléments

Lavello sopratop, rubinetto, barbecue DolceVita
In-set sink, tap, DolceVita barbecue

Fregadero sobre encimera, grifo, barbacoa DolceVita
Évier sur plan, robinet, barbecue DolceVita

Descrizione Description Descripción Description

Cucina da esterno laccata opaca gofrata in RAL 7030
Embossed matt lacquered outdoor kitchen in RAL 7030
Cocina de exterior lacada mate gofrada en RAL 7030
Cuisine pour extérieur laquée mate gaufrée en RAL 7030

Caratteristiche tecniche

Technical characteristics

Modello Model	OF Via Nolfi da esterno <i>OF Via Nolfi outdoor</i>
Finitura cassa Carcass finish	Acciaio inox naturale 304 <i>304 natural stainless steel</i>
Finitura frontale Door finish	Acciaio inox laccato opaco gofrato 304 (Smart) <i>304 embossed matt lacquered stainless steel (Smart)</i>
Top Worktop	Spessore 4mm Acciaio inox naturale 304 <i>4mm thick 304 natural stainless steel</i>
Gola sottotop Insert groove	Orizzontale Acciaio inox naturale 304 <i>Horizontal 304 natural stainless steel</i>
Zoccolo Plinth	H100 Acciaio inox naturale 304 <i>H100 304 natural stainless steel</i>
Carter Panels	Spessore 4mm Acciaio inox naturale 304 <i>4mm thick 304 natural stainless steel</i>
Lavello Sink	OF / Installazione sopratop <i>OF / In-set installation</i>
Rubinetto Tap	OF / Square <i>OF / Square</i>
Bbq BBq	OF / Bbq DolceVita <i>OF / DolceVita bbq</i>



Vista 3D
3D view

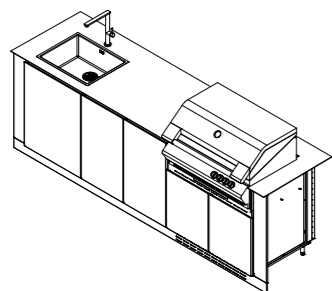

Vista dall'alto Top view Vista superior Vue du haut



Profondità Depth Profundidad Profondeur 744 mm

Vista frontale Front view Vista frontal Vue frontale

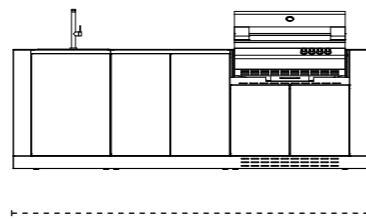

Larghezza Width Anchura Largeur 2680 mm

Vista laterale Side view Vista lateral Vue latérale

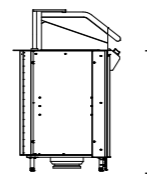

Altezza Height Altura Hauteur 904 mm



COMPOSIZIONE 5

Acciaio Inox Laccato Opaco Goffrato RAL 3005

Embossed matt lacquered stainless steel RAL 3005
 Acero inoxidable lacado mate gofrado RAL 3005
 Acier inox laqué mate gaufré RAL 3005

Elementi Elements Elementos Eléments

Piano cottura a gas, barbecue Napoleon, lavello sopratop, rubinetto
Gas hob, Napoleon barbecue, in-set sink, tap
 Placa de gas, barbacoa Napoleon, fregadero sobre encimera, grifo
Cuisinière a gaz, barbecue Napoleon, évier sur plan, robinet

Descrizione Description Descripción Description

Cucina da esterno laccata opaca gofrata in RAL 3005
Embossed matt lacquered outdoor kitchen in RAL 3005
 Cocina de exterior lacada mate gofrada en RAL 3005
Cuisine pour extérieur laquée mate gaufrée en RAL 3005

Caratteristiche tecniche

Technical characteristics

Modello Model	OF Via Nolfi da esterno OF Via Nolfi outdoor
Finitura cassa Carcass finish	Acciaio inox naturale 304 304 natural stainless steel
Finitura frontale Door finish	Acciaio inox laccato opaco gofrato (Smart) Embossed matt lacquered stainless steel (Smart)
Top Worktop	Spessore 4mm Acciaio inox delabrè 304 4mm thick 304 delabrè stainless steel
Gola sottotop Insert groove	Orizzontale Acciaio inox laccato opaco gofrato 304 Horizontal 304 embossed matt lacquered stainless steel
Zoccolo Plinth	H100 Acciaio inox laccato opaco gofrato 304 H100 304 embossed matt lacquered stainless steel
Carter Panels	Spessore 4mm Acciaio inox delabrè 304 4mm thick 304 delabrè stainless steel
Lavello Sink	OF / Installazione sopratop OF / In-set installation
Rubinetto Tap	OF / Square OF / Square
Bbq BBq	OF / Bbq Napoleon OF / Napoleon bbq
Fornello a gas Gas hob	Da incasso tripla corona Built-in triple crown

Vista 3D
3D view

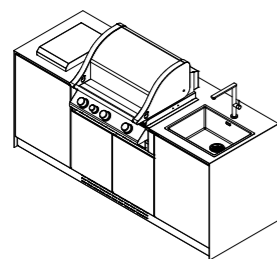

Vista dall'alto Top view Vista superior Vue du haut

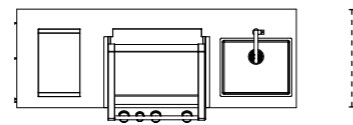

Profondità Depth Profundidad Profondeur 744 mm

Vista frontale Front view Vista frontal Vue frontale

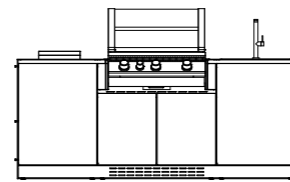

Larghezza Width Anchura Largeur 2110 mm

Vista laterale Side view Vista lateral Vue latérale

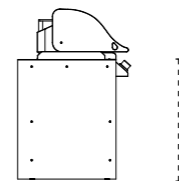

Altezza Height Altura Hauteur 904 mm





ATTENZIONE ALL'AMBIENTE

Environmental responsibility

Atención al medio ambiente

Attention à l'environnement

IT I trattamenti superficiali sono realizzati con cicli di verniciatura a ridotto contenuto di Composti Organici Volatili (COV), controllati tramite verifiche periodiche di laboratorio. Questo consente di limitare le emissioni durante la produzione e di ottenere superfici stabili nel tempo, riducendo la necessità di interventi di ripristino. I processi adottati sono conformi ai principali standard internazionali di riferimento per la qualità ambientale degli edifici.

EN Surface treatments are carried out using low-VOC (Volatile Organic Compounds) coating cycles, monitored through periodic laboratory testing. This helps limit emissions during production and delivers surfaces that remain stable over time, reducing the need for restoration work. The processes adopted comply with the main international reference standards for the environmental quality of buildings.

ES Los tratamientos superficiales se realizan mediante ciclos de pintado con bajo contenido de Compuestos Orgánicos Volátiles (COV), controlados mediante verificaciones periódicas de laboratorio. Esto permite limitar las emisiones durante la producción y obtener superficies estables a lo largo del tiempo, reduciendo la necesidad de intervenciones de restauración. Los procesos adoptados cumplen con los principales estándares internacionales de referencia para la calidad ambiental de los edificios.

FR Les traitements de surface sont réalisés selon des cycles de peinture à faible teneur en COV (Composés Organiques Volatils), contrôlés par des vérifications périodiques en laboratoire. Cela permet de limiter les émissions pendant la production et d'obtenir des surfaces stables dans le temps, réduisant la nécessité d'interventions de remise en état. Les procédés adoptés sont conformes aux principaux standards internationaux de référence en matière de qualité environnementale des bâtiments.



outdoorkitchens

ENERGIA E PRODUZIONE

Energy and production

Energía y producción

Énergie et production



IT La produzione delle cucine OF OutdoorKitchens avviene in stabilimenti alimentati in larga parte da energia fotovoltaica. L'impianto installato copre circa il 70% del fabbisogno energetico necessario alle lavorazioni, riducendo le emissioni associate alla realizzazione del prodotto. L'adozione di fonti rinnovabili si affianca alla durabilità dell'acciaio e alla possibilità di riciclo del materiale, contribuendo a contenere l'impatto ambientale lungo l'intero ciclo di vita della cucina.

EN OF OutdoorKitchens are manufactured in facilities largely powered by photovoltaic energy. The installed system covers around 70% of the energy required for production processes, reducing emissions associated with manufacturing. The use of renewable sources sits alongside the durability of stainless steel and its recyclability, helping to limit environmental impact across the kitchen's entire life cycle.

ES La producción de las cocinas OF OutdoorKitchens tiene lugar en instalaciones alimentadas en gran parte por energía fotovoltaica. El sistema instalado cubre aproximadamente el 70% de la demanda energética necesaria para los procesos de fabricación, reduciendo las emisiones asociadas a la realización del producto. La adopción de fuentes renovables se suma a la durabilidad del acero inoxidable y a la posibilidad de reciclar el material, contribuyendo a contener el impacto ambiental a lo largo de todo el ciclo de vida de la cocina.

FR La production des cuisines OF OutdoorKitchens est réalisée dans des sites en grande partie alimentés par l'énergie photovoltaïque. L'installation en place couvre environ 70% des besoins énergétiques nécessaires aux opérations de fabrication, réduisant les émissions associées à la production. Le recours aux énergies renouvelables s'ajoute à la durabilité de l'acier inoxydable et à sa recyclabilité, contribuant à limiter l'impact environnemental sur l'ensemble du cycle de vie de la cuisine.

IT Il produttore si riserva il diritto di apportare in qualsiasi momento modifiche tecniche ai prodotti senza obbligo di preavviso, nell'ottica del continuo miglioramento. La disponibilità degli articoli deve essere verificata al momento dell'ordine. A causa dei limiti dei processi di stampa e produzione, i colori riprodotti nel catalogo sono indicativi e possono differire dal prodotto reale; tali differenze non costituiscono difetto di conformità.

EN *The manufacturer reserves the right to make technical modifications to products at any time, without prior notice, as part of a policy of continuous improvement. Product availability must be confirmed at the time of order. Due to the limitations of printing and production processes, colours shown in this catalogue are indicative and may differ from the actual product; such differences do not constitute a lack of conformity.*

ES El fabricante se reserva el derecho de introducir en cualquier momento modificaciones técnicas en los productos sin obligación de previo aviso, en el marco de la mejora continua. La disponibilidad de los artículos deberá verificarse en el momento del pedido. Debido a las limitaciones de los procesos de impresión y producción, los colores reproducidos en el catálogo son orientativos y pueden diferir del producto real; dichas diferencias no constituyen un defecto de conformidad.

FR *Le fabricant se réserve le droit d'apporter à tout moment des modifications techniques aux produits, sans obligation de préavis, dans une logique d'amélioration continue. La disponibilité des articles doit être vérifiée au moment de la commande. En raison des limites liées aux procédés d'impression et de production, les couleurs reproduites dans ce catalogue sont indicatives et peuvent différer du produit réel; ces différences ne constituent pas un défaut de conformité.*

OF outdoorkitchens

via Del Progresso 1,
61036 Colli al Metauro (PU)
phone +39 0721 891907 | Fax. +39 0721.891907
info@ofoutdoorkitchens.com
www.ofoutdoorkitchens.com

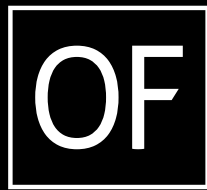

outdoorkitchens