

IDEAONE 2026

fami



.07



**Back from Tomorrow
Designed for Today**

MYTHOS

INNOVATION
SINCE 1929.



Good for you, better for the future.

LA SCELTA SOSTENIBILE

Per noi di Fami, essere e **fare azienda** non significa solo produrre e vendere. Significa abbracciare una **visione** più **ampia** e **profonda**, che pone al centro la nostra responsabilità verso il **pianeta** e le **generazioni future**.

Questa filosofia è racchiusa in un cerchio perfetto composto da tre principi, ognuno dei quali alimenta il successivo e trae beneficio dal precedente.

01.

CO₂ REDUCTION

Sostenibilità ed eco-efficienza sono il cuore del **nostro impegno** per un **futuro più verde**



Good for you,
better for
the future.

02.

DURABILITY

Produzione **100% made in Italy** e materiali di **alta qualità** garantiscono arredi robusti e resistenti che **durano nel tempo**

03.

REUSE

Ricerca e design rendono le nostre soluzioni **adattabili** a nuovi usi e contesti, **aumentandone la vita utile** e **riducendo gli sprechi**

CO₂ REDUCTION 01

Sostenibile dalla produzione alla consegna

L'impegno per **ridurre** le emissioni di **CO₂** ha innescato una rivoluzione nelle nostre **fasi produttive** e di **spedizione**.

- ✓ **Uso di energie rinnovabili e autoprodotte nella produzione**
- ✓ **Riutilizzo e riciclo degli scarti**
- ✓ **Adozione di materie prime rigenerate**
- ✓ **Prodotti smontati per ridurre il volume trasportato**
- ✓ **Packaging riciclabile e a ridotto contenuto di plastica**



DURABILITY 02

Lunga vita al tuo acquisto

Ogni nostro prodotto è frutto di un processo meticoloso di **ricerca, sviluppo**, produzione e test per offrire **soluzioni durevoli** nel tempo e **affidabili**.

- ✓ **Studio di materiali**
- ✓ **Sviluppo di soluzioni multifunzionali**
- ✓ **Controllo costante della qualità**
- ✓ **Test fisico-meccanici**



03

REUSE

Good for you,
better for
the future.

Nuova vita, nuove sfide

I nostri prodotti non sono mai fini a se stessi: fanno parte di un **innovativo ecosistema**, dove ogni componente può essere facilmente riutilizzato e integrato per trovare **nuova vita** in altre soluzioni.

- ✓ **Sistema di arredo interconnesso**
- ✓ **Adattabilità e versatilità per nuovi usi**
- ✓ **Componenti intercambiabili tra diverse soluzioni**
- ✓ **Ricambi di alta qualità**

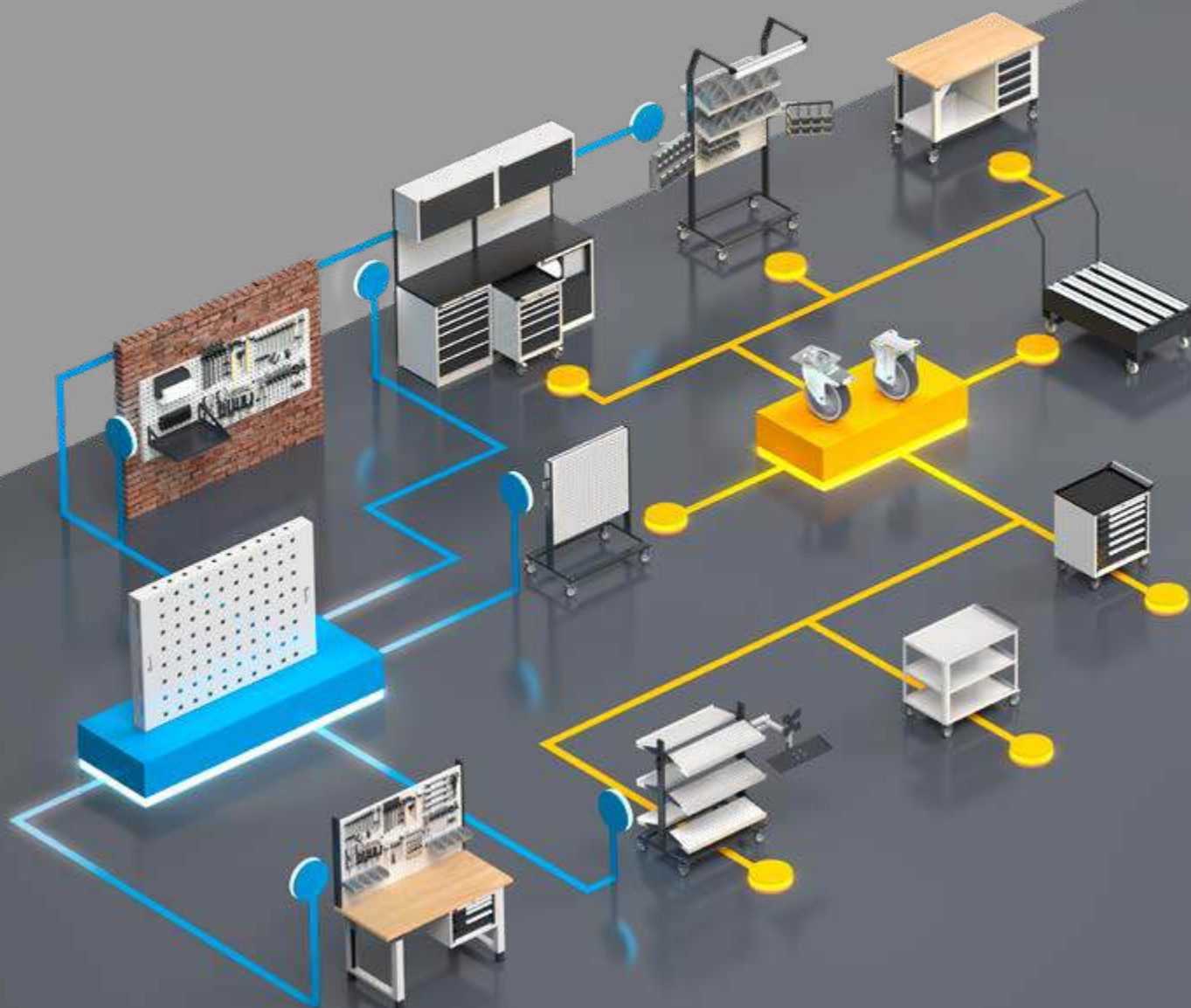



CONSULENZA

Un particolare progetto che vorresti realizzare, una nuova area da allestire? I consulenti commerciali di Fami sono al tuo fianco per analizzare tutte le tue necessità e realizzare gli arredi ideali per la tua azienda.



GARANZIA

I 10 anni di garanzia dei prodotti Fami sono la diretta espressione dell'utilizzo di materiali di qualità, della cura e dedizione nella produzione per rendere i nostri arredi affidabili e durevoli nel tempo.



ORDINI

Ordinare i prodotti Fami Ideaone non è mai stato così facile! Scegli i diversi arredi e contatta il tuo agente di zona o rivenditore per completare il tuo ordine. Oppure visita Fami Shop per acquistare in pochi click!



GAMMA COLORI

Gli arredi Fami Ideaone presentano colorazioni standard, sia monocolore che bicolore, che variano a seconda del prodotto scelto. Su richiesta sono disponibili ulteriori tonalità per personalizzare ogni area di lavoro o adattare gli arredi ai colori aziendali.



VALIDITÀ

Il catalogo Fami Ideaone ha validità dal 01/02/2026 al 31/01/2027. I prezzi si ritengono validi durante tale periodo, salvo possibili variazioni, errori tipografici e/o omissioni di stampa.



FILIALI E RIVENDITORI

Fami è sempre accanto a te! Negli anni abbiamo sviluppato quattro filiali europee oltre a un'ampia rete di rivenditori e distributori, sia in Italia che all'estero, per fornirti consulenza e assistenza ovunque tu sia.



ASSISTENZA

Per qualsiasi domanda, informazione o problema il nostro servizio di assistenza post-vendita è sempre a tua disposizione. In caso di prodotti danneggiati o rotti riceverai sempre dei ricambi originali Fami in sostituzione.



SPEDIZIONE

Gli arredi industriali Fami Ideaone sono disponibili con consegna entro 20 giorni lavorativi. La spedizione è gratuita per ordini superiori a 250,00 € (isole escluse), mentre per importi minori il costo di gestione ordine è pari a 30,00 €.



VASCHE DI RACCOLTA + RIPIANI E VASCHE PERFORM IN ACCIAIO

Idonee a liquidi infiammabili delle categorie GHS 1 - 3 e liquidi inquinanti per le acque delle categorie GHS 1 - 4. Non sono ammesse sostanze corrosive.

VASCHE DI RACCOLTA IN PE

Idonee a liquidi inquinanti per le acque delle categorie GHS 1 - 4. Non sono ammesse sostanze infiammabili.

CONSEGNE PORTO FRANCO in tutta Italia (isole escluse) per ordini a partire da 250 €. Per importi inferiori verrà applicato un contributo per costi di gestione di 30 €.

new

PICKING BOX MYTHOS vedi pag. 44



RK BOX AIR vedi pag. 22



new

ST vedi pag. 122



STEEL vedi pag. 92



PERFOM vedi pag. 485



MASTER

vedi pag. 369, 377, 400, 412, 417, 421



ECOLOGIA vedi pag. 492



WORK LOOK vedi pag. 281



vedi pag. 281



vedi pag. 328

BANCO DA IMBALLAGGIO vedi pag. 260



vedi pag. 327



vedi pag. 327



vedi pag. 327

IRON TEAM vedi pag. 326

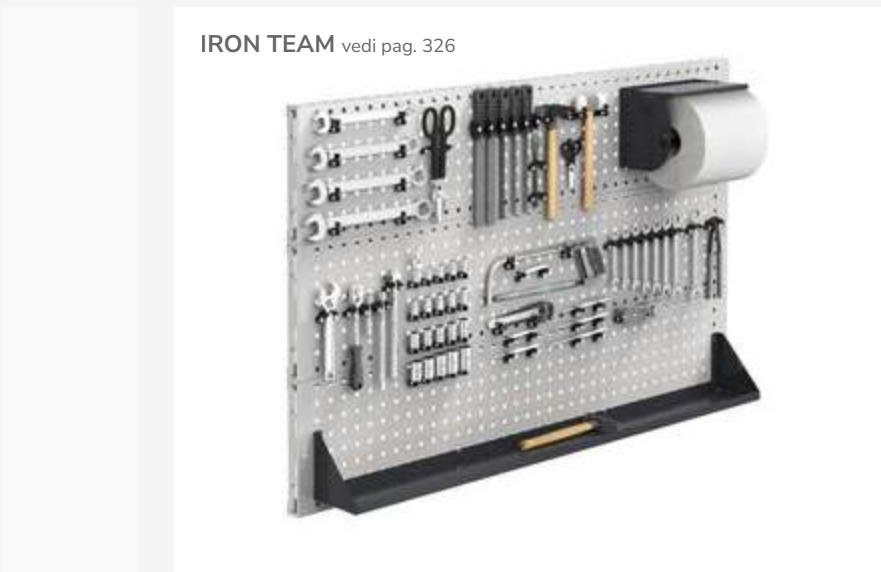

indice

STOCCAGGIO

AIR

12

PRO+

- **PICKING BOX AIR** **12**
 - contenitori 16
 - armadi FAK 18
 - componenti 20
- **RK BOX AIR** **22**
 - contenitori 26
 - accessori 29
 - scaffali monoblocco 30
 - componenti 32
 - scaffali con piani 36
 - armadi con porte a battente 40



CLASSIC

44

PRO

- **PICKING BOX MYTHOS** **44**
 - contenitori 48
 - accessori 50
- **RK BOX** **52**
 - contenitori
 - P= 300 mm 54
 - P= 400 mm 54
 - P= 500 mm 55
 - accessori 56
 - scaffali monoblocco
 - P= 300 mm 58
 - P= 400 mm 58
 - P= 500 mm 59
 - componenti 60
- **EURO BOX** **62**
 - coperchi 64
 - contenitori
 - 300x200 mm 64
 - 400x300 mm 65
 - 600x400 mm 67
 - 800x600 mm 70
 - cassette divisorio
 - 400x300 mm 70
 - 600x400 mm 71
 - accessori 72



- **EURO BOX ESD** **74**
 - contenitori
 - 400x300 mm 74
 - 600x400 mm 74
 - accessori 75
- **VISUAL BOX** **76**
 - cassettiere 78
 - componenti 79
 - scaffali
 - H= 500 mm 80
 - H= 1000 mm 81
 - H= 1500 mm 82
 - H= 2000 mm 83
 - scaffali con base
 - H= 1500 mm 84
 - H= 2000 mm 85
- **MAT** **86**
 - tappeti 87
 - componenti 87
- **CASSONI IN PLASTICA** **88**
 - contenitore ADR
 - 1040x640 mm 90
 - 1200x800 mm 91

STEEL

92

PRO+

- **STEEL** **92**
 - cassette forate 93
 - cassette 94
 - contenitori a bocca di lupo 96
 - contenitori fondo apribile 100
 - container a bocca di lupo 101

SCAFFALI

102

PRO



- **ST** **102**
 - scaffali con piani 106
 - componenti 107
 - scaffali portaminuterie 110
 - scaffali portapneumatici 112
 - scaffali a campata larga 113
 - scaffali con piani inclinati 114
 - scaffali Kanban 115
 - scaffali con contenitori 118

START



- **DOMINO** **130**
 - scaffali 131
 - componenti 133

BANCHI DA LAVORO

134

START



- **WORK** **134**
 - 1500x750 mm con ruote 138
 - 2000x750 mm con ruote 139
 - 1500x750 mm 140
 - 2000x750 mm 146
 - componenti 152
 - materiale di separazione 158

PRO



- **BR** **160**
 - 1500x750 mm 166
 - 2000x750 mm 170
 - componenti 174
 - materiale di separazione 182

PRO+



- **MASTER** **186**
 - 1500x750 mm 192
 - 2000x750 mm 206
 - 2500x750 mm 220
 - 3000x750 mm 232
 - componenti 247



- **DYNAMIC** **258**
 - preconfigurati 262
 - componenti 264

SISTEMI PORTA ATTREZZI

268

PRO



- **WORK LOOK** **268**
 - preconfigurati 270
 - componenti 272
 - preconfigurati con pensili 273
 - componenti 274
 - preconfigurati con tapparelle 275
 - componenti 276
 - pannelli forati da muro 282



- **COMPONENTS** **284**
 - tavolo pieghevole 284
 - morsetto 285
 - sedie 288



- **ERGO WORK POSTAZIONI MES** **290**
 - braccio con morsetto 291
 - montante verticale 291
 - componenti 294
 - carrello con braccio estensibile 296
 - braccio estensibile con porta tastiera 296
 - componenti 297



- **ERGO WORK BRACCI ESTENSIBILI** **298**
 - bracci per montanti 300
 - bracci per piano 303
 - componenti 306



- **TOOL ORGANIZER** **312**
 - Unipok 314
 - Pikpad 316
 - componenti 318
 - The Block 319

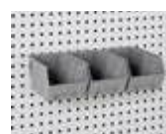

- **IRON TEAM** **320**
 - Iron Team 320
 - Iron Team Electric 328
 - Iron Team Light 330



CASSETTIERE

332

START

- FLEXA** **332**
 36x27 EH 717x600 mm 334
 materiale di separazione 335
 54x27 EH 1023x600 mm 336
 materiale di separazione 337



PRO

- MASTER DE** **338**
 36x36 EH 714x726 mm 342
 materiale di separazione 343
 54x36 EH 1020x726 mm 344
 materiale di separazione 345
 accessori 346



PRO+

- MASTER** **348**
 18x27 EH 408x573 mm 354
 materiale di separazione 356
 27x27 EH 561x573 mm 358
 materiale di separazione 362
 36x27 EH 714x573 mm 364
 materiale di separazione 372
 54x27 EH 1020x573 mm 374
 materiale di separazione 378
 27x36 EH 561x726 mm 380
 materiale di separazione 388
 36x36 EH 714x726 mm 390
 materiale di separazione 402
 45x36 EH 867x726 mm 404
 materiale di separazione 406
 54x36 EH 1020x726 mm 408
 materiale di separazione 414
 64x36 EH 1190x726 mm 416
 materiale di separazione 418
 78x36 EH 1428x726 mm 420
 materiale di separazione 422
 accessori 424



ARMADI PORTA COMPUTER

428

PRO+

- MASTER CS** **430**
 preconfigurati 430
 componenti 431



PRO

- STANDARD CS** **432**
 preconfigurati 432
 componenti 433



ARMADI CON PORTE

434

PRO

- PERFOM**
PORTE A BATTENTE **434**
 64x27 EH 1193x555x1000 mm 435
 64x27 EH 1193x555x2000 mm 436
 24x27 EH 512x555x1000 mm 437
 54x27 EH 1023x555x1000 mm 438
 54x27 EH 1023x555x2000 mm 440
 componenti 448
 materiale di separazione 460
- PERFOM**
PORTE SCORREVOLI **462**
 54x27 EH 1020x600x2000 mm 464
 54x27 EH 1020x600x915 mm 465
 78x27 EH 1428x600x2000 mm 466
 78x27 EH 1428x600x915 mm 467
 54+54x27 EH 2040x600x2000 mm 468
 54+54x27 EH 2040x600x915 mm 470
 componenti 471
 materiale di separazione 479



- PERFOM**
SPOGLIATOIO **480**
 preconfigurati 481
 panchine 485





NC

488

PRO

- **NC** **488**
preconfigurati 489
componenti 490

ECOLOGIA

492

PRO



- **BENNE** **493**
- **PORTA BIG BAG** **495**
- **CONTENITORE ADR** **495**
- **VASCHE DI RACCOLTA** **496**
- **ARMADI DI SICUREZZA** **503**

CARRELLI

506

PRO



- **CLEVER** **506**
Clever Small preconfigurati 507
Clever Large preconfigurati 508
componenti 514
- **COMBI** **517**
- **PRO+**
- **BIN CART** **518**
preconfigurati 519
componenti 532

ARREDO GARAGE

538

PRO



- **BEST SELLER** **546**
- **MODULI** **558**
L= 714 mm 558
L= 1020 mm 559
L= 1428 mm 560
L= 1734 mm 561
L= 2040 mm 562
corner 564
Flexa 564
- **PERFORM PORTE A BATTENTE** **565**
L= 512 mm 565
L= 1023 mm 565
- **PERFORM PORTE SCORREVOLI** **566**
L= 1020 mm 566
L= 1427 mm 566
L= 2040 mm 567
accessori 567
materiale di separazione 568

- **CONDIZIONI GENERALI DI GARANZIA** **574**

- **CONDIZIONI GENERALI DI VENDITA** **575**

CONTENITORI A BOCCA DI LUPO

SALVASPAZIO

PICKING BOX AIR



AIR

Air è la gamma di contenitori in plastica ideata da Fami. Funzionali e di design, questi contenitori sono studiati per ottimizzare gli spazi e l'organizzazione di postazioni di lavoro, magazzini e nel trasporto.

I contenitori **Picking Box Air** sono una soluzione **salvaspazio** per la custodia di componenti e C-Parts, caratterizzati da una particolare **struttura** ideata per poterli stoccare sia **sovrapposti** che **inseriti** l'uno dentro l'altro e per essere **compatibili** con contenitori a bocca di lupo di altri brand. Ogni elemento del contenitore ha una precisa funzione: le **nervature** laterali e il **fondo** rinforzato **irrobustiscono** la struttura e **distribuiscono** uniformemente il carico; gli **inserti brevettati** garantiscono una **sovrapposizione stabile** e sicura; l'ampia **apertura frontale** massimizza la **visibilità** del contenuto e l'**ergonomia** nel prelievo del materiale; il **gancio posteriore** consente il posizionamento di Picking Box Air su profili di carrelli Bin Cart e barre Iron Team.

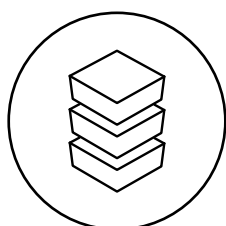

**SOVRAPPONIBILE
E COMPATIBILE**

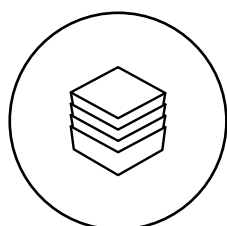

INSERIBILE

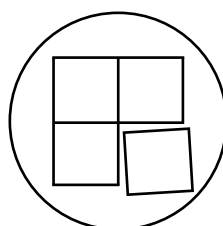

INTEGRABILE



ECOSOSTENIBILE



PICKING BOX AIR

I contenitori sono caratterizzati da:

1. Maniglia
2. Inserti per sovrapposizione
3. Rinforzo strutturale
4. Forma conica per agevolare l'inserimento dei contenitori uno dentro l'altro
5. Gancio posteriore per l'aggancio su barre (mis. 1, 2, 3A2, 3)
Maniglia posteriore per il trasporto (mis. 4, 4A5)

Disponibili in 5 colori:



SISTEMA DI SOVRAPPOSIZIONE BREVETTATO

Gli inserti brevettati garantiscono una sovrapposizione salda e sicura dei diversi Picking Box Air e distribuiscono uniformemente il peso.



SOVRAPPONIBILI E INSERIBILI

I contenitori Picking Box Air possono passare dalla sovrapposizione all'inserimento uno dentro l'altro con un semplice movimento della mano.

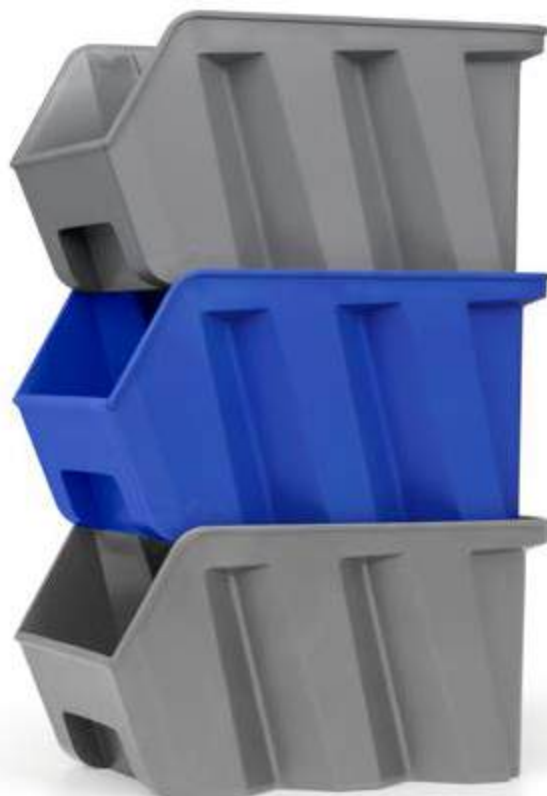

6 DIMENSIONI

Picking Box Air è disponibile in 6 misure con differenti capacità di stoccaggio.

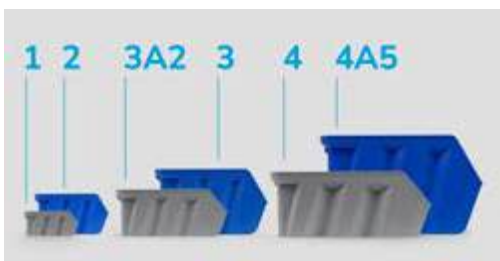

FONDO RINFORZATO

Il fondo è dotato di particolari nervature per aumentarne la robustezza e dissipare i pesi.

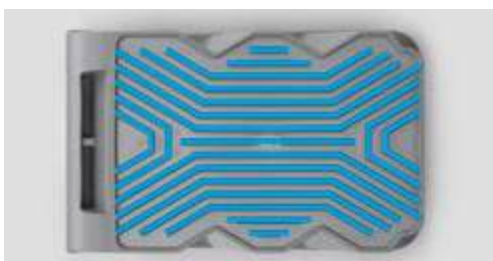

APERTURA FRONTALE

L'apertura frontale è più ampia ed ergonomica per aumentare la visibilità e facilitare il prelievo del contenuto in caso di sovrapposizione.



ETICHETTE

Le etichette adesive possono essere posizionate nello spazio frontale per facilitare la classificazione del contenuto.



COMPATIBILITÀ

La conformazione dei bordi superiori è ideata per garantire la sovrapposizione di contenitori di altri brand.



GANCIO POSTERIORE

I contenitori di mis. 1, 2, 3A2 e 3 sono dotati di un gancio posteriore che aumenta la stabilità del contenitore quando è installato sui profili dei carrelli Bin Cart o sulle barre Iron Team. I Picking Box Air di misura 4 e 4A5, invece, presentano una maniglia per agevolarne la movimentazione manuale.



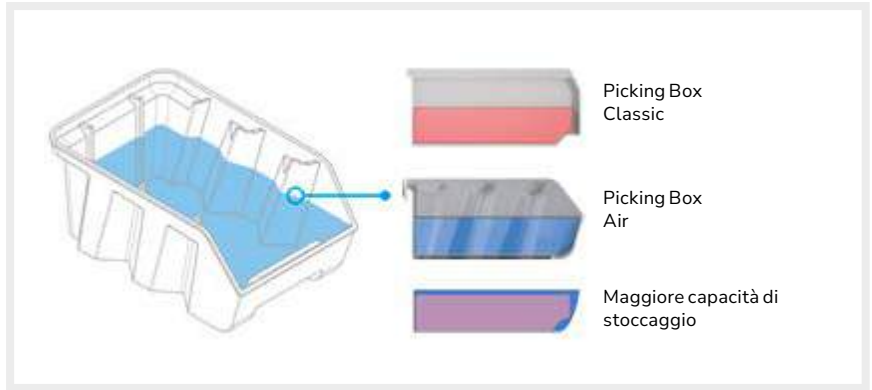
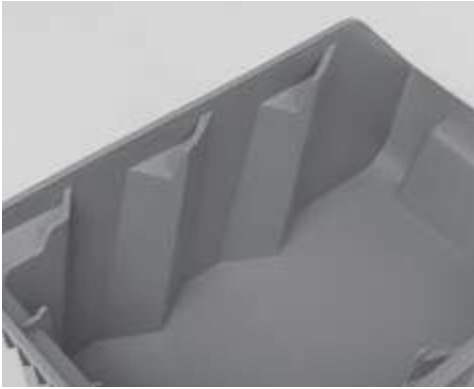

PIÙ SPAZIO ED ERGONOMIA

I contenitori Picking Box Air rappresentano l'evoluzione dei tradizionali contenitori a bocca di lupo presenti in commercio.

Rispetto ai Picking Box Classic, Air è caratterizzato da una maggiore apertura anteriore che rende più ergonomico il prelievo del materiale stoccato e migliora la visibilità.

La particolare conformazione delle pareti laterali dei Picking Box Air non ostacola la visione e non riduce lo spazio interno del contenitore. La capacità di stoccaggio della linea Air, infatti, è maggiore rispetto a quella della Classic: l'ingombro strutturale delle pareti è distribuito in modo tale da creare nuove aree che compensano ampiamente gli spazi occupati dalle nervature.



Confronto spazio interno di stoccaggio:

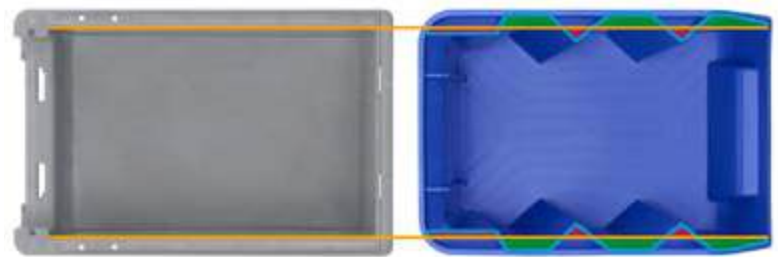

TRASPORTO OTTIMIZZATO ED EFFICIENTE



La gamma Picking Box Air consente un risparmio del 50% degli spazi in magazzino e nel trasporto. L'innestabilità e la compatibilità con gli Europallet dei contenitori, infatti, rendono le diverse operazioni interne e logistiche più efficienti e sempre più ottimizzate determinando una riduzione in termini di consumi aziendali e di impatto ambientale. In particolare, un'analisi ha rivelato come l'utilizzo dei Picking Box Air comporti una diminuzione dei consumi da costi di magazzinaggio (-57%) e da movimentazione interna (-27%), oltre ad una minor emissione di CO2 della catena logistica (-10 tonnellate)*.

** Analisi condotta simulando l'utilizzo di Picking Box Air per un anno nell'attività aziendale Fami. Il confronto è stato svolto comparando la totalità delle attività ed i relativi consumi del 2023 dei contenitori tradizionali Picking Box con la medesima quantità di attività ricalcolata sui consumi necessari a stoccaggio e movimentazione dei Picking Box Air.*

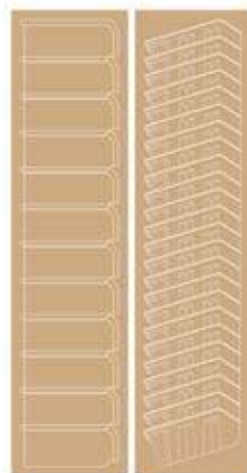

CONTENITORE CON FONDO RINFORZATO - DIM. INGOMBRO (mm): L=108 P=173 H=76



ART.	multiplo d'ordine	mis.	dim. utili			L	colore	€
			L mm	P mm	H mm			
FPB0001R051LQ	48	1	65	128	71	1		1,24
FPB0001R05132	48	1	65	128	71	1		1,24
FPB0001R0511Z	48	1	65	128	71	1		1,24
FPB0001R0512Y	48	1	65	128	71	1		1,24
FPB0001R0514Q	48	1	65	128	71	1		1,24

CONTENITORE CON FONDO RINFORZATO - DIM. INGOMBRO (mm): L=160 P=234 H=127



ART.	multiplo d'ordine	mis.	dim. utili			L	colore	€
			L mm	P mm	H mm			
FPB0002R051LQ	36	2	95	170	121	3,8		2,17
FPB0002R05132	36	2	95	170	121	3,8		2,17
FPB0002R0511Z	36	2	95	170	121	3,8		2,17
FPB0002R0512Y	36	2	95	170	121	3,8		2,17
FPB0002R0514Q	36	2	95	170	121	3,8		2,17

CONTENITORE CON FONDO RINFORZATO - DIM. INGOMBRO (mm): L=224 P=354 H=147



ART.	multiplo d'ordine	mis.	dim. utili			L	colore	€
			L mm	P mm	H mm			
FPB03A2R051LQ	16	3A2	157	278	140	9,4		5,58
FPB03A2R05132	16	3A2	157	278	140	9,4		5,58
FPB03A2R0511Z	16	3A2	157	278	140	9,4		5,58
FPB03A2R0512Y	16	3A2	157	278	140	9,4		5,58
FPB03A2R0514Q	16	3A2	157	278	140	9,4		5,58

CONTENITORE CON FONDO RINFORZATO - DIM. INGOMBRO (mm): L=224 P=354 H=203



ART.	multiplo d'ordine	mis.	dim. utili			L	colore	€
			L mm	P mm	H mm			
FPB0003R051LQ	12	3	154	263	195	12,5		5,89
FPB0003R05132	12	3	154	263	195	12,5		5,89
FPB0003R0511Z	12	3	154	263	195	12,5		5,89
FPB0003R0512Y	12	3	154	263	195	12,5		5,89
FPB0003R0514Q	12	3	154	263	195	12,5		5,89

CONTENITORE CON FONDO RINFORZATO - DIM. INGOMBRO (mm): L=336 P=508 H=203

4

ART.	multiplo d'ordine	mis.	dim. utili			L	colore	€
			L mm	P mm	H mm			
FPB0004R051LQ	12	4	228	402	196	28	■	11,78
FPB0004R05132	12	4	228	402	196	28	■	11,78
FPB0004R0511Z	12	4	228	402	196	28	■	11,78
FPB0004R0512Y	12	4	228	402	196	28	■	11,78
FPB0004R0514Q	12	4	228	402	196	28	■	11,78

CONTENITORE CON FONDO RINFORZATO - DIM. INGOMBRO (mm): L=336 P=508 H=304

4A5

ART.	multiplo d'ordine	mis.	dim. utili			L	colore	€
			L mm	P mm	H mm			
FPB04A5R051LQ	9	4A5	238	381	298	42	■	14,26
FPB04A5R05132	9	4A5	238	381	298	42	■	14,26
FPB04A5R0511Z	9	4A5	238	381	298	42	■	14,26
FPB04A5R0512Y	9	4A5	238	381	298	42	■	14,26
FPB04A5R0514Q	9	4A5	238	381	298	42	■	14,26



ARMADI CON PORTE A BATTENTE



ARMADIO CON PORTE A BATTENTE CON 24 CONTENITORI PICKING BOX AIR

ART.	L mm	P mm	H mm	KG	colore contenitori	RAL	€
PERFOMAK03	700	267	1001	450		7035+7016	373,55
PERFOMAK04	700	267	1001	450		7035	373,55
PERFOMAK05	700	267	1001	450		5012	373,55

Composto da:

qtà	descrizione
1	Armadio con porte a battente
1	Kit 5 piani regolabili
8	Kit 3 contenitori Picking Box Air mis. 2



ARMADIO CON PORTE A BATTENTE CON 48 CONTENITORI PICKING BOX AIR

ART.	L mm	P mm	H mm	KG	colore contenitori	RAL	€
PERFOMAK08	700	267	1651	500		7035+7016	464,38
PERFOMAK09	700	267	1651	500		7035	464,38
PERFOMAK10	700	267	1651	500		5012	464,38

Composto da:

qtà	descrizione
1	Armadio con porte a battente
2	Kit 5 piani regolabili
36	Contenitore in polipropilene Picking Box Air mis. 2
3	Kit 4 contenitori Picking Box Air mis. 1
2	Fermo per contenitori mis. 1



ARMADIO CON PORTE A BATTENTE CON 72 CONTENITORI PICKING BOX AIR

ART.	L mm	P mm	H mm	KG	colore contenitori	RAL	€
PERFOMAK13	700	267	1996	500		7035+7016	563,27
PERFOMAK14	700	267	1996	500		7035	563,27
PERFOMAK15	700	267	1996	500		5012	563,27

Composto da:

qtà	descrizione
1	Armadio con porte a battente
1	Kit 5 piani regolabili
3	Kit 3 piani regolabili
36	Contenitore in polipropilene Picking Box Air mis. 2
9	Kit 4 contenitori Picking Box Air mis. 1
6	Fermo per contenitori mis. 1

ARMADI SENZA PORTE A BATTENTE



ARMADIO CON 24 CONTENITORI PICKING BOX AIR

ART.	L mm	P mm	H mm	KG	colore contenitori	RAL	€
PERFOMAK01	700	267	1001	450		7035	274,97
PERFOMAK02	700	267	1001	450		5012	274,97

Composto da:

qtà	descrizione
1	Armadio senza porte a battente
1	Kit 5 piani regolabili
8	Kit 3 contenitori Picking Box Air mis. 2



ARMADIO CON 48 CONTENITORI PICKING BOX AIR

ART.	L mm	P mm	H mm	KG	colore contenitori	RAL	€
PERFOMAK06	700	267	1651	500		7035	352,16
PERFOMAK07	700	267	1651	500		5012	352,16

Composto da:

qtà	descrizione
1	Armadio senza porte a battente
2	Kit 5 piani regolabili
36	Contenitore in polipropilene Picking Box Air mis. 2
3	Kit 4 contenitori Picking Box Air mis. 1
2	Fermo per contenitori mis. 1



ARMADIO CON 72 CONTENITORI PICKING BOX AIR

ART.	L mm	P mm	H mm	KG	colore contenitori	RAL	€
PERFOMAK11	700	267	1996	500		7035	441,75
PERFOMAK12	700	267	1996	500		5012	441,75

Composto da:

qtà	descrizione
1	Armadio senza porte a battente
1	Kit 5 piani regolabili
3	Kit 3 piani regolabili
36	Contenitore in polipropilene Picking Box Air mis. 2
9	Kit 4 contenitori Picking Box Air mis. 1
6	Fermo per contenitori mis. 1



PORTATA



RAL 7035 + RAL 7016



RAL 5012





RAL 7035

COMPONENTI



ARMADIO CON PORTE A BATTENTE

ART.	L mm	P mm	H mm	KG	RAL	€
 FAK1040C000PD	700	267	1001	450	7035+7016	260,40
 FAK1040C00008	700	267	1001	450	7035	260,40
 FAK1040C00004	700	267	1001	450	5012	260,40



ARMADIO CON PORTE A BATTENTE

ART.	L mm	P mm	H mm	KG	RAL	€
 FAK1066C000PD	700	267	1651	500	7035+7016	283,65
 FAK1066C00008	700	267	1651	500	7035	283,65
 FAK1066C00004	700	267	1651	500	5012	283,65





ARMADIO CON PORTE A BATTENTE

ART.	L mm	P mm	H mm	KG	RAL	€
 FAK1080C000PD	700	267	1996	500	7035+7016	309,07
 FAK1080C00008	700	267	1996	500	7035	309,07
 FAK1080C00004	700	267	1996	500	5012	309,07





COMPONENTI



ARMADIO SENZA PORTE A BATTENTE

ART.	L mm	P mm	H mm	H utile mm	 KG	RAL	€
 FAK2040X00008	700	267	1001	934	450	7035	161,82
 FAK2040X00004	700	267	1001	934	450	5012	161,82





ARMADIO SENZA PORTE A BATTENTE

ART.	L mm	P mm	H mm	H utile mm	 KG	RAL	€
 FAK2066X00008	700	267	1651	1584	500	7035	171,43
 FAK2066X00004	700	267	1651	1584	500	5012	171,43



ARMADIO SENZA PORTE A BATTENTE

ART.	L mm	P mm	H mm	H utile mm	 KG	RAL	€
 FAK2080X00008	700	267	1996	1929	500	7035	187,55
 FAK2080X00004	700	267	1996	1929	500	5012	187,55

KIT PIANI REGOLABILI

ART.	L mm	P mm	H mm	n. piani	 KG	finitura	€
 FAK9020S299	675	235	17	3	50	Zincato	24,80
 FAK9020S199	675	235	17	5	50	Zincato	41,23

FERMO PER CONTENITORI MIS. 1

ART.	L mm	P mm	H mm	finitura	€
 FAK90400099	671	31	11	Zincato	1,24



PORTATA



RAL 7035 + RAL 7016



RAL 5012



RAL 7035



ZINCATO

CONTENITORI PER SCAFFALI SALVASPAZIO

RK BOX AIR

**AIR**

Air è la gamma di contenitori in plastica ideata da Fami. Funzionali e di design, questi contenitori sono studiati per ottimizzare gli spazi e l'organizzazione di postazioni di lavoro, magazzini e nel trasporto.

I contenitori per scaffali RK Box Air sono delle innovative soluzioni per la **custodia** e lo **stoccaggio** di una vasta gamma di componenti. Il particolare design è stato progettato per poter **sovrapporre** in totale sicurezza i diversi contenitori e per poterli **inserire uno dentro l'altro**, comportando un notevole **risparmio di spazio**. L'ampia apertura frontale facilita il prelievo del materiale, mentre il **fondo rinforzato** evita la deformazione del contenitore e consente lo stoccaggio di materiale pesante.

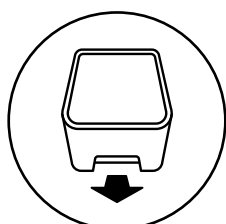

ESTRAIBILE

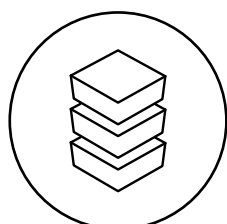

SOVRAPPONIBILE

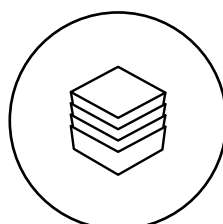

INSERIBILE

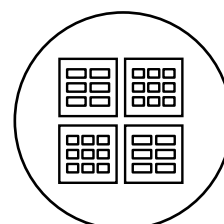

MODULARE



RK BOX AIR

I contenitori per scaffali sono caratterizzati da:

1. Bordi rinforzati
2. Maniglia
3. Inserti per sovrapposizione
4. Forma conica per agevolare l'inserimento dei contenitori uno dentro l'altro
5. Rinforzo strutturale per l'installazione dei divisori trasversali
6. Gancio per coperchio
7. Predisposizione per frontalino

SISTEMA DI SOVRAPPOSIZIONE BREVETTATO

Gli inserti brevettati garantiscono una sovrapposizione salda e sicura dei diversi RK Box Air e distribuiscono uniformemente il peso.



SOVRAPPONIBILI E INSERIBILI

I contenitori RK Box Air possono passare dalla sovrapposizione all'inserimento uno dentro l'altro con un semplice movimento della mano.



BORDI E FONDO RINFORZATI

Bordi e fondo rinforzati evitano la deformazione e irrobustiscono la struttura degli RK Box Air per il contenimento di carichi pesanti.



12 DIMENSIONI

I contenitori sono disponibili in tre profondità, ciascuna delle quali è offerta in due differenti altezze e due larghezze.



ETICHETTE

Le etichette adesive possono essere posizionate nello spazio frontale per facilitare la classificazione del contenuto.



ACCESSORI

RK Box Air può essere completato con una vasta gamma di accessori come frontalini, coperchi e divisori trasversali.

VISIBILITÀ MASSIMA

Gli accessori per la suddivisione e la protezione del contenuto sono realizzati in polistirolo trasparente per garantire la massima visibilità e l'immediata identificazione dei materiali stoccati.

FRONTALINO

Il frontalino trasparente chiude l'apertura frontale degli RK Box Air senza impedire la visione del contenuto. Il particolare design si adatta perfettamente alla forma del contenitore, inserendosi con un clic. Può essere utilizzato in combinazione con il coperchio per chiudere completamente il contenitore.



DIVISORIO

Il divisorio trasversale suddivide lo spazio interno degli RK Box Air in più scomparti per lo stoccaggio di componenti di natura diversa. È trasparente per consentire la visione di tutto il materiale e si incastra perfettamente nei rinforzi laterali senza occupare spazio.



COPERCHIO

Il coperchio per RK Box Air è installato ad incastro sulla parte superiore del contenitore e presenta un'apertura parziale o totale. La trasparenza rende sempre visibile il materiale stoccato e può essere utilizzato in combinazione con il frontalino per la protezione completa del contenuto degli RK Box Air.





La struttura modulare consente di impilare scaffali con la medesima profondità o con profondità decrescente.

Ogni scaffale, infatti, presenta delle alette nella parte superiore per sovrapporre in modo stabile e sicuro i diversi moduli.

SCAFFALE MONOBLOCCO FORNITO MONTATO

P= 300 mm



CONTENITORE CON FONDO RINFORZATO - DIM. INGOMBRO (mm): L=141 P=305 H=91

ART.	multiplo d'ordine	mis.	dim. utili			L	colore	€
			L mm	P mm	H mm			
FRK3014R05132	20	3014	102	248	79	2,4		4,03



CONTENITORE CON FONDO RINFORZATO - DIM. INGOMBRO (mm): L=214 P=305 H=91

ART.	multiplo d'ordine	mis.	dim. utili			L	colore	€
			L mm	P mm	H mm			
FRK3021R05132	20	3021	176	245	79	4		4,96



CONTENITORE CON FONDO RINFORZATO - DIM. INGOMBRO (mm): L=141 P=305 H=142

ART.	multiplo d'ordine	mis.	dim. utili			L	colore	€
			L mm	P mm	H mm			
FRK3114R05132	16	3114	100	234	130	3,8		4,34



CONTENITORE CON FONDO RINFORZATO - DIM. INGOMBRO (mm): L=214 P=305 H=142

ART.	multiplo d'ordine	mis.	dim. utili			L	colore	€
			L mm	P mm	H mm			
FRK3121R05132	16	3121	174	234	130	6,5		5,89



P= 400 mm



CONTENITORE CON FONDO RINFORZATO - DIM. INGOMBRO (mm): L=141 P=400 H=91

ART.	multiplo d'ordine	mis.	dim. utili			L	colore	€
			L mm	P mm	H mm			
FRK4014R05132	20	4014	102	348	79	3,4		5,27



CONTENITORE CON FONDO RINFORZATO - DIM. INGOMBRO (mm): L=214 P=400 H=91

ART.	multiplo d'ordine	mis.	dim. utili			L	colore	€
			L mm	P mm	H mm			
FRK4021R05132	20	4021	176	345	79	5,8		5,89



CONTENITORE CON FONDO RINFORZATO - DIM. INGOMBRO (mm): L=141 P=400 H=142

ART.	multiplo d'ordine	mis.	dim. utili			L	colore	€
			L mm	P mm	H mm			
FRK4114R05132	16	4114	100	334	130	5,2		5,89



CONTENITORE CON FONDO RINFORZATO - DIM. INGOMBRO (mm): L=214 P=400 H=142

ART.	multiplo d'ordine	mis.	dim. utili			L	colore	€
			L mm	P mm	H mm			
FRK4121R05132	16	4121	174	334	130	9,1		6,82



P= 500 mm



CONTENITORE CON FONDO RINFORZATO - DIM. INGOMBRO (mm): L=141 P=495 H=91

ART.	multiplo d'ordine	mis.	dim. utili			L	colore	€
			L mm	P mm	H mm			
FRK5014R05132	20	5014	102	448	79	4,3		5,89



CONTENITORE CON FONDO RINFORZATO - DIM. INGOMBRO (mm): L=214 P=495 H=91

ART.	multiplo d'ordine	mis.	dim. utili			L	colore	€
			L mm	P mm	H mm			
FRK5021R05132	20	5021	176	445	79	7,4		6,82



CONTENITORE CON FONDO RINFORZATO - DIM. INGOMBRO (mm): L=141 P=495 H=142

ART.	multiplo d'ordine	mis.	dim. utili			L	colore	€
			L mm	P mm	H mm			
FRK5114R05132	16	5114	100	434	130	6,8		6,20





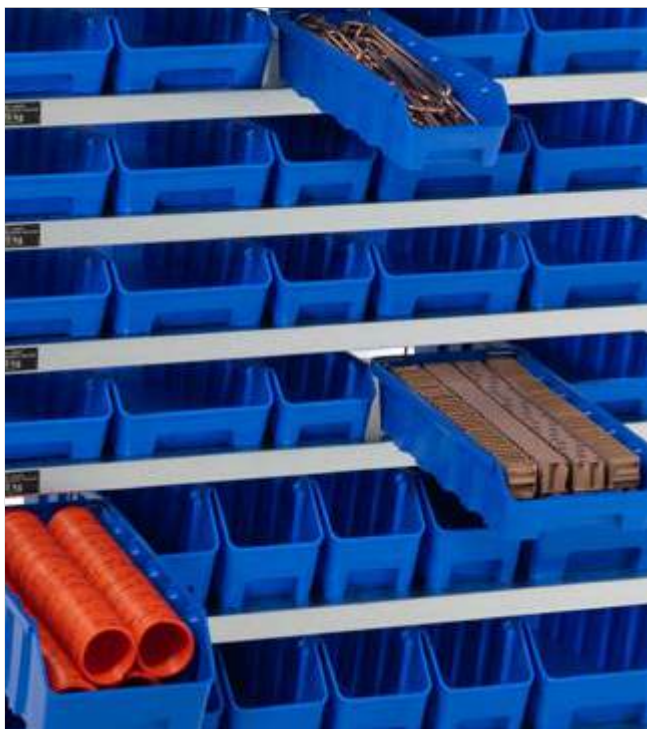

CONTENITORE CON FONDO RINFORZATO - DIM. INGOMBRO (mm): L=214 P=495 H=142

ART.	multiplo d'ordine	mis.	dim. utili			L	colore	€
			L mm	P mm	H mm			
FRK5121R05132	16	5121	174	434	130	12		7,75



ACCESSORI

DIVISORIO TRASVERSALE PER CONTENITORE RK BOX AIR





ART.	multiplo d'ordine	adatto per	€
 FRKD014T00096	20	FRK3014R051-FRK4014R051-FRK5014R051	1,86
 FRKD021T00096	20	FRK3021R051-FRK4021R051-FRK5021R051	2,79
 FRKD114T00096	16	FRK3114R051-FRK4114R051-FRK5114R051	2,17
 FRKD121T00096	16	FRK3121R051-FRK4121R051-FRK5121R051	3,10



Il divisorio trasversale si inserisce perfettamente nei rinforzi del contenitore per creare più aree di stoccaggio senza occupare spazio.



FRONTALINO PER CONTENITORE RK BOX AIR

ART.	multiplo d'ordine	adatto per	€
 FRKF014000096	20	FRK3014R051-FRK4014R051-FRK5014R051	2,17
 FRKF021000096	20	FRK3021R051-FRK4021R051-FRK5021R051	2,48
 FRKF114000096	16	FRK3114R051-FRK4114R051-FRK5114R051	2,79
 FRKF121000096	16	FRK3121R051-FRK4121R051-FRK5121R051	3,10



Il frontalino è sagomato per adattarsi alla forma della parte frontale del contenitore.



COPERCHIO PER CONTENITORE RK BOX AIR



ART.	multiplo d'ordine	adatto per	€
 FRK3C14000096	20	FRK3014R051-FRK3114R051	5,27
 FRK3C21000096	20	FRK3021R051-FRK3121R051	7,13



Il coperchio si installa ad incastro sui bordi superiori del contenitore e ha un'apertura parziale o totale.



FERMO POSTERIORE PER CONTENITORE RK BOX AIR

ART.	multiplo d'ordine	per contenitore L mm	finitura	€
 FRKS014000099	20	141	Zincato	1,24
 FRKS021000099	20	214	Zincato	1,24



Il fermo si applica nella parte posteriore del contenitore sfruttando i due fori presenti sul bordo.



CAPACITÀ



ZINCATO

P= 300 mm



SCAFFALE CON 12 CONTENITORI RK BOX AIR

ART.	L mm	P mm	H mm	contenitori			RAL	€
						colore		
RKBOX3070	500	300	545	4 - 7	2,4 - 4		7000	167,40

Composto da:

qtà	descrizione
1	Scaffale a 3 piani
2	Kit 4 contenitori RK Box Air 3014
1	Kit 4 contenitori RK Box Air 3021
2	Kit 4 fermi posteriori per contenitore RK Box Air
1	Kit 4 fermi posteriori per contenitore RK Box Air

SCAFFALE MONOBLOCCO FORNITO MONTATO CON CONTENITORI

P= 400 mm



SCAFFALE CON 12 CONTENITORI RK BOX AIR

ART.	L mm	P mm	H mm	contenitori			RAL	€
						colore		
RKBOX4070	500	400	545	6 - 10	3,4 - 5,8		7000	187,86

Composto da:

qtà	descrizione
1	Scaffale a 3 piani
2	Kit 4 contenitori RK Box Air 4014
1	Kit 4 contenitori RK Box Air 4021
2	Kit 4 fermi posteriori per contenitore RK Box Air
1	Kit 4 fermi posteriori per contenitore RK Box Air

SCAFFALE MONOBLOCCO FORNITO MONTATO CON CONTENITORI

P= 500 mm



SCAFFALE CON 12 CONTENITORI RK BOX AIR

ART.	L mm	P mm	H mm	contenitori			RAL	€
						colore		
RKBOX5070	500	500	545	7 - 13	4,3 - 7,4		7000	205,84

Composto da:

qtà	descrizione
1	Scaffale a 3 piani
2	Kit 4 contenitori RK Box Air 5014
1	Kit 4 contenitori RK Box Air 5021
2	Kit 4 fermi posteriori per contenitore RK Box Air
1	Kit 4 fermi posteriori per contenitore RK Box Air

SCAFFALE MONOBLOCCO FORNITO MONTATO CON CONTENITORI



Di serie tutti gli scaffali per RK Box Air presentano un fermo antibaltamento. Possono essere aggiunti divisori e frontalini per una migliore gestione e protezione del materiale stoccato.



vedi pag. 29

P= 300 mm



SCAFFALE CON 12 CONTENITORI RK BOX AIR CON DIVISORI E FRONTALINI

ART.	L mm	P mm	H mm	contenitori			RAL	€
				KG	L	colore		
RKBOX3071	500	300	545	4 - 7	2,4 - 4		7000	214,83

Composto da:

qtà	descrizione
1	Scaffale a 3 piani
2	Kit 4 contenitori RK Box Air 3014
1	Kit 4 contenitori RK Box Air 3021
2	Kit 4 fermi posteriori per contenitore RK Box Air
1	Kit 4 fermi posteriori per contenitore RK Box Air
2	Kit 4 frontalini per contenitore RK Box Air
1	Kit 4 frontalini per contenitore RK Box Air
2	Kit 4 divisori trasversali per contenitore RK Box Air
1	Kit 4 divisori trasversali per contenitore RK Box Air

SCAFFALE MONOBLOCCO FORNITO MONTATO CON CONTENITORI

P= 400 mm



SCAFFALE CON 12 CONTENITORI RK BOX AIR CON DIVISORI E FRONTALINI

ART.	L mm	P mm	H mm	contenitori			RAL	€
				KG	L	colore		
RKBOX4071	500	400	545	6 - 10	3,4 - 5,8		7000	235,29

Composto da:

qtà	descrizione
1	Scaffale a 3 piani
2	Kit 4 contenitori RK Box Air 4014
1	Kit 4 contenitori RK Box Air 4021
2	Kit 4 fermi posteriori per contenitore RK Box Air
1	Kit 4 fermi posteriori per contenitore RK Box Air
2	Kit 4 frontalini per contenitore RK Box Air
1	Kit 4 frontalini per contenitore RK Box Air
2	Kit 4 divisori trasversali per contenitore RK Box Air
1	Kit 4 divisori trasversali per contenitore RK Box Air

SCAFFALE MONOBLOCCO FORNITO MONTATO CON CONTENITORI

P= 500 mm



SCAFFALE CON 12 CONTENITORI RK BOX AIR CON DIVISORI E FRONTALINI

ART.	L mm	P mm	H mm	contenitori			RAL	€
				KG	L	colore		
RKBOX5071	500	500	545	7 - 13	4,3 - 7,4		7000	253,27

Composto da:

qtà	descrizione
1	Scaffale a 3 piani
2	Kit 4 contenitori RK Box Air 5014
1	Kit 4 contenitori RK Box Air 5021
2	Kit 4 fermi posteriori per contenitore RK Box Air
1	Kit 4 fermi posteriori per contenitore RK Box Air
2	Kit 4 frontalini per contenitore RK Box Air
1	Kit 4 frontalini per contenitore RK Box Air
2	Kit 4 divisori trasversali per contenitore RK Box Air
1	Kit 4 divisori trasversali per contenitore RK Box Air

SCAFFALE MONOBLOCCO FORNITO MONTATO CON CONTENITORI

COMPONENTI PER SCAFFALI PER RK BOX AIR



SCAFFALE VUOTO

ART.	L mm	P mm	H mm	n. ripiani	RAL	€
FRKBX30S30001	500	300	545	3	7000	97,03
FRKBX40S30001	500	400	545	3	7000	110,36
FRKBX50S30001	500	500	545	3	7000	119,66



KIT 4 CONTENITORI RK BOX AIR 3014

ART.	L mm	P mm	H mm	colore	€
FRKBX30KB0A32	141	300	91		16,43



KIT 4 CONTENITORI RK BOX AIR 3021

ART.	L mm	P mm	H mm	colore	€
FRKBX30KB0B32	214	300	91		20,77



KIT 4 CONTENITORI RK BOX AIR 4014

ART.	L mm	P mm	H mm	colore	€
FRKBX40KB0A32	141	400	91		18,91



KIT 4 CONTENITORI RK BOX AIR 4021

ART.	L mm	P mm	H mm	colore	€
FRKBX40KB0B32	214	400	91		22,94



KIT 4 CONTENITORI RK BOX AIR 5014

ART.	L mm	P mm	H mm	colore	€
FRKBX50KB0A32	141	500	91		22,32



KIT 4 CONTENITORI RK BOX AIR 5021

ART.	L mm	P mm	H mm	colore	€
FRKBX50KB0B32	214	500	91		24,80

ZOCOLO PER SCAFFALE



ART.	L mm	P mm	H mm	adatto per scaffale P mm	RAL	€
FRKBX30Z00101	488	278	110	300	7000	38,44
FRKBX40Z00101	488	378	110	400	7000	39,37
FRKBX50Z00101	488	478	110	500	7000	40,30



COMPONENTI PER SCAFFALI PER RK BOX AIR



KIT 4 FERMI POSTERIORI PER CONTENITORE RK BOX AIR

ART.	per contenitore L mm	finitura	€
 FRKBX00KS0A99	141	Zincato	5,58



KIT 4 FERMI POSTERIORI PER CONTENITORE RK BOX AIR

ART.	per contenitore L mm	finitura	€
 FRKBX00KS0B99	214	Zincato	5,58



KIT 4 DIVISORI TRASVERSALI PER CONTENITORE RK BOX AIR

ART.	adatto per	€
 FRKBX00KD0A96	FRK3014R051 FRK4014R051 FRK5014R051	6,82



KIT 4 DIVISORI TRASVERSALI PER CONTENITORE RK BOX AIR

ART.	adatto per	€
 FRKBX00KD0B96	FRK3021R051 FRK4021R051 FRK5021R051	8,68



KIT 4 FRONTALINI PER CONTENITORE RK BOX AIR

ART.	adatto per	€
 FRKBX00KF0A96	FRK3014R051 FRK4014R051 FRK5014R051	8,06



KIT 4 FRONTALINI PER CONTENITORE RK BOX AIR

ART.	adatto per	€
 FRKBX00KF0B96	FRK3021R051 FRK4021R051 FRK5021R051	8,99

Schema disposizione contenitori **RK Box Air** su scaffale **ST** e armadio con porte a battente **Perform**

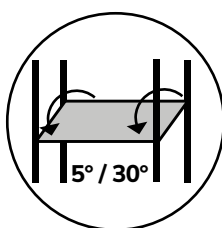
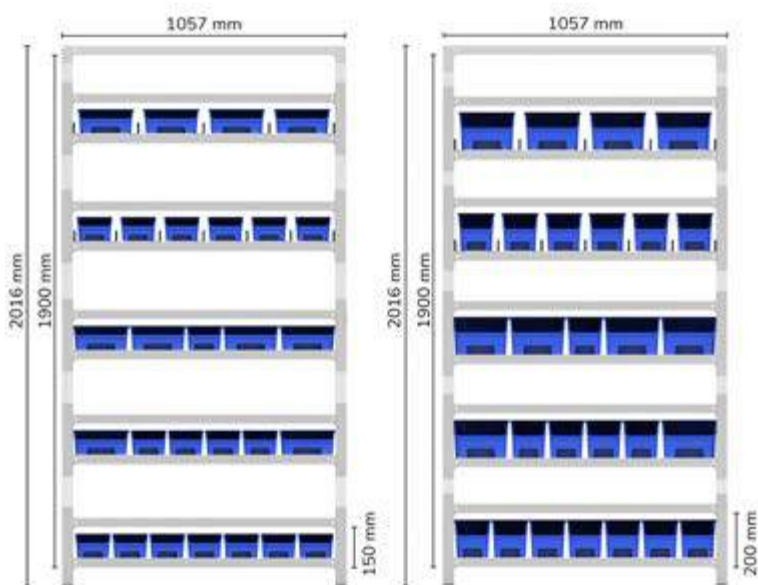

[CONFIGURE](#)

SCAFFALE CON 7 PIANI INCLINATI

ART.	Lmm	Pmm	Hmm	n. kit 4 separatori	finitura	€
ST1036	1057	521	2016	10	Zincato	673,01
ST1037	1057	621	2016	10	Zincato	762,91
ST1038	1057	821	2016	10	Zincato	825,53

Completo di bordi fermacasse e coppia staffe per piani inclinati 5°/30°

Piani con profondità 500 mm portata 120 kg. Piani con profondità 600 e 800 mm portata 300 kg.





SCAFFALI CON PIANI PER RK BOX AIR



SCAFFALE CON 11 PIANI E 68 CONTENITORI RK BOX AIR



ART.	L mm	P mm	H mm	finitura	€
ST1069	1057	521	2011	Zincato	837,31

Composto da:

qtà	descrizione
2	Kit 2 montanti
4	Kit 2 piedini in polipropilene
2	Kit 3 traversini
2	Crociera di irrigidimento
2	Kit 5 piani fessurati
1	Piano fessurato
2	Kit 4 contenitori RK Box Air 5014
1	Kit 4 contenitori RK Box Air 5021
48	Contenitore in polipropilene RK Box Air 5114
2	Kit 4 contenitori RK Box Air 5114
60	Fermo posteriore per contenitore RK Box Air
1	Kit 4 fermi posteriori per contenitore RK Box Air
1	Kit 4 fermi posteriori per contenitore RK Box Air



SCAFFALE CON 11 PIANI E 60 CONTENITORI RK BOX AIR



ART.	L mm	P mm	H mm	finitura	€
ST1070	1057	521	2011	Zincato	798,25

Composto da:

qtà	descrizione
2	Kit 2 montanti
4	Kit 2 piedini in polipropilene
2	Kit 3 traversini
2	Crociera di irrigidimento
2	Kit 5 piani fessurati
1	Piano fessurato
2	Kit 4 contenitori RK Box Air 5014
1	Kit 4 contenitori RK Box Air 5021
32	Contenitore in polipropilene RK Box Air 5114
16	Contenitore in polipropilene RK Box Air 5121
40	Fermo posteriore per contenitore RK Box Air
20	Fermo posteriore per contenitore RK Box Air



SCAFFALE CON 11 PIANI E 52 CONTENITORI RK BOX AIR



ART.	L mm	P mm	H mm	finitura	€
ST1071	1057	521	2011	Zincato	776,55

Composto da:

qtà	descrizione
2	Kit 2 montanti
4	Kit 2 piedini in polipropilene
2	Kit 3 traversini
2	Crociera di irrigidimento
2	Kit 5 piani fessurati
1	Piano fessurato
2	Kit 4 contenitori RK Box Air 5014
1	Kit 4 contenitori RK Box Air 5021
2	Kit 4 contenitori RK Box Air 5114
32	Contenitore in polipropilene RK Box Air 5121
20	Fermo posteriore per contenitore RK Box Air
40	Fermo posteriore per contenitore RK Box Air

SCAFFALI CON PIANI PER RK BOX AIR



SCAFFALE CON 11 PIANI E 60 CONTENITORI RK BOX AIR CON DIVISORI E FRONTALINI

ART.	L mm	P mm	H mm	finitura	€
 ST1072	1057	521	2011	Zincato	1254,88

Composto da:

qtà	descrizione	qtà	descrizione
2	Kit 2 montanti	40	Fermo posteriore per contenitore RK Box Air
4	Kit 2 piedini in polipropilene	20	Fermo posteriore per contenitore RK Box Air
2	Kit 3 traversini	2	Kit 4 frontalini per contenitore RK Box Air
2	Crociera di irrigidimento	1	Kit 4 frontalini per contenitore RK Box Air
2	Kit 5 piani fessurati	32	Frontalino per contenitore RK Box Air
1	Piano fessurato	16	Frontalino per contenitore RK Box Air
2	Kit 4 contenitori RK Box Air 5014	20	Divisorio trasversale per contenitore RK Box Air
1	Kit 4 contenitori RK Box Air 5021	2	Kit 4 divisori trasversali per contenitore RK Box Air
32	Contenitore in polipropilene RK Box Air 5114	64	Divisorio trasversale per contenitore RK Box Air
16	Contenitore in polipropilene RK Box Air 5121	32	Divisorio trasversale per contenitore RK Box Air

SCAFFALI CON PIANI PER RK BOX AIR



SCAFFALE CON 13 PIANI E 82 CONTENITORI RK BOX AIR



ART.	L mm	P mm	H mm	finitura	€
ST1073	1057	521	2011	Zincato	1000,99

Composto da:

qtà	descrizione
2	Kit 2 montanti
4	Kit 2 piedini in polipropilene
2	Kit 3 traversini
2	Crociera di irrigidimento
2	Kit 5 piani fessurati
3	Piano fessurato
2	Kit 4 contenitori RK Box Air 5114
1	Kit 4 contenitori RK Box Air 5121
60	Contenitore in polipropilene RK Box Air 5014
3	Kit 4 contenitori RK Box Air 5014
80	Fermo posteriore per contenitore RK Box Air
1	Kit 4 fermi posteriori per contenitore RK Box Air

SCAFFALE CON 13 PIANI E 72 CONTENITORI RK BOX AIR



ART.	L mm	P mm	H mm	finitura	€
ST1074	1057	521	2011	Zincato	938,99

Composto da:

qtà	descrizione
2	Kit 2 montanti
4	Kit 2 piedini in polipropilene
2	Kit 3 traversini
2	Crociera di irrigidimento
2	Kit 5 piani fessurati
3	Piano fessurato
2	Kit 4 contenitori RK Box Air 5114
1	Kit 4 contenitori RK Box Air 5121
40	Contenitore in polipropilene RK Box Air 5014
20	Contenitore in polipropilene RK Box Air 5021
40	Fermo posteriore per contenitore RK Box Air
2	Kit 4 fermi posteriori per contenitore RK Box Air
20	Fermo posteriore per contenitore RK Box Air
1	Kit 4 fermi posteriori per contenitore RK Box Air



SCAFFALE CON 13 PIANI E 62 CONTENITORI RK BOX AIR



ART.	L mm	P mm	H mm	finitura	€
ST1075	1057	521	2011	Zincato	895,59

Composto da:

qtà	descrizione
2	Kit 2 montanti
4	Kit 2 piedini in polipropilene
2	Kit 3 traversini
2	Crociera di irrigidimento
2	Kit 5 piani fessurati
3	Piano fessurato
2	Kit 4 contenitori RK Box Air 5114
1	Kit 4 contenitori RK Box Air 5121
3	Kit 4 contenitori RK Box Air 5014
40	Contenitore in polipropilene RK Box Air 5021
20	Fermo posteriore per contenitore RK Box Air
40	Fermo posteriore per contenitore RK Box Air
1	Kit 4 fermi posteriori per contenitore RK Box Air



SCAFFALI CON PIANI PER RK BOX AIR



SCAFFALE CON 13 PIANI E 72 CONTENITORI RK BOX AIR CON DIVISORI E FRONTALINI

ART.	L mm	P mm	H mm	finitura	€
 ST1076	1057	521	2011	Zincato	1422,90

Composto da:

qtà	descrizione	qtà	descrizione
2	Kit 2 montanti	2	Kit 4 fermi posteriori per contenitore RK Box Air
4	Kit 2 piedini in polipropilene	20	Fermo posteriore per contenitore RK Box Air
2	Kit 3 traversini	1	Kit 4 fermi posteriori per contenitore RK Box Air
2	Crociera di irrigidimento	2	Kit 4 frontalini per contenitore RK Box Air
2	Kit 5 piani fessurati	1	Kit 4 frontalini per contenitore RK Box Air
3	Piano fessurato	40	Frontalino per contenitore RK Box Air
2	Kit 4 contenitori RK Box Air 5114	20	Frontalino per contenitore RK Box Air
1	Kit 4 contenitori RK Box Air 5121	16	Divisorio trasversale per contenitore RK Box Air
40	Contenitore in polipropilene RK Box Air 5014	2	Kit 4 divisori trasversali per contenitore RK Box Air
20	Contenitore in polipropilene RK Box Air 5021	80	Divisorio trasversale per contenitore RK Box Air
40	Fermo posteriore per contenitore RK Box Air	40	Divisorio trasversale per contenitore RK Box Air

ARMADI CON PORTE A BATTENTE PER RK BOX AIR

ARMADIO CON PORTE A BATTENTE CON 68 CONTENITORI RK BOX AIR



ART.	L mm	P mm	H mm	KG	RAL	€
 PERFOM14059	1023	555	2000	1200	7035+7016	1165,29
 PERFOM14060	1023	555	2000	1200	7035	1165,29
 PERFOM14061	1023	555	2000	1200	5012	1165,29



Composto da:

qtà	descrizione
1	Armadio con porte a battente
2	Kit 4 piani fessurati
1	Piano fessurato
2	Kit 4 contenitori RK Box Air 5014
1	Kit 4 contenitori RK Box Air 5021
48	Contenitore in polipropilene RK Box Air 5114
2	Kit 4 contenitori RK Box Air 5114
60	Fermo posteriore per contenitore RK Box Air
1	Kit 4 fermi posteriori per contenitore RK Box Air
1	Kit 4 fermi posteriori per contenitore RK Box Air

ARMADIO CON PORTE A BATTENTE CON 60 CONTENITORI RK BOX AIR



ART.	L mm	P mm	H mm	KG	RAL	€
 PERFOM14062	1023	555	2000	1200	7035+7016	1126,23
 PERFOM14063	1023	555	2000	1200	7035	1126,23
 PERFOM14064	1023	555	2000	1200	5012	1126,23



Composto da:

qtà	descrizione
1	Armadio con porte a battente
2	Kit 4 piani fessurati
1	Piano fessurato
2	Kit 4 contenitori RK Box Air 5014
1	Kit 4 contenitori RK Box Air 5021
32	Contenitore in polipropilene RK Box Air 5114
16	Contenitore in polipropilene RK Box Air 5121
40	Fermo posteriore per contenitore RK Box Air
20	Fermo posteriore per contenitore RK Box Air

ARMADIO CON PORTE A BATTENTE CON 52 CONTENITORI RK BOX AIR

ART.	L mm	P mm	H mm	KG	RAL	€
 PERFOM14065	1023	555	2000	1200	7035+7016	1104,53
 PERFOM14066	1023	555	2000	1200	7035	1104,53
 PERFOM14067	1023	555	2000	1200	5012	1104,53



Composto da:

qtà	descrizione
1	Armadio con porte a battente
2	Kit 4 piani fessurati
1	Piano fessurato
2	Kit 4 contenitori RK Box Air 5014
1	Kit 4 contenitori RK Box Air 5021
2	Kit 4 contenitori RK Box Air 5114
32	Contenitore in polipropilene RK Box Air 5121
20	Fermo posteriore per contenitore RK Box Air
40	Fermo posteriore per contenitore RK Box Air

ARMADI CON PORTE A BATTENTE PER RK BOX AIR



ARMADIO CON PORTE A BATTENTE CON 60 CONTENITORI RK BOX AIR CON DIVISORI E FRONTALINI

ART.	L mm	P mm	H mm	KG	RAL	€
PERFOM14068	1023	555	2000	1200	7035+7016	1582,86
PERFOM14069	1023	555	2000	1200	7035	1582,86
PERFOM14070	1023	555	2000	1200	5012	1582,86

Composto da:

qtà	descrizione
1	Armadio con porte a battente
2	Kit 4 piani fessurati
1	Piano fessurato
2	Kit 4 contenitori RK Box Air 5014
1	Kit 4 contenitori RK Box Air 5021
32	Contenitore in polipropilene RK Box Air 5114
16	Contenitore in polipropilene RK Box Air 5121
40	Fermo posteriore per contenitore RK Box Air
20	Fermo posteriore per contenitore RK Box Air

qtà	descrizione
2	Kit 4 frontalini per contenitore RK Box Air
1	Kit 4 frontalini per contenitore RK Box Air
32	Frontalino per contenitore RK Box Air
16	Frontalino per contenitore RK Box Air
20	Divisorio trasversale per contenitore RK Box Air
2	Kit 4 divisorii trasversali per contenitore RK Box Air
64	Divisorio trasversale per contenitore RK Box Air
32	Divisorio trasversale per contenitore RK Box Air



PORTATA



RAL 7035 + RAL 7016



RAL 7035



RAL 5012

ARMADI CON PORTE A BATTENTE PER RK BOX AIR

ARMADIO CON PORTE A BATTENTE CON 82 CONTENITORI RK BOX AIR



ART.	L mm	P mm	H mm	KG	RAL	€
PERFOM14071	1023	555	2000	1200	7035+7016	1318,12
PERFOM14072	1023	555	2000	1200	7035	1318,12
PERFOM14073	1023	555	2000	1200	5012	1318,12

Composto da:

qtà	descrizione
1	Armadio con porte a battente
2	Kit 4 piani fessurati
1	Kit 3 piani fessurati
2	Kit 4 contenitori RK Box Air 5114
1	Kit 4 contenitori RK Box Air 5121
60	Contenitore in polipropilene RK Box Air 5014
3	Kit 4 contenitori RK Box Air 5014
80	Fermo posteriore per contenitore RK Box Air
1	Kit 4 fermi posteriori per contenitore RK Box Air

ARMADIO CON PORTE A BATTENTE CON 72 CONTENITORI RK BOX AIR



ART.	L mm	P mm	H mm	KG	RAL	€
PERFOM14074	1023	555	2000	1200	7035+7016	1256,12
PERFOM14075	1023	555	2000	1200	7035	1256,12
PERFOM14076	1023	555	2000	1200	5012	1256,12

Composto da:

qtà	descrizione
1	Armadio con porte a battente
2	Kit 4 piani fessurati
1	Kit 3 piani fessurati
2	Kit 4 contenitori RK Box Air 5114
1	Kit 4 contenitori RK Box Air 5121
40	Contenitore in polipropilene RK Box Air 5014
20	Contenitore in polipropilene RK Box Air 5021
40	Fermo posteriore per contenitore RK Box Air
2	Kit 4 fermi posteriori per contenitore RK Box Air
20	Fermo posteriore per contenitore RK Box Air
1	Kit 4 fermi posteriori per contenitore RK Box Air

ARMADIO CON PORTE A BATTENTE CON 62 CONTENITORI RK BOX AIR



ART.	L mm	P mm	H mm	KG	RAL	€
PERFOM14077	1023	555	2000	1200	7035+7016	1212,72
PERFOM14078	1023	555	2000	1200	7035	1212,72
PERFOM14079	1023	555	2000	1200	5012	1212,72

Composto da:

qtà	descrizione
1	Armadio con porte a battente
2	Kit 4 piani fessurati
1	Kit 3 piani fessurati
2	Kit 4 contenitori RK Box Air 5114
1	Kit 4 contenitori RK Box Air 5121
3	Kit 4 contenitori RK Box Air 5014
40	Contenitore in polipropilene RK Box Air 5021
20	Fermo posteriore per contenitore RK Box Air
40	Fermo posteriore per contenitore RK Box Air
1	Kit 4 fermi posteriori per contenitore RK Box Air

ARMADI CON PORTE A BATTENTE PER RK BOX AIR



ARMADIO CON PORTE A BATTENTE CON 72 CONTENITORI RK BOX AIR CON DIVISORI E FRONTALINI

ART.	L mm	P mm	H mm	KG	RAL	€
PERFOM14080	1023	555	2000	1200	7035+7016	1740,03
PERFOM14081	1023	555	2000	1200	7035	1740,03
PERFOM14082	1023	555	2000	1200	5012	1740,03

Composto da:

qtà	descrizione
1	Armadio con porte a battente
2	Kit 4 piani fessurati
1	Kit 3 piani fessurati
2	Kit 4 contenitori RK Box Air 5114
1	Kit 4 contenitori RK Box Air 5121
40	Contenitore in polipropilene RK Box Air 5014
20	Contenitore in polipropilene RK Box Air 5021
40	Fermo posteriore per contenitore RK Box Air
2	Kit 4 fermi posteriori per contenitore RK Box Air
20	Fermo posteriore per contenitore RK Box Air

qtà	descrizione
1	Kit 4 fermi posteriori per contenitore RK Box Air
2	Kit 4 frontalini per contenitore RK Box Air
1	Kit 4 frontalini per contenitore RK Box Air
40	Frontalino per contenitore RK Box Air
20	Frontalino per contenitore RK Box Air
16	Divisorio trasversale per contenitore RK Box Air
2	Kit 4 divisorii trasversali per contenitore RK Box Air
80	Divisorio trasversale per contenitore RK Box Air
40	Divisorio trasversale per contenitore RK Box Air



PORTATA



RAL 7035 + RAL 7016



RAL 7035



RAL 5012

CONTENITORI A BOCCA DI LUPO

PICKING BOX MYTHOS

Ordinabile dal 15/04/26



I **contenitori a bocca di lupo Picking Box Mythos** sono le soluzioni professionali per la gestione e la raccolta di piccoli componenti, ricambi e minuteria. Sono caratterizzati da un'**apertura frontale** che agevola la visione e il prelievo del materiale contenuto e sono dotati di **bordi rinforzati, fondo e fianchi nervati** per poterli impilare in tutta sicurezza.

Picking Box Mythos può essere arricchito con una vasta gamma di accessori, sia per la suddivisione dello spazio interno che per la protezione e l'identificazione del contenuto. Oltre ai tradizionali **divisori**, infatti, sono disponibili **frontalini, coperchio parapolvere ed etichette**.

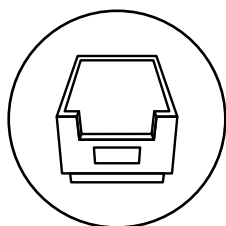

**APERTURA
FRONTALE BOCCA
DI LUPO**

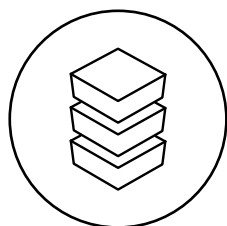

SOVRAPPONIBILE

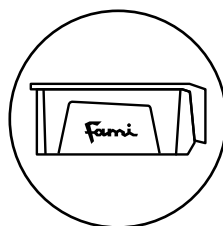

**MARCHIATURA
PERSONALIZZATA**

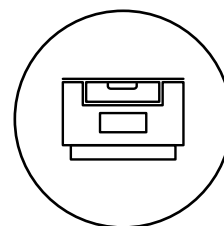

**AMPIA GAMMA
ACCESSORI**

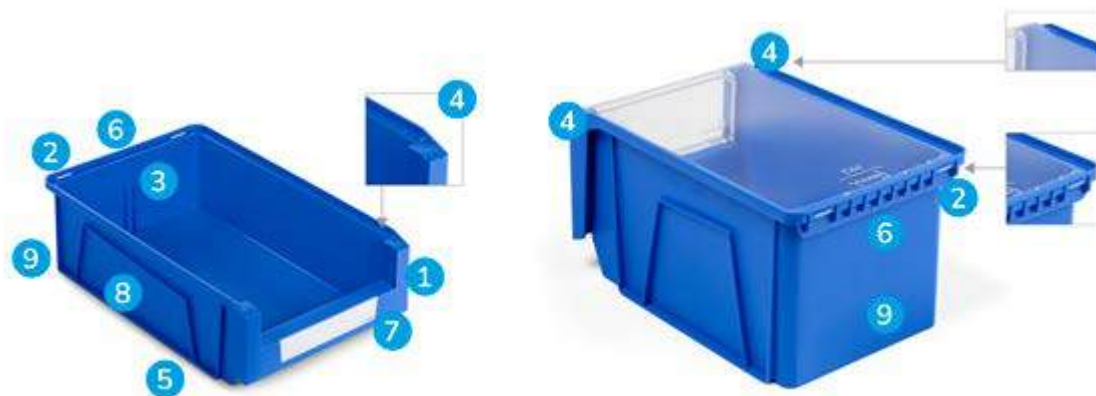

PICKING BOX MYTHOS

I contenitori sono caratterizzati da:

1. Angoli anteriori smussati a doppia parete
2. Fori per il fissaggio del coperchio
3. Predisposizione per divisorio longitudinale (mis. 1, 2 escluse)
4. Fori per clip chiusura coperchio
5. Fondo nervato
6. Gancio posteriore per l'aggancio su barre (mis. 1, 2, 3A2, 3)
Maniglia posteriore per il trasporto (mis. 4A2, 4, 4A5, 5)
7. Porta etichette
8. Nervatura strutturale con area per marchiatura
9. Retro liscio per applicazione etichette

Disponibili in 5 colori:



DESIGN VINCENTE

La struttura robusta e intelligente è studiata per offrire **funzionalità, resistenza** e ampio **spazio di stoccaggio**. Il fondo nervato e i rinforzi strutturali assicurano un'elevata portata, mentre il gancio posteriore permette un fissaggio facile e stabile su barre per pareti forate o carrelli. Il frontale liscio con porta etichette integrato, invece, consente una classificazione rapida e ordinata di tutto il materiale.



SOVRAPPONIBILI E COMPATIBILI

La particolare conformazione della parte superiore e inferiore del contenitore a bocca di lupo permette la **sovrapposizione stabile e sicura** dei Picking Box anche di diverse misure e in presenza di coperchi parapolvere. In caso di sovrapposizione, l'accesso al materiale contenuto è comunque possibile grazie all'apertura frontale.

I Picking Box Mythos, inoltre, sono **compatibili** con i contenitori a bocca di lupo di **altri brand**.



BORDI E FONDO NERVATO

I bordi rinforzati e il fondo nervato evitano la deformazione e irrobustiscono la struttura dei Picking Box Mythos per il contenimento di carichi pesanti.

MANIGLIE

Le maniglie frontali e posteriori sono ergonomiche per agevolare la presa e la movimentazione di Picking Box all'interno dell'area di lavoro.



GANCIO POSTERIORE

I contenitori di mis. 1, 2, 3A2 e 3 sono dotati di un gancio posteriore con speciali rinforzi nervati che aumentano la portata e la stabilità del contenitore quando è installato sui profili dei carrelli Bin Cart o sulle barre Iron Team.

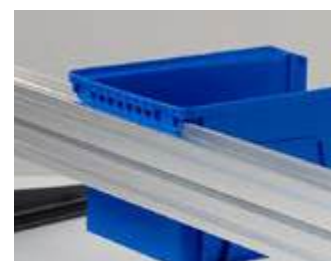

SUDDIVISIONE E PROTEZIONE



FRONTALINO

Il frontalino trasparente garantisce la visione del contenuto e, grazie al meccanismo di apertura a ribalta a 180°, facilita le operazioni di picking.



COPERCHIO

Il coperchio parapolvere protegge il contenuto da polvere e sporcizia. Le cerniere integrate ne permettono l'apertura controllata, evitando che si sfilino o fuoriesca dall'alloggiamento.



ETICHETTE

Le etichette semplificano l'identificazione del materiale e si inseriscono nella pratica tasca frontale.



TRAVERSINO

Il traversino ha una duplice funzione: aumenta la robustezza della struttura e può essere impiegato come maniglia aggiuntiva per la movimentazione del contenitore.



DIVISORIO LONGITUDINALE

Il divisorio longitudinale migliora l'organizzazione dello spazio interno del contenitore. Si installa inserendolo nelle apposite scanalature presenti sulla schiena dei Picking Box Myths, creando due aree per lo stoccaggio di materiali diversi per tipologia e dimensione.



CONTENITORE CON FONDO NERVATO - DIM. INGOMBRO (mm): L=104 P=164 H=75

ART.	multiplo d'ordine	mis.	dim. utili			L	colore	€
			Lmm	Pmm	Hmm			
FPK0001R0513Z	48	1	85	123	67	0,9		0,93
FPK0001R051LQ	48	1	85	123	67	0,9		0,93
FPK0001R0511Z	48	1	85	123	67	0,9		0,93
FPK0001R0512Y	48	1	85	123	67	0,9		0,93
FPK0001R0514Q	48	1	85	123	67	0,9		0,93



1



CONTENITORE CON FONDO NERVATO - DIM. INGOMBRO (mm): L=151 P=234 H=125

ART.	multiplo d'ordine	mis.	dim. utili			L	colore	€
			Lmm	Pmm	Hmm			
FPK0002R0513Z	18	2	130	180	117	3,2		2,17
FPK0002R051LQ	18	2	130	180	117	3,2		2,17
FPK0002R0511Z	18	2	130	180	117	3,2		2,17
FPK0002R0512Y	18	2	130	180	117	3,2		2,17
FPK0002R0514Q	18	2	130	180	117	3,2		2,17



2



CONTENITORE CON FONDO NERVATO - DIM. INGOMBRO (mm): L=211 P=354 H=145

ART.	multiplo d'ordine	mis.	dim. utili			L	colore	€
			Lmm	Pmm	Hmm			
FPK03A2R0513Z	24	3A2	185	290	135	8,4		4,96
FPK03A2R051LQ	24	3A2	185	290	135	8,4		4,96
FPK03A2R0511Z	24	3A2	185	290	135	8,4		4,96
FPK03A2R0512Y	24	3A2	185	290	135	8,4		4,96
FPK03A2R0514Q	24	3A2	185	290	135	8,4		4,96



3A2



CONTENITORE CON FONDO NERVATO - DIM. INGOMBRO (mm): L=212 P=354 H=200

ART.	multiplo d'ordine	mis.	dim. utili			L	colore	€
			Lmm	Pmm	Hmm			
FPK0003R0513Z	18	3	184	279	190	11,6		5,89
FPK0003R051LQ	18	3	184	279	190	11,6		5,89
FPK0003R0511Z	18	3	184	279	190	11,6		5,89
FPK0003R0512Y	18	3	184	279	190	11,6		5,89
FPK0003R0514Q	18	3	184	279	190	11,6		5,89



3



CONTENITORE CON FONDO NERVATO - DIM. INGOMBRO (mm): L=314 P=500 H=145



ART.	multiplo d'ordine	mis.	dim. utili			L	colore	€
			L mm	P mm	H mm			
FPK04A2R0513Z	9	4A2	282	420	132	18,3		10,54
FPK04A2R051LQ	9	4A2	282	420	132	18,3		10,54
FPK04A2R0511Z	9	4A2	282	420	132	18,3		10,54
FPK04A2R0512Y	9	4A2	282	420	132	18,3		10,54
FPK04A2R0514Q	9	4A2	282	420	132	18,3		10,54

CONTENITORE CON FONDO NERVATO - DIM. INGOMBRO (mm): L=315 P=500 H=200



ART.	multiplo d'ordine	mis.	dim. utili			L	colore	€
			L mm	P mm	H mm			
FPK0004R0513Z	8	4	283	412	188	25,3		11,47
FPK0004R051LQ	8	4	283	412	188	25,3		11,47
FPK0004R0511Z	8	4	283	412	188	25,3		11,47
FPK0004R0512Y	8	4	283	412	188	25,3		11,47
FPK0004R0514Q	8	4	283	412	188	25,3		11,47

CONTENITORE CON FONDO NERVATO - DIM. INGOMBRO (mm): L=315 P=500 H=300



ART.	multiplo d'ordine	mis.	dim. utili			L	colore	€
			L mm	P mm	H mm			
FPK04A5R0513Z	28	4A5	282	392	288	38		14,26
FPK04A5R051LQ	28	4A5	282	392	288	38		14,26
FPK04A5R0511Z	28	4A5	282	392	288	38		14,26
FPK04A5R0512Y	28	4A5	282	392	288	38		14,26
FPK04A5R0514Q	28	4A5	282	392	288	38		14,26

CONTENITORE CON FONDO NERVATO - DIM. INGOMBRO (mm): L=474 P=724 H=300











ART.	multiplo d'ordine	mis.	dim. utili			L	colore	€
			L mm	P mm	H mm			
FPK0005R0513Z	14	5	432	596	284	83,8		32,86
FPK0005R051LQ	14	5	432	596	284	83,8		32,86
FPK0005R0511Z	14	5	432	596	284	83,8		32,86
FPK0005R0512Y	14	5	432	596	284	83,8		32,86
FPK0005R0514Q	14	5	432	596	284	83,8		32,86

ACCESSORI

Ordinabile dal 15/04/26



FRONTALINO PER CONTENITORE PICKING BOX MYTHOS

ART.	multiplo d'ordine	adatto per	mis.	€
 FPKF001000096	12	FPK0001R051	1	0,93
 FPKF002000096	9	FPK0002R051	2	1,24
 FPKF3A2000096	12	FPK03A2R051	3A2	1,55
 FPKF003000096	9	FPK0003R051	3	1,55
 FPKF4A2000096	9	FPK04A2R051	4A2	1,55
 FPKF004000096	8	FPK0004R051	4	1,86
 FPKF4A5000096	14	FPK04A5R051	4A5	2,79
 FPKF005000096	7	FPK0005R051	5	4,34



Il frontalino presenta un meccanismo anti-sgancio che evita che il componente si stacchi dall'alloggiamento quando aperto.

COPERCHIO PARAPOLVERE PER CONTENITORE PICKING BOX MYTHOS

ART.	multiplo d'ordine	adatto per	mis.	€
 FPKC001000096	12	FPK0001R051	1	1,55
 FPKC002000096	9	FPK0002R051	2	2,17
 FPKC003000096	6	FPK0003R051 FPK03A2R051	3/3A2	3,41
 FPKC004000096	8	FPK0004R051 FPK04A2R051 FPK04A5R051	4/4A2/4A5	7,75
 FPKC005000096	7	FPK0005R051	5	15,50



Il coperchio parapolvere per contenitore può essere installato in combinazione con il frontalino.





Coperchio completo di cerniere

ACCESSORI

Ordinabile dal 15/04/26





DIVISORIO LONGITUDINALE PER CONTENITORE PICKING BOX MYTHOS

ART.	multiplo d'ordine	adatto per	mis.	€
 FPKD3A2L05107	12	FPK03A2R051	3A2	2,17
 FPKD003L05107	9	FPK0003R051	3	2,79
 FPKD4A2L05107	9	FPK04A2R051	4A2	3,72
 FPKD004L05107	8	FPK0004R051	4	4,03
 FPKD4A5L05107	14	FPK04A5R051	4A5	5,58
 FPKD005L05107	7	FPK0005R051	5	7,44

Il divisorio longitudinale è installato inserendolo nelle scanalature presenti all'interno del contenitore.



TRAVERSINO PER CONTENITORE PICKING BOX MYTHOS





ART.	multiplo d'ordine	adatto per	mis.	€
 FPKT004000007	8	FPK0004R051 FPK04A2R051 FPK04A5R051	4/4A2/4A5	2,48
 FPKT005000007	7	FPK0005R051	5	3,72



Il traversino è fissato tramite viti nella parte anteriore del contenitore, in corrispondenza dell'apertura.



ETICHETTE AGGIUNTIVE PER CONTENITORE PICKING BOX MYTHOS

ART.	multiplo d'ordine	n. etichette per foglio	adatto per	mis.	€
 FPKE001F00013	10	54	FPK0001R051	1	0,93
 FPKE002F00013	10	18	FPK0002R051	2	0,93
 FPKE003F00013	10	10	FPK0003R051 FPK03A2R051	3/3A2	0,93
 FPKE004F00013	10	7	FPK0004R051 FPK04A2R051 FPK04A5R051	4/4A2/4A5	0,93
 FPKE005F00013	10	2	FPK0005R051	5	1,24



CONTENITORI PER SCAFFALI

RK BOX CLASSIC



Le **cassette RK Box** sono impiegate per lo stoccaggio di minuterie e piccoli componenti e presentano dimensioni tali da poterle custodire all'interno di **scaffali**. I diversi modelli e formati, infatti, possono essere inseriti negli appositi scomparti degli scaffali modulari per creare un **magazzino C-Parts** organizzato ed ordinato. La sovrapposizione è garantita dal design del bordo superiore e del fondo e, grazie alle nervature laterali, non vi è deformazione in quanto il peso viene distribuito lungo tutta la cassetta. RK Box sono dotate di scanalature interne per l'inserimento di **divisori longitudinali** e **trasversali** e sono predisposte per l'aggiunta di un pratico **coperchio parapolvere** così da proteggere il contenuto da sporcizia e polvere.

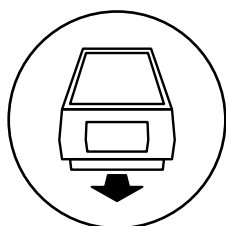

ESTRAIBILE

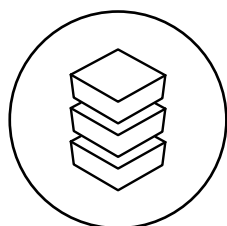

SOVRAPPONIBILE

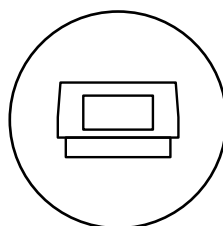

ETICHETTE DI
SERIE

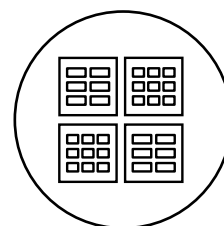

MODULARE

CLASSIC



RK BOX

Le cassette per scaffali sono caratterizzate da:

1. Guide di sospensione con bordi rinforzati
2. Angoli anteriori smussati
3. Portaetichette con etichette di serie
4. Predisposizione per divisorio trasversale
5. Predisposizione per divisorio longitudinale



BORDI RINFORZATI

I bordi rinforzati consentono la sovrapposizione della cassetta e ne evitano la deformazione a causa del peso. Il fondo è liscio e presenta apposite guide per agevolare lo scorrimento di RK Box nelle guide degli scaffali.

DIVISORI

Le scanalature presenti sulle pareti laterali e posteriori agevolano l'inserimento di divisori longitudinali e trasversali per l'organizzazione dello spazio interno.

FERMO

Il fermo posteriore evita la caduta accidentale della cassetta dallo scaffale quando estratta.



SCAFFALE MODULARE

Le cassette RK Box possono essere custodite negli appositi scaffali in acciaio con ripiani per creare un'area di approvvigionamento organizzata. Ogni ripiano, infatti, presenta apposite fessure su cui installare le guide per lo scorrimento delle cassette.

SUDDIVISIONE E PROTEZIONE

Divisorio longitudinale

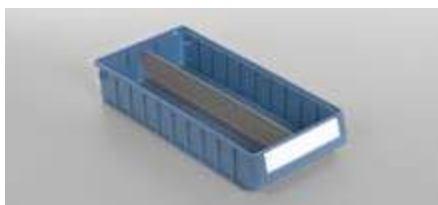

Divisorio trasversale



Parapolvere



CLASSIC

PICKING BOX

RK BOX

EURO BOX

EURO BOX - ESD

VISUAL BOX

MAT

P= 300 mm



CASSETTA CON FONDO LISCIO - DIM. INGOMBRO (mm): L=117 P=300 H=90

ART.	multiplo d'ordine	dim. utili			L	colore	€
		L mm	P mm	H mm			
FAXRK3012L0513K	16	92	259	80	2		4,65



CASSETTA CON FONDO LISCIO - DIM. INGOMBRO (mm): L=156 P=300 H=90

ART.	multiplo d'ordine	dim. utili			L	colore	€
		L mm	P mm	H mm			
FAXRK3016L0513K	12	133	256	80	2,7		5,27



CASSETTA CON FONDO LISCIO - DIM. INGOMBRO (mm): L=234 P=300 H=90

ART.	multiplo d'ordine	dim. utili			L	colore	€
		L mm	P mm	H mm			
FAXRK3024L0513K	8	208	254	80	4,4		5,27

P= 400 mm



CASSETTA CON FONDO LISCIO - DIM. INGOMBRO (mm): L=117 P=400 H=90

ART.	multiplo d'ordine	dim. utili			L	colore	€
		L mm	P mm	H mm			
FAXRK4012L0513K	16	92	358	80	2,7		5,27



CASSETTA CON FONDO LISCIO - DIM. INGOMBRO (mm): L=156 P=400 H=90

ART.	multiplo d'ordine	dim. utili			L	colore	€
		L mm	P mm	H mm			
FAXRK4016L0513K	12	133	356	80	3,8		5,89



CASSETTA CON FONDO LISCIO - DIM. INGOMBRO (mm): L=234 P=400 H=90

ART.	multiplo d'ordine	dim. utili			L	colore	€
		L mm	P mm	H mm			
FAXRK4024L0513K	8	208	354	80	6		7,44

CLASSIC

PICKING BOX

RK BOX

EURO BOX

EURO BOX - ESD

VISUAL BOX

MAT

P= 500 mm



CASSETTA CON FONDO LISCIO - DIM. INGOMBRO (mm): L=117 P=500 H=90

ART.	multiplo d'ordine	dim. utili			L	colore	€
		L mm	P mm	H mm			
FAXRK5012L0513K	16	92	456	80	3,5		5,89



CASSETTA CON FONDO LISCIO - DIM. INGOMBRO (mm): L=156 P=500 H=90

ART.	multiplo d'ordine	dim. utili			L	colore	€
		L mm	P mm	H mm			
FAXRK5016L0513K	12	133	456	80	4,9		6,20



CASSETTA CON FONDO LISCIO - DIM. INGOMBRO (mm): L=234 P=500 H=90

ART.	multiplo d'ordine	dim. utili			L	colore	€
		L mm	P mm	H mm			
FAXRK5024L0513K	8	208	451	80	7,8		8,06







PARAPOLVERE PER CASSETTA RK BOX CLASSIC

ART.	multiplo d'ordine	adatto per	€
 FAXRK3P12000096	10	FAXRK3012L051	5,89
 FAXRK3P16000096	10	FAXRK3016L051	9,30
 FAXRK3P24000096	10	FAXRK3024L051	12,40
 FAXRK4P12000096	10	FAXRK4012L051	7,13
 FAXRK4P16000096	10	FAXRK4016L051	10,23
 FAXRK4P24000096	10	FAXRK4024L051	8,68
 FAXRK5P12000096	10	FAXRK5012L051	7,13
 FAXRK5P16000096	10	FAXRK5016L051	10,54
 FAXRK5P24000096	10	FAXRK5024L051	16,74



Il parapolvere è posizionato nella parte superiore della cassetta e protegge il contenuto da polvere e sporcizia.

DIVISORIO LONGITUDINALE PER CASSETTA RK BOX CLASSIC

ART.	multiplo d'ordine	adatto per	€
 FAXRK30D0L00033	10	FAXRK3016L051 FAXRK3024L051	6,82
 FAXRK40D0L00033	10	FAXRK4016L051 FAXRK4024L051	6,82
 FAXRK50D0L00033	10	FAXRK5016L051	8,06
 FAXRK50D0L10033	10	FAXRK5024L051	7,44

Il divisorio longitudinale è installato inserendolo nelle scanalature presenti all'interno della cassetta.

DIVISORIO TRASVERSALE PER CASSETTA RK BOX CLASSIC

ART.	multiplo d'ordine	adatto per	€
 FAXRKD012T05196	10	FAXRK3012L051 FAXRK4012L051 FAXRK5012L051	0,62
 FAXRKD016T05196	10	FAXRK3016L051 FAXRK4016L051 FAXRK5016L051	0,93
 FAXRKD024T05196	10	FAXRK3024L051 FAXRK4024L051 FAXRK5024L051	1,24

Il divisorio trasversale suddivide l'interno della cassetta in più aree per la custodia di minuteria di diverso tipo. È fornito di serie con un'etichetta.



ACCESSORI



PORTA ETICHETTE PER CASSETTA RK BOX CLASSIC

ART.	multiplo d'ordine	adatto per	€
 FAXRKE012P00096	50	FAXRK3012L051 FAXRK4012L051 FAXRK5012L051	0,62
 FAXRKE016P00096	50	FAXRK3016L051 FAXRK4016L051 FAXRK5016L051	0,62
 FAXRKE024P00096	50	FAXRK3024L051 FAXRK4024L051 FAXRK5024L051	0,62

Il porta etichette protegge le etichette da polvere e sporcizia ed è inserito nell'alloggiamento frontale della cassetta RK Box.



ETICHETTE AGGIUNTIVE PER CASSETTA RK BOX CLASSIC

ART.	multiplo d'ordine	n. etichette per foglio	adatto per	€
 FAXRKE012F00013	25	15	FAXRK3012L051 FAXRK4012L051 FAXRK5012L051	1,24
 FAXRKE016F00013	25	10	FAXRK3016L051 FAXRK4016L051 FAXRK5016L051	1,24
 FAXRKE024F00013	25	7	FAXRK3024L051 FAXRK4024L051 FAXRK5024L051	1,24



CLASSIC

PICKING BOX

RK BOX

EURO BOX

EURO BOX - ESD

VISUAL BOX

MAT

P= 300 mm



SCAFFALE CON 16 CASSETTE RK BOX CLASSIC

ART.	L mm	P mm	H mm	n. contenitori	RAL	€
 RKBOX3004	500	300	545	16 x FAXRK3012L0513K	7000	218,55

Completo di guide e fermi posteriori



SCAFFALE CON 12 CASSETTE RK BOX CLASSIC

ART.	L mm	P mm	H mm	n. contenitori	RAL	€
 RKBOX3005	500	300	545	12 x FAXRK3016L0513K	7000	212,97

Completo di guide e fermi posteriori



SCAFFALE CON 8 CASSETTE RK BOX CLASSIC

ART.	L mm	P mm	H mm	n. contenitori	RAL	€
 RKBOX3006	500	300	545	8 x FAXRK3024L0513K	7000	166,47

Completo di guide e fermi posteriori

P= 400 mm



SCAFFALE CON 16 CASSETTE RK BOX CLASSIC

ART.	L mm	P mm	H mm	n. contenitori	RAL	€
 RKBOX4004	500	400	545	16 x FAXRK4012L0513K	7000	243,66

Completo di guide e fermi posteriori



SCAFFALE CON 12 CASSETTE RK BOX CLASSIC

ART.	L mm	P mm	H mm	n. contenitori	RAL	€
 RKBOX4005	500	400	545	12 x FAXRK4016L0513K	7000	234,98

Completo di guide e fermi posteriori



SCAFFALE CON 8 CASSETTE RK BOX CLASSIC

ART.	L mm	P mm	H mm	n. contenitori	RAL	€
 RKBOX4006	500	400	545	8 x FAXRK4024L0513K	7000	197,78

Completo di guide e fermi posteriori

P= 500 mm



SCAFFALE CON 16 CASSETTE RK BOX CLASSIC

ART.	L mm	P mm	H mm	n. contenitori	RAL	€
 RKBOX5004	500	500	545	16 x FAXRK5012L0513K	7000	261,02

Completo di guide e fermi posteriori



SCAFFALE CON 12 CASSETTE RK BOX CLASSIC

ART.	L mm	P mm	H mm	n. contenitori	RAL	€
 RKBOX5005	500	500	545	12 x FAXRK5016L0513K	7000	246,76

Completo di guide e fermi posteriori



SCAFFALE CON 8 CASSETTE RK BOX CLASSIC

ART.	L mm	P mm	H mm	n. contenitori	RAL	€
 RKBOX5006	500	500	545	8 x FAXRK5024L0513K	7000	211,42



Completo di guide e fermi posteriori



COMPONENTI PER SCAFFALI PER RK BOX CLASSIC





SCAFFALE VUOTO

ART.	L mm	P mm	H mm	n. ripiani	RAL	€
 FRKBX30S30001	500	300	545	3	7000	97,03
 FRKBX40S30001	500	400	545	3	7000	110,36
 FRKBX50S30001	500	500	545	3	7000	119,66





KIT 4 GUIDE PER SCAFFALE

ART.	per scaffale P mm	finitura	€
 FRKBX30KG0499	300	Zincato	7,44
 FRKBX40KG0499	400	Zincato	8,06
 FRKBX50KG0499	500	Zincato	7,44



KIT FERMI POSTERIORI PER CASSETTE RK BOX CLASSIC

ART.	n. fermi	adatto per	finitura	€
 FRKBX00KS1699	16	FAXRK3012L051 FAXRK4012L051 FAXRK5012L051	Zincato	24,80
 FRKBX00KS1299	12	FAXRK3016L051 FAXRK4016L051 FAXRK5016L051	Zincato	37,82
 FRKBX00KS0899	8	FAXRK3024L051 FAXRK4024L051 FAXRK5024L051	Zincato	19,84





La struttura modulare consente di impilare scaffali con la medesima profondità o con profondità decrescente.

Ogni scaffale, infatti, presenta delle alette nella parte superiore per sovrapporre in modo stabile e sicuro i diversi moduli.



 RAL 7000

 ZINCATO

CONTENITORI EURO

EURO BOX CLASSIC



Le **Euro Box** sono tipicamente utilizzate per l'organizzazione di magazzini e, soprattutto, nella distribuzione e nella logistica. Queste cassette, infatti, presentano dimensioni compatibili con gli **Euro pallet** per l'ottimizzazione del carico durante il trasporto. Euro Box è disponibile in diverse varianti in base alla tipologia di maniglia (chiusa, aperta, a conchiglia) o fondo scelto (liscio o rinforzato). I bordi rinforzati rendono l'intera struttura più solida e robusta e consentono la sovrapposizione di più cassette sia con che senza coperchio. Cassette divisorio e divisori a pettine in polipropilene sono disponibili per la suddivisione interna del contenitore e per una migliore gestione del materiale da stoccare.

Le **Euro Box ESD** sono realizzate in polipropilene conduttivo per l'impiego in ambienti a rischio di scariche elettrostatiche.

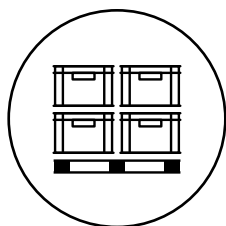

**MISURE
COMPATIBILI CON
EUROPALLET**

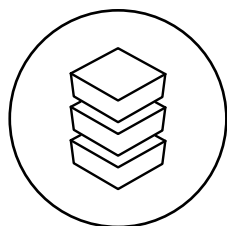

SOVRAPPONIBILE

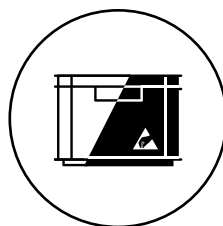

**POLIPROPILENE O
POLIPROPILENE
ESD**

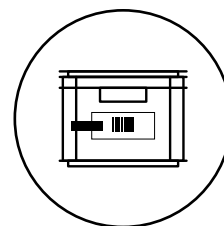

**AMPIA GAMMA
ACCESSORI**

CLASSIC



EURO BOX

Le cassette sono caratterizzate da:

1. Pareti rinforzate
2. Predisposizione per coperchio
3. Maniglie (aperte, chiuse o a conchiglia)
4. Fondo liscio o rinforzato



BORDI RINFORZATI

I bordi rinforzati irrobustiscono l'intera struttura, rendendola resistente a carichi pesanti in caso di sovrapposizione. Quest'ultima può avvenire anche se è presente il coperchio a cerniera.

MANIGLIE

Oltre alle tradizionali maniglie chiuse o aperte, Euro Box è disponibile anche con maniglia a conchiglia.

FONDO

Le cassette Euro Box sono disponibili con fondo liscio o fondo rinforzato per una capacità di carico più elevata.



POLIPROPILENE ESD

Le Euro Box in polipropilene ESD possono essere impiegate per la custodia e il trasporto di prodotti elettronici in quanto proteggono il contenuto da possibili scariche elettrostatiche.



MARCHIATURA PERSONALIZZATA

Su richiesta è possibile marchiare le cassette Euro Box con il nome o logo aziendale.

SUDDIVISIONE E PROTEZIONE

Cassette divisorio 400x300



Cassette divisorio 600x400



Divisori a pettine



Porta etichetta



Chiusura



CLASSIC

PICKING BOX

RK BOX

EURO BOX

EURO BOX - ESD

VISUAL BOX

MAT

COPERCHIO

300x200 mm



COPERCHIO A CERNIERA

ART.	L mm	P mm	H mm	colore	€
FAXEB32C0005137	300	200	22		2,48

400x300 mm



COPERCHIO A CERNIERA

ART.	L mm	P mm	H mm	colore	€
FAXEB43C0005137	400	300	22		4,34

600x400 mm



COPERCHIO A CERNIERA

ART.	L mm	P mm	H mm	colore	€
FAXEB64C0005137	600	400	22		8,06

300x200 mm



CASSETTA CON FONDO LISCIO - DIM. INGOMBRO (mm): L=300 P=200 H=120

ART.	mis.	dim. utili				colore	€
		L mm	P mm	H mm			
FAXEB3212L15137	3212	260	160	117	4,9		4,65



CASSETTA CON FONDO LISCIO - DIM. INGOMBRO (mm): L=300 P=200 H=147

ART.	mis.	dim. utili				colore	€
		L mm	P mm	H mm			
FAXEB3215L15137	3215	260	160	145	6		5,27



CASSETTA CON FONDO LISCIO - DIM. INGOMBRO (mm): L=300 P=200 H=220

ART.	mis.	dim. utili				colore	€
		L mm	P mm	H mm			
FAXEB3222L15137	3222	260	160	218	9,1		6,20





CLASSIC

400x300 mm



PICKING BOX RK BOX **EURO BOX** EURO BOX - ESD VISUAL BOX MAT

CASSETTA CON FONDO LISCIO - DIM. INGOMBRO (mm): L=400 P=300 H=120

ART.	mis.	dim. utili			L	colore	€
		L mm	P mm	H mm			
 FAXEB4312L15137	4312	360	258	118	11		7,13



CASSETTA CON FONDO LISCIO - DIM. INGOMBRO (mm): L=400 P=300 H=170

ART.	mis.	dim. utili			L	colore	€
		L mm	P mm	H mm			
 FAXEB4317L05137	4317	358	258	168	15,5		8,37





CASSETTA CON FONDO LISCIO - DIM. INGOMBRO (mm): L=400 P=300 H=220

ART.	mis.	dim. utili			L	colore	€
		L mm	P mm	H mm			
 FAXEB4322L05137	4322	358	258	217	19,9		10,85





CASSETTA CON FONDO LISCIO - DIM. INGOMBRO (mm): L=400 P=300 H=220

ART.	mis.	dim. utili			L	colore	€
		L mm	P mm	H mm			
 FAXEB4322L25137	4322	358	258	217	19,9		10,85



CASSETTA CON FONDO RINFORZATO - DIM. INGOMBRO (mm): L=400 P=300 H=220

ART.	mis.	dim. utili			L	colore	€
		L mm	P mm	H mm			
 FAXEB4322R25137	4322	358	258	205	18,9		14,57





-  FONDO LISCIO
-  FONDO RINFORZATO
-  PARETI CHIUSE
-  MANIGLIA CONCHIGLIA
-  MANIGLIE CHIUSE
-  MANIGLIE APERTE
-  CAPACITÀ

CLASSIC

400x300 mm



PICKING BOX	RK BOX	EURO BOX	EURO BOX - ESD	VISUAL BOX	MAT
-------------	--------	-----------------	----------------	------------	-----

CASSETTA CON FONDO LISCIO - DIM. INGOMBRO (mm): L=400 P=300 H=270

ART.	mis.	dim. utili			L	colore	€
		L mm	P mm	H mm			
 FAXEB4327L05137	4327	358	256	267	24,3		14,88





CASSETTA CON FONDO LISCIO - DIM. INGOMBRO (mm): L=400 P=300 H=270

ART.	mis.	dim. utili			L	colore	€
		L mm	P mm	H mm			
 FAXEB4327L25137	4327	358	256	267	24,3		14,88





CASSETTA CON FONDO LISCIO - DIM. INGOMBRO (mm): L=400 P=300 H=320

ART.	mis.	dim. utili			L	colore	€
		L mm	P mm	H mm			
 FAXEB4332L05137	4332	358	256	316	29		16,74





CASSETTA CON FONDO LISCIO - DIM. INGOMBRO (mm): L=400 P=300 H=320

ART.	mis.	dim. utili			L	colore	€
		L mm	P mm	H mm			
 FAXEB4332L25137	4332	358	256	316	29		16,74



CASSETTA CON FONDO RINFORZATO - DIM. INGOMBRO (mm): L=400 P=300 H=320

ART.	mis.	dim. utili			L	colore	€
		L mm	P mm	H mm			
 FAXEB4332R25137	4332	358	256	305	28		17,36



CLASSIC

600x400 mm

PICKING BOX RK BOX **EURO BOX** EURO BOX - ESD VISUAL BOX MAT



CASSETTA CON FONDO LISCIO - DIM. INGOMBRO (mm): L=600 P=400 H=75

ART.	mis.	dim. utili			L	colore	€
		L mm	P mm	H mm			
FAXEB6408L05137	6408	555	355	72	14,2		10,54



CASSETTA CON FONDO LISCIO - DIM. INGOMBRO (mm): L=600 P=400 H=120

ART.	mis.	dim. utili			L	colore	€
		L mm	P mm	H mm			
FAXEB6412L15137	6412	555	358	115	22,8		12,09



CASSETTA CON FONDO LISCIO - DIM. INGOMBRO (mm): L=600 P=400 H=150

ART.	mis.	dim. utili			L	colore	€
		L mm	P mm	H mm			
FAXEB6415L05137	6415	553	353	145	28,3		14,57



CASSETTA CON FONDO LISCIO - DIM. INGOMBRO (mm): L=600 P=400 H=150

ART.	mis.	dim. utili			L	colore	€
		L mm	P mm	H mm			
FAXEB6415L25137	6415	553	353	145	28,3		14,57



CASSETTA CON FONDO LISCIO - DIM. INGOMBRO (mm): L=600 P=400 H=170

ART.	mis.	dim. utili			L	colore	€
		L mm	P mm	H mm			
FAXEB6417L05137	6417	555	355	165	32,5		13,95



CASSETTA CON FONDO LISCIO - DIM. INGOMBRO (mm): L=600 P=400 H=170

ART.	mis.	dim. utili			L	colore	€
		L mm	P mm	H mm			
FAXEB6417L25137	6417	555	355	165	32,5		13,95



CLASSIC

600x400 mm

PICKING BOX	RK BOX	EURO BOX	EURO BOX - ESD	VISUAL BOX	MAT
-------------	--------	-----------------	----------------	------------	-----



CASSETTA CON FONDO LISCIO - DIM. INGOMBRO (mm): L=600 P=400 H=220

ART.	mis.	dim. utili			L	colore	€
		L mm	P mm	H mm			
FAXEB6422L05137	6422	555	358	217	43,1		16,12



CASSETTA CON FONDO LISCIO - DIM. INGOMBRO (mm): L=600 P=400 H=220

ART.	mis.	dim. utili			L	colore	€
		L mm	P mm	H mm			
FAXEB6422L25137	6422	555	358	217	43,1		16,12



CASSETTA CON FONDO LISCIO - DIM. INGOMBRO (mm): L=600 P=400 H=236

ART.	mis.	dim. utili			L	colore	€
		L mm	P mm	H mm			
FAXEB6424L05137	6424	555	357	231	45,8		17,98



CASSETTA CON FONDO LISCIO - DIM. INGOMBRO (mm): L=600 P=400 H=236

ART.	mis.	dim. utili			L	colore	€
		L mm	P mm	H mm			
FAXEB6424L25137	6424	555	357	231	45,8		17,98



CASSETTA CON FONDO LISCIO - DIM. INGOMBRO (mm): L=600 P=400 H=280

ART.	mis.	dim. utili			L	colore	€
		L mm	P mm	H mm			
FAXEB6428L05137	6428	553	355	277	54,4		20,77



CASSETTA CON FONDO LISCIO - DIM. INGOMBRO (mm): L=600 P=400 H=280

ART.	mis.	dim. utili			L	colore	€
		L mm	P mm	H mm			
FAXEB6428L25137	6428	553	355	277	54,4		20,77



CLASSIC

600x400 mm

PICKING BOX RK BOX **EURO BOX** EURO BOX - ESD VISUAL BOX MAT



CASSETTA CON FONDO LISCIO - DIM. INGOMBRO (mm): L=600 P=400 H=320

ART.	mis.	dim. utili			L	colore	€
		L mm	P mm	H mm			
FAXEB6432L05137	6432	551	352	318	60,3		21,70



CASSETTA CON FONDO LISCIO - DIM. INGOMBRO (mm): L=600 P=400 H=320

ART.	mis.	dim. utili			L	colore	€
		L mm	P mm	H mm			
FAXEB6432L25137	6432	554	354	317	60,3		21,70



CASSETTA CON FONDO RINFORZATO - DIM. INGOMBRO (mm): L=600 P=400 H=320

ART.	mis.	dim. utili			L	colore	€
		L mm	P mm	H mm			
FAXEB6432R25137	6432	552	352	306	58,5		24,80



CASSETTA CON FONDO LISCIO - DIM. INGOMBRO (mm): L=600 P=400 H=423

ART.	mis.	dim. utili			L	colore	€
		L mm	P mm	H mm			
FAXEB6442L05137	6442	555	355	420	82,8		29,14



CASSETTA CON FONDO LISCIO - DIM. INGOMBRO (mm): L=600 P=400 H=423

ART.	mis.	dim. utili			L	colore	€
		L mm	P mm	H mm			
FAXEB6442L25137	6442	555	355	420	82,8		29,14



CASSETTA CON FONDO RINFORZATO - DIM. INGOMBRO (mm): L=600 P=400 H=418

ART.	mis.	dim. utili			L	colore	€
		L mm	P mm	H mm			
FAXEB6442R25137	6442	555	355	400	78,8		31,62



FONDO LISCIO
 FONDO RINFORZATO
 PARETI CHIUSE
 MANIGLIE CHIUSE
 MANIGLIE APERTE
 CAPACITÀ

CLASSIC

PICKING BOX

RK BOX

EURO BOX

EURO BOX - ESD

VISUAL BOX

MAT

800x600 mm



CASSETTA CON FONDO MODULARE - DIM. INGOMBRO (mm): L=800 P=600 H=320

ART.	mis.	dim. utili			L	colore	€
		L mm	P mm	H mm			
FAXEB8632M25137	8632	753	552	297	123,4	■	43,40



⚠ Questo modello presenta maniglie su tutti i lati

CASSETTE DIVISORIO PER CASSETTE 400x300 mm

SCHEMA PARTIZIONI

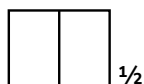

CASSETTA DIVISORIO PER CASSETTA EURO BOX - DIM. INGOMBRO (mm): L=250 P=175 H=95

ART.	partizione	dim. utili			L	colore	€
		L mm	P mm	H mm			
FAXEB43S0025137	1/2	242	158	88	3,3	■	6,51



Esempio di partizione delle cassette Euro Box 400x300 mm con cassette divisorio (2 x FAXEB43S0025137)



Esempio di partizione delle cassette Euro Box 600x400 mm con cassette divisorio (1 x FAXEB64S1085137, 2 x FAXEB64S0165137, 1 x FAXEB64S0047137, 2 x FAXEB64S0085137, 1 x FAXEB64S1045137)

CASSETTE DIVISORIO PER CASSETTE 600x400 mm

SCHEMA PARTIZIONI

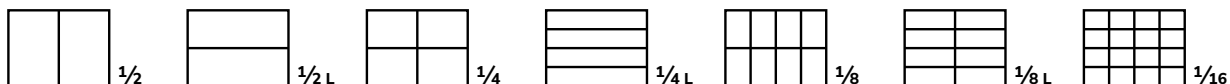

CASSETTA DIVISORIO PER CASSETTA EURO BOX - DIM. INGOMBRO (mm): L=550 P=174 H=110



ART.	partizione	dim. utili			L	colore	€
		L mm	P mm	H mm			
FAXEB64S0027137	1/2	544	168	105	9,6	■	14,88

CASSETTA DIVISORIO PER CASSETTA EURO BOX - DIM. INGOMBRO (mm): L=550 P=87 H=110



ART.	partizione	dim. utili			L	colore	€
		L mm	P mm	H mm			
FAXEB64S0047137	1/4	544	81	105	4,6	■	11,47

CASSETTA DIVISORIO PER CASSETTA EURO BOX - DIM. INGOMBRO (mm): L=137 P=174 H=110



ART.	partizione	dim. utili			L	colore	€
		L mm	P mm	H mm			
FAXEB64S0085137	1/8	131	168	105	2,3	■	4,03

CASSETTA DIVISORIO PER CASSETTA EURO BOX - DIM. INGOMBRO (mm): L=137 P=87 H=110



ART.	partizione	dim. utili			L	colore	€
		L mm	P mm	H mm			
FAXEB64S0165137	1/16	132	82	105	1,1	■	2,79

CASSETTA DIVISORIO PER CASSETTA EURO BOX - DIM. INGOMBRO (mm): L=274 P=350 H=110



ART.	partizione	dim. utili			L	colore	€
		L mm	P mm	H mm			
FAXEB64S1025137	1/2	268	344	105	9,7	■	11,47

CASSETTA DIVISORIO PER CASSETTA EURO BOX - DIM. INGOMBRO (mm): L=274 P=174 H=110



ART.	partizione	dim. utili			L	colore	€
		L mm	P mm	H mm			
FAXEB64S1045137	1/4	268	168	105	4,7	■	6,20

CASSETTA DIVISORIO PER CASSETTA EURO BOX - DIM. INGOMBRO (mm): L=274 P=87 H=110



ART.	partizione	dim. utili			L	colore	€
		L mm	P mm	H mm			
FAXEB64S1085137	1/8	268	82	105	2,3	■	4,96

PORTA ETICHETTE PER CASSETTA DIVISORIO



ART.	L mm	P mm	H mm	€
FAXEB00PE010096	74	9	104	7,44



FONDO MODULARE







MANIGLIE APERTE





CAPACITÀ





CARRELLO CON RUOTE PER CASSETTA EURO BOX 600X400

ART.	L mm	P mm	H mm	KG	colore	€
 FAXEB64R0006103	620	420	170	250		86,80
 FAXEB64R0006104	620	420	170	250		86,80

DIVISORIO A PETTINE IN POLIPROPILENE PER CASSETTA EURO BOX 600X400

ART.	L mm	P mm	H mm	colore	€
 FAXEB4D10005137	352	4	100		1,55

DIVISORIO A PETTINE IN POLIPROPILENE PER CASSETTA EURO BOX 600X400

ART.	L mm	P mm	H mm	colore	€
 FAXEB6D10005137	552	4	100		1,86

I divisori a pettine hanno un sistema di installazione ad incastro per una suddivisione modulare e flessibile dell'interno della cassetta.



CLIP PORTA ETICHETTE PER CASSETTA EURO BOX

ART.	L mm	P mm	H mm	finitura	€
 FAXEB00PE000099	84	13	20	Zincato	1,55

Il porta etichette è installato sulle nervature della cassetta.



GANCIO A SCATTO PER COPERCHIO EURO BOX

ART.	L mm	P mm	H mm	€
 FAXEBSCC0000013	32	8	26	0,31

Inserita nei fori del coperchio e del bordo della cassetta, blocca il coperchio evitandone l'apertura accidentale.





PORTATA



ZINCATO

CLASSIC

400x300 mm



COPERCHIO ESD A CERNIERA

ART.	L mm	P mm	H mm	colore	€
FAXEB43C0005207	400	300	22		6,51



CASSETTA ESD CON FONDO LISCIO - DIM. INGOMBRO (mm): L=400 P=300 H=220

ART.	mis.	dim. utili				colore	€
		L mm	P mm	H mm			
FAXEB4322L05207	4322	358	258	217	19,9		21,39



600x400 mm



COPERCHIO ESD A CERNIERA

ART.	L mm	P mm	H mm	colore	€
FAXEB64C0005207	600	400	22		12,40



CASSETTA ESD CON FONDO LISCIO - DIM. INGOMBRO (mm): L=600 P=400 H=75

ART.	mis.	dim. utili				colore	€
		L mm	P mm	H mm			
FAXEB6408L05207	6408	555	355	72	14,2		21,08



CASSETTA ESD CON FONDO LISCIO - DIM. INGOMBRO (mm): L=600 P=400 H=120

ART.	mis.	dim. utili				colore	€
		L mm	P mm	H mm			
FAXEB6412L15207	6412	555	358	115	22,8		25,11



CASSETTA ESD CON FONDO LISCIO - DIM. INGOMBRO (mm): L=600 P=400 H=220

ART.	mis.	dim. utili				colore	€
		L mm	P mm	H mm			
FAXEB6422L05207	6422	555	358	217	43,1		39,99



ACCESSORI

CARRELLO ESD CON RUOTE PER CASSETTA EURO BOX 600X400



ART.	L mm	P mm	H mm	KG	colore	€
FAXEB64R0006207	620	420	170	250	■	248,00



GANCIO A SCORRIMENTO IN POLIPROPILENE CONDUTTIVO PER COPERCHIO EURO BOX



ART.	L mm	P mm	H mm	€
FAXEBSMC0005207	44	9	24	0,31



CASSETTIERE PER MINUTERIA

VISUAL BOX CLASSIC



Visual Box è il sistema modulare di **cassettiere portaminuteria** caratterizzato da cassette trasparenti con **apertura basculante**. Ogni cassetta è composta da due elementi: un robusto e resistente corpo in polistirolo e un numero variabile di cassette infrangibili in copolimero di stirene trasparente. La trasparenza e la modalità di apertura di quest'ultimi **agevola la visione e l'estrazione del contenuto stoccato**. Indipendentemente dal numero di cassette scelte, i diversi modelli di Visual Box presentano la medesima larghezza per poterli **sovrapporre** e creare magazzini portaminuteria modulari ed espandibili in qualsiasi momento. Queste soluzioni sono integrabili in numerosi arredi, quali banchi o bracci estensibili, oppure possono essere installate su telai per creare scaffali portaminuteria da parete.

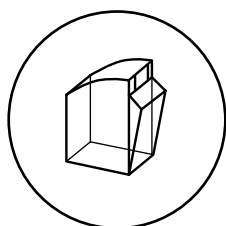

**CASSETTI
TRASPARENTI CON
APERTURA
BASCULANTE**

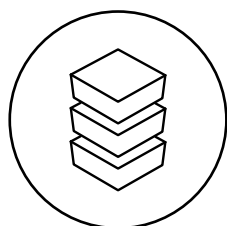

**SOVRAPPONIBILE
E COMPATIBILE**

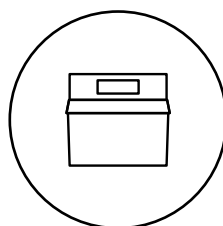

**ETICHETTE DI
SERIE**

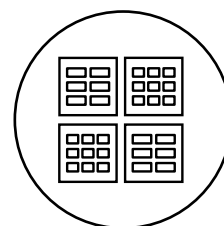

MODULARE

CLASSIC



VISUAL BOX

Le cassettiere portaminuteria con cassetti con apertura basculante sono caratterizzati da:

1. Cassetto trasparente
2. Apertura basculante
3. Porta etichette con etichette
4. Gancio per sovrapposizione



ALTA VISIBILITÀ

I cassetti in copolimero di stirene trasparente sono infrangibili e facilitano la visione e l'identificazione del contenuto di ogni Visual Box.



MANIGLIA CON ETICHETTE

Tutti i cassetti dispongono di un portaetichetta nella parte superiore per catalogare il contenuto. Frontalmente è presente una maniglia per l'apertura ergonomica del cassetto.



TELAJ PER VISUAL BOX

I telai per Visual Box da 500 mm di altezza sono sovrapponibili tramite un apposito sistema di incastro brevettato per creare magazzini modulari alti massimo 2000 mm su cui organizzare le diverse cassettiere Visual Box.



SOVRAPPONIBILITÀ

Il gancio installato nella parte superiore di Visual Box consente di sovrapporre ogni modulo in modo stabile e sicuro.

In caso di sovrapposizione di Visual Box con profondità diverse, l'installazione della cassettiere con profondità inferiore può avvenire frontalmente o posteriormente.



CASSETTIERA VISUAL BOX CON 9 CASSETTI

DIM. INGOMBRO (mm): L=600 P=68 H=78



ART.	multiplo d'ordine	cassetti				colore	€
		n.	L mm	P mm	H mm		
FAXVBCH00900001	1	9	56	43	47		12,40

CASSETTIERA VISUAL BOX CON 6 CASSETTI

DIM. INGOMBRO (mm): L=600 P=96 H=112



ART.	multiplo d'ordine	cassetti				colore	€
		n.	L mm	P mm	H mm		
FAXVBCH00600001	1	6	88	65	70		14,57

CASSETTIERA VISUAL BOX CON 5 CASSETTI

DIM. INGOMBRO (mm): L=600 P=140 H=168



ART.	multiplo d'ordine	cassetti				colore	€
		n.	L mm	P mm	H mm		
FAXVBCH00500001	1	5	108	98	107		23,25

CASSETTIERA VISUAL BOX CON 4 CASSETTI

DIM. INGOMBRO (mm): L=600 P=178 H=206



ART.	multiplo d'ordine	cassetti				colore	€
		n.	L mm	P mm	H mm		
FAXVBCH00400001	1	4	138	127	134		32,24

CASSETTIERA VISUAL BOX CON 3 CASSETTI

DIM. INGOMBRO (mm): L=600 P=210 H=242



ART.	multiplo d'ordine	cassetti				colore	€
		n.	L mm	P mm	H mm		
FAXVBCH00300001	1	3	180	145	161		39,37

FERMO PER CASSETTIERA VISUAL BOX

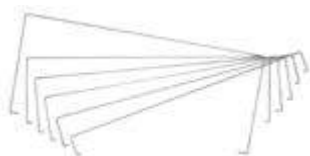

ART.	adatto per	€
FAXVBCHL0900099	FAXVBCH009000	1,86
FAXVBCHL0600099	FAXVBCH006000	1,86
FAXVBCHL0500099	FAXVBCH005000	1,86
FAXVBCHL0400099	FAXVBCH004000	1,86
FAXVBCHL0300099	FAXVBCH003000	1,86

COMPONENTI



TELAIO DA PARETE PER CASSETTIERE VISUAL BOX

ART.	L mm	P mm	H mm	materiale	€
FVB100TEL0000	602	22	1000	Alluminio	58,90
FVB150TEL0000	602	22	1500	Alluminio	66,65
FVB200TEL0000	602	22	2000	Alluminio	76,88



BASE PER SCAFFALE VISUAL BOX

ART.	L mm	P mm	H mm	RAL	€
FVB100BAS0001	604	322	100	7000	38,13



TELAIO MODULARE E SOVRAPPONIBILE PER CASSETTIERE VISUAL BOX

ART.	L mm	P mm	H mm	materiale	€
FVB050TEL0000	602	22	500	Alluminio	31,00

ART. FVB050TEL0000 x2
H= 1000



ART. FVB050TEL0000 x3
H= 1500



ART. FVB050TEL0000 x4
H= 2000



TRAVERSO DA PARETE CON FERMO VISUAL BOX

ART.	L mm	P mm	H mm	finitura	€
FVB090TRA0099	601	42	88	Zincato	10,54

Consente il fissaggio sospeso da terra degli scaffali con altezza 500 e 1000 mm.



CLASSIC

H= 500 mm

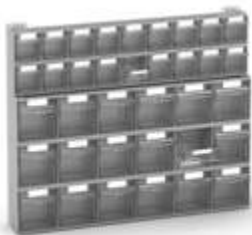

SCAFFALE CON 36 CASSETTI VISUAL BOX
 DIM. INGOMBRO (mm): L=602 P=114 H=500

ART.	descrizione	colore	€
FVB00101	1 x FVB050TEL0000 2 x FAXVBCH00900001 3 x FAXVBCH00600001		102,61



SCAFFALE CON 23 CASSETTI VISUAL BOX
 DIM. INGOMBRO (mm): L=602 P=157 H=500

ART.	descrizione	colore	€
FVB00201	1 x FVB050TEL0000 3 x FAXVBCH00600001 1 x FAXVBCH00500001		100,75



SCAFFALE CON 15 CASSETTI VISUAL BOX
 DIM. INGOMBRO (mm): L=602 P=157 H=500

ART.	descrizione	colore	€
FVB00301	1 x FVB050TEL0000 3 x FAXVBCH00500001		103,54



SCAFFALE CON 17 CASSETTI VISUAL BOX
 DIM. INGOMBRO (mm): L=602 P=190 H=500

ART.	descrizione	colore	€
FVB00401	1 x FVB050TEL0000 1 x FAXVBCH00900001 2 x FAXVBCH00400001		110,98



SCAFFALE CON 6 CASSETTI VISUAL BOX
 DIM. INGOMBRO (mm): L=602 P=225 H=500

ART.	descrizione	colore	€
FVB00501	1 x FVB050TEL0000 2 x FAXVBCH00300001		112,84

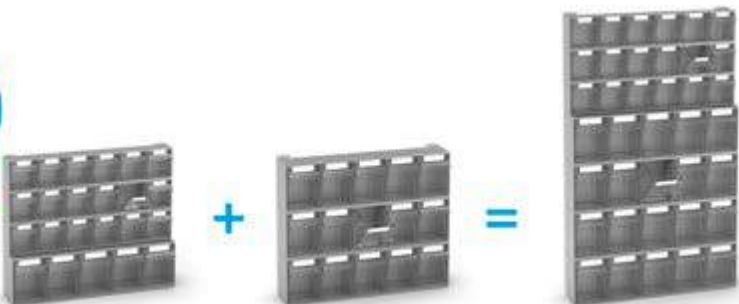

Gli scaffali da 500 mm di altezza sono sovrapponibili per creare strutture con altezza variabile (1000, 1500 o 2000 mm).

H= 1000 mm

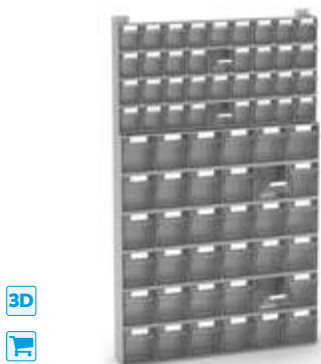

SCAFFALE CON 72 CASSETTI VISUAL BOX
DIM. (mm): L=602 P=114 H=1000

ART.	descrizione	€
VISUAL001	2 x FVB00101	205,22

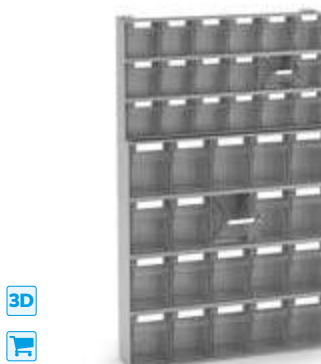

SCAFFALE CON 38 CASSETTI VISUAL BOX
DIM. (mm): L=602 P=157 H=1000

ART.	descrizione	€
VISUAL002	1 x FVB00201 1 x FVB00301	204,29

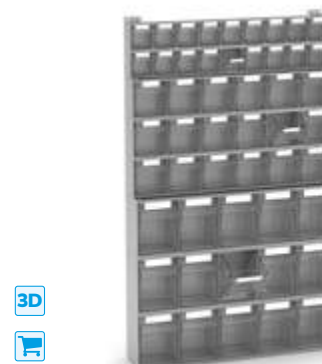

SCAFFALE CON 51 CASSETTI VISUAL BOX
DIM. (mm): L=602 P=157 H=1000

ART.	descrizione	€
VISUAL003	1 x FVB00101 1 x FVB00301	206,15

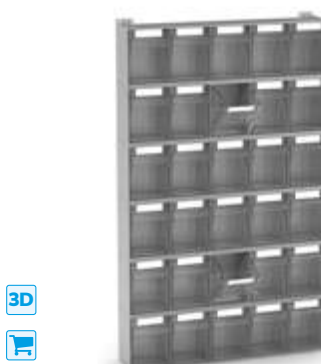

SCAFFALE CON 30 CASSETTI VISUAL BOX
DIM. (mm): L=602 P=157 H=1000

ART.	descrizione	€
VISUAL004	2 x FVB00301	207,08

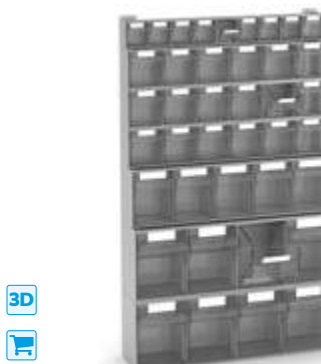

SCAFFALE CON 40 CASSETTI VISUAL BOX
DIM. (mm): L=602 P=190 H=1000

ART.	descrizione	€
VISUAL005	1 x FVB00201 1 x FVB00401	211,73

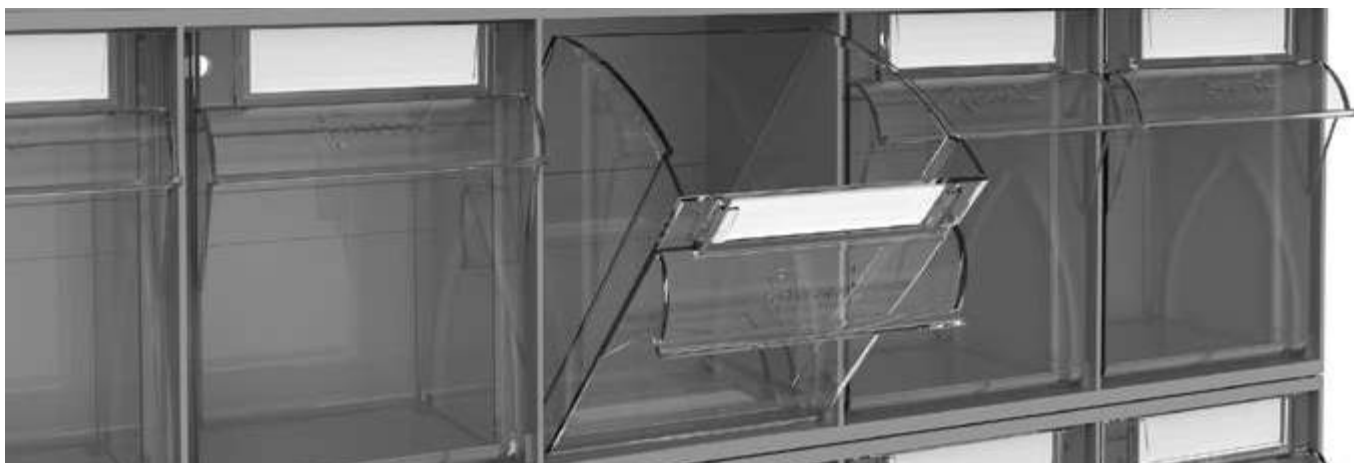

H= 1500 mm

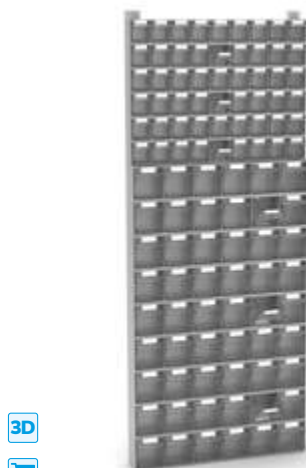

SCAFFALE CON 108 CASSETTI VISUAL BOX
DIM. (mm): L=602 P=114 H=1500

ART.	descrizione	€
VISUAL006	3 x FVB00101	307,83



SCAFFALE CON 87 CASSETTI VISUAL BOX
DIM. (mm): L=602 P=157 H=1500

ART.	descrizione	€
VISUAL007	2 x FVB00101 1 x FVB00301	308,76



SCAFFALE CON 45 CASSETTI VISUAL BOX
DIM. (mm): L=602 P=157 H=1500

ART.	descrizione	€
VISUAL008	3 x FVB00301	310,62

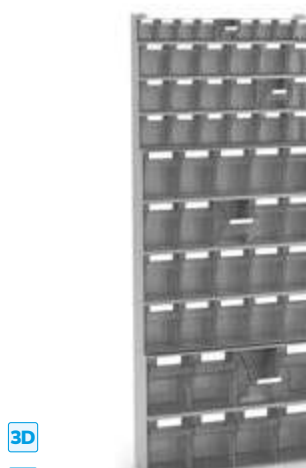

SCAFFALE CON 55 CASSETTI VISUAL BOX
DIM. (mm): L=602 P=190 H=1500

ART.	descrizione	€
VISUAL009	1 x FVB00201 1 x FVB00301 1 x FVB00401	315,27

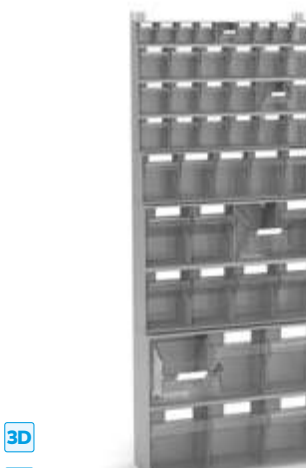

SCAFFALE CON 46 CASSETTI VISUAL BOX
DIM. (mm): L=602 P=225 H=1500

ART.	descrizione	€
VISUAL010	1 x FVB00201 1 x FVB00401 1 x FVB00501	324,57



H= 2000 mm



SCAFFALE CON 144 CASSETTI VISUAL BOX
DIM. (mm): L=602 P=114 H=2000

ART.	descrizione	€
VISUAL011	4 x FVB00101	410,44



SCAFFALE CON 102 CASSETTI VISUAL BOX
DIM. (mm): L=602 P=157 H=2000

ART.	descrizione	€
VISUAL012	2 x FVB00101 2 x FVB00301	412,30



SCAFFALE CON 60 CASSETTI VISUAL BOX
DIM. (mm): L=602 P=157 H=2000

ART.	descrizione	€
VISUAL013	4 x FVB00301	414,16

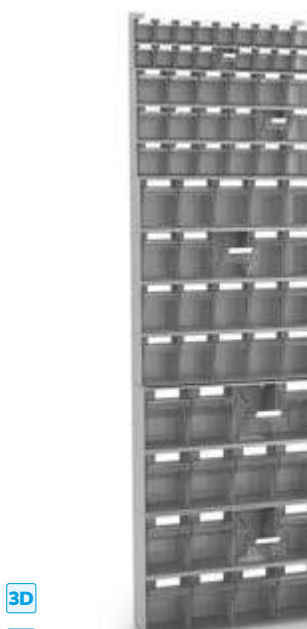

SCAFFALE CON 72 CASSETTI VISUAL BOX
DIM. (mm): L=602 P=190 H=2000

ART.	descrizione	€
VISUAL014	1 x FVB00201 1 x FVB00301 2 x FVB00401	426,25

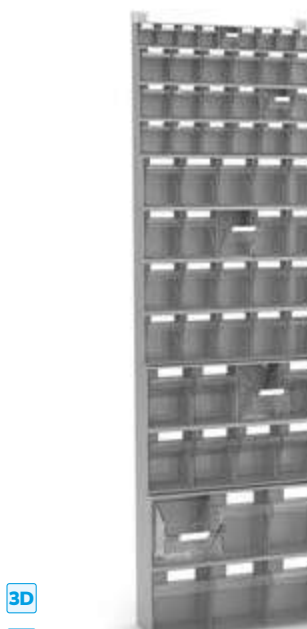

SCAFFALE CON 61 CASSETTI VISUAL BOX
DIM. (mm): L=602 P=225 H=2000

ART.	descrizione	€
VISUAL015	1 x FVB00201 1 x FVB00301 1 x FVB00401 1 x FVB00501	428,11



Scaffali composti da 4 telai da 500 mm di altezza sovrapposti tramite incastro brevettato.

H= 1500 mm

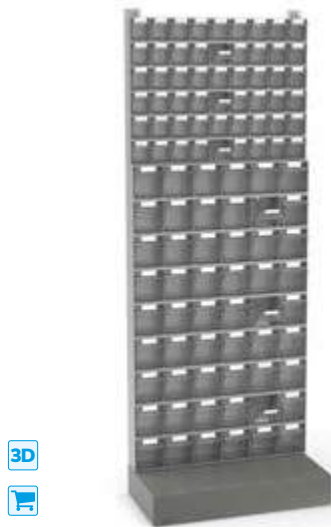

SCAFFALE CON 108 CASSETTI VISUAL BOX
DIM. (mm): L=604 P=322 H=1600

ART.	descrizione	€
VISUAL016	3 x FVB00101 1 x FVB100BAS0001	345,96



SCAFFALE CON 87 CASSETTI VISUAL BOX
DIM. (mm): L=604 P=322 H=1600

ART.	descrizione	€
VISUAL017	2 x FVB00101 1 x FVB00301 1 x FVB100BAS0001	346,89

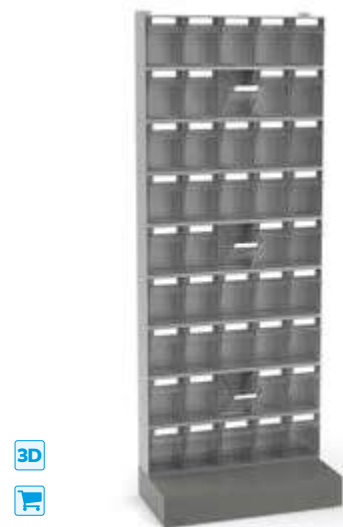

SCAFFALE CON 45 CASSETTI VISUAL BOX
DIM. (mm): L=604 P=322 H=1600

ART.	descrizione	€
VISUAL018	3 x FVB00301 1 x FVB100BAS0001	348,75



SCAFFALE CON 55 CASSETTI VISUAL BOX
DIM. (mm): L=604 P=322 H=1600

ART.	descrizione	€
VISUAL019	1 x FVB00201 1 x FVB00301 1 x FVB00401 1 x FVB100BAS0001	353,40



SCAFFALE CON 46 CASSETTI VISUAL BOX
DIM. (mm): L=604 P=322 H=1600

ART.	descrizione	€
VISUAL020	1 x FVB00201 1 x FVB00401 1 x FVB00501 1 x FVB100BAS0001	362,70



Scaffali composti da base e 3 telai da 500 mm di altezza sovrapposti tramite incastro brevettato.

H= 2000 mm



SCAFFALE CON 144 CASSETTI VISUAL BOX
DIM. (mm): L=604 P=322 H=2100

ART.	descrizione	€
VISUAL021	4 x FVB00101 1 x FVB100BAS0001	448,57

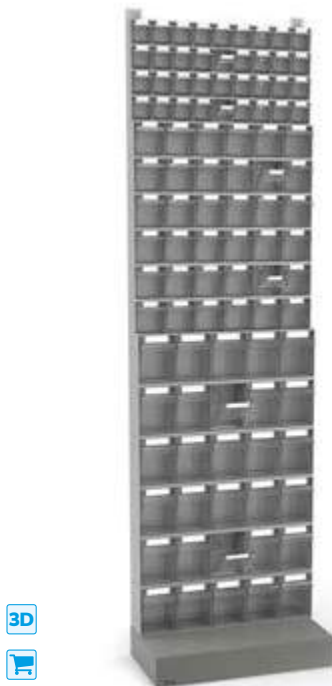

SCAFFALE CON 102 CASSETTI VISUAL BOX
DIM. (mm): L=604 P=322 H=2100

ART.	descrizione	€
VISUAL022	2 x FVB00101 2 x FVB00301 1 x FVB100BAS0001	450,43

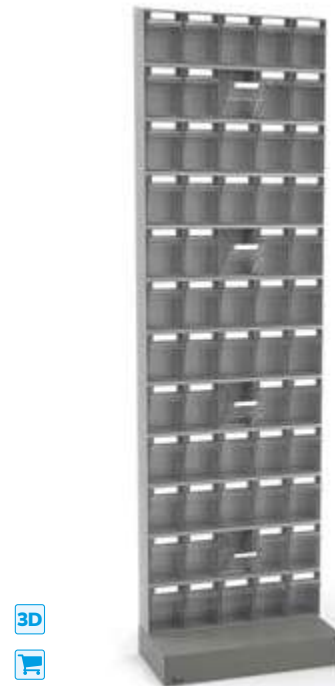

SCAFFALE CON 60 CASSETTI VISUAL BOX
DIM. (mm): L=604 P=322 H=2100

ART.	descrizione	€
VISUAL023	4 x FVB00301 1 x FVB100BAS0001	452,29



SCAFFALE CON 72 CASSETTI VISUAL BOX
DIM. (mm): L=604 P=322 H=2100

ART.	descrizione	€
VISUAL024	1 x FVB00201 1 x FVB00301 2 x FVB00401 1 x FVB100BAS0001	464,38



SCAFFALE CON 61 CASSETTI VISUAL BOX
DIM. (mm): L=604 P=322 H=2100

ART.	descrizione	€
VISUAL025	1 x FVB00201 1 x FVB00301 1 x FVB00401 1 x FVB00501 1 x FVB100BAS0001	466,24



Scaffali composti da base e 4 telai da 500 mm di altezza sovrapposti tramite incastro brevettato.

TAPPETI ANTISCIVOLO

MAT CLASSIC



I tappeti MAT contribuiscono ad **incrementare l'efficienza e la sicurezza** sul luogo di lavoro. La particolare trama della superficie, infatti, aumenta l'attrito durante la camminata o il lavoro evitando possibili cadute o infortuni. L'aggiunta di **raccordi ed angoli** crea una rampa che riduce il pericolo di inciampo ed agevola la salita e discesa anche nel caso in cui siano impiegati arredi su ruote come carrelli o cassettiere.

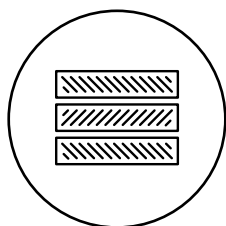

**TRAMA
ANTISDRUCCIOLO**

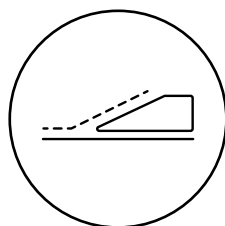

**SALITA/DISCESA
SICURA**

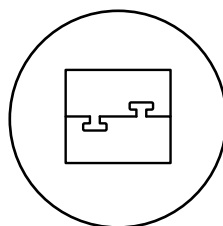

INCASTRO FACILE

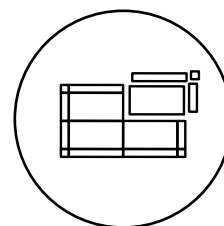

MODULARE

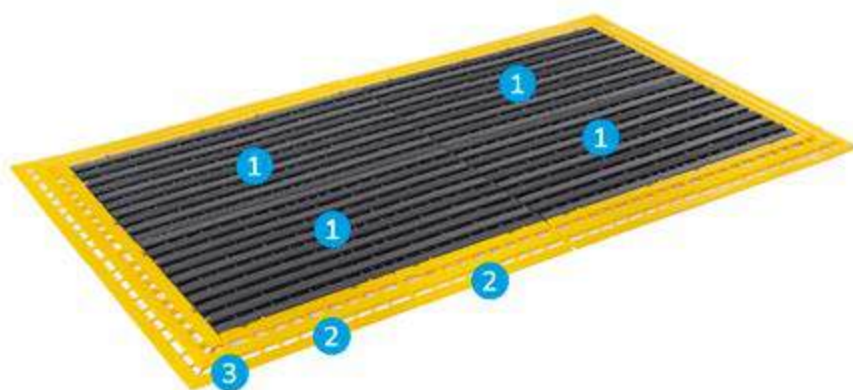

MAT

I tappeti antisdrucciolo sono caratterizzati da:

1. Tappeto antisdrucciolo
2. Raccordo per tappeto
3. Angolo per tappeto

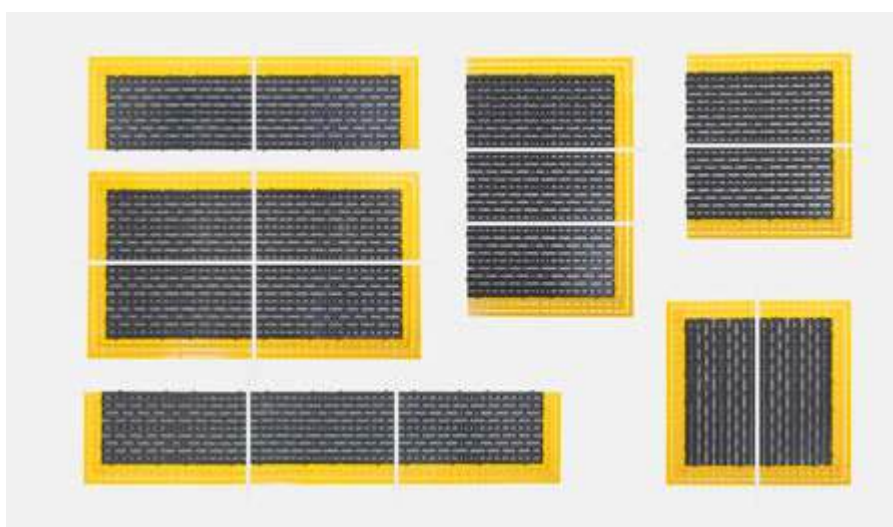



SISTEMA MODULARE

Ogni tappeto antisdrucciolo è dotato di appositi inserti lungo tutto il perimetro per garantire massima libertà nell'unione di più componenti. È possibile così ottenere tappeti di diverse forme e ampiezze, facili da adattare allo spazio a disposizione.





TAPPETO ANTISDRUCCILO IN POLIETILENE

ART.	multiplo d'ordine	L mm	P mm	H mm	colore	€
 FAXBRTA80400039	4	800	400	25		17,98





RACCORDO PER TAPPETO IN POLIETILENE

ART.	multiplo d'ordine	L mm	P mm	H mm	colore	€
 FAXBRRA40010005	12	400	110	25		3,72



ANGOLO PER TAPPETO IN POLIETILENE

ART.	multiplo d'ordine	L mm	P mm	H mm	colore	€
 FAXBRAN01010005	10	110	110	25		1,86

CONTENITORI INDUSTRIALI

CASSONI IN PLASTICA



I cassoni in plastica contribuiscono al miglioramento delle operazioni di immagazzinaggio, rendendo sempre più efficienti e sicuri i processi di stoccaggio e trasporto. Queste soluzioni, infatti, garantiscono un elevato volume di contenimento e, a seconda del modello, possono essere impiegati per la custodia di semilavorati e merci pericolose in regime di ADR. Realizzati in **polietilene ad alta densità (PE-HD)** presentano un'elevata resistenza agli urti, agli sbalzi termici e ai raggi ultravioletti e sono movimentabili con transpallet e carrelli elevatori. I container sono **sovrapponibili** e accessoriabili con ruote, traverse e coperchi.



**MOVIMENTABILE CON
CARRELLO
ELEVATORE**

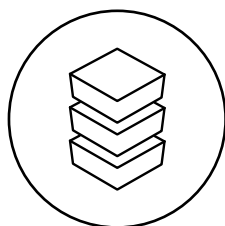

SOVRAPPONIBILE

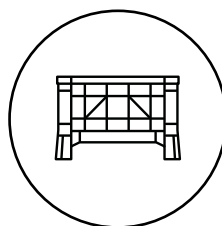

**POLIETILENE AD ALTA
DENSITÀ
PE-HD**



ACCESSORIABILE

CASSONI IN PLASTICA

1200x1000 mm



CONTENITORE ADR CON COPERCHIO - OMOLOGATO 11H2/Y

ART.	L mm	P mm	H mm	KG	€
FAX1091B3Y00001	1200	1000	830	360	488,25

⚠ N. pezzi max sovrapponibili: 4 (portata statica max. 1388 kg)



KG
PORTATA

CASSONI IN PLASTICA

1040x640 mm

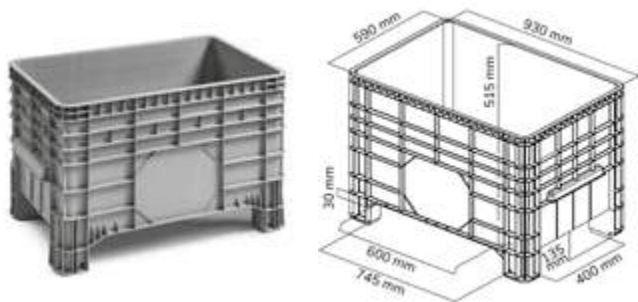

CONTENITORE SOVRAPPONIBILE

ART.	L mm	P mm	H mm	KG	€
FAX1425B0000001	1040	640	670	200	84,63

⚠ N. pezzi max sovrapponibili: 9 (portata statica max. 1800 kg)

CONTENITORE CON RUOTE

ART.	L mm	P mm	H mm	KG	€
CONT1001	1040	640	780	200	168,95



COPERCHIO PER CONTENITORE

ART.	L mm	P mm	H mm	€
FAX1CO1425BF001	1040	640	50	37,51



KITRUOTE

ART.	Ø mm	KG set ruote	H mm	materiale	🔄	€
FAX2RXBD1KR0001	100	200	185	Gomma standard	4	84,32



CASSONI IN PLASTICA

1200x800 mm

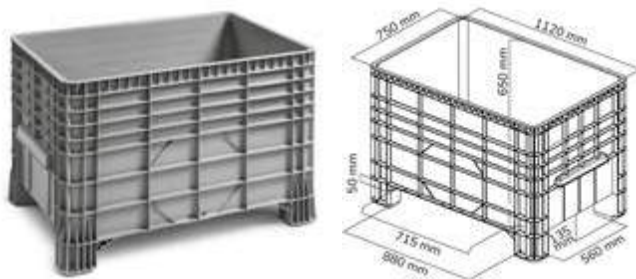

CONTENITORE SOVRAPPONIBILE

ART.	L mm	P mm	H mm	KG	€
FAX1425A0000001	1200	800	800	300	155,00

⚠ N. pezzi max sovrapponibili: 6 (portata statica max. 2000 kg)



CONTENITORE CON RUOTE

ART.	L mm	P mm	H mm	KG	€
CONT1201	1200	800	940	200	266,91



CONTENITORE CON TRAVERSE

ART.	L mm	P mm	H mm	KG	€
CONT1202	1200	800	800	200	188,48



COPERCHIO PER CONTENITORE

ART.	L mm	P mm	H mm	€
FAX1CO142500001	1215	815	70	52,70



TRAVERSA PER CONTENITORE

ART.	L mm	P mm	H mm	KG	€
FAX1TRAVXAN0007	1140	105	120	150	16,74



KIT RUOTE

ART.	Ø mm	KG set ruote	H mm	materiale	☞ sx	☞ dx	€
FAX2RA125KR0001	125	200	228	Gomma standard	2	2	111,91



PORTATA



RUOTA GIREVOLE

CASSETTE E CONTENITORI METALLICI

STEEL



Le **cassette e i contenitori in metallo** hanno una struttura solida per poter trasportare e contenere minuteria e componenti pesanti. Fianchi e fondo, infatti, presentano apposite **nerature** che irrobustiscono l'intero contenitore e garantiscono **resistenza a usi intensivi, urti e carichi pesanti**. Steel presenta **cassette e contenitori a bocca di lupo** di dimensioni contenute per l'organizzazione di componentistica su postazioni di lavoro o in magazzino oppure **caissoni in metallo con fondo apribile o a bocca di lupo di grandi dimensioni** per la gestione degli scarti e dei semilavorati. Le **cassette** sono disponibili anche nella versione **forata**, in **acciaio inox** o **zincato**, ideali per il lavaggio di componenti e materiali.

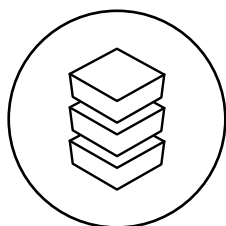

SOVRAPPONIBILE

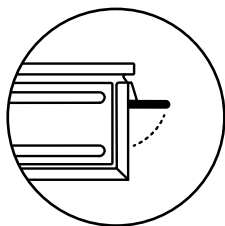

MANIGLIA BLOCCO
A 90°

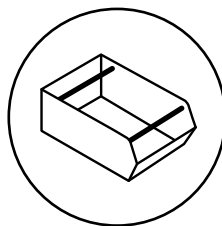

TRAVERSINO DI
SOLLEVAMENTO

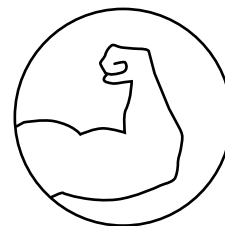

ROBUSTI

STEEL

CASSETTE E CONTENITORI



272-4

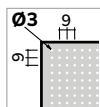

272-4

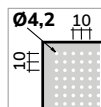

272-4

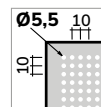

272-4

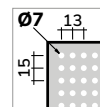

ART.	multiplo d'ordine	mis.	Ø mm	dim. ingombro			dim. utili			L	finitura	€
				Lmm	P mm	Hmm	Lmm	P mm	H mm			
FLA65100AZZ	6	272-4	3	480	315	200	450	300	185	27	Inox	74,40
FLA65110A99	6	272-4	4,2	480	315	200	450	300	185	27	Zincato	44,95
FLA65120A99	6	272-4	5,5	480	315	200	450	300	185	27	Zincato	44,95
FLA65130A99	6	272-4	7	480	315	200	450	300	185	27	Zincato	44,95



272-4

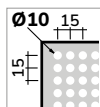

272-4

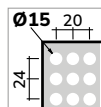

272-4A2

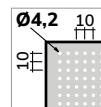

272-4A2

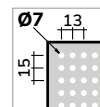

ART.	multiplo d'ordine	mis.	Ø mm	dim. ingombro			dim. utili			L	finitura	€
				Lmm	P mm	Hmm	Lmm	P mm	H mm			
FLA65150A99	6	272-4	10	480	315	200	450	300	185	27	Zincato	44,95
FLA65170A99	6	272-4	15	480	315	200	450	300	185	27	Zincato	44,95
FLA57110A99	12	272-4A2	4,2	480	315	105	450	300	85	11,3	Zincato	62,93
FLA57130A99	12	272-4A2	7	480	315	105	450	300	85	11,3	Zincato	62,93



272-3

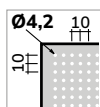

ART.	multiplo d'ordine	mis.	Ø mm	dim. ingombro			dim. utili			L	finitura	€
				Lmm	P mm	Hmm	Lmm	P mm	H mm			
FLA41110A99	8	272-3	4,2	325	210	200	300	200	185	12	Zincato	38,13

CAPACITÀ

ZINCATO

INOX

STEEL

CASSETTE E CONTENITORI



272-3A2



272-3



272-4



272-4A5



272-5

ART.	multiplo d'ordine	mis.	dim. ingombro			dim. utili			L	RAL	€
			L mm	P mm	H mm	L mm	P mm	H mm			
FLA33200A01	10	272-3A2	325	210	145	300	200	130	8,7	7000	24,18
FLA41200A01	8	272-3	325	210	200	300	200	185	12	7000	25,42
FLA65200A01	6	272-4	480	315	200	450	300	185	27	7000	29,14
FLA73200A01	4	272-4A5	480	315	300	450	300	280	40,5	7000	47,12
FLA89200A01	6	272-5	660	480	300	630	450	280	85	7000	71,92



STEEL

CASSETTE E CONTENITORI



272-3A2



272-3



272-4



272-4A5



272-5

ART.	multiplo d'ordine	mis.	dim. ingombro			dim. utili			L	finitura	€
			L mm	P mm	H mm	L mm	P mm	H mm			
FLA33200A99	10	272-3A2	325	210	145	300	200	130	8,7	Zincato	28,52
FLA41200A99	8	272-3	325	210	200	300	200	185	12	Zincato	30,07
FLA65200A99	6	272-4	480	315	200	450	300	185	27	Zincato	38,75
FLA73200A99	4	272-4A5	480	315	300	450	300	280	40,5	Zincato	57,35
FLA89200A99	6	272-5	660	480	300	630	450	280	85	Zincato	116,25



CAPACITÀ

RAL 7000

ZINCATO

STEEL

CASSETTE E CONTENITORI



1



2



3A2



4A2

ART.	multiplo d'ordine	mis.	dim. ingombro			dim. utili			L	RAL	€
			L mm	P mm	H mm	L mm	P mm	H mm			
FLS17000A01	20	1	105	165	75	95	140	65	1	7000	5,89
FLS25000A01	20	2	150	235	125	140	195	115	3,8	7000	9,92
FLS33000A01	10	3A2	210	350	145	195	300	135	9,4	7000	20,46
FLS57000A01	8	4A2	310	500	145	300	450	135	20	7000	31,62



3



3P4



4



4A5

ART.	multiplo d'ordine	mis.	dim. ingombro			dim. utili			L	RAL	€
			L mm	P mm	H mm	L mm	P mm	H mm			
FLS41000A01	8	3	210	350	200	200	300	185	12,5	7000	20,77
FLS49000A01	9	3P4	210	550	200	200	450	185	18	7000	29,14
FLS65000A01	6	4	310	510	200	300	450	185	28	7000	26,97
FLS73000A01	4	4A5	310	525	315	300	450	280	42	7000	43,09

TRAVERSINO DI SOLLEVAMENTO ABBINATO ALLA MANIGLIA BLOCCO A 90°



STEEL

CASSETTE E CONTENITORI



2



3A2



4A2

ART.	multiplo d'ordine	mis.	dim. ingombro			dim. utili			L	finitura	€
			L mm	P mm	H mm	L mm	P mm	H mm			
FLS25000A99	20	2	150	235	125	140	195	115	3,8	Zincato	15,19
FLS33000A99	10	3A2	210	350	145	195	300	135	9,4	Zincato	25,11
FLS57000A99	8	4A2	310	500	145	300	450	135	20	Zincato	38,13



3



3P4



4



4A5

ART.	multiplo d'ordine	mis.	dim. ingombro			dim. utili			L	finitura	€
			L mm	P mm	H mm	L mm	P mm	H mm			
FLS41000A99	8	3	210	350	200	200	300	185	12,5	Zincato	25,42
FLS49000A99	9	3P4	210	550	200	200	450	185	18	Zincato	36,89
FLS65000A99	6	4	310	510	200	300	450	185	28	Zincato	37,20
FLS73000A99	4	4A5	310	525	315	300	450	280	42	Zincato	57,04

DIVISORIO LONGITUDINALE

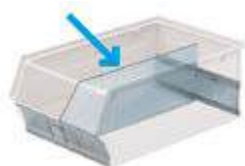

ART.	multiplo d'ordine	mis.	finitura	€
FND01300299	8	3	Zincato	9,92
FND01900299	6	4	Zincato	13,64
FND02210399	4	4A5/5P4	Zincato	16,74
FND02410299	4	5	Zincato	20,46

COPPIA SUPPORTI PER DIVISORI



ART.	multiplo d'ordine	mis.	finitura	€
FND05200299	8	3	Zincato	4,96
FND05400399	6	4	Zincato	5,58
FND05500199	4	4A5	Zincato	7,75
FND05900199	4	5/5P4	Zincato	12,40

CAPACITÀ

RAL 7000

ZINCATO

STEEL

CASSETTE E CONTENITORI



5P4



5



5P4



5

ART.	multiplo d'ordine	mis.	dim. ingombro			dim. utili			n. slitte	L	RAL	€
			L mm	P mm	H mm	L mm	P mm	H mm				
FLS81000A01	6	5P4	480	540	300	450	450	280	-	63	7000	57,66
FLS89000A01	6	5	480	725	295	450	630	280	-	88	7000	60,76
FLS81100A01	4	5P4	480	540	385	450	450	280	2	63	7000	86,18
FLS89100A01	4	5	480	725	385	450	630	280	2	88	7000	87,42



4



4A5



5P4



5

ART.	multiplo d'ordine	mis.	dim. ingombro			dim. utili			L	RAL	€
			L mm	P mm	H mm	L mm	P mm	H mm			
FLS65010A01	6	4	310	510	200	300	450	185	28	7000	35,65
FLS73010A01	4	4A5	310	525	315	300	450	280	42	7000	53,32
FLS81010A01	6	5P4	480	540	300	450	450	280	63	7000	70,99
FLS89010A01	6	5	480	725	295	450	630	280	88	7000	73,78

APPLICAZIONI SPECIALI

CONTENITORI CON DOPPIO TRAVERSINO

CONTENITORI CON SLITTA

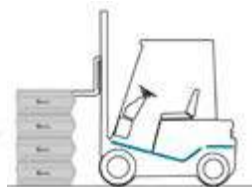

sistema di prelevamento con carrello elevatore



sistema di prelevamento con carrello elevatore

STEEL

CASSETTE E CONTENITORI



5P4



5



5P4



5

ART.	multiplo d'ordine	mis.	dim. ingombro			dim. utili			n. slitte	L	finitura	€
			Lmm	Pmm	Hmm	Lmm	Pmm	Hmm				
FLS81000A99	6	5P4	480	540	300	450	450	280	-	63	Zincato	79,36
FLS89000A99	6	5	480	725	295	450	630	280	-	88	Zincato	85,87
FLS81100A99	4	5P4	480	540	385	450	450	280	2	63	Zincato	115,63
FLS89100A99	4	5	480	725	385	450	630	280	2	88	Zincato	121,21



4



4A5



5P4



5

ART.	multiplo d'ordine	mis.	dim. ingombro			dim. utili			L	finitura	€
			Lmm	Pmm	Hmm	Lmm	Pmm	Hmm			
FLS65010A99	6	4	310	510	200	300	450	185	28	Zincato	46,19
FLS73010A99	4	4A5	310	525	315	300	450	280	42	Zincato	67,27
FLS81010A99	6	5P4	480	540	300	450	450	280	63	Zincato	93,31
FLS89010A99	6	5	480	725	295	450	630	280	88	Zincato	97,34



CAPACITÀ



RAL 7000



ZINCATO

STEEL

CONTENITORI FONDO APRIBILE



CONTAINER CON FONDO APRIBILE A RULLI

ART.	Lmm	Pmm	Hmm	KG	RAL	€
 FML01210001	1095	865	1265	2000	7000	1023,00

CONTAINER CON FONDO APRIBILE A RULLI

ART.	Lmm	Pmm	Hmm	KG	RAL	€
 FML01110001	1095	865	915	2000	7000	922,87

CONTAINERS CON FONDO APRIBILE A RULLI

Sollevati con carrello elevatore tramite le quattro maniglie saldate al bordo superiore, consentono di scaricare il materiale per mezzo del fondo apribile a rulli (apertura dell'87%). L'apertura avviene in modo facile e sicuro tramite la leva posta sul lato da 800 mm, mentre la chiusura mediante un particolare dispositivo composto di leve e rulli d'acciaio.





STEEL

CONTENITORI BOCCA DI LUPO



CONTAINER A BOCCA DI LUPO

ART.	multiplo d'ordine	L mm	P mm	H mm		RAL	€
 FML05100A01	3	830	680	600	1000	7000	190,03

DIVISORIO MOBILE PER CONTAINER A BOCCA DI LUPO

ART.	multiplo d'ordine	adatto per	RAL	€
 FML07100001	1	FML05100A	7000	33,48



PORTATA



RAL 7000

SCAFFALATURE METALLICHE

ST



ST è una scaffalatura metallica facile da montare, solida e ad alta portata. La **struttura modulare**, disponibile in due larghezze, 1000 e 1300 mm, e altezze da 1000 a 3000 mm, consente di creare differenti configurazioni di ampiezza variabile. La versione base dello **scaffale per magazzino** con ripiani fessurati, divisori e separatori, infatti, può ampliarsi e trasformarsi fino a diventare uno **scaffale porta pneumatici**, uno **scaffale per magazzino dinamico**, con ripiani inclinati o telai inclinabili con binari e rulli, o uno **scaffale porta minuteria con contenitori**.

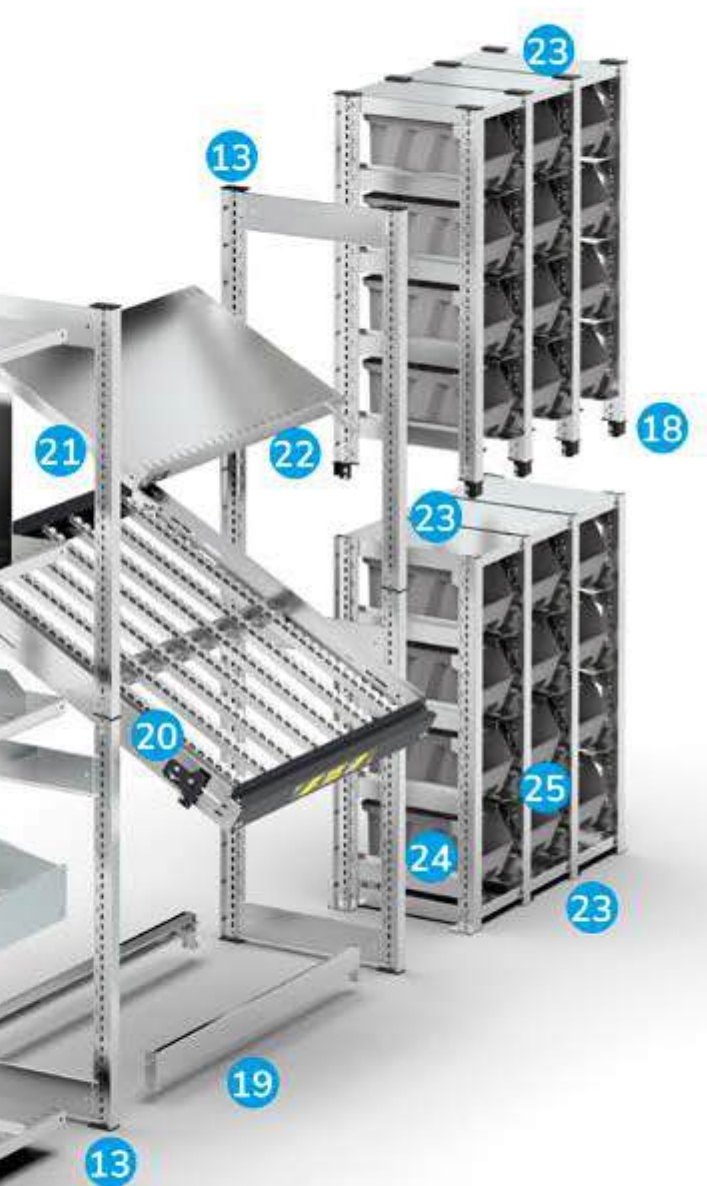

1. Montante fessurato passo 25 mm per fiancata
2. Piano fessurato (portata fino a 300 kg)
3. Parete posteriore (su richiesta)
4. Parete laterale (su richiesta)
5. Barra appendi abiti (su richiesta)
6. Cassetto ad estrazione semplice (portata 50 kg)
Cassetto ad estrazione telescopica (portata 100 kg)
7. Zoccolo (su richiesta)
8. Coppia porte a battente con chiusura a cilindro e 2 chiavi (su richiesta)
9. Parete centrale (su richiesta)
10. Traverso di collegamento per fiancate
11. Corrente L=2000 mm
Corrente L=2600 mm (su richiesta)
12. Traverso di collegamento tra scaffali (su richiesta)
13. Piedino/tappo in plastica
14. Divisori verticali (su richiesta)
15. Separatori H=100 mm
16. Set bandinelle con divisori trapezoidali
17. Separatori H=40 mm
18. Innesto in plastica per montanti
19. Coppia supporti porta pneumatici
20. Telaio ad inclinazione variabile con binari a rulli spostabili in lunghezza
21. Coppia staffe per piano inclinato (da 5° a 30° circa)
22. Bordo fermacasse
23. Piano di tenuta
24. Slitte per contenitori
25. Fermo antibaltamento per contenitori



**FACILI DA
MONTARE**

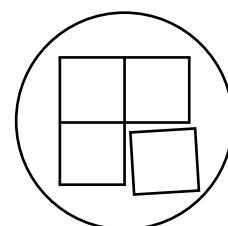

COMPONIBILI

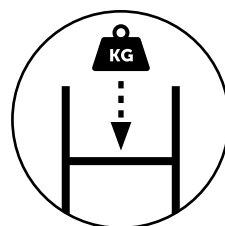

**PORTATA PIANI
FINO A 300 KG**

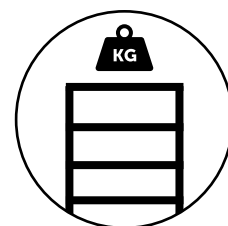

**PORTATA
CAMPATA 2300 KG**



ST





CONFIGURE

SCAFFALE CON 5 PIANI

	ART.	L mm	P mm	H mm	per piano	finitura	€
	A ST1001	1057	321	2011	120	Zincato	203,05
	A ST1002	1057	421	2011	120	Zincato	208,01
	A ST1003	1057	521	2011	120	Zincato	215,45
	A ST1004	1057	621	2011	120	Zincato	244,90
	A ST1005	1057	821	2011	120	Zincato	272,80
	B ST1006	1028	321	2011	120	Zincato	142,60
	B ST1007	1028	421	2011	120	Zincato	147,87
	B ST1008	1028	521	2011	120	Zincato	154,38
	B ST1009	1028	621	2011	120	Zincato	182,90
	B ST1010	1028	821	2011	120	Zincato	208,94



SCAFFALE CON 10 PIANI

	ART.	L mm	P mm	H mm	per piano	finitura	€
	ST2001	2071	521	2011	120	Zincato	369,83





Composto da:

qtà	descrizione
3	Kit 4 montanti
2	Kit 5 piani fessurati
3	Kit 3 traversini
3	Crociera di irrigidimento
3	Kit 2 piedini in polipropilene
3	Kit 2 innesti

CONFIGURE







KIT 5 PIANI FESSURATI

ART.	L mm	P mm	H mm	KG	finitura	€
 FST1030S199	1000	300	35	120	Zincato	82,15
 FST1040S199	1000	400	35	120	Zincato	87,73
 FST1050S199	1000	500	35	120	Zincato	93,31
 FST1060S199	1000	600	35	120	Zincato	120,90
 FST1080S199	1000	800	35	120	Zincato	145,08



PIANO FESSURATO

ART.	L mm	P mm	H mm	KG	finitura	€
 FST1030S099	1000	300	35	120	Zincato	27,59
 FST1040S099	1000	400	35	120	Zincato	27,90
 FST1050S099	1000	500	35	120	Zincato	29,45
 FST1060S099	1000	600	35	120	Zincato	31,00
 FST1080S099	1000	800	35	120	Zincato	37,51

RINFORZO PER PIANO FESSURATO

ART.	L mm	P mm	H mm	finitura	€
 FST1310S099	998	50	33	Zincato	5,89



 Un rinforzo aumenta la portata del piano fessurato a 300 kg. Non può essere installato sui piani fessurati con profondità 300 mm.

KIT 5 RINFORZI PER PIANO FESSURATO

ART.	L mm	P mm	H mm	finitura	€
 FST1310S299	998	50	33	Zincato	30,07



 Un rinforzo aumenta la portata del piano fessurato a 300 kg. Non può essere installato sui piani fessurati con profondità 300 mm.

BORDO FERMACASSE PER PIANO FESSURATO

ART.	L mm	P mm	H mm	finitura	€
 FST1410S099	972	10	60	Zincato	9,61



KIT 5 BORDI FERMACASSE PER PIANO FESSURATO

ART.	L mm	P mm	H mm	finitura	€
 FST1410S199	972	10	60	Zincato	39,99

COPPIA STAFFE PER PIANO INCLINATO

ART.	L mm	P mm	H mm	finitura	€
 FST1200S099	19	210	64	Zincato	12,09



STAFFE FISSAGGIO A MURO

ART.	L mm	P mm	H mm	finitura	€
 FST0710S199	24	20	79	Zincato	5,58



PORTATA



ZINCATO

CASSETTI AD ESTRAZIONE SEMPLICE 54X27 EH

Adatto solo per scaffali P 500 mm



ART.	dim. utili			H frontale cassetto	KG		RAL	€
	L mm	P mm	H mm					
ST1011	908	449	85	100	50	88%	7035	95,48
ST1012	908	449	85	100	50	88%	5012	111,29
ST1013	908	449	85	100	50	88%	7016	95,48

Si possono inserire massimo 6 cassetti per ogni campata e la massima altezza di inserimento è di 950 mm.

CASSETTI AD ESTRAZIONE TELESCOPICA 54X27 EH

Adatto solo per scaffali P 500 mm



ART.	dim. utili			H frontale cassetto	KG		RAL	€
	L mm	P mm	H mm					
ST1014	908	449	85	100	100	100%	7035	124,93
ST1015	908	449	85	100	100	100%	5012	139,50
ST1016	908	449	85	100	100	100%	7016	124,93
ST1017	908	449	135	150	100	100%	7035	137,33
ST1018	908	449	135	150	100	100%	5012	146,01
ST1019	908	449	135	150	100	100%	7016	137,33

Si possono inserire massimo 3 cassetti per ogni campata (oppure 6 se si riduce la portata a 50 kg) e la massima altezza di inserimento è di 950 mm.

COPPIA BANDINELLE CON DIVISORI TRAPEZOIDALI

ART.	L mm	P mm	H mm	finitura	€
ST1061	999	301	200	Zincato	32,86
ST1062	999	401	200	Zincato	33,79
ST1063	999	501	200	Zincato	34,72
ST1064	999	601	200	Zincato	35,65

COPPIA DIVISORI TRAPEZOIDALI ZINCATI AGGIUNTIVI





ART.	L mm	P mm	H mm	finitura	€
FST9630S099	16	293	187	Zincato	9,61
FST9640S099	16	393	187	Zincato	10,54
FST9650S099	16	493	187	Zincato	11,47
FST9660S099	16	593	187	Zincato	12,40

KIT 4 SEPARATORI ZINCATI PER PIANI

ART.	L mm	P mm	H mm	finitura	€
FST9230S199	39	297	100	Zincato	17,36
FST9240S199	39	397	100	Zincato	18,91
FST9250S199	39	497	100	Zincato	18,29
FST9260S199	39	597	100	Zincato	20,15
FST9280S199	39	797	100	Zincato	22,63











KIT 4 SEPARATORI ZINCATI PER PIANI

ART.	L mm	P mm	H mm	finitura	€
 FST9330S199	39	297	40	Zincato	12,40
 FST9340S199	39	397	40	Zincato	13,33
 FST9350S199	39	497	40	Zincato	14,57
 FST9360S199	39	597	40	Zincato	16,12
 FST9380S199	39	797	40	Zincato	18,29



KIT RUOTE

ART.	Ø mm	 KG set ruote	H mm	materiale	 	€
 FKRD1002107	100	225	128	Gomma standard	2 2	46,81
 FKRB1252107	125	300	155	Gomma standard	2 2	52,08
 FKRU1252101	125	300	155	Gomma antitraccia sintetica	2 2	56,73
 FKRS1252101	125	750	155	Gomma elastica	2 2	90,83

 La capacità di carico delle ruote degli scaffali ST è da intendersi come portata statica.



COPPIA PIEDINI IN ACCIAIO

ART.	L mm	P mm	H mm	€
 FVT01450000	65	68	18	1,55



COPPIA PIEDINI / TAPPI IN PLASTICA

ART.	L mm	P mm	H mm	€
 FVT02590000	42	65	55	2,48





KIT 4 PIASTRE PER RUOTE

ART.	L mm	P mm	H mm	RAL	€
 FST3600S139	105	104	52	7016	32,86



COPPIA STAFFE DI RINFORZO PER SCAFFALE SU RUOTE

ART.	L mm	P mm	H mm	RAL	€
 FST4550S139	113	520	22	7016	27,59
 FST4560S139	113	620	22	7016	31,93
 FST4580S139	113	820	22	7016	35,03



PORTATA



ESTRAZIONE



RUOTA FISSA



RUOTA GIREVOLE CON FRENO



RAL 5012



RAL 7016



RAL 7035



ZINCATO



SCAFFALE CON 6 PIANI

ART.	L mm	P mm	H mm	KG per piano	cassetti			finitura	€
					n.	KG			
A ST1020	1057	521	2011	120	1	50	88%	Zincato	451,05
B ST1021	1028	521	2011	120	1	50	88%	Zincato	389,98

Completo di 4 separatori, 2 coppie bandinelle, 4 divisori trapezoidali, 1 cassetto ad estrazione semplice

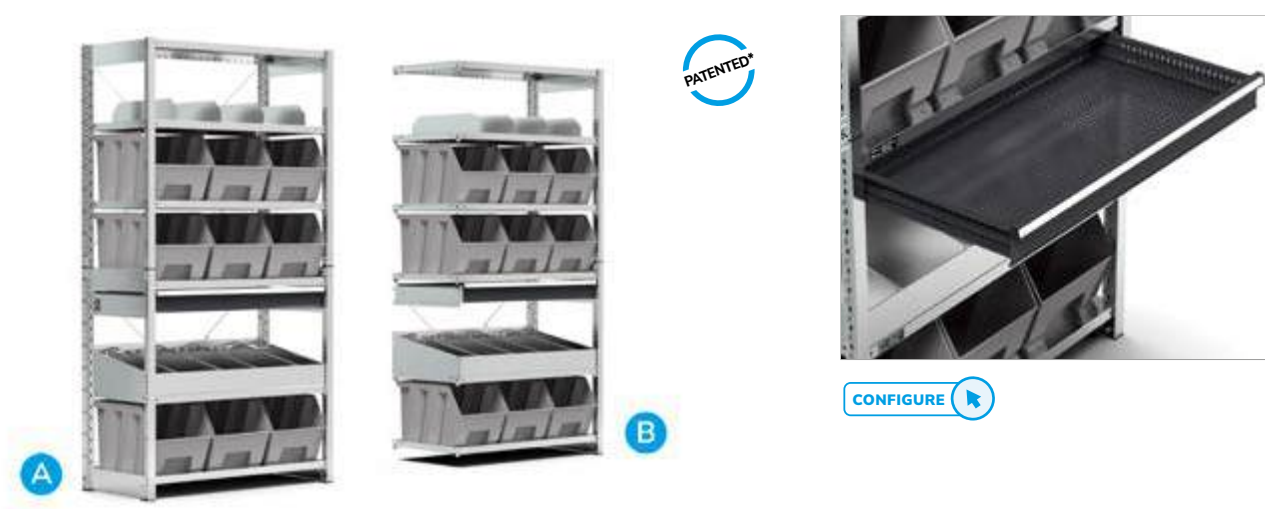

SCAFFALE CON 6 PIANI E 9 CONTENITORI PICKING BOX AIR MIS. 4A5

ART.	L mm	P mm	H mm	KG per piano	cassetti			finitura	€
					n.	KG			
A ST1022	1057	521	2011	120	1	50	88%	Zincato	544,67
B ST1023	1028	521	2011	120	1	50	88%	Zincato	483,60

Completo di 4 separatori, 1 coppia bandinelle, 4 divisori trapezoidali, 1 cassetto ad estrazione semplice

SCAFFALE CON 6 PIANI SENZA CONTENITORI

ART.	L mm	P mm	H mm	KG per piano	cassetti			finitura	€
					n.	KG			
A ST1024	1057	521	2011	120	1	50	88%	Zincato	416,33
B ST1025	1028	521	2011	120	1	50	88%	Zincato	355,26

Completo di 4 separatori, 1 coppia bandinelle, 4 divisori trapezoidali, 1 cassetto ad estrazione semplice



CONFIGURE

SCAFFALE CON 6 PIANI

ART.	L mm	P mm	H mm	KG per piano	finitura	€
A ST1026	1057	321	2011	120	Zincato	315,58
A ST1027	1057	421	2011	120	Zincato	324,57
A ST1028	1057	521	2011	120	Zincato	337,28
A ST1029	1057	621	2011	120	Zincato	372,00

Completo di 2 coppie bandinelle, 4 divisori trapezoidali

B ST1030	1028	321	2011	120	Zincato	255,13
B ST1031	1028	421	2011	120	Zincato	264,43
B ST1032	1028	521	2011	120	Zincato	276,21
B ST1033	1028	621	2011	120	Zincato	310,00

Completo di 2 coppie bandinelle, 4 divisori trapezoidali



KG
PORTATA

ESTRAZIONE

ZINCATO



[CONFIGURE](#)

SCAFFALE PORTA PNEUMATICI

ART.	L mm	P mm	H mm	n. supporti	per supporto	finitura	€
A ST1034	1057	421	2016	6	50	Zincato	182,28
B ST1035	1028	421	2016	6	50	Zincato	130,20

SUPPORTO PORTA PNEUMATICI



ART.	multiplo d'ordine	L mm	P mm	H mm	per supporto	finitura	€
FST9580S199	2	1000	33	98	50	Zincato	13,02



PATENTED

[CONFIGURE](#)

SCAFFALE PORTA PNEUMATICI

ART.	L mm	P mm	H mm	n. supporti	per supporto	finitura	€
ST2002	2071	421	2016	12	50	Zincato	312,48



CONFIGURE

SCAFFALE CON 6 PIANI E 6 CORRENTI

	ART.	L mm	P mm	H mm	KG per coppia corrente	finitura	€
A	ST2003	2065	321	2016	250	Zincato	471,20
A	ST2004	2065	421	2016	250	Zincato	476,47
A	ST2005	2065	521	2016	250	Zincato	485,46
A	ST2006	2065	621	2016	250	Zincato	516,46
A	ST2007	2065	821	2016	250	Zincato	550,87
B	ST2008	2036	321	2016	250	Zincato	418,81
B	ST2009	2036	421	2016	250	Zincato	424,39
B	ST2010	2036	521	2016	250	Zincato	432,45
B	ST2011	2036	621	2016	250	Zincato	462,52
B	ST2012	2036	821	2016	250	Zincato	495,07



PORTATA



ZINCATO



PATENTED*

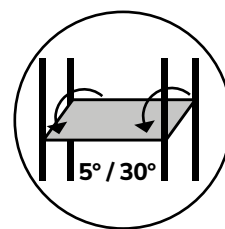

CONFIGURE 

SCAFFALE CON 6 PIANI INCLINATI

	ART.	L mm	P mm	H mm	 per piano	finitura	€
	ST2602	2671	321	2016	100	Zincato	450,43
	ST2603	2671	421	2016	100	Zincato	456,01
	ST2604	2671	521	2016	100	Zincato	470,27
	ST2605	2671	621	2016	100	Zincato	507,47
	ST2606	2671	821	2016	100	Zincato	552,42

Completo di bordi fermacasse e coppia staffe per piani inclinati 5°/30°





Predisposto per ruote e staffe vedi pag. 107 / 109

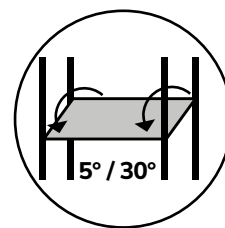

CONFIGURE

SCAFFALE CON 7 PIANI INCLINATI

	ART.	L mm	P mm	H mm	n. kit 4 separatori	finitura	€
	A ST1036	1057	521	2016	10	Zincato	673,01
	A ST1037	1057	621	2016	10	Zincato	762,91
	A ST1038	1057	821	2016	10	Zincato	825,53
	B ST1039	1028	521	2016	10	Zincato	620,00
	B ST1040	1028	621	2016	10	Zincato	708,97
	B ST1041	1028	821	2016	10	Zincato	769,73

Completo di bordi fermacasse e coppia staffe per piani inclinati 5°/30°

Piani con profondità 500 mm portata 120 kg. Piani con profondità 600 e 800 mm portata 300 kg.



PORTATA



ZINCATO



A



PATENTED*

[CONFIGURE](#)

SCAFFALE CON 4 TELAI INCLINABILI

	ART.	L mm	P mm	H mm	KG per telaio	KG per rullo	n. binari con rulli	finitura	€
 A	ST1101	1100	1509	2009	200	4	32	Zincato	1477,46
 B	ST1102	1100	1009	2009	200	4	32	Zincato	1329,90
 C	ST1401	1400	1009	2009	200	4	32	Zincato	1406,78
 D	ST1402	1400	1509	2009	200	4	32	Zincato	1541,94



B



C



D

[CONFIGURE](#)
[CONFIGURE](#)
[CONFIGURE](#)



A



PATENTED*

CONFIGURE

SCAFFALE CON 4 TELAI INCLINABILI CON RUOTE

ART.	L mm	P mm	H mm	KG per telaio	KG per rullo	n. binari con rulli	ruote			finitura	€
							KG set ruote				
A ST1103	1118	1009	2164	200	4	32	750	2	2	Zincato	1485,52
B ST1403	1418	1009	2164	200	4	32	750	2	2	Zincato	1562,40



B

CONFIGURE



PORTATA
 RUOTA FISSA
 RUOTA GIREVOLE CON FRENO
 ZINCATO

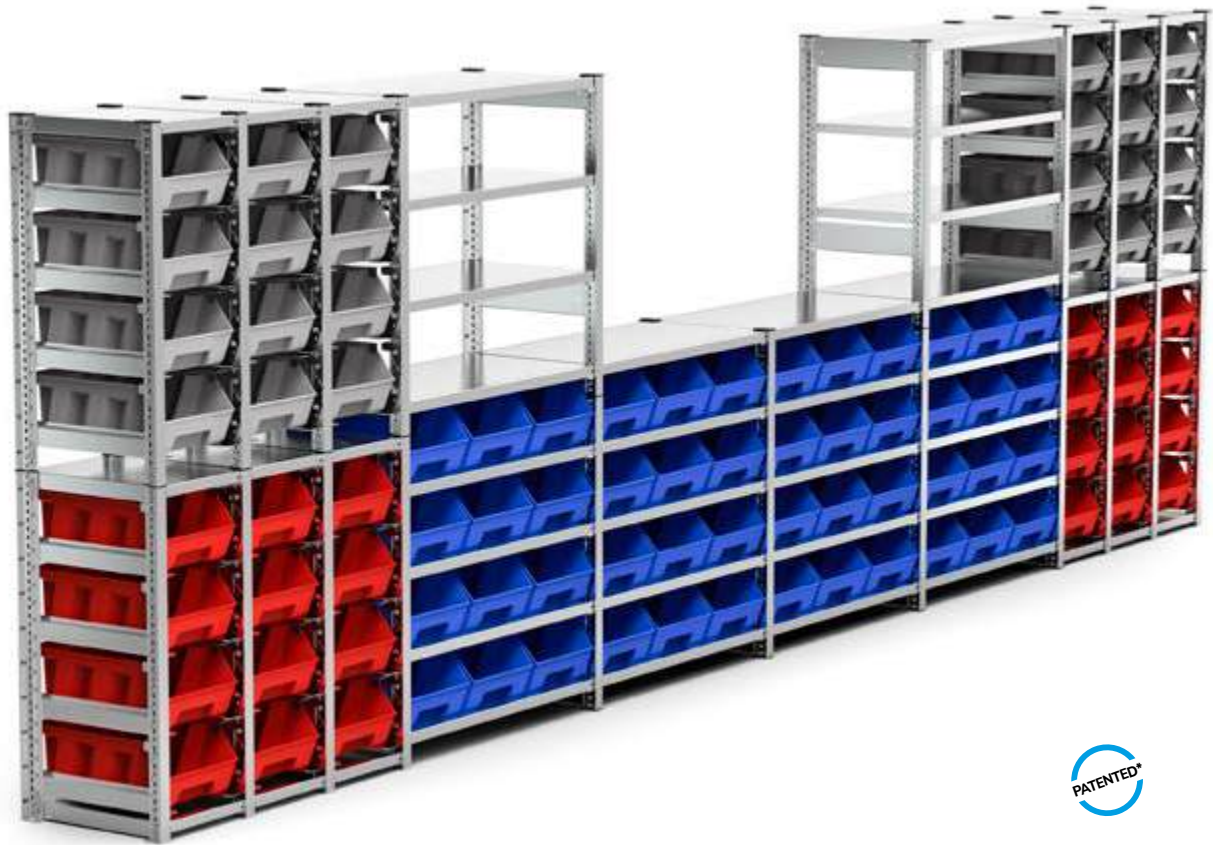

[CONFIGURE](#)

SCAFFALE CON 5 PIANI E 12 CONTENITORI PICKING BOX AIR MIS. 4

ART.	L mm	P mm	H mm	contenitori					per piano	finitura	€
				nr	mis.	kg	L	colore			
A ST1045	1057	521	1111	12	4	39	28		120	Zincato	312,79
B ST1046	1028	521	1111	12	4	39	28		120	Zincato	279,00

SCAFFALE CON 5 PIANI SENZA CONTENITORI MIS. 4

ART.	L mm	P mm	H mm	per piano	finitura	€
A ST1047	1057	521	1111	120	Zincato	171,43
B ST1048	1028	521	1111	120	Zincato	137,64



CONFIGURE

SCAFFALE CON 8 PIANI E 24 CONTENITORI PICKING BOX AIR MIS. 4

ART.	L mm	P mm	H mm	contenitori					per piano	finitura	€
				nr	mis.	KG	L	colore			
A ST1049	1057	521	2056	24	4	39	28		120	Zincato	591,48
B ST1050	1028	521	2056	24	4	39	28		120	Zincato	527,93

SCAFFALE CON 8 PIANI SENZA CONTENITORI MIS. 4

ART.	L mm	P mm	H mm	per piano	finitura	€
A ST1051	1057	521	2016	120	Zincato	308,76
B ST1052	1028	521	2016	120	Zincato	245,21

CONTENITORE CON FONDO RINFORZATO - DIM. INGOMBRO (mm): L=336 P=508 H=203



ART.	multiplo d'ordine	mis.	dim. utili			L	colore	€
			L mm	P mm	H mm			
FPB0004R051LQ	12	4	228	402	196	28		11,78
FPB0004R05132	12	4	228	402	196	28		11,78
FPB0004R0511Z	12	4	228	402	196	28		11,78
FPB0004R0512Y	12	4	228	402	196	28		11,78
FPB0004R0514Q	12	4	228	402	196	28		11,78



PORTATA



CAPACITÀ



ZINCATO



CONFIGURE

SCAFFALE CON 6 PIANI E 18 CONTENITORI PICKING BOX AIR MIS. 4A5

ART.	L mm	P mm	H mm	contenitori					per piano	finitura	€
				nr	mis.	KG	L	colore			
A ST1053	1057	521	2131	18	4A5	39	42		120	Zincato	506,54
B ST1054	1028	521	2131	18	4A5	39	42		120	Zincato	442,99

SCAFFALE CON 6 PIANI SENZA CONTENITORI MIS. 4A5

ART.	L mm	P mm	H mm	per piano	finitura	€
A ST1055	1057	521	2016	120	Zincato	249,86
B ST1056	1028	521	2016	120	Zincato	186,31

CONTENITORE CON FONDO RINFORZATO - DIM. INGOMBRO (mm): L=336 P=508 H=304



PATENTED*

ART.	multiplo d'ordine	mis.	dim. utili			L	colore	€
			L mm	P mm	H mm			
FPB04A5R051LQ	9	4A5	238	381	298	42		14,26
FPB04A5R05132	9	4A5	238	381	298	42		14,26
FPB04A5R0511Z	9	4A5	238	381	298	42		14,26
FPB04A5R0512Y	9	4A5	238	381	298	42		14,26
FPB04A5R0514Q	9	4A5	238	381	298	42		14,26



CONFIGURE

SCAFFALE CON 7 PIANI E 21 CONTENITORI PICKING BOX AIR MIS. 4/4A5

ART.	L mm	P mm	H mm	contenitori					per piano	finitura	€
				nr	mis.			colore			
A ST1057	1057	521	2111	9+12	4A5/4	39/39	42/28		120	Zincato	549,01
B ST1058	1028	521	2111	9+12	4A5/4	39/39	42/28		120	Zincato	485,46

SCAFFALE CON 7 PIANI SENZA CONTENITORI MIS. 4/4A5

ART.	L mm	P mm	H mm		finitura	€
				per piano		
A ST1059	1057	521	2016	120	Zincato	279,31
B ST1060	1028	521	2016	120	Zincato	215,76

CONTENITORE CON FONDO RINFORZATO - DIM. INGOMBRO (mm): L=336 P=508 H=203



ART.	multiplo d'ordine	mis.	dim. utili				colore	€
			L mm	P mm	H mm			
FPB0004R051LQ	12	4	228	402	196	28		11,78
FPB0004R05132	12	4	228	402	196	28		11,78
FPB0004R0511Z	12	4	228	402	196	28		11,78
FPB0004R0512Y	12	4	228	402	196	28		11,78
FPB0004R0514Q	12	4	228	402	196	28		11,78



PORTATA



CAPACITÀ



ZINCATO

P= 421 mm

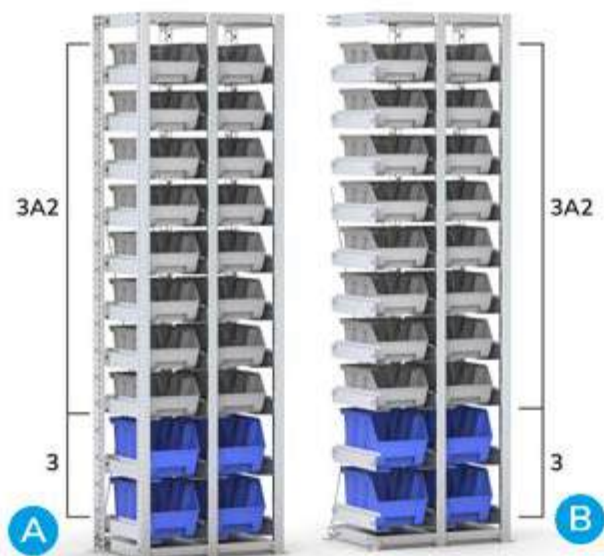

PICKING BOX AIR MIS. 3A2 - 3





vedi pag. 12





PICKING BOX MYTHOS MIS. 3A2 - 3

vedi pag. 44

SCAFFALE CON 20 CONTENITORI PICKING BOX AIR MIS. 3/3A2

ART.	L mm	P mm	H mm	n. slitte	contenitori				coppia slitte	finitura	€
					nr	mis.	KG	colore			
 A ST0601	634	421	2003	20 + 20	20	3/3A2	22/17		50	Zincato	503,75
 B ST0602	584	421	2003	20 + 20	20	3/3A2	22/17		50	Zincato	469,96



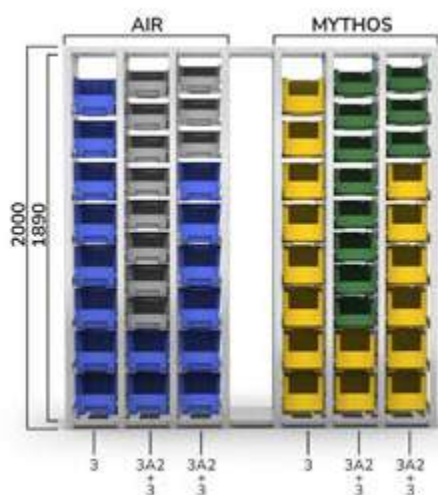

SCAFFALE VUOTO PER CONTENITORI MIS. 3/3A2

ART.	L mm	P mm	H mm	n. slitte	coppia slitte	finitura	€
 A ST0603	634	421	2003	20 + 20	50	Zincato	369,21
 B ST0604	584	421	2003	20 + 20	50	Zincato	335,42

SCHEMA DISPOSIZIONE CONTENITORI PICKING BOX



La tabella sottostante indica il passo delle guide in base alla misura dei contenitori da inserire.

misura	passo mm
3A2 Mythos	175 
3 Mythos	225 
3A2 Air	175 
3 Air	225 

ST

P= 421 mm



1

2

3

4

1 CAMPATA BASE H=2000 MM

ART.	L mm	P mm	H mm	H utile mm	finitura	€
ST0301	360	421	2003	1890	Zincato	106,33

2 CAMPATA AGGIUNTIVA H=2000 MM

ART.	L mm	P mm	H mm	H utile mm	finitura	€
ST0302	310	421	2003	1890	Zincato	72,54

3 CAMPATA BASE H=1000 MM

ART.	L mm	P mm	H mm	H utile mm	finitura	€
ST0303	360	421	1009	890	Zincato	78,74

4 CAMPATA AGGIUNTIVA H=1000 MM

ART.	L mm	P mm	H mm	H utile mm	finitura	€
ST0304	310	421	1009	890	Zincato	60,45



COPIA SLITTE PER CONTENITORI

ART.	L mm	P mm	H mm	finitura	€
ST9001	75	394	69	Zincato	8,99



KIT 2 FERMI PER CONTENITORI

ART.	L mm	P mm	H mm	finitura	€
FST4200S199	62	75	54	Zincato	9,92



CROCIERA DI IRRIGIDIMENTO

ART.	L mm	P mm	H mm	finitura	€
FST7310S099	15	10	1290/1340	Zincato	10,54

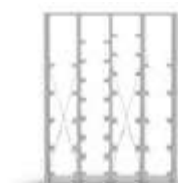

! Nelle scaffalature con altezza 2003 mm è obbligatorio installare una crociera ogni due campate.
Nelle scaffalature con altezza 1009 mm non è necessaria l'installazione delle crociere.



PORTATA



ZINCATO

ST

P= 521 mm



PICKING BOX AIR MIS. 4 - 4A5

vedi pag. 12



PICKING BOX MYTHOS MIS. 4A2 - 4 - 4A5

vedi pag. 44

SCAFFALE CON 21 CONTENITORI PICKING BOX AIR MIS. 4/4A5

ART.	L mm	P mm	H mm	n. slitte	contenitori				coppia slitte	finitura	€
					nr	mis.	KG	colore			
A ST1217	1208	521	2003	21 + 21	21	4 / 4A5	39 / 39		50	Zincato	802,59
B ST1218	1158	521	2003	21 + 21	21	4 / 4A5	39 / 39		50	Zincato	758,26

SCAFFALE VUOTO PER CONTENITORI MIS. 4/4A5

ART.	L mm	P mm	H mm	n. slitte	KG	finitura	€
A ST1219	1208	521	2003	21 + 21	50	Zincato	532,89
B ST1220	1158	521	2003	21 + 21	50	Zincato	488,56

SCHEMA DISPOSIZIONE CONTENITORI PICKING BOX

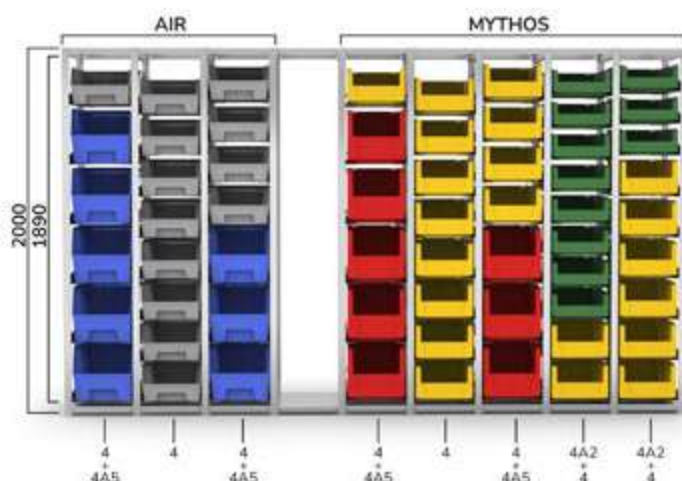

La tabella sottostante indica il passo delle guide in base alla misura dei contenitori da inserire.

misura	passo mm
4A2 Mythos	175
4 Mythos	225
4A5 Mythos	325
4 Air	225
4A5 Air	325

ST

P= 521 mm



1

2

3

4

1 CAMPATA BASE H=2000 MM

ART.	L mm	P mm	H mm	H utile mm	finitura	€
ST0401	460	521	2003	1890	Zincato	112,84

2 CAMPATA AGGIUNTIVA H=2000 MM

ART.	L mm	P mm	H mm	H utile mm	finitura	€
ST0402	410	521	2003	1890	Zincato	79,05

3 CAMPATA BASE H=1000 MM

ART.	L mm	P mm	H mm	H utile mm	finitura	€
ST0403	460	521	1009	890	Zincato	85,25

4 CAMPATA AGGIUNTIVA H=1000 MM

ART.	L mm	P mm	H mm	H utile mm	finitura	€
ST0404	410	521	1009	890	Zincato	66,96



COPIA SLITTE PER CONTENITORI

ART.	L mm	P mm	H mm	finitura	€
ST9002	75	494	69	Zincato	11,47



KIT 2 FERMI PER CONTENITORI

ART.	L mm	P mm	H mm	finitura	€
FST4200S199	62	75	54	Zincato	9,92



CROCIERA DI IRRIGIDIMENTO

ART.	L mm	P mm	H mm	finitura	€
FST7310S099	15	10	1290/1340	Zincato	10,54



! Nelle scaffalature con altezza 2003 mm è obbligatorio installare una crociera ogni due campate.
Nelle scaffalature con altezza 1009 mm non è necessaria l'installazione delle crociere.



PORTATA



ZINCATO

ST

P= 421 mm



EURO BOX 4317 - 4322

vedi pag. 62

SCAFFALE CON 16 CASSETTE EURO BOX MIS. 4317/4322

ART.	L mm	P mm	H mm	n. slitte	cassette				coppia slitte	finitura	€
					nr	mis.	KG	colore			
A ST0801	810	421	2003	16 + 16	16	4317 / 4322	30 / 30	■	50	Zincato	496,31
B ST0802	760	421	2003	16 + 16	16	4317 / 4322	30 / 30	■	50	Zincato	462,52

SCAFFALE VUOTO PER CASSETTE 400X300

ART.	L mm	P mm	H mm	n. slitte	KG	finitura	€
					coppia slitte		
A ST0803	810	421	2003	16 + 16	50	Zincato	337,59
B ST0804	760	421	2003	16 + 16	50	Zincato	303,80

SCHEMA DISPOSIZIONE CASSETTE EURO BOX 400X300

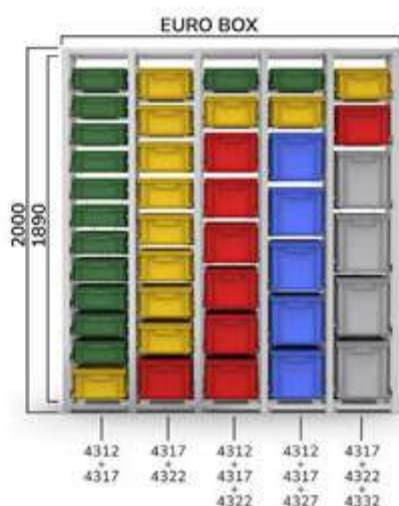

La tabella sottostante indica il passo delle guide in base alla misura delle cassette da inserire.

misura	passo mm	colore
4312	150	■
4317	200	■
4322	250	■
4327	300	■
4332	350	■

! Le cassette Euro Box sono disponibili solo in grigio. I colori nell'immagine sono puramente a scopo illustrativo, utile a evidenziare le diverse misure.

ST

P= 421 mm



1

2

3

4

1 CAMPATA BASE H=2000 MM

ART.	L mm	P mm	H mm	H utile mm	finitura	€
ST0405	448	421	2003	1890	Zincato	108,50

2 CAMPATA AGGIUNTIVA H=2000 MM

ART.	L mm	P mm	H mm	H utile mm	finitura	€
ST0406	398	421	2003	1890	Zincato	74,71

3 CAMPATA BASE H=1000 MM

ART.	L mm	P mm	H mm	H utile mm	finitura	€
ST0407	448	421	1009	890	Zincato	80,91

4 CAMPATA AGGIUNTIVA H=1000 MM

ART.	L mm	P mm	H mm	H utile mm	finitura	€
ST0408	398	421	1009	890	Zincato	62,62



COPIA SLITTE PER CONTENITORI

ART.	L mm	P mm	H mm	finitura	€
ST9001	75	394	69	Zincato	8,99



KIT 2 FERMI PER CONTENITORI

ART.	L mm	P mm	H mm	finitura	€
FST4200S199	62	75	54	Zincato	9,92



CROCIERA DI IRRIGIDIMENTO

ART.	L mm	P mm	H mm	finitura	€
FST7310S099	15	10	1290/1340	Zincato	10,54

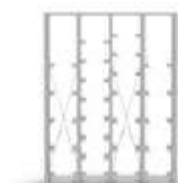

! Nelle scaffalature con altezza 2003 mm è obbligatorio installare una crociera ogni due campate.
Nelle scaffalature con altezza 1009 mm non è necessaria l'installazione delle crociere.



PORTATA



ZINCATO

ST

P= 621 mm





EURO BOX 6417 - 6422

vedi pag. 62

SCAFFALE CON 16 CASSETTE EURO BOX MIS. 6417/6422

ART.	L mm	P mm	H mm	n. slitte	cassette				coppia slitte	finitura	€
					nr	mis.	KG	colore			
 A ST1065	1010	621	2003	16 + 16	16	6417 / 6422	30 / 30	■	50	Zincato	652,55
 B ST1066	960	621	2003	16 + 16	16	6417 / 6422	30 / 30	■	50	Zincato	618,76

SCAFFALE VUOTO PER CASSETTE 600X400

ART.	L mm	P mm	H mm	n. slitte	KG	finitura	€
					coppia slitte		
 A ST1067	1010	621	2003	16 + 16	50	Zincato	407,65
 B ST1068	960	621	2003	16 + 16	50	Zincato	373,86

SCHEMA DISPOSIZIONE CASSETTE EURO BOX 600X400

La tabella sottostante indica il passo delle guide in base alla misura delle cassette da inserire.

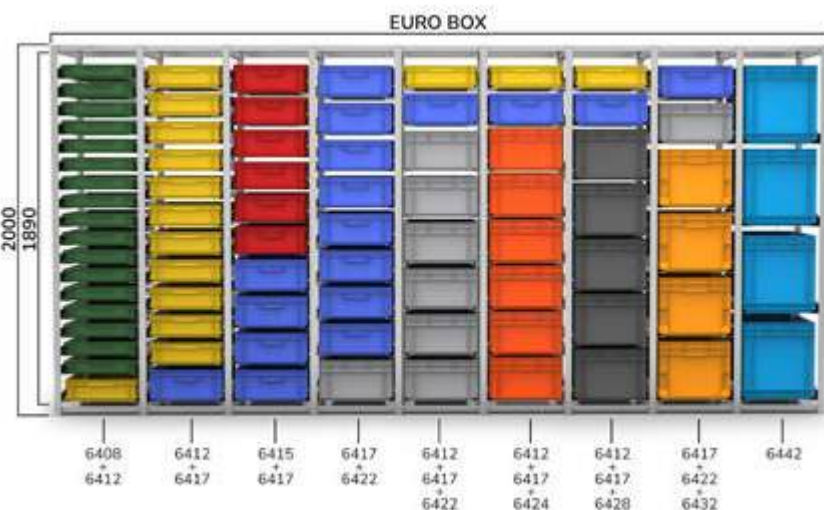

misura	passo mm	colore
6408	100	■
6412	150	■
6415	175	■
6417	200	■
6422	250	■
6424	250	■
6428	300	■
6432	350	■
6442	450	■

! Le cassette Euro Box sono disponibili solo in grigio. I colori nell'immagine sono puramente a scopo illustrativo, utile a evidenziare le diverse misure.

ST

P= 621 mm

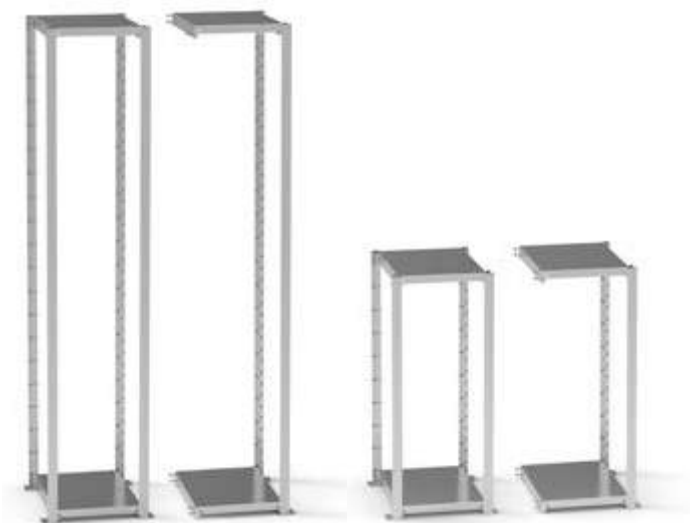

1

2

3

4

1 CAMPATA BASE H=2000 MM

ART.	L mm	P mm	H mm	H utile mm	finitura	€
ST0501	548	621	2003	1890	Zincato	118,73

2 CAMPATA AGGIUNTIVA H=2000 MM

ART.	L mm	P mm	H mm	H utile mm	finitura	€
ST0502	498	621	2003	1890	Zincato	84,94

3 CAMPATA BASE H=1000 MM

ART.	L mm	P mm	H mm	H utile mm	finitura	€
ST0503	548	621	1009	890	Zincato	91,14

4 CAMPATA AGGIUNTIVA H=1000 MM

ART.	L mm	P mm	H mm	H utile mm	finitura	€
ST0504	498	621	1009	890	Zincato	72,85



COPIA SLITTE PER CONTENITORI

ART.	L mm	P mm	H mm	finitura	€
ST9003	75	594	69	Zincato	12,09



KIT 2 FERMI PER CONTENITORI

ART.	L mm	P mm	H mm	finitura	€
FST4200S199	62	75	54	Zincato	9,92



CROCIERA DI IRRIGIDIMENTO

ART.	L mm	P mm	H mm	finitura	€
FST7310S099	15	10	1290/1340	Zincato	10,54



! Nelle scaffalature con altezza 2003 mm è obbligatorio installare una crociera ogni due campate.
Nelle scaffalature con altezza 1009 mm non è necessaria l'installazione delle crociere.



PORTATA



ZINCATO

SCAFFALI MONOBLOCCO

DOMINO



Gli **scaffali monoblocco porta contenitori** Domino presentano una **struttura alveolare** per la creazione di magazzini modulari in cui organizzare contenitori a bocca di lupo in ferro o polipropilene. È possibile, infatti, **sovrapporli** in tutta sicurezza per creare soluzioni che si sviluppano in altezza e in larghezza in base agli spazi a disposizione. L'estrazione dei contenitori è rapida e sicura: un apposito gancio installato nella parte anteriore delle guide impedisce la fuoriuscita totale e accidentale del contenitore.

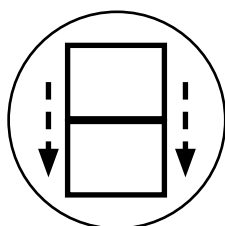

SOVRAPPONIBILI

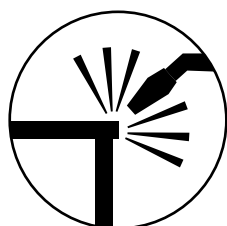

STRUTTURA
SALDATA



PORTATA MODULO
FINO A 1600 KG

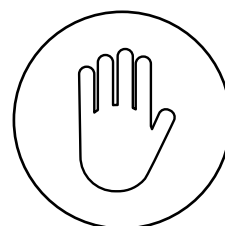

FERMO ANTICADUTA

DOMINO



SCAFFALE CON 16 PICKING BOX MYTHOS MIS. 3

ART.	L mm	P mm	H mm	RAL	€
 FED30440301	1025	355	885	7000	393,08

Composto da:

qtà	descrizione
1	Scaffale a 16 posti per contenitori mis. 3
16	Contenitore in polipropilene Picking Box Mythos mis. 3

SOVRAPPONIBILITÀ



n. telai sovrapposti	 di ogni telaio	 di ogni box
2	960	60
3	640	40



SCAFFALE CON 20 PICKING BOX MYTHOS MIS. 4

ART.	L mm	P mm	H mm	RAL	€
 FED40540301	1765	500	885	7000	590,55

Composto da:

qtà	descrizione
1	Scaffale a 20 posti per contenitori mis. 4
20	Contenitore in polipropilene Picking Box Mythos mis. 4

SOVRAPPONIBILITÀ

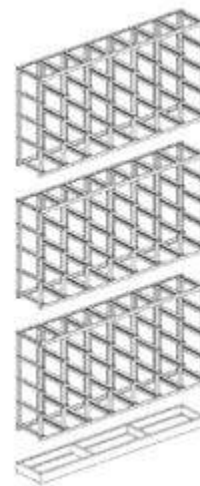

n. telai sovrapposti	 di ogni telaio	 di ogni box
3	1600	80



PORTATA



RAL7000

DOMINO



SCAFFALE CON 16 CONTENITORI MIS. 3

ART.	L mm	P mm	H mm	RAL	€
 FED30440201	1025	355	885	7000	534,75

Composto da:

qtà	descrizione
1	Scaffale a 16 posti per contenitori mis. 3
16	Contenitore in metallo mis. 3

[CONFIGURE](#) 



SCAFFALE CON 20 CONTENITORI MIS. 4

ART.	L mm	P mm	H mm	RAL	€
 FED40540201	1765	500	885	7000	828,32

Composto da:

qtà	descrizione
1	Scaffale a 20 posti per contenitori mis. 4
20	Contenitore in metallo mis. 4

[CONFIGURE](#) 

SOVRAPPONIBILITÀ



n. telai sovrapposti	 di ogni telaio	 di ogni box
2	960	60
3	640	40

SOVRAPPONIBILITÀ

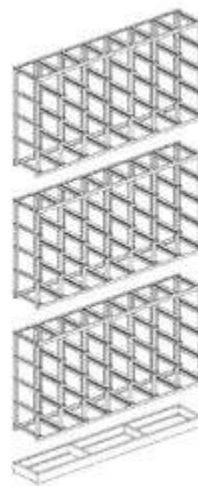

n. telai sovrapposti	 di ogni telaio	 di ogni box
3	1600	80

DOMINO

COMPONENTI



SCAFFALE VUOTO

ART.	L mm	P mm	H mm	RAL	€
 FED30440A01	1025	310	885	7000	274,04

[CONFIGURE](#) 



SCAFFALE VUOTO

ART.	L mm	P mm	H mm	RAL	€
 FED40540A01	1765	460	885	7000	342,24

[CONFIGURE](#) 



COPERCHIO PARAPOLVERE

ART.	L mm	P mm	H mm	RAL	€
 FED90340001	1020	315	20	7000	27,90



COPERCHIO PARAPOLVERE

ART.	L mm	P mm	H mm	RAL	€
 FED90450001	1765	465	20	7000	39,68



ZOCOLO DI APPOGGIO

ART.	L mm	P mm	H mm	RAL	€
 FED92340001	1020	313	85	7000	63,24



ZOCOLO DI APPOGGIO

ART.	L mm	P mm	H mm	RAL	€
 FED92450001	1765	463	85	7000	77,19



PORTATA



RAL 7000

BANCHI DA OFFICINA

WORK

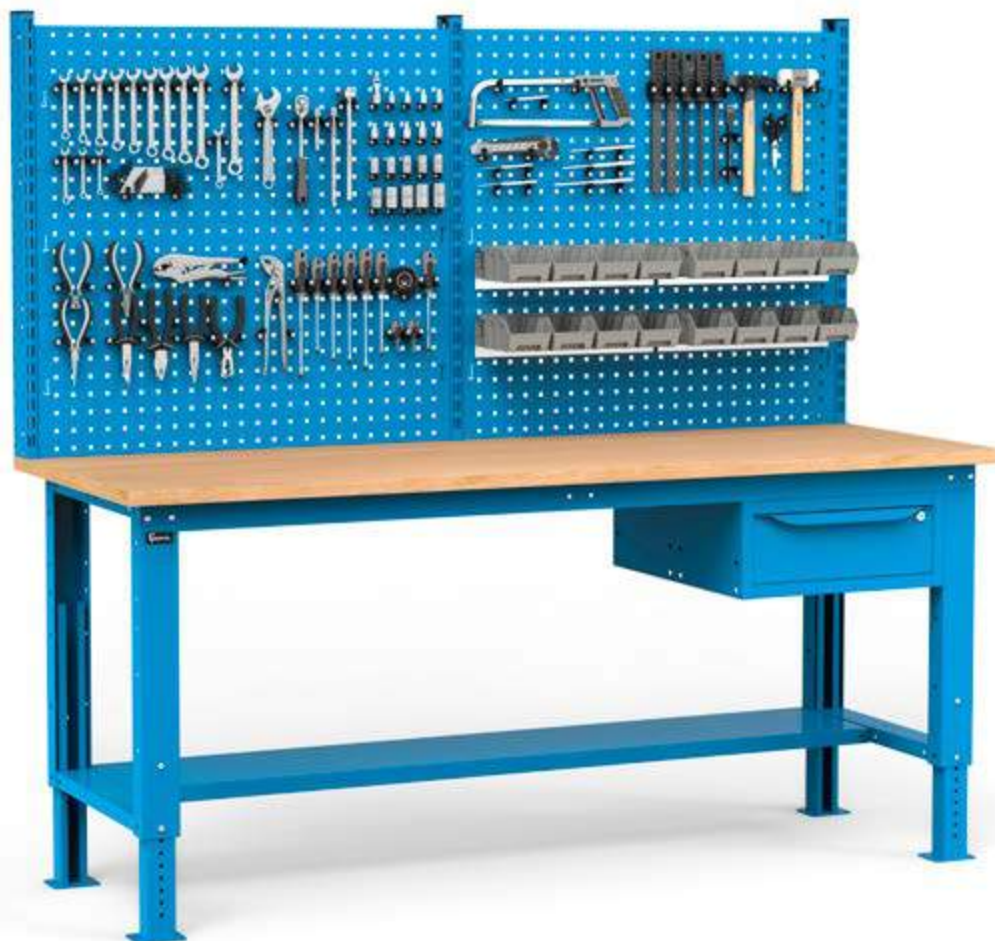

I banchi della serie Work sono **soluzioni flessibili** e facilmente personalizzabili a seconda delle esigenze. Possono essere allestiti con **piano** in legno multilex di **faggio** da 30 mm o con piano in acciaio da 2,5 mm e sono disponibili in **3 larghezze**: 1000, 1500 o 2000 mm. I banchi Work possono presentare **gambe in acciaio fisse** e **piano inferiore** di serie, oppure **semipiano inferiore** di serie e **gambe regolabili in altezza** predisposte per l'installazione di ruote. La struttura in acciaio può ospitare armadi a porte o con cassetti, ripiani o semipiani, pannelli forati e mensole.

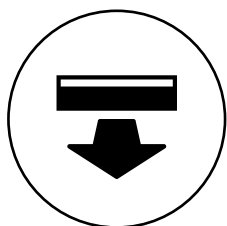

**CASSETTI AD
ESTRAZIONE
SEMPLICE**



**PORTATA
CASSETTI 80 KG**

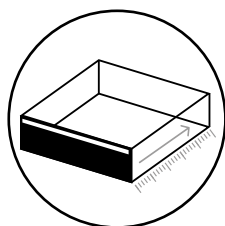

**PROFONDITÀ UTILE
CASSETTO 513 MM**

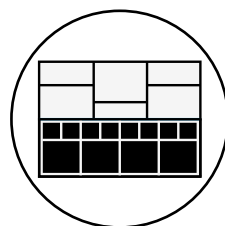

**MATERIALE DI
SEPARAZIONE**

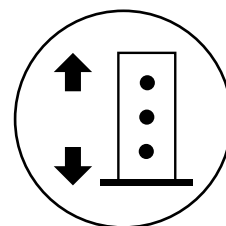

**GAMBE REGOLABILI IN
ALTEZZA**

WORK



PIANO IN MULTIPLEX DI FAGGIO

Il piano in multiplex di faggio offre robustezza e resistenza, garantendo una superficie stabile e solida, perfetta per operazioni pesanti e di precisione. È resistente a graffi, urti e altre forme di usura e presenta uno spessore di 30 mm.



PIANO IN ACCIAIO

Il piano in acciaio è ideale per ambienti di lavoro intensivi dove si utilizzano strumenti da taglio, grazie alla sua elevata resistenza all'usura e alle abrasioni. Ha uno spessore di 2,5 mm e dispone di tre bordi rialzati.



COPERTURA IN ACCIAIO GOMMATO

La copertura in acciaio gommato preserva l'integrità del piano di lavoro in caso di utilizzo di acidi o oli o si effettuino lavorazioni pesanti. Può essere applicata sia a piani in multiplex che in acciaio.



RUOTE

Le ruote trasformano i banchi regolabili in altezza Work in pratiche postazioni mobili. Sono disponibili in gomma antitraccia sintetica o in gomma elastica e sono fornite in kit composti da 2 ruote girevoli con freno e 2 ruote fisse.



MATERIALE DI SEPARAZIONE

Il cassetto può essere suddiviso internamente tramite **cassette divisorio portaminuterie e divisori longitudinali e trasversali in metallo**. Quest'ultimi sono fissati al fondo forato del cassetto tramite viti per evitare la fuoriuscita del materiale stoccato.

COMPONIBILE ED ESPANDIBILE

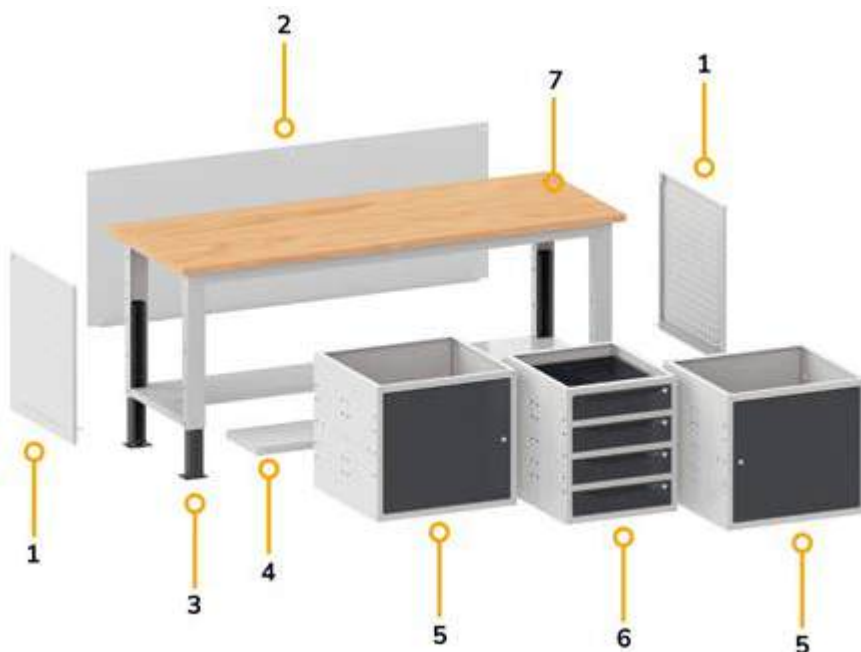

1. Pannello forato laterale
2. Chiusura posteriore
3. Gambe regolabili
4. Semipiano aggiuntivo
5. Armadio con porta
6. Armadio a 4 cassetti
7. Piano in Multiplex

WORK



SEMIPIANO AGGIUNTIVO

Il semipiano aggiuntivo è installato nella parte inferiore del banco per disporre di una mensola porta oggetti capiente e poco ingombrante.



PIANO AGGIUNTIVO

Il piano aggiuntivo ottimizza lo spazio sul banco, offrendo una superficie extra per lo stoccaggio di materiale di lavoro.



PANNELLO FORATO LATERALE

Il pannello forato trasforma i fianchi del banco in pratiche pareti porta attrezzi, ideali per fissare accessori e ganci portautensili.

COLORI

Il banco da lavoro Work è disponibile in 12 combinazioni di colori di cui 2 pronte a magazzino.

BANCO



7035
7016



7035*



5012



9002*



7016*



7000*



5019*



9010*



6011*



3003*



5010*



7035
5012*

* Su richiesta

	START	PRO	PRO+
	WORK	BR	MASTER
Larghezza mm	1000-1500-2000	1024-1500-2000-3000	1300-1500-2000-2500-3000
Tipologia piani lavoro	Acciaio Multiplex	Multiplex	Multiplex
Profondità piano lavoro mm	750	750	750-800*
Spessore piano lavoro in multiplex di faggio mm	30	40	40-50*
Copertura	Gommato	Gommato	Gommato
Portata banco kg	1000	1000	800 - 1500
Regolabile in altezza	✓	✓	✓
Gambe fisse	✓	-	✓
Gambe con ruote	Banco regolabile	-	✓
Gambe elettrificate	-	-	✓
Profondità utile cassetti	513 mm	447 mm - 27 EH	600 mm - 36 EH
Cassetto estrazione totale	-	✓	✓
Portata cassetti kg	80	50-75-100	50-75-100-200
Asta anti ribaltamento cassetto	-	✓	✓
Parete attrezzata	✓	✓	✓
Chiusura posteriore	Accessorio	Di serie	Accessorio*



* Su richiesta





Utensili esclusi

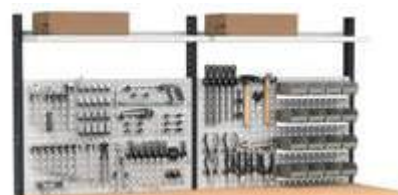
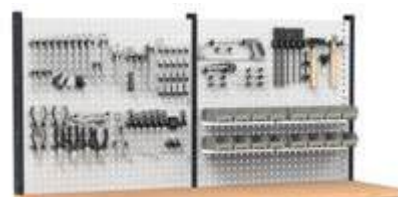

ESEMPI DI CONFIGURAZIONE



ART.	L mm	P mm	H mm	KG	RAL	€
 WORK2030	2000	750	1675/2000	1000	7035+7016	869,55
 WORK2036	2000	750	1675/2000	1000	5012	998,82

Composto da:

qtà	descrizione
1	Banco smontato regolabile con piano in multiplex 30 mm
1	Armadio L=500 mm con 1 cassetto H=150 mm
1	Kit 3 montanti biasolati
2	Kit 3 pannelli forati/mensole con 2 bordi fermacasse
6	Gancio Unipok per utensili - confezione 30 pezzi
4	Barra aggancio per contenitori Picking Box mis. 1/2
4	Kit 4 contenitori Picking Box Air mis. 1



RAL 7035 + RAL 7016

RAL 5012



300 kg

regolabili in altezza

piano in multiplex spessore 30 mm

Forniti smontati

passo fori gambe 25 mm

Ruote in gomma antitraccia sintetica



ART.	L mm	P mm	H mm	RAL	€
WORK1553	1500	750	887/1212	7035+7016	409,82
WORK1554	1500	750	887/1212	5012	467,79

Composto da:

qtà	descrizione
1	Banco smontato regolabile con piano in multiplex 30 mm
2	Coppia squadre di rinforzo
1	Kit 4 ruote in gomma antitraccia sintetica Ø 125 mm

CONFIGURE



ART.	L mm	P mm	H mm	RAL	€
WORK1555	1500	750	887/1212	7035+7016	499,10
WORK1556	1500	750	887/1212	5012	562,96

Composto da:

qtà	descrizione
1	Banco smontato regolabile con piano in multiplex 30 mm
1	Armadio L=500 mm con 1 cassetto H=150 mm
1	Coppia squadre di rinforzo
1	Kit 4 ruote in gomma antitraccia sintetica Ø 125 mm

CONFIGURE



ART.	L mm	P mm	H mm	RAL	€
WORK1557	1500	750	887/1212	7035+7016	777,17
WORK1558	1500	750	887/1212	5012	887,53

Composto da:

qtà	descrizione
1	Banco smontato regolabile con piano in multiplex 30 mm
1	Armadio L=500 mm con 4 cassetti H=105 mm
1	Semipiano non fessurato L=1260 mm
1	Coppia squadre di rinforzo
1	Kit 4 ruote in gomma antitraccia sintetica Ø 125 mm

CONFIGURE

 **300 kg**

 **regolabili in altezza**

 **piano in multiplex spessore 30 mm**

 **Forniti smontati**

 **passo fori gambe 25 mm**

 **Ruote in gomma antitraccia sintetica**



ART.	L mm	P mm	H mm	RAL	€
WORK2056	2000	750	887/1212	7035+7016	461,28
WORK2057	2000	750	887/1212	5012	518,63



Composto da:

qtà	descrizione
1	Banco smontato regolabile con piano in multiplex 30 mm
2	Coppia squadre di rinforzo
1	Kit 4 ruote in gomma antitraccia sintetica Ø 125 mm

CONFIGURE 



ART.	L mm	P mm	H mm	RAL	€
WORK2058	2000	750	887/1212	7035+7016	550,56
WORK2059	2000	750	887/1212	5012	613,80



Composto da:

qtà	descrizione
1	Banco smontato regolabile con piano in multiplex 30 mm
1	Armadio L=500 mm con 1 cassetto H=150 mm
1	Coppia squadre di rinforzo
1	Kit 4 ruote in gomma antitraccia sintetica Ø 125 mm

CONFIGURE 



ART.	L mm	P mm	H mm	RAL	€
WORK2060	2000	750	887/1212	7035+7016	838,55
WORK2061	2000	750	887/1212	5012	949,84



Composto da:

qtà	descrizione
1	Banco smontato regolabile con piano in multiplex 30 mm
1	Armadio L=500 mm con 4 cassetti H=105 mm
1	Semipiano non fessurato L=1760 mm
1	Coppia squadre di rinforzo
1	Kit 4 ruote in gomma antitraccia sintetica Ø 125 mm

CONFIGURE 



PORTATA



RUOTA FISSA



RUOTA GIREVOLE CON FRENO



RAL 7035 + RAL 7016



RAL 5012



1000 kg **Forniti smontati** **piano in multiplex spessore 30 mm**

Portata cassetti 80 kg **Estrazione cassetto 86%**



ART.	L mm	P mm	H mm	RAL	€
WORK1541	1500	750	882	7035+7016	387,50
WORK1542	1500	750	882	5012	408,89

Composto da:

qtà	descrizione
1	Banco smontato con piano in multiplex 30 mm
1	Armadio L=500 mm con 1 cassetto H=150 mm

CONFIGURE



ART.	L mm	P mm	H mm	RAL	€
WORK1543	1500	750	882	7035+7016	625,89
WORK1544	1500	750	882	5012	688,82

Composto da:

qtà	descrizione
1	Banco smontato con piano in multiplex 30 mm
1	Armadio L=500 mm con 4 cassetti H=105 mm

CONFIGURE



ART.	L mm	P mm	H mm	RAL	€
WORK1545	1500	750	882	7035+7016	729,74
WORK1546	1500	750	882	5012	812,51

Composto da:

qtà	descrizione
1	Banco smontato con piano in multiplex 30 mm
1	Armadio L=500 mm con 4 cassetti H=105 mm
1	Chiusura posteriore
1	Piano non fessurato L=760 mm

CONFIGURE

 **1000 kg**

 **regolabili in altezza**

 **piano in multiplex spessore 30 mm**

 **Forniti smontati**

 **passo fori gambe 25 mm**



[CONFIGURE](#) 



ART.	L mm	P mm	H mm	RAL	€
 WORK1501	1500	750	732/1057	7035+7016	424,70
 WORK1502	1500	750	732/1057	5012	487,63

Composto da:

qtà	descrizione
1	Banco smontato regolabile con piano in multiplex 30 mm
1	Armadio L=500 mm con 1 cassetto H=150 mm



[CONFIGURE](#) 



ART.	L mm	P mm	H mm	RAL	€
 WORK1503	1500	750	732/1057	7035+7016	702,77
 WORK1504	1500	750	732/1057	5012	812,20

Composto da:

qtà	descrizione
1	Banco smontato regolabile con piano in multiplex 30 mm
1	Armadio L=500 mm con 4 cassetti H=105 mm
1	Semipiano non fessurato L=1260 mm



[CONFIGURE](#) 

ART.	L mm	P mm	H mm	RAL	€
 WORK1507	1500	750	732/1057	7035+7016	761,98
 WORK1508	1500	750	732/1057	5012	887,53

Composto da:

qtà	descrizione
1	Banco smontato regolabile con piano in multiplex 30 mm
1	Armadio L=500 mm con 4 cassetti H=105 mm
1	Chiusura posteriore
1	Semipiano non fessurato L=760 mm
1	Supporto semipiano intermedio



PORTATA



RAL 7035 + RAL 7016



RAL 5012



1000 kg

regolabili in altezza

piano in multiplex spessore 30 mm

Forniti smontati

passo fori gambe 25 mm



ART.	L mm	P mm	H mm	RAL	€
WORK1505	1500	750	732/1057	7035+7016	844,13
WORK1506	1500	750	732/1057	5012	970,92

Composto da:

qtà	descrizione
1	Banco smontato regolabile con piano in multiplex 30 mm
1	Armadio L=500 mm con 4 cassetti H=105 mm
1	Armadio L=500 mm con 1 porta e 1 piano regolabile
1	Fondo di chiusura per armadio L=500 mm

CONFIGURE



ART.	L mm	P mm	H mm	RAL	€
WORK1511	1500	750	732/1057	7035+7016	745,55
WORK1512	1500	750	732/1057	5012	838,86

Composto da:

qtà	descrizione
1	Banco smontato regolabile con piano in multiplex 30 mm
2	Armadio L=629 mm con 1 cassetto H=150 mm e 1 porta
1	Semipiano non fessurato L=1260 mm

CONFIGURE



ART.	L mm	P mm	H mm	RAL	€
WORK1509	1500	750	732/1057	7035+7016	883,81
WORK1510	1500	750	732/1057	5012	1012,15

Composto da:

qtà	descrizione
1	Banco smontato regolabile con piano in multiplex 30 mm
1	Armadio L=629 mm con 4 cassetti H=105 mm
1	Armadio L=629 mm con 1 porta e 1 piano regolabile
1	Semipiano non fessurato L=1260 mm

CONFIGURE

CONFIGURAZIONI ALTERNATIVE

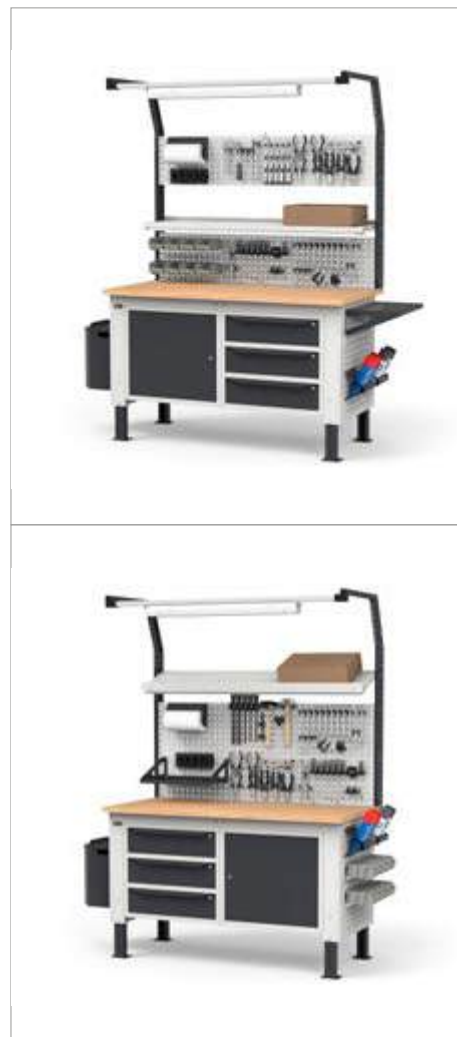

Utensili esclusi

[CONFIGURE](#)

[SHOP](#)

PATENTED

ART.	L mm	P mm	H mm	KG	RAL	€
WORK1540	1500	750	1977/2302	1000	7035+7016	1758,01

Composto da:

qtà	descrizione	qtà	descrizione
1	Banco smontato regolabile con piano in multiplex 30 mm	1	Kit 3 pannelli forati/mensole con 2 bordi fermacasse
1	Armadio L=629 mm con 1 porta e 1 piano regolabile	1	Lampada doppia
1	Fondo di chiusura per armadio L=629 mm	1	Lampada singola
1	Armadio L=629 mm con 3 cassetti H=150 mm	1	Kit porta rotolo con carta Ø=130 mm
2	Pannello forato laterale	1	Supporto multipresa a 4 scomparti
1	Cestino capacità 30 L	1	Multipresa schuko a 4 scomparti
1	Mensola grande reversibile	1	Cavo di collegamento wieland schuko/francese
2	Porta bombolette inclinato a 2 posti	4	Gancio Unipok per utensili - confezione 30 pezzi
1	Kit 2 montanti biasolati	2	Barra aggancio per contenitori Picking Box mis. 1/2
1	Kit 2 supporti inclinati con binario	2	Kit 4 contenitori Picking Box Air mis. 1



PORTATA



RAL 7035 + RAL 7016



RAL 5012



1000 kg



regolabili in altezza

piano in multiplex spessore 30 mm

Forniti smontati



passo fori gambe 25 mm



Utensili esclusi



[CONFIGURE](#)



Utensili esclusi



[CONFIGURE](#)



Utensili esclusi



[CONFIGURE](#)

ART.	L mm	P mm	H mm	RAL	€
WORK1528	1500	750	1675/2000	7035+7016	693,78
WORK1534	1500	750	1675/2000	5012	814,37

Composto da:

qtà	descrizione
1	Banco smontato regolabile con piano in multiplex 30 mm
1	Armadio L=500 mm con 1 cassetto H=150 mm
1	Kit 2 montanti biasolati
1	Kit 3 pannelli forati/mensole con 2 bordi fermacasse
6	Gancio Unipok per utensili - confezione 30 pezzi
2	Barra aggancio per contenitori Picking Box mis. 1/2
2	Kit 4 contenitori Picking Box Air mis. 1

ART.	L mm	P mm	H mm	RAL	€
WORK1529	1500	750	1675/2000	7035+7016	971,85
WORK1535	1500	750	1675/2000	5012	1138,94

Composto da:

qtà	descrizione
1	Banco smontato regolabile con piano in multiplex 30 mm
1	Armadio L=500 mm con 4 cassetti H=105 mm
1	Semipiano non fessurato L=1260 mm
1	Kit 2 montanti biasolati
1	Kit 3 pannelli forati/mensole con 2 bordi fermacasse
6	Gancio Unipok per utensili - confezione 30 pezzi
2	Barra aggancio per contenitori Picking Box mis. 1/2
2	Kit 4 contenitori Picking Box Air mis. 1

ART.	L mm	P mm	H mm	RAL	€
WORK1530	1500	750	1675/2000	7035+7016	1031,06
WORK1536	1500	750	1675/2000	5012	1214,27

Composto da:

qtà	descrizione
1	Banco smontato regolabile con piano in multiplex 30 mm
1	Chiusura posteriore
1	Armadio L=500 mm con 4 cassetti H=105 mm
1	Semipiano non fessurato L=760 mm
1	Supporto semipiano intermedio
1	Kit 2 montanti biasolati
1	Kit 3 pannelli forati/mensole con 2 bordi fermacasse
6	Gancio Unipok per utensili - confezione 30 pezzi
2	Barra aggancio per contenitori Picking Box mis. 1/2
2	Kit 4 contenitori Picking Box Air mis. 1

ESEMPI DI CONFIGURAZIONE

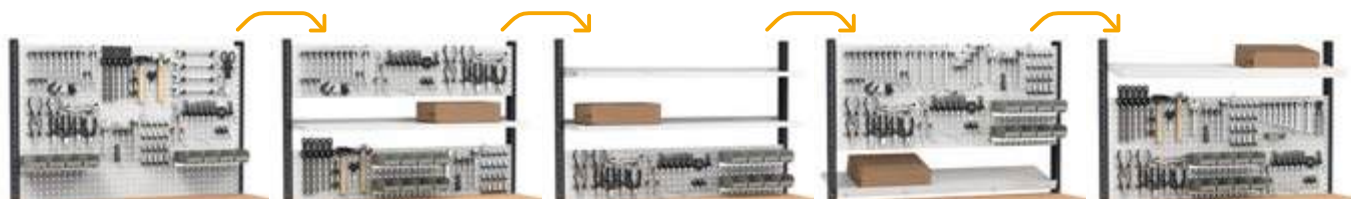

Utensili esclusi



[CONFIGURE](#)

ART.	L mm	P mm	H mm	RAL	€
WORK1531	1500	750	1675/2000	7035+7016	1113,21
WORK1537	1500	750	1675/2000	5012	1297,66

Composto da:

qtà	descrizione
1	Banco smontato regolabile con piano in multiplex 30 mm
1	Armadio L=500 mm con 1 porta e 1 piano regolabile
1	Fondo di chiusura per armadio L=500 mm
1	Armadio L=500 mm con 4 cassetti H=105 mm
1	Kit 2 montanti biasolati
1	Kit 3 pannelli forati/mensole con 2 bordi fermacasse
6	Gancio Unipok per utensili - confezione 30 pezzi
2	Barra aggancio per contenitori Picking Box mis. 1/2
2	Kit 4 contenitori Picking Box Air mis. 1



Utensili esclusi



[CONFIGURE](#)

ART.	L mm	P mm	H mm	RAL	€
WORK1532	1500	750	1675/2000	7035+7016	1014,63
WORK1538	1500	750	1675/2000	5012	1165,60

Composto da:

qtà	descrizione
1	Banco smontato regolabile con piano in multiplex 30 mm
2	Armadio L=629 mm con 1 cassetto H=150 mm e 1 porta
1	Semipiano non fessurato L=1260 mm
1	Kit 2 montanti biasolati
1	Kit 3 pannelli forati/mensole con 2 bordi fermacasse
6	Gancio Unipok per utensili - confezione 30 pezzi
2	Barra aggancio per contenitori Picking Box mis. 1/2
2	Kit 4 contenitori Picking Box Air mis. 1



Utensili esclusi



[CONFIGURE](#)

ART.	L mm	P mm	H mm	RAL	€
WORK1533	1500	750	1675/2000	7035+7016	1152,89
WORK1539	1500	750	1675/2000	5012	1338,89

Composto da:

qtà	descrizione
1	Banco smontato regolabile con piano in multiplex 30 mm
1	Armadio L=629 mm con 1 porta e 1 piano regolabile
1	Armadio L=629 mm con 4 cassetti H=105 mm
1	Semipiano non fessurato L=1260 mm
1	Kit 2 montanti biasolati
1	Kit 3 pannelli forati/mensole con 2 bordi fermacasse
6	Gancio Unipok per utensili - confezione 30 pezzi
2	Barra aggancio per contenitori Picking Box mis. 1/2
2	Kit 4 contenitori Picking Box Air mis. 1



PORTATA



RAL 7035 + RAL 7016



RAL 5012



1000 kg

Forniti smontati

piano in multiplex spessore 30 mm

**Portata cassetti
80 kg**

Estrazione cassetto 86%



ART.	L mm	P mm	H mm	RAL	€
WORK2044	2000	750	882	7035+7016	438,96
WORK2045	2000	750	882	5012	469,34

Composto da:

qtà	descrizione
1	Banco smontato con piano in multiplex 30 mm
1	Armadio L=500 mm con 1 cassetto H=150 mm

CONFIGURE



ART.	L mm	P mm	H mm	RAL	€
WORK2046	2000	750	882	7035+7016	677,35
WORK2047	2000	750	882	5012	749,27

Composto da:

qtà	descrizione
1	Banco smontato con piano in multiplex 30 mm
1	Armadio L=500 mm con 4 cassette H=105 mm

CONFIGURE



ART.	L mm	P mm	H mm	RAL	€
WORK2048	2000	750	882	7035+7016	999,75
WORK2049	2000	750	882	5012	1109,49

Composto da:

qtà	descrizione
1	Banco smontato con piano in multiplex 30 mm
1	Armadio L=500 mm con 4 cassette H=105 mm
2	Armadio L=629 mm con 1 porta e 1 piano regolabile

CONFIGURE

 **1000 kg**

 **regolabili in altezza**

 **piano in multiplex spessore 30 mm**

 **Forniti smontati**

 **passo fori gambe 25 mm**



[CONFIGURE](#) 



[CONFIGURE](#) 



[CONFIGURE](#) 

ART.	L mm	P mm	H mm	RAL	€
 WORK2001	2000	750	732/1057	7035+7016	476,16
 WORK2002	2000	750	732/1057	5012	538,47

Composto da:

qtà	descrizione
1	Banco smontato regolabile con piano in multiplex 30 mm
1	Armadio L=500 mm con 1 cassetto H=150 mm

ART.	L mm	P mm	H mm	RAL	€
 WORK2003	2000	750	732/1057	7035+7016	764,15
 WORK2004	2000	750	732/1057	5012	874,51

Composto da:

qtà	descrizione
1	Banco smontato regolabile con piano in multiplex 30 mm
1	Armadio L=500 mm con 4 cassetti H=105 mm
1	Semipiano non fessurato L=1760 mm

ART.	L mm	P mm	H mm	RAL	€
 WORK2009	2000	750	732/1057	7035+7016	1086,55
 WORK2010	2000	750	732/1057	5012	1234,73

Composto da:

qtà	descrizione
1	Banco smontato regolabile con piano in multiplex 30 mm
1	Armadio L=500 mm con 4 cassetti H=105 mm
2	Armadio L=629 mm con 1 porta e 1 piano regolabile
1	Semipiano non fessurato L=1760 mm



PORTATA



RAL 7035 + RAL 7016



RAL 5012



1000 kg

regolabili in altezza

piano in multiplex spessore 30 mm

Forniti smontati

passo fori gambe 25 mm



ART.	L mm	P mm	H mm	RAL	€
WORK2005	2000	750	732/1057	7035+7016	912,33



WORK2006	2000	750	732/1057	5012	1041,60
-----------------	------	-----	----------	------	---------

Composto da:

qtà	descrizione
1	Banco smontato regolabile con piano in multiplex 30 mm
1	Armadio L=500 mm con 4 cassetti H=105 mm
1	Armadio L=500 mm con 1 porta e 1 piano regolabile
1	Semipiano non fessurato L=1760 mm

CONFIGURE



ART.	L mm	P mm	H mm	RAL	€
WORK2007	2000	750	732/1057	7035+7016	1004,40



WORK2008	2000	750	732/1057	5012	1153,51
-----------------	------	-----	----------	------	---------

Composto da:

qtà	descrizione
1	Banco smontato regolabile con piano in multiplex 30 mm
1	Armadio L=500 mm con 4 cassetti H=105 mm
1	Armadio L=500 mm con 1 porta e 1 piano regolabile
1	Chiusura posteriore
1	Semipiano non fessurato L=760 mm
1	Fondo di chiusura per armadio L=500 mm

CONFIGURE



ART.	L mm	P mm	H mm	RAL	€
WORK2011	2000	750	732/1057	7035+7016	984,87



WORK2012	2000	750	732/1057	5012	1091,82
-----------------	------	-----	----------	------	---------

Composto da:

qtà	descrizione
1	Banco smontato regolabile con piano in multiplex 30 mm
1	Armadio L=500 mm con 1 cassetto H=150 mm e 1 porta
2	Armadio L=629 mm con 1 cassetto H=150 mm e 1 porta
1	Semipiano non fessurato L=1760 mm

CONFIGURE

CONFIGURAZIONI ALTERNATIVE



Utensili esclusi

[CONFIGURE](#)

[SHOP](#)

PATENTED*

ART.	L mm	P mm	H mm	KG	RAL	€
WORK2043	2000	750	1977/2302	1000	7035+7016	2062,43

Composto da:

qtà	descrizione	qtà	descrizione
1	Banco smontato regolabile con piano in multiplex 30 mm	2	Kit 3 pannelli forati/mensole con 2 bordi fermacasse
2	Armadio L=629 mm con 1 porta e 1 piano regolabile	1	Lampada doppia
1	Armadio L=500 mm con 3 cassetti H=150 mm	2	Porta bombolette inclinato a 2 posti
1	Semipiano non fessurato L=1760 mm	1	Kit porta rotolo con carta Ø=240 mm
2	Pannello forato laterale	7	Gancio Unipok per utensili - confezione 30 pezzi
1	Cestino capacità 30 L	1	Supporto multipresa a 4 scomparti
2	Porta silicone inclinato a 2 posti	1	Multipresa schuko a 4 scomparti
1	Tasca porta documenti A4	1	Cavo di collegamento wieland schuko/francese
1	Kit 3 montanti biasolati	1	Mensola grande reversibile
1	Kit 3 supporti inclinati con 2 binari		



PORTATA



RAL 7035 + RAL 7016



RAL 5012



1000 kg



regolabili in altezza

piano in multiplex spessore 30 mm

Forniti smontati



passo fori gambe 25 mm



Utensili esclusi



[CONFIGURE](#)



Utensili esclusi



[CONFIGURE](#)



Utensili esclusi



[CONFIGURE](#)

ART.	L mm	P mm	H mm	RAL	€
WORK2030	2000	750	1675/2000	7035+7016	869,55
WORK2036	2000	750	1675/2000	5012	998,82

Composto da:

qtà	descrizione
1	Banco smontato regolabile con piano in multiplex 30 mm
1	Armadio L=500 mm con 1 cassetto H=150 mm
1	Kit 3 montanti biasolati
2	Kit 3 pannelli forati/mensole con 2 bordi fermacasse
6	Gancio Unipok per utensili - confezione 30 pezzi
4	Barra aggancio per contenitori Picking Box mis. 1/2
4	Kit 4 contenitori Picking Box Air mis. 1

ART.	L mm	P mm	H mm	RAL	€
WORK2031	2000	750	1675/2000	7035+7016	1157,54
WORK2037	2000	750	1675/2000	5012	1334,86

Composto da:

qtà	descrizione
1	Banco smontato regolabile con piano in multiplex 30 mm
1	Armadio L=500 mm con 4 cassetti H=105 mm
1	Semipiano non fessurato L=1760 mm
1	Kit 3 montanti biasolati
2	Kit 3 pannelli forati/mensole con 2 bordi fermacasse
6	Gancio Unipok per utensili - confezione 30 pezzi
4	Barra aggancio per contenitori Picking Box mis. 1/2
4	Kit 4 contenitori Picking Box Air mis. 1

ART.	L mm	P mm	H mm	RAL	€
WORK2032	2000	750	1675/2000	7035+7016	1305,72
WORK2038	2000	750	1675/2000	5012	1501,95

Composto da:

qtà	descrizione
1	Banco smontato regolabile con piano in multiplex 30 mm
1	Armadio L=500 mm con 1 porta e 1 piano regolabile
1	Armadio L=500 mm con 4 cassetti H=105 mm
1	Semipiano non fessurato L=1760 mm
1	Kit 3 montanti biasolati
2	Kit 3 pannelli forati/mensole con 2 bordi fermacasse
6	Gancio Unipok per utensili - confezione 30 pezzi
4	Barra aggancio per contenitori Picking Box mis. 1/2
4	Kit 4 contenitori Picking Box Air mis. 1

ESEMPI DI CONFIGURAZIONE

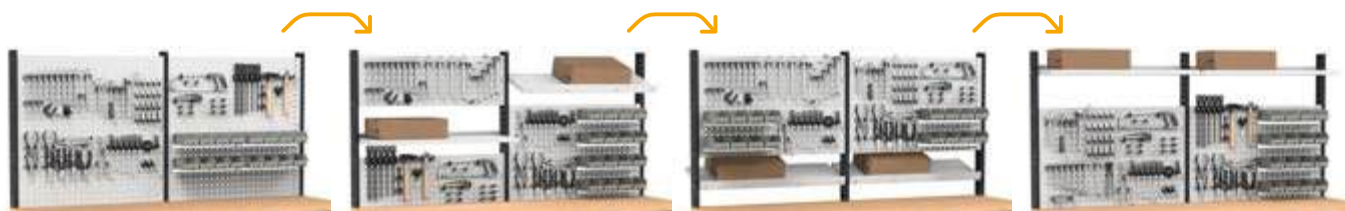

Utensili esclusi



[CONFIGURE](#)



Utensili esclusi



[CONFIGURE](#)



Utensili esclusi



[CONFIGURE](#)

ART.	L mm	P mm	H mm	RAL	€
WORK2033	2000	750	1675/2000	7035+7016	1397,79
WORK2039	2000	750	1675/2000	5012	1613,86

Composto da:

qtà	descrizione
1	Banco smontato regolabile con piano in multiplex 30 mm
1	Chiusura posteriore
1	Armadio L=500 mm con 1 porta e 1 piano regolabile
1	Fondo di chiusura per armadio L=500 mm
1	Armadio L=500 mm con 4 cassetti H=105 mm
1	Semipiano non fessurato L=760 mm
1	Kit 3 montanti biasolati
2	Kit 3 pannelli forati/mensole con 2 bordi fermacasse
6	Gancio Unipok per utensili - confezione 30 pezzi
4	Barra aggancio per contenitori Picking Box mis. 1/2
4	Kit 4 contenitori Picking Box Air mis. 1

ART.	L mm	P mm	H mm	RAL	€
WORK2034	2000	750	1675/2000	7035+7016	1378,26
WORK2040	2000	750	1675/2000	5012	1552,17

Composto da:

qtà	descrizione
1	Banco smontato regolabile con piano in multiplex 30 mm
2	Armadio L=629 mm con 1 cassetto H=150 mm e 1 porta
1	Armadio L=500 mm con 1 cassetto H=150 mm e 1 porta
1	Semipiano non fessurato L=1760 mm
1	Kit 3 montanti biasolati
2	Kit 3 pannelli forati/mensole con 2 bordi fermacasse
6	Gancio Unipok per utensili - confezione 30 pezzi
4	Barra aggancio per contenitori Picking Box mis. 1/2
4	Kit 4 contenitori Picking Box Air mis. 1

ART.	L mm	P mm	H mm	RAL	€
WORK2035	2000	750	1675/2000	7035+7016	1479,94
WORK2041	2000	750	1675/2000	5012	1695,08

Composto da:

qtà	descrizione
1	Banco smontato regolabile con piano in multiplex 30 mm
2	Armadio L=629 mm con 1 porta e 1 piano regolabile
1	Armadio L=500 mm con 4 cassetti H=105 mm
1	Semipiano non fessurato L=1760 mm
1	Kit 3 montanti biasolati
2	Kit 3 pannelli forati/mensole con 2 bordi fermacasse
6	Gancio Unipok per utensili - confezione 30 pezzi
4	Barra aggancio per contenitori Picking Box mis. 1/2
4	Kit 4 contenitori Picking Box Air mis. 1



PORTATA



RAL 7035 + RAL 7016



RAL 5012

L ➤ 1000 - 1500 - 2000 mm

 1000 kg

 piano in multiplex spessore 30 mm

 Forniti smontati

 piano in acciaio spessore 2,5 mm

BANCO CON PIANO IN ACCIAIO



3D



ART.	L mm	P mm	H mm	piano		RAL	€
				materiale	mm		
FBG01S1000F00PD	1031	704	887	Acciaio	2,5	7035+7016	224,44
FBG01S1000F0004	1031	704	887	Acciaio	2,5	5012	261,33
FBG01S1500F00PD	1507	704	887	Acciaio	2,5	7035+7016	280,55
FBG01S1500F0004	1507	704	887	Acciaio	2,5	5012	336,66
FBG01S2000F00PD	2007	704	887	Acciaio	2,5	7035+7016	332,01
FBG01S2000F0004	2007	704	887	Acciaio	2,5	5012	387,50

BANCO CON PIANO IN LEGNO



3D



ART.	L mm	P mm	H mm	piano		RAL	€
				materiale	mm		
FBG02S1000F0008	1024	750	882	Multiplex	30	7035	224,44
FBG02S1000F0004	1024	750	882	Multiplex	30	5012	236,22
FBG02S1500F0008	1500	750	882	Multiplex	30	7035	280,55
FBG02S1500F0004	1500	750	882	Multiplex	30	5012	295,12
FBG02S2000F0008	2000	750	882	Multiplex	30	7035	332,01
FBG02S2000F0004	2000	750	882	Multiplex	30	5012	355,57



IMBALLO BANCO SMONTATO



COPERTURA IN ACCIAIO GOMMATO A 2 LATI PER PIANO IN ACCIAIO

ART.	L mm	P mm	H mm	€
FBG32100007	1024	702	27	85,56
FBG32150007	1500	702	27	120,59
FBG32200007	2000	702	27	155,31



COPERTURA IN ACCIAIO GOMMATO A 2 LATI PER PIANO IN MULTIPLEX

ART.	L mm	P mm	H mm	€
FBL22300007	1024	750	22	85,56
MBC15752G020V07	1500	750	22	125,55
MBC20752G020V07	2000	750	22	160,89

WORK

COMPONENTI

L ➤ 1000 - 1500 - 2000 mm

 1000 kg

↑
↓ **regolabili in altezza**

 **piano in multiplex spessore 30 mm**

 **Forniti smontati**

 **passo fori gambe 25 mm**

 **piano in acciaio spessore 2,5 mm**



3D



3D



3D



3D



3D



3D



BANCO REGOLABILE CON PIANO IN ACCIAIO

ART.	L mm	P mm	H mm	piano		RAL	€
				materiale	 mm		
FBG01S1000R00PD	1031	704	737/1062	Acciaio	2,5	7035+7016	261,64
FBG01S1000R0004	1031	704	737/1062	Acciaio	2,5	5012	298,53
FBG01S1500R00PD	1507	704	737/1062	Acciaio	2,5	7035+7016	317,75
FBG01S1500R0004	1507	704	737/1062	Acciaio	2,5	5012	373,86
FBG01S2000R00PD	2007	704	737/1062	Acciaio	2,5	7035+7016	369,21
FBG01S2000R0004	2007	704	737/1062	Acciaio	2,5	5012	424,70

BANCO REGOLABILE CON PIANO IN LEGNO

ART.	L mm	P mm	H mm	piano		RAL	€
				materiale	 mm		
FBG02S1000R00PD	1024	750	732/1057	Multiplex	30	7035+7016	261,64
FBG02S1000R0004	1024	750	732/1057	Multiplex	30	5012	298,53
FBG02S1500R00PD	1500	750	732/1057	Multiplex	30	7035+7016	317,75
FBG02S1500R0004	1500	750	732/1057	Multiplex	30	5012	373,86
FBG02S2000R00PD	2000	750	732/1057	Multiplex	30	7035+7016	369,21
FBG02S2000R0004	2000	750	732/1057	Multiplex	30	5012	424,70



IMBALLO BANCO SMONTATO



KIT RUOTE

Adatte solo per banchi regolabili in altezza Work



3D

3D

ART.	Ø mm	 kg	H mm	materiale			€
FKRU1252101	125	300	155	Gomma antitraccia sintetica	2	2	56,73
FKRS1252101	125	750	155	Gomma elastica	2	2	90,83



RUOTA GIREVOLE CON FRENO



RUOTA FISSA



COPIA SQUADRE DI RINFORZO

ART.	L mm	P mm	H mm	RAL	€
FBGKITS0008	145	39	145	7035	17,67
FBGKITS0004	145	39	145	5012	18,60

 Utilizzare una coppia squadre per gamba se non è presente la cassetteria



PORTATA



SPESSORE



RAL 7035 + RAL 7016



RAL 5012



RAL 7035

WORK

COMPONENTI SCHEMA TECNICO

2000

1000



1500

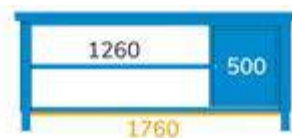
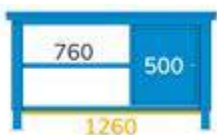

ARMADI

L → 500 mm

ARMADIO CON 1 CASSETTO



ART.	L mm	P mm	H mm	cassetti				RAL	€
				n.	H mm	KG	☑		
FBG03S50C0001PD	500	630	210	1	150	80	86%	7035+7016	106,95
FBG03S50C000104	500	630	210	1	150	80	86%	5012	113,77

ARMADIO CON 3 CASSETTI



ART.	L mm	P mm	H mm	cassetti				RAL	€
				n.	H mm	KG	☑		
FBG03S50C0002PD	500	630	570	3	150	80	86%	7035+7016	255,13
FBG03S50C000204	500	630	570	3	150	80	86%	5012	298,53

ARMADIO CON 4 CASSETTI



ART.	L mm	P mm	H mm	cassetti				RAL	€
				n.	H mm	KG	☑		
FBG03S50C0003PD	500	630	570	4	105	80	86%	7035+7016	345,34
FBG03S50C000304	500	630	570	4	105	80	86%	5012	393,70

ARMADIO CON 1 CASSETTO E 1 PORTA



ART.	L mm	P mm	H mm	cassetti				porta		RAL	€
				n.	H mm	KG	☑	n.	H ingresso mm		
FBG03S50C0004PD	500	630	570	1	150	80	86%	1	310	7035+7016	177,94
FBG03S50C000404	500	630	570	1	150	80	86%	1	310	5012	190,65

Senza fondo di chiusura

ARMADIO CON 1 PORTA E 1 PIANO





ART.	L mm	P mm	H mm	porta		RAL	€
				n.	H ingresso mm		
FBG03S50C0005PD	500	612	570	1	491	7035+7016	148,18
FBG03S50C000504	500	612	570	1	491	5012	167,09

Senza fondo di chiusura



FONDO DI CHIUSURA

FONDO DI CHIUSURA PER ARMADI L= 500 mm

ART.	L mm	P mm	H mm	RAL	€
 FBG16S50V0V0008	494	572	4	7035	32,86
 FBG16S50V0V0004	494	572	4	5012	36,27

 Da utilizzare sull'armadio con porta quando è presente il semipiano

FONDO DI CHIUSURA PER ARMADI L= 629 mm

ART.	L mm	P mm	H mm	RAL	€
 FBG16S63V0V0008	623	572	4	7035	32,86
 FBG16S63V0V0004	623	572	4	5012	36,27



 Da utilizzare sull'armadio con porta quando è presente il semipiano





ARMADI

L → 629 mm

ARMADIO CON 3 CASSETTI

ART.	L mm	P mm	H mm	cassetti				RAL	€
				n.	H mm	KG			
 FBG03S63C0002PD	629	630	570	3	150	80	86%	7035+7016	283,03
 FBG03S63C000204	629	630	570	3	150	80	86%	5012	324,88

ARMADIO CON 4 CASSETTI



ART.	L mm	P mm	H mm	cassetti				RAL	€
				n.	H mm	KG			
 FBG03S63C0003PD	629	630	570	4	105	80	86%	7035+7016	365,18
 FBG03S63C000304	629	630	570	4	105	80	86%	5012	413,54

ARMADIO CON 1 CASSETTO E 1 PORTA

ART.	L mm	P mm	H mm	cassetti				porta		RAL	€
				n.	H mm	KG		n.	H ingresso mm		
 FBG03S63C0004PD	629	630	570	1	150	80	86%	1	310	7035+7016	194,06
 FBG03S63C000404	629	630	570	1	150	80	86%	1	310	5012	210,18

 Senza fondo di chiusura

ARMADIO CON 1 PORTA E 1 PIANO

ART.	L mm	P mm	H mm	porta		RAL	€
				n.	H ingresso mm		
 FBG03S63C0005PD	629	612	570	1	491	7035+7016	161,20
 FBG03S63C000504	629	612	570	1	491	5012	180,11

 Senza fondo di chiusura



PORTATA

ESTRAZIONE

RAL 7035 + RAL 7016

RAL 5012

RAL 7035



CHIUSURA POSTERIORE

ART.	L mm	H mm	adatto per banco Lmm	RAL	€
FBG12S080000008	825	665	1024-1031	7035	48,05
FBG12S080000004	825	665	1024-1031	5012	56,11
FBG12S130000008	1325	665	1500-1507	7035	57,66
FBG12S130000004	1325	665	1500-1507	5012	70,99
FBG12S180000008	1825	665	2000-2007	7035	77,50
FBG12S180000004	1825	665	2000-2007	5012	95,48



COPIA TAMPONI LATERALI

Per banco L=1024-1031 mm con armadio L=629 mm

ART.	L mm	P mm	H mm	RAL	€
FBG14S130V00008	65	35	568	7035	18,29
FBG14S130V00004	65	35	568	5012	28,21



PANNELLO FORATO LATERALE

ART.	L mm	P mm	H mm	dim. foro mm	RAL	€
FBG15S00V0V0008	610	75	669	10x10	7035	46,19
FBG15S00V0V0004	610	75	669	10x10	5012	49,60



PIANO NON FESSURATO AGGIUNTIVO

ART.	L mm	P mm	H mm	KG	RAL	€
FBG08S070600108	760	600	35	250	7035	46,19
FBG08S070600104	760	600	35	250	5012	52,70
FBG08S120600108	1260	600	35	250	7035	61,07
FBG08S120600104	1260	600	35	250	5012	67,58
FBG08S170600108	1760	600	35	200	7035	77,50
FBG08S170600104	1760	600	35	200	5012	95,48

WORK

COMPONENTI



SEMIPIANO NON FESSURATO AGGIUNTIVO

ART.	Lmm	Pmm	Hmm	KG	RAL	€
FBG09S070300108	760	300	35	100	7035	31,31
FBG09S070300104	760	300	35	100	5012	36,27
FBG09S120300108	1260	300	35	100	7035	39,68
FBG09S120300104	1260	300	35	100	5012	44,64
FBG09S170300108	1760	300	35	100	7035	49,60
FBG09S170300104	1760	300	35	100	5012	56,11



SUPPORTO SOLO PER SEMIPIANO AGGIUNTIVO

ART.	Lmm	Pmm	Hmm	RAL	€
FBG13S605V00008	605	77	35	7035	9,92
FBG13S605V00004	605	77	35	5012	12,71



CONFIGURAZIONI ALTERNATIVE



Utensili esclusi

[CONFIGURE](#)

[SHOP](#)



ART.	Lmm	Pmm	Hmm	KG	RAL	€
WORK2042	2000	704	2098	1000	7035+7016	1942,46



PORTATA



RAL 7035 + RAL 7016



RAL 5012



RAL 7035



MATERIALE DI SEPARAZIONE

L → 500 mm



ART.	adatto per cassetto H mm	n. divisori trasversali	€
FBG18S50DV00199	105/150	3	13,02



ART.	adatto per cassetto H mm	n. divisori trasversali	n. divisori longitudinali	€
FBG18S50DV00299	105/150	1	1	9,30



ART.	adatto per cassetto H mm	componenti	€
FBG18S50CD00103	105/150	4 x Cassetta divisorio 100x50 mm	7,75



ART.	adatto per cassetto H mm	componenti	€
FBG18S50CD00203	105/150	3 x Cassetta divisorio 100x50 mm 2 x Cassetta divisorio 150x75 mm 1 x Cassetta divisorio 150x150 mm	11,78



ART.	adatto per cassetto H mm	componenti	€
MATSEP001	105/150	1 x FBG18S50CD00103 1 x FBG18S50CD00203 1 x FBG18S50DV00299	28,83



ART.	adatto per cassetto H mm	componenti	€
MATSEP002	105/150	1 x FBG18S50CD00103 2 x FBG18S50CD00203 1 x FBG18S50DV00299	40,61



TAPPETO PER CASSETTIERA L=500 MM

ART.	materiale	€
FBG18S50TP00107	Poliestere	4,65





MATERIALE DI SEPARAZIONE

L → 629 mm



ART.	adatto per cassetto H mm	n. divisori trasversali	€
FBG18S63DV00199	105/150	3	13,95



ART.	adatto per cassetto H mm	n. divisori trasversali	n. divisori longitudinali	€
FBG18S63DV00299	105/150	1	1	9,92



ART.	adatto per cassetto H mm	componenti	€
FBG18S63CD00103	105/150	5 x Cassetta divisorio 100x50 mm	9,61



ART.	adatto per cassetto H mm	componenti	€
FBG18S63CD00203	105/150	2 x Cassetta divisorio 75x75 mm 2 x Cassetta divisorio 150x75 mm 2 x Cassetta divisorio 150x150 mm	11,78



ART.	adatto per cassetto H mm	componenti	€
MATSEP003	105/150	1 x FBG18S63CD00103 1 x FBG18S63CD00203 1 x FBG18S63DV00299	31,31



ART.	adatto per cassetto H mm	componenti	€
MATSEP004	105/150	1 x FBG18S63CD00103 2 x FBG18S63CD00203 1 x FBG18S63DV00299	43,09



TAPPETO PER CASSETTIERA L=629 MM

ART.	materiale	€
FBG18S63TP00107	Poliestere	5,89



BANCHI COMPATTI

BR



Il banco BR presenta una **struttura modulare** che permette di ampliarlo e arricchirlo in qualsiasi momento, adattandosi costantemente ai bisogni dell'utilizzatore. Disponibile in **4 larghezze**, da 1000 a 3000 mm, è dotato di un robusto **piano** di lavoro in legno multiplex di **faggio** con spessore 40 mm e da **gambe regolabili in altezza** per una posizione ergonomica nel lavoro. Può essere allestito con soluzioni ad alta capacità come pareti porta attrezzi, armadi a ripiani, con porte e cassettiere. Quest'ultime sono personalizzabili sia in termini di estrazione, da 92 a 100%, che di portata, da 50 a 100 kg.

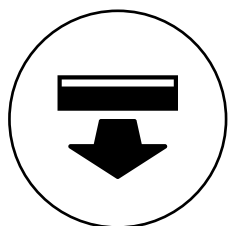

**CASSETTI AD
ESTRAZIONE
TOTALE**



**PORTATA
CASSETTI 50-75-
100 KG**

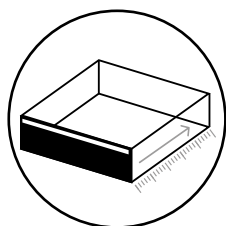

**PROFONDITÀ UTILE
CASSETTO 27 EH**

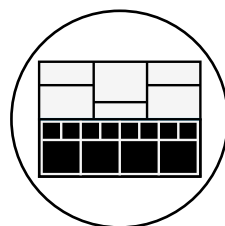

**MATERIALE DI
SEPARAZIONE**

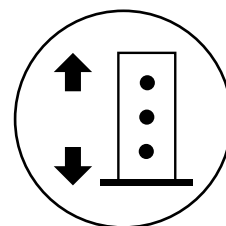

**GAMBE REGOLABILI IN
ALTEZZA**

BR



PIANO IN MULTIPLEX DI FAGGIO

Il piano in multiplex di faggio offre robustezza e resistenza, garantendo una superficie stabile e solida, perfetta per operazioni pesanti e di precisione. È resistente a graffi, urti e altre forme di usura e presenta uno spessore di 40 mm.



COPERTURA IN ACCIAIO GOMMATO

La copertura in acciaio gommato preserva l'integrità del piano di lavoro in caso di utilizzo di acidi o oli o si effettuino lavorazioni pesanti.



CHIUSURA POSTERIORE

La chiusura posteriore, presente di serie nei banchi BR, rinforza la struttura del banco e crea un vano nella parte inferiore, impedendo che il materiale stoccato cada accidentalmente.



SERRATURA

La serratura a cilindro si collega tramite un'asta quadra al gruppo di chiusura posteriore composto di un elemento rotante in materiale plastico e un'asta chiusura in lamiera di acciaio. Girando la chiave si aziona il sistema a camme del gruppo di chiusura che fa ruotare l'asta posteriore (A).



MATERIALE DI SEPARAZIONE

Il cassetto può essere suddiviso internamente tramite vassoi portautensili 5S Pikpad, cassette divisorio portaminuterie e divisori longitudinali e trasversali in metallo. Quest'ultimi sono fissati al fondo forato del cassetto tramite viti per evitare la fuoriuscita del materiale stoccato.



COMPONIBILE ED ESPANDIBILE

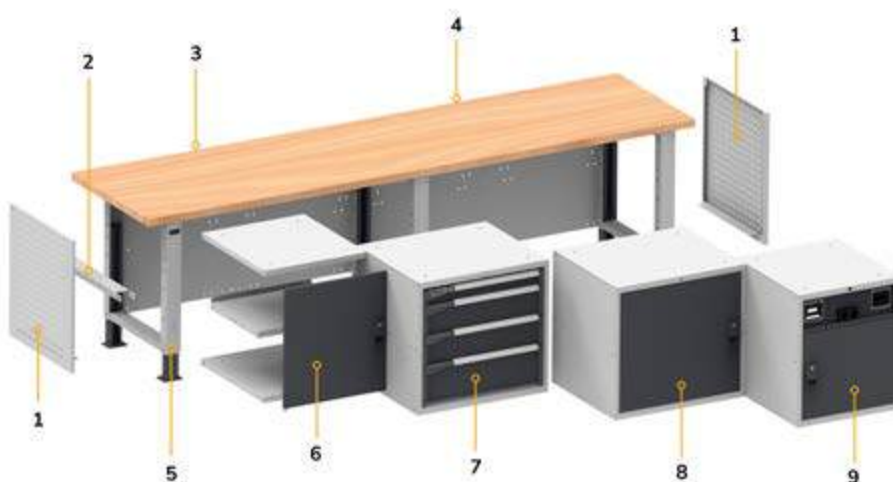

1. Pannello forato laterale
2. Supporto semipiano intermedio
3. Chiusura posteriore
4. Piano in Multiplex
5. Gambe regolabili
6. Modulo componibile
7. Armadio a cassette
8. Armadio con porta
9. Armadio tecnico con porta

ESTRAZIONE E GESTIONE DEL CASSETTO

Il cassetto Master DE rappresenta una rivoluzione nel mondo dell'arredo industriale in quanto è stato ideato e sviluppato per essere personalizzato autonomamente in termini di estrazione/portata e suddivisione interna.



LIBERAMENTE CONFIGURABILE

La nuova guida ad **estrazione flessibile** permette la regolazione meccanica del fermo posteriore del cassetto/piano estraibile, in **3 diverse posizioni** ottenendo così **3 portate differenti: 50, 75, 100 kg**. Un'etichetta indica la portata massima del cassetto a seconda della sua estrazione e del tipo di guida.



GUIDA FLESSIBILE CONFIGURATA PER ESTRAZIONE TOTALE 50 KG

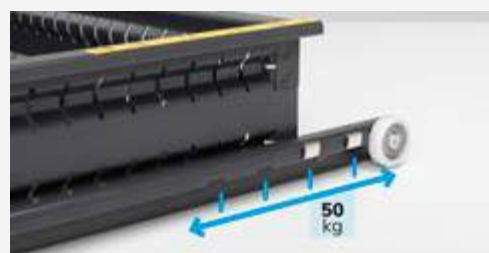
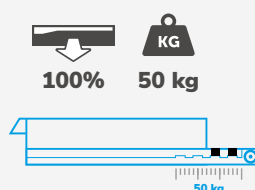

GUIDA FLESSIBILE CONFIGURATA PER ESTRAZIONE TOTALE 75 KG

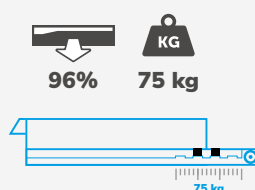

GUIDA FLESSIBILE CONFIGURATA PER ESTRAZIONE PARZIALE 100 KG

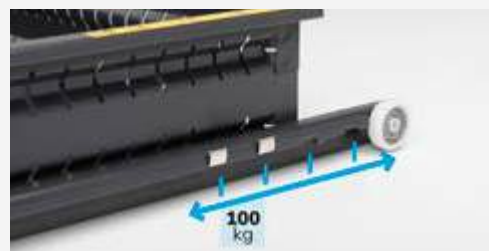
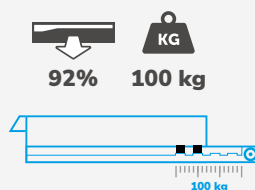

ESTRAZIONE TOTALE



LIBERTÀ NELLA CONFIGURAZIONE
Modifica velocemente e facilmente l'estrazione del cassetto per aumentare la portata fino a 100 kg.

GUIDE AD ALTE PRESTAZIONI



CORRERE SENZA PROBLEMI
Le guide lunghe come i cassetti permettono di spostare il cuscinetto nella parte frontale dell'armadio aumentando visibilità, portata ed estrazione.

CASSETTI FORATI



ORGANIZZAZIONE AL MILLIMETRO
Fori e scanalature sui cassetti facilitano la suddivisione interna del cassetto per una perfetta organizzazione di utensili e materiali.



Le innovazioni che semplificano l'identificazione dei contenuti all'interno dei cassette.

Con la tecnologia Syfront di Sylogik® il frontale del cassetto non è più solo un elemento di chiusura, ma diventa una vera interfaccia visiva.

- Personalizzazione con elementi estetici e decorativi
- Input utente: etichette per la descrizione e catalogazione del contenuto
- Output utente: possibilità di inserire messaggi visivi o descrittivi sulla maniglia

MANIGLIE PERSONALIZZABILI

UNA MINIERA DI INFORMAZIONI

Inserisci nella maniglia codici a barre, etichette o immagini per conoscere velocemente il contenuto di ogni singolo cassetto.



COLORI

L'armadio Master è disponibile in 12 combinazioni di colore a cui associare 8 diversi colori per le maniglie per creare soluzioni personalizzate nel minimo dettaglio. È possibile, quindi, assegnare a particolari aree di lavoro o progetti colori specifici oppure implementare il colore aziendale anche negli arredi installati in azienda.

10 colori RAL per la parte metallica
8 colori per gli accessori plastici

Combinazioni infinite

MANIGLIA FRONTALE



BANCHI



* Su richiesta

	START	PRO	PRO+
	WORK	BR	MASTER
Larghezza mm	1000-1500-2000	1024-1500-2000-3000	1300-1500-2000-2500-3000
Tipologia piani lavoro	Acciaio Multiplex	Multiplex	Multiplex
Profondità piano lavoro mm	750	750	750-800*
Spessore piano lavoro in multiplex di faggio mm	30	40	40-50*
Copertura	Gommato	Gommato	Gommato
Portata banco kg	1000	1000	800 - 1500
Regolabile in altezza	✓	✓	✓
Gambe fisse	✓	-	✓
Gambe con ruote	Banco regolabile	-	✓
Gambe elettrificate	-	-	✓
Profondità utile cassetti	513 mm	447 mm - 27 EH	600 mm - 36 EH
Cassetto estrazione totale	-	✓	✓
Portata cassetti kg	80	50-75-100	50-75-100-200
Asta anti ribaltamento cassetto	-	✓	✓
Parete attrezzata	✓	✓	✓
Chiusura posteriore	Accessorio	Di serie	Accessorio*



* Su richiesta

[CONFIGURE](#)
[SHOP](#)

ART.	L mm	P mm	H mm	KG	RAL	€
MASTERBR2007	2000	750	1805/2130	1000	7035+7016	2848,90

Composto da:

qtà	descrizione	qtà	descrizione
1	Banco smontato con piano in multiplex 40 mm	2	Pensile vasistas senza serratura
1	Armadio L=560 mm con 4 cassetti 1x75 2x150 1x200	2	Coppia staffe di fissaggio pensile su montanti
4	Piano superiore/inferiore L=560 mm	2	Barra led
1	Porta totale destra H=600 mm con maniglia Dark Grey	2	Multipresa schuko a 2 scomparti
1	Porta totale sinistra H=600 mm con maniglia Dark Grey	1	Multipresa schuko a 4 scomparti
2	Supporto semipiano intermedio	1	Magnetotermico differenziale
2	Piano interno L=558 mm	1	Cavo di collegamento wieland schuko/francese
2	Pannello forato laterale	1	Tasca porta documenti A4
1	Pannello forato/mensola con 1 bordo fermacasse	1	Kit porta rotolo con carta Ø=240 mm
1	Kit 3 montanti biasolati	2	Porta bombolette inclinato a 2 posti
1	Kit 2 pannelli forati/mensole con 1 bordo fermacasse	5	Gancio Unipok per utensili - confezione 30 pezzi
1	Pannello forato Electric	1	Cestino capacità 30 L



PORTATA



RAL 7035 + RAL 7016



1000 kg

regolabili in altezza

piano in multiplex spessore 40 mm

Forniti smontati

passo fori gambe 25 mm



ART.	L mm	P mm	H mm	RAL	€
MASTERBR1505	1500	750	740/1065	7035+7016	798,87

Composto da:

qtà	descrizione
1	Banco smontato con piano in multiplex 40 mm
1	Armadio L=560 mm con 3 cassetti 1x75 2x100
1	Coppia squadre di rinforzo



CONFIGURE



ART.	L mm	P mm	H mm	RAL	€
MASTERBR1506	1500	750	740/1065	7035+7016	874,82

Composto da:

qtà	descrizione
1	Banco smontato con piano in multiplex 40 mm
1	Armadio L=560 mm con 4 cassetti 1x75 2x150 1x200
1	Coppia squadre di rinforzo



CONFIGURE



ART.	L mm	P mm	H mm	RAL	€
MASTERBR1501	1500	750	740/1065	7035+7016	1020,21

Composto da:

qtà	descrizione
1	Banco smontato con piano in multiplex 40 mm
1	Armadio L=560 mm con 4 cassetti 1x75 2x150 1x200
2	Semipiano aggiuntivo L=560 mm
1	Supporto semipiano intermedio
2	Pannello forato laterale



CONFIGURE



ESEMPI DI CONFIGURAZIONE



Utensili esclusi



CONFIGURE



Utensili esclusi



CONFIGURE



Utensili esclusi



CONFIGURE



ART.	L mm	P mm	H mm	RAL	€
MASTERBR1514	1500	750	1683/2008	7035+7016	1067,95

Composto da:

qtà	descrizione
1	Banco smontato con piano in multiplex 40 mm
1	Armadio L=560 mm con 3 cassetti 1x75 2x100
1	Coppia squadre di rinforzo
1	Kit 2 montanti biasolati
1	Kit 3 pannelli forati/mensole con 2 bordi fermacasse
6	Gancio Unipok per utensili - confezione 30 pezzi
2	Barra aggancio per contenitori Picking Box mis. 1/2
2	Kit 4 contenitori Picking Box Air mis. 1



ART.	L mm	P mm	H mm	RAL	€
MASTERBR1515	1500	750	1683/2008	7035+7016	1143,90

Composto da:

qtà	descrizione
1	Banco smontato con piano in multiplex 40 mm
1	Armadio L=560 mm con 4 cassetti 1x75 2x150 1x200
1	Coppia squadre di rinforzo
1	Kit 2 montanti biasolati
1	Kit 3 pannelli forati/mensole con 2 bordi fermacasse
6	Gancio Unipok per utensili - confezione 30 pezzi
2	Barra aggancio per contenitori Picking Box mis. 1/2
2	Kit 4 contenitori Picking Box Air mis. 1



ART.	L mm	P mm	H mm	RAL	€
MASTERBR1510	1500	750	1683/2008	7035+7016	1289,29

Composto da:

qtà	descrizione
1	Banco smontato con piano in multiplex 40 mm
2	Pannello forato laterale
1	Armadio L=560 mm con 4 cassetti 1x75 2x150 1x200
2	Semipiano aggiuntivo L=560 mm
1	Supporto semipiano intermedio
1	Kit 2 montanti biasolati
1	Kit 3 pannelli forati/mensole con 2 bordi fermacasse
6	Gancio Unipok per utensili - confezione 30 pezzi
2	Barra aggancio per contenitori Picking Box mis. 1/2
2	Kit 4 contenitori Picking Box Air mis. 1



PORTATA

RAL 7035 + RAL 7016



1000 kg

regolabili in altezza

piano in multiplex spessore 40 mm

Forniti smontati

passo fori gambe 25 mm



ART.	L mm	P mm	H mm	RAL	€
MASTERBR1502	1500	750	740/1065	7035+7016	1112,28

Composto da:

qtà	descrizione
1	Banco smontato con piano in multiplex 40 mm
1	Armadio L=560 mm con 4 cassetti 1x75 2x150 1x200
2	Piano superiore/inferiore L=560 mm
1	Porta totale sinistra H=600 mm con maniglia Dark Grey
1	Supporto semipiano intermedio
1	Piano interno L=558 mm
2	Pannello forato laterale

[CONFIGURE](#)

ART.	L mm	P mm	H mm	RAL	€
MASTERBR1503	1500	750	740/1065	7035+7016	1469,71

Composto da:

qtà	descrizione
1	Banco smontato con piano in multiplex 40 mm
1	Armadio L=560 mm con 4 cassetti 1x75 2x150 1x200
1	Armadio L=560 mm con 5 cassetti 1x75 3x100 1x200

[CONFIGURE](#)

ART.	L mm	P mm	H mm	RAL	€
MASTERBR1504	1500	750	740/1065	7035+7016	1041,29

Composto da:

qtà	descrizione
1	Banco smontato con piano in multiplex 40 mm
2	Armadio L=560 mm predisposto per porta con 1 cassetto H=150 mm
1	Porta parziale sinistra H=435 mm con maniglia Dark Grey
1	Porta parziale destra H=435 mm con maniglia Dark Grey

[CONFIGURE](#)



ESEMPI DI CONFIGURAZIONE



Utensili esclusi



CONFIGURE



Utensili esclusi



CONFIGURE



Utensili esclusi



CONFIGURE



ART.	L mm	P mm	H mm	RAL	€
MASTERBR1511	1500	750	1683/2008	7035+7016	1381,36

Composto da:

qtà	descrizione
1	Banco smontato con piano in multiplex 40 mm
2	Pannello forato laterale
1	Armadio L=560 mm con 4 cassetti 1x75 2x150 1x200
2	Piano superiore/inferiore L=560 mm
1	Porta totale sinistra H=600 mm con maniglia Dark Grey
1	Piano interno L=558 mm
1	Supporto semipiano intermedio
1	Kit 2 montanti biasolati
1	Kit 3 pannelli forati/mensole con 2 bordi fermacasse
6	Gancio Unipok per utensili - confezione 30 pezzi
2	Barra aggancio per contenitori Picking Box mis. 1/2
2	Kit 4 contenitori Picking Box Air mis. 1



ART.	L mm	P mm	H mm	RAL	€
MASTERBR1512	1500	750	1683/2008	7035+7016	1738,79

Composto da:

qtà	descrizione
1	Banco smontato con piano in multiplex 40 mm
1	Armadio L=560 mm con 4 cassetti 1x75 2x150 1x200
1	Armadio L=560 mm con 5 cassetti 1x75 3x100 1x200
1	Kit 2 montanti biasolati
1	Kit 3 pannelli forati/mensole con 2 bordi fermacasse
6	Gancio Unipok per utensili - confezione 30 pezzi
2	Barra aggancio per contenitori Picking Box mis. 1/2
2	Kit 4 contenitori Picking Box Air mis. 1



ART.	L mm	P mm	H mm	RAL	€
MASTERBR1513	1500	750	1683/2008	7035+7016	1310,37

Composto da:

qtà	descrizione
1	Banco smontato con piano in multiplex 40 mm
2	Armadio L=560 mm predisposto per porta con 1 cassetto H=150 mm
1	Porta parziale sinistra H=435 mm con maniglia Dark Grey
1	Porta parziale destra H=435 mm con maniglia Dark Grey
1	Kit 2 montanti biasolati
1	Kit 3 pannelli forati/mensole con 2 bordi fermacasse
6	Gancio Unipok per utensili - confezione 30 pezzi
2	Barra aggancio per contenitori Picking Box mis. 1/2
2	Kit 4 contenitori Picking Box Air mis. 1



PORTATA



RAL 7035 + RAL 7016



1000 kg

regolabili in altezza

piano in multiplex spessore 40 mm

Forniti smontati

passo fori gambe 25 mm



ART.	L mm	P mm	H mm	RAL	€
MASTERBR2005	2000	750	740/1065	7035+7016	855,29

Composto da:

qtà	descrizione
1	Banco smontato con piano in multiplex 40 mm
1	Armadio L=560 mm con 3 cassetti 1x75 2x100
1	Coppia squadre di rinforzo

[CONFIGURE](#)

ART.	L mm	P mm	H mm	RAL	€
MASTERBR2006	2000	750	740/1065	7035+7016	931,24

Composto da:

qtà	descrizione
1	Banco smontato con piano in multiplex 40 mm
1	Armadio L=560 mm con 4 cassetti 1x75 2x150 1x200
1	Coppia squadre di rinforzo

[CONFIGURE](#)



ART.	L mm	P mm	H mm	RAL	€
MASTERBR2001	2000	750	740/1065	7035+7016	1248,68

Composto da:

qtà	descrizione
1	Banco smontato con piano in multiplex 40 mm
1	Armadio L=560 mm con 4 cassetti 1x75 2x150 1x200
1	Armadio L=560 mm predisposto per porta con 1 piano regolabile
1	Porta totale sinistra H=600 mm con maniglia Dark Grey
2	Semipiano aggiuntivo L=560 mm

[CONFIGURE](#)

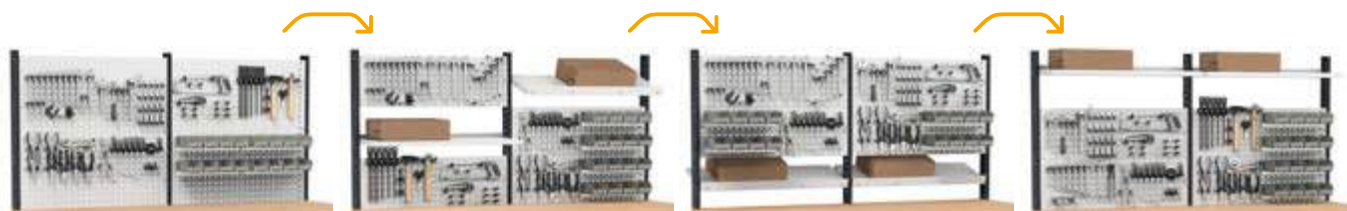
ESEMPI DI CONFIGURAZIONE



Utensili esclusi



ART.	L mm	P mm	H mm	RAL	€
MASTERBR2013	2000	750	1683/2008	7035+7016	1248,68

Composto da:

qtà	descrizione
1	Banco smontato con piano in multiplex 40 mm
1	Armadio L=560 mm con 3 cassetti 1x75 2x100
1	Coppia squadre di rinforzo
1	Kit 3 montanti biasolati
2	Kit 3 pannelli forati/mensole con 2 bordi fermacasse
6	Gancio Unipok per utensili - confezione 30 pezzi
4	Barra aggancio per contenitori Picking Box mis. 1/2
4	Kit 4 contenitori Picking Box Air mis. 1



Utensili esclusi



ART.	L mm	P mm	H mm	RAL	€
MASTERBR2014	2000	750	1683/2008	7035+7016	1324,63

Composto da:

qtà	descrizione
1	Banco smontato con piano in multiplex 40 mm
1	Armadio L=560 mm con 4 cassetti 1x75 2x150 1x200
1	Coppia squadre di rinforzo
1	Kit 3 montanti biasolati
2	Kit 3 pannelli forati/mensole con 2 bordi fermacasse
6	Gancio Unipok per utensili - confezione 30 pezzi
4	Barra aggancio per contenitori Picking Box mis. 1/2
4	Kit 4 contenitori Picking Box Air mis. 1



Utensili esclusi



ART.	L mm	P mm	H mm	RAL	€
MASTERBR2009	2000	750	1683/2008	7035+7016	1642,07

Composto da:

qtà	descrizione
1	Banco smontato con piano in multiplex 40 mm
1	Armadio L=560 mm predisposto per porta con 1 piano regolabile
1	Porta totale sinistra H=600 mm con maniglia Dark Grey
1	Armadio L=560 mm con 4 cassetti 1x75 2x150 1x200
2	Semipiano aggiuntivo L=560 mm
1	Kit 3 montanti biasolati
2	Kit 3 pannelli forati/mensole con 2 bordi fermacasse
6	Gancio Unipok per utensili - confezione 30 pezzi
4	Barra aggancio per contenitori Picking Box mis. 1/2
4	Kit 4 contenitori Picking Box Air mis. 1



PORTATA

RAL 7035 + RAL 7016



1000 kg

regolabili in altezza

piano in multiplex spessore 40 mm

Forniti smontati

passo fori gambe 25 mm



ART.	L mm	P mm	H mm	RAL	€
MASTERBR2002	2000	750	740/1065	7035+7016	1586,89

Composto da:

qtà	descrizione
1	Banco smontato con piano in multiplex 40 mm
1	Armadio L=560 mm con 4 cassetti 1x75 2x150 1x200
1	Armadio L=560 mm con 5 cassetti 1x75 3x100 1x200
2	Semipiano aggiuntivo L=560 mm



CONFIGURE



ART.	L mm	P mm	H mm	RAL	€
MASTERBR2003	2000	750	740/1065	7035+7016	1412,67

Composto da:

qtà	descrizione
1	Banco smontato con piano in multiplex 40 mm
1	Armadio L=560 mm con 5 cassetti 1x75 3x100 1x200
4	Piano superiore/inferiore L=560 mm
1	Porta totale destra H=600 mm con maniglia Dark Grey
1	Porta totale sinistra H=600 mm con maniglia Dark Grey
2	Supporto semipiano intermedio
2	Piano interno L=558 mm
2	Pannello forato laterale



CONFIGURE



ART.	L mm	P mm	H mm	RAL	€
MASTERBR2004	2000	750	740/1065	7035+7016	1455,45

Composto da:

qtà	descrizione
1	Banco smontato con piano in multiplex 40 mm
3	Armadio L=560 mm predisposto per porta con 1 cassetto H=150 mm
1	Porta parziale destra H=435 mm con maniglia Dark Grey
2	Porta parziale sinistra H=435 mm con maniglia Dark Grey



CONFIGURE



ESEMPI DI CONFIGURAZIONE

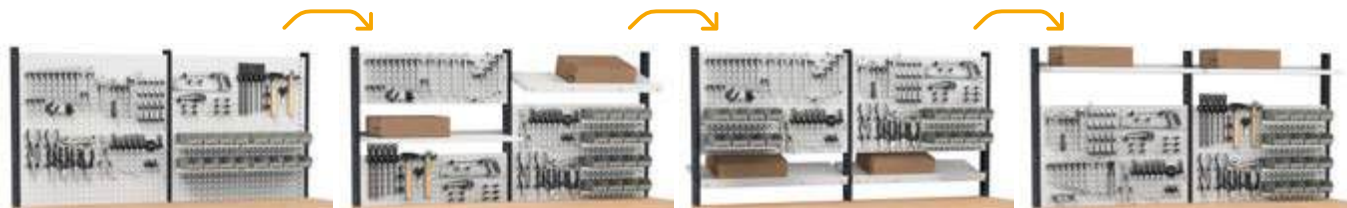

Utensili esclusi



CONFIGURE



ART.	L mm	P mm	H mm	RAL	€
MASTERBR2010	2000	750	1683/2008	7035+7016	1980,28

Composto da:

qtà	descrizione
1	Banco smontato con piano in multiplex 40 mm
1	Armadio L=560 mm con 5 cassetti 1x75 3x100 1x200
1	Armadio L=560 mm con 4 cassetti 1x75 2x150 1x200
2	Semipiano aggiuntivo L=560 mm
1	Kit 3 montanti biasolati
2	Kit 3 pannelli forati/mensole con 2 bordi fermacasse
6	Gancio Unipok per utensili - confezione 30 pezzi
4	Barra aggancio per contenitori Picking Box mis. 1/2
4	Kit 4 contenitori Picking Box Air mis. 1



ART.	L mm	P mm	H mm	RAL	€
MASTERBR2011	2000	750	1683/2008	7035+7016	1806,06

Composto da:

qtà	descrizione
1	Banco smontato con piano in multiplex 40 mm
4	Piano superiore/inferiore L=560 mm
1	Porta totale sinistra H=600 mm con maniglia Dark Grey
1	Porta totale destra H=600 mm con maniglia Dark Grey
2	Piano interno L=558 mm
2	Supporto semipiano intermedio
1	Armadio L=560 mm con 5 cassetti 1x75 3x100 1x200
2	Pannello forato laterale
1	Kit 3 montanti biasolati
2	Kit 3 pannelli forati/mensole con 2 bordi fermacasse
6	Gancio Unipok per utensili - confezione 30 pezzi
4	Barra aggancio per contenitori Picking Box mis. 1/2
4	Kit 4 contenitori Picking Box Air mis. 1



ART.	L mm	P mm	H mm	RAL	€
MASTERBR2012	2000	750	1683/2008	7035+7016	1848,84

Composto da:

qtà	descrizione
1	Banco smontato con piano in multiplex 40 mm
3	Armadio L=560 mm predisposto per porta con 1 cassetto H=150 mm
2	Porta parziale sinistra H=435 mm con maniglia Dark Grey
1	Porta parziale destra H=435 mm con maniglia Dark Grey
1	Kit 3 montanti biasolati
2	Kit 3 pannelli forati/mensole con 2 bordi fermacasse
6	Gancio Unipok per utensili - confezione 30 pezzi
4	Barra aggancio per contenitori Picking Box mis. 1/2
4	Kit 4 contenitori Picking Box Air mis. 1



Utensili esclusi



CONFIGURE



PORTATA



RAL 7035 + RAL 7016

COMPONENTI

 1000 kg

 regolabili in altezza

 piano in multiplex spessore 40 mm

 Forniti smontati

 passo fori gambe 25 mm

ART.	L mm	P mm	H mm	piano		RAL	€
				materiale	mm		
MBR01S0V0V001PD	1024	750	740/1065	Multiplex	40	7035+7016	279,62

[CONFIGURE](#)
[SHOP](#)

ART.	L mm	P mm	H mm	piano		RAL	€
				materiale	mm		
MBR02S0V0V001PD	1500	750	740/1065	Multiplex	40	7035+7016	325,81

[CONFIGURE](#)
[SHOP](#)

ART.	L mm	P mm	H mm	piano		RAL	€
				materiale	mm		
MBR03S0V0V001PD	2000	750	740/1065	Multiplex	40	7035+7016	382,23

[CONFIGURE](#)
[SHOP](#)

ART.	L mm	P mm	H mm	piano		RAL	€
				materiale	mm		
MBR04S0V0V001PD	3000	750	740/1065	Multiplex	40	7035+7016	672,39

[CONFIGURE](#)
[SHOP](#)

IMBALLO BANCO SMONTATO



COPPIA SQUADRE DI RINFORZO

ART.	L mm	P mm	H mm	RAL	€
FBGKITS0008	145	39	145	7035	17,67

 Utilizzare una squadra per gamba se non è presente la cassettera o il piano (una coppia per banchi 1024/1500/2000, due coppie per banchi 3000)

[SHOP](#)

BR

COMPONENTI



COPERTURA IN ACCIAIO GOMMATO A 2 LATI PER PIANO IN MULTIPLEX

ART.	L mm	P mm	H mm	€
FBL22300007	1024	750	22	85,56
MBC15752G020V07	1500	750	22	125,55
MBC20752G020V07	2000	750	22	160,89
MBC30752G020V07	3000	750	22	281,17

SCHEMA TECNICO

L → 1000 mm



L → 1500 mm

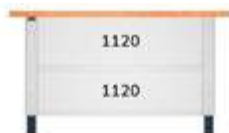

L → 2000 mm

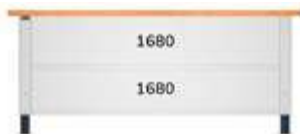

L → 3000 mm

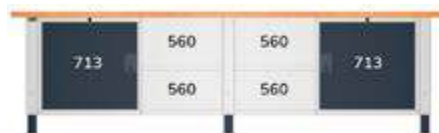
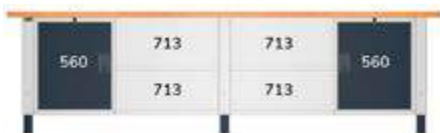

PORTATA



SPESORE



RAL 7035 + RAL 7016



RAL 7035

ARMADIO CON 3 CASSETTI



ART.	L mm	P mm	H mm	cassetti					RAL	€
				n.	H 75 mm	H 100 mm	KG			
MBR05SC010203PD	560	610	369	3	1	2	100-75-50	92-96-100%	7035+7016	455,39



ARMADIO CON 4 CASSETTI



ART.	L mm	P mm	H mm	cassetti					RAL	€	
				n.	H 75 mm	H 150 mm	H 200 mm	KG			
MBR05SC010204PD	560	610	669	4	1	2	1	100-75-50	92-96-100%	7035+7016	531,34



ARMADIO CON 5 CASSETTI



ART.	L mm	P mm	H mm	cassetti					RAL	€	
				n.	H 75 mm	H 100 mm	H 200 mm	KG			
MBR05SC010205PD	560	610	669	5	1	3	1	100-75-50	92-96-100%	7035+7016	612,56



ARMADIO CON PIANO INTERMEDIO PREDISPOSTO PER PORTE



ART.	L mm	P mm	H mm	piano regolabile	RAL	€
MBR05SX00020708	560	610	669	1	7035	217,62



PORTA TOTALE SINISTRA H=600 MM CON MANIGLIA DARK GREY



ART.	L mm	P mm	H mm	apertura	RAL	€
MBR06SC01020239	504	34	600	Sinistra	7016	56,73



PORTA TOTALE DESTRA H=600 MM CON MANIGLIA DARK GREY



ART.	L mm	P mm	H mm	apertura	RAL	€
MBR06SC01020139	504	34	600	Destra	7016	56,73





ARMADIO TECNICO L=560 MM PREDISPOSTO PER PORTA
Adatto per porte Art. MBR06SC01020339 e Art. MBR06SC01020439

ART.	L mm	P mm	H mm	RAL	€
MBR05SX000208PD	560	610	669	7035+7016	241,49



ARROTOLATORE ELETTRICO CON PRESA SCHUKO

ART.	L cavo m	tipo presa	Volt	Watt	€
MBR13S0V0V00100	20	Schuko	230	1600	578,46



ARROTOLATORE PER ARIA COMPRESSA

ART.	L cavo m	pressione max Mpa	Ø mm	€
MBR13S0V0V00200	14	1,5	10	265,67



RULLO PER ARROTOLATORE

ART.	€
MBR13S0V0V00339	30,07



PIASTRA PER ARROTOLATORE
Da fissare alla parte posteriore dell'armadio

ART.	€
MBR13S0V0V00499	21,39



1. Armadio tecnico L=560 mm predisposto per porta
2. Modulo: Rullo per arrotolatore

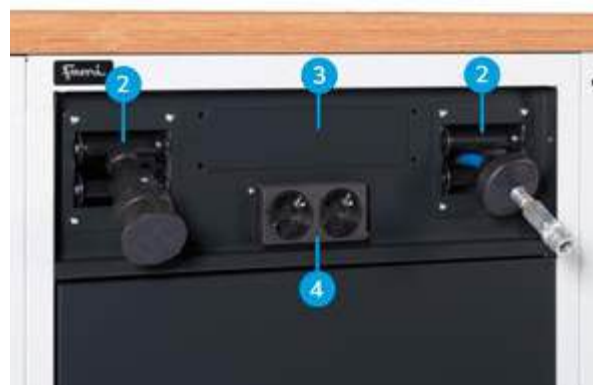

3. Modulo: Multipresa a 4 scomparti
4. Modulo: Multipresa a 2 scomparti



PORTATA



ESTRAZIONE



RAL 7035 + RAL 7016



RAL 7016



RAL 7035

L → 560 mm

27X27 EH

ARMADIO L=560 MM PREDISPOSTO PER PORTA CON 1 CASSETTO H=150 MM



ART.	L mm	P mm	H mm	cassetti			RAL	€
				H 150 mm	KG	↓		
MBR05SC010206PD	560	610	669	1	100-75-50	92-96-100%	7035+7016	303,49



PORTA PARZIALE SINISTRA H=435 MM CON MANIGLIA DARK GREY



ART.	L mm	P mm	H mm	apertura	RAL	€
MBR06SC01020439	504	34	435	Sinistra	7016	54,25



PORTA PARZIALE DESTRA H=435 MM CON MANIGLIA DARK GREY



ART.	L mm	P mm	H mm	apertura	RAL	€
MBR06SC01020339	504	34	435	Destra	7016	54,25



ARMADI CON CASSETTI

L → 713 mm

36X27 EH

ARMADIO L=713 MM CON 4 CASSETTI 1X75 2X150 1X200



ART.	L mm	P mm	H mm	cassetti					RAL	€	
				n.	H 75 mm	H 150 mm	H 200 mm	KG			↓
MBR05SC010304PD	713	610	669	4	1	2	1	100-75-50	92-96-100%	7035+7016	563,89



ARMADIO L=713 MM CON 5 CASSETTI 1X75 3X100 1X200



ART.	L mm	P mm	H mm	cassetti					RAL	€	
				n.	H 75 mm	H 100 mm	H 200 mm	KG			↓
MBR05SC010305PD	713	610	669	5	1	3	1	100-75-50	92-96-100%	7035+7016	636,12





ARMADIO L=713 MM PREDISPOSTO PER PORTA CON 1 PIANO REGOLABILE

ART.	L mm	P mm	H mm	RAL	€
MBR05SX00030708	713	610	669	7035	234,05



PORTA TOTALE SINISTRA H=600 MM CON MANIGLIA DARK GREY

ART.	L mm	P mm	H mm	apertura	RAL	€
MBR06SC01030239	657	34	600	Sinistra	7016	60,76





PORTA TOTALE DESTRA H=600 MM CON MANIGLIA DARK GREY

ART.	L mm	P mm	H mm	apertura	RAL	€
MBR06SC01030139	657	34	600	Destra	7016	60,76



ARMADIO L=713 MM PREDISPOSTO PER PORTA CON 1 CASSETTO H=150 MM

ART.	L mm	P mm	H mm	cassetti			RAL	€
				H 150 mm				
MBR05SC010306PD	713	610	669	1	100-75-50	92-96-100%	7035+7016	330,15



PORTA PARZIALE SINISTRA H=435 MM CON MANIGLIA DARK GREY

ART.	L mm	P mm	H mm	apertura	RAL	€
MBR06SC01030439	657	34	435	Sinistra	7016	57,35



PORTA PARZIALE DESTRA H=435 MM CON MANIGLIA DARK GREY

ART.	L mm	P mm	H mm	apertura	RAL	€
MBR06SC01030339	657	34	435	Destra	7016	57,35



PORTATA



ESTRAZIONE



RAL 7035 + RAL 7016



RAL 7016



RAL 7035



PANNELLO FORATO LATERALE

ART.	L mm	P mm	H mm	dim. foro mm	RAL	€
FBG15S00V0V0008	610	75	669	10x10	7035	46,19



PIANO AGGIUNTIVO

ART.	L mm	P mm	H mm	KG	RAL	€
MBR08S070600008	713	605	35	250	7035	44,64
MBR08S090600008	967	605	35	250	7035	55,80
MBR08S110600008	1120	605	35	250	7035	55,80
MBR08S120600008	1273	605	35	250	7035	59,21
MBR08S160600008	1680	605	35	200	7035	75,02



SEMIPIANO AGGIUNTIVO

ART.	L mm	P mm	H mm	KG	RAL	€
MBR09S050300008	560	305	35	100	7035	30,38
MBR09S070300008	713	305	35	100	7035	30,38
MBR09S090300008	967	305	35	100	7035	34,72
MBR09S110300008	1120	305	35	100	7035	34,72
MBR09S120300008	1273	305	35	100	7035	39,68
MBR09S160300008	1680	305	35	100	7035	48,05



SUPPORTO SEMIPIANO INTERMEDIO

ART.	L mm	P mm	H mm	RAL	€
FBG13S605V00008	605	77	35	7035	9,92





SHOP

PIANO INTERNO 27X27 EH

ART.	L mm	P mm	H mm		RAL	€
MBR11S0V0020008	558	466	60	100	7035	29,14



SHOP

PIANO SUPERIORE E INFERIORE 27X27 EH

ART.	L mm	P mm	H mm		RAL	€
MBR10S050600008	560	610	32	100	7035	33,17

1. Piano interno 27x27 EH
2. Piano superiore e inferiore 27x27 EH
3. Supporto semipiano intermedio
4. Porta totale destra H=600 mm con maniglia Dark Grey
5. Porta totale sinistra H=600 mm con maniglia Dark Grey



SHOP

PORTA TOTALE DESTRA H=600 MM CON MANIGLIA DARK GREY

ART.	L mm	P mm	H mm	apertura	RAL	€
MBR06SC01020539	554	34	600	Destra	7016	57,35



SHOP

SUPPORTO SEMIPIANO INTERMEDIO

ART.	L mm	P mm	H mm	RAL	€
FBG13S605V00008	605	77	35	7035	9,92



SHOP

PORTA TOTALE SINISTRA H=600 MM CON MANIGLIA DARK GREY

ART.	L mm	P mm	H mm	apertura	RAL	€
MBR06SC01020639	554	34	600	Sinistra	7016	57,35



PORTATA



RAL 7016



RAL 7035



L ➔ 560 mm



ART.	adatto per cassetto H mm	componenti	€
FFH84050200	50/300	16 x Divisorio trasversale L=36 mm 7 x Divisorio trasversale L=47 mm 6 x Divisorio a 3 canali 3 x Divisorio a 4 canali	22,63



ART.	adatto per cassetto H mm	componenti	€
FFH84050300	50/300	15 x Divisorio trasversale L=47 mm 8 x Divisorio trasversale L=73 mm 6 x Divisorio a 2 canali 3 x Divisorio a 3 canali	22,63



ART.	adatto per cassetto H mm	componenti	€
FFH84050400	50/300	18 x Divisorio trasversale L=73 mm 9 x Divisorio a 2 canali	21,70



ART.	adatto per cassetto H mm	componenti	€
FFH84071800	75	6 x Cassetta divisorio 150x75 mm	23,25
FFH84101800	100/125	6 x Cassetta divisorio 150x150 mm	25,42



ART.	adatto per cassetto H mm	componenti	€
FFH84070800	75		13,33
FFH84100800	100/125		16,43
FFH84150800	150/175		21,08
FFH84200800	200/250	2 x Divisorio longitudinale fessurato L=457 mm 3 x Divisorio trasversale L=151 mm	30,69

MATERIALE DI SEPARAZIONE

L  713 mm

ART.	adatto per cassetto H mm	componenti	€
FFH10051000	50/300	3 x Divisorio a 3 canali 9 x Divisorio a 4 canali 12 x Divisorio trasversale L=47 mm 36 x Divisorio trasversale L=36 mm	31,93



ART.	adatto per cassetto H mm	componenti	€
FFH10051300	50/300	18 x Divisorio trasversale L=47 mm 12 x Divisorio trasversale L=73 mm 6 x Divisorio a 2 canali 6 x Divisorio a 3 canali	28,83



ART.	adatto per cassetto H mm	componenti	€
FFH10051500	50/300	20 x Divisorio trasversale L=36 mm 20 x Divisorio trasversale L=47 mm 6 x Divisorio a 3 canali 5 x Divisorio a 4 canali 1 x Porta chiavi a brugola	31,93



ART.	adatto per cassetto H mm	componenti	€
FFH10071800	75	16 x Cassetta divisorio 75x75 mm 8 x Cassetta divisorio 150x75 mm 4 x Cassetta divisorio 150x150 mm	32,55



ART.	adatto per cassetto H mm	componenti	€
FFH10071600	75	12 x Cassetta divisorio 150x75 mm 6 x Cassetta divisorio 150x150 mm	29,76
FFH10101600	100/125		34,72



ART.	adatto per cassetto H mm	componenti	€
FFH10070500	75	2 x Divisorio longitudinale fessurato L=457 mm 3 x Divisorio trasversale L=202 mm	16,43
FFH10100500	100/125		17,05
FFH10150500	150/175		22,63
FFH10200500	200/250		32,24

[CONFIGURE](#)
[SHOP](#)

ART.	L mm	P mm	H mm	KG	RAL	€
MASTERBR3001	3000	750	1985/2310	1000	7035+7016	4810,58

Composto da:

qtà	descrizione	qtà	descrizione
1	Banco smontato con piano in multiplex 40 mm	1	Tasca porta documenti A4
1	Armadio L=560 mm predisposto per porta con 1 piano regolabile	1	Kit porta rotolo con carta Ø=240 mm
2	Armadio L=713 mm con 4 cassetti 1x75 2x150 1x200	4	Porta bombolette inclinato a 2 posti
1	Armadio tecnico L=560 mm predisposto per porta	6	Gancio Unipok per utensili - confezione 30 pezzi
1	Porta parziale destra H=435 mm con maniglia Dark Grey	1	Barra aggancio per contenitori Picking Box mis. 1/2
1	Porta totale sinistra H=600 mm con maniglia Dark Grey	1	Kit 4 contenitori Picking Box Air mis. 1
2	Pannello forato laterale	2	Mensola grande reversibile
1	Kit 3 montanti biasolati	1	Cestino capacità 30 L
2	Kit 3 pannelli forati/mensole con 2 bordi fermacasse	3	Kit 2 contenitori Picking Box Air mis. 3A2
2	Lampada doppia	1	Piastra per arrotolatore
2	Pensile con porta	2	Rullo per arrotolatore
1	Multipresa schuko a 2 scomparti	1	Arrotolatore per aria compressa
1	Cavo di collegamento wieland schuko/francese	1	Arrotolatore elettrico con presa Schuko
1	Kit 3 supporti inclinati con 2 binari		



[CONFIGURE](#)
[SHOP](#)

ART.	L mm	P mm	H mm	KG	RAL	€
MASTERBR1508	1500	750	1985/2310	1000	7035+7016	2165,04

Composto da:

qtà	descrizione	qtà	descrizione
1	Banco smontato con piano in multiplex 40 mm	1	Cavo di collegamento wieland schuko/francese
1	Armadio L=560 mm con 5 cassetti 1x75 3x100 1x200	1	Tasca porta documenti A4
2	Piano superiore/inferiore L=560 mm	1	Kit porta rotolo con carta Ø=240 mm
1	Porta totale sinistra H=600 mm con maniglia Dark Grey	2	Porta bombole inclinato a 2 posti
1	Supporto semipiano intermedio	4	Gancio Unipok per utensili - confezione 30 pezzi
1	Piano interno L=558 mm	1	Cestino capacità 30 L
2	Pannello forato laterale	2	Pensile con porta
1	Supporto multipresa a 2 scomparti	1	Lampada doppia
1	Supporto multipresa a 4 scomparti	1	Kit 3 pannelli forati/mensole con 2 bordi fermacasse
1	Multipresa schuko a 2 scomparti	1	Kit 2 supporti inclinati con binario
1	Multipresa schuko a 4 scomparti	1	Kit 2 montanti biasolati



PORTATA



RAL 7035 + RAL 7016

BANCHI PROFESSIONALI

MASTER



I banchi **Master** offrono una combinazione perfetta di **versatilità**, funzionalità e personalizzazione. Disponibili in **5 larghezze** (1300, 1500, 2000, 2500, 3000 mm), questi banchi ad alta portata sono dotati di **piano in multiplex di faggio** con spessore **40 mm**. Sono altamente personalizzabili con una vasta gamma di componenti come piani aggiuntivi, armadi con **cassetti** con portata ed estrazione variabile, armadi con **morsa** o armadi per **allacciamenti**. Le innovative **gambe** possono essere **fisse, regolabili** in altezza o con **ruote** e includono un **foro** con tappo per l'installazione di una **multipresa** a due posti.

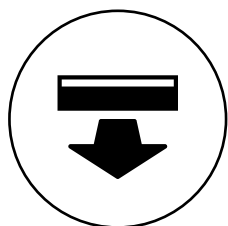

**CASSETTI AD
ESTRAZIONE
TOTALE**

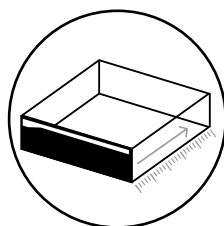

**PROFONDITÀ
UTILE CASSETTO
27 EH**

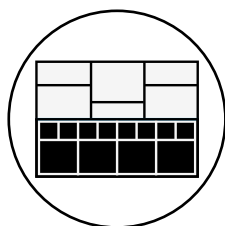

**MATERIALE DI
SEPARAZIONE**

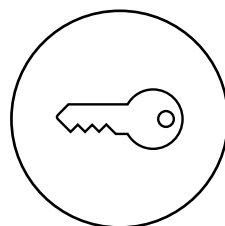

**CHIUSURA A
CHIAVE**

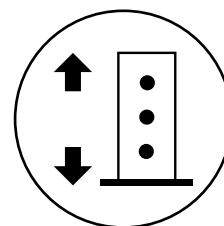

**GAMBE REGOLABILI IN
ALTEZZA**

MASTER



PIANO IN MULTIPLEX DI FAGGIO

Il piano in multiplex di faggio offre robustezza e resistenza, garantendo una superficie stabile e solida, perfetta per operazioni pesanti e di precisione. È resistente a graffi, urti e altre forme di usura e presenta uno spessore di 40 mm.



COPERTURA IN ACCIAIO GOMMATO

La copertura in acciaio gommato preserva l'integrità del piano di lavoro in caso di utilizzo di acidi o oli o si effettuino lavorazioni pesanti.



MANIGLIA

La maniglia facilita lo spostamento del banco con ruote, offrendo una presa sicura e un controllo ottimale durante le manovre.



MATERIALE DI SEPARAZIONE

Il cassetto può essere suddiviso internamente tramite vassoi portautensili 5S Pikpad, cassette divisorie portaminuterie e divisori longitudinali e trasversali in metallo.



SISTEMA ANTIELUSIVO

SICUREZZA AL PRIMO POSTO
Al contrario di altri armadi presenti in commercio, il sistema di chiusura brevettato non consente allo scassinatore di eludere la chiusura. In caso di apertura forzata l'effrazione è sempre visibile.



RUOTE

Le ruote trasformano i banchi Master in pratiche postazioni mobili. Sono disponibili in gomma antitraccia sintetica o in gomma elastica e possono essere fisse, girevoli o girevoli con freno.



Ogni gamba del banco Master presenta, di serie, un foro con tappo che, se rimosso, consente il fissaggio di una multipresa a 2 posti. A seconda di come viene installata la gamba, è possibile scegliere se posizionare il lato con il foro nella parte anteriore o posteriore del banco.

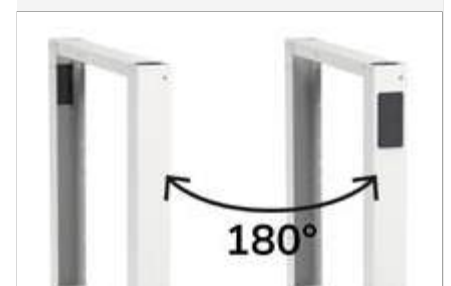

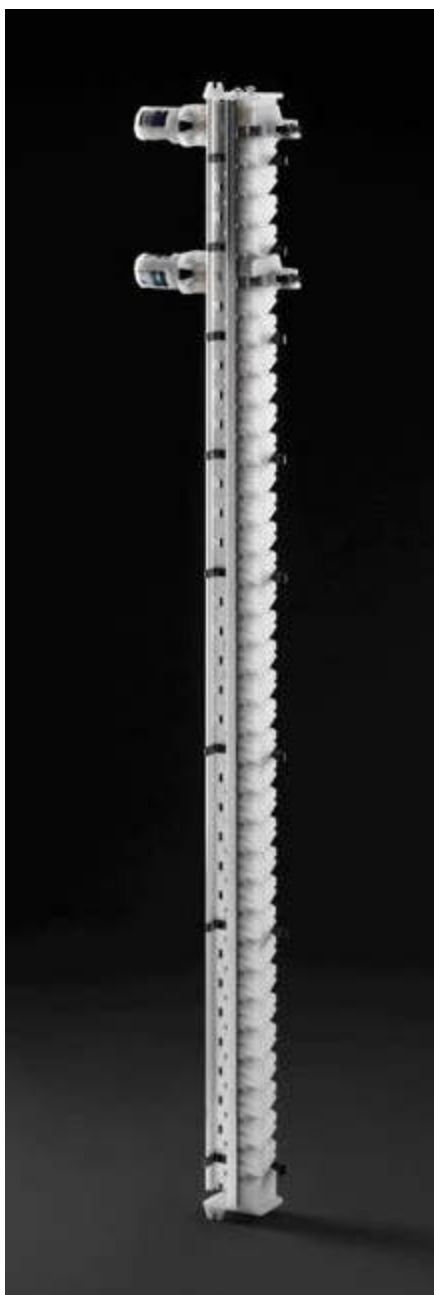

ASTA VERTEBRATA ANTIRIBALTAMENTO

L'asta è in profilato d'alluminio e rimane sempre fissa, senza ruotare.

Il movimento di chiusura è ottenuto da **tasselli che si spostano verticalmente** sfruttando una delle forze elementari della fisica: **la gravità. Più il movimento è semplice, meno probabilità di rotture ci sono.**

L'asta è **forata a passo 25 mm** e consente l'applicazione di più teste di chiusura. Questo permette di dividere l'accesso ai cassetti in più gruppi. La divisione dei gruppi è configurabile in altezza.

SISTEMA MECCANICO

Il sistema di comando meccanico del gruppo chiusura utilizza tecnologia Sylogik®. **Le differenze sono decisive.**

Il sistema di trasmissione dal cilindro della serratura alla testa dell'asta è costituito da fili di acciaio con guaina elastica e movimento lineare.

Rispetto ai comuni sistemi fissi ad asta quadra con movimento rotatorio, permette di svincolare il parallelismo della posizione del cilindro della serratura rispetto alla testa dell'asta. Questo consente al progettista di applicare il cilindro nel punto più idoneo dell'armadio.

Il cilindro della serratura è appoggiato a un tamburo di rinvio così da poter scegliere diverse case costruttrici di cilindri*.

In questo modo l'armadio può essere integrato con altri preesistenti mantenendo lo stesso tipo di chiave.



* Opzione a richiesta con sovrapprezzo



ESTRAZIONE TOTALE



LIBERTÀ NELLA CONFIGURAZIONE
Modifica velocemente e facilmente l'estrazione del cassetto per aumentare la portata fino a 100 kg.

GUIDE AD ALTE PRESTAZIONI



CORRERE SENZA PROBLEMI
Le guide lunghe come i cassetti permettono di spostare il cuscinetto nella parte frontale dell'armadio aumentando visibilità, portata ed estrazione.

CASSETTI FORATI



ORGANIZZAZIONE AL MILLIMETRO
Fori e scanalature sui cassetti facilitano la suddivisione interna del cassetto per una perfetta organizzazione di utensili e materiali.

MASTER

ESTRAZIONE E GESTIONE DEL CASSETTO

Il cassetto Master rappresenta una rivoluzione nel mondo dell'arredo industriale in quanto è stato ideato e sviluppato per essere personalizzato autonomamente in termini di estrazione/portata e suddivisione interna.



LIBERAMENTE CONFIGURABILE

La nuova guida ad **estrazione flessibile** permette la regolazione meccanica del fermo posteriore del cassetto/piano estraibile, in **3 diverse posizioni** ottenendo così **3 portate differenti: 50, 75, 100 kg**. L'installazione dell'innovativa **guida telescopica** aumenta la portata del **cassetto/piano estraibile fino a 200 kg**. Un'etichetta indica la portata massima del cassetto a seconda della sua estrazione e del tipo di guida.



GUIDA FLESSIBILE CONFIGURATA PER ESTRAZIONE TOTALE 50 KG

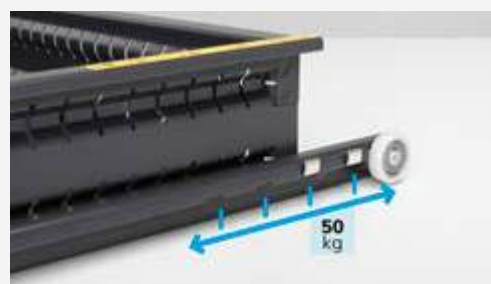
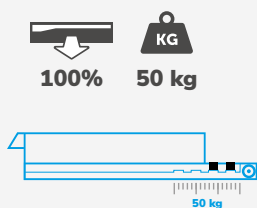

GUIDA FLESSIBILE CONFIGURATA PER ESTRAZIONE TOTALE 75 KG

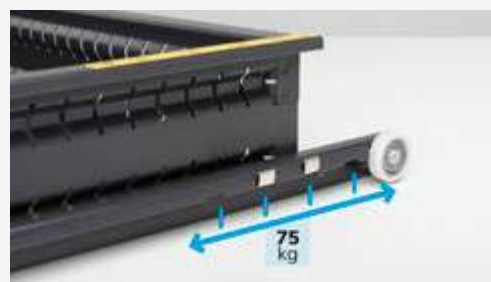
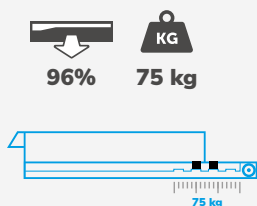

GUIDA FLESSIBILE CONFIGURATA PER ESTRAZIONE PARZIALE 100 KG

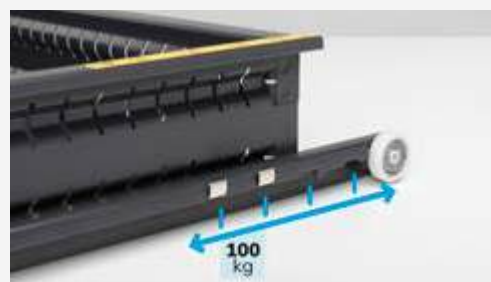
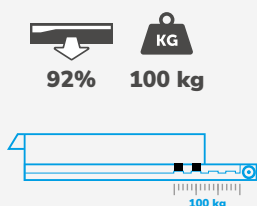

GUIDA TELESCOPICA CONFIGURATA PER ESTRAZIONE TOTALE 200 KG

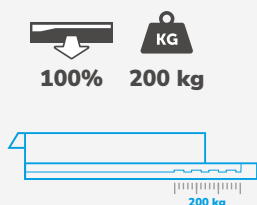

MASTER

COLORI

Il banco da lavoro Master è disponibile in 13 combinazioni di colore a cui associare 8 diversi colori per le maniglie per creare soluzioni personalizzate nel minimo dettaglio. È possibile, quindi, assegnare a particolari aree di lavoro o progetti colori specifici oppure implementare il colore aziendale anche negli arredi installati in azienda.

10 colori RAL per la parte metallica
8 colori per gli accessori plastici

Combinazioni infinite

MANIGLIA FRONTALE



Dark Grey



Mediterranean Blue*



Sky Blue*



Glamour Red*



Red Carpet*



Juicy Orange*



Sunny Yellow*



Forest Green*

BANCHI



7035
7016



5012
7016



7035*



5012*



9002*



7016*



7000*



5019*



9010*



6011*



3003*







5010*



7035
5012*

* Su richiesta

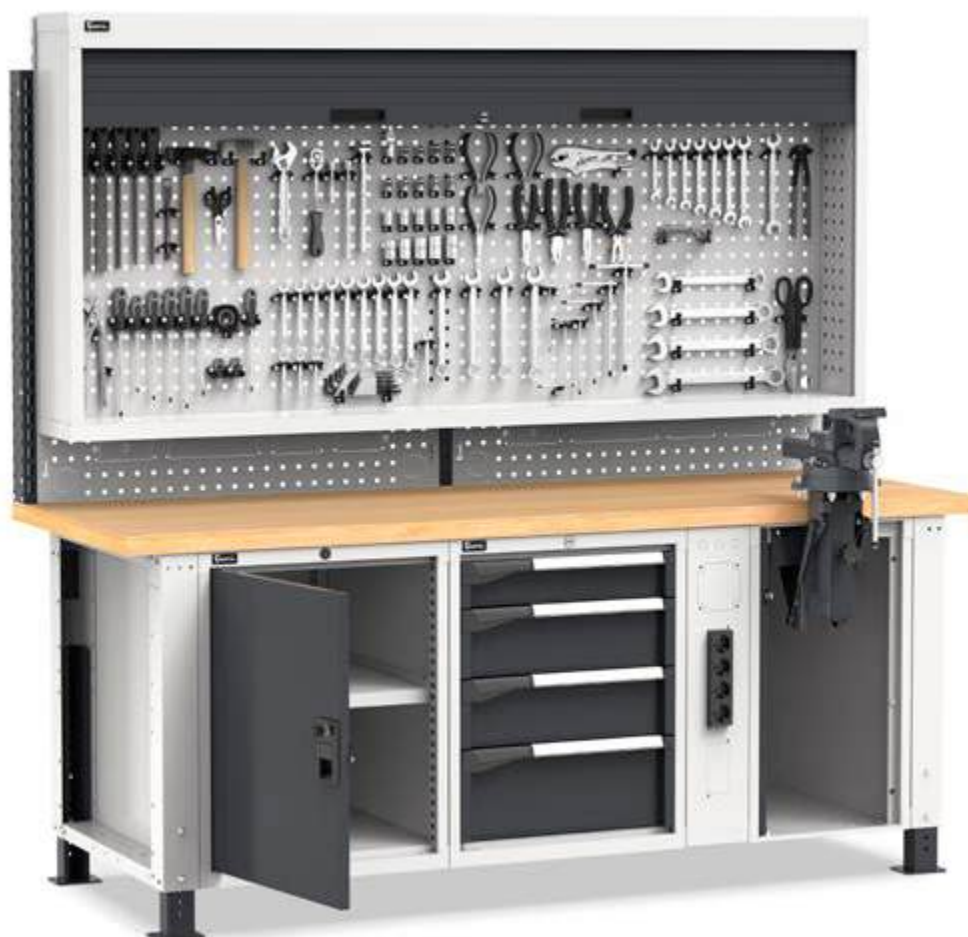

	START	PRO	PRO+	
	WORK	BR	MASTER	
Larghezza mm	1000-1500-2000	1024-1500-2000-3000	1300-1500-2000-2500-3000	 1300
Tipologia piani lavoro	Acciaio Multiplex	Multiplex	Multiplex	 1500
Profondità piano lavoro mm	750	750	750-800*	 2000
Spessore piano lavoro in multiplex di faggio mm	30	40	40-50*	 2500
Copertura	Gommato	Gommato	Gommato	 3000
Portata banco kg	1000	1000	800 - 1500	
Regolabile in altezza	✓	✓	✓	
Gambe fisse	✓	-	✓	
Gambe con ruote	Banco regolabile	-	✓	
Gambe elettrificate	-	-	✓	
Profondità utile cassetti	513 mm	447 mm - 27 EH	600 mm - 36 EH	
Cassetto estrazione totale	-	✓	✓	
Portata cassetti kg	80	50-75-100	50-75-100-200	
Asta anti ribaltamento cassetto	-	✓	✓	
Parete attrezzata	✓	✓	✓	
Chiusura posteriore	Accessorio	Di serie	Accessorio*	

* Su richiesta



BANCO REGOLABILE

DIM. (mm): L=2000 P=750 H=1829/2179

ART.	 KG	RAL	€
 MASTERWR2081	1000	7035+7016	3449,06

Armadio 1xPR con porta
 Armadio con 4 cassetti 1x100 2x150 1x200
 Armadio per allacciamenti con multipresa Schuko a 4 scomparti
 Armadio con sistema ribaltabile e morsa
 Armadio con tapparella
 Completo di 240 ganci Unipok
 Utensili esclusi



passo fori gambe 25 mm



piano in multiplex spessore 40 mm



Forniti smontati



Portata cassetto 100-75-50 kg



Estrazione cassetto 92-96-100%



vedi pag. 248



3D

BANCO

DIM. (mm): L=1500 P=750 H=890

ART.	KG	RAL	€
MASTERWR1501	800	7035+7016	285,20
MASTERWR1502	800	5012+7016	306,28

3D

BANCO REGOLABILE

DIM. (mm): L=1500 P=750 H=765/1115

ART.	KG	RAL	€
MASTERWR1503	800	7035+7016	342,24
MASTERWR1504	800	5012+7016	363,32



3D

BANCO REGOLABILE CON RUOTE

DIM. (mm): L=1500 P=750 H=921/1271

ART.	KG	RAL	€
MASTERMR1503	300	7035+7016	470,58
MASTERMR1504	300	5012+7016	495,38

Kit 4 ruote in gomma antistraccia sintetica Ø 125 mm

3D

BANCO REGOLABILE

DIM. (mm): L=1500 P=750 H=1708/2058

ART.	KG	RAL	€
MASTERWR1505	800	7035+7016	611,32
MASTERWR1506	800	5012+7016	690,06

Completo di 180 ganci Unipok e 8 contenitori Picking Box Air
Utensili esclusi

ESEMPI DI CONFIGURAZIONE



3D

BANCO

DIM. (mm): L=1500 P=750 H=890

ART.	KG	RAL	€
MASTERWR1507	800	7035+7016	558,00
MASTERWR1508	800	5012+7016	590,24

Armadio con 1 cassetto 1x100



3D

BANCO REGOLABILE

DIM. (mm): L=1500 P=750 H=765/1115

ART.	KG	RAL	€
MASTERWR1509	800	7035+7016	615,04
MASTERWR1510	800	5012+7016	647,28

Armadio con 1 cassetto 1x100



3D

BANCO REGOLABILE CON RUOTE

DIM. (mm): L=1500 P=750 H=921/1271

ART.	KG	RAL	€
MASTERMR1509	300	7035+7016	725,09
MASTERMR1510	300	5012+7016	761,05

Armadio con 1 cassetto 1x100
Kit 4 ruote in gomma antitraccia sintetica Ø 125 mm



3D

BANCO REGOLABILE

DIM. (mm): L=1500 P=750 H=1708/2058

ART.	KG	RAL	€
MASTERWR1511	800	7035+7016	884,12
MASTERWR1512	800	5012+7016	974,02

Armadio con 1 cassetto 1x100
Completo di 180 ganci Unipok e 8 contenitori Picking Box Air
Utensili esclusi



PORTATA



RAL 7035+ RAL 7016



RAL 5012+ RAL 7016



passo fori gambe 25 mm



piano in multiplex spessore 40 mm



Forniti smontati



Portata cassetto 100-75-50 kg



Estrazione cassetto 92-96-100%



vedi pag. 248



3D

BANCO

DIM. (mm): L=1500 P=750 H=890

ART.	KG	RAL	€
MASTERWR1513	800	7035+7016	742,45
MASTERWR1514	800	5012+7016	832,66

Armadio con 3 cassetti 1x50 1x100 1x150

3D

BANCO REGOLABILE

DIM. (mm): L=1500 P=750 H=765/1115

ART.	KG	RAL	€
MASTERWR1515	800	7035+7016	799,49
MASTERWR1516	800	5012+7016	889,70

Armadio con 3 cassetti 1x50 1x100 1x150



3D

BANCO REGOLABILE CON RUOTE

DIM. (mm): L=1500 P=750 H=921/1271

ART.	KG	RAL	€
MASTERMR1515	300	7035+7016	927,83
MASTERMR1516	300	5012+7016	1021,76

Armadio con 3 cassetti 1x50 1x100 1x150
Kit 4 ruote in gomma antitraccia sintetica Ø 125 mm

3D

BANCO REGOLABILE

DIM. (mm): L=1500 P=750 H=1708/2058

ART.	KG	RAL	€
MASTERWR1517	800	7035+7016	1068,57
MASTERWR1518	800	5012+7016	1216,44

Armadio con 3 cassetti 1x50 1x100 1x150
Completo di 180 ganci Unipok e 8 contenitori Picking Box Air
Utensili esclusi



ESEMPI DI CONFIGURAZIONE



3D

BANCO

DIM. (mm): L=1500 P=750 H=890

ART.	KG	RAL	€
MASTERWR1519	800	7035+7016	879,47
MASTERWR1520	800	5012+7016	934,96

Armadio con 4 cassetti 2x75 1x150 1x200



3D

BANCO REGOLABILE

DIM. (mm): L=1500 P=750 H=765/1115

ART.	KG	RAL	€
MASTERWR1521	800	7035+7016	936,51
MASTERWR1522	800	5012+7016	992,00

Armadio con 4 cassetti 2x75 1x150 1x200



3D

BANCO REGOLABILE CON RUOTE

DIM. (mm): L=1500 P=750 H=921/1271

ART.	KG	RAL	€
MASTERMR1521	300	7035+7016	1064,85
MASTERMR1522	300	5012+7016	1124,06

Armadio con 4 cassetti 2x75 1x150 1x200
Kit 4 ruote in gomma antitraccia sintetica Ø 125 mm



3D

BANCO REGOLABILE

DIM. (mm): L=1500 P=750 H=1708/2058

ART.	KG	RAL	€
MASTERWR1523	800	7035+7016	1205,59
MASTERWR1524	800	5012+7016	1318,74

Armadio con 4 cassetti 2x75 1x150 1x200
Completo di 180 ganci Unipok e 8 contenitori Picking Box Air
Utensili esclusi



PORTATA



RAL 7035+ RAL 7016



RAL 5012+ RAL 7016



passo fori gambe 25 mm



piano in multiplex spessore 40 mm



Forniti smontati



Portata cassetto 100-75-50 kg



Estrazione cassetto 92-96-100%



vedi pag. 248



BANCO

DIM. (mm): L=1500 P=750 H=890

ART.	KG	RAL	€
MASTERWR1525	1500	7035+7016	892,80
MASTERWR1526	1500	5012+7016	936,82

Armadio con 4 cassetti 3x150 1x300



BANCO REGOLABILE

DIM. (mm): L=1500 P=750 H=765/1115

ART.	KG	RAL	€
MASTERWR1527	800	7035+7016	964,72
MASTERWR1528	800	5012+7016	1018,35

Armadio con 4 cassetti 1x100 2x150 1x200



BANCO REGOLABILE CON RUOTE

DIM. (mm): L=1500 P=750 H=921/1271

ART.	KG	RAL	€
MASTERMR1527	300	7035+7016	1096,78
MASTERMR1528	300	5012+7016	1154,75

Armadio con 4 cassetti 1x100 2x150 1x200
Kit 4 ruote in gomma antitraccia sintetica Ø 125 mm



BANCO REGOLABILE

DIM. (mm): L=1500 P=750 H=1708/2058

ART.	KG	RAL	€
MASTERWR1529	800	7035+7016	1233,80
MASTERWR1530	800	5012+7016	1345,09

Armadio con 4 cassetti 1x100 2x150 1x200
Completo di 180 ganci Unipok e 8 contenitori Picking Box Air
Utensili esclusi



ESEMPI DI CONFIGURAZIONE



BANCO REGOLABILE

DIM. (mm): L=1500 P=750 H=2010/2360

ART.	KG	RAL	€
MASTERWR1580	800	7035+7016	1834,58

Armadio con 4 cassetti 1x100 2x150 1x200
Completo di 120 ganci Unipok e accessori Iron Team
Utensili esclusi



PORTATA



RAL 7035+ RAL 7016



RAL 5012+ RAL 7016



passo fori gambe 25 mm



piano in multiplex spessore 40 mm



Forniti smontati



Portata cassetto 100-75-50 kg



Estrazione cassetto 92-96-100%



vedi pag. 248



BANCO

DIM. (mm): L=1500 P=750 H=890

ART.	KG	RAL	€
MASTERWR1531	1500	7035+7016	902,72
MASTERWR1532	1500	5012+7016	1021,14

Armadio con 5 cassetti 2x100 1x150 2x200



BANCO REGOLABILE

DIM. (mm): L=1500 P=750 H=765/1115

ART.	KG	RAL	€
MASTERWR1533	800	7035+7016	1025,17
MASTERWR1534	800	5012+7016	1091,82

Armadio con 5 cassetti 2x75 1x100 1x150 1x200



BANCO REGOLABILE CON RUOTE

DIM. (mm): L=1500 P=750 H=921/1271

ART.	KG	RAL	€
MASTERMR1533	300	7035+7016	1157,23
MASTERMR1534	300	5012+7016	1228,22

Armadio con 5 cassetti 2x75 1x100 1x150 1x200
Kit 4 ruote in gomma antitraccia sintetica Ø 125 mm



BANCO REGOLABILE

DIM. (mm): L=1500 P=750 H=1708/2058

ART.	KG	RAL	€
MASTERWR1535	800	7035+7016	1294,25
MASTERWR1536	800	5012+7016	1418,56

Armadio con 5 cassetti 2x75 1x100 1x150 1x200
Completo di 180 ganci Unipok e 8 contenitori Picking Box Air
Utensili esclusi

ESEMPI DI CONFIGURAZIONE

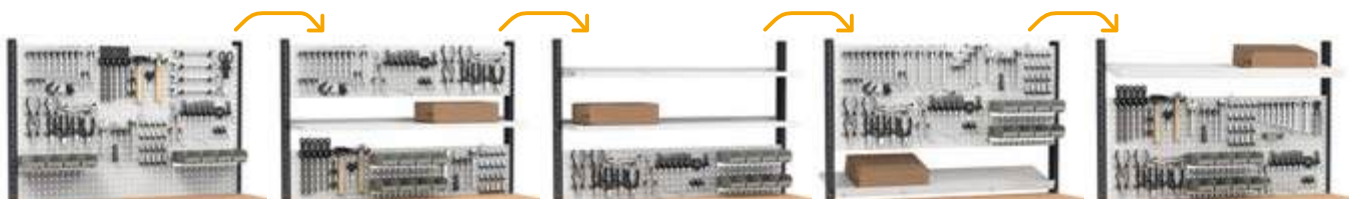

3D

BANCO

DIM. (mm): L=1500 P=750 H=890

ART.	KG	RAL	€
MASTERWR1537	1500	7035+7016	1029,51
MASTERWR1538	1500	5012+7016	1096,47

Armadio con 6 cassetti 1x50 2x100 2x150 1x200

3D

BANCO REGOLABILE

DIM. (mm): L=1500 P=750 H=765/1115

ART.	KG	RAL	€
MASTERWR1539	800	7035+7016	1090,89
MASTERWR1540	800	5012+7016	1173,04

Armadio con 6 cassetti 1x50 2x75 2x100 1x200

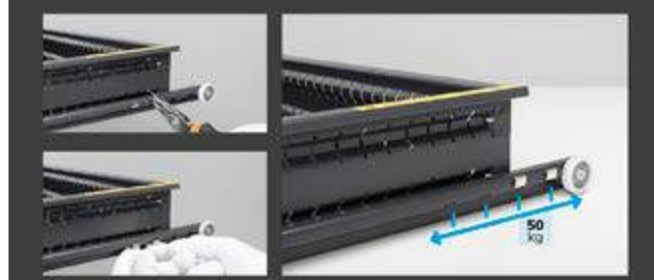

Esempio di configurazione

vedi pag. 189



3D

BANCO REGOLABILE

DIM. (mm): L=1500 P=750 H=1708/2058

ART.	KG	RAL	€
MASTERWR1541	800	7035+7016	1359,97
MASTERWR1542	800	5012+7016	1499,78

Armadio con 6 cassetti 1x50 2x75 2x100 1x200

Completo di 180 ganci Unipok e 8 contenitori Picking Box Air
Utensili esclusi



PORTATA



RAL 7035 + RAL 7016



RAL 5012 + RAL 7016



passo fori gambe 25 mm



piano in multiplex spessore 40 mm



Forniti smontati



Portata cassetto 100-75-50 kg



Estrazione cassetto 92-96-100%



vedi pag. 248



BANCO

DIM. (mm): L=1500 P=750 H=890

ART.	KG	RAL	€
MASTERWR1543	1500	7035+7016	726,02
MASTERWR1544	1500	5012+7016	745,86

Armadio con 1 cassetto 1x100 1xPR con porta



BANCO REGOLABILE

DIM. (mm): L=1500 P=750 H=765/1115

ART.	KG	RAL	€
MASTERWR1545	800	7035+7016	748,03
MASTERWR1546	800	5012+7016	769,11

Armadio 1xPR con porta



Esempio di configurazione

vedi pag. 189



BANCO REGOLABILE

DIM. (mm): L=1500 P=750 H=1708/2058

ART.	KG	RAL	€
MASTERWR1547	800	7035+7016	1017,11
MASTERWR1548	800	5012+7016	1095,85

Armadio 1xPR con porta
Completo di 180 ganci Unipok e 8 contenitori Picking Box Air
Utensili esclusi

ESEMPI DI CONFIGURAZIONE



3D

BANCO

DIM. (mm): L=1500 P=750 H=890

ART.	KG	RAL	€
MASTERWR1549	1500	7035+7016	1333,62
MASTERWR1550	1500	5012	1376,40

Armadio con 1 cassetto 1x100 1xPR con porta
Armadio con 4 cassetti 3x150 1x300



3D

BANCO REGOLABILE

DIM. (mm): L=1500 P=750 H=765/1115

ART.	KG	RAL	€
MASTERWR1551	1000	7035+7016	1430,96
MASTERWR1552	1000	5012+7016	1497,61

Armadio 1xPR con porta
Armadio con 5 cassetti 2x75 1x100 1x150 1x200



3D

BANCO REGOLABILE CON RUOTE

DIM. (mm): L=1500 P=750 H=921/1271

ART.	KG	RAL	€
MASTERMR1551	750	7035+7016	1567,05
MASTERMR1552	750	5012+7016	1633,70

Armadio 1xPR con porta
Armadio con 5 cassetti 2x75 1x100 1x150 1x200
Kit 4 ruote in gomma elastica Ø 125 mm



3D

BANCO REGOLABILE

DIM. (mm): L=1500 P=750 H=1708/2058

ART.	KG	RAL	€
MASTERWR1553	1000	7035+7016	1700,04
MASTERWR1554	1000	5012+7016	1824,35

Armadio 1xPR con porta
Armadio con 5 cassetti 2x75 1x100 1x150 1x200
Completo di 180 ganci Unipok e 8 contenitori Picking Box Air
Utensili esclusi



passo fori gambe 25 mm



piano in multiplex spessore 40 mm



Forniti smontati



Portata cassetto 100-75-50 kg



Estrazione cassetto 92-96-100%



vedi pag. 248



BANCO

DIM. (mm): L=1500 P=750 H=890

ART.	KG	RAL	€
MASTERWR1555	1500	7035+7016	1510,32
MASTERWR1556	1500	5012	1651,68

Armadio con 4 cassetti 3x150 1x300

Armadio con 5 cassetti 2x100 1x150 2x200



BANCO REGOLABILE

DIM. (mm): L=1500 P=750 H=765/1115

ART.	KG	RAL	€
MASTERWR1557	1000	7035+7016	1647,65
MASTERWR1558	1000	5012+7016	1746,85

Armadio con 4 cassetti 1x100 2x150 1x200

Armadio con 5 cassetti 2x75 1x100 1x150 1x200

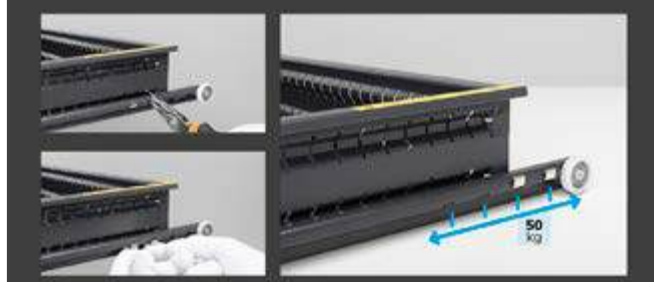

Esempio di configurazione

vedi pag. 189



BANCO REGOLABILE

DIM. (mm): L=1500 P=750 H=1708/2058

ART.	KG	RAL	€
MASTERWR1559	1000	7035+7016	1916,73
MASTERWR1560	1000	5012+7016	2073,59

Armadio con 4 cassetti 1x100 2x150 1x200

Armadio con 5 cassetti 2x75 1x100 1x150 1x200

Completo di 180 ganci Unipok e 8 contenitori Picking Box Air
Utensili esclusi

ESEMPI DI CONFIGURAZIONE



3D

BANCO

DIM. (mm): L=1500 P=750 H=890

ART.	KG	RAL	€
MASTERWR1561	1500	7035+7016	1647,03
MASTERWR1562	1500	5012	1811,33

Armadio con 5 cassetti 2x100 1x150 2x200
Armadio con 6 cassetti 1x50 2x100 2x150 1x200

3D

BANCO REGOLABILE

DIM. (mm): L=1500 P=750 H=765/1115

ART.	KG	RAL	€
MASTERWR1563	1000	7035+7016	1773,82
MASTERWR1564	1000	5012+7016	1901,54

Armadio con 5 cassetti 2x75 1x100 1x150 1x200
Armadio con 6 cassetti 1x50 2x75 2x100 1x200



Esempio di configurazione

vedi pag. 189



3D

BANCO REGOLABILE

DIM. (mm): L=1500 P=750 H=1708/2058

ART.	KG	RAL	€
MASTERWR1565	1000	7035+7016	2042,90
MASTERWR1566	1000	5012+7016	2228,28

Armadio con 5 cassetti 2x75 1x100 1x150 1x200
Armadio con 6 cassetti 1x50 2x75 2x100 1x200
Completo di 180 ganci Unipok e 8 contenitori Picking Box Air
Utensili esclusi



PORTATA



RAL 7035 + RAL 7016



RAL 5012 + RAL 7016



RAL 5012



passo fori gambe 25 mm

piano in multiplex spessore 40 mm

Forniti smontati

Portata cassetto 100-75-50 kg

Estrazione cassetto 92-96-100%



vedi pag. 248



3D

BANCO REGOLABILE

DIM. (mm): L=1500 P=750 H=765/1115

ART.	KG	RAL	€
MASTERWR1567	1000	7035+7016	1370,51
MASTERWR1568	1000	5012+7016	1424,14

Armadio 1xPR con porta
Armadio con 4 cassetti 1x100 2x150 1x200

3D

BANCO REGOLABILE CON RUOTE

DIM. (mm): L=1500 P=750 H=921/1271

ART.	KG	RAL	€
MASTERMR1567	750	7035+7016	1506,60
MASTERMR1568	750	5012+7016	1560,23

Armadio 1xPR con porta
Armadio con 4 cassetti 1x100 2x150 1x200
Kit 4 ruote in gomma elastica Ø 125 mm





3D

BANCO REGOLABILE

DIM. (mm): L=1500 P=750 H=765/1115

ART.	KG	RAL	€
MASTERWR1569	1000	7035+7016	1798,31
MASTERWR1570	1000	5012+7016	1848,84

Armadio con 4 cassetti 1x100 2x150 1x200
Armadio con sistema ribaltabile e morsa

3D

BANCO REGOLABILE CON RUOTE

DIM. (mm): L=1500 P=750 H=921/1271

ART.	KG	RAL	€
MASTERMR1569	750	7035+7016	1934,40
MASTERMR1570	750	5012+7016	1984,93

Armadio con 4 cassetti 1x100 2x150 1x200
Armadio con sistema ribaltabile e morsa
Kit 4 ruote in gomma elastica Ø 125 mm



3D

BANCO REGOLABILE

DIM. (mm): L=1500 P=750 H=765/1115

ART.	KG	RAL	€
MASTERWR1571	1000	7035+7016	1902,78
MASTERWR1572	1000	5012+7016	1956,41

Armadio con 4 cassetti 1x100 2x150 1x200
Armadio per allacciamenti con multipresa Schuko a 4 scomparti
Armadio con sistema ribaltabile e morsa

3D

BANCO REGOLABILE CON RUOTE

DIM. (mm): L=1500 P=750 H=921/1271

ART.	KG	RAL	€
MASTERMR1571	750	7035+7016	2038,87
MASTERMR1572	750	5012+7016	2092,50

Armadio con 4 cassetti 1x100 2x150 1x200
Armadio per allacciamenti con multipresa Schuko a 4 scomparti
Armadio con sistema ribaltabile e morsa
Kit 4 ruote in gomma elastica Ø 125 mm



PORTATA



RAL 7035+RAL 7016



RAL 5012+RAL 7016

PR: PIANO REGOLABILE



passo fori gambe 25 mm



piano in multiplex spessore 40 mm



Forniti smontati



Portata cassetto 100-75-50 kg



Estrazione cassetto 92-96-100%



vedi pag. 248



3D

BANCO

DIM. (mm): L=2000 P=750 H=890

ART.	KG	RAL	€
MASTERWR2001	500	7035+7016	332,32
MASTERWR2002	500	5012+7016	353,40

3D

BANCO REGOLABILE

DIM. (mm): L=2000 P=750 H=765/1115

ART.	KG	RAL	€
MASTERWR2003	500	7035+7016	389,36
MASTERWR2004	500	5012+7016	410,44



3D

BANCO REGOLABILE CON RUOTE

DIM. (mm): L=2000 P=750 H=921/1271

ART.	KG	RAL	€
MASTERMR2003	300	7035+7016	522,04
MASTERMR2004	300	5012+7016	551,49

Kit 4 ruote in gomma antistrada Ø 125 mm

3D

BANCO REGOLABILE

DIM. (mm): L=2000 P=750 H=1708/2058

ART.	KG	RAL	€
MASTERWR2005	500	7035+7016	782,75
MASTERWR2006	500	5012+7016	870,79

Completo di 180 ganci Unipok e 16 contenitori Picking Box Air Utensili esclusi



ESEMPI DI CONFIGURAZIONE

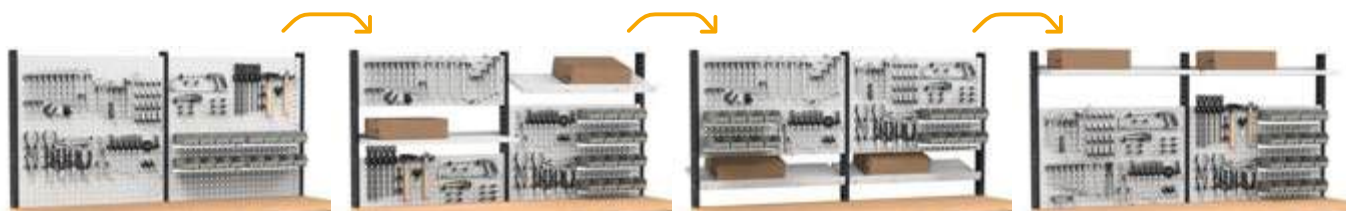

3D

BANCO

DIM. (mm): L=2000 P=750 H=890

ART.	KG	RAL	€
MASTERWR2007	500	7035+7016	605,12
MASTERWR2008	500	5012+7016	637,36

Armadio con 1 cassetto 1x100



3D

BANCO REGOLABILE

DIM. (mm): L=2000 P=750 H=765/1115

ART.	KG	RAL	€
MASTERWR2009	500	7035+7016	662,16
MASTERWR2010	500	5012+7016	694,40

Armadio con 1 cassetto 1x100



3D

BANCO REGOLABILE CON RUOTE

DIM. (mm): L=2000 P=750 H=921/1271

ART.	KG	RAL	€
MASTERMR2009	300	7035+7016	776,55
MASTERMR2010	300	5012+7016	817,16

Armadio con 1 cassetto 1x100

Kit 4 ruote in gomma antitraccia sintetica Ø 125 mm



3D

BANCO REGOLABILE

DIM. (mm): L=2000 P=750 H=1708/2058

ART.	KG	RAL	€
MASTERWR2011	500	7035+7016	1055,55
MASTERWR2012	500	5012+7016	1154,75

Armadio con 1 cassetto 1x100

Completo di 180 ganci Unipok e 16 contenitori Picking Box Air
Utensili esclusi



PORTATA



RAL 7035+ RAL 7016



RAL 5012+ RAL 7016



passo fori gambe 25 mm

piano in multiplex spessore 40 mm

Forniti smontati

Portata cassetto 100-75-50 kg

Estrazione cassetto 92-96-100%



vedi pag. 248



3D

BANCO

DIM. (mm): L=2000 P=750 H=890

ART.	KG	RAL	€
MASTERWR2013	500	7035+7016	789,57
MASTERWR2014	500	5012+7016	879,78

Armadio con 3 cassetti 1x50 1x100 1x150

3D

BANCO REGOLABILE

DIM. (mm): L=2000 P=750 H=765/1115

ART.	KG	RAL	€
MASTERWR2015	500	7035+7016	846,61
MASTERWR2016	500	5012+7016	936,82

Armadio con 3 cassetti 1x50 1x100 1x150



3D

BANCO REGOLABILE CON RUOTE

DIM. (mm): L=2000 P=750 H=921/1271

ART.	KG	RAL	€
MASTERMR2015	300	7035+7016	979,29
MASTERMR2016	300	5012+7016	1077,87

Armadio con 3 cassetti 1x50 1x100 1x150
Kit 4 ruote in gomma antitraccia sintetica Ø 125 mm

3D

BANCO REGOLABILE

DIM. (mm): L=2000 P=750 H=1708/2058

ART.	KG	RAL	€
MASTERWR2017	500	7035+7016	1240,00
MASTERWR2018	500	5012+7016	1397,17

Armadio con 3 cassetti 1x50 1x100 1x150
Completo di 180 ganci Unipok e 16 contenitori Picking Box Air
Utensili esclusi



ESEMPI DI CONFIGURAZIONE

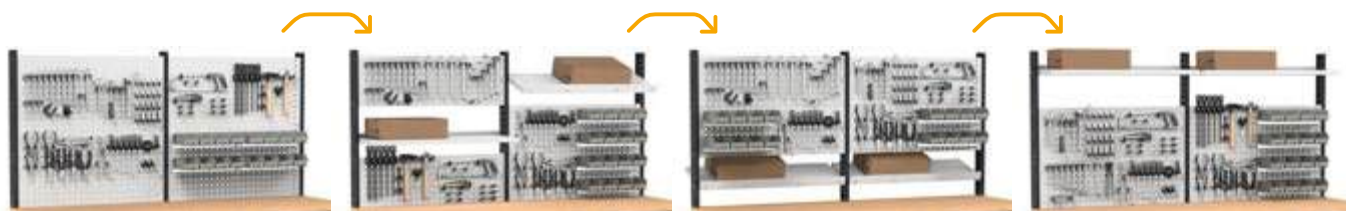

3D

BANCO

DIM. (mm): L=2000 P=750 H=890

ART.	KG	RAL	€
MASTERWR2019	500	7035+7016	926,59
MASTERWR2020	500	5012+7016	982,08

Armadio con 4 cassetti 2x75 1x150 1x200



3D

BANCO REGOLABILE

DIM. (mm): L=2000 P=750 H=765/1115

ART.	KG	RAL	€
MASTERWR2021	500	7035+7016	983,63
MASTERWR2022	500	5012+7016	1039,12

Armadio con 4 cassetti 2x75 1x150 1x200



3D

BANCO REGOLABILE CON RUOTE

DIM. (mm): L=2000 P=750 H=921/1271

ART.	KG	RAL	€
MASTERMR2021	300	7035+7016	1116,31
MASTERMR2022	300	5012+7016	1180,17

Armadio con 4 cassetti 2x75 1x150 1x200
Kit 4 ruote in gomma antitraccia sintetica Ø 125 mm



3D

BANCO REGOLABILE

DIM. (mm): L=2000 P=750 H=1708/2058

ART.	KG	RAL	€
MASTERWR2023	500	7035+7016	1377,02
MASTERWR2024	500	5012+7016	1499,47

Armadio con 4 cassetti 2x75 1x150 1x200
Completo di 180 ganci Unipok e 16 contenitori Picking Box Air
Utensili esclusi



PORTATA



RAL 7035+ RAL 7016



RAL 5012+ RAL 7016



passo fori gambe 25 mm



piano in multiplex spessore 40 mm



Forniti smontati



Portata cassetto 100-75-50 kg



Estrazione cassetto 92-96-100%



vedi pag. 248



BANCO

DIM. (mm): L=2000 P=750 H=890

ART.	KG	RAL	€
MASTERWR2025	800	7035+7016	939,92
MASTERWR2026	800	5012+7016	983,94

Armadio con 4 cassetti 3x150 1x300



BANCO REGOLABILE

DIM. (mm): L=2000 P=750 H=765/1115

ART.	KG	RAL	€
MASTERWR2027	500	7035+7016	1011,84
MASTERWR2028	500	5012+7016	1065,47

Armadio con 4 cassetti 1x100 2x150 1x200



BANCO REGOLABILE CON RUOTE

DIM. (mm): L=2000 P=750 H=921/1271

ART.	KG	RAL	€
MASTERMR2027	300	7035+7016	1155,37
MASTERMR2028	300	5012+7016	1224,81

Armadio con 4 cassetti 1x100 2x150 1x200
Kit 4 ruote in gomma antitraccia sintetica Ø 125 mm



BANCO REGOLABILE

DIM. (mm): L=2000 P=750 H=1708/2058

ART.	KG	RAL	€
MASTERWR2029	500	7035+7016	1405,23
MASTERWR2030	500	5012+7016	1525,82

Armadio con 4 cassetti 1x100 2x150 1x200
Completo di 180 ganci Unipok e 16 contenitori Picking Box Air
Utensili esclusi



ESEMPI DI CONFIGURAZIONE

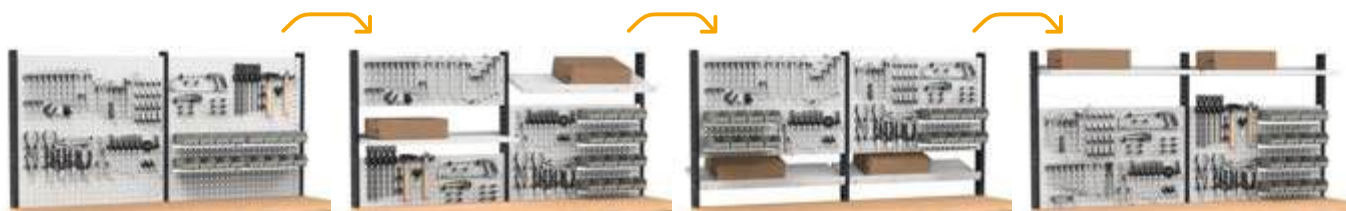

3D

BANCO

DIM. (mm): L=2000 P=750 H=890

ART.	KG	RAL	€
MASTERWR2031	800	7035+7016	949,84
MASTERWR2032	800	5012+7016	1068,26

Armadio con 5 cassetti 2x100 1x150 2x200



3D

BANCO REGOLABILE

DIM. (mm): L=2000 P=750 H=765/1115

ART.	KG	RAL	€
MASTERWR2033	500	7035+7016	1072,29
MASTERWR2034	500	5012+7016	1138,94

Armadio con 5 cassetti 2x75 1x100 1x150 1x200



3D

BANCO REGOLABILE CON RUOTE

DIM. (mm): L=2000 P=750 H=921/1271

ART.	KG	RAL	€
MASTERMR2033	300	7035+7016	1215,82
MASTERMR2034	300	5012+7016	1298,28

Armadio con 5 cassetti 2x75 1x100 1x150 1x200
Kit 4 ruote in gomma antitraccia sintetica Ø 125 mm



3D

BANCO REGOLABILE

DIM. (mm): L=2000 P=750 H=1708/2058

ART.	KG	RAL	€
MASTERWR2035	500	7035+7016	1465,68
MASTERWR2036	500	5012+7016	1599,29

Armadio con 5 cassetti 2x75 1x100 1x150 1x200
Completo di 180 ganci Unipok e 16 contenitori Picking Box Air
Utensili esclusi



PORTATA



RAL 7035+ RAL 7016



RAL 5012+ RAL 7016



 **passo fori gambe 25 mm**

 **piano in multiplex spessore 40 mm**

 **Forniti smontati**

 **Portata cassetto 100-75-50 kg**

 **Estrazione cassetto 92-96-100%**





vedi pag. 248



3D

BANCO

DIM. (mm): L=2000 P=750 H=890



ART.	KG	RAL	€
 MASTERWR2037	800	7035+7016	1076,63
 MASTERWR2038	800	5012+7016	1143,59

Armadio con 6 cassetti 1x50 2x100 2x150 1x200

3D

BANCO REGOLABILE

DIM. (mm): L=2000 P=750 H=765/1115

ART.	KG	RAL	€
 MASTERWR2039	500	7035+7016	1138,01
 MASTERWR2040	500	5012+7016	1220,16

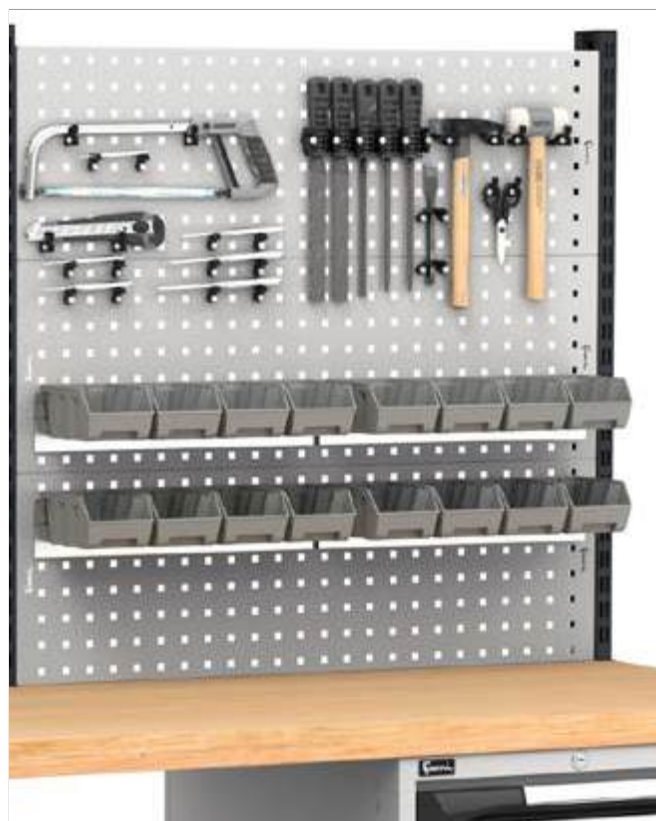

Armadio con 6 cassetti 1x50 2x75 2x100 1x200



3D

BANCO REGOLABILE

DIM. (mm): L=2000 P=750 H=1708/2058

ART.	KG	RAL	€
 MASTERWR2041	500	7035+7016	1531,40
 MASTERWR2042	500	5012+7016	1680,51

Armadio con 6 cassetti 1x50 2x75 2x100 1x200
Completo di 180 ganci Unipok e 16 contenitori Picking Box Air
Utensili esclusi



ESEMPI DI CONFIGURAZIONE

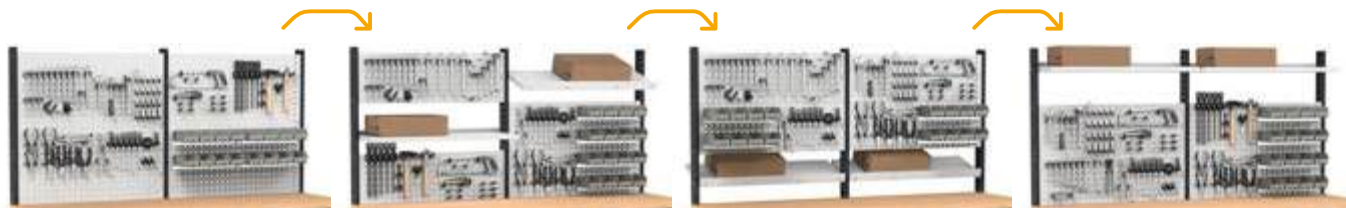

3D

BANCO

DIM. (mm): L=2000 P=750 H=890

ART.	KG	RAL	€
MASTERWR2043	800	7035+7016	773,14
MASTERWR2044	800	5012+7016	792,98

Armadio con 1 cassetto 1x100 1xPR con porta

3D

BANCO REGOLABILE

DIM. (mm): L=2000 P=750 H=765/1115

ART.	KG	RAL	€
MASTERWR2045	500	7035+7016	795,15
MASTERWR2046	500	5012+7016	816,23

Armadio 1xPR con porta



3D

BANCO REGOLABILE

DIM. (mm): L=2000 P=750 H=1708/2058

ART.	KG	RAL	€
MASTERWR2047	500	7035+7016	1188,54
MASTERWR2048	500	5012+7016	1276,58

Armadio 1xPR con porta
Completo di 180 ganci Unipok e 16 contenitori Picking Box Air
Utensili esclusi





passo fori gambe 25 mm



piano in multiplex spessore 40 mm



Forniti smontati



Portata cassetto 100-75-50 kg



Estrazione cassetto 92-96-100%



vedi pag. 248



3D

BANCO

DIM. (mm): L=2000 P=750 H=890

ART.	KG	RAL	€
MASTERWR2049	1500	7035+7016	1380,74
MASTERWR2050	1500	5012	1423,52

Armadio con 1 cassetto 1x100 1xPR con porta
Armadio con 4 cassetti 3x150 1x300

3D

BANCO REGOLABILE

DIM. (mm): L=2000 P=750 H=765/1115

ART.	KG	RAL	€
MASTERWR2051	500	7035+7016	1478,08
MASTERWR2052	500	5012+7016	1544,73

Armadio 1xPR con porta
Armadio con 5 cassetti 2x75 1x100 1x150 1x200



3D

BANCO REGOLABILE CON RUOTE

DIM. (mm): L=2000 P=750 H=921/1271

ART.	KG	RAL	€
MASTERMR2051	750	7035+7016	1644,24
MASTERMR2052	750	5012+7016	1715,23

Armadio 1xPR con porta
Armadio con 5 cassetti 2x75 1x100 1x150 1x200
Kit 4 ruote in gomma elastica Ø 125 mm

3D

BANCO REGOLABILE

DIM. (mm): L=2000 P=750 H=1708/2058

ART.	KG	RAL	€
MASTERWR2053	500	7035+7016	1871,47
MASTERWR2054	500	5012+7016	2005,08

Armadio 1xPR con porta
Armadio con 5 cassetti 2x75 1x100 1x150 1x200
Completo di 180 ganci Unipok e 16 contenitori Picking Box Air
Utensili esclusi



ESEMPI DI CONFIGURAZIONE

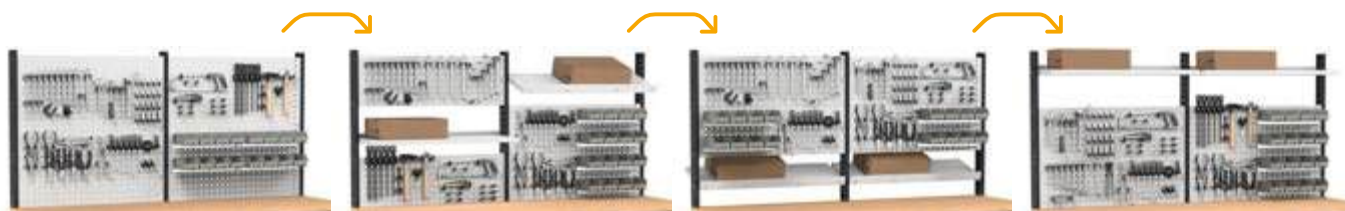

BANCO REGOLABILE

DIM. (mm): L=2000 P=750 H=2010/2360

ART.	KG	RAL	€
MASTERWR2082	500	7035+7016	2405,60

Armadio 1xPR con porta
 Armadio con 5 cassetti 2x75 1x100 1x150 1x200
 Completo di 180 ganci Unipok, accessori Iron Team e 8 contenitori Picking Box Air
 Utensili esclusi





passo fori gambe 25 mm



piano in multiplex spessore 40 mm



Forniti smontati



Portata cassetto 100-75-50 kg



Estrazione cassetto 92-96-100%



vedi pag. 248



BANCO

DIM. (mm): L=2000 P=750 H=890

ART.	KG	RAL	€
MASTERWR2055	1500	7035+7016	1557,44
MASTERWR2056	1500	5012	1698,80

Armadio con 4 cassetti 3x150 1x300

Armadio con 5 cassetti 2x100 1x150 2x200



BANCO REGOLABILE

DIM. (mm): L=2000 P=750 H=765/1115

ART.	KG	RAL	€
MASTERWR2057	500	7035+7016	1694,77
MASTERWR2058	500	5012+7016	1793,97

Armadio con 4 cassetti 1x100 2x150 1x200

Armadio con 5 cassetti 2x75 1x100 1x150 1x200



Esempio di configurazione

vedi pag. 189



BANCO REGOLABILE

DIM. (mm): L=2000 P=750 H=1708/2058

ART.	KG	RAL	€
MASTERWR2059	500	7035+7016	2088,16
MASTERWR2060	500	5012+7016	2254,32

Armadio con 4 cassetti 1x100 2x150 1x200

Armadio con 5 cassetti 2x75 1x100 1x150 1x200

Completo di 180 ganci Unipok e 16 contenitori Picking Box Air
Utensili esclusi

ESEMPI DI CONFIGURAZIONE

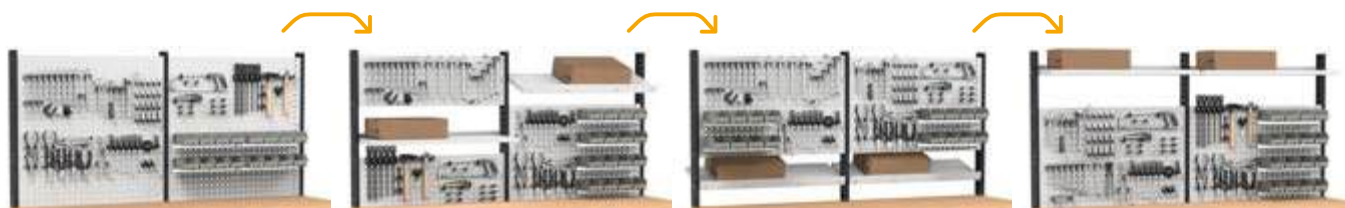

3D

BANCO

DIM. (mm): L=2000 P=750 H=890

ART.	KG	RAL	€
MASTERWR2061	1500	7035+7016	1694,15
MASTERWR2062	1500	5012	1858,45

Armadio con 5 cassetti 2x100 1x150 2x200
Armadio con 6 cassetti 1x50 2x100 2x150 1x200



3D

BANCO REGOLABILE

DIM. (mm): L=2000 P=750 H=765/1115

ART.	KG	RAL	€
MASTERWR2063	500	7035+7016	1820,94
MASTERWR2064	500	5012+7016	1948,66

Armadio con 5 cassetti 2x75 1x100 1x150 1x200
Armadio con 6 cassetti 1x50 2x75 2x100 1x200



Esempio di configurazione

vedi pag. 189



3D

BANCO REGOLABILE

DIM. (mm): L=2000 P=750 H=1708/2058

ART.	KG	RAL	€
MASTERWR2065	500	7035+7016	2214,33
MASTERWR2066	500	5012+7016	2409,01

Armadio con 5 cassetti 2x75 1x100 1x150 1x200
Armadio con 6 cassetti 1x50 2x75 2x100 1x200
Completo di 180 ganci Unipok e 16 contenitori Picking Box Air
Utensili esclusi



PORTATA



RAL 7035 + RAL 7016



RAL 5012 + RAL 7016



RAL 5012



passo fori gambe 25 mm



piano in multiplex spessore 40 mm



Forniti smontati



Portata cassetto 100-75-50 kg



Estrazione cassetto 92-96-100%



vedi pag. 248



BANCO REGOLABILE

DIM. (mm): L=2000 P=750 H=765/1115

ART.	KG	RAL	€
MASTERWR2067	1000	7035+7016	1839,54
MASTERWR2068	1000	5012+7016	1893,17

2 x Armadio 1xPR con porta
Armadio con 4 cassetti 1x100 2x150 1x200



BANCO REGOLABILE CON RUOTE

DIM. (mm): L=2000 P=750 H=921/1271

ART.	KG	RAL	€
MASTERMR2067	750	7035+7016	1975,63
MASTERMR2068	750	5012+7016	2029,26

2 x Armadio 1xPR con porta
Armadio con 4 cassetti 1x100 2x150 1x200
Kit 4 ruote in gomma elastica Ø 125 mm





Ganasce stringitubo di serie

vedi pag. 252



vedi pag. 253



3D

BANCO REGOLABILE

DIM. (mm): L=2000 P=750 H=765/1115

ART.	KG	RAL	€
MASTERWR2069	1000	7035+7016	2267,34
MASTERWR2070	1000	5012+7016	2317,87

Armadio 1xPR con porta
Armadio con 4 cassetti 1x100 2x150 1x200
Armadio con sistema ribaltabile e morsa

3D

BANCO REGOLABILE CON RUOTE

DIM. (mm): L=2000 P=750 H=921/1271

ART.	KG	RAL	€
MASTERMR2069	750	7035+7016	2403,43
MASTERMR2070	750	5012+7016	2453,96

Armadio 1xPR con porta
Armadio con 4 cassetti 1x100 2x150 1x200
Armadio con sistema ribaltabile e morsa
Kit 4 ruote in gomma elastica Ø 125 mm



3D

BANCO REGOLABILE

DIM. (mm): L=2000 P=750 H=765/1115

ART.	KG	RAL	€
MASTERWR2071	1000	7035+7016	2371,81
MASTERWR2072	1000	5012+7016	2425,44

Armadio 1xPR con porta
Armadio con 4 cassetti 1x100 2x150 1x200
Armadio per allacciamenti con multipresa Schuko a 4 scomparti
Armadio con sistema ribaltabile e morsa

3D

BANCO REGOLABILE CON RUOTE

DIM. (mm): L=2000 P=750 H=921/1271

ART.	KG	RAL	€
MASTERMR2071	750	7035+7016	2507,90
MASTERMR2072	750	5012+7016	2561,53

Armadio 1xPR con porta
Armadio con 4 cassetti 1x100 2x150 1x200
Armadio per allacciamenti con multipresa Schuko a 4 scomparti
Armadio con sistema ribaltabile e morsa
Kit 4 ruote in gomma elastica Ø 125 mm



PORTATA



RAL 7035+RAL 7016



RAL 5012+RAL 7016

PR: PIANO REGOLABILE



passo fori gambe 25 mm



piano in multiplex spessore 40 mm



Forniti smontati



Portata cassetto 100-75-50 kg



Estrazione cassetto 92-96-100%



vedi pag. 248



3D

BANCO

DIM. (mm): L=2500 P=750 H=890

ART.	KG	RAL	€
MASTERWR2501	800	7035+7016	447,02
MASTERWR2502	800	5012+7016	478,64

3D

BANCO REGOLABILE

DIM. (mm): L=2500 P=750 H=765/1115

ART.	KG	RAL	€
MASTERWR2503	800	7035+7016	532,58
MASTERWR2504	800	5012+7016	564,20



3D

BANCO REGOLABILE

DIM. (mm): L=2500 P=750 H=1708/2058

ART.	KG	RAL	€
MASTERWR2505	800	7035+7016	1082,83
MASTERWR2506	800	5012+7016	1205,59

Completo di 210 ganci Unipok e 16 contenitori Picking Box Air
Utensili esclusi



ESEMPI DI CONFIGURAZIONE

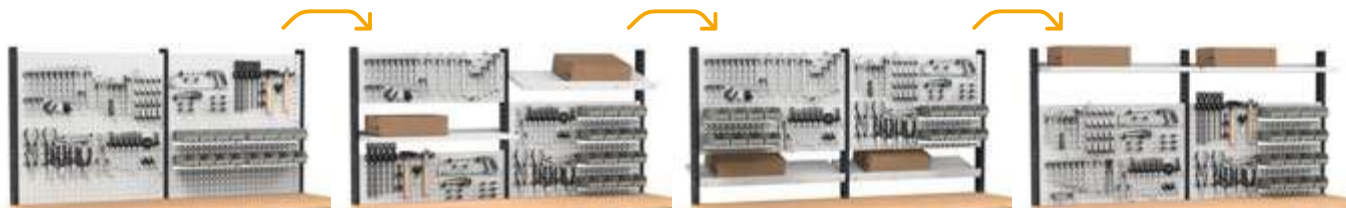

3D

BANCO

DIM. (mm): L=2500 P=750 H=890

ART.	KG	RAL	€
MASTERWR2507	800	7035+7016	717,65
MASTERWR2508	800	5012+7016	760,43

Armadio con 1 cassetto 1x100

3D

BANCO REGOLABILE

DIM. (mm): L=2500 P=750 H=765/1115

ART.	KG	RAL	€
MASTERWR2509	800	7035+7016	803,21
MASTERWR2510	800	5012+7016	845,99

Armadio con 1 cassetto 1x100



3D

BANCO REGOLABILE

DIM. (mm): L=2500 P=750 H=1708/2058

ART.	KG	RAL	€
MASTERWR2511	800	7035+7016	1353,46
MASTERWR2512	800	5012+7016	1487,38

Armadio con 1 cassetto 1x100
Completo di 210 ganci Unipok e 16 contenitori Picking Box Air
Utensili esclusi



PORTATA



RAL 7035+ RAL 7016



RAL 5012+ RAL 7016



passo fori gambe 25 mm



piano in multiplex spessore 40 mm



Forniti smontati



Portata cassetto 100-75-50 kg



Estrazione cassetto 92-96-100%



vedi pag. 248



BANCO

DIM. (mm): L=2500 P=750 H=890

ART.	KG	RAL	€
MASTERWR2513	800	7035+7016	902,10
MASTERWR2514	800	5012+7016	1002,85

Armadio con 3 cassetti 1x50 1x100 1x150



BANCO REGOLABILE

DIM. (mm): L=2500 P=750 H=765/1115

ART.	KG	RAL	€
MASTERWR2515	800	7035+7016	987,66
MASTERWR2516	800	5012+7016	1088,41

Armadio con 3 cassetti 1x50 1x100 1x150



BANCO REGOLABILE

DIM. (mm): L=2500 P=750 H=1708/2058

ART.	KG	RAL	€
MASTERWR2517	800	7035+7016	1537,91
MASTERWR2518	800	5012+7016	1729,80

Armadio con 3 cassetti 1x50 1x100 1x150
Completo di 210 ganci Unipok e 16 contenitori Picking Box Air
Utensili esclusi



ESEMPI DI CONFIGURAZIONE

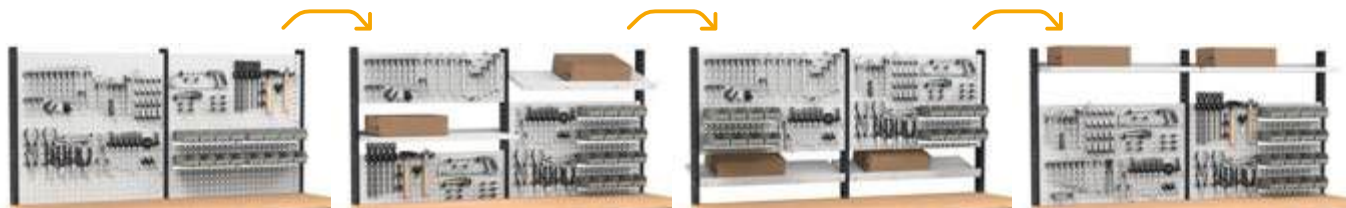

3D

BANCO

DIM. (mm): L=2500 P=750 H=890

ART.	KG	RAL	€
MASTERWR2519	800	7035+7016	1039,12
MASTERWR2520	800	5012+7016	1105,15

Armadio con 4 cassetti 2x75 1x150 1x200

3D

BANCO REGOLABILE

DIM. (mm): L=2500 P=750 H=765/1115

ART.	KG	RAL	€
MASTERWR2521	800	7035+7016	1124,68
MASTERWR2522	800	5012+7016	1190,71

Armadio con 4 cassetti 2x75 1x150 1x200



3D

BANCO REGOLABILE

DIM. (mm): L=2500 P=750 H=1708/2058

ART.	KG	RAL	€
MASTERWR2523	800	7035+7016	1674,93
MASTERWR2524	800	5012+7016	1832,10

Armadio con 4 cassetti 2x75 1x150 1x200
Completo di 210 ganci Unipok e 16 contenitori Picking Box Air
Utensili esclusi



PORTATA



RAL 7035+ RAL 7016



RAL 5012+ RAL 7016



passo fori gambe 25 mm



piano in multiplex spessore 40 mm



Forniti smontati



Portata cassetto 100-75-50 kg



Estrazione cassetto 92-96-100%



vedi pag. 248



BANCO

DIM. (mm): L=2500 P=750 H=890

ART.	KG	RAL	€
MASTERWR2525	800	7035+7016	1052,45
MASTERWR2526	800	5012+7016	1107,01

Armadio con 4 cassetti 3x150 1x300



BANCO REGOLABILE

DIM. (mm): L=2500 P=750 H=765/1115

ART.	KG	RAL	€
MASTERWR2527	800	7035+7016	1152,89
MASTERWR2528	800	5012+7016	1217,06

Armadio con 4 cassetti 1x100 2x150 1x200



BANCO REGOLABILE

DIM. (mm): L=2500 P=750 H=1708/2058

ART.	KG	RAL	€
MASTERWR2529	800	7035+7016	1703,14
MASTERWR2530	800	5012+7016	1858,45

Armadio con 4 cassetti 1x100 2x150 1x200
Completo di 210 ganci Unipok e 16 contenitori Picking Box Air
Utensili esclusi



ESEMPI DI CONFIGURAZIONE

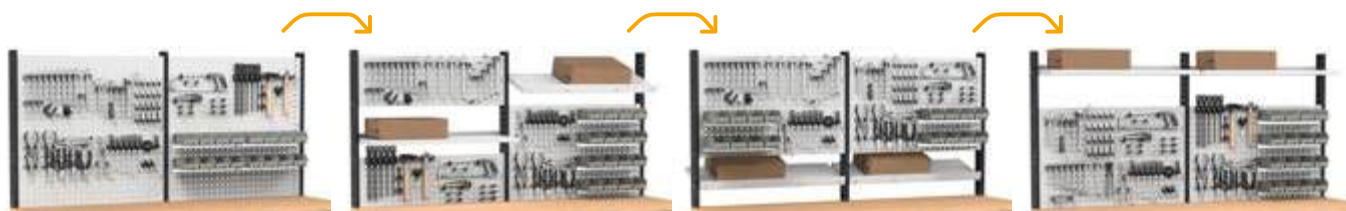

3D

BANCO

DIM. (mm): L=2500 P=750 H=890

ART.	KG	RAL	€
MASTERWR2531	800	7035+7016	1062,37
MASTERWR2532	800	5012+7016	1191,33

Armadio con 5 cassetti 2x100 1x150 2x200

3D

BANCO REGOLABILE

DIM. (mm): L=2500 P=750 H=765/1115

ART.	KG	RAL	€
MASTERWR2533	800	7035+7016	1213,34
MASTERWR2534	800	5012+7016	1290,53

Armadio con 5 cassetti 2x75 1x100 1x150 1x200



3D

BANCO REGOLABILE

DIM. (mm): L=2500 P=750 H=1708/2058

ART.	KG	RAL	€
MASTERWR2535	800	7035+7016	1763,59
MASTERWR2536	800	5012+7016	1931,92

Armadio con 5 cassetti 2x75 1x100 1x150 1x200
Completo di 210 ganci Unipok e 16 contenitori Picking Box Air
Utensili esclusi



PORTATA



RAL 7035+RAL 7016



RAL 5012+RAL 7016



passo fori gambe 25 mm



piano in multiplex spessore 40 mm



Forniti smontati



Portata cassetto 100-75-50 kg



Estrazione cassetto 92-96-100%



vedi pag. 248



BANCO

DIM. (mm): L=2500 P=750 H=890

ART.	KG	RAL	€
MASTERWR2537	800	7035+7016	1189,16
MASTERWR2538	800	5012+7016	1266,66

Armadio con 6 cassetti 1x50 2x100 2x150 1x200



BANCO REGOLABILE

DIM. (mm): L=2500 P=750 H=765/1115

ART.	KG	RAL	€
MASTERWR2539	800	7035+7016	1279,06
MASTERWR2540	800	5012+7016	1371,75

Armadio con 6 cassetti 1x50 2x75 2x100 1x200



BANCO REGOLABILE

DIM. (mm): L=2500 P=750 H=1708/2058

ART.	KG	RAL	€
MASTERWR2541	800	7035+7016	1829,31
MASTERWR2542	800	5012+7016	2013,14

Armadio con 6 cassetti 1x50 2x75 2x100 1x200
Completo di 210 ganci Unipok e 16 contenitori Picking Box Air
Utensili esclusi



ESEMPI DI CONFIGURAZIONE

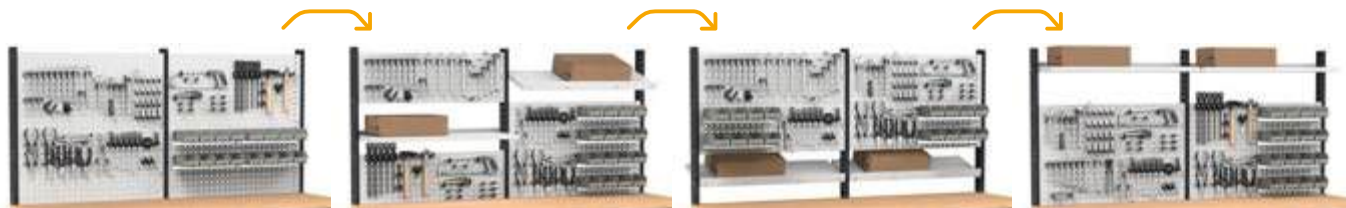

3D

BANCO

DIM. (mm): L=2500 P=750 H=890

ART.	KG	RAL	€
MASTERWR2543	800	7035+7016	885,67
MASTERWR2544	800	5012+7016	916,05

Armadio con 1 cassetto 1x100 1xPR con porta



3D

BANCO REGOLABILE

DIM. (mm): L=2500 P=750 H=765/1115

ART.	KG	RAL	€
MASTERWR2545	800	7035+7016	936,20
MASTERWR2546	800	5012+7016	967,82

Armadio 1xPR con porta



3D

BANCO REGOLABILE

DIM. (mm): L=2500 P=750 H=1708/2058

ART.	KG	RAL	€
MASTERWR2547	800	7035+7016	1486,45
MASTERWR2548	800	5012+7016	1609,21

Armadio 1xPR con porta
Completo di 210 ganci Unipok e 16 contenitori Picking Box Air
Utensili esclusi





passo fori gambe 25 mm

piano in multiplex spessore 40 mm

Forniti smontati

Portata cassetto 100-75-50 kg

Estrazione cassetto 92-96-100%



vedi pag. 248



3D

BANCO

DIM. (mm): L=2500 P=750 H=890

ART.	KG	RAL	€
MASTERWR2549	1500	7035+7016	1491,10
MASTERWR2550	1500	5012+7016	1544,42

Armadio con 1 cassetto 1x100 1xPR con porta
Armadio con 4 cassetti 3x150 1x300

3D

BANCO REGOLABILE

DIM. (mm): L=2500 P=750 H=765/1115

ART.	KG	RAL	€
MASTERWR2551	800	7035+7016	1616,96
MASTERWR2552	800	5012+7016	1694,15

Armadio 1xPR con porta
Armadio con 5 cassetti 2x75 1x100 1x150 1x200



3D

BANCO REGOLABILE

DIM. (mm): L=2500 P=750 H=1708/2058

ART.	KG	RAL	€
MASTERWR2553	800	7035+7016	2167,21
MASTERWR2554	800	5012+7016	2335,54

Armadio 1xPR con porta
Armadio con 5 cassetti 2x75 1x100 1x150 1x200
Completo di 210 ganci Unipok e 16 contenitori Picking Box Air
Utensili esclusi



ESEMPI DI CONFIGURAZIONE

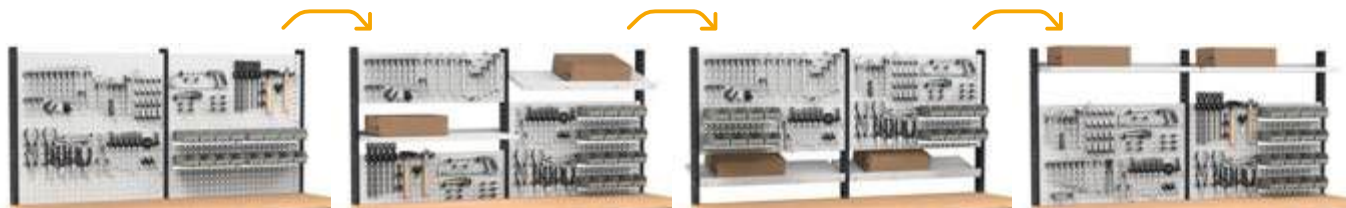

3D

BANCO

DIM. (mm): L=2500 P=750 H=890

ART.	KG	RAL	€
MASTERWR2555	1500	7035+7016	1667,80
MASTERWR2556	1500	5012+7016	1819,70

Armadio con 4 cassetti 3x150 1x300
Armadio con 5 cassetti 2x100 1x150 2x200

3D

BANCO REGOLABILE

DIM. (mm): L=2500 P=750 H=765/1115

ART.	KG	RAL	€
MASTERWR2557	800	7035+7016	1833,65
MASTERWR2558	800	5012+7016	1943,39

Armadio con 4 cassetti 1x100 2x150 1x200
Armadio con 5 cassetti 2x75 1x100 1x150 1x200



3D

BANCO REGOLABILE

DIM. (mm): L=2500 P=750 H=1708/2058

ART.	KG	RAL	€
MASTERWR2559	800	7035+7016	2383,90
MASTERWR2560	800	5012+7016	2584,78

Armadio con 4 cassetti 1x100 2x150 1x200
Armadio con 5 cassetti 2x75 1x100 1x150 1x200
Completo di 210 ganci Unipok e 16 contenitori Picking Box Air
Utensili esclusi





passo fori gambe 25 mm



piano in multiplex spessore 40 mm



Forniti smontati



Portata cassetto 100-75-50 kg



Estrazione cassetto 92-96-100%



vedi pag. 248



BANCO

DIM. (mm): L=2500 P=750 H=890

ART.	KG	RAL	€
MASTERWR2561	1500	7035+7016	1804,51
MASTERWR2562	1500	5012+7016	1979,35

Armadio con 5 cassetti 2x100 1x150 2x200
Armadio con 6 cassetti 1x50 2x100 2x150 1x200



BANCO REGOLABILE

DIM. (mm): L=2500 P=750 H=765/1115

ART.	KG	RAL	€
MASTERWR2563	800	7035+7016	1959,82
MASTERWR2564	800	5012+7016	2098,08

Armadio con 5 cassetti 2x75 1x100 1x150 1x200
Armadio con 6 cassetti 1x50 2x75 2x100 1x200



BANCO REGOLABILE

DIM. (mm): L=2500 P=750 H=1708/2058

ART.	KG	RAL	€
MASTERWR2565	800	7035+7016	2510,07
MASTERWR2566	800	5012+7016	2739,47

Armadio con 5 cassetti 2x75 1x100 1x150 1x200
Armadio con 6 cassetti 1x50 2x75 2x100 1x200
Completo di 210 ganci Unipok e 16 contenitori Picking Box Air
Utensili esclusi



3D

BANCO REGOLABILE

DIM. (mm): L=2500 P=750 H=765/1115

ART.	KG	RAL	€
MASTERWR2567	1500	7035+7016	2600,90
MASTERWR2568	1500	5012+7016	2697,62

2 x Armadio 1xPR con porta
2 x Armadio con 4 cassetti 1x100 2x150 1x200

3D

BANCO REGOLABILE

DIM. (mm): L=2500 P=750 H=765/1115

ART.	KG	RAL	€
MASTERWR2569	1500	7035+7016	3028,70
MASTERWR2570	1500	5012+7016	3122,32

Armadio 1xPR con porta
2 x Armadio con 4 cassetti 1x100 2x150 1x200
Armadio con sistema ribaltabile e morsa



3D

BANCO REGOLABILE

DIM. (mm): L=2500 P=750 H=765/1115

ART.	KG	RAL	€
MASTERWR2571	1500	7035+7016	3133,17
MASTERWR2572	1500	5012+7016	3229,89

Armadio 1xPR con porta
2 x Armadio con 4 cassetti 1x100 2x150 1x200
Armadio per allacciamenti con multipresa Schuko a 4 scomparti
Armadio con sistema ribaltabile e morsa



PORTATA



RAL 7035+RAL 7016



RAL 5012+RAL 7016

PR:PIANO REGOLABILE



passo fori gambe 25 mm



piano in multiplex spessore 40 mm



Forniti smontati



Portata cassetto 100-75-50 kg



Estrazione cassetto 92-96-100%



vedi pag. 248



BANCO

DIM. (mm): L=3000 P=750 H=890

ART.	KG	RAL	€
MASTERWR3001	800	7035+7016	530,72
MASTERWR3002	800	5012+7016	562,34



BANCO REGOLABILE

DIM. (mm): L=3000 P=750 H=765/1115

ART.	KG	RAL	€
MASTERWR3003	800	7035+7016	616,28
MASTERWR3004	800	5012+7016	647,90



BANCO REGOLABILE

DIM. (mm): L=3000 P=750 H=1708/2058

ART.	KG	RAL	€
MASTERWR3005	800	7035+7016	1224,81
MASTERWR3006	800	5012+7016	1371,75

Completo di 270 ganci Unipok e 20 contenitori Picking Box Air
Utensili esclusi



ESEMPI DI CONFIGURAZIONE

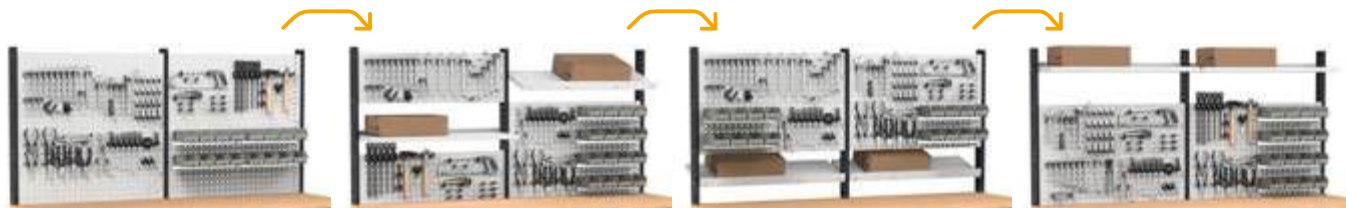

3D

BANCO

DIM. (mm): L=3000 P=750 H=890

ART.	KG	RAL	€
MASTERWR3007	800	7035+7016	803,52
MASTERWR3008	800	5012+7016	846,30

Armadio con 1 cassetto 1x100

3D

BANCO REGOLABILE

DIM. (mm): L=3000 P=750 H=765/1115

ART.	KG	RAL	€
MASTERWR3009	800	7035+7016	889,08
MASTERWR3010	800	5012+7016	931,86

Armadio con 1 cassetto 1x100

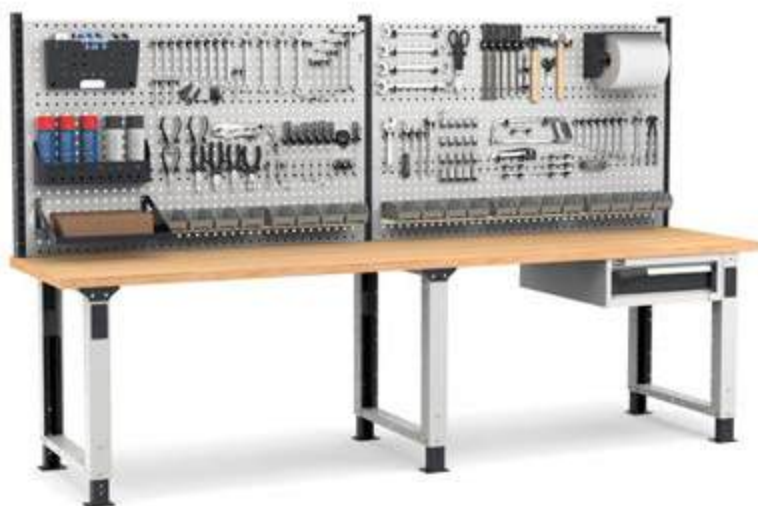

3D

BANCO REGOLABILE

DIM. (mm): L=3000 P=750 H=1708/2058

ART.	KG	RAL	€
MASTERWR3011	800	7035+7016	1497,61
MASTERWR3012	800	5012+7016	1655,71

Armadio con 1 cassetto 1x100
Completo di 270 ganci Unipok e 20 contenitori Picking Box Air
Utensili esclusi



PORTATA



RAL 7035+ RAL 7016



RAL 5012+ RAL 7016



passo fori gambe 25 mm



piano in multiplex spessore 40 mm



Forniti smontati



Portata cassetto 100-75-50 kg



Estrazione cassetto 92-96-100%



vedi pag. 248



BANCO

DIM. (mm): L=3000 P=750 H=890

ART.	KG	RAL	€
MASTERWR3013	800	7035+7016	987,97
MASTERWR3014	800	5012+7016	1088,72

Armadio con 3 cassetti 1x50 1x100 1x150



BANCO REGOLABILE

DIM. (mm): L=3000 P=750 H=765/1115

ART.	KG	RAL	€
MASTERWR3015	800	7035+7016	1073,53
MASTERWR3016	800	5012+7016	1174,28

Armadio con 3 cassetti 1x50 1x100 1x150

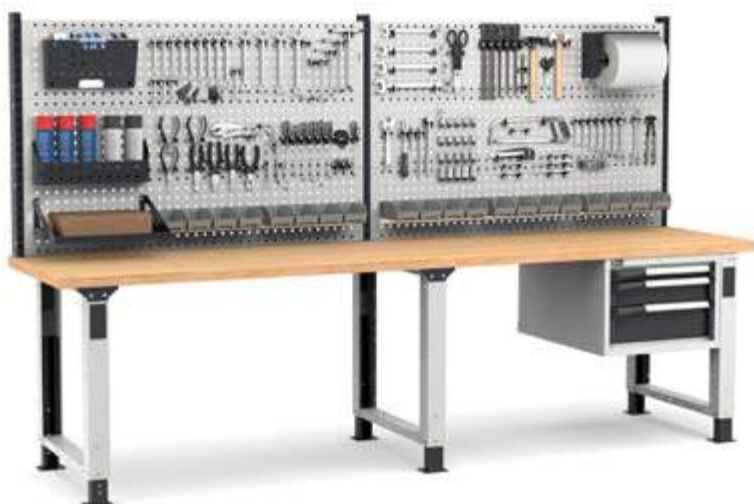

BANCO REGOLABILE

DIM. (mm): L=3000 P=750 H=1708/2058

ART.	KG	RAL	€
MASTERWR3017	800	7035+7016	1682,06
MASTERWR3018	800	5012+7016	1898,13

Armadio con 3 cassetti 1x50 1x100 1x150
Completo di 270 ganci Unipok e 20 contenitori Picking Box Air
Utensili esclusi



ESEMPI DI CONFIGURAZIONE

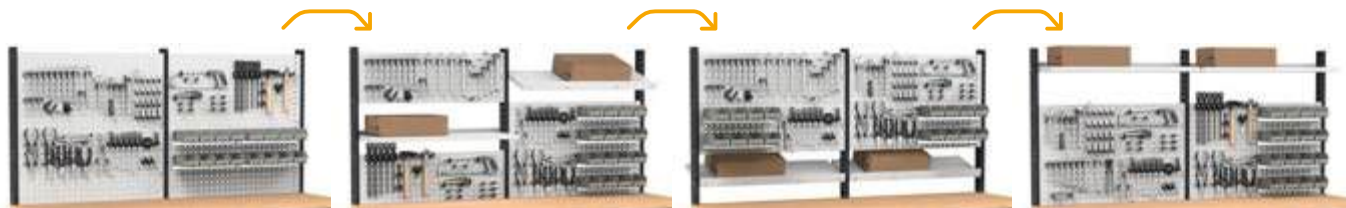

3D

BANCO

DIM. (mm): L=3000 P=750 H=890

ART.	KG	RAL	€
MASTERWR3019	800	7035+7016	1124,99
MASTERWR3020	800	5012+7016	1191,02

Armadio con 4 cassetti 2x75 1x150 1x200

3D

BANCO REGOLABILE

DIM. (mm): L=3000 P=750 H=765/1115

ART.	KG	RAL	€
MASTERWR3021	800	7035+7016	1210,55
MASTERWR3022	800	5012+7016	1276,58

Armadio con 4 cassetti 2x75 1x150 1x200



3D

BANCO REGOLABILE

DIM. (mm): L=3000 P=750 H=1708/2058

ART.	KG	RAL	€
MASTERWR3023	800	7035+7016	1819,08
MASTERWR3024	800	5012+7016	2000,43

Armadio con 4 cassetti 2x75 1x150 1x200
Completo di 270 ganci Unipok e 20 contenitori Picking Box Air
Utensili esclusi



PORTATA



RAL 7035+ RAL 7016



RAL 5012+ RAL 7016



passo fori gambe 25 mm

piano in multiplex spessore 40 mm

Forniti smontati

Portata cassetto 100-75-50 kg

Estrazione cassetto 92-96-100%



vedi pag. 248



3D

BANCO

DIM. (mm): L=3000 P=750 H=890

ART.	KG	RAL	€
MASTERWR3025	800	7035+7016	1138,32
MASTERWR3026	800	5012+7016	1192,88

Armadio con 4 cassetti 3x150 1x300

3D

BANCO REGOLABILE

DIM. (mm): L=3000 P=750 H=765/1115

ART.	KG	RAL	€
MASTERWR3027	800	7035+7016	1238,76
MASTERWR3028	800	5012+7016	1302,93

Armadio con 4 cassetti 1x100 2x150 1x200



3D

BANCO REGOLABILE

DIM. (mm): L=3000 P=750 H=1708/2058

ART.	KG	RAL	€
MASTERWR3029	800	7035+7016	1847,29
MASTERWR3030	800	5012+7016	2026,78

Armadio con 4 cassetti 1x100 2x150 1x200
Completo di 270 ganci Unipok e 20 contenitori Picking Box Air
Utensili esclusi



ESEMPI DI CONFIGURAZIONE

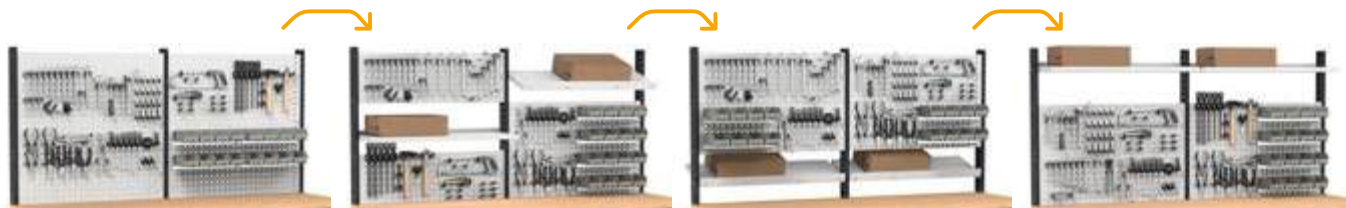

3D

BANCO

DIM. (mm): L=3000 P=750 H=890

ART.	KG	RAL	€
MASTERWR3031	800	7035+7016	1148,24
MASTERWR3032	800	5012+7016	1277,20

Armadio con 5 cassetti 2x100 1x150 2x200

3D

BANCO REGOLABILE

DIM. (mm): L=3000 P=750 H=765/1115

ART.	KG	RAL	€
MASTERWR3033	800	7035+7016	1299,21
MASTERWR3034	800	5012+7016	1376,40

Armadio con 5 cassetti 2x75 1x100 1x150 1x200



3D

BANCO REGOLABILE

DIM. (mm): L=3000 P=750 H=1708/2058

ART.	KG	RAL	€
MASTERWR3035	800	7035+7016	1907,74
MASTERWR3036	800	5012+7016	2100,25

Armadio con 5 cassetti 2x75 1x100 1x150 1x200
Completo di 270 ganci Unipok e 20 contenitori Picking Box Air
Utensili esclusi



PORTATA



RAL 7035+ RAL 7016



RAL 5012+ RAL 7016



passo fori gambe 25 mm

piano in multiplex spessore 40 mm

Forniti smontati

Portata cassetto 100-75-50 kg

Estrazione cassetto 92-96-100%



vedi pag. 248



3D

BANCO

DIM. (mm): L=3000 P=750 H=890

ART.	KG	RAL	€
MASTERWR3037	800	7035+7016	1275,03
MASTERWR3038	800	5012+7016	1352,53

Armadio con 6 cassetti 1x50 2x100 2x150 1x200

3D

BANCO REGOLABILE

DIM. (mm): L=3000 P=750 H=765/1115

ART.	KG	RAL	€
MASTERWR3039	800	7035+7016	1364,93
MASTERWR3040	800	5012+7016	1457,62

Armadio con 6 cassetti 1x50 2x75 2x100 1x200



3D

BANCO REGOLABILE

DIM. (mm): L=3000 P=750 H=1708/2058

ART.	KG	RAL	€
MASTERWR3041	800	7035+7016	1973,46
MASTERWR3042	800	5012+7016	2181,47

Armadio con 6 cassetti 1x50 2x75 2x100 1x200
Completo di 270 ganci Unipok e 20 contenitori Picking Box Air
Utensili esclusi



ESEMPI DI CONFIGURAZIONE

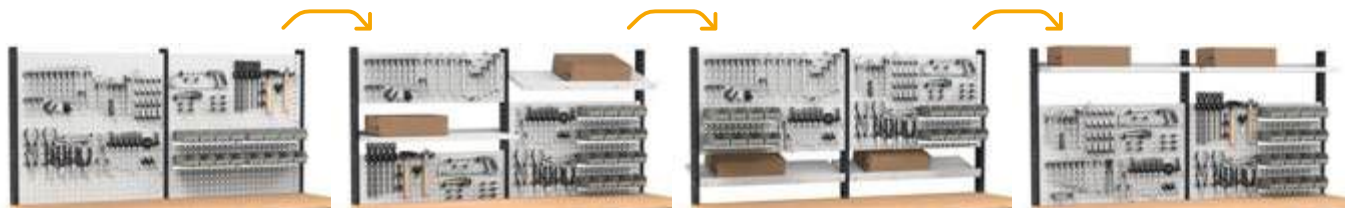

3D

BANCO

DIM. (mm): L=3000 P=750 H=890

ART.	KG	RAL	€
MASTERWR3043	800	7035+7016	971,54
MASTERWR3044	800	5012+7016	1001,92

Armadio con 1 cassetto 1x100 1xPR con porta

3D

BANCO REGOLABILE

DIM. (mm): L=3000 P=750 H=765/1115

ART.	KG	RAL	€
MASTERWR3045	800	7035+7016	1022,07
MASTERWR3046	800	5012+7016	1053,69

Armadio 1xPR con porta



3D

BANCO REGOLABILE

DIM. (mm): L=3000 P=750 H=1708/2058

ART.	KG	RAL	€
MASTERWR3047	800	7035+7016	1630,60
MASTERWR3048	800	5012+7016	1777,54

Armadio 1xPR con porta
Completo di 270 ganci Unipok e 20 contenitori Picking Box Air
Utensili esclusi





passo fori gambe 25 mm

piano in multiplex spessore 40 mm

Forniti smontati

Portata cassetto 100-75-50 kg

Estrazione cassetto 92-96-100%



vedi pag. 248



3D

BANCO

DIM. (mm): L=3000 P=750 H=890

ART.	KG	RAL	€
MASTERWR3049	1500	7035+7016	1579,14
MASTERWR3050	1500	5012+7016	1632,46

Armadio con 1 cassetto 1x100 1xPR con porta
Armadio con 4 cassetti 3x150 1x300

3D

BANCO REGOLABILE

DIM. (mm): L=3000 P=750 H=765/1115

ART.	KG	RAL	€
MASTERWR3051	800	7035+7016	1705,00
MASTERWR3052	800	5012+7016	1782,19

Armadio 1xPR con porta
Armadio con 5 cassetti 2x75 1x100 1x150 1x200



3D

BANCO REGOLABILE

DIM. (mm): L=3000 P=750 H=1708/2058

ART.	KG	RAL	€
MASTERWR3053	800	7035+7016	2313,53
MASTERWR3054	800	5012+7016	2506,04

Armadio 1xPR con porta
Armadio con 5 cassetti 2x75 1x100 1x150 1x200
Completo di 270 ganci Unipok e 20 contenitori Picking Box Air
Utensili esclusi



ESEMPI DI CONFIGURAZIONE

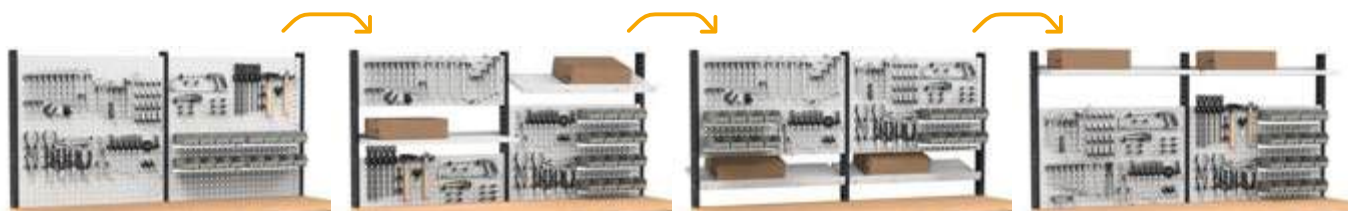

3D

BANCO REGOLABILE

DIM. (mm): L=3000 P=750 H=2010/2360

ART.	KG	RAL	€
MASTERWR3073	800	7035+7016	3202,92

Armadio 1xPR con porta
 Armadio con 5 cassetti 2x75 1x100 1x150 1x200
 2 x Pensile con porta
 Completo di 180 ganci Unipok, accessori Iron Team e 10 contenitori Picking Box Air
 Utensili esclusi





 **passo fori gambe 25 mm**

 **piano in multiplex spessore 40 mm**

 **Forniti smontati**

 **Portata cassetto 100-75-50 kg**

 **Estrazione cassetto 92-96-100%**





vedi pag. 248



3D

BANCO

DIM. (mm): L=3000 P=750 H=890

ART.	 KG	RAL	€
 MASTERWR3055	1500	7035+7016	1755,84
 MASTERWR3056	1500	5012+7016	1907,74



Armadio con 4 cassetti 3x150 1x300

Armadio con 5 cassetti 2x100 1x150 2x200

3D

BANCO REGOLABILE

DIM. (mm): L=3000 P=750 H=765/1115

ART.	 KG	RAL	€
 MASTERWR3057	800	7035+7016	1921,69
 MASTERWR3058	800	5012+7016	2031,43

Armadio con 4 cassetti 1x100 2x150 1x200



Armadio con 5 cassetti 2x75 1x100 1x150 1x200



3D

BANCO REGOLABILE

DIM. (mm): L=3000 P=750 H=1708/2058

ART.	 KG	RAL	€
 MASTERWR3059	800	7035+7016	2530,22
 MASTERWR3060	800	5012+7016	2755,28

Armadio con 4 cassetti 1x100 2x150 1x200

Armadio con 5 cassetti 2x75 1x100 1x150 1x200

Completo di 270 ganci Unipok e 20 contenitori Picking Box Air
Utensili esclusi



ESEMPI DI CONFIGURAZIONE

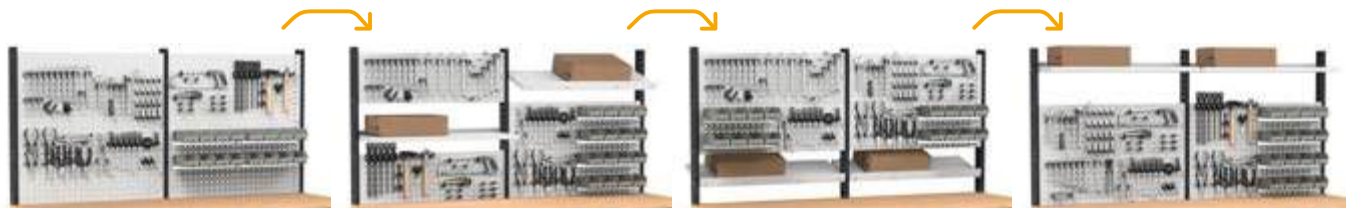

3D

BANCO

DIM. (mm): L=3000 P=750 H=890

ART.	KG	RAL	€
MASTERWR3061	1500	7035+7016	1892,55
MASTERWR3062	1500	5012+7016	2067,39

Armadio con 5 cassetti 2x100 1x150 2x200
Armadio con 6 cassetti 1x50 2x100 2x150 1x200

3D

BANCO REGOLABILE

DIM. (mm): L=3000 P=750 H=765/1115

ART.	KG	RAL	€
MASTERWR3063	800	7035+7016	2047,86
MASTERWR3064	800	5012+7016	2186,12

Armadio con 5 cassetti 2x75 1x100 1x150 1x200
Armadio con 6 cassetti 1x50 2x75 2x100 1x200



3D

BANCO REGOLABILE

DIM. (mm): L=3000 P=750 H=1708/2058

ART.	KG	RAL	€
MASTERWR3065	800	7035+7016	2656,39
MASTERWR3066	800	5012+7016	2909,97

Armadio con 5 cassetti 2x75 1x100 1x150 1x200
Armadio con 6 cassetti 1x50 2x75 2x100 1x200
Completo di 270 ganci Unipok e 20 contenitori Picking Box Air
Utensili esclusi



PORTATA



RAL 7035+ RAL 7016



RAL 5012+ RAL 7016



passo fori gambe 25 mm

piano in multiplex spessore 40 mm

Forniti smontati

Portata cassetto 100-75-50 kg

Estrazione cassetto 92-96-100%



vedi pag. 248



3D

BANCO REGOLABILE

DIM. (mm): L=3000 P=750 H=765/1115

ART.	KG	RAL	€
MASTERWR3067	1500	7035+7016	2846,42
MASTERWR3068	1500	5012+7016	2936,94

2 x Armadio 1xPR con porta
2 x Armadio con 4 cassetti 1x100 2x150 1x200

3D

BANCO REGOLABILE CON RUOTE

DIM. (mm): L=3000 P=750 H=921/1271

ART.	KG	RAL	€
MASTERMR3067	750	7035+7016	3028,08
MASTERMR3068	750	5012+7016	3118,60

2 x Armadio 1xPR con porta
2 x Armadio con 4 cassetti 1x100 2x150 1x200
Kit 6 ruote in gomma elastica Ø 125 mm





3D

BANCO REGOLABILE

DIM. (mm): L=3000 P=750 H=765/1115

ART.	KG	RAL	€
MASTERWR3069	1500	7035+7016	3339,01
MASTERWR3070	1500	5012+7016	3428,60

Armadio 1xPR con porta
2 x Armadio con 4 cassetti 1x100 2x150 1x200
Armadio con sistema ribaltabile e morsa

3D

BANCO REGOLABILE CON RUOTE

DIM. (mm): L=3000 P=750 H=921/1271

ART.	KG	RAL	€
MASTERMR3069	750	7035+7016	3520,67
MASTERMR3070	750	5012+7016	3610,26

Armadio 1xPR con porta
2 x Armadio con 4 cassetti 1x100 2x150 1x200
Armadio con sistema ribaltabile e morsa
Kit 6 ruote in gomma elastica Ø 125 mm



3D

BANCO REGOLABILE

DIM. (mm): L=3000 P=750 H=765/1115

ART.	KG	RAL	€
MASTERWR3071	1500	7035+7016	3378,69
MASTERWR3072	1500	5012+7016	3469,21

Armadio 1xPR con porta
2 x Armadio con 4 cassetti 1x100 2x150 1x200
Armadio per allacciamenti con multipresa Schuko a 4 scomparti
Armadio con sistema ribaltabile e morsa

3D

BANCO REGOLABILE CON RUOTE

DIM. (mm): L=3000 P=750 H=921/1271

ART.	KG	RAL	€
MASTERMR3071	750	7035+7016	3560,35
MASTERMR3072	750	5012+7016	3650,87

Armadio 1xPR con porta
2 x Armadio con 4 cassetti 1x100 2x150 1x200
Armadio per allacciamenti con multipresa Schuko a 4 scomparti
Armadio con sistema ribaltabile e morsa
Kit 6 ruote in gomma elastica Ø 125 mm



PORTATA



RAL 7035+RAL 7016



RAL 5012+RAL 7016

PR: PIANO REGOLABILE

MASTER

SCHEMA TECNICO

L → 1300 mm



L → 1500 mm



L → 2000 mm



L → 2500 mm







L → 3000 mm



MASTER





COMPONENTI

PIANO IN MULTIPLEX

ART.	L mm	P mm	H mm	€
 MBP13754M0V0100	1300	750	40	147,87
 MBP15754M0V0100	1500	750	40	161,82
 MBP20754M0V0100	2000	750	40	208,94
 MBP25754M0V0100	2500	750	40	257,61
 MBP30754M0V0100	3000	750	40	345,65



















COPERTURA IN ACCIAIO GOMMATO A 2 LATI PER PIANO IN MULTIPLEX

ART.	L mm	P mm	H mm	€
 MBC13752G020V07	1300	750	22	119,04
 MBC15752G020V07	1500	750	22	125,55
 MBC20752G020V07	2000	750	22	160,89
 MBC25752G020V07	2500	750	22	250,79
 MBC30752G020V07	3000	750	22	281,17





PIANO INFERIORE

ART.	L mm	P mm	H mm	 KG	RAL	€
 MBI05673A0V0V08	561	724	35	200	7035	30,07
 MBI05673A0V0V04	561	724	35	200	5012	34,41
 MBI06373A0V0V08	637	724	35	200	7035	30,69
 MBI06373A0V0V04	637	724	35	200	5012	35,34
 MBI07173A0V0V08	714	724	35	200	7035	33,79
 MBI07173A0V0V04	714	724	35	200	5012	37,51
 MBI09673A0V0V08	969	724	35	200	7035	38,13
 MBI09673A0V0V04	969	724	35	200	5012	53,01
 MBI11273A0V0V08	1122	724	35	200	7035	41,54
 MBI11273A0V0V04	1122	724	35	200	5012	57,35
 MBI11973A0V0V08	1198	724	35	200	7035	44,02
 MBI11973A0V0V04	1198	724	35	200	5012	58,59
 MBI12773A0V0V08	1275	724	35	200	7035	46,50
 MBI12773A0V0V04	1275	724	35	200	5012	60,76
 MBI16873A0V0V08	1683	724	35	120	7035	53,94
 MBI16873A0V0V04	1683	724	35	120	5012	67,58



SUPPORTO PIANO INFERIORE PER ARMADIO H=850 MM

ART.	L mm	P mm	H mm	RAL	€
 MBISUP7850V0V08	25	721	102	7035	12,40
 MBISUP7850V0V04	25	721	102	5012	13,02



PORTATA



RAL 5012



RAL 7035

MASTER

COMPONENTI



Le gambe del banco Master sono tutte dotate di un foro su un lato chiuso da un tappo. Rimuovendo il tappo, è possibile inserire una multipresa a 2 posti con il relativo cavo di collegamento per fornire il banco di una pratica fonte di energia elettrica. Il cavo passa all'interno della gamba, che è cava, mantenendo la postazione ordinata e priva di fili in vista. A seconda del posizionamento della gamba, il foro può trovarsi nella parte frontale o posteriore del banco, garantendo flessibilità nell'installazione.

FBLET004007 FBLET016007

vedi pag. 253



GAMBA

ART.	L mm	P mm	H mm	RAL	€
M03G085100V0008	84	726	850	7035	45,57
M03G085100V0004	84	726	850	5012	56,11



1 GAMBA

Predisposta per allunghe e piedini

ART.	L mm	P mm	H mm	RAL	€
M03G070100V0008	80	726	700	7035	42,47
M03G070100V0004	80	726	700	5012	53,01



2 COPPIA ALLUNGHE PER GAMBA

Predisposta per ruote

ART.	L mm	P mm	H mm	passo mm	RAL	€
M00G00010AL0039	105	85	518	25	7016	31,62



MASTER

COMPONENTI



A COPPIA STAFFE A V PER GAMBA

ART.	L mm	P mm	H mm	RAL	€
M00G00010ST0139	153	34	50	7016	16,12



B COPPIA STAFFE A FILO PER GAMBA

ART.	L mm	P mm	H mm	€
M00G00010ST0299	73	90	40	18,29

1500/2000



Nei banchi da 1500/2000 mm è obbligatorio utilizzare una coppia di squadre a V per ogni gamba senza cassetteria.

2500



Nei banchi da 2500 mm, le gambe senza cassetteria devono essere dotate di staffe a filo se sono esterne e di staffe a V se sono centrali.

3000



Nei banchi da 3000 mm è obbligatorio installare una coppia di squadre a V per ogni gamba senza cassetteria.

 RAL 5012

 RAL 7016

 RAL 7035

MASTER

COMPONENTI



1 GAMBA Predisposta per allunghe e piedini

ART.	L mm	P mm	H mm	RAL	€
M03G070100V0008	80	726	700	7035	42,47
M03G070100V0004	80	726	700	5012	53,01



2 COPPIA ALLUNGHE PER GAMBA Predisposta per ruote

ART.	L mm	P mm	H mm	passo mm	RAL	€
M00G00010AL0039	105	85	518	25	7016	31,62



3 COPPIA PIEDINI PER GAMBA Predisposta per ruote

ART.	L mm	P mm	H mm	RAL	€
M00G00010PD0039	120	98	34	7016	11,16

Non può essere utilizzato in presenza di allunghe.



4 MANIGLIA A TUBO

ART.	L mm	P mm	H mm	RAL	€
M03G00010MN0039	170	724	109	7016	45,26

MASTER

COMPONENTI

5 KIT RUOTE



ART.	Ø mm	KG	H mm	materiale				€
FKRS1252101	125	750	155	Gomma elastica	-	2	2	90,83
FKRT1252101	125	750	155	Gomma elastica	2	2	-	99,51
FKRU1252101	125	300	155	Gomma antitraccia sintetica	-	2	2	56,73
FKRW1252101	125	300	155	Gomma antitraccia sintetica	2	2	-	62,31
FKRX1252101	125	500	155	Gomma antitraccia sintetica	2	2	2	84,32
FKRY1252101	125	1250	155	Gomma elastica	2	2	2	136,40



RUOTA GIREVOLE



RUOTA GIREVOLE CON FRENO



RUOTA FISSA



TRAVERSO DI COLLEGAMENTO



ART.	L mm	P mm	H mm	adatto per banco L mm	RAL	€
MBT09610V0V0008	1108	115	38	1300	7035	24,80
MBT09610V0V0004	1108	115	38	1300	5012	28,83
MBT11210V0V0008	1261	115	38	1500	7035	26,35
MBT11210V0V0004	1261	115	38	1500	5012	30,07
MBT16810V0V0008	1822	115	38	2000	7035	30,69
MBT16810V0V0004	1822	115	38	2000	5012	39,06

PIANO INFERIORE



ART.	L mm	P mm	H mm	KG	RAL	€
MBI05673A0V0V08	561	724	35	200	7035	30,07
MBI05673A0V0V04	561	724	35	200	5012	34,41
MBI11273A0V0V08	1122	724	35	200	7035	41,54
MBI11273A0V0V04	1122	724	35	200	5012	57,35

1500



2000



2000



PORTATA



RAL 5012



RAL 7016



RAL 7035

MASTER

COMPONENTI



1 ARMADIO PER MORSA

ART.	L mm	P mm	RAL	€
M13M070010000PD	408	726	7035+7016	310,00
M13M07001000004	408	726	5012	310,00

H=700 mm



2 SISTEMA MORSA A SCOMPARSA

ART.	L mm	P mm	H mm	RAL	€
FBLIT063039	255	266	320	7016	223,82



3 STAFFA BASE GIREVOLE PER SISTEMA MORSA A SCOMPARSA

ART.	L mm	P mm	H mm	RAL	€
FBLIT062039	219	190	6	7016	28,21

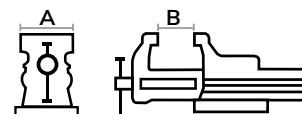

4 MORSA PROFESSIONALE MODELLO WORK GO

ART.	L mm	P mm	H mm	A mm	B mm	RAL	€
F22FABL11650039	150	389	150	120	150	7016	164,30

⚠ Con ganasce stringitubo per tubi con Ø esterno 17-48 mm



5 BASE GIREVOLE PER MORSA MODELLO WORK GO

ART.	L mm	P mm	H mm	RAL	€
F22FABL1165BA39	218	187	26	7016	44,64

MASTER

COMPONENTI



1 ARMADIO PER ALLACCIAMENTI

ART.	L mm	P mm	RAL	€
M03E070100V0008	153	726	7035	136,71
M03E070100V0004	153	726	5012	136,71

H=700 mm



2 ARROTOLATORE PER ARIA COMPRESSA

ART.	L cavo m	Pressione max Mpa	€
M00AR00AIR00100	5	1	133,61



3 ARROTOLATORE ELETTRICO CON PRESA SCHUKO

ART.	L cavo m	tipo presa	Volt	Watt	€
M00AR00ELE00100	5	Schuko	230	800	159,65



4 RULLO PER ARROTOLATORE

ART.	€
MBR13S0V0V00339	30,07



5 CAVO DI COLLEGAMENTO WIELAND

ART.	L mm	P mm	H mm	tipo spina	colore	€
FBLET016007	3000	50	50	Schuko/Francese	Nero	19,22
FBLET017007	3000	50	50	Inglese	Nero	23,25
FBLET018007	3000	50	50	Svizzera	Nero	21,39



6 MULTIPRESA A 2 SCOMPARTI

ART.	L mm	P mm	H mm	tipo presa	colore	€
FBLET004007	148	59	46	Schuko	Nero	20,77
FBLET006007	148	59	46	Svizzera	Nero	44,64
FBLET008007	148	59	46	Inglese	Nero	36,27
FBLET010007	148	59	46	Francese	Nero	20,77



7 MULTIPRESA A 4 SCOMPARTI

ART.	L mm	P mm	H mm	tipo presa	colore	€
FBLET005007	248	59	46	Schuko	Nero	27,28
FBLET007007	248	59	46	Svizzera	Nero	51,15
FBLET009007	248	59	46	Inglese	Nero	63,24
FBLET011007	248	59	46	Francese	Nero	27,28



RAL 7035 + RAL 7016



RAL 5012



RAL 7016



RAL 7035

MASTER

COMPONENTI

ARMADI CON CASSETTI

L → 561 mm

27X36 EH



ARMADIO CON 1 CASSETTO 1X100

ART.	cassetti		RAL	€
	KG			
M23A020C01005PD	100-75-50	92-96-100%	7035+7016	270,63
M23A020C0100504	100-75-50	92-96-100%	5012	281,79

H=200 mm

CONFIGURE



ARMADIO CON 3 CASSETTI 1X50 1X100 1X150

ART.	cassetti		RAL	€
	KG			
M23A040C01001PD	100-75-50	92-96-100%	7035+7016	473,37
M23A040C0100104	100-75-50	92-96-100%	5012	542,50

H=400 mm

CONFIGURE



ARMADIO CON 4 CASSETTI 2X75 1X150 1X200

ART.	cassetti		RAL	€
	KG			
M23A060C01020PD	100-75-50	92-96-100%	7035+7016	610,39
M23A060C0102004	100-75-50	92-96-100%	5012	644,80

H=600 mm

CONFIGURE



ARMADIO CON 4 CASSETTI 1X100 2X150 1X200

ART.	cassetti		RAL	€
	KG			
M23A070C01049PD	100-75-50	92-96-100%	7035+7016	638,60
M23A070C0104904	100-75-50	92-96-100%	5012	671,15

H=700 mm

CONFIGURE

MASTER

COMPONENTI

ARMADI CON CASSETTI

L → 561 mm

27X36 EH



ARMADIO CON 5 CASSETTI 2X75 1X100 1X150 1X200

ART.	cassetti		RAL	€
	KG			
M23A070C01031PD	100-75-50	92-96-100%	7035+7016	699,05
M23A070C0103104	100-75-50	92-96-100%	5012	744,62

H=700 mm

CONFIGURE



ARMADIO CON 6 CASSETTI 1X50 2X75 2X100 1X200

ART.	cassetti		RAL	€
	KG			
M23A070C01032PD	100-75-50	92-96-100%	7035+7016	764,77
M23A070C0103204	100-75-50	92-96-100%	5012	825,84

H=700 mm

CONFIGURE



ARMADIO CON 4 CASSETTI 3X150 1X300

ART.	cassetti		RAL	€
	KG			
M23A085C010AQPD	100-75-50	92-96-100%	7035+7016	669,29
M23A085C010AQ04	100-75-50	92-96-100%	5012	702,77

H=850 mm

CONFIGURE



ARMADIO CON 5 CASSETTI 2X100 1X150 2X200

ART.	cassetti		RAL	€
	KG			
M23A085C01090PD	100-75-50	92-96-100%	7035+7016	679,21
M23A085C0109004	100-75-50	92-96-100%	5012	787,09

H=850 mm

CONFIGURE



PORTATA



ESTRAZIONE



RAL 7035 + RAL 7016



RAL 5012

MASTER

COMPONENTI

ARMADI

L ➔ 561 mm

27X36 EH



ARMADIO CON 6 CASSETTI 1X50 2X100 2X150 1X200

ART.	cassetti		RAL	€
	KG			
M23A085C01091PD	100-75-50	92-96-100%	7035+7016	806,00
M23A085C0109104	100-75-50	92-96-100%	5012	862,42

H=850 mm

CONFIGURE



ARMADIO 1XPR

Predisposto per porta

ART.	L mm	P mm	H mm	RAL	€
M23A070X010SZ08	561	726	700	7035	351,85
M23A070X010SZ04	561	726	700	5012	351,85

H=700 mm



ARMADIO CON 1 CASSETTO 1X100 1XPR

Predisposto per porta

ART.	cassetti		RAL	€
	KG			
M23A085C010SYPD	100-75-50	92-96-100%	7035+7016	432,45
M23A085C010SY04	100-75-50	92-96-100%	5012	441,75

H=850 mm



PORTA INTERNA SINISTRA H=600 MM CON MANIGLIA DARK GREY

ART.	L mm	P mm	H mm	apertura	RAL	€
M20P060C0104239	503	34	600	Sinistra	7016	70,06
M20P060C0104204	503	34	600	Sinistra	5012	70,06



PORTA INTERNA DESTRA H=600 MM CON MANIGLIA DARK GREY

ART.	L mm	P mm	H mm	apertura	RAL	€
M20P060C0104139	503	34	600	Destra	7016	70,06
M20P060C0104104	503	34	600	Destra	5012	70,06

MASTER

COMPONENTI

ARMADI CON CASSETTI

L → 714 mm

36X36 EH



ARMADIO CON 4 CASSETTI 1X100 2X150 1X200

ART.	cassetti		RAL	€
M33A070C01049PD	100-75-50	92-96-100%	7035+7016	717,34
M33A070C0104904	100-75-50	92-96-100%	5012	746,79

H=700 mm

ARMADI CON CASSETTI

L → 867 mm

45X36 EH



ARMADIO CON 4 CASSETTI 1X100 2X150 1X200

ART.	cassetti		RAL	€
M43A070C01049PD	100-75-50	92-96-100%	7035+7016	860,87
M43A070C0104904	100-75-50	92-96-100%	5012	889,39

H=700 mm



BANCHI PER ELETTRONICA

DYNAMIC

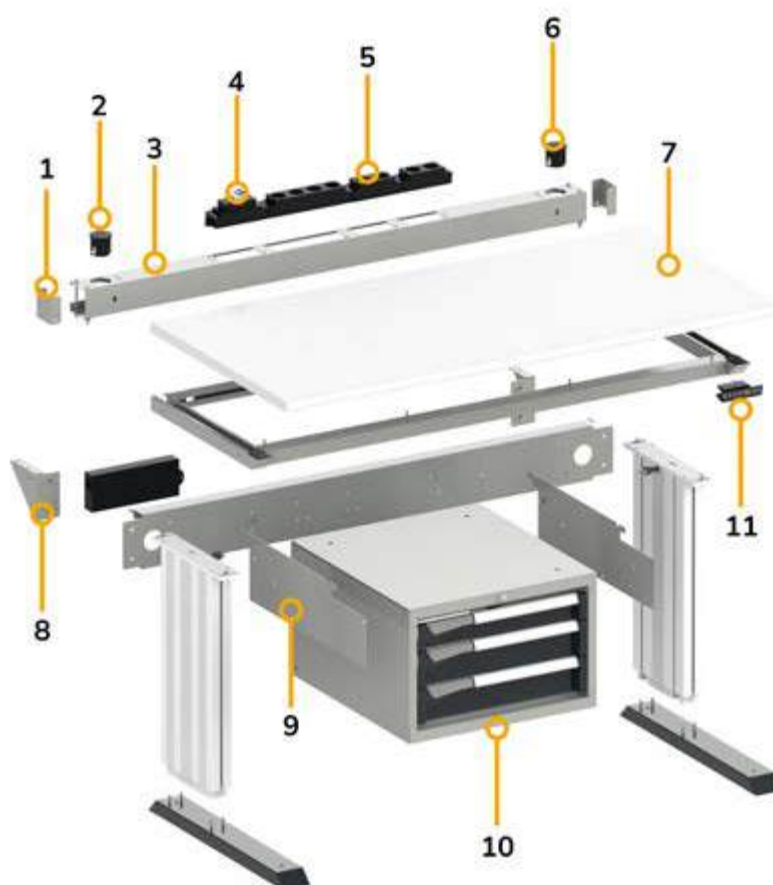

1. Tampone
2. USB Dati
3. Telaio
4. Magnetotermico

5. Multiprese
6. USB Ricarica
7. Piano in laminato
8. Angolare

9. Supporto
10. Armadio a cassette
11. Tastierino

La postazione di lavoro Dynamic è una soluzione dinamica ed ergonomica con **gambe regolabili in altezza elettronicamente** tramite un pratico tastierino con 3 memorie di posizionamento. È disponibile con larghezza 985 e 1470 mm ed è dotato di un **piano di lavoro in laminato**. La componentistica elettrica può essere installata nel traverso di serie o nel telaio aggiuntivo che consente anche il fissaggio dei montanti per parete attrezzata. Dynamic può essere personalizzato con armadi a cassette e con **prodotti per l'ESD** quali tappeti e prese di messa a terra per poter essere impiegato anche per la lavorazione di componenti elettroniche.



**PORTATA BANCO 400
KG**

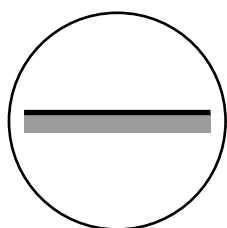

PIANO IN LAMINATO

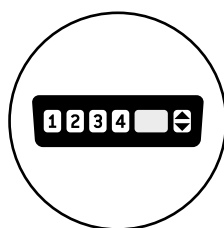

**TASTIERINO CON 3
MEMORIE**

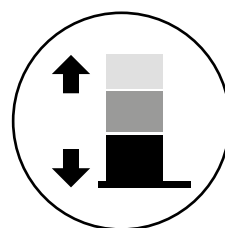

**REGOLABILE IN
ALTEZZA
ELETTRONICAMENTE**

DYNAMIC



PIANO IN LAMINATO

Realizzato in laminato spesso 30 mm, il piano di lavoro offre resistenza contro graffi, abrasioni e umidità. La superficie liscia e non porosa facilita la rimozione delle impurità, garantendo un elevato grado di pulizia.



ALTEZZA REGOLABILE

Il banco è dotato di un sistema elettronico per la regolazione delle gambe, che consente di variare l'altezza del piano di lavoro da 740 mm a 1140 mm in modo semplice e veloce.



TASTIERINO

Il tastierino controlla il sistema di regolazione delle gambe. Oltre a consentire la modifica dell'altezza del piano, può memorizzare fino a 3 posizioni per adattare il banco in base all'utilizzatore o al lavoro da svolgere.



TRAVERSO REVERSIBILE

Il traverso è predisposto per l'installazione di multiprese elettriche e interruttori magnetotermici. Presenta delle incisioni per il posizionamento dei diversi Iron Team Electric sia nella parte posteriore che anteriore.



TELAIO PORTAPRESE AGGIUNTIVO

Il telaio aggiuntivo amplia la profondità del banco, creando uno spazio dedicato per multiprese e interruttori magnetotermici. I diversi componenti elettrici possono essere installati nella parte superiore o inferiore del telaio.



PROTEZIONE ESD

Tappeti, prese e cavi ESD trasformano il banco in una perfetta postazione per la lavorazione di componenti elettronici, assicurando la protezione dell'operatore e dei prodotti manipolati.



PANNELLO PORTA ATTREZZI

Il banco da lavoro può essere arricchito con una pratica parete porta attrezzi, ideale per l'organizzazione di utensili e componenti di uso frequente. Il pannello forato si installa tramite montanti solo sul telaio portaprese aggiuntivo, senza sottrarre spazio utile al piano di lavoro.

DYNAMIC

Il tavolo da imballaggio Dynamic è progettato per ottimizzare ogni fase del confezionamento, offrendo massima funzionalità, ordine e versatilità. Dotato di un **piano in laminato** regolabile in altezza, può essere adattato alla posizione di lavoro dell'operatore. La parete attrezzata modulare offre ampie possibilità di configurazione e può trasformarsi in una **mensola inclinata** per **contenitori** estraibili su guide e per **divisori verticali**. La **taglierina** integrata nella parete attrezzata e il **carrello porta rotoli** permettono di effettuare operazioni di taglio direttamente sul banco, mentre i **bracci estensibili** sono ideali per tenere a portata di mano computer, vassoi portautensili Pikpad e altri contenitori.



DYNAMIC



CONTENITORI CON GUIDE

vedi pag. 26

I contenitori RK Box Air sono installati su apposite guide che ne consentono una facile estrazione, evitando il rischio di caduta grazie al blocco in apertura. Questo sistema garantisce un accesso pratico, sicuro ed ergonomico al materiale stoccato.



DIVISORI

vedi pag. 327

I divisori verticali ripartiscono lo spazio sulle mensole per l'organizzazione ordinata e stabile di cartoni, scatole e materiale di imballaggio.



BRACCI ESTENSIBILI

vedi pag. 300 e 318

I bracci estensibili possono essere configurati in base alle specifiche esigenze, offrendo spazio aggiuntivo per attrezzature senza occupare il piano di lavoro. Sono ideali per alloggiare computer per il controllo ordini e vassoi Pikpad con gli utensili più utilizzati.



PORTA ROTOLI

vedi pag. 327

Il porta rotolo trasforma Bin Cart in un porta bobine professionale, facilmente movimentabile e posizionabile. Fissato con staffe ai montanti del carrello è dotato di fermo di sicurezza che blocca l'asta e ne evita la fuoriuscita dall'alloggiamento.



TAGLIERINA

vedi pag. 327

La taglierina è dotata di un carrello portalame scorrevole che garantisce un taglio netto e preciso in entrambe le direzioni. Si installa direttamente ai montanti del banco tramite staffe, lasciando libero il piano di lavoro. Può essere impiegata per il taglio di carta, cartone ondulato, oltre a pluriball e nylon.



ART.	L mm	P mm	H mm	KG	RAL	€
DYNAMIC1504	1497	780	740/1140	400	7035+7016	2736,37

Composto da:

qtà	descrizione
1	Banco smontato regolabile elettricamente
1	Armadio L=560 mm con 3 cassetti 1x75 2x100
1	Telaio portaprese aggiuntivo completo di tamponi e angolari
1	Coppia supporti per armadio
2	Multipresa schuko a 2 scomparti
1	Multipresa schuko a 4 scomparti
1	Magnetotermico differenziale
1	Cavo di collegamento wieland con spine in/out
1	Cavo di collegamento wieland schuko/francese
1	Presse usb dati
1	Presse usb ricarica



ART.	L mm	P mm	H mm	KG	RAL	€
DYNAMIC1501	1497	780	1983/2383	400	7035+7016	3575,23

Composto da:

qtà	descrizione
1	Banco smontato regolabile elettricamente
1	Armadio L=560 mm con 3 cassetti 1x75 2x100
2	Pannello forato/mensola con 1 bordo fermacasse
1	Kit 2 montanti biasolati
1	Kit 2 supporti inclinati con binario
1	Pannello forato Electric
1	Lampada doppia
1	Coppia supporti per armadio
1	Telaio portaprese aggiuntivo completo di tamponi e angolari
2	Lampada singola
1	Binario supplementare con attacchi
1	Presse usb ricarica
1	Presse usb dati
1	Cavo di collegamento wieland schuko/francese
1	Magnetotermico differenziale
1	Multipresa schuko a 4 scomparti
2	Multipresa schuko a 2 scomparti
36	Contenitore in polipropilene Picking Box Air mis. 2





ART.	L mm	P mm	H mm	KG	RAL	€
DYNAMIC1503	1497	780	1983/2383	400	7035+7016	3471,69

Composto da:

qtà	descrizione
1	Banco smontato regolabile elettricamente
1	Armadio L=500 mm con 1 cassetto H=150 mm
1	Binario supplementare con attacchi
1	Pannello forato/mensola
2	Pannello forato/mensola con 1 bordo fermacasse
1	Kit 2 montanti biasolati
1	Kit 2 supporti inclinati con binario
1	Mensola porta oggetti reversibile
1	Gancio Unipok per utensili - confezione 30 pezzi
1	Coperchio per armadio L=500 mm
2	Multipresa schuko a 2 scomparti
1	Multipresa schuko a 4 scomparti
1	Magnetotermico differenziale
1	Cavo di collegamento wieland schuko/francese
1	Presa usb dati
1	Presa usb ricarica
1	Pannello forato Electric
1	Lampada doppia
3	Lampada singola
1	Telaio portaprese aggiuntivo completo di tamponi e angolari
1	Coppia supporti per armadio
36	Contenitore in polipropilene Picking Box Air mis. 2



ART.	L mm	P mm	H mm	KG	RAL	€
DYNAMIC1502	1497	780	1983/2383	400	7035+7016	3180,29

Composto da:

qtà	descrizione
1	Banco smontato regolabile elettricamente
2	Pensile con porta
1	Binario supplementare con attacchi
2	Pannello forato/mensola con 1 bordo fermacasse
1	Kit 2 montanti biasolati
1	Kit 2 supporti inclinati con binario
1	Pannello forato Electric
1	Multipresa schuko a 4 scomparti
1	Magnetotermico differenziale
1	Cavo di collegamento wieland schuko/francese
1	Presa usb dati
1	Presa usb ricarica
1	Mensola porta oggetti reversibile
1	Lampada doppia
1	Lampada singola
1	Telaio portaprese aggiuntivo completo di tamponi e angolari
2	Multipresa schuko a 2 scomparti
6	Kit 3 contenitori Picking Box Air mis. 2



PORTATA





RAL 7035 + RAL 7016

DYNAMIC

COMPONENTI

L ➔ 1000 - 1500 - 2000 mm

 400 kg

 regolabili in altezza

 Forniti smontati



BANCO BASE CON TRAVERSO REVERSIBILE



ART.	L mm	P mm	H mm	RAL	€
FLE0970E0PD	985	700	740/1140	7035+7016	1536,36
FLE1470E0PD	1470	700	740/1140	7035+7016	1642,38
FLE1970E0PD	1970	700	740/1140	7035+7016	1748,40

1. Traverso reversibile

VISTA ANTERIORE DEL TRAVERSO



VISTA POSTERIORE DEL TRAVERSO



Il traverso del banco presenta delle incisioni per la collocazione delle prese elettriche e degli interruttori magnetotermici Iron Team Electric. In base alla dimensione scelta, il numero di intagli varia. I diversi componenti possono essere installati sia nella parte posteriore che anteriore del traverso. Gli Iron Team Electric non sono compresi con il traverso.

SCHEMA PRESE TRAVERSO

1000



① ② ③ ⑤ ①

1500



① ② ③ ④ ⑤ ①

① foro per cavi ② magnetotermico ③ multipresa 2 scomparti ④ multipresa 4 scomparti ⑤ centralina

DYNAMIC

COMPONENTI

L ➤ 1000 - 1500 - 2000 mm

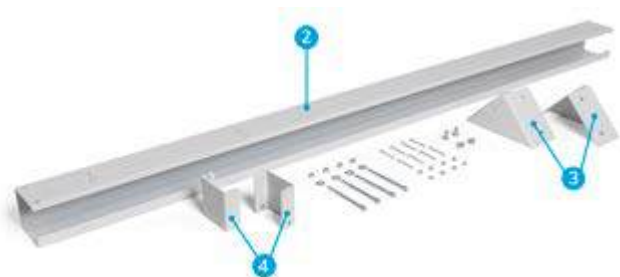

1. Traverso reversibile
2. Telaio
3. Angolari
4. Tamponi

TELAIO PORTAPRESE AGGIUNTIVO COMPLETO DI TAMPONI E ANGOLARI

ART.	L mm	P mm	H mm	RAL	€
FBL46600008	1014	130	208	7035	65,72
FBL46650008	1499	130	208	7035	72,54
FBL46670008	1999	130	208	7035	106,02

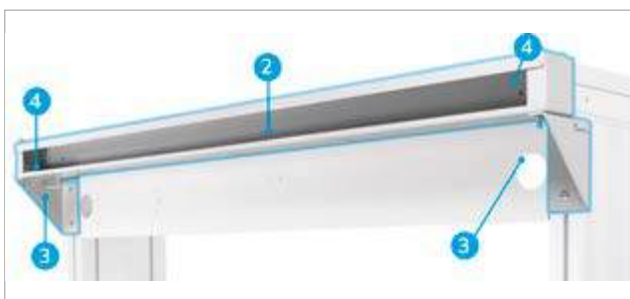

VISTA SUPERIORE DEL TELAI0



VISTA INFERIORE DEL TELAI0

Per il montaggio del montante Work Look è necessaria l'installazione del telaio aggiuntivo.



Il telaio reversibile per banco presenta delle incisioni per la collocazione delle prese elettriche e degli interruttori magnetotermici Iron Team Electric. In base alla dimensione scelta, il numero di intagli varia. I diversi componenti possono essere installati sia nella parte superiore che inferiore del telaio reversibile. Gli Iron Team Electric non sono compresi con il telaio aggiuntivo.

SCHEMA PRESE TELAI0

1000



- 1 2 4 3 3 5

1500



- 1 2 4 3 3 1

- 1 USB dati 2 magnetotermico 3 multipresa 2 scomparti 4 multipresa 4 scomparti 5 USB ricarica

RAL 7035 + RAL 7016 RAL 7035



ARMADIO CON 3 CASSETTI



ART.	L mm	P mm	H mm	cassetti				RAL	€	
				n.	H 75 mm	H 100 mm	KG			
MBR05SC010203PD	560	610	369	3	1	2	100-75-50	92-96-100%	7035+7016	455,39

ARMADIO CON 1 CASSETTO



ART.	L mm	P mm	H mm	cassetti				RAL	€
				n.	H mm	KG			
FBG03S50C0001PD	500	630	210	1	150	80	86%	7035+7016	106,95



COPERCHIO PER ARMADIO L=500 MM

Per armadio ad 1 cassetto



ART.	L mm	P mm	H mm	RAL	€
FBP66900008	496	601	2	7035	35,65



COPPIA SUPPORTI PER ARMADIO



ART.	L mm	P mm	H mm	RAL	€
FBP46010008	2	648	181	7035	23,25

IRONTEAM ELECTRIC



FBLET012007



FBLET004007



FBLET005007



FBLET016007



FBLET013007



FBLET020007



FBLET019007

vedi pag. 328

DYNAMIC

COMPONENTI



1. Tappeto ESD a 2 strati
2. Spina schuko ESD
3. Cinturino regolabile con bottoni completo di cavetto
4. Cavetto con bottoni

TAPPETO ESD A 2 STRATI

ART.	Lmm	Pmm	Hmm	€
FAXTAPPIER120XB	900	600	2	108,50



SPINA SCHUKO ESD

ART.	Lmm	Pmm	Hmm	€
FAXSCHUKOESD005	52	52	72	24,80



CINTURINO REGOLABILE CON BOTTONI COMPLETO DI CAVETTO

ART.	L cavo m	€
FAXITE780419304	2,5	10,23



CAVETTO CON BOTTONI

ART.	Lmm	€
FAXITE7804885XB	2500	8,06



PORTATA



ESTRAZIONE



RAL 7035 + RAL 7016



RAL 7035

PARETI PORTA ATTREZZI

WORK LOOK

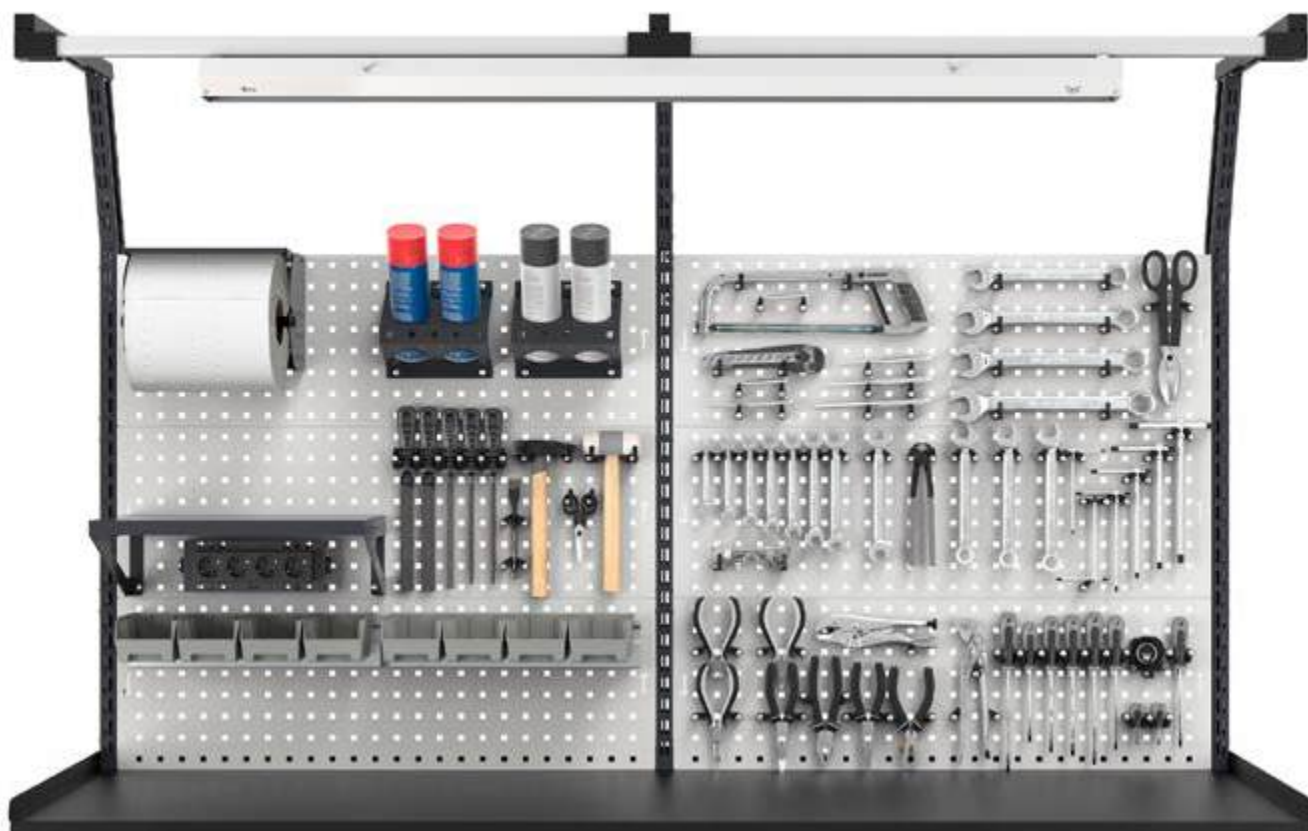

I **pannelli forati** Work Look con foro **10x10** mm possono essere posizionati su banchi da lavoro, carrelli, pareti in legno o muri per creare pareti porta attrezzi di diverse dimensioni. Se installato su montanti per banchi da lavoro, l'utente potrà scegliere se impiegare il pannello come **parete porta utensili** oppure come **mensole orizzontale o inclinata** con bordo fermacasse. Work Look può ospitare una vasta gamma di componenti: da strutture aeree e lampade, fino a pensili vasistas, accessori e ganci.

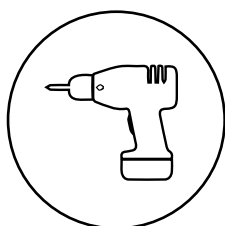

FISSAGGIO A MURO

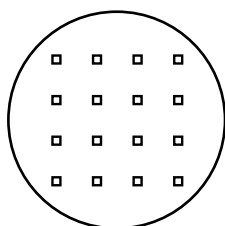

FORI QUADRI
10X10

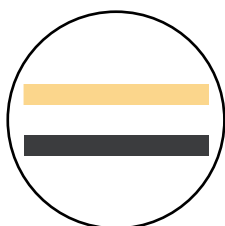

ADATTE PER PIANI
IN LEGNO E
ACCIAIO

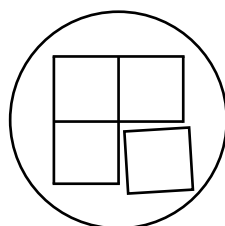

MODULARI

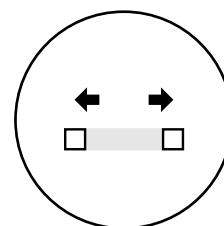

PASSO 38 MM

WORK LOOK



[CONFIGURE](#)

[SHOP](#)

PATENTED*

ART.	L mm	P mm	H mm	KG	RAL	€
MASTERBR1507	1500	750	1985/2310	1000	7035+7016	2341,43

Composto da:

qtà	descrizione
1	Banco smontato con piano in multiplex 40 mm
1	Armadio L=560 mm con 5 cassetti 1x75 3x100 1x200
2	Piano superiore/inferiore L=560 mm
1	Porta totale sinistra H=600 mm con maniglia Dark Grey
1	Piano interno L=558 mm
1	Supporto semipiano intermedio
2	Pannello forato laterale
1	Barra led
1	Coppia staffe di fissaggio pensile su montanti
1	Pensile vasistas senza serratura
1	Lampada doppia
1	Kit 2 pannelli forati/mensole con 1 bordo fermacasse
1	Kit 2 supporti inclinati con binario

qtà	descrizione
1	Kit 2 montanti biasolati
1	Cestino capacità 30 L
1	Mensola grande reversibile
1	Barra aggancio per contenitori Picking Box mis. 1/2
1	Kit 4 contenitori Picking Box Air mis. 1
3	Gancio Unipok per utensili - confezione 30 pezzi
2	Porta bombolette inclinato a 2 posti
1	Kit porta rotolo con carta Ø=130 mm
1	Tasca porta documenti A4
1	Cavo di collegamento wieland schuko/francese
1	Multipresa schuko a 4 scomparti
1	Multipresa schuko a 2 scomparti
1	Supporto multipresa a 4 scomparti
1	Supporto multipresa a 2 scomparti



PORTATA



RAL 7035 + RAL 7016

WORK LOOK

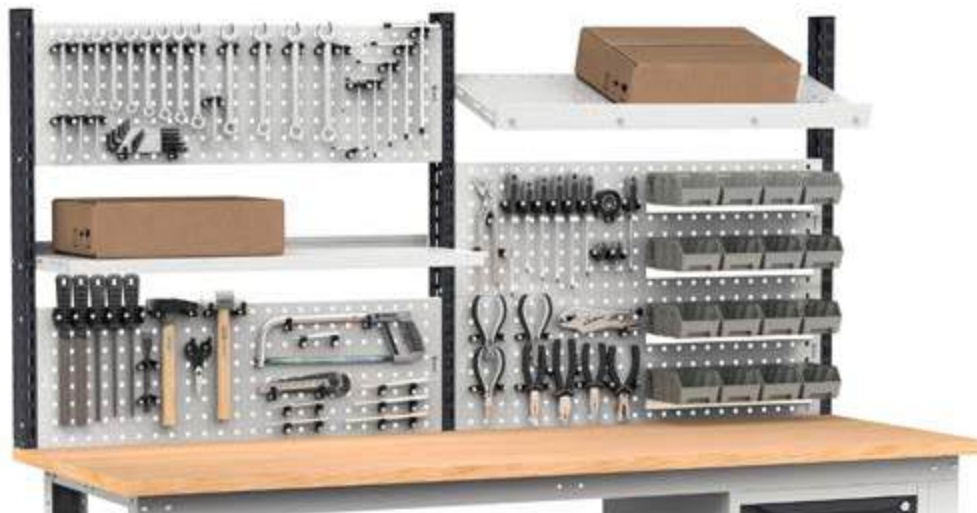

CAMBIA L'ASPETTO DEL TUO BANCO DA LAVORO PER ADATTARLO A DIVERSI UTILIZZI CON WORK LOOK!

In base a come lo installi lo puoi utilizzare come:

pannello forato, mensola orizzontale, mensola inclinata con bordo fermacasse.



ART.	L mm	P mm	H mm	KG montanti	RAL	€
WORKLOOK1001	1015	80	639	50	7035+7016	100,75
WORKLOOK1002	1015	80	639	50	5012	124,31

Composto da:

qtà	descrizione
1	Kit 2 montanti biasolati
1	Kit 2 pannelli forati/mensole con 1 bordo fermacasse

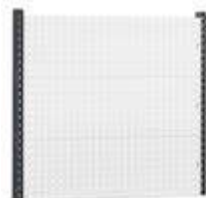

ART.	L mm	P mm	H mm	KG montanti	RAL	€
WORKLOOK1003	1015	80	943	50	7035+7016	141,67
WORKLOOK1004	1015	80	943	50	5012	175,15

Composto da:

qtà	descrizione
1	Kit 2 montanti biasolati
1	Kit 3 pannelli forati/mensole con 2 bordi fermacasse



ART.	L mm	P mm	H mm	KG montanti	RAL	€
WORKLOOK1501	1500	80	639	50	7035+7016	112,84
WORKLOOK1502	1500	80	639	50	5012	148,80

Composto da:

qtà	descrizione
1	Kit 2 montanti biasolati
1	Kit 2 pannelli forati/mensole con 1 bordo fermacasse



ART.	L mm	P mm	H mm	KG montanti	RAL	€
WORKLOOK1503	1500	80	943	50	7035+7016	158,72
WORKLOOK1504	1500	80	943	50	5012	216,38

Composto da:

qtà	descrizione
1	Kit 2 montanti biasolati
1	Kit 3 pannelli forati/mensole con 2 bordi fermacasse

WORK LOOK

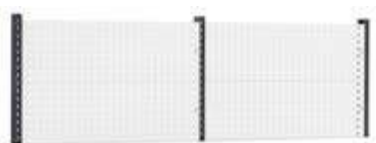

ART.	L mm	P mm	H mm	KG montanti	RAL	€
WORKLOOK2001	2000	80	639	50	7035+7016	181,66
WORKLOOK2002	2000	80	639	50	5012	228,78

Composto da:

qtà	descrizione
1	Kit 3 montanti biasolati
2	Kit 2 pannelli forati/mensole con 1 bordo fermacasse

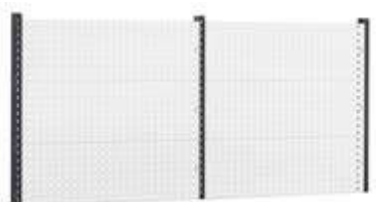

ART.	L mm	P mm	H mm	KG montanti	RAL	€
WORKLOOK2003	2000	80	943	50	7035+7016	256,37
WORKLOOK2004	2000	80	943	50	5012	323,33

Composto da:

qtà	descrizione
1	Kit 3 montanti biasolati
2	Kit 3 pannelli forati/mensole con 2 bordi fermacasse

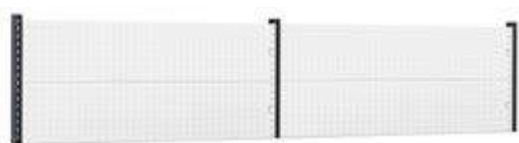

ART.	L mm	P mm	H mm	KG montanti	RAL	€
WORKLOOK3001	2970	80	639	50	7035+7016	205,84
WORKLOOK3002	2970	80	639	50	5012	277,76

Composto da:

qtà	descrizione
1	Kit 3 montanti biasolati
2	Kit 2 pannelli forati/mensole con 1 bordo fermacasse

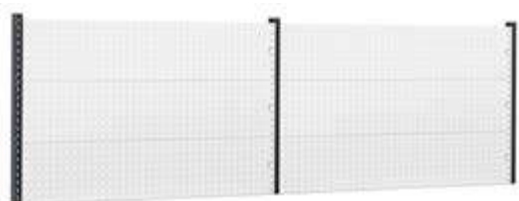

ART.	L mm	P mm	H mm	KG montanti	RAL	€
WORKLOOK3003	2970	80	943	50	7035+7016	290,47
WORKLOOK3004	2970	80	943	50	5012	405,79

Composto da:

qtà	descrizione
1	Kit 3 montanti biasolati
2	Kit 3 pannelli forati/mensole con 2 bordi fermacasse



PORTATA



RAL 7035 + RAL 7016



RAL 5012





WORK LOOK

COMPONENTI

PENSILI



PENSILE VASISTAS SENZA SERRATURA

ART.	L mm	P mm	H mm	KG	RAL	€
 FBL8005X000PD	943	350	456	50	7035+7016	319,30
 FBL8005X00004	943	350	456	50	5012	319,30
 FBL8010X000PD	1428	350	456	50	7035+7016	348,75
 FBL8010X00004	1428	350	456	50	5012	348,75



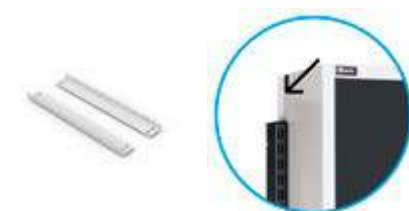

SET DI CHIUSURA PER PENSILE

ART.	€
 FBL8020C00000	12,09





COPPIA STAFFE DI FISSAGGIO PENSILE SU MONTANTI

ART.	L mm	P mm	H mm	RAL	€
 FBL8025000008	33	21	455	7035	24,80
 FBL8025000004	33	21	455	5012	24,80

 Da utilizzare per il fissaggio del pensile ai montanti biasolati



BARRA LED Senza pulsante on/off

ART.	L mm	temperatura colore K	Watt	Hz	Lumen	€
 FBL99350213	573	4000	10	50/60	1000	46,50
 FBL99400213	873	4000	15	50/60	1500	48,98
 FBL99450213	1173	4000	20	50/60	2000	50,22

WORK LOOK

PENSILI CON MONTANTI E PANNELLI PER BANCHI



ART.	L mm	P mm	H mm	KG montanti	RAL	€
WORKLOOK1005	1015	373	1063	50	7035+7016	482,05
WORKLOOK1006	1015	373	1063	50	5012	505,61

Composto da:

qtà	descrizione
1	Kit 2 montanti biasolati
1	Kit 2 pannelli forati/mensole con 1 bordo fermacasse
1	Pensile vasistas senza serratura
1	Coppia staffe di fissaggio pensile su montanti
2	Gancio Unipok per utensili - confezione 30 pezzi



ART.	L mm	P mm	H mm	KG montanti	RAL	€
WORKLOOK1505	1500	373	1063	50	7035+7016	550,25
WORKLOOK1506	1500	373	1063	50	5012	586,21

Composto da:

qtà	descrizione
1	Kit 2 montanti biasolati
1	Kit 2 pannelli forati/mensole con 1 bordo fermacasse
1	Pensile vasistas senza serratura
1	Coppia staffe di fissaggio pensile su montanti
2	Gancio Unipok per utensili - confezione 30 pezzi
2	Barra aggancio per contenitori Picking Box mis. 1/2
2	Kit 4 contenitori Picking Box Air mis. 1



ART.	L mm	P mm	H mm	KG montanti	RAL	€
WORKLOOK2005	2000	373	1063	50	7035+7016	962,55
WORKLOOK2006	2000	373	1063	50	5012	1009,67

Composto da:

qtà	descrizione
1	Kit 3 montanti biasolati
2	Kit 2 pannelli forati/mensole con 1 bordo fermacasse
2	Pensile vasistas senza serratura
2	Coppia staffe di fissaggio pensile su montanti
2	Gancio Unipok per utensili - confezione 30 pezzi
4	Barra aggancio per contenitori Picking Box mis. 1/2
4	Kit 4 contenitori Picking Box Air mis. 1



ART.	L mm	P mm	H mm	KG montanti	RAL	€
WORKLOOK3005	2970	373	1063	50	7035+7016	1060,82
WORKLOOK3006	2970	373	1063	50	5012	1132,74

Composto da:

qtà	descrizione
1	Kit 3 montanti biasolati
2	Kit 2 pannelli forati/mensole con 1 bordo fermacasse
2	Pensile vasistas senza serratura
2	Coppia staffe di fissaggio pensile su montanti
5	Gancio Unipok per utensili - confezione 30 pezzi
2	Barra aggancio per contenitori Picking Box mis. 1/2
2	Kit 4 contenitori Picking Box Air mis. 1



PORTATA



RAL 7035 + RAL 7016



RAL 5012



RAL 7035







WORK LOOK

COMPONENTI



TAPPARELLE



ARMADIO CON TAPPARELLA

ART.	L mm	P mm	H mm	RAL	€
 FBL8050C00008	943	220	912	7035	518,63
 FBL8050C00004	943	220	912	5012	518,63
 FBL8054C00008	1428	220	912	7035	708,35
 FBL8054C00004	1428	220	912	5012	708,35
 FBL8056C00008	1928	220	912	7035	774,69
 FBL8056C00004	1928	220	912	5012	774,69

COPPIA STAFFE DI FISSAGGIO ARMADIO CON TAPPARELLA SU MONTANTI



ART.	L mm	P mm	H mm	RAL	€
 FBL8060000008	33	21	904	7035	28,83
 FBL8060000004	33	21	904	5012	28,83

 Da utilizzare per il fissaggio dell'armadio con tapparella ai montanti biasolati



BARRA LED

Senza pulsante on/off

ART.	L mm	temperatura colore K	Watt	Hz	Lumen	€
 FBL99400213	873	4000	15	50/60	1500	48,98
 FBL99450213	1173	4000	20	50/60	2000	50,22

WORK LOOK

TAPPARELLE CON MONTANTI E PANNELLI PER BANCHI



ART.	L mm	P mm	H mm	KG montanti	RAL	€
WORKLOOK1009	1015	710	1243	50	7035+7016	1027,96
WORKLOOK1010	1015	710	1243	50	5012	1050,90

Composto da:

qtà	descrizione
1	Kit 2 montanti biasolati
1	Kit 2 supporti inclinati con binario
1	Lampada L=988 mm
1	Pannello forato Electric
1	Coppia staffe di fissaggio armadio con tapparella su montanti
1	Armadio con tapparella
4	Gancio Unipok per utensili - confezione 30 pezzi

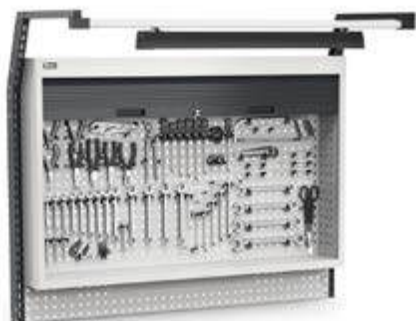

ART.	L mm	P mm	H mm	KG montanti	RAL	€
WORKLOOK1515	1500	710	1243	50	7035+7016	1265,42
WORKLOOK1516	1500	710	1243	50	5012	1288,67

Composto da:

qtà	descrizione
1	Kit 2 montanti biasolati
1	Kit 2 supporti inclinati con binario
1	Lampada L=988 mm
1	Pannello forato Electric
1	Coppia staffe di fissaggio armadio con tapparella su montanti
1	Armadio con tapparella
6	Gancio Unipok per utensili - confezione 30 pezzi



ART.	L mm	P mm	H mm	KG montanti	RAL	€
WORKLOOK2009	2000	710	1243	50	7035+7016	1812,26
WORKLOOK2010	2000	710	1243	50	5012	1841,40

Composto da:

qtà	descrizione
1	Kit 3 montanti biasolati
1	Kit 3 supporti inclinati con 2 binari
1	Lampada L=1473 mm
2	Pannello forato Electric
2	Coppia staffe di fissaggio armadio con tapparella su montanti
2	Armadio con tapparella
8	Gancio Unipok per utensili - confezione 30 pezzi



ART.	L mm	P mm	H mm	KG montanti	RAL	€
WORKLOOK2011	2000	300	1064	50	7035+7016	1077,25
WORKLOOK2012	2000	300	1064	50	5012	1077,25

Composto da:

qtà	descrizione
1	Kit 3 montanti biasolati
2	Pannello forato Electric
1	Coppia staffe di fissaggio armadio con tapparella su montanti
1	Armadio con tapparella
8	Gancio Unipok per utensili - confezione 30 pezzi



PORTATA



RAL 7035 + RAL 7016



RAL 5012







RAL 7035

WORK LOOK

COMPONENTI MONTANTI







KIT 2 MONTANTI BIASOLATI

ART.	L mm	P mm	H mm	KG	adatto per banco L mm	RAL	€
 FBL75301604	30	80	639	50	1000-1500	5012	41,23
 FBL75301639	30	80	639	50	1000-1500	7016	41,23
 FBL75351604	30	80	943	50	1000-1500	5012	50,53
 FBL75351639	30	80	943	50	1000-1500	7016	50,53



KIT 3 MONTANTI BIASOLATI

ART.	L mm	P mm	H mm	KG	adatto per banco L mm	RAL	€
 FBL75302104	30	80	639	50	2000-3000	5012	62,62
 FBL75302139	30	80	639	50	2000-3000	7016	62,62
 FBL75352104	30	80	943	50	2000-3000	5012	74,09
 FBL75352139	30	80	943	50	2000-3000	7016	74,09

WORK LOOK

COMPONENTI

SUPPORTI INCLINATI CON BINARIO BASE



KIT 2 SUPPORTI INCLINATI CON BINARIO

ART.	L mm	P mm	H mm	RAL	€
FBL98102039	1015	686	307	7016	84,32
FBL98102004	1015	686	307	5012	107,26

Adatti solo per montanti H 943 mm



KIT 2 SUPPORTI INCLINATI CON BINARIO

ART.	L mm	P mm	H mm	RAL	€
FBL98152039	1500	686	307	7016	87,73
FBL98152004	1500	686	307	5012	110,98

Adatti solo per montanti H 943 mm



KIT 3 SUPPORTI INCLINATI CON 2 BINARI

ART.	L mm	P mm	H mm	RAL	€
FBL98202039	2000	686	307	7016	132,37
FBL98202004	2000	686	307	5012	161,51

Adatti solo per montanti H 943 mm



KIT 3 SUPPORTI INCLINATI CON 2 BINARI

ART.	L mm	P mm	H mm	RAL	€
FBL98302039	2970	686	307	7016	140,43
FBL98302004	2970	686	307	5012	168,95

Adatti solo per montanti H 943 mm



BINARIO SUPPLEMENTARE CON ATTACCHI

ART.	L mm	P mm	H mm	materiale	€
FBL98101000	1015	60	67	Alluminio	38,44
FBL98151000	1500	60	67	Alluminio	43,40

SET ARIA COMPRESA CON BILANCIATORE E FILTRO

ART.	€
FBL97200300	484,84

Completo di:
 1 cavo flessibile Ø 10 mm
 1 connettore a T da 1/4" con tappo (B)
 2 attacchi di scorrimento
 1 moschettone
 1 bilanciatore con cavo in acciaio lunghezza 1600 mm portata 1/2 kg
 1 attacco universale 1/4" per utensili (A)
 1 tubo a spirale diametro interno 5,5 mm
 1 tubo diametro interno 5,5 mm per lo spurgo del filtro
 1 gruppo filtro regolatore con manometro - il quale può essere utilizzato con una pressione massima di 10 bar, la sua capacità è di circa 9 litri al secondo (sul punto A) e di 11 litri al secondo (sul punto B) con una pressione di utilizzo pari a 6,3 bar (la capacità può variare a seconda delle caratteristiche tecniche della rete pneumatica a cui l'impianto Fami viene allacciato)
 raccordi da 1/4"

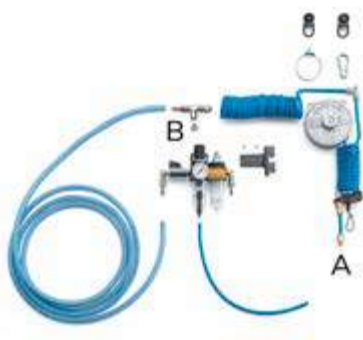

PORTATA



RAL 5012



RAL 7016



ALLUMINIO

WORK LOOK

COMPONENTI

PANNELLI FORATI/MENSOLA 953 mm

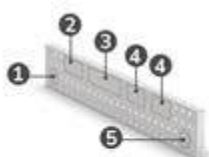
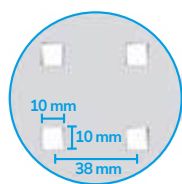

PANNELLO FORATO/MENSOLA

ART.	L mm	P mm	H mm	dim. foro mm	passo mm	RAL	€
FBL76160008	953	40	304	10x10	38	7035	27,28
FBL76160004	953	40	304	10x10	38	5012	37,51

KIT 2 PANNELLI FORATI/MENSOLE CON 1 BORDO FERMACASSE

ART.	L mm	P mm	H mm	dim. foro mm	passo mm	RAL	€
FBL76160208	953	40	304	10x10	38	7035	59,52
FBL76160204	953	40	304	10x10	38	5012	83,08

KIT 3 PANNELLI FORATI/MENSOLE CON 2 BORDI FERMACASSE

ART.	L mm	P mm	H mm	dim. foro mm	passo mm	RAL	€
FBL76160308	953	40	304	10x10	38	7035	91,14
FBL76160304	953	40	304	10x10	38	5012	124,62

PANNELLO FORATO/MENSOLA CON 1 BORDO FERMACASSE

ART.	L mm	P mm	H mm	dim. foro mm	passo mm	RAL	€
FBL76170108	953	40	456	10x10	38	7035	44,33
FBL76170104	953	40	456	10x10	38	5012	56,11

PANNELLO FORATO ELECTRIC

ART.	L mm	P mm	H mm	dim. foro mm	passo mm	RAL	€
FBL76180008	953	40	152	10x10	38	7035	44,02
FBL76180004	953	40	152	10x10	38	5012	44,02

1. USB Dati
2. Magnetotermico differenziale
3. Multipresa 4 scomparti
4. Multipresa 2 scomparti
5. USB Ricarica

WORK LOOK

COMPONENTI

PANNELLI FORATI/MENSOLA 1438 mm

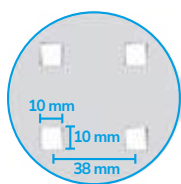

1. USB Dati
2. Magnetotermico differenziale
3. Multipresa 4 scomparti
4. Multipresa 2 scomparti
5. USB Ricarica

PANNELLO FORATO/MENSOLA

ART.	L mm	P mm	H mm	dim. foro mm	passo mm	RAL	€
FBL76310008	1438	40	304	10x10	38	7035	32,24
FBL76310004	1438	40	304	10x10	38	5012	49,91

KIT 2 PANNELLI FORATI/MENSOLE CON 1 BORDO FERMACASSE

ART.	L mm	P mm	H mm	dim. foro mm	passo mm	RAL	€
FBL76310208	1438	40	304	10x10	38	7035	71,61
FBL76310204	1438	40	304	10x10	38	5012	107,57

KIT 3 PANNELLI FORATI/MENSOLE CON 2 BORDI FERMACASSE

ART.	L mm	P mm	H mm	dim. foro mm	passo mm	RAL	€
FBL76310308	1438	40	304	10x10	38	7035	108,19
FBL76310304	1438	40	304	10x10	38	5012	165,85

PANNELLO FORATO/MENSOLA CON 1 BORDO FERMACASSE

ART.	L mm	P mm	H mm	dim. foro mm	passo mm	RAL	€
FBL76320108	1438	40	456	10x10	38	7035	52,70
FBL76320104	1438	40	456	10x10	38	5012	74,71

PANNELLO FORATO ELECTRIC

ART.	L mm	P mm	H mm	dim. foro mm	passo mm	RAL	€
FBL76330008	1438	40	152	10x10	38	7035	60,45
FBL76330004	1438	40	152	10x10	38	5012	60,45

RAL 5012

RAL 7035

WORK LOOK

COMPONENTI

PANNELLI FORATI/MENSOLA 1938 mm

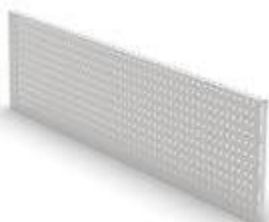
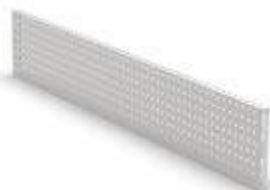
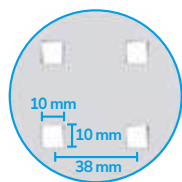

PANNELLO FORATO/MENSOLA

ART.	L mm	P mm	H mm	dim. foro mm	passo mm	RAL	€
FBL76360008	1938	40	304	10x10	38	7035	41,85
FBL76360004	1938	40	304	10x10	38	5012	55,80

PANNELLO FORATO/MENSOLA

ART.	L mm	P mm	H mm	dim. foro mm	passo mm	RAL	€
FBL76370008	1938	40	456	10x10	38	7035	48,98
FBL76370004	1938	40	456	10x10	38	5012	66,03

COPPIA SUPPORTI PER PANNELLO FORATO/MENSOLA

ART.	L mm	P mm	H mm	RAL	€
FVT01010039	12	237	99	7016	13,64



WORK LOOK

COMPONENTI



COPPIA SQUADRE PER FISSAGGIO PANNELLI SU PIANO

ART.	L mm	P mm	H mm	RAL	€
FBL76000239	110	32	110	7016	29,76

La coppia squadre è utilizzata per il fissaggio del pannello forato direttamente sul piano di lavoro

ESEMPI DI UTILIZZO DELLA COPPIA SQUADRE



Installazione del pannello a filo piano
Pannelli forati vedi pag. 278



Installazione arretrata del pannello
Pannelli forati vedi pag. 278



Installazione inclinata del pannello Electric
Accessori Iron Team Electric vedi pag. 328



Installazione del pannello con montanti
Montanti vedi pag. 276



RAL 5012



RAL 7016



RAL 7035

WORK LOOK

PANNELLI FORATI A MURO



KIT STAFFE PER FISSAGGIO PANNELLI A PARETE

ART.	finitura	€
FVT02550000	Zincato	17,05

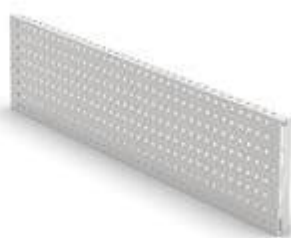
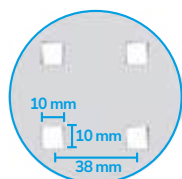

PANNELLO FORATO/MENSOLA

ART.	L mm	P mm	H mm	RAL	€
FBL76160008	953	40	304	7035	27,28
FBL76160004	953	40	304	5012	37,51
FBL76310008	1438	40	304	7035	32,24
FBL76310004	1438	40	304	5012	49,91

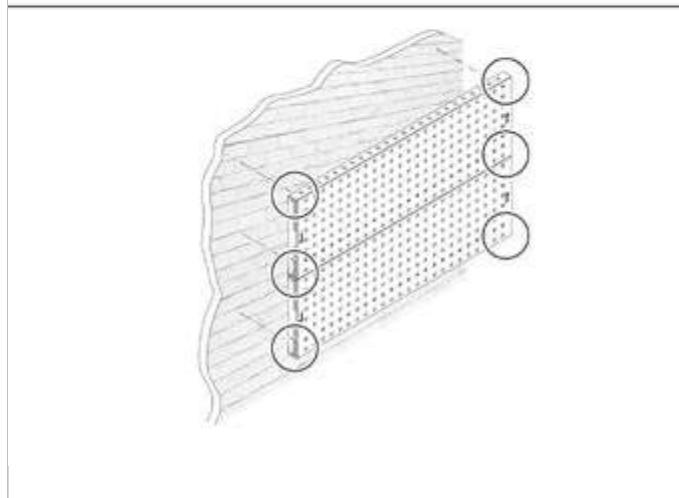
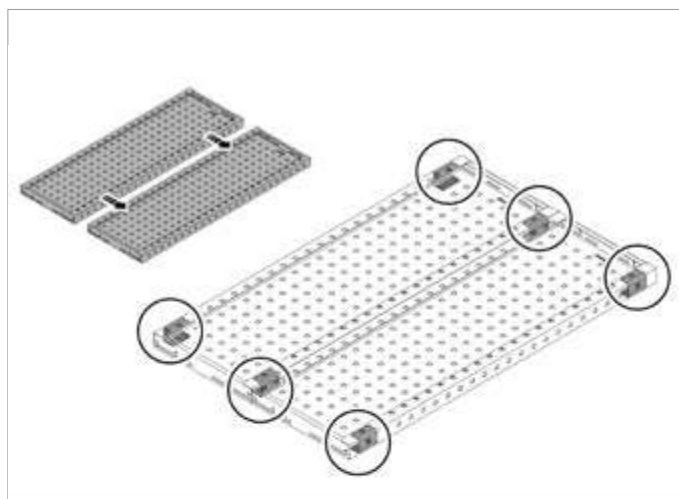

PARETE PORTA ATTREZZI

ART.	L mm	P mm	H mm	RAL	€
WORKLOOK1510	1438	151	608	7035	145,39
WORKLOOK1509	1438	151	608	5012	180,73

Composto da:

qtà	descrizione
2	Pannello forato/mensola
2	Kit staffe per fissaggio pannelli a parete
1	Porta bombolette inclinato a 2 posti
1	Gancio Unipok per utensili - confezione 30 pezzi
10	Gancio con puntale P=100 mm

WORKLOOK

PANNELLI FORATI A MURO

Pannelli forati vedi pag. 278/279
 Fissaggio a muro dei pannelli forati vedi pag. 282
 Ganci Unipok vedi pag. 314
 Ganci The Block vedi pag. 319
 Accessori Iron Team vedi pag. 320



PARETE PORTA ATTREZZI

ART.	Lmm	Pmm	Hmm	RAL	€
WORKLOOK1512	1438	218	608	7035	178,56
WORKLOOK1511	1438	218	608	5012	213,90

Composto da:

qtà	descrizione
2	Pannello forato/mensola
2	Kit staffe per fissaggio pannelli a parete
1	Kit porta rotolo con carta Ø=130 mm
1	Gancio Unipok per utensili - confezione 30 pezzi
10	Gancio con puntale P=100 mm
1	Barra aggancio per contenitori Picking Box mis. 1/2
1	Kit 4 contenitori Picking Box Air mis. 1



PARETE PORTA ATTREZZI

ART.	Lmm	Pmm	Hmm	RAL	€
WORKLOOK1514	1438	275	608	7035	166,16
WORKLOOK1513	1438	275	608	5012	201,50

Composto da:

qtà	descrizione
2	Pannello forato/mensola
2	Kit staffe per fissaggio pannelli a parete
1	Gancio Unipok per utensili - confezione 30 pezzi
10	Gancio con puntale P=100 mm
10	Gancio con puntale P=150 mm
1	Barra aggancio per contenitori Picking Box mis. 1/2
1	Kit 3 contenitori Picking Box Air mis. 2

RAL 5012 RAL 7035 ZINCATO

COMPONENTS

MORSE

SEDIE

TAVOLO PIEGHEVOLE



TAVOLO PIEGHEVOLE



TAVOLO CON GAMBE PIEGHEVOLI

ART.	dim. ingombro aperto			dim. ingombro chiuso			materiale piano	kg	RAL	€
	L mm	P mm	H mm	L mm	P mm	H mm				
 F22WWTABLE00039	1184	590	896	1100	590	60	Multiplex	400	7016	293,57



KIT 3 GANCI PER FISSAGGIO VERTICALE TAVOLO

ART.	L mm	P mm	H mm	kg	RAL	€
 F22WWTABLEFIS39	152	81	92	25	7016	32,55

COMPONENTS

MORSE WORK TECH

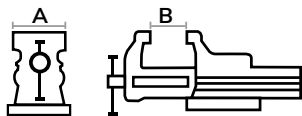

Ganasce stringitubo di serie



KIT VITI PER FISSAGGIO MORSA AL PIANO



ART.	€
F22VT000050Z000	2,48



MORSA PROFESSIONALE MODELLO WORK TECH



ART.	L mm	P mm	H mm	A mm	B mm	RAL	€
F22FABL11500039	100	300	138	100	125	7016	130,51

⚠ Con ganasce stringitubo per tubi con Ø esterno 16-40 mm



MORSA PROFESSIONALE CON BASE GIREVOLE MODELLO WORK TECH



ART.	L mm	P mm	H mm	A mm	B mm	RAL	€
IRONTEAM003	100	300	138	100	125	7016	177,01

⚠ Con ganasce stringitubo per tubi con Ø esterno 16-40 mm



MORSA PROFESSIONALE MODELLO WORK TECH



ART.	L mm	P mm	H mm	A mm	B mm	RAL	€
F22FABL11550039	120	375	170	120	150	7016	174,84

⚠ Con ganasce stringitubo per tubi con Ø esterno 16-58 mm



MORSA PROFESSIONALE CON BASE GIREVOLE MODELLO WORK TECH



ART.	L mm	P mm	H mm	A mm	B mm	RAL	€
IRONTEAM004	120	375	170	120	150	7016	233,74

⚠ Con ganasce stringitubo per tubi con Ø esterno 16-58 mm



PORTATA



RAL7016

COMPONENTS

MORSE WORK GO

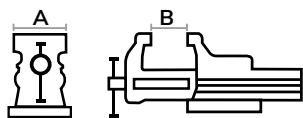

Ganasce stringitubo di serie



MORSA PROFESSIONALE MODELLO WORK GO

ART.	L mm	P mm	H mm	A mm	B mm	RAL	€
 F22FABL11600039	120	333	122	100	125	7016	140,74

 Con ganasce stringitubo per tubi con Ø esterno 17-42 mm



MORSA PROFESSIONALE CON BASE GIREVOLE MODELLO WORK GO

ART.	L mm	P mm	H mm	A mm	B mm	RAL	€
 IRONTEAM005	120	333	122	100	125	7016	181,04

 Con ganasce stringitubo per tubi con Ø esterno 17-42 mm



MORSA PROFESSIONALE MODELLO WORK GO

ART.	L mm	P mm	H mm	A mm	B mm	RAL	€
 F22FABL11650039	150	389	150	120	150	7016	164,30

 Con ganasce stringitubo per tubi con Ø esterno 17-48 mm



MORSA PROFESSIONALE CON BASE GIREVOLE MODELLO WORK GO

ART.	L mm	P mm	H mm	A mm	B mm	RAL	€
 IRONTEAM006	150	389	150	120	150	7016	208,94

 Con ganasce stringitubo per tubi con Ø esterno 17-48 mm

COMPONENTS

MORSE WORK STRONG

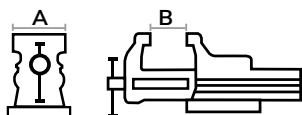

Ganasce stringitubo di serie



MORSA PROFESSIONALE MODELLO WORK STRONG

ART.	L mm	P mm	H mm	A mm	B mm	RAL	€
F22FABL11700039	160	425	167	135	170	7016	205,53

⚠ Con ganasce stringitubo per tubi con Ø esterno 17-48 mm



MORSA PROFESSIONALE CON BASE GIREVOLE MODELLO WORK STRONG

ART.	L mm	P mm	H mm	A mm	B mm	RAL	€
IRONTEAM007	160	425	167	135	170	7016	255,44

⚠ Con ganasce stringitubo per tubi con Ø esterno 17-48 mm



MORSA PROFESSIONALE MODELLO WORK STRONG

ART.	L mm	P mm	H mm	A mm	B mm	RAL	€
F22FABL11750039	180	480	187	150	190	7016	221,65

⚠ Con ganasce stringitubo per tubi con Ø esterno 17-76 mm



MORSA PROFESSIONALE CON BASE GIREVOLE MODELLO WORK STRONG

ART.	L mm	P mm	H mm	A mm	B mm	RAL	€
IRONTEAM008	180	480	187	150	190	7016	276,21

⚠ Con ganasce stringitubo per tubi con Ø esterno 17-76 mm

COMPONENTS

SEDIE DA LAVORO



SGABELLO REGOLABILE CON PIEDINI

ART.	L mm	P mm	materiale	H seduta mm	n. piedini	€
 FAX1100T0000000	600	600	Faggio	460/640	5	137,64



SGABELLO REGOLABILE CON PIEDINI

ART.	L mm	P mm	materiale	H seduta mm	n. piedini	colore	€
 FAX115000000P07	600	600	Poliuretano	530/790	5	Nero	235,60



SEDIA REGOLABILE CON POMPA A GAS CON RUOTE

ART.	L mm	P mm	materiale	H seduta mm	n. ruote	€
 FAX1100RG000000	630	630	Faggio	510/690	5	174,84



SEDIA REGOLABILE CON POMPA A GAS CON PIEDINI

ART.	L mm	P mm	materiale	H seduta mm	n. piedini	colore	€
 FAX120000000007	630	630	Poliuretano	580/840	5	Nero	263,19

COMPONENTS

SEDIE DA LAVORO



SEDIA REGOLABILE CON POMPA A GAS CON RUOTE



ART.	L mm	P mm	materiale	H seduta mm	n. ruote	colore	€
FAX125000000007	630	630	Poliuretano	540/730	5	Nero	217,31



SEDIA REGOLABILE CON POMPA A GAS CON RUOTE



ART.	L mm	P mm	materiale	H seduta mm	n. ruote	colore	€
FAXCATY50000007	630	630	Poliuretano	435/565	5	Nero	374,48



SEDIA REGOLABILE CON POMPA A GAS CON RUOTE



ART.	L mm	P mm	materiale	H seduta mm	n. ruote	colore	€
FAXCATY80000007	630	630	Poliuretano	525/710	5	Nero	446,40



SEDIA ANTISTATICA REGOLABILE CON POMPA A GAS CON RUOTE



ART.	L mm	P mm	materiale	H seduta mm	n. ruote	colore	€
FAXGREF21200001	640	640	Tessuto antistatico	470/600	5	Grigio scuro	425,63

SUPPORTI PER MONITOR - MES

ERGO WORK



Le postazioni MES sono soluzioni composte da diverse tipologie di supporti per monitor e altri hardware per la creazione di postazioni informatiche in qualsiasi area dell'azienda. Possono essere installate direttamente a **pavimento**, tramite appositi **montanti**, su **piani di lavoro** con il profilo con **morsetto** o su **montanti** biasolati di pareti porta attrezzi e carrelli nella versione semplice di **braccio estensibile**. Indipendentemente dalla tipologia di fissaggio scelta, gli Ergo Work per postazioni MES sono dotati di pratiche **piastre VESA** per l'alloggiamento di monitor e possono essere arricchiti con **vassoi inclinati** porta tastiera e **mensole** porta oggetti.

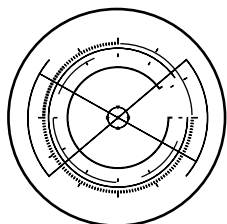

CONFIGURABILE

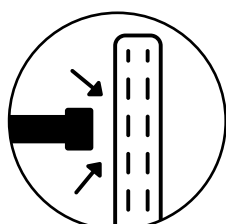

FISSAGGIO SU MONTANTE

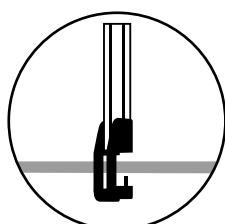

FISSAGGIO SU PIANO

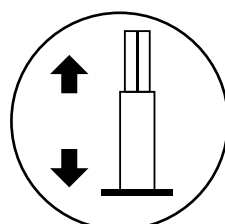

REGOLABILI IN ALTEZZA

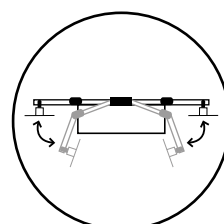

PIEGHEVOLI



BRACCIO DOPPIO MONITOR CON MORSETTO

ART.	L mm	P mm	H mm	RAL	€
ERGOWORK020	1474	167	636	7016	242,11

Composto da:

qtà	descrizione
1	Profilo con morsetto per piano
1	Braccio doppio monitor



MONTANTE CON PORTA TASTIERA E PIASTRA PORTA MONITOR

ART.	L mm	P mm	H mm	RAL	€
ERGOWORK016	649	328	1859	7016	189,10

Composto da:

qtà	descrizione
1	Montante verticale porta monitor
1	Vassoio inclinato porta tastiera e mouse
1	Piastra porta monitor con standard VESA



Attrezzatura informatica esclusa



MONTANTE CON PORTA TASTIERA E BRACCIO DOPPIO MONITOR

ART.	L mm	P mm	H mm	RAL	€
ERGOWORK017	1474	328	1859	7016	376,03

Composto da:

qtà	descrizione
1	Montante verticale porta monitor
1	Vassoio inclinato porta tastiera e mouse
1	Braccio doppio monitor



Attrezzatura informatica esclusa

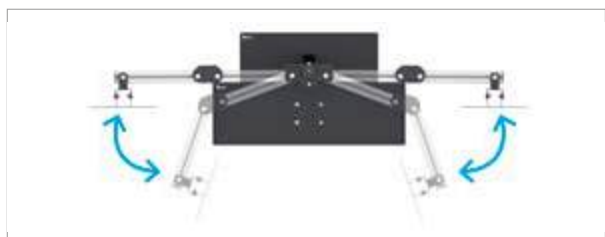

MONTANTE CON PORTA TASTIERA E BRACCIO DOPPIO MONITOR

ART.	L mm	P mm	H mm	RAL	€
ERGOWORK021	1474	378	1859	7016	413,23

Composto da:

qtà	descrizione
1	Montante verticale porta monitor
1	Vassoio inclinato porta tastiera e mouse
1	Braccio doppio monitor
1	Mensola portaoggetti per montante verticale



Attrezzatura informatica esclusa

ERGO WORK

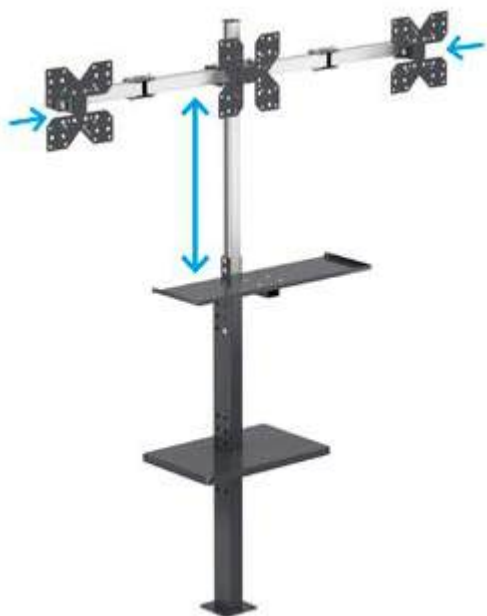

MONTANTE CON PORTA TASTIERA E BRACCIO TRIPLO MONITOR



ART.	L mm	P mm	H mm	RAL	€
ERGOWORK018	1474	378	1859	7016	427,18

Composto da:

qtà	descrizione
1	Montante verticale porta monitor
1	Vassoio inclinato porta tastiera e mouse
1	Braccio doppio monitor
1	Mensola portaoggetti per montante verticale
1	Piastra porta monitor con standard VESA



Attrezzatura informatica esclusa



Il montante verticale si compone di due diversi elementi: un **profilo in alluminio** (1) e un **montante** cavo predisposto per il **fissaggio a pavimento** (5) con viti e tasselli. Il profilo in alluminio presenta apposite fessure per l'installazione di bracci estensibili, piastre VESA e **vassoi porta tastiera** (2). Il montante, invece, è dotato di fori nella parte superiore per regolare l'altezza del profilo in alluminio e di un'ulteriore serie di fori quadro nella parte centrale per l'installazione di **mensole porta oggetti** (3) a diverse altezze. Alla base, il pratico **foro passacavo** (4) facilita il passaggio ordinato di cavi elettrici di monitor e hardware.

1. Profilo in alluminio
2. Vassoio porta tastiera
3. Mensola porta oggetti
4. Foro passacavo
5. Fissaggio a pavimento



MONTANTE VERTICALE PORTA MONITOR

ART.	L mm	P mm	H mm	KG	RAL	€
 FBL74230039	125	125	1200/1850	100	7016	116,25



PROFILO CON MORSETTO PER PIANO

ART.	L mm	P mm	H mm	materiale	KG	RAL	€
 FBL74240039	70	75	602	Alluminio	80	7016	41,23



ERGO WORK

COMPONENTI



BRACCIO DOPPIO MONITOR

ART.	L mm	P mm	H mm	materiale		RAL	€
 FBL74220039	1474	143	225	Alluminio	10	7016	200,88



PIASTRA PORTA MONITOR CON STANDARD VESA

Orientabile su un asse

ART.	L mm	P mm	H mm	RAL	€
 FBL74120039	225	50	225	7016	13,95





VASSOIO INCLINATO PORTA TASTIERA E MOUSE

ART.	L mm	P mm	H mm	RAL	€
 FBL74210039	649	268	88	7016	58,90



MENSOLA PORTAOGGETTI PER MONTANTE VERTICALE

ART.	L mm	P mm	H mm		RAL	€
 FBL74260039	466	304	35	30	7016	37,20



PORTATA



RAL 7016



Contenitori esclusi

CARRELLO CON BRACCIO ESTENSIBILE

ART.	L mm	P mm	H mm	 set ruote	RAL	€
 BINCART1080	1916	739	1357	300	7016	717,65

Composto da:

qtà	descrizione	qtà	descrizione
1	Carrello smontato senza ruote	1	Braccio estensibile per montante
1	Kit 4 ruote in gomma antitraccia sintetica Ø 125 mm	1	Snodo per piastra
6	Coppia supporti per pannello forato/mensola	1	Profilo in alluminio forato
6	Pannello forato/mensola	1	Piastra porta monitor con standard VESA
6	Bordo fermacasse	1	Vassoio inclinato porta tastiera e mouse



BRACCIO ESTENSIBILE CON PORTA TASTIERA

ART.	L mm	P mm	H mm	RAL	€
 ERGOWORK019	649	855	471	7016	210,49

Composto da:

qtà	descrizione
1	Braccio estensibile per montante
1	Snodo per piastra
1	Profilo in alluminio forato
1	Piastra porta monitor con standard VESA
1	Vassoio inclinato porta tastiera e mouse



Attrezzatura informatica esclusa

ERGO WORK

COMPONENTI

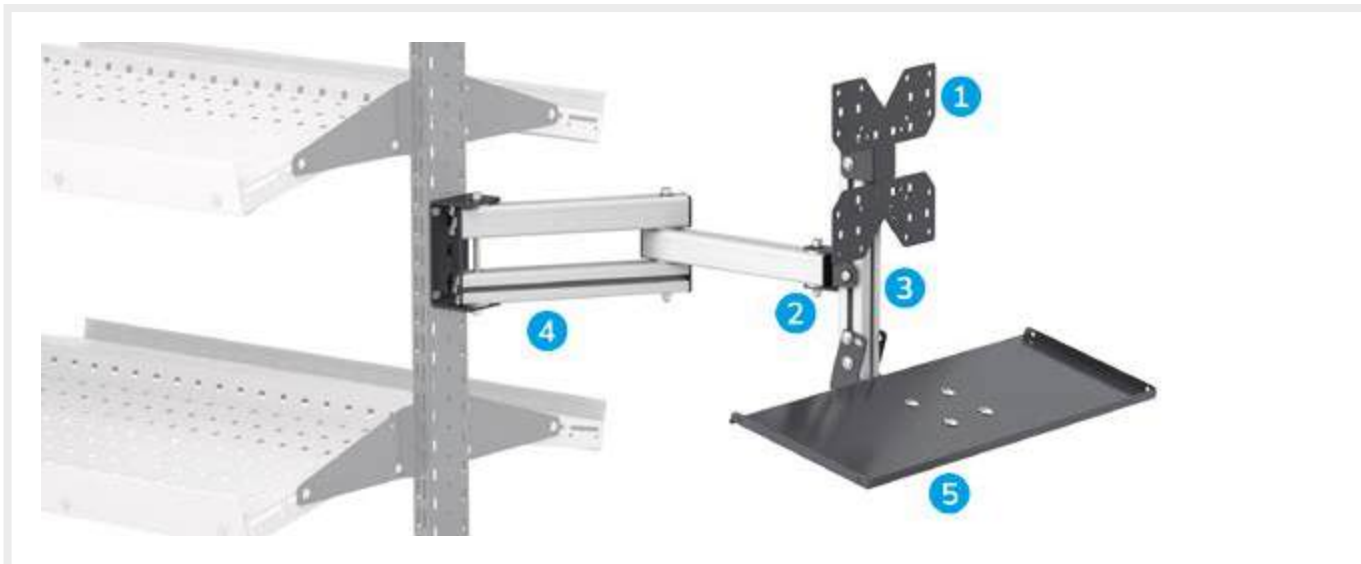

1 PIASTRA PORTA MONITOR CON STANDARD VESA

Orientabile su un asse

ART.	L mm	P mm	H mm	RAL	€
 FBL74120039	225	50	225	7016	13,95



2 SNODO PER PIASTRA

Da utilizzare con piastra porta monitor per orientarla su due assi

ART.	L mm	P mm	H mm	RAL	€
 FBL74110039	91	67	51	7016	15,19





3 PROFILO IN ALLUMINIO FORATO

ART.	L mm	P mm	H mm	materiale	€
 FBL742500A1	40	40	308	Alluminio	17,98



4 BRACCIO ESTENSIBILE PER MONTANTE

ART.	L mm	P mm	H mm	angolo rotazione °	materiale	 KG	RAL	€
 FBL74100039	580/330	72/97	158	240	Alluminio	20	7016	104,47



5 VASSOIO INCLINATO PORTA TASTIERA E MOUSE

ART.	L mm	P mm	H mm	RAL	€
 FBL74210039	649	268	88	7016	58,90



PORTATA



RAL 7016



ALLUMINIO

BRACCI ESTENSIBILI

ERGO WORK



I **bracci estensibili** Ergo Work aumentano lo spazio di stoccaggio a disposizione dell'operatore su banchi da lavoro e carrelli. È possibile scegliere tra due diverse tipologie di bracci: i primi possono essere installati direttamente sul **montante** della parete attrezzata, mentre i secondi sono fissati sul **piano di lavoro**. Grazie all'ampio angolo di rotazione, la posizione del braccio può essere facilmente regolata così da avere tutto a portata di mano e rendere la postazione sempre più ergonomica. Ergo Work può ospitare vassoi, piastre porta monitor, soluzioni con contenitori e pannelli forati.

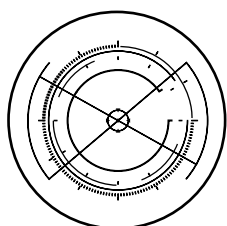

CONFIGURABILE

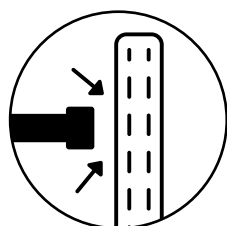

FISSAGGIO SU
MONTANTE

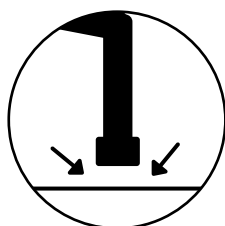

FISSAGGIO SU
PIANO



PORTATA 20 KG

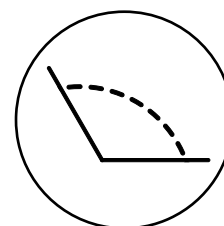

ANGOLO
ROTAZIONE 240-
260°



CONFIGURE 

SHOP 

PATENTED*

ART.	L mm	P mm	H mm	 KG	RAL	€
DYNAMIC1506	1497/3139	780	1983/2383	400	7035+7016	4687,20

Composto da:

qtà	descrizione	qtà	descrizione
1	Banco smontato regolabile elettricamente	1	Multipresa schuko a 4 scomparti
1	Armadio L=500 mm con 1 cassetto H=150 mm	2	Multipresa schuko a 2 scomparti
1	Coperchio per armadio L=500 mm	1	Presse usb ricarica
1	Coppia supporti per armadio	1	Presse usb dati
1	Telaio portaprese aggiuntivo completo di tamponi e angolari	1	Cavo di collegamento wieland schuko/francese
1	Kit 2 montanti biasolati	1	Dispenser per guanti
1	Kit 2 supporti inclinati con binario	1	Porta flacone igienizzante reversibile
1	Lampada doppia	36	Contenitore in polipropilene Picking Box Air mis. 2
1	Binario supplementare con attacchi	4	Braccio estensibile per montante
1	Set aria compressa con bilanciatore e filtro	1	Snodo per piastra
2	Pannello forato/mensola con 1 bordo fermacasse	3	Piastra porta monitor con standard VESA
3	Lampada singola	1	Pannello per Picking Box
1	Pannello forato/mensola	3	Barra aggancio per contenitori Picking Box mis. 1/2
1	Pannello forato Electric	3	Kit 4 contenitori Picking Box Air mis. 1
2	Gancio Unipok per utensili - confezione 30 pezzi	1	Pannello per Visual Box
1	Magnetotermico differenziale	2	Cassetteria Visual Box con 6 cassette
1	Vassoio inclinato	1	Cassetteria Visual Box con 5 cassette



PORTATA



RAL 7035 + RAL 7016



BRACCIO ESTENSIBILE CON PICKING BOX

ART.	L mm	P mm	H mm	RAL	€
 ERGOWORK002	760/515	470/283	356	7016	200,57

Composto da:

qtà	descrizione
1	Braccio estensibile per montante
1	Piastra porta monitor con standard VESA
1	Pannello per Picking Box
3	Barra aggancio per contenitori Picking Box mis. 1/2
3	Kit 4 contenitori Picking Box Air mis. 1



BRACCIO ESTENSIBILE CON PICKING BOX

ART.	L mm	P mm	H mm	RAL	€
 ERGOWORK003	826/515	470/348	356	7016	190,34

Composto da:

qtà	descrizione
1	Braccio estensibile per montante
1	Piastra porta monitor con standard VESA
1	Pannello per Picking Box
2	Barra aggancio per contenitori Picking Box mis. 1/2
1	Kit 3 contenitori Picking Box Air mis. 2
1	Kit 4 contenitori Picking Box Air mis. 1



BRACCIO ESTENSIBILE CON VISUAL BOX

ART.	L mm	P mm	H mm	RAL	€
 ERGOWORK004	738/612	601/294	390	7016	228,16

Composto da:

qtà	descrizione
1	Braccio estensibile per montante
1	Piastra porta monitor con standard VESA
1	Pannello per Visual Box
1	Cassettiera Visual Box con 5 cassette
2	Cassettiera Visual Box con 6 cassette



PIASTRA PORTA MONITOR CON SQUADRETTE

ART.	L mm	P mm	H mm	RAL	€
 ERGOWORK014	225/129	119/225	225	7016	43,40

Composto da:

qtà	descrizione
1	Coppia squadrette a L
1	Snodo per piastra
1	Piastra porta monitor con standard VESA



PANNELLO FORATO CON CERNIERE

ART.	L mm	P mm	H mm	RAL	€
 ERGOWORK007	647	60	496	7035	70,99

Composto da:

qtà	descrizione
1	Pannello forato/mensola con 1 bordo fermacasse
1	Kit cerniere per pannello forato



BRACCIO ESTENSIBILE CON VASSOIO INCLINATO

ART.	L mm	P mm	H mm	RAL	€
 ERGOWORK005	674/522	425/470	194	7016	151,28

Composto da:

qtà	descrizione
1	Braccio estensibile per montante
1	Vassoio inclinato



BRACCIO ESTENSIBILE CON PIASTRA PORTA MONITOR

ART.	L mm	P mm	H mm	RAL	€
 ERGOWORK001	652/330	225/225	225	7016	133,61

Composto da:

qtà	descrizione
1	Braccio estensibile per montante
1	Snodo per piastra
1	Piastra porta monitor con standard VESA

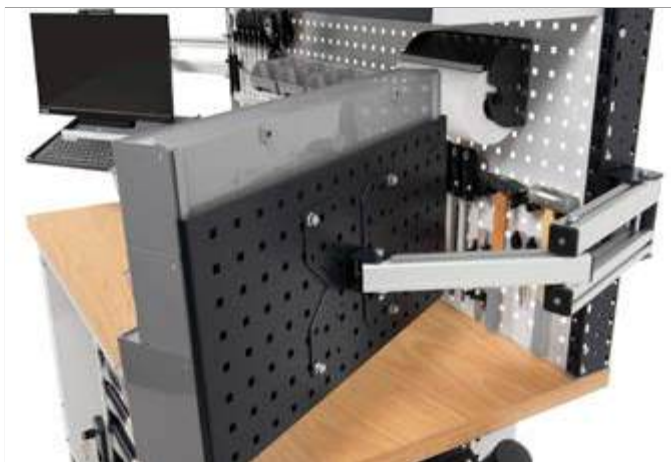

RAL 7016

RAL 7035



[CONFIGURE](#)

[SHOP](#)

ART.	L mm	P mm	H mm	senza ruote	set ruote	RAL	€
CLEVER1031	1036	672	1428	300	300	7035	669,60

Composto da:

qtà	descrizione	qtà	descrizione
1	Carrello smontato senza ruote	1	Profilo con base per piano
1	Piano in legno con supporti	1	Coppia squadrette a L
2	Pannello laterale forato	1	Snodo per piastra
1	Pannello posteriore forato	1	Piastra porta monitor con standard VESA
1	Coppia porte a battente	1	Kit 4 ruote in gomma antitraccia sintetica Ø 125 mm



BRACCIO ESTENSIBILE CON VASSOIO INCLINATO



ART.	L mm	P mm	H mm	RAL	€
ERGOWORK013	745/521	425/480	552	7016	195,92

Composto da:

qtà	descrizione
1	Profilo con base per piano
1	Braccio estensibile per profilo
1	Vassoio inclinato

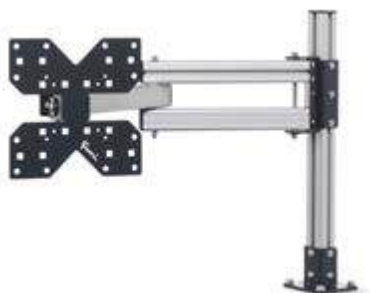

BRACCIO ESTENSIBILE CON PIASTRA PORTA MONITOR



ART.	L mm	P mm	H mm	RAL	€
ERGOWORK009	724/402	225/192	550	7016	178,25

Composto da:

qtà	descrizione
1	Profilo con base per piano
1	Braccio estensibile per profilo
1	Snodo per piastra
1	Piastra porta monitor con standard VESA



PROFILO CON PIASTRA PORTA MONITOR



ART.	L mm	P mm	H mm	RAL	€
ERGOWORK008	225/199	151/225	560	7016	84,94

Composto da:

qtà	descrizione
1	Profilo con base per piano
1	Coppia squadrette a L
1	Snodo per piastra
1	Piastra porta monitor con standard VESA



PORTATA



RAL 7016



RAL 7035



BRACCIO ESTENSIBILE CON PICKING BOX

ART.	L mm	P mm	H mm	RAL	€
 ERGOWORK010	832/515	470/300	628	7016	245,21

Composto da:

qtà	descrizione
1	Profilo con base per piano
1	Braccio estensibile per profilo
1	Piastra porta monitor con standard VESA
1	Pannello per Picking Box
3	Barra aggancio per contenitori Picking Box mis. 1/2
3	Kit 4 contenitori Picking Box Air mis. 1



BRACCIO ESTENSIBILE CON PICKING BOX

ART.	L mm	P mm	H mm	RAL	€
 ERGOWORK011	898/515	470/365	628	7016	234,98

Composto da:

qtà	descrizione
1	Profilo con base per piano
1	Braccio estensibile per profilo
1	Piastra porta monitor con standard VESA
1	Pannello per Picking Box
2	Barra aggancio per contenitori Picking Box mis. 1/2
1	Kit 3 contenitori Picking Box Air mis. 2
1	Kit 4 contenitori Picking Box Air mis. 1



BRACCIO ESTENSIBILE CON VISUAL BOX

ART.	L mm	P mm	H mm	RAL	€
 ERGOWORK012	808/601	601/275	668	7016	272,80

Composto da:

qtà	descrizione
1	Profilo con base per piano
1	Braccio estensibile per profilo
1	Piastra porta monitor con standard VESA
1	Pannello per Visual Box
1	Cassetteria Visual Box con 5 cassette
2	Cassetteria Visual Box con 6 cassette



ART.	L mm	P mm	H mm	KG	RAL	€
MASTERBR2008	2000	750	1985/2310	1000	7035+7016	2892,61

Composto da:

qtà	descrizione
1	Banco smontato con piano in multiplex 40 mm
1	Copertura in acciaio gommato a 2 lati per piano in multiplex
1	Armadio L=560 mm con 4 cassetti 1x75 2x150 1x200
1	Armadio L=560 mm predisposto per porta con 1 piano regolabile
1	Porta totale sinistra H=600 mm con maniglia Dark Grey
2	Semipiano aggiuntivo L=560 mm
1	Kit 2 montanti biasolati
1	Kit 2 supporti inclinati con binario
1	Binario supplementare con attacchi
1	Lampada doppia
1	Kit 3 pannelli forati/mensole con 2 bordi fermacasse
1	Pannello forato Electric
2	Multipresa schuko a 2 scomparti
1	Multipresa schuko a 4 scomparti
1	Piastra porta monitor con standard VESA

qtà	descrizione
1	Magnetotermico differenziale
1	Cavo di collegamento wieland schuko/francese
1	Porta flacone igienizzante reversibile
1	Dispenser per guanti
1	Kit porta rotolo con carta Ø=240 mm
4	Kit 2 contenitori Picking Box Air mis. 3A2
2	Pannello forato/mensola con 1 bordo fermacasse
2	Kit cerniere per pannello forato
8	Barra aggancio per contenitori Picking Box mis. 1/2
4	Kit 4 contenitori Picking Box Air mis. 1
4	Kit 3 contenitori Picking Box Air mis. 2
2	Profilo con base per piano
2	Braccio estensibile per profilo
1	Vassoio inclinato
1	Snodo per piastra



PORTATA



RAL 7035 + RAL 7016



RAL 7016

COMPONENTI

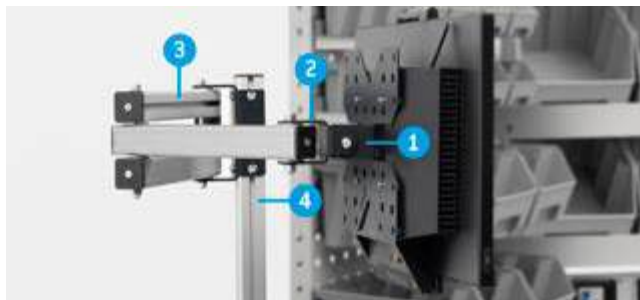

1. Piastra porta monitor con standard VESA
2. Snodo per piastra
3. Braccio estensibile per profilo
4. Profilo con base per piano

1. Piastra porta monitor con standard VESA
2. Pannello per Visual Box
3. Cassettiera Visual Box con 6 cassetti
4. Braccio estensibile per montante



BRACCIO ESTENSIBILE PER MONTANTE

ART.	L mm	P mm	H mm	angolo rotazione °	materiale	KG	RAL	€
 FBL74100039	580/330	72/97	158	240	Alluminio	20	7016	104,47



BRACCIO ESTENSIBILE PER PROFILO

Da utilizzare su profilo con base per piano

ART.	L mm	P mm	H mm	angolo rotazione °	materiale	KG	RAL	€
 FBL74180039	621/371	57/90	158	260	Alluminio	20	7016	107,57



PROFILO CON BASE PER PIANO

ART.	L mm	P mm	H mm	adatto per	materiale	KG	RAL	€
 FBL74160039	100	100	504	Piano in multiplex-Piano in MDF con copertura gommata	Alluminio	20	7016	41,54



PANNELLO PER VISUAL BOX

Da utilizzare con piastra porta monitor

ART.	L mm	P mm	H mm	dim. foro mm	passo mm	KG	RAL	€
 FBL74150039	601	31	313	10x10	38	20	7016	57,35

vedi Visual Box pag. 77

COMPONENTI



PIASTRA PORTA MONITOR CON STANDARD VESA

Orientabile su un asse



ART.	L mm	P mm	H mm	RAL	€
FBL74120039	225	50	225	7016	13,95



SNODO PER PIASTRA

Da utilizzare con piastra porta monitor per orientarla su due assi



ART.	L mm	P mm	H mm	RAL	€
FBL74110039	91	67	51	7016	15,19



COPPIA SQUADRETTE A L

Da utilizzare con piastra porta monitor



ART.	L mm	P mm	H mm	RAL	€
FBL74170039	38	36	32	7016	14,26



VASSOIO INCLINATO



ART.	L mm	P mm	H mm	RAL	€
FBL74130039	425	308	135	7016	46,81



1. Vassoio inclinato
2. Braccio estensibile per profilo
3. Profilo con base per piano



PORTATA



RAL 7016



ALLUMINIO

COMPONENTI



PANNELLO PER PICKING BOX

Da utilizzare con piastra porta monitor

ART.	L mm	P mm	H mm	adatto per	KG	RAL	€
FBL74140039	470	12	356	Contenitore Picking Box mis. 1/2	20	7016	42,16



BARRA AGGANCIO PER CONTENITORI PICKING BOX MIS. 1/2

ART.	L mm	P mm	H mm	finitura	€
FBLIT020099	445	14	89	Zincato	7,44

KIT 4 CONTENITORI PICKING BOX AIR MIS. 1

ART.	dim. ingombro			colore	€
	L mm	P mm	H mm		
FBLIT0600LQ	108	173	76		5,89
FBLIT060032	108	173	76		5,89
FBLIT06001Z	108	173	76		5,89
FBLIT06002Y	108	173	76		5,89
FBLIT06004Q	108	173	76		5,89



KIT 3 CONTENITORI PICKING BOX AIR MIS. 2

ART.	dim. ingombro			colore	€
	L mm	P mm	H mm		
FBLIT0610LQ	160	234	127		8,99
FBLIT061032	160	234	127		8,99
FBLIT06101Z	160	234	127		8,99
FBLIT06102Y	160	234	127		9,30
FBLIT06104Q	160	234	127		8,99

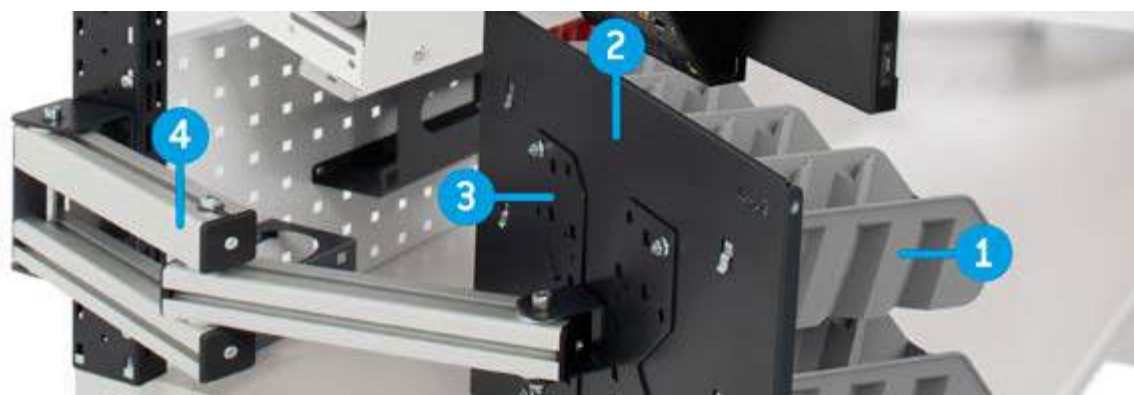

1. Barra aggancio per contenitori Picking Box mis. 1/2
Kit 4 contenitori Picking Box Air mis. 1
2. Pannello per Picking Box
3. Piastra porta monitor con standard VESA
4. Braccio estensibile per montante



CONFIGURE

SHOP

PATENTED*

ART.	L mm	P mm	H mm	KG	RAL	€
MASTERBR1509	1500	750	1985/2310	1000	7035+7016	2750,01

Composto da:

qtà	descrizione	qtà	descrizione
1	Banco smontato con piano in multiplex 40 mm	3	Braccio estensibile per montante
1	Armadio L=560 mm con 5 cassetti 1x75 3x100 1x200	1	Snodo per piastra
2	Piano superiore/inferiore L=560 mm	2	Piastra porta monitor con standard VESA
1	Porta totale sinistra H=600 mm con maniglia Dark Grey	1	Vassoio inclinato
1	Piano interno L=558 mm	1	Pannello per Visual Box
1	Supporto semipiano intermedio	1	Cassettiera Visual Box con 5 cassetti
2	Pannello forato laterale	2	Cassettiera Visual Box con 6 cassetti
1	Kit 2 montanti biasolati	1	Cestino capacità 30 L
1	Kit 2 pannelli forati/mensole con 1 bordo fermacasse	2	Porta bombolette inclinato a 2 posti
1	Kit 2 supporti inclinati con binario	1	Tasca porta documenti A4
1	Lampada doppia	1	Kit porta rotolo con carta Ø=130 mm
1	Pensile vasistas senza serratura	3	Gancio Unipok per utensili - confezione 30 pezzi
1	Barra led	2	Barra aggancio per contenitori Picking Box mis. 1/2
1	Coppia staffe di fissaggio pensile su montanti	1	Kit 4 contenitori Picking Box Air mis. 1
1	Kit 3 contenitori Picking Box Air mis. 2		



PORTATA



RAL 7035 + RAL 7016



RAL 7016





ZINCATO

COMPONENTI





PANNELLO FORATO/MENSOLA

ART.	L mm	P mm	H mm	dim. foro mm	passo mm	RAL	€
 FBL76070008	647	40	304	10x10	38	7035	24,18
 FBL76070004	647	40	304	10x10	38	5012	31,00





PANNELLO FORATO/MENSOLA CON 1 BORDO FERMACASSE

ART.	L mm	P mm	H mm	dim. foro mm	passo mm	RAL	€
 FBL76080108	647	40	456	10x10	38	7035	38,44
 FBL76080104	647	40	456	10x10	38	5012	45,88



KIT CERNIERE PER PANNELLO FORATO

ART.	L mm	P mm	H mm	 KG	€
 FBL7600011F	76	38	64	60	32,55

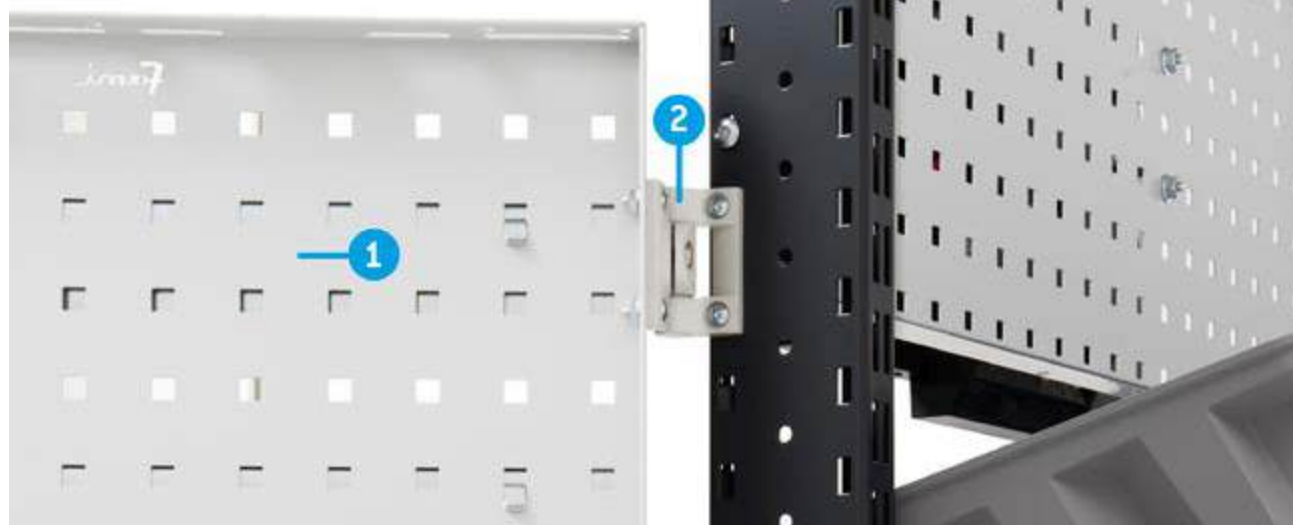

1. Pannello forato/mensola con 1 bordo fermacasse
2. Kit cerniere per pannello forato



CONFIGURE

SHOP

PATENTED*

ART.	Lmm	Pmm	Hmm		RAL	€
DYNAMIC1505	1497/1706	780	1983/2383	400	7035+7016	2942,52

Composto da:

qtà	descrizione
1	Banco smontato regolabile elettricamente
1	Armadio L=500 mm con 1 cassetto H=150 mm
1	Coperchio per armadio L=500 mm
1	Coppia supporti per armadio
1	Telaio portaprese aggiuntivo completo di tamponi e angolari
1	Kit 2 montanti biasolati
1	Coppia supporti per parete attrezzata L=1000 mm
1	Kit 2 supporti inclinati con binario
1	Lampada doppia
1	Kit 3 pannelli forati/mensole con 2 bordi fermacasse
1	Pannello forato Electric
4	Kit 2 contenitori Picking Box Air mis. 3A2
2	Porta bombolette inclinato a 2 posti

qtà	descrizione
1	Magnetotermico differenziale
1	Multipresa schuko a 4 scomparti
2	Multipresa schuko a 2 scomparti
1	Cavo di collegamento wieland schuko/francese
1	Coppia squadrette a L
1	Snodo per piastra
1	Piastra porta monitor con standard VESA
2	Pannello forato/mensola con 1 bordo fermacasse
2	Kit cerniere per pannello forato
6	Barra aggancio per contenitori Picking Box mis. 1/2
2	Kit 4 contenitori Picking Box Air mis. 1
4	Kit 3 contenitori Picking Box Air mis. 2



PORTATA



RAL 7035 + RAL 7016



RAL 5012



RAL 7035

START

PRO

PRO+

TOOL ORGANIZER

UNIPOK

PIKPAD

THE BLOCK

IRON TEAM

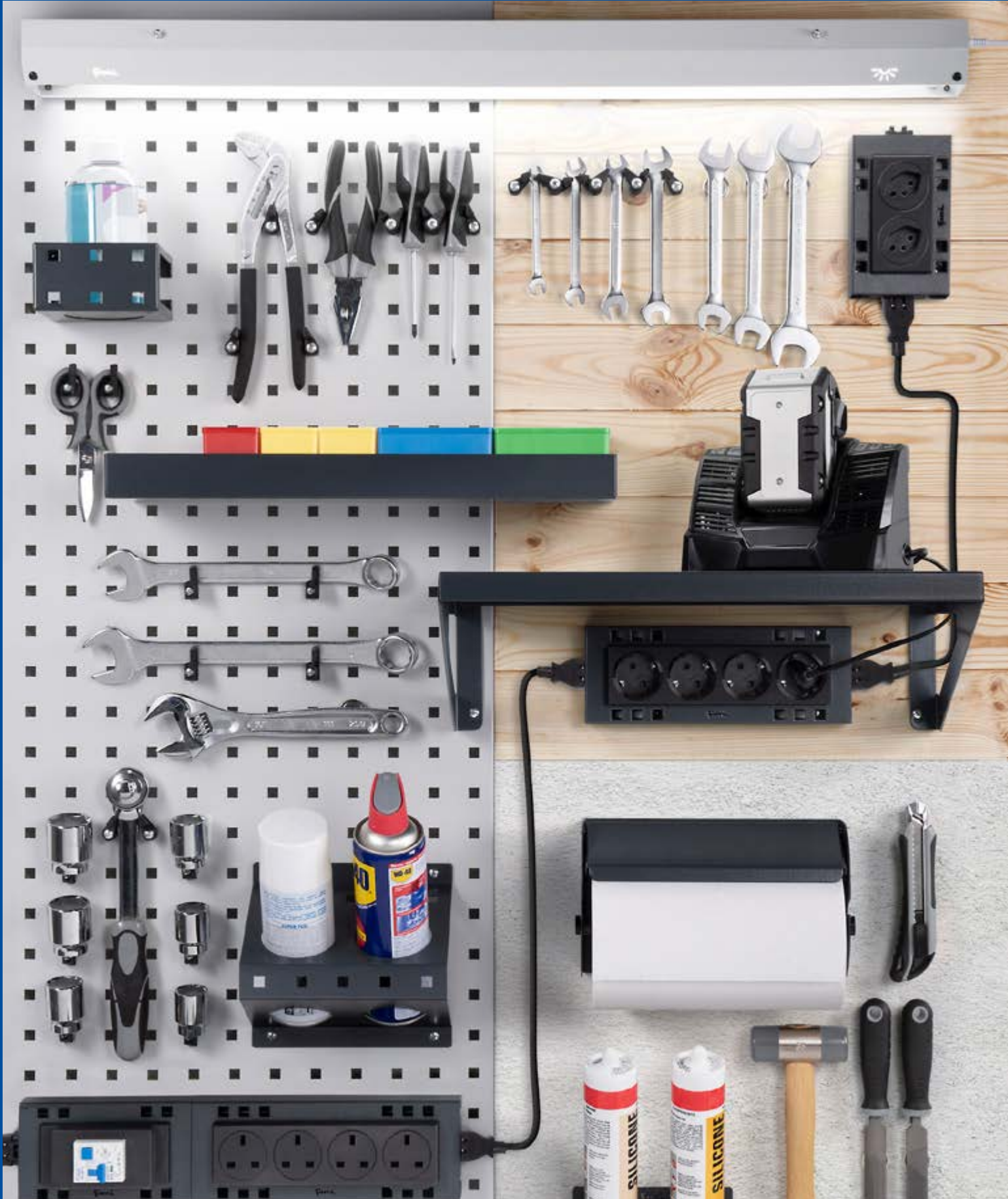



GANCIO UNIPOK PER UTENSILI - CONFEZIONE 30 PEZZI

Con una confezione si possono agganciare fino a 30 utensili

ART.	pz. per confezione	colore	€
FBLIT009007	30	Nero	13,95



Unipok sono i **ganci universali** di Fami che, grazie al sistema a vite, possono essere posizionati su pareti forate o pannelli in legno. Ogni Unipok può essere posizionato con diverse inclinazioni per poter fissare utensili di volumi e dimensioni differenti. Libera la tua fantasia per organizzare al meglio la tua parete forata da muro o da banco e la tua parete in legno per avere sempre tutto a portata di mano!

Con Unipok l'ordine è un gioco da ragazzi!



Fissaggio su legno



Fissaggio su pannello forato

IN 4 POSIZIONI TUTTE LE COMBINAZIONI CHE VUOI!

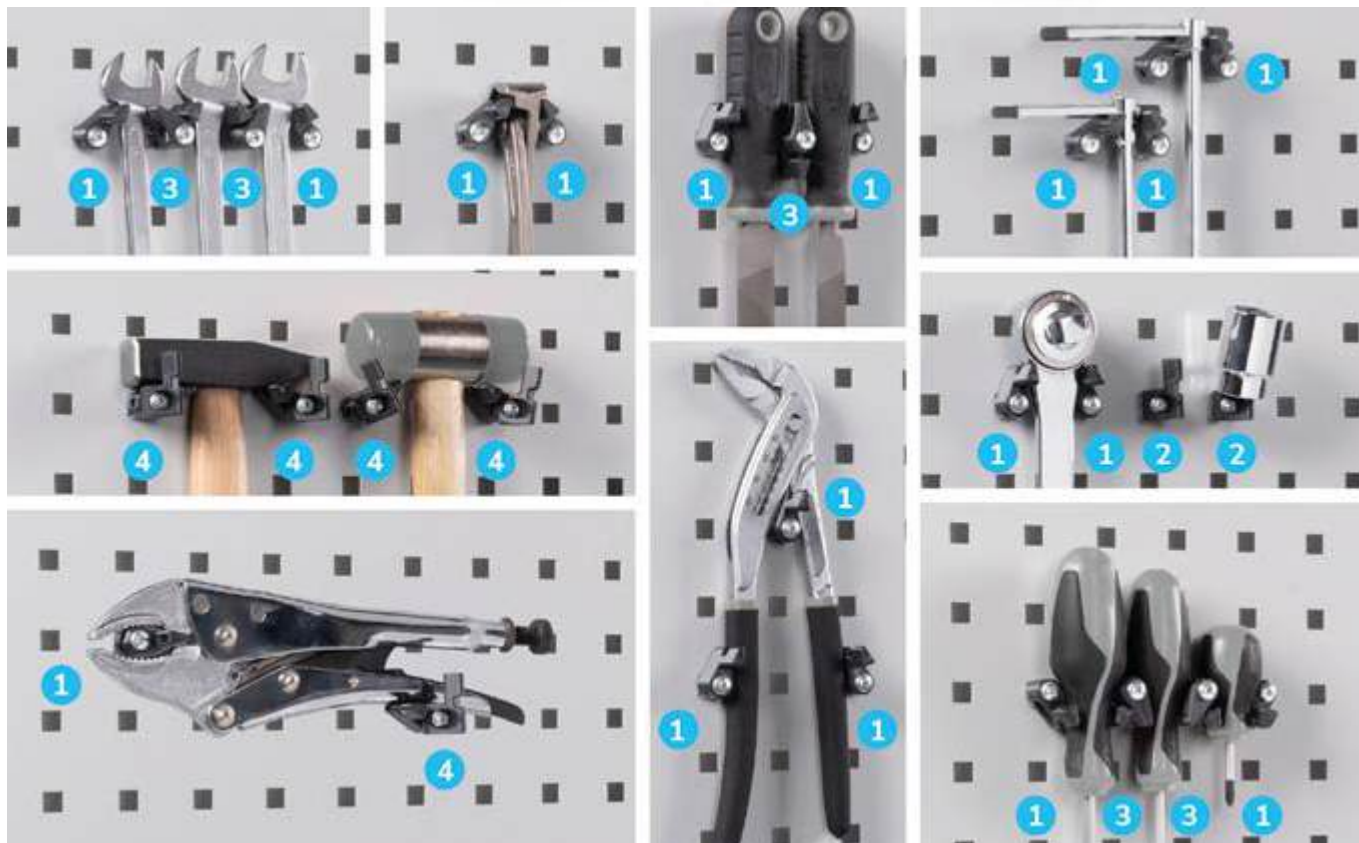





CREARE IL PERFETTO 5S SHADOW TOOL BOX CON PIKPAD!

Con **Pikpad** è possibile allestire un **5S shadow tool box** organizzato nel minimo dettaglio. Il fondo a foro quadro 10x10 del vassoio consente l'installazione di **Unipok** per creare **kit su misura** per ogni lavoro da svolgere e, grazie alle pratiche **etichette utensili**, sarà possibile identificare la tipologia di attrezzo che deve alloggiare in ogni spazio realizzato.

Pikpad è fornito completo di un set di 5 fogli adesivi:

- 4 fogli con più di 250 etichette di utensili (forma utensile + misura)
- 1 foglio non pretagliato per realizzare adesivi personalizzati

Unipok deve essere acquistato separatamente



VASSOIO PIKPAD 5S SHADOW TOOL BOX

ART.	LEH	PEH	L mm	P mm	H mm	RAL	€
FBLIT033039	18	18	284	287	50	7016	44,64

[CONFIGURE](#)

[SHOP](#)



VASSOIO PIKPAD 5S SHADOW TOOL BOX

ART.	LEH	PEH	L mm	P mm	H mm	RAL	€
FBLIT034039	27	18	437	287	50	7016	54,25

[CONFIGURE](#)

[SHOP](#)



VASSOIO PIKPAD 5S SHADOW TOOL BOX

ART.	LEH	PEH	L mm	P mm	H mm	RAL	€
FBLIT035039	36	18	590	287	50	7016	63,86

[CONFIGURE](#)

[SHOP](#)



3 POSIZIONI DI REGOLAZIONE

Il **profilo brevettato** integrato nella parte posteriore di Pikpad consente di **regolare** il vassoio in **3 diverse posizioni**. È possibile, così, adattare l'inclinazione di Pikpad in base all'altezza e alla postura dell'utilizzatore per poter avere tutto a portata di mano e lavorare seguendo i principi dell'**ergonomia**.



SOSTEGNO DA TAVOLO PER VASSOIO PIKPAD 5S SHADOW TOOL BOX

ART.	L mm	P mm	H mm	RAL	€
3D PIKPAD001	653	255	198	7016	42,16
3D PIKPAD002	959	255	198	7016	46,19
3D PIKPAD003	1444	255	198	7016	58,59

ORGANIZZAZIONE MOBILE

I 5S shadow tool box rendono mobile l'organizzazione dell'attrezzatura in quanto possono essere installati su diversi supporti e facilmente movimentati tramite maniglie laterali. Sono posizionabili su piani di lavoro tramite l'apposito sostegno da tavolo, sui montanti delle pareti attrezzate allestite con barre in alluminio all'interno di cassette. In quest'ultimo caso, è possibile aumentare esponenzialmente l'organizzazione interna delle cassette integrando Pikpad con i tradizionali materiali di separazione come cassette divisorio e divisori in metallo.



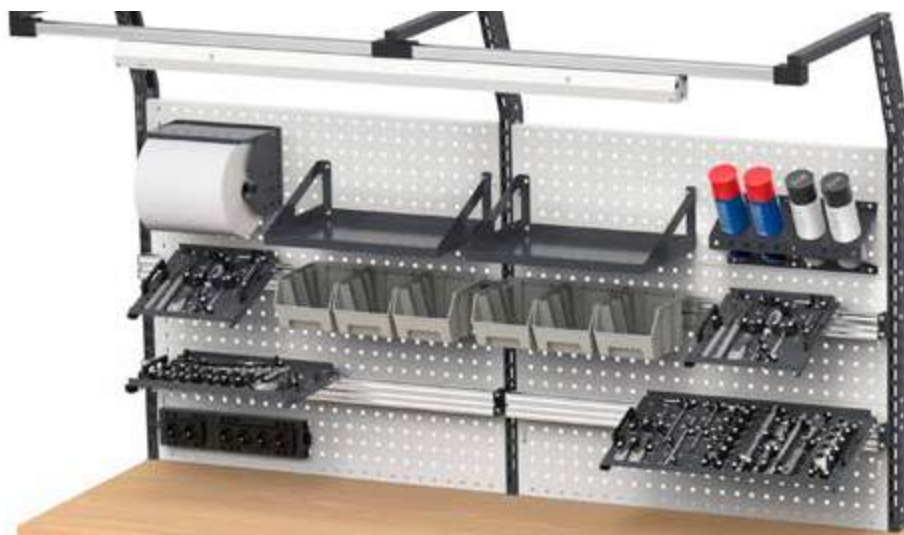

BRACCIO ESTENSIBILE PER MONTANTE CON SNODO PER VASSOIO PIKPAD 5S

ART.	L mm	P mm	H mm	angolo rotazione °	materiale	KG	RAL	€
ERGOWORK015	636/220	663/663	160	240	Alluminio	20	7016	137,02



PROFILO IN ALLUMINIO PER VASSOIO PIKPAD 5S SHADOW TOOL BOX

ART.	L mm	P mm	H mm	€
FBLIT036000	647	35	60	14,57
FBLIT037000	953	35	60	18,60
FBLIT038000	1438	35	60	31,00
FBLIT039000	1938	35	60	43,71



COPPIA STAFFE PER FISSAGGIO PROFILO SU MONTANTE

ART.	RAL	€
FBLIT040039	7016	16,74



COPPIA STAFFE PER SOSTEGNO DA TAVOLO

ART.	RAL	€
FBLIT041039	7016	27,59





GANCIO CON PUNTALE

ART.	L mm	P mm	H mm	multiplo d'ordine	€
FBLIT030000	36	78	42	10	1,86
FBLIT031000	36	128	42	10	1,86
FBLIT032000	36	178	42	10	1,86

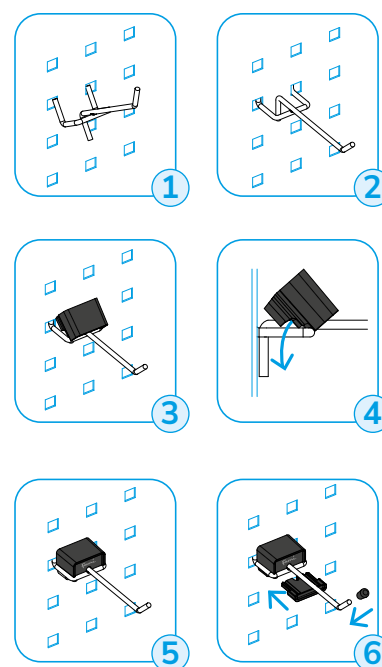
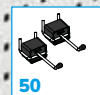
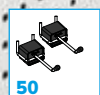
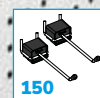
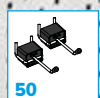
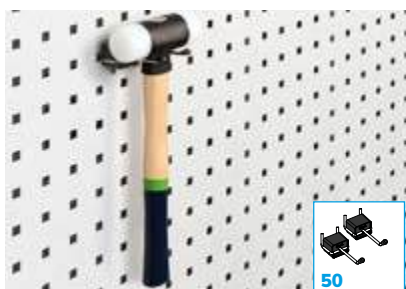
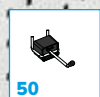
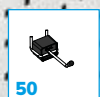
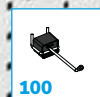
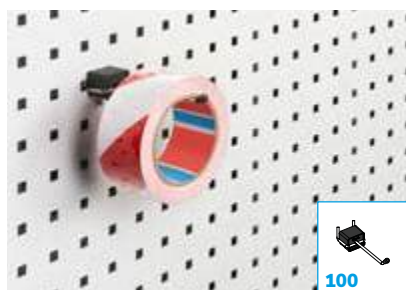
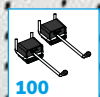

Il blocco di sicurezza ferma il gancio in posizione orizzontale e ne evita il movimento durante le operazioni di recupero/deposito utensili.

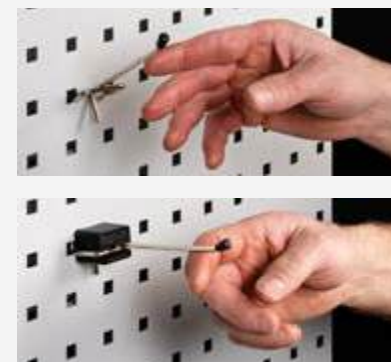

PORTATA



RAL 7016



ALLUMINIO



FISSAGGIO SU LEGNO



FISSAGGIO SU PANNELLO FORATO



FISSAGGIO SU MURO

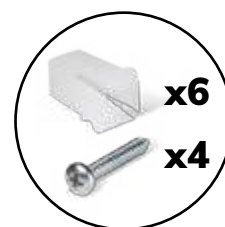

SET DI FISSAGGIO SU LEGNO E PANNELLO FORATO INCLUSO



MENSOLA PICCOLA REVERSIBILE

ART.	Lmm	Pmm	Hmm	RAL	€
 FBLIT017039	303	317	144	7016	23,25



MENSOLA GRANDE REVERSIBILE

ART.	Lmm	Pmm	Hmm	RAL	€
 FBLIT016039	455	317	144	7016	25,73





KIT 4 CONTENITORI PICKING BOX AIR MIS. 1

ART.	dim. ingombro			colore	€
	L mm	P mm	H mm		
FBLIT0600LQ	108	173	76		5,89
FBLIT060032	108	173	76		5,89
FBLIT06001Z	108	173	76		5,89
FBLIT06002Y	108	173	76		5,89
FBLIT06004Q	108	173	76		5,89



KIT 3 CONTENITORI PICKING BOX AIR MIS. 2

ART.	dim. ingombro			colore	€
	L mm	P mm	H mm		
FBLIT0610LQ	160	234	127		8,99
FBLIT061032	160	234	127		8,99
FBLIT06101Z	160	234	127		8,99
FBLIT06102Y	160	234	127		9,30
FBLIT06104Q	160	234	127		8,99



KIT 2 CONTENITORI PICKING BOX AIR MIS. 3A2

ART.	dim. ingombro			colore	€
	L mm	P mm	H mm		
FBLIT0270LQ	224	354	147		13,33
FBLIT027032	224	354	147		13,33
FBLIT02701Z	224	354	147		13,33
FBLIT02702Y	224	354	147		13,64
FBLIT02704Q	224	354	147		13,33



BARRA AGGANCIO PER CONTENITORI PICKING BOX MIS. 1/2

ART.	L mm	P mm	H mm	finitura	€
FBLIT020099	445	14	89	Zincato	7,44

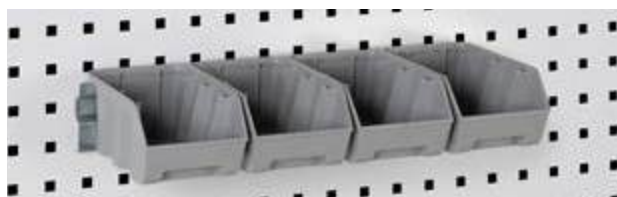

Esempio di applicazione del kit 4 contenitori mis. 1 su barra aggancio



Esempio di applicazione del kit 3 contenitori mis. 2 su barra aggancio





PORTA SILICONE INCLINATO A 2 POSTI

ART.	Lmm	Pmm	Hmm	Ø foro mm	RAL	€
FBLIT008039	150	71	96	61	7016	14,26



PORTA BOMBOLETTE INCLINATO A 2 POSTI

ART.	Lmm	Pmm	Hmm	Ø foro mm	RAL	€
FBLIT007039	188	111	172	70	7016	14,26



PORTA BOMBOLETTE A 6 POSTI

ART.	Lmm	Pmm	Hmm	RAL	€
FBLIT010039	455	75	167	7016	27,28



KIT PORTA CONTENITORE CON CONTENITORE SALVIETTE LAVAMANI

ART.	RAL	€
FBLIT006039	7016	90,83



KIT PORTA ROTOLO CON CARTA Ø=240 MM

ART.	Lmm	Pmm	Hmm	RAL	€
FBLIT004039	297	275	270	7016	53,01



KIT PORTA ROTOLO CON CARTA Ø=130 MM

ART.	Lmm	Pmm	Hmm	RAL	€
FBLIT003039	257	135	168	7016	34,10



PORTA FLACONE IGIENIZZANTE REVERSIBILE

ART.	Lmm	Pmm	Hmm	RAL	€
FBLIT002039	113	100	62	7016	16,12



DISPENSER PER GUANTI

ART.	Lmm	Pmm	Hmm	RAL	€
FBLIT005039	247	81	132	7016	13,95



TASCA PORTA DOCUMENTI A4

ART.	Lmm	Pmm	Hmm	RAL	€
FBLIT001039	365	68	187	7016	19,84



KIT PRONTO SOCCORSO

ART.	Lmm	Pmm	Hmm	€
FBLIT024000	256	90	190	30,69



PORTA ESTINTORE CON ESTINTORE DA 2 KG

ART.	Lmm	Pmm	Hmm	€
FBLIT023000	115	115	400	68,20



SELLA REGGICAVI

ART.	Lmm	Pmm	Hmm	RAL	€
FBLIT019039	220	95	101	7016	22,32



KIT PORTA CONTENITORE

ART.	Lcinghia mm	RAL	€
FBLIT018039	910	7016	34,72



MENSOLA PORTA TRAPANO AVVITATORE

ART.	Lmm	Pmm	Hmm	RAL	€
FBLIT049039	152	228	125	7016	29,76



Mensola porta trapano avvitatore realizzata in collaborazione con:





MENSOLA PORTA OGGETTI REVERSIBILE

ART.	L mm	P mm	H mm	RAL	€
 FBLIT015039	455	160	40	7016	26,97



PORTA PUNTE

ART.	L mm	P mm	H mm	finitura	€
 FBLIT0260ZZ	155	84	39	Inox	29,45



KIT 10 CONTENITORI

ART.	€
 FBLIT028000	12,09



CALAMITA COMPLETA DI CLIP E VITE - CONFEZIONE 10 PEZZI

ART.	pz. per confezione	Ø mm	finitura	€
 FBL95410000	10	20	Zincato	52,39



VALIGETTA CON CONTENITORI

ART.	L mm	P mm	H mm	€
 FBLIT022001	440	350	80	53,01

KIT PORTA VALIGETTA

ART.	RAL	€
 FBLIT021039	7016	46,19





PIASTRA PORTA MONITOR CON SQUADRETTE

ART.	Lmm	Pmm	Hmm	RAL	€
 ERGOWORK014	225/129	119/225	225	7016	43,40





CESTINO CAPACITÀ 30 L

ART.	Lmm	Pmm	Hmm		RAL	€
 FBLIT025039	387	277	394	30	7016	95,48



PENSILE CON PORTA

ART.	Lmm	Pmm	Hmm		RAL	€
 FBL8015C000PD	460	250	456	25	7035+7016	108,50
 FBL8015C00004	460	250	456	25	5012	115,32



PORTATA



CAPACITÀ



RAL 7035+RAL 7016



RAL 5012



RAL 7016



ZINCATO



INOX





MENSOLA PORTA DOCUMENTI A4

ART.	L mm	P mm	H mm	KG	RAL	€
 FBLIT042039	371	243	65	3	7016	23,87



MENSOLA PER PANNELLI

ART.	L mm	P mm	H mm	KG	RAL	€
 FBLIT045039	898	154	152	20	7016	34,72
 FBLIT046039	1354	154	152	20	7016	34,72
 FBLIT047039	1886	154	152	20	7016	34,72



PORTA SMERIGLIATRICE

ART.	L mm	P mm	H mm	KG	RAL	€
 FBLIT058039	190	73	140	10	7016	25,73

BANCO DA IMBALLAGGIO

I diversi accessori Iron Team trasformano il tradizionale tavolo da lavoro in un banco da imballaggio sempre pronto all'uso. Divisori, porta bobina, taglierina e bracci estensibili consentono di avere a portata di mano tutto il necessario per confezionare i prodotti con ordine, cura e precisione.



DIVISORIO VERTICALE PER IMBALLI



ART.	L mm	P mm	H mm	RAL	€
 FBLIT043039	310	89	302	7016	26,35
 FBLIT044039	462	89	302	7016	26,97



Banco da imballaggio vedi pag. 260





TUBO PORTA BOBINA CON STAFFE

ART.	L mm	P mm	H mm	KG	RAL	€
 IRONTEAM012	991	146	150	50	7016	46,50
 IRONTEAM013	1491	146	150	50	7016	49,60
 IRONTEAM014	1991	146	150	50	7016	53,63



TAGLIERINA

ART.	L mm	P mm	H mm	RAL	€
 IRONTEAM009	987	208	120	7016	117,18
 IRONTEAM010	1472	208	120	7016	144,15
 IRONTEAM011	1972	208	120	7016	175,46



PORTATA



RAL 7016



SUPPORTO PER MAGNETOTERMICO DIFFERENZIALE

ART.	L mm	P mm	H mm	RAL	€
FBLET003039	159	32	92	7016	13,33



MAGNETOTERMICO DIFFERENZIALE 2P+T 16A, 30mA TYPE A

ART.	L mm	P mm	H mm	colore	€
FBLET012007	159	59	90	Nero	154,69



SUPPORTO MULTIPRESA A 2 SCOMPARTI

ART.	L mm	P mm	H mm	RAL	€
FBLET001039	148	32	92	7016	12,71



SUPPORTO MULTIPRESA A 4 SCOMPARTI

ART.	L mm	P mm	H mm	RAL	€
FBLET002039	249	32	92	7016	15,19



MULTIPRESA A 2 SCOMPARTI

ART.	L mm	P mm	H mm	tipo presa	colore	€
FBLET004007	148	59	46	Schuko	Nero	20,77
FBLET006007	148	59	46	Svizzera	Nero	44,64
FBLET008007	148	59	46	Inglese	Nero	36,27
FBLET010007	148	59	46	Francese	Nero	20,77



MULTIPRESA A 4 SCOMPARTI

ART.	L mm	P mm	H mm	tipo presa	colore	€
FBLET005007	248	59	46	Schuko	Nero	27,28
FBLET007007	248	59	46	Svizzera	Nero	51,15
FBLET009007	248	59	46	Inglese	Nero	63,24
FBLET011007	248	59	46	Francese	Nero	27,28



PRESA SCHUKO CON INTERRUTTORE

ART.	L mm	P mm	H mm	tipo presa	colore	€
FBLET024007	175	60	45	Schuko	Nero	50,84

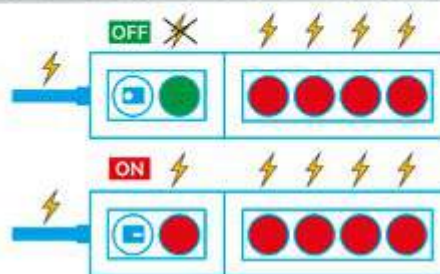



CAVO DI COLLEGAMENTO WIELAND CON SPINE IN/OUT

ART.	L mm	P mm	H mm	colore	€
FBLET013007	200	28	13	Nero	19,22



CONNETTORE AD H WIELAND A 2 OUTPUT

ART.	L mm	P mm	H mm	colore	€
FBLET015007	60	35	35	Nero	19,22



CAVO DI COLLEGAMENTO WIELAND



ART.	L mm	tipo spina	colore	€
FBLET016007	3000	Schuko/Francese	Nero	19,22
FBLET017007	3000	Inglese	Nero	23,25
FBLET018007	3000	Svizzera	Nero	21,39



CAVO DI COLLEGAMENTO WIELAND CON SPINE IN/OUT

ART.	L mm	colore	€
FBLET014007	1500	Nero	21,39





PRESA USB DATI

ART.	Ø mm	L mm	H mm	colore	€
 FBLET019007	59	70	54	Nero	154,07



PRESA USB RICARICA

ART.	Ø mm	L mm	H mm	colore	€
 FBLET020007	59	70	54	Nero	126,79



LAMPADA L=988 MM CON STAFFE DI FISSAGGIO

ART.	L mm	temperatura colore K	Watt	Hz	Lumen	RAL	€
 IRONTEAM001	988	4000	27	50	5058	7016	270,01



LAMPADA L=1473 MM CON STAFFE DI FISSAGGIO

ART.	L mm	temperatura colore K	Watt	Hz	Lumen	RAL	€
 IRONTEAM002	1473	4000	41	50	7588	7016	335,42

LIGHT



LAMPADA SINGOLA

Set di fissaggio incluso (staffe e calamite).
Senza pulsante on/off

ART.	L mm	temperatura colore K	Watt	Hz	Lumen	RAL	€
 FBL99400008	922	4000	15	50/60	1500	7035	124,31
 FBL99450008	1407	4000	20	50/60	2000	7035	136,09



LAMPADA DOPPIA

Set di fissaggio incluso (staffe e calamite).
Senza pulsante on/off

ART.	L mm	temperatura colore K	Watt	Hz	Lumen	RAL	€
 FBL99400108	922	4000	15	50/60	3000	7035	160,27
 FBL99450108	1407	4000	20	50/60	4000	7035	174,53



Esempio di fissaggio al binario aereo



Esempio di fissaggio al pannello forato tramite staffe



Esempio di fissaggio con calamita



RAL 7016

RAL 7035

CASSETTIERE PER OFFICINE

FLEXA



Gli armadi con cassetti Flexa sono una soluzione versatile e compatta per l'organizzazione di tutto il necessario per il lavoro. Sono caratterizzati da **serratura a cilindro centrale** e **cassetti con estrazione totale 100%** che possono avere una **portata variabile tra i 50 e i 70 kg**. L'interno dei **cassetti** è completamente personalizzabile grazie alla possibilità di poterlo suddividere tramite **divisori, cassette divisorio e vassoi portautensili 5S**. Il piano superiore può essere lasciato libero o protetto con un **piano a 3 bordi in PVC** per effettuare lavorazioni e operazioni.



**PORTATA CASSETTI
DA 50 A 70 KG**

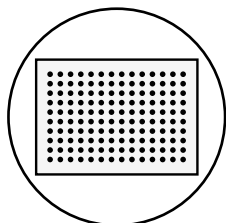

CASSETTI FORATI

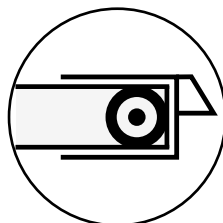

CUSCINETTI A SFERA

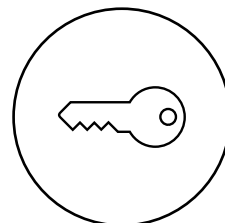

CHIUSURA A CHIAVE



SERRATURA

La serratura a cilindro si collega tramite un'asta quadra al gruppo di chiusura posteriore composto di un elemento rotante in materiale plastico e un'asta di chiusura in lamiera di acciaio. Girando la chiave si aziona il sistema a camme del gruppo di chiusura che fa ruotare l'asta posteriore (A).



TOP A 3 BORDI RIVESTITO IN PVC

Il top a 3 bordi rivestito in PVC protegge la parte superiore dell'armadio e, grazie ai bordi rialzati, evita la caduta del materiale posizionato su di esso.



LIBERAMENTE ORGANIZZABILE

Il cassetto può essere suddiviso internamente tramite cassette divisorie portaminuterie e divisori longitudinali e trasversali in metallo. Quest'ultimi sono fissati al fondo forato del cassetto tramite viti per evitare la fuoriuscita del materiale stoccato.



CASSETTI FORATI



ORGANIZZAZIONE AL MILLIMETRO
Fori e scanalature sui cassetti facilitano la suddivisione interna del cassetto per una perfetta organizzazione di utensili e materiali.



ESTRAZIONE TOTALE
100%



PORTATA
50 / 70 KG

COLORI

L'armadio Flexa è disponibile in 3 combinazioni di colore.

ARMADIO



7016
7035



7035



5012

LEGENDA

		EH		
		36x27 EH	54x27 EH	
	Dimensioni armadio	L=	717	1023
		P=	600	600
	Dimensioni interne cassetto	L=	602	908
		P=	449	449



CONFIGURE

ARMADIO CON 7 CASSETTI 2X75 1X100 3X150 1X200

ART.	cassetti		RAL	€
	KG			
FDF109054PD	70	100%	7035+7016	711,45
FDF10905408	70	100%	7035	711,45
FDF10905404	70	100%	5012	837,31

H=1002 mm



CONFIGURE

ARMADIO CON 9 CASSETTI 9X100

ART.	cassetti		RAL	€
	KG			
FDF109056PD	70	100%	7035+7016	826,77
FDF10905608	70	100%	7035	826,77
FDF10905604	70	100%	5012	901,17

H=1002 mm



CONFIGURE

ARMADIO CON RUOTE CON 5 CASSETTI 4X100 1X200

ART.	cassetti		RAL	€
	KG			
FDGD56001PD	70	100%	7035+7016	641,39
FDGD5600108	70	100%	7035	641,39
FDGD5600104	70	100%	5012	681,07

H=921 mm

Ruote: Gomma antitraccia sintetica Ø 125 mm
Portata armadio: 300 kg

MATERIALE DI SEPARAZIONE



TOP A 4 BORDI RIVESTITO IN PVC

ART.	L mm	P mm	H mm	colore	€
FDF99400107	717	602	22	Nero	69,44



ART.	adatto per cassetto H mm	componenti	€
FFH10051000	50/300	3 x Divisorio a 3 canali 9 x Divisorio a 4 canali 12 x Divisorio trasversale L=47 mm 36 x Divisorio trasversale L=36 mm	31,93



ART.	adatto per cassetto H mm	componenti	€
FFH10051300	50/300	18 x Divisorio trasversale L=47 mm 12 x Divisorio trasversale L=73 mm 6 x Divisorio a 2 canali 6 x Divisorio a 3 canali	28,83



ART.	adatto per cassetto H mm	componenti	€
FFH10051500	50/300	20 x Divisorio trasversale L=36 mm 20 x Divisorio trasversale L=47 mm 6 x Divisorio a 3 canali 5 x Divisorio a 4 canali 1 x Porta chiavi a brugola	31,93



ART.	adatto per cassetto H mm	componenti	€
FFH10071800	75	16 x Cassetta divisorio 75x75 mm 8 x Cassetta divisorio 150x75 mm 4 x Cassetta divisorio 150x150 mm	32,55



ART.	adatto per cassetto H mm	componenti	€
FFH10071600	75	12 x Cassetta divisorio 150x75 mm	29,76
FFH10101600	100/125	6 x Cassetta divisorio 150x150 mm	34,72



ART.	adatto per cassetto H mm	componenti	€
FFH10070500	75	2 x Divisorio longitudinale fessurato L=457 mm 3 x Divisorio trasversale L=202 mm	16,43
FFH10100500	100/125		17,05
FFH10150500	150/175		22,63
FFH10200500	200/250		32,24



DIM. INTERNE LxP



PORTATA



ESTRAZIONE



RAL 7035 + RAL 7016



RAL 5012



RAL 7035



ARMADIO CON 7 CASSETTI 2X75 1X100 3X150 1X200

ART.	cassetti		RAL	€
	KG			
FDL109054PD	50	100%	7035+7016	877,30
FDL10905408	50	100%	7035	877,30
FDL10905404	50	100%	5012	985,49

H=1002 mm

CONFIGURE



ARMADIO CON 9 CASSETTI 9X100

ART.	cassetti		RAL	€
	KG			
FDL109056PD	50	100%	7035+7016	1016,18
FDL10905608	50	100%	7035	1016,18
FDL10905604	50	100%	5012	1117,86

H=1002 mm

CONFIGURE



MATERIALE DI SEPARAZIONE



TOP A 3 BORDI RIVESTITO IN PVC

ART.	L mm	P mm	H mm	colore	€
FDL91500107	1024	601	30	Nero	88,97



ART.	adatto per cassetto H mm	componenti	€
FFH40051200	50/300	15 x Divisorio trasversale L=36 mm 10 x Divisorio trasversale L=47 mm 6 x Divisorio trasversale L=73 mm 6 x Divisorio a 2 canali 6 x Divisorio a 3 canali 6 x Divisorio a 4 canali	39,68



ART.	adatto per cassetto H mm	componenti	€
FFH40051500	50/300	30 x Divisorio trasversale L=36 mm 10 x Divisorio trasversale L=47 mm 6 x Divisorio a 3 canali 12 x Divisorio a 4 canali	42,16



ART.	adatto per cassetto H mm	componenti	€
FFH40071100	75	18 x Cassetta divisorio 150x150 mm	42,47
FFH40101100	100/125		48,05



ART.	adatto per cassetto H mm	componenti	€
FFH40071300	75	12 x Cassetta divisorio 150x75 mm 12 x Cassetta divisorio 150x150 mm	44,33
FFH40101300	100/125		51,15

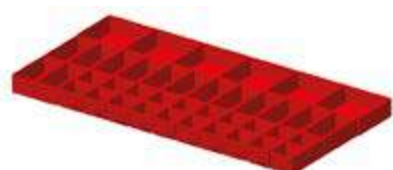

ART.	adatto per cassetto H mm	componenti	€
FFH40071600	75	20 x Cassetta divisorio 75x75 mm 14 x Cassetta divisorio 150x75 mm 6 x Cassetta divisorio 150x150 mm	48,98



ART.	adatto per cassetto H mm	componenti	€
FFH40070500	75	4 x Divisorio longitudinale fessurato L=457 mm 2 x Divisorio trasversale L=151 mm 3 x Divisorio trasversale L=202 mm	24,18
FFH40100500	100/125		29,45
FFH40150500	150/175		40,61
FFH40200500	200/250		59,52



DIM. INTERNE L x P



PORTATA



ESTRAZIONE



RAL 7035 + RAL 7016



RAL 5012



RAL 7035

START

PRO

PRO+

CASSETTIERE PER INDUSTRIA

MASTER DE



Gli armadi a cassetti della linea Master DE rendono la custodia del materiale di lavoro altamente flessibile grazie alla possibilità di allestirli sia con **porte a battente e ripiani** che con **cassetti** con portata ed estrazione regolabile. In particolare, i cassetti possono avere un'**estrazione tra il 92% e il 100%** e una **portata tra i 50 e i 100 kg**. Inoltre, sono liberamente suddivisibili internamente con **divisori, cassette divisorio e vassoi portautensili**. Possono essere installati **top superiori** di varie tipologie oltre a **zoccoli** per rialzare l'armadio da terra.



**PORTATA CASSETTI
DA 50 A 100 KG**

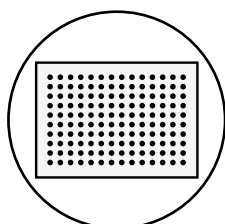

CASSETTI FORATI

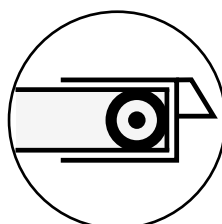

CUSCINETTI A SFERA

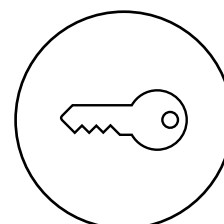

CHIUSURA A CHIAVE

MASTER DE



TOP IN ACCIAIO INOX SATINATO

Il top in acciaio inox satinato permette di effettuare lavorazioni e interventi senza danneggiare l'armadio. Presenta un elevato livello di resistenza alla corrosione e al calore.



TOP IN MULTIPLEX

Il top in multiplex trasforma la parte superiore dell'armadio in un piano di lavoro solido e robusto. È resistente a urti e graffi ed è adatto per operazioni pesanti.



TOP IN ACCIAIO GOMMATO

Il top è realizzato in acciaio zincato e rivestito con gomma antiolio. È particolarmente indicato in caso di uso di oli o per interventi che impiegano strumenti da taglio.



TOP A 3 BORDI RIVESTITO IN PVC

Il top a 3 bordi rivestito in PVC protegge la parte superiore dell'armadio e, grazie ai bordi rialzati, evita la caduta del materiale posizionato su di esso.



ZOCOLI

Gli zoccoli hanno una duplice funzione: rialzano l'armadio a cassetti dal pavimento e ne permettono la movimentazione tramite carrelli elevatori o transpallet.

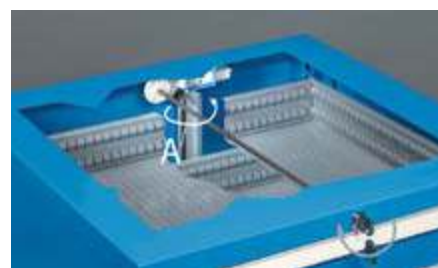

SERRATURA

La serratura a cilindro si collega tramite un'asta quadra al gruppo di chiusura posteriore composto di un elemento rotante in materiale plastico e un'asta di chiusura in lamiera di acciaio. Girando la chiave si aziona il sistema a camme del gruppo di chiusura che fa ruotare l'asta posteriore (A).



ESTRAZIONE TOTALE



LIBERTÀ NELLA CONFIGURAZIONE
Modifica velocemente e facilmente l'estrazione del cassetto per aumentare la portata fino a 100 kg.



GUIDE AD ALTE PRESTAZIONI



CORRERE SENZA PROBLEMI
Le guide lunghe come i cassetti permettono di spostare il cuscinetto nella parte frontale dell'armadio aumentando visibilità, portata ed estrazione.



CASSETTI FORATI



ORGANIZZAZIONE AL MILLIMETRO
Fori e scanalature sui cassetti facilitano la suddivisione interna del cassetto per una perfetta organizzazione di utensili e materiali.

MASTER DE

ESTRAZIONE E GESTIONE DEL CASSETTO

Il cassetto Master DE rappresenta una rivoluzione nel mondo dell'arredo industriale in quanto è stato ideato e sviluppato per essere personalizzato autonomamente in termini di estrazione/portata e suddivisione interna.



LIBERAMENTE CONFIGURABILE

La nuova guida ad **estrazione flessibile** permette la regolazione meccanica del fermo posteriore del cassetto/piano estraibile, in **3 diverse posizioni** ottenendo così **3 portate differenti: 50, 75, 100 kg**. Un'etichetta indica la portata massima del cassetto a seconda della sua estrazione e del tipo di guida.



GUIDA FLESSIBILE CONFIGURATA PER ESTRAZIONE TOTALE 50 KG

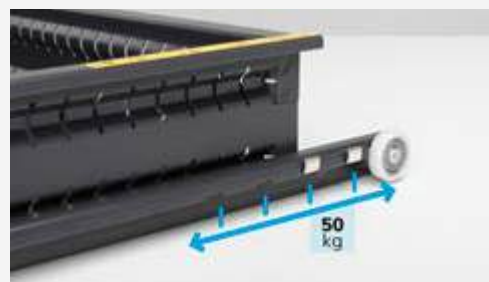
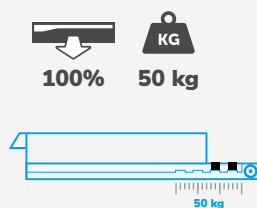

GUIDA FLESSIBILE CONFIGURATA PER ESTRAZIONE TOTALE 75 KG

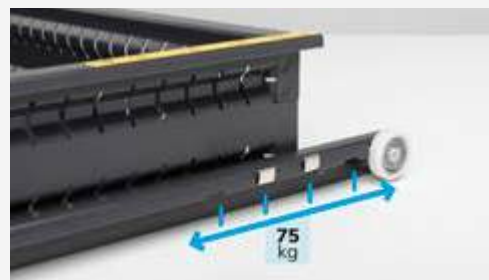
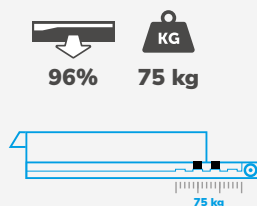

GUIDA FLESSIBILE CONFIGURATA PER ESTRAZIONE PARZIALE 100 KG

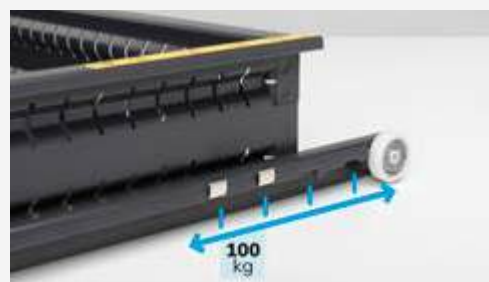
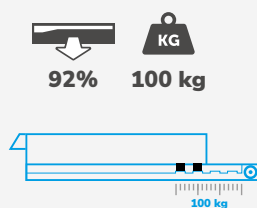

MASTER DE



Le innovazioni che semplificano l'identificazione dei contenuti all'interno dei cassetti.

Con la tecnologia Syfront di Sylogik® il frontale del cassetto non è più solo un elemento di chiusura, ma diventa una vera interfaccia visiva.

- Personalizzazione con elementi estetici e decorativi
- Input utente: etichette per la descrizione e catalogazione del contenuto
- Output utente: possibilità di inserire messaggi visivi o descrittivi sulla maniglia

MANIGLIE PERSONALIZZABILI

UNA MINIERA DI INFORMAZIONI

Inserisci nella maniglia codici a barre, etichette o immagini per conoscere velocemente il contenuto di ogni singolo cassetto.



COLORI

L'armadio Master DE è disponibile in 3 combinazioni di colore per il corpo armadio, mentre la maniglia è disponibile solo in Dark Grey.

ARMADIO



7016
7035



7035



5012

MANIGLIA FRONTALE



Dark Grey

LEGENDA

EH

36x36 EH **54x36 EH**

PR

Piano regolabile



Dimensioni armadio

L=	714	1020
P=	726	726



Dimensioni interne cassetto





L=	602	908
P=	602	602





CONFIGURE 

ARMADIO CON 6 CASSETTI 6X150





ART.	cassetti		RAL	€
	 KG			
 D33A100C01001PD	100-75-50	92-96-100%	7035+7016	846,92
 D33A100C0100108	100-75-50	92-96-100%	7035	846,92
 D33A100C0100104	100-75-50	92-96-100%	5012	871,72

H=1000 mm



CONFIGURE 

ARMADIO CON 7 CASSETTI 1X50 2X75 2X100 1X200 1X300





ART.	cassetti		RAL	€
	 KG			
 D33A100C01002PD	100-75-50	92-96-100%	7035+7016	891,25
 D33A100C0100208	100-75-50	92-96-100%	7035	891,25
 D33A100C0100204	100-75-50	92-96-100%	5012	955,42

H=1000 mm



CONFIGURE 

ARMADIO CON 8 CASSETTI 1X50 2X75 2X100 2X150 1X200





ART.	cassetti		RAL	€
	 KG			
 D33A100C01003PD	100-75-50	92-96-100%	7035+7016	963,79
 D33A100C0100308	100-75-50	92-96-100%	7035	963,79
 D33A100C0100304	100-75-50	92-96-100%	5012	1029,82

H=1000 mm



CONFIGURE 

ARMADIO CON 9 CASSETTI 9X100

ART.	cassetti		RAL	€
	 KG			
 D33A100C01004PD	100-75-50	92-96-100%	7035+7016	1033,85
 D33A100C0100408	100-75-50	92-96-100%	7035	1033,85
 D33A100C0100404	100-75-50	92-96-100%	5012	1106,08

H=1000 mm

MATERIALE DI SEPARAZIONE



ART.	adatto per cassetto H mm	componenti	€
FFH20051500	50/300	35 x Divisorio trasversale L=73 mm 16 x Divisorio a 2 canali	35,34



ART.	adatto per cassetto H mm	componenti	€
FFH20051600	50/300	50 x Divisorio trasversale L=47 mm 16 x Divisorio a 3 canali	37,82



ART.	adatto per cassetto H mm	componenti	€
FFH20051700	50/300	65 x Divisorio trasversale L=36 mm 16 x Divisorio a 4 canali	41,23



ART.	adatto per cassetto H mm	componenti	€
FFH20051200	50	16 x Cassetta divisorio 75x75 mm 16 x Cassetta divisorio 150x75 mm 4 x Cassetta divisorio 150x150 mm	36,58
FFH20071200	75		43,09



ART.	adatto per cassetto H mm	componenti	€
FFH20051300	50	16 x Cassetta divisorio 150x75 mm 8 x Cassetta divisorio 150x150 mm	31,93
FFH20071300	75		39,06
FFH20101300	100/125		45,57



ART.	adatto per cassetto H mm	componenti	€
FFH20050600	50	2 x Divisorio Longitudinale fessurato L=610 mm 3 x Divisorio trasversale L=202 mm	16,12
FFH20070600	75		15,50
FFH20100600	100/125		17,67
FFH20150600	150/175		23,87
FFH20200600	200/250		36,27
FFH20300600	300		63,86





CONFIGURE

ARMADIO CON 6 CASSETTI 6X150

ART.	cassetti		RAL	€
	KG			
D53A100C01001PD	100-75-50	92-96-100%	7035+7016	1005,95
D53A100C0100108	100-75-50	92-96-100%	7035	1005,95
D53A100C0100104	100-75-50	92-96-100%	5012	1113,83

H=1000 mm

CONFIGURE

ARMADIO CON 7 CASSETTI 1X50 2X75 2X100 1X200 1X300

ART.	cassetti		RAL	€
	KG			
D53A100C01002PD	100-75-50	92-96-100%	7035+7016	1069,81
D53A100C0100208	100-75-50	92-96-100%	7035	1069,81
D53A100C0100204	100-75-50	92-96-100%	5012	1198,15

H=1000 mm

CONFIGURE

ARMADIO CON 8 CASSETTI 1X50 2X75 2X100 2X150 1X200

ART.	cassetti		RAL	€
	KG			
D53A100C01003PD	100-75-50	92-96-100%	7035+7016	1149,17
D53A100C0100308	100-75-50	92-96-100%	7035	1149,17
D53A100C0100304	100-75-50	92-96-100%	5012	1309,13

H=1000 mm

CONFIGURE

ARMADIO CON PORTE 1XPR

ART.	n. porte	n. piano regolabile	RAL	€
D53A100C01005PD	2	1	7035+7016	576,29
D53A100C0100508	2	1	7035	576,29
D53A100C0100504	2	1	5012	576,29

H=1000 mm

CONFIGURE

ARMADIO CON PORTE 1XPR

ART.	n. porte	materiale porte	n. piano regolabile	RAL	€
D53A100C01006PD	2	Polycarbonato	1	7035+7016	692,23
D53A100C0100608	2	Polycarbonato	1	7035	692,23
D53A100C0100604	2	Polycarbonato	1	5012	692,23

H=1000 mm



MATERIALE DI SEPARAZIONE

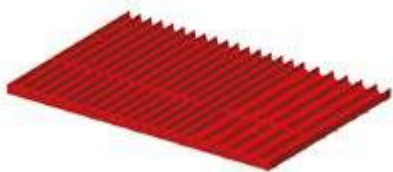

ART.	adatto per cassetto H mm	componenti	€
FFH50051900	50/300	30 x Divisorio trasversale L=36 mm 10 x Divisorio trasversale L=47 mm 8 x Divisorio a 3 canali 16 x Divisorio a 4 canali	50,22

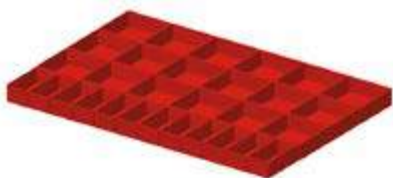

ART.	adatto per cassetto H mm	componenti	€
FFH50050800	50	12 x Cassetta divisorio 150x75 mm 18 x Cassetta divisorio 150x150 mm	44,95
FFH50070800	75		55,18
FFH50100800	100/125		62,00



ART.	adatto per cassetto H mm	componenti	€
FFH50051700	50	20 x Cassetta divisorio 75x75 mm 14 x Cassetta divisorio 150x75 mm 12 x Cassetta divisorio 150x150 mm	49,91
FFH50071700	75		59,83



ART.	adatto per cassetto H mm	componenti	€
FFH50051800	50	24 x Cassetta divisorio 150x150 mm	43,40
FFH50071800	75		53,32
FFH50101800	100/125		58,90



ART.	adatto per cassetto H mm	componenti	€
FFH50051300	50	5 x Divisorio longitudinale fessurato L=610 mm 12 x Divisorio trasversale L=151 mm	32,24
FFH50071300	75		24,80
FFH50101300	100/125		31,00
FFH50151300	150/175		44,95
FFH50201300	200/250		77,81
FFH50301300	300		167,09



ART.	adatto per cassetto H mm	componenti	€
FFH50050700	50	4 x Divisorio longitudinale fessurato L=610 mm 2 x Divisorio trasversale L=151 mm 3 x Divisorio trasversale L=202 mm	25,42
FFH50070700	75		23,56
FFH50100700	100/125		26,66
FFH50150700	150/175		31,00
FFH50200700	200/250		55,18
FFH50300700	300		124,31



MASTER DE

ACCESSORI



TOP A 3 BORDI RIVESTITO IN PVC

ART.	adatto per armadio EH	L mm	P mm	H mm	colore	€
M33T023AG003107	36x36	715	729	23	Nero	88,97
M53T023AG003107	54x36	1021	729	23	Nero	91,45



TOP IN ACCIAIO INOX

ART.	adatto per armadio EH	L mm	P mm	H mm	€
M33T030MDNX710A	36x36	714	726	31	189,41
M53T030MDNX710A	54x36	1020	726	31	237,46



TOP IN ACCIAIO GOMMATO

ART.	adatto per armadio EH	L mm	P mm	H mm	colore	€
M33T030MDGM7107	36x36	714	726	32	Nero	169,57
M53T030MDGM7107	54x36	1020	726	32	Nero	234,36



TOP IN MULTIPLEX

ART.	adatto per armadio EH	L mm	P mm	H mm	€
M33T030MU000100	36x36	714	726	30	106,64
M53T030MU000100	54x36	1020	726	30	128,03



ZOCCOLO PER CARRELLO ELEVATORE E TRANSPALLET

ART.	adatto per armadio EH	L mm	P mm	H mm	RAL	€
M33Z10010000039	36x36	712	722	100	7016	87,73



CHIUSURA PER ZOCCOLO

ART.	adatto per armadio L EH	L mm	P mm	H mm	RAL	€
M30Z10011000039	36	708	46	95	7016	17,36



COPPIA ZOCCOLI PER CARRELLO ELEVATORE E TRANSPALLET

ART.	adatto per armadio EH	L mm	P mm	H mm	RAL	€
M03Z10020000039	54x36	200	722	100	7016	69,75



CHIUSURA PER ZOCCOLO

ART.	adatto per armadio L EH	L mm	P mm	H mm	RAL	€
M50Z10021000039	54	1014	46	95	7016	25,11

MASTER DE



vedi pag. 316

RAL 7016

START

PRO

PRO+

CASSETTIERE PROFESSIONALI

MASTER



La cassettera porta utensili Master è versatile e può essere personalizzata in ogni minimo dettaglio per creare soluzioni che presentano non solo **cassetti o porte a battente e scorrevoli**, ma anche **piani estraibili e piani fessurati**. In base alla tipologia di guida installata su cassetti e piani è possibile avere un'**estrazione flessibile da 92 a 100%** con **portata tra i 50 e i 100 kg**, o un'**estrazione telescopica 100% con portata 200 kg**. Tutti i cassetti sono dotati di fori e fessure per l'installazione di **materiale di separazione e vassoi portautensili**, mentre il piano superiore può essere arricchito con **top** di vario tipo. La parte inferiore, invece, è predisposta per l'installazione di **ruote** oppure **zoccoli**.



**PORTATA CASSETTI
DA 50 A 200 KG**

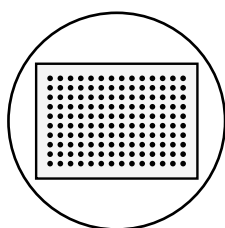

CASSETTI FORATI

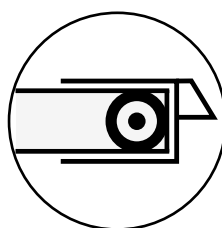

CUSCINETTI A SFERA

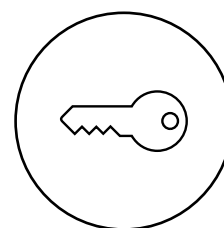

CHIUSURA A CHIAVE

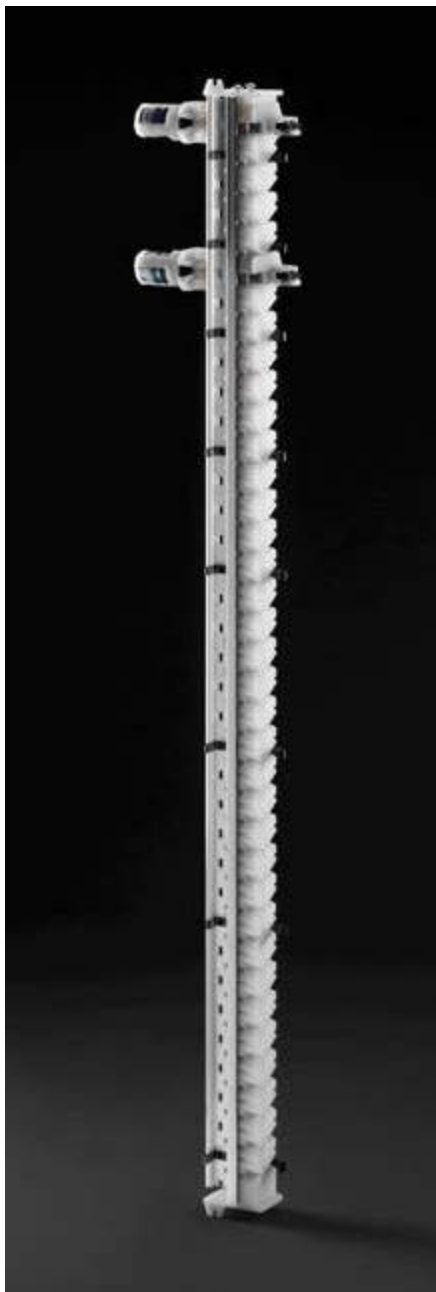

ASTA VERTEBRATA ANTIRIBALTAMENTO

L'asta è in profilato d'alluminio e rimane sempre fissa, senza ruotare.

Il movimento di chiusura è ottenuto da **tasselli che si spostano verticalmente** sfruttando una delle forze elementari della fisica: **la gravità. Più il movimento è semplice, meno probabilità di rotture ci sono.**

L'asta è forata a passo 25 mm e consente l'applicazione di più teste di chiusura. Questo permette di dividere l'accesso ai cassetti in più gruppi. La divisione dei gruppi è configurabile in altezza.

SISTEMA MECCANICO

Il sistema di comando meccanico del gruppo chiusura utilizza tecnologia Sylogik®. **Le differenze sono decisive.**

Il sistema di trasmissione dal cilindro della serratura alla testa dell'asta è costituito da fili di acciaio con guaina elastica e movimento lineare.

Rispetto ai comuni sistemi fissi ad asta quadra con movimento rotatorio, permette di svincolare il parallelismo della posizione del cilindro della serratura rispetto alla testa dell'asta. Questo consente al progettista di applicare il cilindro nel punto più idoneo dell'armadio.

Il cilindro della serratura è appoggiato a un tamburo di rinvio così da poter scegliere diverse case costruttrici di cilindri*.

In questo modo l'armadio può essere integrato con altri preesistenti mantenendo lo stesso tipo di chiave.



* Opzione a richiesta con sovrapprezzo



ESTRAZIONE TOTALE



LIBERTÀ NELLA CONFIGURAZIONE
Modifica velocemente e facilmente l'estrazione del cassetto per aumentare la portata fino a 100 kg.



GUIDE AD ALTE PRESTAZIONI



CORRERE SENZA PROBLEMI
Le guide lunghe come i cassetti permettono di spostare il cuscinetto nella parte frontale dell'armadio aumentando visibilità, portata ed estrazione.



CASSETTI FORATI



ORGANIZZAZIONE AL MILLIMETRO
Fori e scanalature sui cassetti facilitano la suddivisione interna del cassetto per una perfetta organizzazione di utensili e materiali.

MASTER

ESTRAZIONE E GESTIONE DEL CASSETTO

Il cassetto Master rappresenta una rivoluzione nel mondo dell'arredo industriale in quanto è stato ideato e sviluppato per essere personalizzato autonomamente in termini di estrazione/portata e suddivisione interna.



LIBERAMENTE CONFIGURABILE

La nuova guida ad **estrazione flessibile** permette la regolazione meccanica del fermo posteriore del cassetto/piano estraibile, in **3 diverse posizioni** ottenendo così **3 portate differenti: 50, 75, 100 kg**. L'installazione dell'innovativa **guida telescopica** aumenta la portata del **cassetto/piano estraibile fino a 200 kg**. Un'etichetta indica la portata massima del cassetto a seconda della sua estrazione e del tipo di guida.



GUIDA FLESSIBILE CONFIGURATA PER ESTRAZIONE TOTALE 50 KG

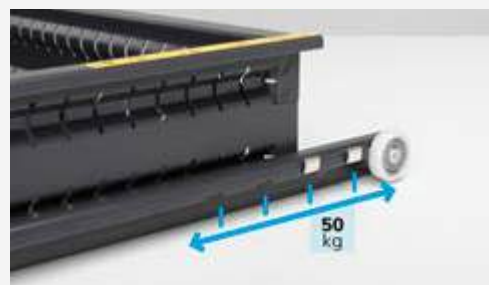
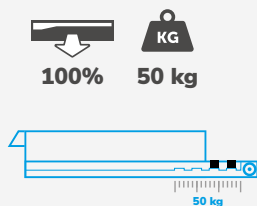

GUIDA FLESSIBILE CONFIGURATA PER ESTRAZIONE TOTALE 75 KG

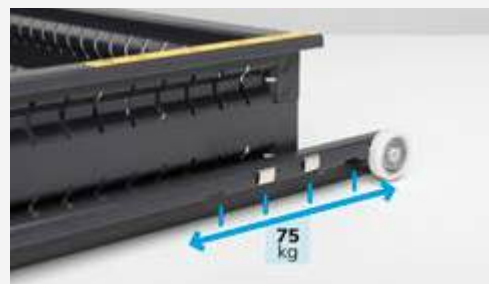
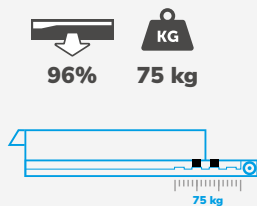

GUIDA FLESSIBILE CONFIGURATA PER ESTRAZIONE PARZIALE 100 KG

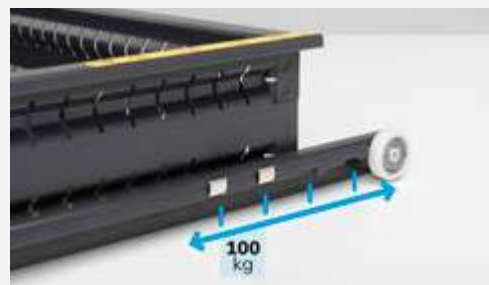
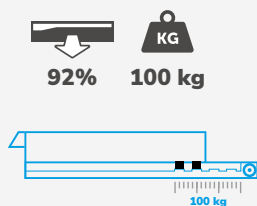

GUIDA TELESCOPICA CONFIGURATA PER ESTRAZIONE TOTALE 200 KG

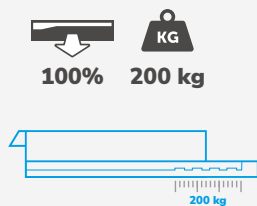

MASTER



Le innovazioni che semplificano l'identificazione dei contenuti all'interno dei cassetti.

Con la tecnologia Syfront di Sylogik® il frontale del cassetto non è più solo un elemento di chiusura, ma diventa una vera interfaccia visiva.

- Personalizzazione con elementi estetici e decorativi
- Input utente: etichette per la descrizione e catalogazione del contenuto
- Output utente: possibilità di inserire messaggi visivi o descrittivi sulla maniglia

MANIGLIE PERSONALIZZABILI

UNA MINIERA DI INFORMAZIONI

Inserisci nella maniglia codici a barre, etichette o immagini per conoscere velocemente il contenuto di ogni singolo cassetto.



MODULARITÀ

I diversi elementi che compongono la serie Master possono essere facilmente **integrati tra di loro per creare composizioni di arredo complete e pronte a tutto**. È possibile così creare, ad esempio, banconate con cassetti e porte corredate di piani a 4 bordi per effettuare manutenzioni e lavorazioni o per essere utilizzate come postazioni per accettazione clienti in negozi o magazzini.

Courtesy of Fridle Group



MASTER



TOP IN ACCIAIO INOX SATINATO

Il top in acciaio inox satinato permette di effettuare lavorazioni e interventi senza danneggiare l'armadio. Presenta un elevato livello di resistenza alla corrosione e al calore.



TOP IN MULTIPLEX

Il top in multiplex trasforma la parte superiore dell'armadio in un piano di lavoro solido e robusto. È resistente a urti e graffi ed è adatto per operazioni pesanti.



TOP IN ACCIAIO GOMMATO

Il top è realizzato in acciaio zincato e rivestito con gomma antiolio. È particolarmente indicato in caso di uso di oli o per interventi che impiegano strumenti da taglio.



TOP A 3 BORDI RIVESTITO IN PVC

Il top a 3 bordi rivestito in PVC protegge la parte superiore dell'armadio e, grazie ai bordi rialzati, evita la caduta del materiale posizionato su di esso.



ZOCOLI

Gli zoccoli hanno una duplice funzione: rialzano l'armadio a cassette dal pavimento e ne permettono la movimentazione tramite carrelli elevatori o transpallet.



RUOTE

Gli armadi possono essere forniti con ruote per trasformarli in pratici carrelli portautensili. Di serie sono allestiti con 2 ruote girevoli con freno e 2 ruote fisse.



SISTEMA ANTIELUSIVO

SICUREZZA AL PRIMO POSTO
Al contrario di altri armadi presenti in commercio, il sistema di chiusura brevettato non consente allo scassinatore di eludere la chiusura. In caso di apertura forzata l'effrazione è sempre visibile.



MANIGLIA ERGONOMICA REGOLABILE

Gli armadi con ruote sono forniti con una pratica maniglia ergonomica regolabile che può essere installata in due diverse posizioni. L'altezza della maniglia potrà, quindi, essere impostata a seconda dell'altezza stessa dell'utilizzatore per consentire una movimentazione agile e facile dell'armadio e il mantenimento di una postura ergonomica al fine di ridurre gli sforzi durante il lavoro che potrebbero comportare possibili infortuni.



MASTER

COLORI

L'armadio Master è disponibile in 12 combinazioni di colore a cui associare 8 diversi colori per le maniglie per creare soluzioni personalizzate nel minimo dettaglio. È possibile, quindi, assegnare a particolari aree di lavoro o progetti colori specifici oppure implementare il colore aziendale anche negli arredi installati in azienda.

10 colori RAL per la parte metallica
8 colori per gli accessori plastici

Combinazioni infinite

MANIGLIA FRONTALE



Dark Grey



Mediterranean Blue



Sky Blue



Glamour Red



Red Carpet



Juicy Orange



Sunny Yellow



Forest Green

ARMADIO



7016
7035



7035



5012



9002



7016



7000



5019



9010



6011



3003





5010



5012
7035

LEGENDA

EH		18x27 EH	27x27 EH	36x27 EH	54x27 EH	27x36 EH	36x36 EH	45x36 EH	54x36 EH	64x36 EH	78x36 EH	
	Dimensioni armadio	L=	408	561	714	1020	561	714	867	1020	1190	1428
		P=	573	573	573	573	726	726	726	726	726	726
	Dimensioni interne cassetto	L=	296	449	602	908	449	602	755	908	1078	1316
		P=	449	449	449	449	602	602	602	602	602	602

PE
Piano estraibile ad estrazione flessibile



PE
Piano estraibile ad estrazione telescopica



PR
Piano regolabile



PF
Piano regolabile fessurato





ARMADIO CON 3 CASSETTI 1X50 1X100 1X150



ART.	cassetti		RAL	€
	KG			
M12A040C01001PD	100-75-50	92-96-100%	7035+7016	566,06
M12A040C0100108	100-75-50	92-96-100%	7035	566,06
M12A040C0100104	100-75-50	92-96-100%	5012	594,27

CONFIGURE

H=400 mm



ARMADIO CON 3 CASSETTI 2X75 1X150



ART.	cassetti		RAL	€
	KG			
M12A040C01002PD	100-75-50	92-96-100%	7035+7016	548,70
M12A040C0100208	100-75-50	92-96-100%	7035	548,70
M12A040C0100204	100-75-50	92-96-100%	5012	580,32

CONFIGURE

H=400 mm



ARMADIO CON 4 CASSETTI 1X50 2X75 1X100



ART.	cassetti		RAL	€
	KG			
M12A040C01003PD	100-75-50	92-96-100%	7035+7016	636,12
M12A040C0100308	100-75-50	92-96-100%	7035	636,12
M12A040C0100304	100-75-50	92-96-100%	5012	680,14

CONFIGURE

H=400 mm



ARMADIO CON 4 CASSETTI 2X75 1X150 1X200



ART.	cassetti		RAL	€
	KG			
M12A060C01020PD	100-75-50	92-96-100%	7035+7016	664,02
M12A060C0102008	100-75-50	92-96-100%	7035	664,02
M12A060C0102004	100-75-50	92-96-100%	5012	699,36

CONFIGURE

H=600 mm



ARMADIO CON 3 CASSETTI 1X100 1X200 1X300



ART.	cassetti		RAL	€
	KG			
M12A070C01029PD	100-75-50	92-96-100%	7035+7016	635,50
M12A070C0102908	100-75-50	92-96-100%	7035	635,50
M12A070C0102904	100-75-50	92-96-100%	5012	652,55

CONFIGURE

H=700 mm



ARMADIO CON 5 CASSETTI 2X75 3X150

ART.	cassetti		RAL	€
	KG			
M12A070C01035PD	100-75-50	92-96-100%	7035+7016	758,88
M12A070C0103508	100-75-50	92-96-100%	7035	758,88
M12A070C0103504	100-75-50	92-96-100%	5012	806,62

CONFIGURE

H=700 mm



ARMADIO CON RUOTE CON 4 CASSETTI 2X75 1X150 1X200

ART.	cassetti		RAL	€
	KG			
M12R060C01020PD	100-75-50	92-96-100%	7035+7016	838,24
M12R060C0102008	100-75-50	92-96-100%	7035	838,24
M12R060C0102004	100-75-50	92-96-100%	5012	873,27

CONFIGURE

H=822 mm

Ruote: Gomma standard Ø 125 mm
Portata armadio: 300 kg



ARMADIO CON RUOTE CON 5 CASSETTI 1X50 2X75 1X100 1X200

ART.	cassetti		RAL	€
	KG			
M12R060C01021PD	100-75-50	92-96-100%	7035+7016	925,97
M12R060C0102108	100-75-50	92-96-100%	7035	925,97
M12R060C0102104	100-75-50	92-96-100%	5012	973,40

CONFIGURE

H=822 mm

Ruote: Gomma standard Ø 125 mm
Portata armadio: 300 kg



ARMADIO CON RUOTE CON 6 CASSETTI 2X50 2X75 1X150 1X200

ART.	cassetti		RAL	€
	KG			
M12R070C010SSPD	100-75-50	92-96-100%	7035+7016	1025,17
M12R070C010SS08	100-75-50	92-96-100%	7035	1025,17
M12R070C010SS04	100-75-50	92-96-100%	5012	1080,97

CONFIGURE

H=922 mm

Ruote: Gomma standard Ø 125 mm
Portata armadio: 300 kg



DIM. INTERNE LxP



PORTATA



ESTRAZIONE



RAL 7035 + RAL 7016



RAL 5012



RAL 7035



MATERIALE DI SEPARAZIONE



ART.	adatto per cassetto H mm	componenti	€
FFH82050200	50/300	16 x Divisorio trasversale L=36 mm 7 x Divisorio trasversale L=47 mm 3 x Divisorio a 3 canali 3 x Divisorio a 4 canali	16,12



ART.	adatto per cassetto H mm	componenti	€
FFH82050300	50/300	15 x Divisorio trasversale L=47 mm 8 x Divisorio trasversale L=73 mm 3 x Divisorio a 2 canali 3 x Divisorio a 3 canali	16,43



ART.	adatto per cassetto H mm	componenti	€
FFH82050400	50/300	18 x Divisorio trasversale L=73 mm 6 x Divisorio a 2 canali	13,02



ART.	adatto per cassetto H mm	componenti	€
FFH80050800	50	2 x Divisorio trasversale L=151 mm 1 x Divisorio longitudinale fessurato L=457 mm	9,92
FFH80070800	75		9,61
FFH80100800	100/125		10,54
FFH80150800	150/175		12,71
FFH80200800	200/250		16,43
FFH80300800	300		26,66



ART.	adatto per cassetto H mm	componenti	€
FFH80050900	50	2 x Divisorio longitudinale fessurato L=457 mm 6 x Divisorio trasversale L=100 mm	15,81
FFH80070900	75		14,57
FFH80100900	100/125		17,05
FFH80150900	150/175		22,01



ART.	adatto per cassetto H mm	componenti	€
FFH84051300	50	2 x Divisorio longitudinale non fessurato L=457 mm	10,85
FFH84071300	75		9,92
FFH84101300	100/125		11,16
FFH84151300	150/175		12,71
FFH84201300	200/250		13,64



MATERIALE DI SEPARAZIONE



ART.	adatto per cassetto H mm	componenti	€
FFH82051800	50	4 x Cassetta divisorio 150x75 mm 4 x Cassetta divisorio 150x150 mm	13,95
FFH82071800	75		15,50
FFH82101800	100/125		17,05



ART.	adatto per cassetto H mm	componenti	€
FFH82051700	50	4 x Cassetta divisorio 75x75 mm 6 x Cassetta divisorio 150x75 mm 2 x Cassetta divisorio 150x150 mm	15,19
FFH82071700	75		16,74

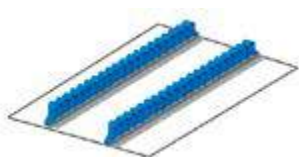

ART.	adatto per cassetto H mm	componenti	€
FFH86051900	50/300	2 x Portautensili multiuso	19,84





ARMADIO CON 2 CASSETTI 1X100 1X200



ART.	cassetti		RAL	€
	KG			
M22A040C01004PD	100-75-50	92-96-100%	7035+7016	432,14
M22A040C0100408	100-75-50	92-96-100%	7035	432,14
M22A040C0100404	100-75-50	92-96-100%	5012	453,22

CONFIGURE

H=400 mm



ARMADIO CON 3 CASSETTI 1X50 1X100 1X150



ART.	cassetti		RAL	€
	KG			
M22A040C01001PD	100-75-50	92-96-100%	7035+7016	498,79
M22A040C0100108	100-75-50	92-96-100%	7035	498,79
M22A040C0100104	100-75-50	92-96-100%	5012	533,51

CONFIGURE

H=400 mm



ARMADIO CON 4 CASSETTI 1X50 2X75 1X100



ART.	cassetti		RAL	€
	KG			
M22A040C01003PD	100-75-50	92-96-100%	7035+7016	561,10
M22A040C0100308	100-75-50	92-96-100%	7035	561,10
M22A040C0100304	100-75-50	92-96-100%	5012	614,73

CONFIGURE

H=400 mm



ARMADIO CON 6 CASSETTI 1X50 2X75 2X100 1X200



ART.	cassetti		RAL	€
	KG			
M22A070C01032PD	100-75-50	92-96-100%	7035+7016	763,84
M22A070C0103208	100-75-50	92-96-100%	7035	763,84
M22A070C0103204	100-75-50	92-96-100%	5012	838,55

CONFIGURE

H=700 mm



ARMADIO CON 4 CASSETTI 2X100 1X200 1X300



ART.	cassetti		RAL	€
	KG			
M22A080C01055PD	100-75-50	92-96-100%	7035+7016	664,02
M22A080C0105508	100-75-50	92-96-100%	7035	664,02
M22A080C0105504	100-75-50	92-96-100%	5012	701,22

CONFIGURE

H=800 mm



CONFIGURE

ARMADIO CON 5 CASSETTI 1X50 2X100 1X150 1X300



ART.	cassetti		RAL	€
M22A080C01054PD	100-75-50	92-96-100%	7035+7016	730,67
M22A080C0105408	100-75-50	92-96-100%	7035	730,67
M22A080C0105404	100-75-50	92-96-100%	5012	781,51

H=800 mm



CONFIGURE

ARMADIO CON 4 CASSETTI 1X100 1X150 1X200 1X300



ART.	cassetti		RAL	€
M22A085C01092PD	100-75-50	92-96-100%	7035+7016	673,94
M22A085C0109208	100-75-50	92-96-100%	7035	673,94
M22A085C0109204	100-75-50	92-96-100%	5012	708,66

H=850 mm



CONFIGURE

ARMADIO CON 5 CASSETTI 1X100 3X150 1X200



ART.	cassetti		RAL	€
M22A085C01088PD	100-75-50	92-96-100%	7035+7016	740,90
M22A085C0108808	100-75-50	92-96-100%	7035	740,90
M22A085C0108804	100-75-50	92-96-100%	5012	789,57

H=850 mm



CONFIGURE

ARMADIO CON 6 CASSETTI 2X75 2X100 2X200



ART.	cassetti		RAL	€
M22A085C01089PD	100-75-50	92-96-100%	7035+7016	805,38
M22A085C0108908	100-75-50	92-96-100%	7035	805,38
M22A085C0108904	100-75-50	92-96-100%	5012	875,44

H=850 mm



CONFIGURE

ARMADIO CON 6 CASSETTI 1X50 2X100 2X150 1X200



ART.	cassetti		RAL	€
M22A085C01091PD	100-75-50	92-96-100%	7035+7016	809,72
M22A085C0109108	100-75-50	92-96-100%	7035	809,72
M22A085C0109104	100-75-50	92-96-100%	5012	874,82

H=850 mm



DIM. INTERNE LxP



PORTATA



ESTRAZIONE



RAL 7035 + RAL 7016



RAL 5012



RAL 7035



CONFIGURE

ARMADIO CON 7 CASSETTI 2X75 3X100 2X150

ART.	cassetti		RAL	€
M22A085C01095PD	100-75-50	92-96-100%	7035+7016	875,44
M22A085C0109508	100-75-50	92-96-100%	7035	875,44
M22A085C0109504	100-75-50	92-96-100%	5012	957,59

H=850 mm



CONFIGURE

ARMADIO CON 8 CASSETTI 1X50 2X75 4X100 1X150

ART.	cassetti		RAL	€
M22A085C01087PD	100-75-50	92-96-100%	7035+7016	944,57
M22A085C0108708	100-75-50	92-96-100%	7035	944,57
M22A085C0108704	100-75-50	92-96-100%	5012	1042,84

H=850 mm



CONFIGURE

ARMADIO CON RUOTE CON 4 CASSETTI 2X75 1X150 1X200

ART.	cassetti		RAL	€
M22R060C01020PD	100-75-50	92-96-100%	7035+7016	837,00
M22R060C0102008	100-75-50	92-96-100%	7035	837,00
M22R060C0102004	100-75-50	92-96-100%	5012	883,50

H=822 mm

Ruote: Gomma standard Ø 125 mm
Portata armadio: 300 kg



CONFIGURE

ARMADIO CON RUOTE CON 5 CASSETTI 1X50 2X75 1X100 1X200

ART.	cassetti		RAL	€
M22R060C01021PD	100-75-50	92-96-100%	7035+7016	905,82
M22R060C0102108	100-75-50	92-96-100%	7035	905,82
M22R060C0102104	100-75-50	92-96-100%	5012	968,75

H=822 mm

Ruote: Gomma standard Ø 125 mm
Portata armadio: 300 kg



CONFIGURE

ARMADIO CON RUOTE CON 6 CASSETTI 2X50 2X75 1X150 1X200

ART.	cassetti		RAL	€
M22R070C010SSPD	100-75-50	92-96-100%	7035+7016	951,08
M22R070C010SS08	100-75-50	92-96-100%	7035	951,08
M22R070C010SS04	100-75-50	92-96-100%	5012	1025,17

H=922 mm

Ruote: Gomma standard Ø 125 mm
Portata armadio: 300 kg



CONFIGURE

ARMADIO CON RUOTE CON 5 CASSETTI 4X100 1X200

ART.	cassetti		RAL	€
	KG	ESTRAZIONE		
M22R070C010GFPD	100-75-50	92-96-100%	7035+7016	900,24
M22R070C010GF08	100-75-50	92-96-100%	7035	900,24
M22R070C010GF04	100-75-50	92-96-100%	5012	956,97

H=922 mm

Ruote: Gomma standard Ø 125 mm
Portata armadio: 300 kg



CONFIGURE

ARMADIO CON RUOTE CON 6 CASSETTI 1X50 2X75 2X100 1X200

ART.	cassetti		RAL	€
	KG	ESTRAZIONE		
M22R070C01032PD	100-75-50	92-96-100%	7035+7016	956,97
M22R070C0103208	100-75-50	92-96-100%	7035	956,97
M22R070C0103204	100-75-50	92-96-100%	5012	1031,68

H=922 mm

Ruote: Gomma standard Ø 125 mm
Portata armadio: 300 kg



CONFIGURE

ARMADIO CON RUOTE CON 6 CASSETTI 2X75 3X100 1X150

ART.	cassetti		RAL	€
	KG	ESTRAZIONE		
M22R070C01044PD	100-75-50	92-96-100%	7035+7016	960,38
M22R070C0104408	100-75-50	92-96-100%	7035	960,38
M22R070C0104404	100-75-50	92-96-100%	5012	1033,23

H=922 mm

Ruote: Gomma standard Ø 125 mm
Portata armadio: 300 kg



DIM. INTERNE LxP



PORTATA



ESTRAZIONE



RAL 7035 + RAL 7016



RAL 5012



RAL 7035



MATERIALE DI SEPARAZIONE



ART.	adatto per cassetto H mm	componenti	€
FFH84050200	50/300	16 x Divisorio trasversale L=36 mm 7 x Divisorio trasversale L=47 mm 6 x Divisorio a 3 canali 3 x Divisorio a 4 canali	22,63



ART.	adatto per cassetto H mm	componenti	€
FFH84050300	50/300	15 x Divisorio trasversale L=47 mm 8 x Divisorio trasversale L=73 mm 6 x Divisorio a 2 canali 3 x Divisorio a 3 canali	22,63



ART.	adatto per cassetto H mm	componenti	€
FFH84050400	50/300	18 x Divisorio trasversale L=73 mm 9 x Divisorio a 2 canali	21,70



ART.	adatto per cassetto H mm	componenti	€
FFH84050800	50	2 x Divisorio longitudinale fessurato L=457 mm 3 x Divisorio trasversale L=151 mm	13,33
FFH84070800	75		13,33
FFH84100800	100/125		16,43
FFH84150800	150/175		21,08
FFH84200800	200/250		30,69
FFH84300800	300		47,43



ART.	adatto per cassetto H mm	componenti	€
FFH84050900	50	2 x Divisorio longitudinale fessurato L=457 mm 7 x Divisorio trasversale L=151 mm	16,43
FFH84070900	75		15,50
FFH84100900	100/125		17,98
FFH84150900	150/175		22,94
FFH84200900	200/250		31,62

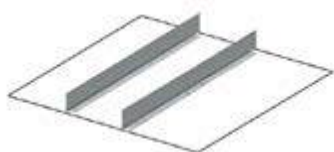

ART.	adatto per cassetto H mm	componenti	€
FFH84051300	50	2 x Divisorio longitudinale non fessurato L=457 mm	10,85
FFH84071300	75		9,92
FFH84101300	100/125		11,16
FFH84151300	150/175		12,71
FFH84201300	200/250		13,64



MATERIALE DI SEPARAZIONE



ART.	adatto per cassetto H mm	componenti	€
FFH84051700	50	8 x Cassetta divisorio 75x75 mm 6 x Cassetta divisorio 150x75 mm 4 x Cassetta divisorio 150x150 mm	21,08
FFH84071700	75		23,25



ART.	adatto per cassetto H mm	componenti	€
FFH84051800	50	6 x Cassetta divisorio 150x75 mm 6 x Cassetta divisorio 150x150 mm	19,53
FFH84071800	75		23,25
FFH84101800	100/125		25,42

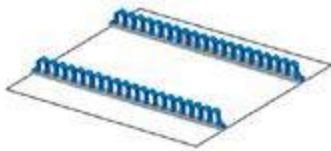

ART.	adatto per cassetto H mm	componenti	€
FFH86051900	50/300	2 x Portautensili multiuso	19,84





CONFIGURE

ARMADIO CON 5 CASSETTI 1X50 2X100 1X150 1X200



ART.	cassetti		RAL	€
M32A070C01040PD	100-75-50	92-96-100%	7035+7016	796,70
M32A070C0104008	100-75-50	92-96-100%	7035	796,70
M32A070C0104004	100-75-50	92-96-100%	5012	860,56

H=700 mm



CONFIGURE

ARMADIO CON 5 CASSETTI 2X75 2X100 1X250



ART.	cassetti		RAL	€
M32A070C01042PD	100-75-50	92-96-100%	7035+7016	789,57
M32A070C0104208	100-75-50	92-96-100%	7035	789,57
M32A070C0104204	100-75-50	92-96-100%	5012	862,73

H=700 mm



CONFIGURE

ARMADIO CON 6 CASSETTI 2X75 3X100 1X150



ART.	cassetti		RAL	€
M32A070C01044PD	100-75-50	92-96-100%	7035+7016	859,32
M32A070C0104408	100-75-50	92-96-100%	7035	859,32
M32A070C0104404	100-75-50	92-96-100%	5012	942,40

H=700 mm



CONFIGURE

ARMADIO CON 7 CASSETTI 1X50 2X75 2X100 1X150 1X200



ART.	cassetti		RAL	€
M32A085C010AEPD	100-75-50	92-96-100%	7035+7016	966,58
M32A085C010AE08	100-75-50	92-96-100%	7035	966,58
M32A085C010AE04	100-75-50	92-96-100%	5012	1060,51

H=850 mm



CONFIGURE

ARMADIO CON 7 CASSETTI 2X75 2X100 2X125 1X150



ART.	cassetti		RAL	€
M32A085C010ACPD	100-75-50	92-96-100%	7035+7016	964,10
M32A085C010AC08	100-75-50	92-96-100%	7035	964,10
M32A085C010AC04	100-75-50	92-96-100%	5012	1058,65

H=850 mm



ARMADIO CON 8 CASSETTI 4X75 3X100 1X150



ART.	cassetti		RAL	€
	KG			
M32A085C010AGPD	100-75-50	92-96-100%	7035+7016	1029,20
M32A085C010AG08	100-75-50	92-96-100%	7035	1029,20
M32A085C010AG04	100-75-50	92-96-100%	5012	1142,04

CONFIGURE

H=850 mm



ARMADIO CON 7 CASSETTI 1X50 2X75 2X100 1X200 1X300

ART.	cassetti		RAL	€
	KG			
M32A100C010BNPD	100-75-50	92-96-100%	7035+7016	1002,54
M32A100C010BN08	100-75-50	92-96-100%	7035	1002,54
M32A100C010BN04	100-75-50	92-96-100%	5012	1101,12

CONFIGURE

H=1000 mm



ARMADIO CON 7 CASSETTI 2X75 1X100 3X150 1X200

ART.	cassetti		RAL	€
	KG			
M32A100C010AWPD	100-75-50	92-96-100%	7035+7016	998,51
M32A100C010AW08	100-75-50	92-96-100%	7035	998,51
M32A100C010AW04	100-75-50	92-96-100%	5012	1082,83

CONFIGURE

H=1000 mm



ARMADIO CON 8 CASSETTI 1X50 2X75 3X100 1X150 1X250

ART.	cassetti		RAL	€
	KG			
M32A100C010BQPD	100-75-50	92-96-100%	7035+7016	1075,39
M32A100C010BQ08	100-75-50	92-96-100%	7035	1075,39
M32A100C010BQ04	100-75-50	92-96-100%	5012	1187,92

CONFIGURE

H=1000 mm



DIM. INTERNE LxP



PORTATA



ESTRAZIONE



RAL 7035 + RAL 7016



RAL 5012



RAL 7035



ARMADIO CON PORTE CON 1 CASSETTO 1X75 2XPE

ART.	cassetti / piani estraibili		RAL	€
	KG			
M32A100C010BUPD	100-75-50	92-96-100%	7035+7016	851,88
M32A100C010BU08	100-75-50	92-96-100%	7035	851,88
M32A100C010BU04	100-75-50	92-96-100%	5012	894,97
M32A100C010BVPD	200	100%	7035+7016	947,67
M32A100C010BV08	200	100%	7035	947,67
M32A100C010BV04	200	100%	5012	990,76

H=1022 mm

CONFIGURE



ARMADIO CON PORTE CON 2 CASSETTI 2X75 1XPE

ART.	cassetti / piani estraibili		RAL	€
	KG			
M32A100C010BWPD	100-75-50	92-96-100%	7035+7016	831,11
M32A100C010BW08	100-75-50	92-96-100%	7035	831,11
M32A100C010BW04	100-75-50	92-96-100%	5012	875,13
M32A100C010BXPD	200	100%	7035+7016	926,90
M32A100C010BX08	200	100%	7035	926,90
M32A100C010BX04	200	100%	5012	970,92

H=1022 mm

CONFIGURE



ARMADIO CON PORTE CON 3 CASSETTI 3X75 1XPE

ART.	cassetti / piani estraibili		RAL	€
	KG			
M32A100C010BYPD	100-75-50	92-96-100%	7035+7016	911,40
M32A100C010BY08	100-75-50	92-96-100%	7035	911,40
M32A100C010BY04	100-75-50	92-96-100%	5012	970,30
M32A100C010BZPD	200	100%	7035+7016	1039,12
M32A100C010BZ08	200	100%	7035	1039,12
M32A100C010BZ04	200	100%	5012	1098,02

H=1022 mm

CONFIGURE



ARMADIO CON PORTE CON 3 CASSETTI 3X75 2XPE

ART.	cassetti / piani estraibili		RAL	€
	KG			
M32A100C010CAPD	100-75-50	92-96-100%	7035+7016	1012,15
M32A100C010CA08	100-75-50	92-96-100%	7035	1012,15
M32A100C010CA04	100-75-50	92-96-100%	5012	1085,31
M32A100C010CBPD	200	100%	7035+7016	1171,80
M32A100C010CB08	200	100%	7035	1171,80
M32A100C010CB04	200	100%	5012	1244,96

H=1022 mm

CONFIGURE



ARMADIO CON PORTE CON 4 CASSETTI 4X75



ART.	cassetti		RAL	€
M32A100C010CCPD	100-75-50	92-96-100%	7035+7016	890,63
M32A100C010CC08	100-75-50	92-96-100%	7035	890,63
M32A100C010CC04	100-75-50	92-96-100%	5012	950,46
M32A100C010CDPD	200	100%	7035+7016	1018,35
M32A100C010CD08	200	100%	7035	1018,35
M32A100C010CD04	200	100%	5012	1078,18

CONFIGURE

H=1022 mm



ART.	cassetti		RAL	€
M32A100C010CEPD	100-75-50	92-96-100%	7035+7016	970,61
M32A100C010CE08	100-75-50	92-96-100%	7035	970,61
M32A100C010CE04	100-75-50	92-96-100%	5012	1045,63
M32A100C010CFPD	200	100%	7035+7016	1130,26
M32A100C010CF08	200	100%	7035	1130,26
M32A100C010CF04	200	100%	5012	1205,28

CONFIGURE

H=1022 mm



ARMADIO CON PORTE SCORREVOLI CON 2 CASSETTI 2X75 6XPE

ART.	cassetti / piani estraibili		RAL	€
M32D100C010GWPD	100-75-50	92-96-100%	7035+7016	2089,40
M32D100C010GW08	100-75-50	92-96-100%	7035	2089,40
M32D100C010GW04	100-75-50	92-96-100%	5012	2203,79
M32D100C010GXPD	200	100%	7035+7016	2344,84
M32D100C010GX08	200	100%	7035	2344,84
M32D100C010GX04	200	100%	5012	2459,23

CONFIGURE

H=1022 mm



ARMADIO CON PORTE SCORREVOLI CON 4 CASSETTI 4X75 2XPE

ART.	cassetti / piani estraibili		RAL	€
M32D100C010GYPD	100-75-50	92-96-100%	7035+7016	1846,05
M32D100C010GY08	100-75-50	92-96-100%	7035	1846,05
M32D100C010GY04	100-75-50	92-96-100%	5012	1934,40
M32D100C010GZPD	200	100%	7035+7016	2037,63
M32D100C010GZ08	200	100%	7035	2037,63
M32D100C010GZ04	200	100%	5012	2125,98

CONFIGURE

H=1022 mm





ARMADIO CON PORTE SCORREVOLI CON 6 CASSETTI 6X75 2XPE



ART.	cassetti / piani estraibili		RAL	€
M32D100C010HAPD	100-75-50	92-96-100%	7035+7016	2006,63
M32D100C010HA08	100-75-50	92-96-100%	7035	2006,63
M32D100C010HA04	100-75-50	92-96-100%	5012	2124,74
M32D100C010HBPD	200	100%	7035+7016	2262,07
M32D100C010HB08	200	100%	7035	2262,07
M32D100C010HB04	200	100%	5012	2380,18

CONFIGURE

H=1022 mm

ARMADIO CON PORTE SCORREVOLI CON 8 CASSETTI 8X75



ART.	cassetti		RAL	€
M32D100C010HNPDP	100-75-50	92-96-100%	7035+7016	1965,09
M32D100C010HN08	100-75-50	92-96-100%	7035	1965,09
M32D100C010HN04	100-75-50	92-96-100%	5012	2085,06
M32D100C010HPPDP	200	100%	7035+7016	2220,53
M32D100C010HP08	200	100%	7035	2220,53
M32D100C010HP04	200	100%	5012	2340,50

CONFIGURE

H=1022 mm

ARMADIO CON PORTE SCORREVOLI CON 4 CASSETTI 4X75 4XPE



ART.	cassetti / piani estraibili		RAL	€
M32D100C010HEPD	100-75-50	92-96-100%	7035+7016	2047,86
M32D100C010HE08	100-75-50	92-96-100%	7035	2047,86
M32D100C010HE04	100-75-50	92-96-100%	5012	2164,11
M32D100C010HFPD	200	100%	7035+7016	2303,30
M32D100C010HF08	200	100%	7035	2303,30
M32D100C010HF04	200	100%	5012	2419,55

CONFIGURE

H=1022 mm

ARMADIO CON PORTE SCORREVOLI CON 10 CASSETTI 10X75



ART.	cassetti		RAL	€
M32D100C010HJPD	100-75-50	92-96-100%	7035+7016	2125,36
M32D100C010HJ08	100-75-50	92-96-100%	7035	2125,36
M32D100C010HJ04	100-75-50	92-96-100%	5012	2275,40
M32D100C010HKPD	200	100%	7035+7016	2444,66
M32D100C010HK08	200	100%	7035	2444,66
M32D100C010HK04	200	100%	5012	2594,70

CONFIGURE

H=1022 mm



ARMADIO CON 7 CASSETTI 2XPR 2X75 1X100 3X150 1X200

ART.	cassetti		RAL	€
	KG			
M32A200C010FSPD	100-75-50	92-96-100%	7035+7016	1380,43
M32A200C010FS08	100-75-50	92-96-100%	7035	1380,43
M32A200C010FS04	100-75-50	92-96-100%	5012	1464,75
M32A200C010FTPD	200	100%	7035+7016	1603,94
M32A200C010FT08	200	100%	7035	1603,94
M32A200C010FT04	200	100%	5012	1688,26

H=2000 mm

CONFIGURE



ARMADIO CON PORTE CON 3 CASSETTI 2XPR 2X100 1X150 2XPE

ART.	cassetti / piani estraibili		RAL	€
	KG			
M32A200C010FWPD	100-75-50	92-96-100%	7035+7016	1430,34
M32A200C010FW08	100-75-50	92-96-100%	7035	1430,34
M32A200C010FW04	100-75-50	92-96-100%	5012	1497,30
M32A200C010FXPD	200	100%	7035+7016	1589,99
M32A200C010FX08	200	100%	7035	1589,99
M32A200C010FX04	200	100%	5012	1656,95

H=2000 mm

CONFIGURE



ARMADIO CON PORTA CON 7 CASSETTI 2XPR 2X75 1X100 3X150 1X200

ART.	cassetti		RAL	€
	KG			
M32A200C010TAPD	100-75-50	92-96-100%	7035+7016	1520,86
M32A200C010TA08	100-75-50	92-96-100%	7035	1520,86
M32A200C010TA04	100-75-50	92-96-100%	5012	1605,18
M32A200C010TBPD	200	100%	7035+7016	1744,37
M32A200C010TB08	200	100%	7035	1744,37
M32A200C010TB04	200	100%	5012	1828,69

H=2000 mm





CONFIGURE

ARMADIO CON RUOTE CON 5 CASSETTI 1X50 2X100 1X150 1X200



ART.	cassetti		RAL	€
M32R070C01040PD	100-75-50	92-96-100%	7035+7016	999,13
M32R070C0104008	100-75-50	92-96-100%	7035	999,13
M32R070C0104004	100-75-50	92-96-100%	5012	1062,99

H=922 mm

Ruote: Gomma standard Ø 125 mm
Portata armadio: 300 kg



CONFIGURE

ARMADIO CON RUOTE CON 5 CASSETTI 2X75 2X100 1X250



ART.	cassetti		RAL	€
M32R070C01042PD	100-75-50	92-96-100%	7035+7016	992,31
M32R070C0104208	100-75-50	92-96-100%	7035	992,31
M32R070C0104204	100-75-50	92-96-100%	5012	1065,47

H=922 mm

Ruote: Gomma standard Ø 125 mm
Portata armadio: 300 kg



CONFIGURE

ARMADIO CON RUOTE CON 6 CASSETTI 2X75 3X100 1X150



ART.	cassetti		RAL	€
M32R070C01044PD	100-75-50	92-96-100%	7035+7016	1061,75
M32R070C0104408	100-75-50	92-96-100%	7035	1061,75
M32R070C0104404	100-75-50	92-96-100%	5012	1144,83

H=922 mm

Ruote: Gomma standard Ø 125 mm
Portata armadio: 300 kg



CASSETTO H 50 mm

Set composto da 12 divisori a 4 canali e 65 divisori trasversali 36 mm



CASSETTO H 75 mm

Set di predisposizione per termoformati



CASSETTO H 200 mm

Set composto da 2 divisori longitudinali fessurati 455 mm e 3 divisori trasversali 200 mm



CASSETTO H 300 mm

Set composto da 1 divisorio longitudinale fessurato 455 mm

Utensili e termoformati esclusi



DIM. INTERNE LxP



PORTATA



ESTRAZIONE



RAL 7035 + RAL 7016



RAL 5012



RAL 7035



MATERIALE DI SEPARAZIONE



ART.	adatto per cassetto H mm	componenti	€
FFH10051500	50/300	20 x Divisorio trasversale L=36 mm 20 x Divisorio trasversale L=47 mm 6 x Divisorio a 3 canali 5 x Divisorio a 4 canali 1 x Porta chiavi a brugola	31,93



ART.	adatto per cassetto H mm	componenti	€
FFH10051000	50/300	3 x Divisorio a 3 canali 9 x Divisorio a 4 canali 12 x Divisorio trasversale L=47 mm 36 x Divisorio trasversale L=36 mm	31,93



ART.	adatto per cassetto H mm	componenti	€
FFH10051300	50/300	18 x Divisorio trasversale L=47 mm 12 x Divisorio trasversale L=73 mm 6 x Divisorio a 2 canali 6 x Divisorio a 3 canali	28,83



ART.	adatto per cassetto H mm	componenti	€
FFH10052100	50/300	12 x Divisorio a 4 canali 65 x Divisorio trasversale L=36 mm	47,43



ART.	adatto per cassetto H mm	componenti	€
FFH10051600	50	12 x Cassetta divisorio 150x75 mm 6 x Cassetta divisorio 150x150 mm	25,73
FFH10071600	75		29,76
FFH10101600	100/125		34,72

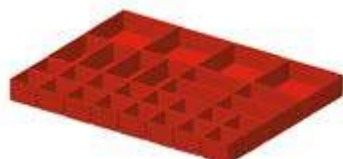

ART.	adatto per cassetto H mm	componenti	€
FFH10051800	50	16 x Cassetta divisorio 75x75 mm 8 x Cassetta divisorio 150x75 mm 4 x Cassetta divisorio 150x150 mm	27,90
FFH10071800	75		32,55



MATERIALE DI SEPARAZIONE

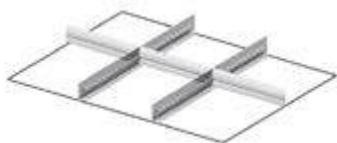

ART.	adatto per cassetto H mm	componenti	€
FFH10050500	50	2 x Divisorio longitudinale fessurato L=457 mm 3 x Divisorio trasversale L=202 mm	14,26
FFH10070500	75		16,43
FFH10100500	100/125		17,05
FFH10150500	150/175		22,63
FFH10200500	200/250		32,24
FFH10300500	300		48,67



ART.	adatto per cassetto H mm	componenti	€
FFH10050300	50	3 x Divisorio longitudinale fessurato L=457 mm 8 x Divisorio trasversale L=151 mm	20,46
FFH10070300	75		20,46
FFH10100300	100/125		23,56
FFH10150300	150/175		30,07
FFH10200300	200/250		43,40



ART.	adatto per cassetto H mm	componenti	€
FFH10052200	50	5 x Divisorio longitudinale fessurato L=457 mm 18 x Divisorio trasversale L=100 mm	33,17
FFH10072200	75		33,17
FFH10102200	100/125		42,78
FFH10152200	150/175		56,42

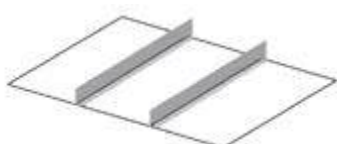

ART.	adatto per cassetto H mm	componenti	€
FFH84051300	50	2 x Divisorio longitudinale non fessurato L=457 mm	10,85
FFH84071300	75		9,92
FFH84101300	100/125		11,16
FFH84151300	150/175		12,71
FFH84201300	200/250		13,64





ARMADIO CON 5 CASSETTI 3X100 1X150 1X300



ART.	cassetti		RAL	€
M52A085C010AKPD	100-75-50	92-96-100%	7035+7016	986,42
M52A085C010AK08	100-75-50	92-96-100%	7035	986,42
M52A085C010AK04	100-75-50	92-96-100%	5012	1046,56
M52A085C010ALPD	200	100%	7035+7016	1146,07
M52A085C010AL08	200	100%	7035	1146,07
M52A085C010AL04	200	100%	5012	1206,21

CONFIGURE

H=850 mm

ARMADIO CON 6 CASSETTI 2X75 2X100 1X150 1X250



ART.	cassetti		RAL	€
M52A085C010AMPD	100-75-50	92-96-100%	7035+7016	1065,78
M52A085C010AM08	100-75-50	92-96-100%	7035	1065,78
M52A085C010AM04	100-75-50	92-96-100%	5012	1145,45
M52A085C010ANPD	200	100%	7035+7016	1257,36
M52A085C010AN08	200	100%	7035	1257,36
M52A085C010AN04	200	100%	5012	1337,03

CONFIGURE

H=850 mm

ARMADIO CON 7 CASSETTI 1X50 2X75 2X100 1X150 1X200



ART.	cassetti		RAL	€
M52A085C010AEPD	100-75-50	92-96-100%	7035+7016	1155,06
M52A085C010AE08	100-75-50	92-96-100%	7035	1155,06
M52A085C010AE04	100-75-50	92-96-100%	5012	1253,64
M52A085C010AFPD	200	100%	7035+7016	1346,64
M52A085C010AF08	200	100%	7035	1346,64
M52A085C010AF04	200	100%	5012	1445,22

CONFIGURE

H=850 mm I cassetti H=50 mm hanno sempre estrazione flessibile

ARMADIO CON 6 CASSETTI 3X100 2X150 1X300



ART.	cassetti		RAL	€
M52A100C010CQPD	100-75-50	92-96-100%	7035+7016	1130,88
M52A100C010CQ08	100-75-50	92-96-100%	7035	1130,88
M52A100C010CQ04	100-75-50	92-96-100%	5012	1202,49
M52A100C010CRPD	200	100%	7035+7016	1322,46
M52A100C010CR08	200	100%	7035	1322,46
M52A100C010CR04	200	100%	5012	1394,07

CONFIGURE

H=1000 mm



ARMADIO CON 7 CASSETTI 2X75 1X100 3X150 1X200



ART.	cassetti		RAL	€
M52A100C010AWPD	100-75-50	92-96-100%	7035+7016	1213,34
M52A100C010AW08	100-75-50	92-96-100%	7035	1213,34
M52A100C010AW04	100-75-50	92-96-100%	5012	1302,93
M52A100C010BHPD	200	100%	7035+7016	1436,85
M52A100C010BH08	200	100%	7035	1436,85
M52A100C010BH04	200	100%	5012	1526,44

CONFIGURE

H=1000 mm



ARMADIO CON 8 CASSETTI 2X75 4X100 1X150 1X200

ART.	cassetti		RAL	€
M52A100C010CNPD	100-75-50	92-96-100%	7035+7016	1302,31
M52A100C010CN08	100-75-50	92-96-100%	7035	1302,31
M52A100C010CN04	100-75-50	92-96-100%	5012	1409,88
M52A100C010CPPD	200	100%	7035+7016	1557,75
M52A100C010CP08	200	100%	7035	1557,75
M52A100C010CP04	200	100%	5012	1665,32

CONFIGURE

H=1000 mm



ARMADIO CON 9 CASSETTI 2X75 2X100 1X150 3X200 1X300

ART.	cassetti		RAL	€
M52A150C010FLPD	100-75-50	92-96-100%	7035+7016	1593,71
M52A150C010FL08	100-75-50	92-96-100%	7035	1593,71
M52A150C010FL04	100-75-50	92-96-100%	5012	1703,76
M52A150C010FMPD	200	100%	7035+7016	1881,08
M52A150C010FM08	200	100%	7035	1881,08
M52A150C010FM04	200	100%	5012	1991,13

CONFIGURE

H=1500 mm



ARMADIO CON 10 CASSETTI 2X75 3X100 1X150 4X200

ART.	cassetti		RAL	€
M52A150C010FNPD	100-75-50	92-96-100%	7035+7016	1690,43
M52A150C010FN08	100-75-50	92-96-100%	7035	1690,43
M52A150C010FN04	100-75-50	92-96-100%	5012	1815,36
M52A150C010FPPD	200	100%	7035+7016	2009,73
M52A150C010FP08	200	100%	7035	2009,73
M52A150C010FP04	200	100%	5012	2134,66

CONFIGURE

H=1500 mm



DIM. INTERNE LxP



PORTATA



ESTRAZIONE



RAL 7035 + RAL 7016



RAL 5012



RAL 7035



ARMADIO CON 11 CASSETTI 2X75 4X100 3X150 2X200



ART.	cassetti		RAL	€
M52A150C010FQPD	100-75-50	92-96-100%	7035+7016	1784,67
M52A150C010FQ08	100-75-50	92-96-100%	7035	1784,67
M52A150C010FQ04	100-75-50	92-96-100%	5012	1924,79
M52A150C010FRPD	200	100%	7035+7016	2135,90
M52A150C010FR08	200	100%	7035	2135,90
M52A150C010FR04	200	100%	5012	2276,02

CONFIGURE

H=1500 mm



ARMADIO CON 7 CASSETTI 2XPR 2X75 1X100 3X150 1X200



ART.	cassetti		RAL	€
M52A200C010FSPD	100-75-50	92-96-100%	7035+7016	1629,67
M52A200C010FS08	100-75-50	92-96-100%	7035	1629,67
M52A200C010FS04	100-75-50	92-96-100%	5012	1719,57
M52A200C010FTPD	200	100%	7035+7016	1853,18
M52A200C010FT08	200	100%	7035	1853,18
M52A200C010FT04	200	100%	5012	1943,08

CONFIGURE

H=2000 mm



ARMADIO CON PORTE CON 3 CASSETTI 2XPR 2X100 1X150 2XPE



ART.	cassetti / piani estraibili		RAL	€
M52A200C010FWPD	100-75-50	92-96-100%	7035+7016	1639,28
M52A200C010FW08	100-75-50	92-96-100%	7035	1639,28
M52A200C010FW04	100-75-50	92-96-100%	5012	1704,07
M52A200C010FXPD	200	100%	7035+7016	1798,93
M52A200C010FX08	200	100%	7035	1798,93
M52A200C010FX04	200	100%	5012	1863,72

CONFIGURE

H=2000 mm



ARMADIO CON PORTE CON 7 CASSETTI 2XPR 2X75 1X100 3X150 1X200



ART.	cassetti		RAL	€
M52A200C010TAPD	100-75-50	92-96-100%	7035+7016	1810,71
M52A200C010TA08	100-75-50	92-96-100%	7035	1810,71
M52A200C010TA04	100-75-50	92-96-100%	5012	1900,61
M52A200C010TBPD	200	100%	7035+7016	2034,22
M52A200C010TB08	200	100%	7035	2034,22
M52A200C010TB04	200	100%	5012	2124,12

H=2000 mm



CONFIGURE

ARMADIO CON RUOTE CON 4 CASSETTI 1X100 2X150 1X200



ART.	cassetti		RAL	€
M52R070C01049PD	100-75-50	92-96-100%	7035+7016	1125,61
M52R070C0104908	100-75-50	92-96-100%	7035	1125,61
M52R070C0104904	100-75-50	92-96-100%	5012	1171,49

H=922 mm

Ruote: Gomma elastica Ø 125 mm
Portata armadio: 750 kg



CONFIGURE

ARMADIO CON RUOTE CON 5 CASSETTI 2X75 1X100 1X150 1X200



ART.	cassetti		RAL	€
M52R070C01031PD	100-75-50	92-96-100%	7035+7016	1200,32
M52R070C0103108	100-75-50	92-96-100%	7035	1200,32
M52R070C0103104	100-75-50	92-96-100%	5012	1267,59

H=922 mm

Ruote: Gomma elastica Ø 125 mm
Portata armadio: 750 kg



CONFIGURE

ARMADIO CON RUOTE CON 6 CASSETTI 2X75 3X100 1X150



ART.	cassetti		RAL	€
M52R070C01044PD	100-75-50	92-96-100%	7035+7016	1291,77
M52R070C0104408	100-75-50	92-96-100%	7035	1291,77
M52R070C0104404	100-75-50	92-96-100%	5012	1375,78

H=922 mm

Ruote: Gomma elastica Ø 125 mm
Portata armadio: 750 kg





MATERIALE DI SEPARAZIONE



ART.	adatto per cassetto H mm	componenti	€
FFH40051200	50/300	15 x Divisorio trasversale L=36 mm 10 x Divisorio trasversale L=47 mm 6 x Divisorio trasversale L=73 mm 6 x Divisorio a 2 canali 6 x Divisorio a 3 canali 6 x Divisorio a 4 canali	39,68



ART.	adatto per cassetto H mm	componenti	€
FFH40051500	50/300	30 x Divisorio trasversale L=36 mm 10 x Divisorio trasversale L=47 mm 6 x Divisorio a 3 canali 12 x Divisorio a 4 canali	42,16



ART.	adatto per cassetto H mm	componenti	€
FFH40051100	50	18 x Cassetta divisorio 150x150 mm	37,20
FFH40071100	75		42,47
FFH40101100	100/125		48,05



ART.	adatto per cassetto H mm	componenti	€
FFH40051300	50	12 x Cassetta divisorio 150x75 mm 12 x Cassetta divisorio 150x150 mm	35,96
FFH40071300	75		44,33
FFH40101300	100/125		51,15



ART.	adatto per cassetto H mm	componenti	€
FFH40051600	50	20 x Cassetta divisorio 75x75 mm 14 x Cassetta divisorio 150x75 mm 6 x Cassetta divisorio 150x150 mm	43,09
FFH40071600	75		48,98



ART.	adatto per cassetto H mm	componenti	€
FFH40050300	50	5 x Divisorio longitudinale fessurato L=457 mm 12 x Divisorio trasversale L=151 mm	31,00
FFH40070300	75		28,52
FFH40100300	100/125		34,41
FFH40150300	150/175		44,95
FFH40200300	200/250		70,37



MATERIALE DI SEPARAZIONE



ART.	adatto per cassetto H mm	componenti	€
FFH40050500	50	4 x Divisorio longitudinale fessurato L=457 mm 2 x Divisorio trasversale L=151 mm 3 x Divisorio trasversale L=202 mm	24,18
FFH40070500	75		24,18
FFH40100500	100/125		29,45
FFH40150500	150/175		40,61
FFH40200500	200/250		59,52



ART.	adatto per cassetto H mm	componenti	€
FFH40052000	50	2 x Divisorio longitudinale fessurato L=457 mm 2 x Divisorio trasversale L=304 mm	14,26
FFH40072000	75		13,64
FFH40102000	100/125		16,12
FFH40152000	150/175		20,15
FFH40202000	200/250		27,59
FFH40302000	300		48,98



ART.	adatto per cassetto H mm	componenti	€
FFH40050600	50	7 x Divisorio longitudinale fessurato L=457 mm 12 x Divisorio trasversale L=100 mm 2 x Divisorio trasversale L=151 mm	39,37
FFH40070600	75		38,75
FFH40100600	100/125		49,91





ARMADIO CON 1 CASSETTO 1X100



ART.	cassetti		RAL	€
M23A020C01005PD	100-75-50	92-96-100%	7035+7016	270,63
M23A020C0100508	100-75-50	92-96-100%	7035	270,63
M23A020C0100504	100-75-50	92-96-100%	5012	281,79

CONFIGURE

H=200 mm



ARMADIO CON 1 CASSETTO 1X200



ART.	cassetti		RAL	€
M23A030C01006PD	100-75-50	92-96-100%	7035+7016	292,33
M23A030C0100608	100-75-50	92-96-100%	7035	292,33
M23A030C0100604	100-75-50	92-96-100%	5012	296,67

CONFIGURE

H=300 mm



ARMADIO CON 3 CASSETTI 1X50 1X100 1X150



ART.	cassetti		RAL	€
M23A040C01001PD	100-75-50	92-96-100%	7035+7016	473,37
M23A040C0100108	100-75-50	92-96-100%	7035	509,95
M23A040C0100104	100-75-50	92-96-100%	5012	542,50

CONFIGURE

H=400 mm



ARMADIO CON 3 CASSETTI 2X75 1X150



ART.	cassetti		RAL	€
M23A040C01002PD	100-75-50	92-96-100%	7035+7016	504,37
M23A040C0100208	100-75-50	92-96-100%	7035	504,37
M23A040C0100204	100-75-50	92-96-100%	5012	534,75

CONFIGURE

H=400 mm



ARMADIO CON 4 CASSETTI 2X75 1X150 1X200



ART.	cassetti		RAL	€
M23A060C01020PD	100-75-50	92-96-100%	7035+7016	610,39
M23A060C0102008	100-75-50	92-96-100%	7035	610,39
M23A060C0102004	100-75-50	92-96-100%	5012	644,80

CONFIGURE

H=600 mm



CONFIGURE

ARMADIO CON 5 CASSETTI 1X50 2X75 1X100 1X200



ART.	cassetti		RAL	€
M23A060C01021PD	100-75-50	92-96-100%	7035+7016	676,11
M23A060C0102108	100-75-50	92-96-100%	7035	676,11
M23A060C0102104	100-75-50	92-96-100%	5012	726,02

H=600 mm



CONFIGURE

ARMADIO CON 5 CASSETTI 2X75 1X100 1X150 1X200



ART.	cassetti		RAL	€
M23A070C01031PD	100-75-50	92-96-100%	7035+7016	699,05
M23A070C0103108	100-75-50	92-96-100%	7035	699,05
M23A070C0103104	100-75-50	92-96-100%	5012	744,62

H=700 mm



CONFIGURE

ARMADIO CON 4 CASSETTI 1X100 2X150 1X200



ART.	cassetti		RAL	€
M23A070C01049PD	100-75-50	92-96-100%	7035+7016	638,60
M23A070C0104908	100-75-50	92-96-100%	7035	638,60
M23A070C0104904	100-75-50	92-96-100%	5012	671,15

H=700 mm



CONFIGURE

ARMADIO CON 6 CASSETTI 1X50 2X75 2X100 1X200



ART.	cassetti		RAL	€
M23A070C01032PD	100-75-50	92-96-100%	7035+7016	764,77
M23A070C0103208	100-75-50	92-96-100%	7035	764,77
M23A070C0103204	100-75-50	92-96-100%	5012	825,84

H=700 mm



CONFIGURE

ARMADIO CON 4 CASSETTI 2X100 1X200 1X300



ART.	cassetti		RAL	€
M23A080C01055PD	100-75-50	92-96-100%	7035+7016	662,16
M23A080C0105508	100-75-50	92-96-100%	7035	662,16
M23A080C0105504	100-75-50	92-96-100%	5012	696,26

H=800 mm



DIM. INTERNE LxP



PORTATA



ESTRAZIONE



RAL 7035 + RAL 7016



RAL 5012



RAL 7035



ARMADIO CON 5 CASSETTI 1X50 2X100 1X150 1X300



ART.	cassetti		RAL	€
M23A080C01054PD	100-75-50	92-96-100%	7035+7016	720,44
M23A080C0105408	100-75-50	92-96-100%	7035	720,44
M23A080C0105404	100-75-50	92-96-100%	5012	771,90

CONFIGURE

H=800 mm



ARMADIO CON 6 CASSETTI 2X75 2X100 1X150 1X200



ART.	cassetti		RAL	€
M23A080C01056PD	100-75-50	92-96-100%	7035+7016	785,85
M23A080C0105608	100-75-50	92-96-100%	7035	785,85
M23A080C0105604	100-75-50	92-96-100%	5012	842,58

CONFIGURE

H=800 mm



ARMADIO CON 7 CASSETTI 1X50 2X75 2X100 2X150



ART.	cassetti		RAL	€
M23A080C01066PD	100-75-50	92-96-100%	7035+7016	843,82
M23A080C0106608	100-75-50	92-96-100%	7035	843,82
M23A080C0106604	100-75-50	92-96-100%	5012	917,91

CONFIGURE

H=800 mm



ARMADIO CON 7 CASSETTI 2X75 4X100 1X150



ART.	cassetti		RAL	€
M23A080C01065PD	100-75-50	92-96-100%	7035+7016	849,71
M23A080C0106508	100-75-50	92-96-100%	7035	849,71
M23A080C0106504	100-75-50	92-96-100%	5012	924,73

CONFIGURE

H=800 mm



ARMADIO CON PORTA CON 1 CASSETTO 1X75 1XPR 1XPE



ART.	cassetti/piani estraibili		RAL	€
M23A080C01069PD	100-75-50	92-96-100%	7035+7016	651,62
M23A080C0106908	100-75-50	92-96-100%	7035	651,62
M23A080C0106904	100-75-50	92-96-100%	5012	673,63

CONFIGURE

H=800 mm



[CONFIGURE](#)

ARMADIO CON 4 CASSETTI 3X150 1X300

ART.	cassetti		RAL	€
M23A085C010AQPDP	100-75-50	92-96-100%	7035+7016	669,29
M23A085C010AQ08	100-75-50	92-96-100%	7035	669,29
M23A085C010AQ04	100-75-50	92-96-100%	5012	702,77

H=850 mm



[CONFIGURE](#)

ARMADIO CON 5 CASSETTI 1X50 2X100 1X200 1X300

ART.	cassetti		RAL	€
M23A085C01093PD	100-75-50	92-96-100%	7035+7016	742,76
M23A085C0109308	100-75-50	92-96-100%	7035	742,76
M23A085C0109304	100-75-50	92-96-100%	5012	789,57

H=850 mm



[CONFIGURE](#)

ARMADIO CON 5 CASSETTI 2X100 1X150 2X200

ART.	cassetti		RAL	€
M23A085C01090PD	100-75-50	92-96-100%	7035+7016	679,21
M23A085C0109008	100-75-50	92-96-100%	7035	747,72
M23A085C0109004	100-75-50	92-96-100%	5012	787,09

H=850 mm



[CONFIGURE](#)

ARMADIO CON 6 CASSETTI 1X75 3X100 1X125 1X250

ART.	cassetti		RAL	€
M23A085C01094PD	100-75-50	92-96-100%	7035+7016	806,62
M23A085C0109408	100-75-50	92-96-100%	7035	806,62
M23A085C0109404	100-75-50	92-96-100%	5012	865,83

H=850 mm



[CONFIGURE](#)

ARMADIO CON 6 CASSETTI 1X50 2X100 2X150 1X200

ART.	cassetti		RAL	€
M23A085C01091PD	100-75-50	92-96-100%	7035+7016	806,00
M23A085C0109108	100-75-50	92-96-100%	7035	806,00
M23A085C0109104	100-75-50	92-96-100%	5012	862,42

H=850 mm

PE: PIANO ESTRAIBILE
PR: PIANO REGOLABILE



DIM. INTERNE LxP



PORTATA



ESTRAZIONE



RAL 7035 + RAL 7016



RAL 5012



RAL 7035



CONFIGURE

ARMADIO CON 7 CASSETTI 1X50 2X75 2X100 1X150 1X200



ART.	cassetti		RAL	€
M23A085C010AEPD	100-75-50	92-96-100%	7035+7016	866,14
M23A085C010AE08	100-75-50	92-96-100%	7035	866,14
M23A085C010AE04	100-75-50	92-96-100%	5012	935,89

H=850 mm



CONFIGURE

ARMADIO CON 7 CASSETTI 2X75 3X100 2X150



ART.	cassetti		RAL	€
M23A085C01095PD	100-75-50	92-96-100%	7035+7016	864,28
M23A085C0109508	100-75-50	92-96-100%	7035	864,28
M23A085C0109504	100-75-50	92-96-100%	5012	936,82

H=850 mm



CONFIGURE

ARMADIO CON 8 CASSETTI 1X50 2X75 4X100 1X150



ART.	cassetti		RAL	€
M23A085C01087PD	100-75-50	92-96-100%	7035+7016	930,00
M23A085C0108708	100-75-50	92-96-100%	7035	930,00
M23A085C0108704	100-75-50	92-96-100%	5012	1018,04

H=850 mm



CONFIGURE

ARMADIO CON RUOTE CON 4 CASSETTI 2X75 1X150 1X200



ART.	cassetti		RAL	€
M23R060C01020PD	100-75-50	92-96-100%	7035+7016	804,14
M23R060C0102008	100-75-50	92-96-100%	7035	804,14
M23R060C0102004	100-75-50	92-96-100%	5012	838,86

H=822 mm

Ruote: Gomma standard Ø 125 mm
Portata armadio: 300 kg



CONFIGURE

ARMADIO CON RUOTE CON 5 CASSETTI 1X50 2X75 1X100 1X200



ART.	cassetti		RAL	€
M23R060C01021PD	100-75-50	92-96-100%	7035+7016	870,17
M23R060C0102108	100-75-50	92-96-100%	7035	870,17
M23R060C0102104	100-75-50	92-96-100%	5012	919,77

H=822 mm

Ruote: Gomma standard Ø 125 mm
Portata armadio: 300 kg



CONFIGURE

ARMADIO CON RUOTE CON 6 CASSETTI 4X75 2X100



ART.	cassetti		RAL	€
M23R060C01022PD	100-75-50	92-96-100%	7035+7016	928,45
M23R060C0102208	100-75-50	92-96-100%	7035	928,45
M23R060C0102204	100-75-50	92-96-100%	5012	994,17

H=822 mm

Ruote: Gomma standard Ø 125 mm
Portata armadio: 300 kg



CONFIGURE

ARMADIO CON RUOTE CON 5 CASSETTI 2X75 1X100 1X150 1X200



ART.	cassetti		RAL	€
M23R070C01031PD	100-75-50	92-96-100%	7035+7016	892,49
M23R070C0103108	100-75-50	92-96-100%	7035	892,49
M23R070C0103104	100-75-50	92-96-100%	5012	938,06

H=922 mm

Ruote: Gomma standard Ø 125 mm
Portata armadio: 300 kg



CONFIGURE

ARMADIO CON RUOTE CON 6 CASSETTI 1X50 2X75 2X100 1X200



ART.	cassetti		RAL	€
M23R070C01032PD	100-75-50	92-96-100%	7035+7016	958,21
M23R070C0103208	100-75-50	92-96-100%	7035	958,21
M23R070C0103204	100-75-50	92-96-100%	5012	1019,28

H=922 mm

Ruote: Gomma standard Ø 125 mm
Portata armadio: 300 kg



CONFIGURE

ARMADIO CON RUOTE CON 5 CASSETTI 1X50 2X100 1X150 1X300



ART.	cassetti		RAL	€
M23R080C01054PD	100-75-50	92-96-100%	7035+7016	917,91
M23R080C0105408	100-75-50	92-96-100%	7035	917,91
M23R080C0105404	100-75-50	92-96-100%	5012	969,37

H=1022 mm

Ruote: Gomma standard Ø 125 mm
Portata armadio: 300 kg



CONFIGURE

ARMADIO CON RUOTE CON 5 CASSETTI 3X100 2X200



ART.	cassetti		RAL	€
M23R080C01063PD	100-75-50	92-96-100%	7035+7016	930,62
M23R080C0106308	100-75-50	92-96-100%	7035	930,62
M23R080C0106304	100-75-50	92-96-100%	5012	972,47

H=1022 mm

Ruote: Gomma standard Ø 125 mm
Portata armadio: 300 kg



DIM. INTERNE LxP



PORTATA



ESTRAZIONE



RAL 7035 + RAL 7016



RAL 5012



RAL 7035



CONFIGURE



CONFIGURE

ARMADIO CON RUOTE CON 7 CASSETTI 2X75 4X100 1X150

ART.	cassetti		RAL	€
M23R080C01065PD	100-75-50	92-96-100%	7035+7016	1047,18
M23R080C0106508	100-75-50	92-96-100%	7035	1047,18
M23R080C0106504	100-75-50	92-96-100%	5012	1122,20

H=1022 mm

Ruote: Gomma standard Ø 125 mm
Portata armadio: 300 kg

ARMADIO CON RUOTE CON 7 CASSETTI 1X50 2X75 2X100 2X150

ART.	cassetti		RAL	€
M23R080C01066PD	100-75-50	92-96-100%	7035+7016	1041,60
M23R080C0106608	100-75-50	92-96-100%	7035	1041,60
M23R080C0106604	100-75-50	92-96-100%	5012	1115,69

H=1022 mm

Ruote: Gomma standard Ø 125 mm
Portata armadio: 300 kg





DIM. INTERNE LxP



PORTATA



ESTRAZIONE



RAL 7035 + RAL 7016



RAL 5012



RAL 7035



MATERIALE DI SEPARAZIONE



ART.	adatto per cassetto H mm	componenti	€
FFH86050100	50/300	50 x Divisorio trasversale L=36 mm 12 x Divisorio a 4 canali	27,59



ART.	adatto per cassetto H mm	componenti	€
FFH86050200	50/300	4 x Divisorio a 4 canali 8 x Divisorio a 3 canali 20 x Divisorio trasversale L=36 mm 10 x Divisorio trasversale L=47 mm	33,79



ART.	adatto per cassetto H mm	componenti	€
FFH86050300	50/300	4 x Divisorio a 3 canali 8 x Divisorio a 2 canali 20 x Divisorio trasversale L=47 mm 10 x Divisorio trasversale L=73 mm	32,55



ART.	adatto per cassetto H mm	componenti	€
FFH86051600	50	16 x Cassetta divisorio con divisorio fisso 75x75 mm	29,14
FFH86071600	75	16 x Cassetta divisorio 75x75 mm 4 x Cassetta divisorio 150x75 mm 2 x Cassetta divisorio 150x150 mm	31,00



ART.	adatto per cassetto H mm	componenti	€
FFH86051700	50	16 x Cassetta divisorio 75x75 mm 8 x Cassetta divisorio 150x75 mm	27,90
FFH86071700	75	4 x Cassetta divisorio 150x150 mm	31,00



ART.	adatto per cassetto H mm	componenti	€
FFH86051800	50	12 x Cassetta divisorio 150x75 mm 6 x Cassetta divisorio 150x150 mm	25,11
FFH86071800	75		28,21
FFH86101800	100/125		31,31



MATERIALE DI SEPARAZIONE



ART.	adatto per cassetto H mm	componenti	€
FFH86050700	50	1 x Divisorio longitudinale fessurato L=610 mm 1 x Divisorio trasversale L=202 mm 1 x Divisorio trasversale L=253 mm	10,85
FFH86070700	75		8,68
FFH86100700	100/125		9,30
FFH86150700	150/175		11,47
FFH86200700	200/250		17,98
FFH86300700	300		35,65



ART.	adatto per cassetto H mm	componenti	€
FFH86050800	50	2 x Divisorio longitudinale fessurato L=610 mm 3 x Divisorio trasversale L=151 mm	14,88
FFH86070800	75		10,54
FFH86100800	100/125		11,78
FFH86150800	150/175		15,50
FFH86200800	200/250		26,97
FFH86300800	300		54,25



ART.	adatto per cassetto H mm	componenti	€
FFH86050900	50	2 x Divisorio longitudinale fessurato L=610 mm 10 x Divisorio trasversale L=151 mm	18,60
FFH86070900	75		14,57
FFH86100900	100/125		16,74
FFH86150900	150/175		23,87
FFH86200900	200/250		35,96



ART.	adatto per cassetto H mm	componenti	€
FFH86051000	50	3 x Divisorio longitudinale fessurato L=610 mm 6 x Divisorio trasversale L=100 mm 2 x Divisorio trasversale L=151 mm	21,08
FFH86071000	75		14,88
FFH86101000	100/125		18,60
FFH86151000	150/175		26,35



ART.	adatto per cassetto H mm	componenti	€
FFH86051300	50	2 x Divisorio longitudinale non fessurato L=610 mm	11,47
FFH86071300	75		10,85
FFH86101300	100/125		11,78
FFH86151300	150/175		13,64
FFH86201300	200/250		16,43
FFH86301300	300		21,08

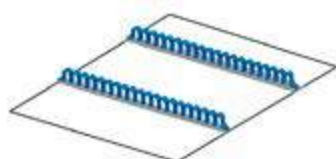

ART.	adatto per cassetto H mm	componenti	€
FFH86051900	50/300	2 x Portautensili multiuso	19,84





ARMADIO CON 4 CASSETTI 1X100 2X150 1X300



ART.	cassetti		RAL	€
M33A080C01072PD	100-75-50	92-96-100%	7035+7016	770,97
M33A080C0107208	100-75-50	92-96-100%	7035	770,97
M33A080C0107204	100-75-50	92-96-100%	5012	817,78

H=800 mm

CONFIGURE

ARMADIO CON 6 CASSETTI 2X75 2X100 1X150 1X200



ART.	cassetti		RAL	€
M33A080C01056PD	100-75-50	92-96-100%	7035+7016	922,25
M33A080C0105608	100-75-50	92-96-100%	7035	922,25
M33A080C0105604	100-75-50	92-96-100%	5012	995,72

H=800 mm

CONFIGURE

ARMADIO CON 4 CASSETTI 1X100 1X150 1X200 1X300



ART.	cassetti		RAL	€
M33A085C01092PD	100-75-50	92-96-100%	7035+7016	748,96
M33A085C0109208	100-75-50	92-96-100%	7035	748,96
M33A085C0109204	100-75-50	92-96-100%	5012	799,49
M33A085C010ASPD	200	100%	7035+7016	876,68
M33A085C010AS08	200	100%	7035	876,68
M33A085C010AS04	200	100%	5012	927,21

H=850 mm

CONFIGURE

ARMADIO CON 5 CASSETTI 1X50 2X100 1X200 1X300



ART.	cassetti		RAL	€
M33A085C01093PD	100-75-50	92-96-100%	7035+7016	823,67
M33A085C0109308	100-75-50	92-96-100%	7035	823,67
M33A085C0109304	100-75-50	92-96-100%	5012	891,25
M33A085C010ATPD	200	100%	7035+7016	951,39
M33A085C010AT08	200	100%	7035	951,39
M33A085C010AT04	200	100%	5012	1018,97

H=850 mm I cassetti H=50 mm hanno sempre estrazione flessibile

CONFIGURE



ARMADIO CON 5 CASSETTI 1X100 3X150 1X200



ART.	cassetti		RAL	€
	KG			
M33A085C01088PD	100-75-50	92-96-100%	7035+7016	825,22
M33A085C0108808	100-75-50	92-96-100%	7035	825,22
M33A085C0108804	100-75-50	92-96-100%	5012	881,02
M33A085C010APPD	200	100%	7035+7016	984,87
M33A085C010AP08	200	100%	7035	984,87
M33A085C010AP04	200	100%	5012	1040,67

CONFIGURE

H=850 mm



ARMADIO CON 7 CASSETTI 1X50 2X75 2X100 1X150 1X200

ART.	cassetti		RAL	€
	KG			
M33A085C010AEPD	100-75-50	92-96-100%	7035+7016	974,02
M33A085C010AE08	100-75-50	92-96-100%	7035	974,02
M33A085C010AE04	100-75-50	92-96-100%	5012	1061,75
M33A085C010AFPD	200	100%	7035+7016	1165,60
M33A085C010AF08	200	100%	7035	1165,60
M33A085C010AF04	200	100%	5012	1253,33

CONFIGURE

H=850 mm I cassetti H=50 mm hanno sempre estrazione flessibile



ARMADIO CON 7 CASSETTI 2X75 3X100 2X150

ART.	cassetti		RAL	€
	KG			
M33A085C01095PD	100-75-50	92-96-100%	7035+7016	972,16
M33A085C0109508	100-75-50	92-96-100%	7035	972,16
M33A085C0109504	100-75-50	92-96-100%	5012	1054,31
M33A085C010AUPD	200	100%	7035+7016	1195,67
M33A085C010AU08	200	100%	7035	1195,67
M33A085C010AU04	200	100%	5012	1277,82

CONFIGURE

H=850 mm



ARMADIO CON 8 CASSETTI 1X50 2X75 4X100 1X150

ART.	cassetti		RAL	€
	KG			
M33A085C01087PD	100-75-50	92-96-100%	7035+7016	1046,87
M33A085C0108708	100-75-50	92-96-100%	7035	1046,87
M33A085C0108704	100-75-50	92-96-100%	5012	1146,07
M33A085C010AVPD	200	100%	7035+7016	1270,38
M33A085C010AV08	200	100%	7035	1270,38
M33A085C010AV04	200	100%	5012	1369,58

CONFIGURE

H=850 mm I cassetti H=50 mm hanno sempre estrazione flessibile



DIM. INTERNE LxP



PORTATA



ESTRAZIONE



RAL 7035 + RAL 7016



RAL 5012



RAL 7035



ARMADIO CON 6 CASSETTI 1X50 3X150 2X200

ART.	cassetti		RAL	€
M33A100C010CZPD	100-75-50	92-96-100%	7035+7016	957,90
M33A100C010CZ08	100-75-50	92-96-100%	7035	957,90
M33A100C010CZ04	100-75-50	92-96-100%	5012	1029,51
M33A100C010DAPD	200	100%	7035+7016	1117,55
M33A100C010DA08	200	100%	7035	1117,55
M33A100C010DA04	200	100%	5012	1189,16

CONFIGURE

H=1000 mm I cassetti H=50 mm hanno sempre estrazione flessibile



ARMADIO CON 6 CASSETTI 1X100 4X150 1X200

ART.	cassetti		RAL	€
M33A100C010DBPD	100-75-50	92-96-100%	7035+7016	956,35
M33A100C010DB08	100-75-50	92-96-100%	7035	956,35
M33A100C010DB04	100-75-50	92-96-100%	5012	1022,07
M33A100C010DCPD	200	100%	7035+7016	1147,93
M33A100C010DC08	200	100%	7035	1147,93
M33A100C010DC04	200	100%	5012	1213,65

CONFIGURE

H=1000 mm



ARMADIO CON 7 CASSETTI 1X50 2X75 2X100 1X200 1X300

ART.	cassetti		RAL	€
M33A100C010BNPD	100-75-50	92-96-100%	7035+7016	1029,20
M33A100C010BN08	100-75-50	92-96-100%	7035	1029,20
M33A100C010BN04	100-75-50	92-96-100%	5012	1121,27
M33A100C010BPPD	200	100%	7035+7016	1220,78
M33A100C010BP08	200	100%	7035	1220,78
M33A100C010BP04	200	100%	5012	1312,85

CONFIGURE

H=1000 mm I cassetti H=50 mm hanno sempre estrazione flessibile



ARMADIO CON 7 CASSETTI 2X75 1X100 3X150 1X200

ART.	cassetti		RAL	€
M33A100C010AWPD	100-75-50	92-96-100%	7035+7016	1030,44
M33A100C010AW08	100-75-50	92-96-100%	7035	1030,44
M33A100C010AW04	100-75-50	92-96-100%	5012	1111,04
M33A100C010BHPD	200	100%	7035+7016	1253,95
M33A100C010BH08	200	100%	7035	1253,95
M33A100C010BH04	200	100%	5012	1334,55

CONFIGURE

H=1000 mm



ARMADIO CON 8 CASSETTI 1X50 2X75 2X100 2X150 1X200



ART.	cassetti		RAL	€
M33A100C010CUPD	100-75-50	92-96-100%	7035+7016	1105,15
M33A100C010CU08	100-75-50	92-96-100%	7035	1105,15
M33A100C010CU04	100-75-50	92-96-100%	5012	1202,80
M33A100C010CVPD	200	100%	7035+7016	1328,66
M33A100C010CV08	200	100%	7035	1328,66
M33A100C010CV04	200	100%	5012	1426,31

CONFIGURE

H=1000 mm I cassetti H=50 mm hanno sempre estrazione flessibile



ARMADIO CON 8 CASSETTI 2X75 3X100 3X150

ART.	cassetti		RAL	€
M33A100C010DDPD	100-75-50	92-96-100%	7035+7016	1103,60
M33A100C010DD08	100-75-50	92-96-100%	7035	1103,60
M33A100C010DD04	100-75-50	92-96-100%	5012	1195,36
M33A100C010DEPD	200	100%	7035+7016	1359,04
M33A100C010DE08	200	100%	7035	1359,04
M33A100C010DE04	200	100%	5012	1450,80

CONFIGURE

H=1000 mm



ARMADIO CON 9 CASSETTI 9X100

ART.	cassetti		RAL	€
M33A100C010BLPD	100-75-50	92-96-100%	7035+7016	1177,69
M33A100C010BL08	100-75-50	92-96-100%	7035	1177,69
M33A100C010BL04	100-75-50	92-96-100%	5012	1289,60
M33A100C010BMPD	200	100%	7035+7016	1465,06
M33A100C010BM08	200	100%	7035	1465,06
M33A100C010BM04	200	100%	5012	1576,97

CONFIGURE

H=1000 mm



ARMADIO CON 10 CASSETTI 1X50 2X75 7X100

ART.	cassetti		RAL	€
M33A100C010DFPD	100-75-50	92-96-100%	7035+7016	1252,40
M33A100C010DF08	100-75-50	92-96-100%	7035	1252,40
M33A100C010DF04	100-75-50	92-96-100%	5012	1378,88
M33A100C010DGPD	200	100%	7035+7016	1539,77
M33A100C010DG08	200	100%	7035	1539,77
M33A100C010DG04	200	100%	5012	1666,25

CONFIGURE

H=1000 mm I cassetti H=50 mm hanno sempre estrazione flessibile



DIM. INTERNE LxP



PORTATA



ESTRAZIONE



RAL 7035 + RAL 7016



RAL 5012



RAL 7035



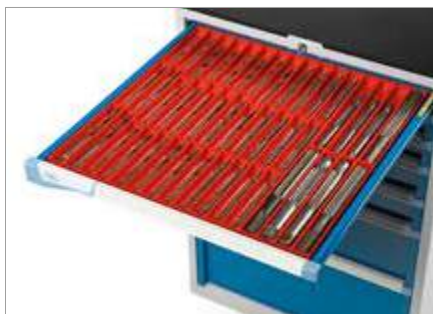

CASSETTO H 50 mm

Set composto da 16 divisori a 4 canali e 65 divisori trasversali 36 mm



CASSETTO H 75 mm

Set di predisposizione per termoformati



CASSETTO H 75 mm

Set di predisposizione per termoformati



CASSETTO H 100 mm

Set di predisposizione per termoformati



CASSETTO H 100 mm

Set composto da 3 divisori longitudinali fessurati 610 mm e 15 divisori trasversali 149 mm



CASSETTO H 200 mm

Set composto da 2 divisori longitudinali fessurati 610 mm e 3 divisori trasversali 200 mm



CASSETTO H 300 mm

Set composto da 1 divisorio longitudinale fessurato 610 mm



Utensili e termoformati esclusi

Disponibili in varie dimensioni



ARMADIO CON PORTE CON 2 CASSETTI 2X75 2XPE

ART.	cassetti / piani estraibili		RAL	€
M33A100C010LJPD	100-75-50	92-96-100%	7035+7016	981,77
M33A100C010LJ08	100-75-50	92-96-100%	7035	981,77
M33A100C010LJ04	100-75-50	92-96-100%	5012	1034,16
M33A100C010LKPD	200	100%	7035+7016	1109,49
M33A100C010LK08	200	100%	7035	1109,49
M33A100C010LK04	200	100%	5012	1161,88

H=1022 mm

CONFIGURE



ARMADIO CON PORTE 2XPR 2XPE

ART.	piani estraibili		RAL	€
M33A100C010LMPD	100-75-50	92-96-100%	7035+7016	935,89
M33A100C010LM08	100-75-50	92-96-100%	7035	935,89
M33A100C010LM04	100-75-50	92-96-100%	5012	963,48
M33A100C010LNPD	200	100%	7035+7016	999,75
M33A100C010LN08	200	100%	7035	999,75
M33A100C010LN04	200	100%	5012	1027,34

H=1022 mm

CONFIGURE



ARMADIO CON PORTE CON 4 CASSETTI 4X75

ART.	cassetti		RAL	€
M33A100C010CCPD	100-75-50	92-96-100%	7035+7016	946,12
M33A100C010CC08	100-75-50	92-96-100%	7035	946,12
M33A100C010CC04	100-75-50	92-96-100%	5012	996,03
M33A100C010CDPD	200	100%	7035+7016	1073,84
M33A100C010CD08	200	100%	7035	1073,84
M33A100C010CD04	200	100%	5012	1123,75

H=1022 mm

CONFIGURE



ARMADIO CON PORTE CON 3 CASSETTI 1X125 2X75 2XPE

ART.	cassetti / piani estraibili		RAL	€
M33A100C010LRPD	100-75-50	92-96-100%	7035+7016	1112,59
M33A100C010LR08	100-75-50	92-96-100%	7035	1112,59
M33A100C010LR04	100-75-50	92-96-100%	5012	1177,38
M33A100C010LSPD	200	100%	7035+7016	1272,24
M33A100C010LS08	200	100%	7035	1272,24
M33A100C010LS04	200	100%	5012	1337,03

H=1022 mm

CONFIGURE



ARMADIO CON PORTE CON 5 CASSETTI 1X50 2X75 2X100 1XPE



ART.	cassetti / piani estraibili		RAL	€
	KG			
M33A100C010LTPD	100-75-50	92-96-100%	7035+7016	1177,69
M33A100C010LT08	100-75-50	92-96-100%	7035	1177,69
M33A100C010LT04	100-75-50	92-96-100%	5012	1255,50
M33A100C010LUPD	200	100%	7035+7016	1337,34
M33A100C010LU08	200	100%	7035	1337,34
M33A100C010LU04	200	100%	5012	1415,15

[CONFIGURE](#)

H=1022 mm I cassetti H=50 mm hanno sempre estrazione flessibile



ARMADIO CON PORTE CON 5 CASSETTI 1X50 4X75 1XPE

ART.	cassetti / piani estraibili		RAL	€
	KG			
M33A100C010LVPD	100-75-50	92-96-100%	7035+7016	1169,94
M33A100C010LV08	100-75-50	92-96-100%	7035	1169,94
M33A100C010LV04	100-75-50	92-96-100%	5012	1247,75
M33A100C010LWPD	200	100%	7035+7016	1329,59
M33A100C010LW08	200	100%	7035	1329,59
M33A100C010LW04	200	100%	5012	1407,40

[CONFIGURE](#)

H=1022 mm I cassetti H=50 mm hanno sempre estrazione flessibile



ARMADIO CON PORTE SCORREVOLI CON 4 CASSETTI 4X75 2XPE

ART.	cassetti / piani estraibili		RAL	€
	KG			
M33D100C010GYPD	100-75-50	92-96-100%	7035+7016	1884,18
M33D100C010GY08	100-75-50	92-96-100%	7035	1884,18
M33D100C010GY04	100-75-50	92-96-100%	5012	1961,37
M33D100C010GZPD	200	100%	7035+7016	2075,76
M33D100C010GZ08	200	100%	7035	2075,76
M33D100C010GZ04	200	100%	5012	2152,95

[CONFIGURE](#)

H=1022 mm



ARMADIO CON PORTE SCORREVOLI 4XPR 2XPE

ART.	piani estraibili		RAL	€
	KG			
M33D100C010JAPD	100-75-50	92-96-100%	7035+7016	1703,45
M33D100C010JA08	100-75-50	92-96-100%	7035	1703,45
M33D100C010JA04	100-75-50	92-96-100%	5012	1731,04
M33D100C010JBPD	200	100%	7035+7016	1767,31
M33D100C010JB08	200	100%	7035	1767,31
M33D100C010JB04	200	100%	5012	1794,90

[CONFIGURE](#)

H=1022 mm

PE: PIANO ESTRAIBILE
PR: PIANO REGOLABILE



DIM. INTERNE LxP



PORTATA



ESTRAZIONE



RAL 7035 + RAL 7016



RAL 5012



RAL 7035



ARMADIO CON PORTE SCORREVOLI CON 4 CASSETTI 4X75 4XPE



ART.	cassetti / piani estraibili		RAL	€
M33D100C010HEPD	100-75-50	92-96-100%	7035+7016	2090,95
M33D100C010HE08	100-75-50	92-96-100%	7035	2090,95
M33D100C010HE04	100-75-50	92-96-100%	5012	2195,73
M33D100C010HFPD	200	100%	7035+7016	2346,39
M33D100C010HF08	200	100%	7035	2346,39
M33D100C010HF04	200	100%	5012	2451,17

CONFIGURE

H=1022 mm

ARMADIO CON 9 CASSETTI 2X75 2X100 1X150 3X200 1X300



ART.	cassetti		RAL	€
M33A150C010LXPD	100-75-50	92-96-100%	7035+7016	1339,82
M33A150C010LX08	100-75-50	92-96-100%	7035	1339,82
M33A150C010LX04	100-75-50	92-96-100%	5012	1455,14
M33A150C010LYPD	200	100%	7035+7016	1627,19
M33A150C010LY08	200	100%	7035	1627,19
M33A150C010LY04	200	100%	5012	1742,51

CONFIGURE

H=1500 mm

ARMADIO CON 9 CASSETTI 2X100 6X150 1X300



ART.	cassetti		RAL	€
M33A150C010FJPD	100-75-50	92-96-100%	7035+7016	1337,03
M33A150C010FJ08	100-75-50	92-96-100%	7035	1337,03
M33A150C010FJ04	100-75-50	92-96-100%	5012	1435,61
M33A150C010FKPD	200	100%	7035+7016	1624,40
M33A150C010FK08	200	100%	7035	1624,40
M33A150C010FK04	200	100%	5012	1722,98

CONFIGURE

H=1500 mm

ARMADIO CON 10 CASSETTI 1X50 4X100 1X150 4X200



ART.	cassetti		RAL	€
M33A150C010LZPD	100-75-50	92-96-100%	7035+7016	1417,32
M33A150C010LZ08	100-75-50	92-96-100%	7035	1417,32
M33A150C010LZ04	100-75-50	92-96-100%	5012	1546,28
M33A150C010MAPD	200	100%	7035+7016	1704,69
M33A150C010MA08	200	100%	7035	1704,69
M33A150C010MA04	200	100%	5012	1833,65

CONFIGURE

H=1500 mm I cassetti H=50 mm hanno sempre estrazione flessibile



ARMADIO CON PORTE CON 3 CASSETTI 2X75 1X150 2XPE



ART.	cassetti / piani estraibili		RAL	€
M33A150C010LAPD	100-75-50	92-96-100%	7035+7016	1116,93
M33A150C010LA08	100-75-50	92-96-100%	7035	1116,93
M33A150C010LA04	100-75-50	92-96-100%	5012	1179,24
M33A150C010LBPD	200	100%	7035+7016	1276,58
M33A150C010LB08	200	100%	7035	1276,58
M33A150C010LB04	200	100%	5012	1338,89

CONFIGURE

H=1500 mm



ARMADIO CON PORTE 3XPR 2XPE



ART.	piani estraibili		RAL	€
M33A150C010LCPD	100-75-50	92-96-100%	7035+7016	1036,33
M33A150C010LC08	100-75-50	92-96-100%	7035	1036,33
M33A150C010LC04	100-75-50	92-96-100%	5012	1063,92
M33A150C010LDPD	200	100%	7035+7016	1100,19
M33A150C010LD08	200	100%	7035	1100,19
M33A150C010LD04	200	100%	5012	1127,78

CONFIGURE

H=1500 mm



ARMADIO CON PORTE CON 5 CASSETTI 2X75 3X150



ART.	cassetti		RAL	€
M33A150C010LEPD	100-75-50	92-96-100%	7035+7016	1104,22
M33A150C010LE08	100-75-50	92-96-100%	7035	1104,22
M33A150C010LE04	100-75-50	92-96-100%	5012	1158,78
M33A150C010LFPD	200	100%	7035+7016	1263,87
M33A150C010LF08	200	100%	7035	1263,87
M33A150C010LF04	200	100%	5012	1318,43

CONFIGURE

H=1500 mm



PE: PIANO ESTRAIBILE
PR: PIANO REGOLABILE



DIM. INTERNE LxP



PORTATA



ESTRAZIONE



RAL 7035 + RAL 7016



RAL 5012



RAL 7035



ARMADIO CON 7 CASSETTI 2XPR 2X75 1X100 3X150 1X200

ART.	cassetti		RAL	€
	KG			
M33A200C010FSPD	100-75-50	92-96-100%	7035+7016	1430,96
M33A200C010FS08	100-75-50	92-96-100%	7035	1430,96
M33A200C010FS04	100-75-50	92-96-100%	5012	1511,87
M33A200C010FTPD	200	100%	7035+7016	1654,47
M33A200C010FT08	200	100%	7035	1654,47
M33A200C010FT04	200	100%	5012	1735,38

H=2000 mm

CONFIGURE



ARMADIO CON PORTE CON 3 CASSETTI 2XPR 2X100 1X150 2XPE

ART.	cassetti / piani estraibili		RAL	€
	KG			
M33A200C010FWPD	100-75-50	92-96-100%	7035+7016	1468,16
M33A200C010FW08	100-75-50	92-96-100%	7035	1468,16
M33A200C010FW04	100-75-50	92-96-100%	5012	1530,47
M33A200C010FXPD	200	100%	7035+7016	1627,81
M33A200C010FX08	200	100%	7035	1627,81
M33A200C010FX04	200	100%	5012	1690,12

H=2000 mm

CONFIGURE



ARMADIO CON PORTA CON 7 CASSETTI 2XPR 2X75 1X100 3X150 1X200

ART.	cassetti		RAL	€
	KG			
M33A200C010TAPD	100-75-50	92-96-100%	7035+7016	1570,15
M33A200C010TA08	100-75-50	92-96-100%	7035	1570,15
M33A200C010TA04	100-75-50	92-96-100%	5012	1650,75
M33A200C010TBPD	200	100%	7035+7016	1793,66
M33A200C010TB08	200	100%	7035	1793,66
M33A200C010TB04	200	100%	5012	1874,26

H=2000 mm



CONFIGURE

ARMADIO CON RUOTE CON 3 CASSETTI 1X100 1X200 1X300

ART.	cassetti		RAL	€
M33R070C01029PD	100-75-50	92-96-100%	7035+7016	923,49
M33R070C0102908	100-75-50	92-96-100%	7035	923,49
M33R070C0102904	100-75-50	92-96-100%	5012	964,10

H=922 mm

Ruote: Gomma elastica Ø 125 mm
Portata armadio: 750 kg



CONFIGURE

ARMADIO CON RUOTE CON 5 CASSETTI 1X50 2X100 1X150 1X200

ART.	cassetti		RAL	€
M33R070C01040PD	100-75-50	92-96-100%	7035+7016	1074,15
M33R070C0104008	100-75-50	92-96-100%	7035	1074,15
M33R070C0104004	100-75-50	92-96-100%	5012	1137,08

H=922 mm

Ruote: Gomma elastica Ø 125 mm
Portata armadio: 750 kg



CONFIGURE

ARMADIO CON RUOTE CON 6 CASSETTI 2X75 3X100 1X150

ART.	cassetti		RAL	€
M33R070C01044PD	100-75-50	92-96-100%	7035+7016	1146,69
M33R070C0104408	100-75-50	92-96-100%	7035	1146,69
M33R070C0104404	100-75-50	92-96-100%	5012	1218,92

H=922 mm

Ruote: Gomma elastica Ø 125 mm
Portata armadio: 750 kg



CONFIGURE

ARMADIO CON RUOTE CON 7 CASSETTI 2X75 2X100 2X125 1X150

ART.	cassetti		RAL	€
M33R085C010ACPD	100-75-50	92-96-100%	7035+7016	1246,20
M33R085C010AC08	100-75-50	92-96-100%	7035	1246,20
M33R085C010AC04	100-75-50	92-96-100%	5012	1330,83

H=1072 mm

Ruote: Gomma elastica Ø 125 mm
Portata armadio: 750 kg



CONFIGURE

ARMADIO CON RUOTE CON 8 CASSETTI 4X75 3X100 1X150

ART.	cassetti		RAL	€
M33R085C010AGPD	100-75-50	92-96-100%	7035+7016	1321,53
M33R085C010AG08	100-75-50	92-96-100%	7035	1321,53
M33R085C010AG04	100-75-50	92-96-100%	5012	1418,56

H=1072 mm

Ruote: Gomma elastica Ø 125 mm
Portata armadio: 750 kg

PE: PIANO ESTRAIBILE
PR: PIANO REGOLABILE



DIM. INTERNE LxP



PORTATA



ESTRAZIONE



RAL 7035 + RAL 7016



RAL 5012



RAL 7035



MATERIALE DI SEPARAZIONE



ART.	adatto per cassetto H mm	componenti	€
FFH20051500	50/300	35 x Divisorio trasversale L=73 mm 16 x Divisorio a 2 canali	35,34



ART.	adatto per cassetto H mm	componenti	€
FFH20051600	50/300	50 x Divisorio trasversale L=47 mm 16 x Divisorio a 3 canali	37,82



ART.	adatto per cassetto H mm	componenti	€
FFH20051700	50/300	65 x Divisorio trasversale L=36 mm 16 x Divisorio a 4 canali	41,23



ART.	adatto per cassetto H mm	componenti	€
FFH20052000	50/300	30 x Divisorio trasversale L=36 mm 20 x Divisorio trasversale L=47 mm 10 x Divisorio trasversale L=73 mm 4 x Divisorio a 2 canali 8 x Divisorio a 3 canali 4 x Divisorio a 4 canali	35,34



ART.	adatto per cassetto H mm	componenti	€
FFH20052100	50/300	8 x Divisorio a 3 canali 8 x Divisorio a 4 canali 16 x Divisorio trasversale L=47 mm 24 x Divisorio trasversale L=36 mm	45,88



ART.	adatto per cassetto H mm	componenti	€
FFH20051200	50	16 x Cassetta divisorio 75x75 mm 16 x Cassetta divisorio 150x75 mm	36,58
FFH20071200	75	4 x Cassetta divisorio 150x150 mm	43,09



MATERIALE DI SEPARAZIONE

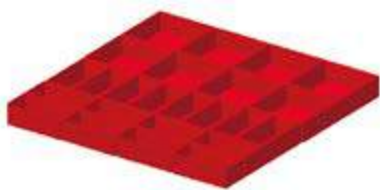

ART.	adatto per cassetto H mm	componenti	€
FFH20051300	50	16 x Cassetta divisorio 150x75 mm 8 x Cassetta divisorio 150x150 mm	31,93
FFH20071300	75		39,06
FFH20101300	100/125		45,57



ART.	adatto per cassetto H mm	componenti	€
FFH20050500	50	1 x Divisorio longitudinale fessurato L=610 mm 2 x Divisorio trasversale L=304 mm	10,54
FFH20070500	75		10,23
FFH20100500	100/125		11,16
FFH20150500	150/175		13,95
FFH20200500	200/250		20,77
FFH20300500	300		34,10



ART.	adatto per cassetto H mm	componenti	€
FFH20050600	50	2 x Divisorio longitudinale fessurato L=610 mm 3 x Divisorio trasversale L=202 mm	16,12
FFH20070600	75		15,50
FFH20100600	100/125		17,67
FFH20150600	150/175		23,87
FFH20200600	200/250		36,27
FFH20300600	300		63,86



ART.	adatto per cassetto H mm	componenti	€
FFH20050700	50	3 x Divisorio longitudinale fessurato L=610 mm 15 x Divisorio trasversale L=151 mm	25,73
FFH20070700	75		23,87
FFH20100700	100/125		24,80
FFH20150700	150/175		35,34
FFH20200700	200/250		53,94



ART.	adatto per cassetto H mm	componenti	€
FFH20050800	50	4 x Divisorio longitudinale fessurato L=610 mm 9 x Divisorio trasversale L=151 mm 12 x Divisorio trasversale L=100 mm	32,86
FFH20070800	75		30,38
FFH20100800	100/125		40,92



ART.	adatto per cassetto H mm	componenti	€
FFH20050900	50	5 x Divisorio longitudinale fessurato L=610 mm 20 x Divisorio trasversale L=100 mm	35,03
FFH20070900	75		30,38
FFH20100900	100/125		41,54
FFH20150900	150/175		57,35





ARMADIO CON 7 CASSETTI 1X50 2X75 2X100 1X150 1X200



ART.	cassetti		RAL	€
M43A085C010AEPD	100-75-50	92-96-100%	7035+7016	1221,40
M43A085C010AE08	100-75-50	92-96-100%	7035	1221,40
M43A085C010AE04	100-75-50	92-96-100%	5012	1329,90
M43A085C010AFPD	200	100%	7035+7016	1412,98
M43A085C010AF08	200	100%	7035	1412,98
M43A085C010AF04	200	100%	5012	1521,48

CONFIGURE

H=850 mm I cassetti H=50 mm hanno sempre estrazione flessibile

ARMADIO CON 7 CASSETTI 2X75 2X100 2X125 1X150



ART.	cassetti		RAL	€
M43A085C010ACPD	100-75-50	92-96-100%	7035+7016	1214,58
M43A085C010AC08	100-75-50	92-96-100%	7035	1214,58
M43A085C010AC04	100-75-50	92-96-100%	5012	1313,47
M43A085C010ADPD	200	100%	7035+7016	1438,09
M43A085C010AD08	200	100%	7035	1438,09
M43A085C010AD04	200	100%	5012	1536,98

CONFIGURE

H=850 mm

ARMADIO CON 8 CASSETTI 4X75 3X100 1X150



ART.	cassetti		RAL	€
M43A085C010AGPD	100-75-50	92-96-100%	7035+7016	1306,34
M43A085C010AG08	100-75-50	92-96-100%	7035	1306,34
M43A085C010AG04	100-75-50	92-96-100%	5012	1424,45
M43A085C010AHPD	200	100%	7035+7016	1561,78
M43A085C010AH08	200	100%	7035	1561,78
M43A085C010AH04	200	100%	5012	1679,89

CONFIGURE

H=850 mm

ARMADIO CON 7 CASSETTI 1X50 2X75 2X100 1X200 1X300



ART.	cassetti		RAL	€
M43A100C010BNPD	100-75-50	92-96-100%	7035+7016	1265,11
M43A100C010BN08	100-75-50	92-96-100%	7035	1265,11
M43A100C010BN04	100-75-50	92-96-100%	5012	1377,95
M43A100C010BPPD	200	100%	7035+7016	1456,69
M43A100C010BP08	200	100%	7035	1456,69
M43A100C010BP04	200	100%	5012	1569,53

CONFIGURE

H=1000 mm I cassetti H=50 mm hanno sempre estrazione flessibile



ARMADIO CON 8 CASSETTI 1X50 2X75 3X100 1X150 1X250



ART.	cassetti		RAL	€
	KG			
M43A100C010BQPD	100-75-50	92-96-100%	7035+7016	1357,18
M43A100C010BQ08	100-75-50	92-96-100%	7035	1357,18
M43A100C010BQ04	100-75-50	92-96-100%	5012	1474,67
M43A100C010BRPD	200	100%	7035+7016	1580,69
M43A100C010BR08	200	100%	7035	1580,69
M43A100C010BR04	200	100%	5012	1698,18

CONFIGURE

H=1000 mm I cassetti H=50 mm hanno sempre estrazione flessibile



ARMADIO CON 9 CASSETTI 3X50 2X75 2X100 1X150 1X250

ART.	cassetti		RAL	€
	KG			
M43A100C010CSPD	100-75-50	92-96-100%	7035+7016	1453,90
M43A100C010CS08	100-75-50	92-96-100%	7035	1453,90
M43A100C010CS04	100-75-50	92-96-100%	5012	1586,58
M43A100C010CTPD	200	100%	7035+7016	1645,48
M43A100C010CT08	200	100%	7035	1645,48
M43A100C010CT04	200	100%	5012	1778,16

CONFIGURE

H=1000 mm I cassetti H=50 mm hanno sempre estrazione flessibile



ARMADIO CON 9 CASSETTI 3X100 4X150 1X200 1X300

ART.	cassetti		RAL	€
	KG			
M43A150C010FAPD	100-75-50	92-96-100%	7035+7016	1665,01
M43A150C010FA08	100-75-50	92-96-100%	7035	1665,01
M43A150C010FA04	100-75-50	92-96-100%	5012	1790,87
M43A150C010FBPD	200	100%	7035+7016	1952,38
M43A150C010FB08	200	100%	7035	1952,38
M43A150C010FB04	200	100%	5012	2078,24

CONFIGURE

H=1500 mm



ARMADIO CON 9 CASSETTI 8X150 1X200

ART.	cassetti		RAL	€
	KG			
M43A150C010EYPD	100-75-50	92-96-100%	7035+7016	1663,46
M43A150C010EY08	100-75-50	92-96-100%	7035	1663,46
M43A150C010EY04	100-75-50	92-96-100%	5012	1771,34
M43A150C010EZPD	200	100%	7035+7016	1950,83
M43A150C010EZ08	200	100%	7035	1950,83
M43A150C010EZ04	200	100%	5012	2058,71

CONFIGURE

H=1500 mm



DIM. INTERNE LxP

PORTATA

ESTRAZIONE

RAL 7035 + RAL 7016

RAL 5012

RAL 7035



MATERIALE DI SEPARAZIONE



ART.	adatto per cassetto H mm	componenti	€
FFH30051000	50/300	130 x Divisorio trasversale L=36 mm 20 x Divisorio a 4 canali	51,77



ART.	adatto per cassetto H mm	componenti	€
FFH30051200	50/300	100 x Divisorio trasversale L=47 mm 20 x Divisorio a 3 canali	51,15

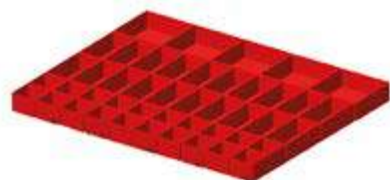

ART.	adatto per cassetto H mm	componenti	€
FFH30050700	50	20 x Cassetta divisorio 75x75 mm 20 x Cassetta divisorio 150x75 mm 5 x Cassetta divisorio 150x150 mm	44,33
FFH30070700	75		50,53

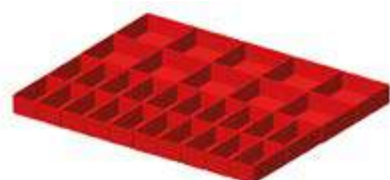

ART.	adatto per cassetto H mm	componenti	€
FFH30050800	50	20 x Cassetta divisorio 150x75 mm 10 x Cassetta divisorio 150x150 mm	40,61
FFH30070800	75		45,88
FFH30100800	100/125		53,01



ART.	adatto per cassetto H mm	componenti	€
FFH30050900	50	20 x Cassetta divisorio 150x150 mm	37,82
FFH30070900	75		43,09
FFH30100900	100/125		47,74



ART.	adatto per cassetto H mm	componenti	€
FFH30100200	100/125	2 x Divisorio longitudinale fessurato L=610 mm 8 x Divisorio trasversale L=253 mm	22,63
FFH30150200	150/175		27,90
FFH30200200	200/250		46,50
FFH30300200	300		77,19



MATERIALE DI SEPARAZIONE



ART.	adatto per cassetto H mm	componenti	€
FFH30070300	75	4 x Divisorio longitudinale fessurato L=610 mm 21 x Divisorio trasversale L=151 mm	27,28
FFH30100300	100/125		33,79
FFH30150300	150/175		48,67
FFH30200300	200/250		73,47
FFH30300300	300		144,15



ART.	adatto per cassetto H mm	componenti	€
FFH30070400	75	3 x Divisorio longitudinale fessurato L=610 mm 5 x Divisorio trasversale L=151 mm 10 x Divisorio trasversale L=202 mm	24,80
FFH30100400	100/125		32,55
FFH30150400	150/175		41,54
FFH30200400	200/250		68,20
FFH30300400	300		133,92





ARMADIO CON 5 CASSETTI 3X100 1X150 1X300

ART.	cassetti		RAL	€
M53A085C010AKPD	100-75-50	92-96-100%	7035+7016	1006,26
M53A085C010AK08	100-75-50	92-96-100%	7035	1006,26
M53A085C010AK04	100-75-50	92-96-100%	5012	1107,01
M53A085C010ALPD	200	100%	7035+7016	1165,91
M53A085C010AL08	200	100%	7035	1165,91
M53A085C010AL04	200	100%	5012	1266,66

CONFIGURE

H=850 mm



ARMADIO CON 6 CASSETTI 2X75 2X100 1X150 1X250

ART.	cassetti		RAL	€
M53A085C010AMPD	100-75-50	92-96-100%	7035+7016	1091,51
M53A085C010AM08	100-75-50	92-96-100%	7035	1091,51
M53A085C010AM04	100-75-50	92-96-100%	5012	1213,65
M53A085C010ANPD	200	100%	7035+7016	1283,09
M53A085C010AN08	200	100%	7035	1283,09
M53A085C010AN04	200	100%	5012	1405,23

CONFIGURE

H=850 mm



ARMADIO CON 7 CASSETTI 1X50 2X75 2X100 1X150 1X200

ART.	cassetti		RAL	€
M53A085C010AEPD	100-75-50	92-96-100%	7035+7016	1182,96
M53A085C010AE08	100-75-50	92-96-100%	7035	1182,96
M53A085C010AE04	100-75-50	92-96-100%	5012	1328,97
M53A085C010AFPD	200	100%	7035+7016	1374,54
M53A085C010AF08	200	100%	7035	1374,54
M53A085C010AF04	200	100%	5012	1520,55

CONFIGURE

H=850 mm I cassetti H=50 mm hanno sempre estrazione flessibile



ARMADIO CON 5 CASSETTI 2X100 2X200 1X300

ART.	cassetti		RAL	€
M53A100C010EAPD	100-75-50	92-96-100%	7035+7016	1057,72
M53A100C010EA08	100-75-50	92-96-100%	7035	1057,72
M53A100C010EA04	100-75-50	92-96-100%	5012	1155,99
M53A100C010EBPD	200	100%	7035+7016	1217,37
M53A100C010EB08	200	100%	7035	1217,37
M53A100C010EB04	200	100%	5012	1315,64

CONFIGURE

H=1000 mm



ARMADIO CON 6 CASSETTI 1X100 4X150 1X200

ART.	cassetti		RAL	€
M53A100C010DBPD	100-75-50	92-96-100%	7035+7016	1158,47
M53A100C010DB08	100-75-50	92-96-100%	7035	1158,47
M53A100C010DB04	100-75-50	92-96-100%	5012	1275,34
M53A100C010DCPD	200	100%	7035+7016	1350,05
M53A100C010DC08	200	100%	7035	1350,05
M53A100C010DC04	200	100%	5012	1466,92

CONFIGURE

H=1000 mm



ARMADIO CON 7 CASSETTI 1X50 2X75 2X100 1X200 1X300

ART.	cassetti		RAL	€
M53A100C010BNPD	100-75-50	92-96-100%	7035+7016	1228,53
M53A100C010BN08	100-75-50	92-96-100%	7035	1228,53
M53A100C010BN04	100-75-50	92-96-100%	5012	1375,16
M53A100C010BPPD	200	100%	7035+7016	1420,11
M53A100C010BP08	200	100%	7035	1420,11
M53A100C010BP04	200	100%	5012	1566,74

CONFIGURE

H=1000 mm I cassetti H=50 mm hanno sempre estrazione flessibile



ARMADIO CON 7 CASSETTI 2X75 1X100 3X150 1X200

ART.	cassetti		RAL	€
M53A100C010AWPD	100-75-50	92-96-100%	7035+7016	1243,10
M53A100C010AW08	100-75-50	92-96-100%	7035	1243,10
M53A100C010AW04	100-75-50	92-96-100%	5012	1383,22
M53A100C010BHPD	200	100%	7035+7016	1466,61
M53A100C010BH08	200	100%	7035	1466,61
M53A100C010BH04	200	100%	5012	1606,73

CONFIGURE

H=1000 mm



ARMADIO CON 8 CASSETTI 1X50 2X75 2X100 2X150 1X200

ART.	cassetti		RAL	€
M53A100C010CUPD	100-75-50	92-96-100%	7035+7016	1329,28
M53A100C010CU08	100-75-50	92-96-100%	7035	1329,28
M53A100C010CU04	100-75-50	92-96-100%	5012	1494,51
M53A100C010CVPD	200	100%	7035+7016	1552,79
M53A100C010CV08	200	100%	7035	1552,79
M53A100C010CV04	200	100%	5012	1718,02

CONFIGURE

H=1000 mm I cassetti H=50 mm hanno sempre estrazione flessibile



DIM. INTERNE LxP

PORTATA

ESTRAZIONE

RAL 7035 + RAL 7016

RAL 5012

RAL 7035



ARMADIO CON 8 CASSETTI 2X75 3X100 3X150



ART.	cassetti		RAL	€
M53A100C010DDPD	100-75-50	92-96-100%	7035+7016	1337,65
M53A100C010DD08	100-75-50	92-96-100%	7035	1337,65
M53A100C010DD04	100-75-50	92-96-100%	5012	1500,09
M53A100C010DEPD	200	100%	7035+7016	1593,09
M53A100C010DE08	200	100%	7035	1593,09
M53A100C010DE04	200	100%	5012	1755,53

CONFIGURE

H=1000 mm

ARMADIO CON 10 CASSETTI 1X50 2X75 7X100



ART.	cassetti		RAL	€
M53A100C010DFPD	100-75-50	92-96-100%	7035+7016	1518,38
M53A100C010DF08	100-75-50	92-96-100%	7035	1518,38
M53A100C010DF04	100-75-50	92-96-100%	5012	1728,25
M53A100C010DGPDP	200	100%	7035+7016	1805,75
M53A100C010DG08	200	100%	7035	1805,75
M53A100C010DG04	200	100%	5012	2015,62

CONFIGURE

H=1000 mm I cassetti H=50 mm hanno sempre estrazione flessibile

ARMADIO CON 9 CASSETTI 2X75 2X100 1X150 3X200 1X300



ART.	cassetti		RAL	€
M53A150C010LXPD	100-75-50	92-96-100%	7035+7016	1611,69
M53A150C010LX08	100-75-50	92-96-100%	7035	1611,69
M53A150C010LX04	100-75-50	92-96-100%	5012	1790,56
M53A150C010LYPD	200	100%	7035+7016	1899,06
M53A150C010LY08	200	100%	7035	1899,06
M53A150C010LY04	200	100%	5012	2077,93

CONFIGURE

H=1500 mm

ARMADIO CON 9 CASSETTI 2X100 6X150 1X300



ART.	cassetti		RAL	€
M53A150C010FJPD	100-75-50	92-96-100%	7035+7016	1621,61
M53A150C010FJ08	100-75-50	92-96-100%	7035	1621,61
M53A150C010FJ04	100-75-50	92-96-100%	5012	1799,55
M53A150C010FKPD	200	100%	7035+7016	1908,98
M53A150C010FK08	200	100%	7035	1908,98
M53A150C010FK04	200	100%	5012	2086,92

CONFIGURE

H=1500 mm



ARMADIO CON 10 CASSETTI 1X50 4X100 1X150 4X200



ART.	cassetti		RAL	€
M53A150C010LZPD	100-75-50	92-96-100%	7035+7016	1713,99
M53A150C010LZ08	100-75-50	92-96-100%	7035	1713,99
M53A150C010LZ04	100-75-50	92-96-100%	5012	1913,63
M53A150C010MAPD	200	100%	7035+7016	2001,36
M53A150C010MA08	200	100%	7035	2001,36
M53A150C010MA04	200	100%	5012	2201,00

H=1500 mm I cassetti H=50 mm hanno sempre estrazione flessibile

CONFIGURE



ARMADIO 2XPF 2XPE

ART.	piani estraibili		RAL	€
M53A200C010SVPD	200	100%	7035+7016	1161,88
M53A200C010SV08	200	100%	7035	1161,88
M53A200C010SV04	200	100%	5012	1204,66

H=2000 mm

CONFIGURE



ARMADIO CON 4 CASSETTI 2XPF 1X150 1X200 1X250 1X300

ART.	cassetti		RAL	€
M53A200C010SXPD	200	100%	7035+7016	1519,31
M53A200C010SX08	200	100%	7035	1519,31
M53A200C010SX04	200	100%	5012	1596,50

H=2000 mm

CONFIGURE

PE: PIANO ESTRAIBILE
 PF: PIANO FESSURATO



DIM. INTERNE LxP



PORTATA



ESTRAZIONE



RAL 7035 + RAL 7016



RAL 5012



RAL 7035



ARMADIO CON 7 CASSETTI 2XPF 1X50 1X75 1X100 1X125 1X150 2X200



ART.	cassetti		RAL	€
M53A200C010SWPD	200	100%	7035+7016	1863,41
M53A200C010SW08	200	100%	7035	1863,41
M53A200C010SW04	200	100%	5012	2005,39

H=2000 mm I cassetti H=50 mm hanno sempre estrazione flessibile

CONFIGURE



ARMADIO CON PORTE 2XPF 2XPE



ART.	piani estraibili		RAL	€
M53A200C010SUPD	100-75-50	92-96-100%	7035+7016	1294,87
M53A200C010SU08	100-75-50	92-96-100%	7035	1294,87
M53A200C010SU04	100-75-50	92-96-100%	5012	1337,65

H=2000 mm

CONFIGURE



ARMADIO CON PORTE CON 7 CASSETTI 2XPR 2X75 1X100 3X150 1X200



ART.	cassetti		RAL	€
M53A200C010TAPD	100-75-50	92-96-100%	7035+7016	1884,49
M53A200C010TA08	100-75-50	92-96-100%	7035	1884,49
M53A200C010TA04	100-75-50	92-96-100%	5012	2023,99
M53A200C010TBPD	200	100%	7035+7016	2108,00
M53A200C010TB08	200	100%	7035	2108,00
M53A200C010TB04	200	100%	5012	2247,50

H=2000 mm



ARMADIO CON PORTE CON 3 CASSETTI 2XPR 2X100 1X150 2XPE



ART.	cassetti / piani estraibili		RAL	€
	KG			
M53A200C010FWPD	100-75-50	92-96-100%	7035+7016	1710,27
M53A200C010FW08	100-75-50	92-96-100%	7035	1710,27
M53A200C010FW04	100-75-50	92-96-100%	5012	1813,19
M53A200C010FXPD	200	100%	7035+7016	1869,92
M53A200C010FX08	200	100%	7035	1869,92
M53A200C010FX04	200	100%	5012	1972,84

H=2000 mm

CONFIGURE



ARMADIO CON RUOTE CON 7 CASSETTI 2X75 3X100 2X150



ART.	cassetti		RAL	€
	KG			
M53R085C01095PD	100-75-50	92-96-100%	7035+7016	1543,18
M53R085C0109508	100-75-50	92-96-100%	7035	1543,18
M53R085C0109504	100-75-50	92-96-100%	5012	1686,40

H=1117 mm

Ruote: Gomma elastica Ø 160 mm
Portata armadio: 900 kg

CONFIGURE



PE: PIANO ESTRAIBILE
PR: PIANO REGOLABILE
PF: PIANO FESSURATO



DIM. INTERNE LxP



PORTATA



ESTRAZIONE



RAL 7035 + RAL 7016



RAL 5012



RAL 7035



MATERIALE DI SEPARAZIONE



ART.	adatto per cassetto H mm	componenti	€
FFH50050900	50/300	15 x Divisorio trasversale L=36 mm 10 x Divisorio trasversale L=47 mm 6 x Divisorio trasversale L=73 mm 8 x Divisorio a 2 canali 8 x Divisorio a 3 canali 8 x Divisorio a 4 canali	46,19



ART.	adatto per cassetto H mm	componenti	€
FFH50051900	50/300	30 x Divisorio trasversale L=36 mm 10 x Divisorio trasversale L=47 mm 8 x Divisorio a 3 canali 16 x Divisorio a 4 canali	50,22



ART.	adatto per cassetto H mm	componenti	€
FFH50050800	50	12 x Cassetta divisorio 150x75 mm 18 x Cassetta divisorio 150x150 mm	44,95
FFH50070800	75		55,18
FFH50100800	100/125		62,00

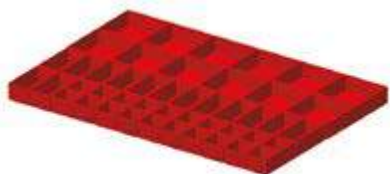

ART.	adatto per cassetto H mm	componenti	€
FFH50051700	50	14 x Cassetta divisorio 150x75 mm 12 x Cassetta divisorio 150x150 mm	49,91
FFH50071700	75		59,83



ART.	adatto per cassetto H mm	componenti	€
FFH50051800	50	24 x Cassetta divisorio 150x150 mm	43,40
FFH50071800	75		53,32
FFH50101800	100/125		58,90



ART.	adatto per cassetto H mm	componenti	€
FFH50050700	50	4 x Divisorio longitudinale fessurato L=610 mm 2 x Divisorio trasversale L=151 mm 3 x Divisorio trasversale L=202 mm	25,42
FFH50070700	75		23,56
FFH50100700	100/125		26,66
FFH50150700	150/175		31,00
FFH50200700	200/250		55,18
FFH50300700	300		124,31



MATERIALE DI SEPARAZIONE



ART.	adatto per cassetto H mm	componenti	€
FFH50051000	50	2 x Divisorio longitudinale fessurato L=610 mm 2 x Divisorio trasversale L=304 mm	15,50
FFH50071000	75		15,50
FFH50101000	100/125		16,43
FFH50151000	150/175		17,98
FFH50201000	200/250		27,59
FFH50301000	300		65,72



ART.	adatto per cassetto H mm	componenti	€
FFH50051300	50	5 x Divisorio longitudinale fessurato L=610 mm 12 x Divisorio trasversale L=151 mm	32,24
FFH50071300	75		24,80
FFH50101300	100/125		31,00
FFH50151300	150/175		44,95
FFH50201300	200/250		77,81
FFH50301300	300		167,09



ART.	adatto per cassetto H mm	componenti	€
FFH50051500	50	7 x Divisorio longitudinale fessurato L=610 mm 12 x Divisorio trasversale L=100 mm 2 x Divisorio trasversale L=151 mm	41,23
FFH50071500	75		31,31
FFH50101500	100/125		39,68





ARMADIO CON 7 CASSETTI 2X75 2X100 1X150 2X200



ART.	cassetti		RAL	€
M63A100C010DYPD	100-75-50	92-96-100%	7035+7016	1550,93
M63A100C010DY08	100-75-50	92-96-100%	7035	1550,93
M63A100C010DY04	100-75-50	92-96-100%	5012	1596,19
M63A100C010DZPD	200	100%	7035+7016	1774,44
M63A100C010DZ08	200	100%	7035	1774,44
M63A100C010DZ04	200	100%	5012	1819,70

CONFIGURE

H=1000 mm

ARMADIO CON 8 CASSETTI 2X75 4X100 1X150 1X200



ART.	cassetti		RAL	€
M63A100C010CNPD	100-75-50	92-96-100%	7035+7016	1679,27
M63A100C010CN08	100-75-50	92-96-100%	7035	1679,27
M63A100C010CN04	100-75-50	92-96-100%	5012	1726,39
M63A100C010CPPD	200	100%	7035+7016	1934,71
M63A100C010CP08	200	100%	7035	1934,71
M63A100C010CP04	200	100%	5012	1981,83

CONFIGURE

H=1000 mm

ARMADIO CON 8 CASSETTI 2X75 3X100 3X150



ART.	cassetti		RAL	€
M63A100C010DDPD	100-75-50	92-96-100%	7035+7016	1671,21
M63A100C010DD08	100-75-50	92-96-100%	7035	1671,21
M63A100C010DD04	100-75-50	92-96-100%	5012	1724,22
M63A100C010DEPD	200	100%	7035+7016	1926,65
M63A100C010DE08	200	100%	7035	1926,65
M63A100C010DE04	200	100%	5012	1979,66

CONFIGURE

H=1000 mm

ARMADIO CON 10 CASSETTI 2X150 1X125 1X75 2X100 2X150 2X200



ART.	cassetti		RAL	€
M63A150C010MCPD	200	100%	7035+7016	2492,40
M63A150C010MC08	200	100%	7035	2492,40
M63A150C010MC04	200	100%	5012	2573,31

CONFIGURE

H=1500 mm



ARMADIO CON 11 CASSETTI 1X150 1X125 1X75 4X100 3X150 1X200

ART.	cassetti		RAL	€
M63A150C010MEPD	200	100%	7035+7016	2652,67
M63A150C010ME08	200	100%	7035	2652,67
M63A150C010ME04	200	100%	5012	2735,44

H=1500 mm

CONFIGURE



ARMADIO CON 7 CASSETTI 2XPR 2X75 1X100 3X150 1X200

ART.	cassetti		RAL	€
M63A200C010FTPD	200	100%	7035+7016	2347,01
M63A200C010FT08	200	100%	7035	2347,01
M63A200C010FT04	200	100%	5012	2397,85

H=2000 mm

CONFIGURE



ARMADIO CON PORTE CON 7 CASSETTI 2XPR 2X75 1X100 3X150 1X200

ART.	cassetti		RAL	€
M63A200C010TBPD	200	100%	7035+7016	2562,15
M63A200C010TB08	200	100%	7035	2562,15
M63A200C010TB04	200	100%	5012	2613,30

H=2000 mm



MATERIALE DI SEPARAZIONE



ART.	adatto per cassetto H mm	componenti	€
FFH60070200	75		29,14
FFH60100200	100/125	4 x Divisorio longitudinale fessurato L=610 mm 3 x Divisorio trasversale L=151 mm 3 x Divisorio trasversale L=168 mm 9 x Divisorio trasversale L=253 mm	34,72
FFH60150200	150/175		50,22
FFH60200200	200/250		71,30



ART.	adatto per cassetto H mm	componenti	€
FFH60070500	75	5 x Divisorio longitudinale fessurato L=610 mm 6 x Divisorio trasversale L=134 mm 9 x Divisorio trasversale L=202 mm	29,76
FFH60100500	100/125		35,96
FFH60150500	150/175		52,08

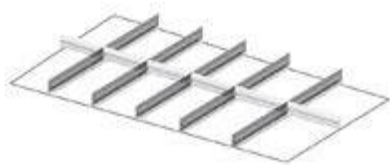

ART.	adatto per cassetto H mm	componenti	€
FFH60070800	75	5 x Divisorio longitudinale fessurato L=610 mm 2 x Divisorio trasversale L=151 mm 1 x Divisorio trasversale L=168 mm 3 x Divisorio trasversale L=202 mm	21,39
FFH60100800	100/125		27,28
FFH60150800	150/175		38,75
FFH60200800	200/250		59,21
FFH60300800	300		132,68



ART.	adatto per cassetto H mm	componenti	€
FFH60071100	75	6 x Divisorio longitudinale fessurato L=610 mm 6 x Divisorio trasversale L=151 mm 1 x Divisorio trasversale L=168 mm	24,80
FFH60101100	100/125		31,62
FFH60151100	150/175		44,64
FFH60201100	200/250		68,51
FFH60301100	300		155,62





ARMADIO CON 5 CASSETTI 2X100 2X200 1X300



ART.	cassetti		RAL	€
M73A100C010EAPD	100-75-50	92-96-100%	7035+7016	1477,77
M73A100C010EA08	100-75-50	92-96-100%	7035	1477,77
M73A100C010EA04	100-75-50	92-96-100%	5012	1568,91
M73A100C010EBPD	200	100%	7035+7016	1637,42
M73A100C010EB08	200	100%	7035	1637,42
M73A100C010EB04	200	100%	5012	1728,56

CONFIGURE

H=1000 mm

ARMADIO CON 7 CASSETTI 2X75 2X100 1X150 2X200



ART.	cassetti		RAL	€
M73A100C010DYPD	100-75-50	92-96-100%	7035+7016	1709,65
M73A100C010DY08	100-75-50	92-96-100%	7035	1709,65
M73A100C010DY04	100-75-50	92-96-100%	5012	1841,09
M73A100C010DZPD	200	100%	7035+7016	1933,16
M73A100C010DZ08	200	100%	7035	1933,16
M73A100C010DZ04	200	100%	5012	2064,60

CONFIGURE

H=1000 mm

ARMADIO CON 8 CASSETTI 2X75 4X100 1X150 1X200



ART.	cassetti		RAL	€
M73A100C010CNPD	100-75-50	92-96-100%	7035+7016	1844,50
M73A100C010CN08	100-75-50	92-96-100%	7035	1844,50
M73A100C010CN04	100-75-50	92-96-100%	5012	2010,97
M73A100C010CPPD	200	100%	7035+7016	2099,94
M73A100C010CP08	200	100%	7035	2099,94
M73A100C010CP04	200	100%	5012	2266,41

CONFIGURE

H=1000 mm

ARMADIO CON 10 CASSETTI 2X150 1X125 1X75 2X100 2X150 2X200



ART.	cassetti		RAL	€
M73A150C010MCPD	200	100%	7035+7016	2674,99
M73A150C010MC08	200	100%	7035	2674,99
M73A150C010MC04	200	100%	5012	2854,48

CONFIGURE

H=1500 mm



ARMADIO CON 11 CASSETTI 1X150 1X125 1X75 4X100 3X150 1X200

ART.	cassetti		RAL	€
M73A150C010MEPD	200	100%	7035+7016	2842,08
M73A150C010ME08	200	100%	7035	2842,08
M73A150C010ME04	200	100%	5012	3056,29

H=1500 mm

CONFIGURE



ARMADIO CON 7 CASSETTI 2XPR 2X75 1X100 3X150 1X200

ART.	cassetti		RAL	€
M73A200C010FTPD	200	100%	7035+7016	2485,89
M73A200C010FT08	200	100%	7035	2485,89
M73A200C010FT04	200	100%	5012	2608,34

H=2000 mm

CONFIGURE



ARMADIO CON PORTE CON 7 CASSETTI 2XPR 2X75 1X100 3X150 1X200

ART.	cassetti		RAL	€
M73A200C010TBPD	200	100%	7035+7016	2710,33
M73A200C010TB08	200	100%	7035	2710,33
M73A200C010TB04	200	100%	5012	2832,16

H=2000 mm



MATERIALE DI SEPARAZIONE



ART.	adatto per cassetto H mm	componenti	€
FFH70070200	75		31,62
FFH70100200	100/125	5 x Divisorio longitudinale fessurato L=610 mm 6 x Divisorio trasversale L=151 mm	37,82
FFH70150200	150/175	9 x Divisorio trasversale L=253 mm	54,56
FFH70200200	200/250		80,29



ART.	adatto per cassetto H mm	componenti	€
FFH70070300	75		37,51
FFH70100300	100/125	6 x Divisorio longitudinale fessurato L=610 mm 3 x Divisorio trasversale L=134 mm	45,57
FFH70150300	150/175	3 x Divisorio trasversale L=168 mm 14 x Divisorio trasversale L=202 mm	66,34

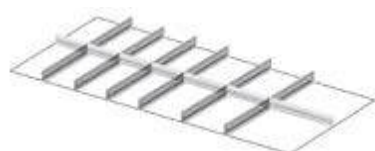

ART.	adatto per cassetto H mm	componenti	€
FFH70070700	75		25,73
FFH70100700	100/125	6 x Divisorio longitudinale fessurato L=610 mm	32,24
FFH70150700	150/175	4 x Divisorio trasversale L=151 mm 2 x Divisorio trasversale L=202 mm	45,88
FFH70200700	200/250	1 x Divisorio trasversale L=304 mm	70,99
FFH70300700	300		159,96

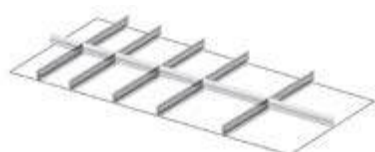

ART.	adatto per cassetto H mm	componenti	€
FFH70070800	75		22,63
FFH70100800	100/125	5 x Divisorio longitudinale fessurato L=610 mm	28,21
FFH70150800	150/175	2 x Divisorio trasversale L=151 mm 2 x Divisorio trasversale L=202 mm	39,99
FFH70200800	200/250	2 x Divisorio trasversale L=304 mm	61,07
FFH70300800	300		137,64













MASTER

ACCESSORI













TOP IN ACCIAIO INOX

ART.	adatto per armadio EH	L mm	P mm	H mm	€
 M12T030MDNX710A	18x27	408	573	31	127,10
 M22T030MDNX710A	27x27	561	573	31	145,39
 M32T030MDNX710A	36x27	714	573	31	164,92
 M52T030MDNX710A	54x27	1020	573	31	205,22
 M23T030MDNX710A	27x36	561	726	31	165,54
 M33T030MDNX710A	36x36	714	726	31	189,41
 M43T030MDNX710A	45x36	867	726	31	216,07
 M53T030MDNX710A	54x36	1020	726	31	237,46
 M63T030MDNX710A	64x36	1190	726	31	265,05
 M73T030MDNX710A	78x36	1428	726	31	302,87



TOP IN ACCIAIO GOMMATO

ART.	adatto per armadio EH	L mm	P mm	H mm	colore	€
 M12T030MDGM7107	18x27	408	573	32	Nero	130,82
 M22T030MDGM7107	27x27	561	573	32	Nero	152,21
 M32T030MDGM7107	36x27	714	573	32	Nero	160,27
 M52T030MDGM7107	54x27	1020	573	32	Nero	222,58
 M23T030MDGM7107	27x36	561	726	32	Nero	161,20
 M33T030MDGM7107	36x36	714	726	32	Nero	169,57
 M43T030MDGM7107	45x36	867	726	32	Nero	198,09
 M53T030MDGM7107	54x36	1020	726	32	Nero	234,36
 M63T030MDGM7107	64x36	1190	726	32	Nero	246,14
 M73T030MDGM7107	78x36	1428	726	32	Nero	262,88



TOP IN MULTIPLEX

ART.	adatto per armadio EH	L mm	P mm	H mm	€
 M12T030MU000100	18x27	408	573	30	79,05
 M22T030MU000100	27x27	561	573	30	89,59
 M32T030MU000100	36x27	714	573	30	93,62
 M52T030MU000100	54x27	1020	573	30	114,39
 M23T030MU000100	27x36	561	726	30	100,75
 M33T030MU000100	36x36	714	726	30	106,64
 M43T030MU000100	45x36	867	726	30	128,96
 M53T030MU000100	54x36	1020	726	30	128,03
 M63T030MU000100	64x36	1190	726	30	146,01
 M73T030MU000100	78x36	1428	726	30	162,75

MASTER

ACCESSORI



TOP A 3 BORDI RIVESTITO IN PVC

ART.	adatto per armadio EH	L mm	P mm	H mm	colore	€
M12T023AG003107	18x27	409	576	23	Nero	53,32
M22T023AG003107	27x27	562	576	23	Nero	59,21
M32T023AG003107	36x27	715	576	23	Nero	63,55
M52T023AG003107	54x27	1021	576	23	Nero	84,63
M23T023AG003107	27x36	562	729	23	Nero	63,55
M33T023AG003107	36x36	715	729	23	Nero	88,97
M43T023AG003107	45x36	868	729	23	Nero	95,79
M53T023AG003107	54x36	1021	729	23	Nero	91,45
M63T023AG003107	64x36	1191	729	23	Nero	98,27
M73T023AG003107	78x36	1429	729	23	Nero	98,27

ZOCCOLO DI RIALZO H=50 mm



ART.	adatto per armadio EH	L mm	P mm	H mm	RAL	€
M12Z05000000008	18x27	406	572	50	7035	60,14
M12Z05000000004	18x27	406	572	50	5012	60,14
M22Z05000000008	27x27	559	572	50	7035	63,24
M22Z05000000004	27x27	559	572	50	5012	63,24
M32Z05000000008	36x27	712	572	50	7035	64,48
M32Z05000000004	36x27	712	572	50	5012	64,48
M52Z05000000008	54x27	1018	572	50	7035	70,37
M52Z05000000004	54x27	1018	572	50	5012	70,37
M23Z05000000008	27x36	559	725	50	7035	61,07
M23Z05000000004	27x36	559	725	50	5012	61,07
M33Z05000000008	36x36	712	725	50	7035	66,34
M33Z05000000004	36x36	712	725	50	5012	66,34
M43Z05000000008	45x36	865	725	50	7035	70,06
M43Z05000000004	45x36	865	725	50	5012	70,06
M53Z05000000008	54x36	1018	725	50	7035	67,89
M53Z05000000004	54x36	1018	725	50	5012	67,89
M63Z05000000008	64x36	1188	725	50	7035	76,57
M63Z05000000004	64x36	1188	725	50	5012	76,57
M73Z05000000008	78x36	1426	725	50	7035	78,43
M73Z05000000004	78x36	1426	725	50	5012	78,43

RAL 5012

RAL 7035



ZOCCOLO DI RIALZO H=100 mm

ART.	adatto per armadio EH	L mm	P mm	H mm	RAL	€
 M12Z10000000008	18x27	406	572	100	7035	63,24
 M12Z10000000004	18x27	406	572	100	5012	63,24
 M22Z10000000008	27x27	559	572	100	7035	65,41
 M22Z10000000004	27x27	559	572	100	5012	65,41
 M32Z10000000008	36x27	712	572	100	7035	70,37
 M32Z10000000004	36x27	712	572	100	5012	70,37
 M52Z10000000008	54x27	1018	572	100	7035	76,57
 M52Z10000000004	54x27	1018	572	100	5012	76,57
 M23Z10000000008	27x36	559	725	100	7035	67,89
 M23Z10000000004	27x36	559	725	100	5012	67,89
 M33Z10000000008	36x36	712	725	100	7035	71,30
 M33Z10000000004	36x36	712	725	100	5012	71,30
 M43Z10000000008	45x36	865	725	100	7035	76,88
 M43Z10000000004	45x36	865	725	100	5012	76,88
 M53Z10000000008	54x36	1018	725	100	7035	79,05
 M53Z10000000004	54x36	1018	725	100	5012	79,05
 M63Z10000000008	64x36	1188	725	100	7035	84,01
 M63Z10000000004	64x36	1188	725	100	5012	84,01
 M73Z10000000008	78x36	1426	725	100	7035	88,35
 M73Z10000000004	78x36	1426	725	100	5012	88,35



MASTER

ACCESSORI



ZOCCOLO PER CARRELLO ELEVATORE E TRANSPALLET

ART.	adatto per armadio EH	L mm	P mm	H mm	RAL	€
M32Z10010000039	36x27	712	569	100	7016	83,70
M23Z10010000039	27x36	559	722	100	7016	88,35
M33Z10010000039	36x36	712	722	100	7016	87,73
M43Z10010000039	45x36	865	722	100	7016	108,81

CHIUSURA PER ZOCCOLO

ART.	adatto per armadio L EH	L mm	P mm	H mm	RAL	€
M20Z10011000039	27	555	46	95	7016	28,52
M30Z10011000039	36	708	46	95	7016	17,36
M40Z10011000039	45	861	46	95	7016	28,52



COPPIA ZOCCOLI PER CARRELLO ELEVATORE E TRANSPALLET

ART.	adatto per armadio EH	L mm	P mm	H mm	RAL	€
M02Z10020000039	54x27	200	569	100	7016	65,72
M03Z10020000039	54x36 64x36 78x36	200	722	100	7016	69,75



CHIUSURA PER ZOCCOLO

ART.	adatto per armadio L EH	L mm	P mm	H mm	RAL	€
M50Z10021000039	54	1014	46	95	7016	25,11
M60Z10021000039	64	1184	46	95	7016	30,07
M70Z10021000039	78	1422	46	95	7016	31,93



RAL 5012



RAL 7016



RAL 7035

START

PRO

PRO+

START

PRO

PRO+

ARMADI PORTA PC ARMADI PORTA PC

MASTER CS

STANDARD CS



Gli armadi porta PC della serie Master CS e Standard CS sono impiegati come **postazioni di lavoro** in reparti, aree produttive e magazzini. La resistente struttura in metallo, infatti, protegge **computer e hardware** da sporcizia e possibili urti ed è dotata di fori per cavi di rete, per il cavo elettrico e di un foro di entrata dell'aria con filtro antipolvere. **Standard CS** è una soluzione **monoblocco** con vano porta schermi, cassetto e vano inferiore con ante a battenti e piani. **Master CS**, invece, è **componibile** e presenta un armadio inferiore ad ante a battenti con cassetto e piani, mentre la parte superiore può essere lasciata libera oppure allestita con un armadio con porta in policarbonato.

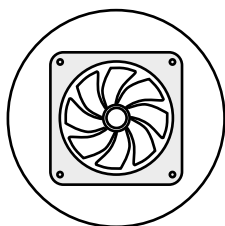

**VENTILAZIONE
FORZATA**

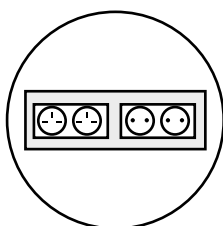

**IMPIANTO ELETTRICO
CON PRESE DE CH GB
FR**

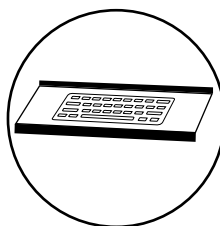

**PIANO PER TASTIERA
ESTRAIBILE**

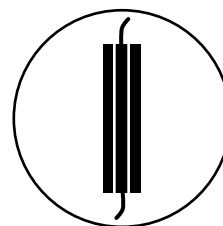

**CANALETTA PER
GESTIONE PASSAGGIO
CAVI**

ARMADI PORTA COMPUTER

MASTER CS

1. Porta con serratura di sicurezza e vetro in policarbonato.
Dimensioni utili: 655x215x465 mm H
2. Possibilità di inserimento video fino a 21".
Dimensioni interne del vano superiore: 710x215x530 mm H
3. Cassetto estraibile con piano porta tastiera e 2 posizioni di bloccaggio, in apertura spazio posteriore per contenimento oggetti.
Dimensioni utili: 655x465 mm H
4. Vano con possibilità di inserimento di piani estraibili e piani regolabili in altezza, per l'alloggiamento di sistemi hardware e stampanti.
Larghezza inserimento utile: 663 mm. Altezza utile: 754 mm
5. Foro per cavi di rete e foro di uscita del cavo per l'impianto elettrico
6. Foro di entrata dell'aria con filtro antipolvere
7. Impianto elettrico a 4 prese Schuko
8. Canalette porta cavi a 4 corsie
9. Ventola di raffreddamento con filtro antipolvere
10. Piano estraibile.
Dimensioni: 602x449 mm
11. Piano regolabile.
Dimensioni 663x560x52 mm H



Armadio acquistabile senza il modulo superiore. Ottimo per soluzioni con computer portatili e schermi touch screen.



STANDARD CS

12. Porta con serratura di sicurezza e vetro in policarbonato.
Dimensioni utili: 661x525 mm H
13. Possibilità di inserimento video fino a 21".
Dimensioni interne del vano superiore: 690x600x580 mm H
14. Piano porta tastiera.
Dimensioni utili: 620x510 mm H
15. Vano inferiore con possibilità di inserimento di piani estraibili e piani regolabili in altezza, per l'alloggiamento di sistemi hardware e stampanti.
Dimensioni interne: 690x600x720 mm H
16. Foro per cavi di rete e foro di uscita del cavo per l'impianto elettrico
17. Foro di entrata dell'aria con filtro antipolvere
18. Impianto elettrico a 4 prese Schuko
19. Canalette porta cavi a 4 corsie
20. Ventola di raffreddamento con filtro antipolvere
21. Piano estraibile.
Dimensioni: 650x582x36 mm H
22. Piano regolabile.
Dimensioni 688x591x38 mm H



MASTER CS

POSTAZIONE PC

[CONFIGURE](#)

[SHOP](#)



ARMADIO PORTA COMPUTER CON RUOTE

ART.	L mm	P mm	H mm	set ruote	RAL	€
MASTERC01	792	617	1731	450	7035	1413,91

Composto da:

qtà	descrizione
1	Armadio inferiore con 1 cassetto
1	Armadio superiore con porta in policarbonato
1	Maniglia a tubo
1	Piano estraibile a estrazione flessibile con maniglia Dark Grey
1	Supporto presa
1	Multipresa schuko a 4 scomparti
1	Cavo di collegamento wieland schuko/francese
1	Ventola 230 V senza griglia con spina Schuko
1	Kit 4 ruote in nylon Ø 100 mm



ARMADIO SUPERIORE CON PORTA IN POLICARBONATO

ART.	L mm	P mm	H mm	RAL	€
FAS1450C01008	714	247	650	7035	296,05

Possibilità di inserimento video fino a 24"

[SHOP](#)



ARMADIO SUPERIORE CON TAPPARELLA

ART.	L mm	P mm	H mm	RAL	€
FAS1450C02008	714	247	650	7035	328,91

Possibilità di inserimento video fino a 24"

[SHOP](#)



[CONFIGURE](#)

[SHOP](#)



piano porta tastiera

ARMADIO INFERIORE CON 1 CASSETTO

ART.	L mm	P mm	H mm	n. cassetti	n. piani porta tastiera	n. piani regolabili	RAL	€
FAS1400C00508	714	598	950	200	1	1	7035	864,90

MASTER CS

COMPONENTI

KIT RUOTE



ART.	Ø mm	KG	KG	H mm	materiale				€
FKRU1252101	125	100	300	155	Gomma antitraccia sintetica	-	2	2	56,73
FKRV1001107	100	150	450	128	Nylon	1	1	2	54,25



RUOTA GIREVOLE



RUOTA GIREVOLE CON FRENO



RUOTA FISSA



PIANO ESTRAIBILE A ESTRAZIONE FLESSIBILE CON MANIGLIA DARK GREY 36X27 EH

ART.	dim. utili		RAL	€
	L mm	P mm		
M32C05701101F39	602	449	7016	92,69

SHOP



MANIGLIA A TUBO

ART.	L mm	P mm	H mm	RAL	€
M02R00000000007	484	80	46	9005	15,19

SHOP



VENTOLA 230 V SENZA GRIGLIA CON SPINA SCHUKO

ART.	L mm	P mm	H mm	colore	€
FAS32200100	125	44	125	Nero	33,79

SHOP



TOP A 3 BORDI RIVESTITO IN PVC CON FORO PASSACAVI 36X27 EH

ART.	L mm	P mm	H mm	colore	€
M32T023AG007107	715	576	31	Nero	63,86

SHOP



SUPPORTO PRESA

ART.	L mm	P mm	H mm	finitura	€
FAS30210099	542	10	77	Zincato	10,54

SHOP



ESEMPI SCHEMA MULTIPRESE SU SUPPORTO PRESA



Con multipresa a 4 scomparti



Con multipresa a 2 scomparti + multipresa a 4 scomparti

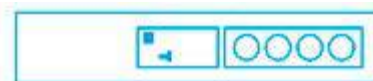

Con magnetotermico + multipresa a 4 scomparti

IRONTEAM

vedi pag. 328



FBLET012007



FBLET004007



FBLET005007



FBLET016007



PORTATA



RAL 7016



RAL 7035



RAL 9005



ZINCATO

STANDARD CS

POSTAZIONE PC

[CONFIGURE](#)

[SHOP](#)

PATENTED



ARMADIO PORTA COMPUTER CON RUOTE

ART.	L mm	P mm	H mm	set ruote	RAL	€
STANDARDCS01	807	654	1688	450	7035	961,00

Composto da:

qtà	descrizione
1	Armadio porta computer
1	Maniglia a tubo
1	Supporto presa
1	Piano estraibile a estrazione semplice
1	Multipresa schuko a 4 scomparti
1	Cavo di collegamento wieland schuko/francese
1	Ventola 230 V senza griglia con spina Schuko
1	Kit 4 ruote in nylon Ø 100 mm



[CONFIGURE](#)

ARMADIO PORTA COMPUTER



ART.	L mm	P mm	H mm	n. piani porta tastiera	n. piani regolabili	RAL	€	
FAS1600C00208	717	635	1560	400	1	2	7035	732,84
FAS1600C00204	717	635	1560	400	1	2	5012	753,30

STANDARD CS

COMPONENTI



KIT RUOTE



ART.	Ø mm	KG	KG	H mm	materiale				€
FKRU1252101	125	100	300	155	Gomma antitraccia sintetica	-	2	2	56,73
FKRV1001107	100	150	450	128	Nylon	1	1	2	54,25



RUOTA GIREVOLE



RUOTA GIREVOLE CON FRENO



RUOTA FISSA



PIANO ESTRAIBILE A ESTRAZIONE SEMPLICE

ART.	L mm	P mm	H mm	RAL	€
FAS2360S039	650	582	36	7016	65,72

SHOP



PIANO REGOLABILE CON GANCI

ART.	L mm	P mm	H mm	RAL	€
FAS2040S139	688	591	38	7016	52,08

SHOP



MANIGLIA A TUBO

ART.	L mm	P mm	H mm	RAL	€
FCL09950007	502	80	46	9005	17,36

SHOP



VENTOLA 230 V SENZA GRIGLIA CON SPINA SCHUKO

ART.	L mm	P mm	H mm	colore	€
FAS32200100	125	44	125	Nero	33,79

SHOP



COPIA ZOCOLI

ART.	L mm	P mm	H mm	RAL	€
FRR16250039	59	608	100	7016	38,44

SHOP



SUPPORTO PRESA

ART.	L mm	P mm	H mm	finitura	€
FAS30210099	542	10	77	Zincato	10,54

SHOP



ESEMPI SCHEMA MULTIPRESE SU SUPPORTO PRESA



Con multipresa a 4 scomparti



Con multipresa a 2 scomparti + multipresa a 4 scomparti

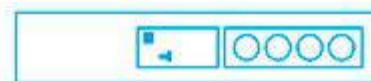

Con magnetotermico + multipresa a 4 scomparti

IRONTEAM

vedi pag. 328



FBLET012007



FBLET004007



FBLET005007



FBLET016007



PORTATA



RAL 5012



RAL 7016



RAL 7035



RAL 9005



ZINCATO

ARMADI CON PORTE A BATTENTE

PERFOM

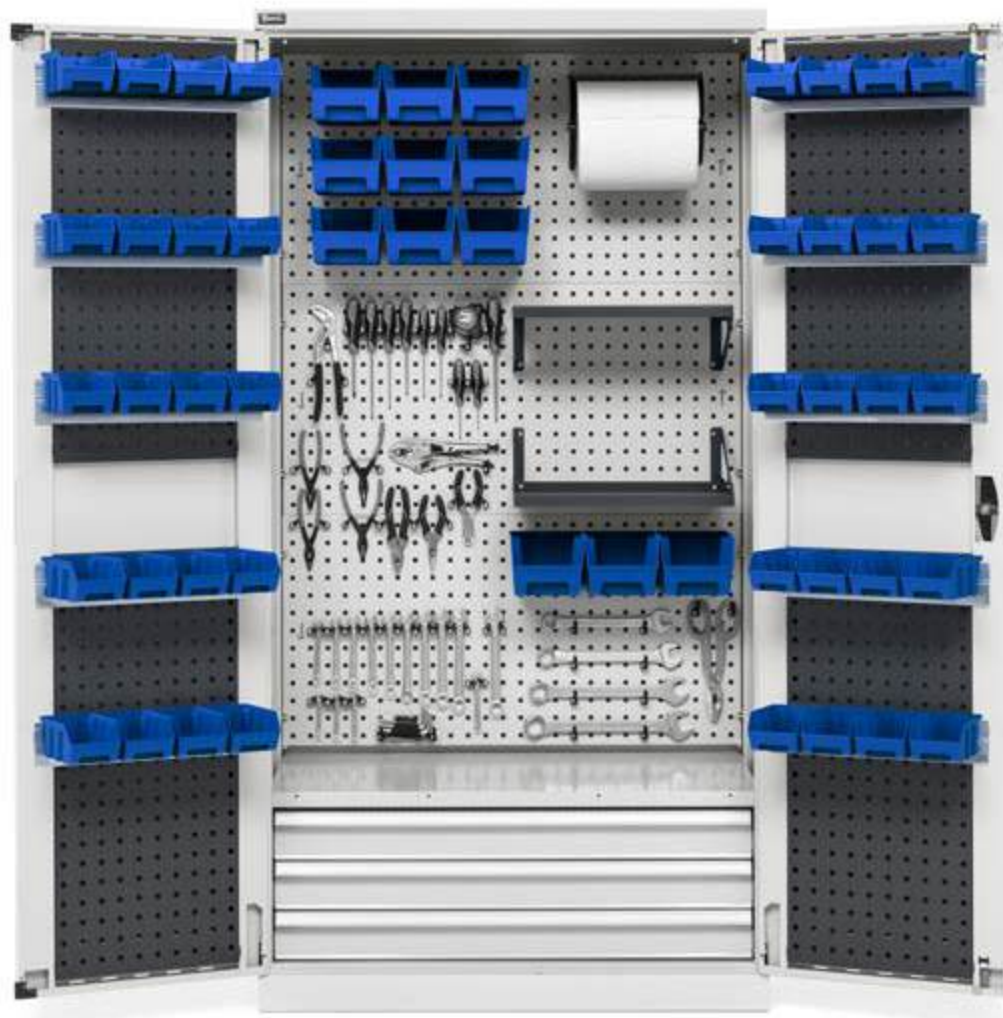

Gli armadi a porte a battente Perfom sono **soluzioni multiuso** che si adattano facilmente a numerosi ambienti e a diverse destinazioni d'uso. Infatti, grazie alla **vasta gamma di componenti** quali piani fessurati, pannelli forati, cassette, canalette e vasche stagne è possibile trasformare Perfom in armadi portautensili, per l'ecologia o per la ricarica. Sono disponibili in **tre diverse larghezze** (512, 1023 o 1193 mm) e **due altezze** (1000 o 2000 mm), tutti con **profondità 555 mm**. In base al modello scelto è possibile optare per **porte lisce, fessurate o fessurate in policarbonato**.

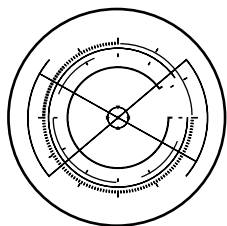

CONFIGURABILE



**PORTATA
800/1200 KG**

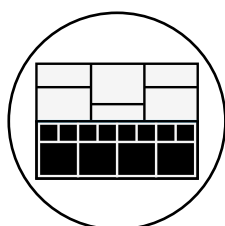

**MATERIALE DI
SEPARAZIONE**

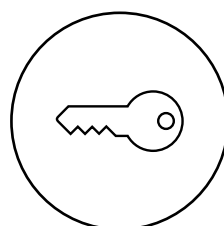

**CHIUSURA A
CHIAVE**

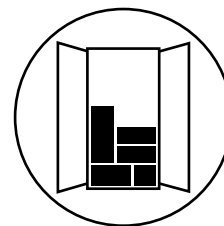

**ARMADIO MONTATO +
ACCESSORI
CONFEZIONATI
ALL'INTERNO**



CONFIGURE

ART.	L mm	P mm	H mm	KG	RAL	€
PERFOM15001	1193	555	1000	800	7035+7016	515,22
PERFOM15002	1193	555	1000	800	7035	515,22
PERFOM15003	1193	555	1000	800	5012	515,22

Composto da:

qtà	descrizione
1	Armadio con porte a battente
1	Kit 2 piani fessurati



CONFIGURE

ART.	L mm	P mm	H mm	KG	RAL	€
PERFOM15004	1193	555	1000	800	7035+7016	647,28
PERFOM15005	1193	555	1000	800	7035	647,28
PERFOM15006	1193	555	1000	800	5012	662,78

Composto da:

qtà	descrizione
1	Armadio con porte a battente
1	Cassetto a estrazione telescopica H=100 mm
1	Kit 2 piani fessurati



CONFIGURE

ART.	L mm	P mm	H mm	KG	RAL	€
PERFOM15007	1193	555	1000	800	7035+7016	779,34
PERFOM15008	1193	555	1000	800	7035	779,34
PERFOM15009	1193	555	1000	800	5012	810,34

Composto da:

qtà	descrizione
1	Armadio con porte a battente
2	Cassetto a estrazione telescopica H=100 mm
1	Kit 2 piani fessurati



CONFIGURE

ART.	L mm	P mm	H mm	KG	RAL	€
PERFOM15010	1193	555	1000	800	7035+7016	881,64
PERFOM15011	1193	555	1000	800	7035	881,64
PERFOM15012	1193	555	1000	800	5012	928,14

Composto da:

qtà	descrizione
1	Armadio con porte a battente
3	Cassetto a estrazione telescopica H=100 mm
1	Piano fessurato





24x27 EH

54x27 EH

64x27 EH

1193 mm 555 mm

1078x449



CONFIGURE

ART.	L mm	P mm	H mm	KG	RAL	€
PERFOM17001	1193	555	2000	1200	7035+7016	662,47
PERFOM17002	1193	555	2000	1200	7035	662,47
PERFOM17003	1193	555	2000	1200	5012	662,47

Composto da:

qtà	descrizione
1	Armadio con porte a battente
2	Kit 2 piani fessurati



CONFIGURE

ART.	L mm	P mm	H mm	KG	RAL	€
PERFOM17004	1193	555	2000	1200	7035+7016	1058,65
PERFOM17005	1193	555	2000	1200	7035	1058,65
PERFOM17006	1193	555	2000	1200	5012	1105,15

Composto da:

qtà	descrizione
1	Armadio con porte a battente
3	Cassetto a estrazione telescopica H=100 mm
2	Kit 2 piani fessurati



CONFIGURE

ART.	L mm	P mm	H mm	KG	RAL	€
PERFOM17007	1193	555	2000	1200	7035+7016	1789,94
PERFOM17008	1193	555	2000	1200	7035	1789,94
PERFOM17009	1193	555	2000	1200	5012	1929,44

Composto da:

qtà	descrizione
1	Armadio con porte a battente
9	Cassetto a estrazione telescopica H=100 mm
1	Kit 2 piani fessurati



24x27 EH

54x27 EH

64x27 EH

512 mm 555 mm

398x449



CONFIGURE

ART.	L mm	P mm	H mm	KG	RAL	€
PERFOM11001	512	555	1000	800	7035+7016	281,79
FAA1120C00108	512	555	1000	800	7035	281,48
FAA1120C00104	512	555	1000	800	5012	281,48

Composto da:

qtà	descrizione
1	Armadio con porta a battente
1	Kit 2 piani fessurati



CONFIGURE

ART.	L mm	P mm	H mm	KG	RAL	€
PERFOM11004	512	555	1000	800	7035+7016	351,23
PERFOM11005	512	555	1000	800	7035	351,23
PERFOM11006	512	555	1000	800	5012	358,98

Composto da:

qtà	descrizione
1	Armadio con porta a battente
1	Cassetto a estrazione semplice H=100 mm
1	Kit 2 piani fessurati



CONFIGURE

ART.	L mm	P mm	H mm	KG	RAL	€
PERFOM11010	512	555	1000	800	1004	352,16
PERFOM11011	512	555	1000	800	7035+7016	352,16
PERFOM11012	512	555	1000	800	7035	352,16
PERFOM11013	512	555	1000	800	5012	352,16

Composto da:

qtà	descrizione
1	Armadio con porta a battente fessurata
1	Kit 2 vasche stagne interne di raccolta liquidi capacità 9 L



vedi pag. 492



CONFIGURE

ART.	L mm	P mm	H mm	KG set ruote	RAL	€
PERFOM11017	519	555	1409	225	7035+7016	571,64
PERFOM11018	519	555	1409	225	7035	571,64
PERFOM11019	519	555	1409	225	5012	570,71

Composto da:

qtà	descrizione
1	Armadio con porta a battente
1	Leggio
1	Cassetto a estrazione semplice H=100 mm
1	Kit 2 piani fessurati
1	Coppia piastre portaruote
1	Kit 4 ruote in gomma standard Ø 100 mm



DIM. INTERNE LxP



PORTATA



RAL 7035 + RAL 7016



RAL 1004



RAL 5012



RAL 7035



CONFIGURE



CONFIGURE



CONFIGURE



CONFIGURE

ART.	L mm	P mm	H mm	KG	RAL	€
PERFOM12001	1023	555	1000	800	7035+7016	407,34
FAA1220C00108	1023	555	1000	800	7035	407,03
FAA1220C00104	1023	555	1000	800	5012	407,03

Composto da:

qtà	descrizione
1	Armadio con porte a battente
1	Kit 2 piani fessurati

ART.	L mm	P mm	H mm	KG	RAL	€
PERFOM12004	1023	555	1000	800	7035+7016	485,46
PERFOM12005	1023	555	1000	800	7035	485,46
PERFOM12006	1023	555	1000	800	5012	501,27

Composto da:

qtà	descrizione
1	Armadio con porte a battente
1	Cassetto a estrazione semplice H=100 mm
1	Kit 2 piani fessurati

ART.	L mm	P mm	H mm	KG	RAL	€
PERFOM12007	1023	555	1000	800	7035+7016	617,21
PERFOM12008	1023	555	1000	800	7035	617,21
PERFOM12009	1023	555	1000	800	5012	664,64

Composto da:

qtà	descrizione
1	Armadio con porte a battente
3	Cassetto a estrazione semplice H=100 mm
1	Piano fessurato

ART.	L mm	P mm	H mm	KG	RAL	€
PERFOM12010	1023	555	1000	800	7035+7016	764,77
PERFOM12011	1023	555	1000	800	7035	764,77
PERFOM12012	1023	555	1000	800	5012	764,77





Composto da:

qtà	descrizione
1	Armadio con porte a battente fessurate
1	Kit 2 piani/pannelli forati
1	Canaletta elettrica per multiprese
2	Multipresa schuko a 2 scomparti
1	Multipresa schuko a 4 scomparti
1	Magnetotermico differenziale
1	Cavo di collegamento wieland schuko/francese





CONFIGURE 

ART.	L mm	P mm	H mm	KG	RAL	€
 PERFOM12013	1048	600	1027	800	1004	502,20
 PERFOM12014	1048	600	1027	800	7035+7016	502,20
 PERFOM12015	1048	600	1027	800	7035	502,20
 PERFOM12016	1048	600	1027	800	5012	502,20

Composto da:





qtà	descrizione
1	Armadio con porte a battente fessurate
1	Piano fessurato
1	Vasca stagna esterna di raccolta liquidi capacità 59 L



vedi pag. 492



CONFIGURE 

ART.	L mm	P mm	H mm	KG	RAL	€
 PERFOM12017	1023	555	1000	800	1004	466,24
 PERFOM12018	1023	555	1000	800	7035+7016	466,24
 PERFOM12019	1023	555	1000	800	7035	466,24
 PERFOM12020	1023	555	1000	800	5012	466,24

Composto da:

qtà	descrizione
1	Armadio con porte a battente fessurate
1	Kit 2 vasche stagne interne di raccolta liquidi capacità 19 L



vedi pag. 492



CONFIGURE 

ART.	L mm	P mm	H mm	KG	RAL	€
 PERFOM12025	1048	600	1027	800	6011	502,20

Composto da:





qtà	descrizione
1	Armadio con porte a battente fessurate
1	Piano fessurato
1	Vasca stagna esterna di raccolta liquidi capacità 59 L



vedi pag. 492



CONFIGURE 

ART.	L mm	P mm	H mm	KG	RAL	€
 PERFOM12021	1023	555	1000	800	3020	407,34
 PERFOM12022	1023	555	1000	800	7035+7016	407,34
 PERFOM12023	1023	555	1000	800	7035	407,34
 PERFOM12024	1023	555	1000	800	5012	407,34

Composto da:

qtà	descrizione
1	Armadio con porte a battente fessurate
1	Kit 2 piani fessurati



DIM. INTERNELxP



PORTATA



RAL 7035+RAL 7016



RAL 1004



RAL 3020



RAL 5012



RAL 6011



RAL 7035



CONFIGURE

ART.	L mm	P mm	H mm	KG	RAL	€
PERFOM14001	1023	555	2000	1200	7035+7016	537,85
FAA1420C00108	1023	555	2000	1200	7035	516,77
FAA1420C00104	1023	555	2000	1200	5012	516,77

Composto da:

qtà	descrizione
1	Armadio con porte a battente
1	Kit 4 piani fessurati



CONFIGURE

ART.	L mm	P mm	H mm	KG	RAL	€
PERFOM14004	1023	555	2000	1200	7035+7016	772,21
PERFOM14005	1023	555	2000	1200	7035	772,21
PERFOM14006	1023	555	2000	1200	5012	819,64

Composto da:

qtà	descrizione
1	Armadio con porte a battente
3	Cassetto a estrazione semplice H=100 mm
1	Kit 4 piani fessurati



CONFIGURE

ART.	L mm	P mm	H mm	KG	RAL	€
PERFOM14007	1023	555	2000	1200	7035+7016	671,77
PERFOM14008	1023	555	2000	1200	7035	671,77
PERFOM14009	1023	555	2000	1200	5012	671,77

Composto da:

qtà	descrizione
1	Armadio con porte a battente fessurate in policarbonato
1	Kit 4 piani fessurati



24x27 EH

54x27 EH

64x27 EH

1023 mm 555 mm

908x449



ART.	L mm	P mm	H mm	KG	RAL	€
PERFOM14019	1023	555	2000	1200	7035+7016	1028,27
PERFOM14020	1023	555	2000	1200	7035	1028,27
PERFOM14021	1023	555	2000	1200	5012	1028,27

Composto da:

qtà	descrizione
1	Armadio con porte a battente fessurate
1	Vasca stagna interna di raccolta liquidi capacità 19 L
1	Kit piano fessurato con 2 separatori e 6 taniche con rubinetto a sfera
1	Kit 2 piani fessurati

CONFIGURE



ART.	L mm	P mm	H mm	KG	RAL	€
PERFOM14022	1048	600	2027	1200	7035+7016	2085,37
PERFOM14023	1048	600	2027	1200	7035	2085,37
PERFOM14024	1048	600	2027	1200	5012	2085,37

Composto da:

qtà	descrizione
1	Armadio con porte a battente fessurate
1	Vasca stagna interna di raccolta liquidi capacità 19 L
3	Kit piano fessurato con 2 separatori e 6 taniche con rubinetto a sfera
1	Piano fessurato
1	Vasca stagna esterna di raccolta liquidi capacità 59 L



CONFIGURE



DIM. INTERNEL x P



PORTATA



RAL 7035 + RAL 7016



RAL 5012



RAL 7035



CONFIGURE

ART.	L mm	P mm	H mm	KG	RAL	€
PERFOM14056	1048	600	2027	1200	6011	633,33

Composto da:

qtà	descrizione
1	Armadio con porte a battente fessurate
1	Kit 3 piani fessurati
1	Vasca stagna esterna di raccolta liquidi capacità 59 L



vedi pag. 492



CONFIGURE

ART.	L mm	P mm	H mm	KG	RAL	€
PERFOM14057	1023	555	2000	1200	6011	657,82

Composto da:

qtà	descrizione
1	Armadio con porte a battente fessurate
2	Kit 2 vasche stagne interne di raccolta liquidi capacità 19 L



vedi pag. 492



ART.	L mm	P mm	H mm	KG	RAL	€
PERFOM14058	1023	555	2000	1200	7035	791,74

Composto da:

qtà	descrizione
1	Armadio con porte a battente fessurate in policarbonato
2	Kit 2 vasche stagne interne di raccolta liquidi capacità 19 L



vedi pag. 492



CONFIGURE

ART.	L mm	P mm	H mm	KG	RAL	€
PERFOM14025	1048	600	2027	1200	1004	644,18
PERFOM14026	1048	600	2027	1200	7035+7016	633,33
PERFOM14027	1048	600	2027	1200	7035	633,33
PERFOM14028	1048	600	2027	1200	5012	633,33

Composto da:

qtà	descrizione
1	Armadio con porte a battente fessurate
1	Kit 3 piani fessurati
1	Vasca stagna esterna di raccolta liquidi capacità 59 L



vedi pag. 492



CONFIGURE

ART.	L mm	P mm	H mm	KG	RAL	€
PERFOM14029	1023	555	2000	1200	1004	668,67
PERFOM14030	1023	555	2000	1200	7035+7016	657,82
PERFOM14031	1023	555	2000	1200	7035	657,82
PERFOM14032	1023	555	2000	1200	5012	657,82

Composto da:

qtà	descrizione
1	Armadio con porte a battente fessurate
2	Kit 2 vasche stagne interne di raccolta liquidi capacità 19 L



vedi pag. 492



CONFIGURE

ART.	L mm	P mm	H mm	KG	RAL	€
PERFOM14033	1023	555	2000	1200	3020	853,12

Composto da:

qtà	descrizione
1	Armadio con porte a battente fessurate safe crash
1	Kit 3 piani fessurati
1	Piano/pannello forato
1	Parete divisorio
1	Kit tubo appendiabiti



PORTATA



RAL 7035+RAL 7016



RAL 1004



RAL 3020



RAL 5012



RAL 6011



RAL 7035



CONFIGURE



ART.	L mm	P mm	H mm	KG	RAL	€
PERFOM14034	1023	555	2000	1200	7035+7016	1376,40
PERFOM14035	1023	555	2000	1200	7035	1376,40
PERFOM14036	1023	555	2000	1200	5012	1376,40

Composto da:

qtà	descrizione	qtà	descrizione
1	Armadio con porte a battente fessurate	1	Magnetotermico differenziale
2	Kit 2 piani/pannelli forati	1	Cavo di collegamento wieland con spine in/out
2	Canaletta elettrica per multiprese	2	Cavo di collegamento wieland schuko/francese
1	Griglia per ventole	1	Kit porta rotolo con carta Ø=240 mm
2	Ventola 230 V senza griglia con spina Schuko	1	Gancio Unipok per utensili - confezione 30 pezzi
4	Multipresa schuko a 2 scomparti	2	Mensola grande reversibile
3	Multipresa schuko a 4 scomparti		



24x27 EH

54x27 EH

64x27 EH

1023 mm 555 mm



CONFIGURE

ART.	L mm	P mm	H mm	KG	RAL	€
PERFOM14037	1023	555	2000	1200	7035+7016	1361,52
PERFOM14038	1023	555	2000	1200	7035	1361,52
PERFOM14039	1023	555	2000	1200	5012	1361,52

Composto da:

qtà	descrizione
1	Armadio con porte a battente fessurate in policarbonato
2	Kit 2 piani/pannelli forati
3	Canaletta elettrica per multiprese
6	Multipresa schuko a 2 scomparti
3	Multipresa schuko a 4 scomparti
1	Magnetotermico differenziale
2	Cavo di collegamento wieland con spine in/out
1	Cavo di collegamento wieland schuko/francese



CONFIGURE

ART.	L mm	P mm	H mm	KG	RAL	€
PERFOM14040	1023	555	2000	1200	7035+7016	1267,59
PERFOM14041	1023	555	2000	1200	7035	1267,59
PERFOM14042	1023	555	2000	1200	5012	1267,59

Composto da:

qtà	descrizione
1	Armadio con porte a battente fessurate
2	Kit 2 piani/pannelli forati
2	Canaletta elettrica per multiprese
2	Barra aggancio per contenitori Picking Box mis. 1/2
2	Kit 3 contenitori Picking Box Air mis. 2
4	Multipresa schuko a 2 scomparti
2	Multipresa schuko a 4 scomparti
1	Magnetotermico differenziale
1	Cavo di collegamento wieland con spine in/out
1	Cavo di collegamento wieland schuko/francese
1	Kit porta rotolo con carta Ø=240 mm
2	Gancio Unipok per utensili - confezione 30 pezzi
2	Mensola grande reversibile



CONFIGURE

ART.	L mm	P mm	H mm	KG	RAL	€
PERFOM14043	1023	555	2000	1200	7035+7016	906,13
PERFOM14044	1023	555	2000	1200	7035	906,13
PERFOM14045	1023	555	2000	1200	5012	906,13

Composto da:

qtà	descrizione
1	Armadio con porte a battente fessurate
2	Kit 2 piani/pannelli forati
2	Canaletta elettrica per multiprese
2	Multipresa schuko a 2 scomparti
2	Multipresa schuko a 4 scomparti
1	Cavo di collegamento wieland con spine in/out
1	Cavo di collegamento wieland schuko/francese



PORTATA



RAL 7035 + RAL 7016



RAL 5012



RAL 7035



CONFIGURE



ART.	L mm	P mm	H mm	KG	RAL	€
PERFOM14049	1023	555	2000	1200	7035+7016	1055,24
PERFOM14050	1023	555	2000	1200	7035	1055,24
PERFOM14051	1023	555	2000	1200	5012	1102,67

Composto da:

qtà	descrizione
1	Armadio con porte a battente
3	Cassetto a estrazione semplice H=100 mm
2	Kit 2 piani/pannelli forati
4	Barra aggancio per contenitori Picking Box mis. 1/2
4	Kit 3 contenitori Picking Box Air mis. 2
4	Gancio Unipok per utensili - confezione 30 pezzi



24x27 EH

54x27 EH

64x27 EH

1023 mm 555 mm

908x449



CONFIGURE

ART.	L mm	P mm	H mm		RAL	€
PERFOM14052	1023	555	2000	1200	7035+7016	1204,66
PERFOM14053	1023	555	2000	1200	7035	1204,66
PERFOM14054	1023	555	2000	1200	5012	1286,81

Composto da:

qtà	descrizione
1	Armadio con porte a battente
3	Cassetto a estrazione semplice H=100 mm
4	Cassetto a estrazione telescopica H=150 mm
1	Kit 2 piani fessurati



CONFIGURE

ART.	L mm	P mm	H mm		RAL	€
PERFOM14046	1023	555	2000	1200	7035+7016	1419,49
PERFOM14047	1023	555	2000	1200	7035	1419,49
PERFOM14048	1023	555	2000	1200	5012	1466,92

Composto da:

qtà	descrizione
1	Armadio con porte a battente
3	Cassetto a estrazione semplice H=100 mm
2	Coppia pannelli forati per porta a battente
2	Kit 2 piani/pannelli forati
14	Barra aggancio per contenitori Picking Box mis. 1/2
10	Kit 4 contenitori Picking Box Air mis. 1
4	Kit 3 contenitori Picking Box Air mis. 2
1	Kit porta rotolo con carta Ø=240 mm
4	Gancio Unipok per utensili - confezione 30 pezzi
2	Mensola grande reversibile



CONFIGURE

ART.	L mm	P mm	H mm		RAL	€
PERFOM14010	1023	555	2000	1200	7035+7016	636,12
PERFOM14011	1023	555	2000	1200	7035	636,12
PERFOM14012	1023	555	2000	1200	5012	636,12

Composto da:

qtà	descrizione
1	Armadio con porte a battente fessurate
1	Kit 3 piani fessurati
1	Piano/pannello forato
1	Parete divisorio
1	Kit tubo appendiabiti



DIM. INTERNEL x P



PORTATA



RAL 7035 + RAL 7016



RAL 5012



RAL 7035



CONFIGURE 

ARMADIO CON PORTA A BATTENTE 24X27 EH

ART.	L mm	P mm	H mm	KG	RAL	€
 FAA1120C000PD	512	555	1000	800	7035+7016	253,58
 FAA1120C00008	512	555	1000	800	7035	253,58
 FAA1120C00004	512	555	1000	800	5012	253,58



CONFIGURE 

ARMADIO CON PORTE A BATTENTE 54X27 EH

ART.	L mm	P mm	H mm	KG	RAL	€
 FAA1220C000PD	1023	555	1000	800	7035+7016	357,74
 FAA1220C00008	1023	555	1000	800	7035	357,74
 FAA1220C00004	1023	555	1000	800	5012	357,74



CONFIGURE 

ARMADIO CON PORTE A BATTENTE 64X27 EH



ART.	L mm	P mm	H mm	KG	RAL	€
 FAA1520C000PD	1193	555	1000	800	7035+7016	454,15
 FAA1520C00008	1193	555	1000	800	7035	454,15
 FAA1520C00004	1193	555	1000	800	5012	454,15

PERFOM

COMPONENTI





ARMADIO CON PORTE A BATTENTE 64X27 EH

ART.	L mm	P mm	H mm	KG	RAL	€
 FAA1720C000PD	1193	555	2000	1200	7035+7016	540,33
 FAA1720C00008	1193	555	2000	1200	7035	540,33
 FAA1720C00004	1193	555	2000	1200	5012	540,33

CONFIGURE 



ARMADIO CON PORTE A BATTENTE 54X27 EH

ART.	L mm	P mm	H mm	KG	RAL	€
 FAA1420C000PD	1023	555	2000	1200	7035+7016	440,82
 FAA1420C00008	1023	555	2000	1200	7035	440,82
 FAA1420C00004	1023	555	2000	1200	5012	440,82

CONFIGURE 



PORTATA



RAL 7035 + RAL 7016



RAL 5012



RAL 7035

COMPONENTI



CONFIGURE

ARMADIO CON PORTE A BATTENTE FESSURATE 24X27 EH

ART.	L mm	P mm	H mm	KG	RAL	€
FAA1130C000PD	512	555	1000	800	7035+7016	253,58
FAA1130C00008	512	555	1000	800	7035	253,58
FAA1130C00004	512	555	1000	800	5012	253,58
FAA1130C00030	512	555	1000	800	1004	253,58



CONFIGURE

ARMADIO CON PORTE A BATTENTE FESSURATE 54X27 EH

ART.	L mm	P mm	H mm	KG	RAL	€
FAA1230C000PD	1023	555	1000	800	7035+7016	357,74
FAA1230C00008	1023	555	1000	800	7035	357,74
FAA1230C00004	1023	555	1000	800	5012	357,74
FAA1230C00030	1023	555	1000	800	1004	357,74
FAA1230C0002Y	1023	555	1000	800	3020	357,74
FAA1230C00002	1023	555	1000	800	6011	357,74



CONFIGURE

ARMADIO CON PORTE A BATTENTE FESSURATE 54X27 EH

ART.	L mm	P mm	H mm	KG	RAL	€
FAA1430C000PD	1023	555	2000	1200	7035+7016	440,82
FAA1430C00008	1023	555	2000	1200	7035	440,82
FAA1430C00004	1023	555	2000	1200	5012	440,82
FAA1430C00030	1023	555	2000	1200	1004	451,67
FAA1430C00002	1023	555	2000	1200	6011	440,82



PERFOM

COMPONENTI



CONFIGURE

ARMADIO CON PORTE A BATTENTE FESSURATE IN POLICARBONATO 54X27 EH

ART.	L mm	P mm	H mm		RAL	€
FAA1440C000PD	1023	555	2000	1200	7035+7016	574,74
FAA1440C00008	1023	555	2000	1200	7035	574,74
FAA1440C00004	1023	555	2000	1200	5012	574,74



CONFIGURE

ARMADIO CON PORTE A BATTENTE FESSURATE SAFE CRASH 54X27 EH

ART.	L mm	P mm	H mm		RAL	€
FAA1440C05C2Y	1023	555	2000	1200	3020	657,82



- PORTATA
- RAL 7035+RAL 7016
- RAL 1004
- RAL 3020
- RAL 5012
- RAL 6011
- RAL 7035



TOP A 3 BORDI RIVESTITI IN PVC

ART.	L mm	P mm	H mm	colore	€
FAC9911290007	514	558	31	Nero	56,11
FAC9912290007	1024	558	31	Nero	78,12
FAC9915290007	1194	558	31	Nero	79,36



TOP IN ACCIAIO GOMMATO

ART.	L mm	P mm	H mm	colore	€
FAC9911360007	512	555	32	Nero	134,23
FAC9912360007	1023	555	32	Nero	204,29
FAC9915360007	1193	555	32	Nero	213,90

PIANO FESSURATO P=500 mm

ART.	L mm	P mm	H mm	KG	finitura	€
FAC9911010099	484	500	35	120	Zincato	18,29
FAC9912010099	995	500	35	120	Zincato	25,11
FAC9915010099	1165	500	35	120	Zincato	31,31



KIT PIANI FESSURATI P=500 mm

ART.	L mm	P mm	H mm	n. piani	KG	finitura	€
FAC9911020099	484	500	35	2	120	Zincato	28,21
FAC9911030099	484	500	35	3	120	Zincato	41,23
FAC9912020099	995	500	35	2	120	Zincato	49,60
FAC9912030099	995	500	35	3	120	Zincato	73,16
FAC9912040099	995	500	35	4	120	Zincato	97,03
FAC9915020099	1165	500	35	2	120	Zincato	61,07
FAC9915030099	1165	500	35	3	120	Zincato	92,38



KIT PIANI FESSURATI P=345 mm

ART.	L mm	P mm	H mm	n. piani	KG	finitura	€
FAC9912050099	995	345	35	2	100	Zincato	49,60
FAC9912060099	995	345	35	3	100	Zincato	73,16



COPIA PANNELLI FORATI PER PORTA A BATTENTE

Si può applicare fino ad un massimo di una coppia pannelli per porta

ART.	L mm	P mm	H mm	dim. foro mm	passo mm	RAL	€
FAC9912250039	381	20	824	10x10	38	7016	63,24



COMPONENTI



KIT 4 CONTENITORI PICKING BOX AIR MIS. 1

ART.	dim. ingombro			colore	€
	L mm	P mm	H mm		
FBLIT0600LQ	108	173	76		5,89
FBLIT060032	108	173	76		5,89
FBLIT06001Z	108	173	76		5,89
FBLIT06002Y	108	173	76		5,89
FBLIT06004Q	108	173	76		5,89



KIT 3 CONTENITORI PICKING BOX AIR MIS. 2

ART.	dim. ingombro			colore	€
	L mm	P mm	H mm		
FBLIT0610LQ	160	234	127		8,99
FBLIT061032	160	234	127		8,99
FBLIT06101Z	160	234	127		8,99
FBLIT06102Y	160	234	127		9,30
FBLIT06104Q	160	234	127		8,99



BARRA AGGANCIAMENTO PER CONTENITORI PICKING BOX MIS. 1/2

ART.	L mm	P mm	H mm	finitura	€
FBLIT020099	445	14	89	Zincato	7,44



Esempio di applicazione del kit 4 contenitori mis. 1 su barra aggancio



Esempio di applicazione del kit 3 contenitori mis. 2 su barra aggancio

PIANO-PANNELLO FORATO

Applicabile in 3 diverse posizioni:

PIANO/PANNELLO FORATO

ART.	L mm	P mm	H mm	KG	dim. foro mm	passo mm	RAL	€
FAC9912070039	995	500	30	120-50	10x10	38	7016	58,28
FAC9912070008	995	500	30	120-50	10x10	38	7035	67,27
FAC9912070004	995	500	30	120-50	10x10	38	5012	67,27

Pannello forato verticale

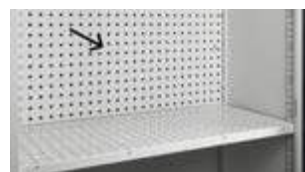

Piano orizzontale

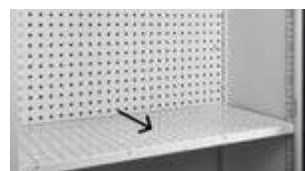

KIT PIANI-PANNELLI FORATI

ART.	L mm	P mm	H mm	n. piani	KG	dim. foro mm	passo mm	RAL	€
FAC9912080008	995	500	30	2	120-50	10x10	38	7035	129,27
FAC9912080004	995	500	30	2	120-50	10x10	38	5012	129,27
FAC9912080039	995	500	30	2	120-50	10x10	38	7016	111,60

Mensola forata a 4 bordi



PORTATA



RAL 5012



RAL 7016



RAL 7035



ZINCATO



CASSETTI AD ESTRAZIONE SEMPLICE 24X27 EH

ART.	dim. utili			KG		H frontale cassetto	RAL	€
	L mm	P mm	H mm					
FAC9911180008	398	449	85	50	88%	100	7035	69,44
FAC9911180004	398	449	85	50	88%	100	5012	77,19
FAC9911180039	398	449	85	50	88%	100	7016	69,44



CASSETTI AD ESTRAZIONE SEMPLICE 54X27 EH

ART.	dim. utili			KG		H frontale cassetto	RAL	€
	L mm	P mm	H mm					
FAC9912180008	908	449	85	50	88%	100	7035	78,12
FAC9912180004	908	449	85	50	88%	100	5012	93,93
FAC9912180039	908	449	85	50	88%	100	7016	78,12



CASSETTI AD ESTRAZIONE TELESCOPICA 54X27 EH

ART.	dim. utili			KG		H frontale cassetto	RAL	€
	L mm	P mm	H mm					
FAC9912190008	908	449	85	100	100%	100	7035	107,57
FAC9912190004	908	449	85	100	100%	100	5012	122,14
FAC9912190039	908	449	85	100	100%	100	7016	107,57
FAC9912210008	908	449	135	100	100%	150	7035	119,97
FAC9912210004	908	449	135	100	100%	150	5012	128,65
FAC9912210039	908	449	135	100	100%	150	7016	119,97



CASSETTI AD ESTRAZIONE TELESCOPICA 64X27 EH

ART.	dim. utili			KG		H frontale cassetto	RAL	€
	L mm	P mm	H mm					
FAC9915190008	1078	449	85	100	100%	100	7035	132,06
FAC9915190004	1078	449	85	100	100%	100	5012	147,56
FAC9915190039	1078	449	85	100	100%	100	7016	132,06

COMPONENTI



ZOCOLO PER TRANSPALLET COMPLETO DI CHIUSURA

ART.	L mm	P mm	H mm	KG	RAL	€
FAC9912170039	1018	550	100	1200	7016	151,28
FAC9915170039	1188	550	100	1200	7016	174,22



VASCA STAGNA ESTERNA DI RACCOLTA LIQUIDI CAPACITÀ 59 L

ART.	L mm	P mm	H mm	KG	L	RAL	€
FAC9912130039	1048	600	167	1200	59	7016	119,35



vedi pag. 492

VASCHE STAGNE INTERNE RACCOLTA LIQUIDI

ART.	L mm	P mm	H mm	KG	L	finitura	€
FAC9911090099	484	500	42	50	9	Zincato	52,70
FAC9912090099	995	500	42	50	19	Zincato	56,73



KIT VASCHE STAGNE INTERNE RACCOLTA LIQUIDI

ART.	L mm	P mm	H mm	KG	L	n. vasche	finitura	€
FAC9911100099	484	500	42	50	9	2	Zincato	98,58
FAC9912100099	995	500	42	50	19	2	Zincato	108,50



KIT PIANO FESSURATO CON 2 SEPARATORI E 6 TANICHE CON RUBINETTO A SFERA

ART.	L mm	P mm	H mm	n. taniche	L taniche	finitura piano	€
FAC9912280099	995	495	315	6	10	Zincato	481,12



PORTATA



CAPACITÀ



ESTRAZIONE



RAL 5012



RAL 7016



RAL 7035



ZINCATO

COMPONENTI



CANALETTA ELETTRICA PER MULTIPRESE

ART.	L mm	P mm	H mm	RAL	€
FAC9912220039	1008	64	140	7016	35,03



SCHEMA MULTIPRESE PER CANALETTA ELETTRICA



- 1
- 2
- 3
- 3
- 4

- 1 magnetotermico
- 2 multipresa 4 scomparti
- 3 multipresa 2 scomparti
- 4 USB ricarica



Applicazione canaletta elettrica sulla **parte superiore** del **piano-pannello forato**



Applicazione canaletta elettrica sulla **parte inferiore** del **piano-pannello forato**



Canaletta elettrica **integrabile** con **piano-pannello forato** in posizione verticale



SUPPORTO LATERALE PER MULTIPRESA

ART.	L mm	P mm	H mm	RAL	€
FAC9912240039	10	463	77	7016	19,84

SCHEMA MULTIPRESE PER SUPPORTO LATERALE



multipresa 4 scomparti



Esempio di applicazione con:
 1 supporto art. FAC9912240039
 1 multipresa art. FBLET005007
 1 cavo di collegamento art. FBLET016007

COMPONENTI



GRIGLIA PER VENTOLE

ART.	L mm	P mm	H mm	RAL	€
 FAC9912230039	994	123	136	7016	41,54

Esempio di applicazione con:
 1 griglia art. FAC9912230039
 2 ventole art. FAS32200100
 1 multipresa art. FBLET005007
 1 cavo di collegamento art. FBLET016007



Applicazione griglia nella **parte superiore** dell'armadio **senza** l'ausilio del **piano-pannello forato**



Applicazione griglia nella **parte superiore** dell'armadio **con** l'ausilio del **piano-pannello forato**



Applicazione griglia nella **parte inferiore** dell'armadio **con** l'ausilio del **piano-pannello forato**



VENTOLA 230 V SENZA GRIGLIA CON SPINA SCHUKO

ART.	L mm	P mm	H mm	colore	€
 FAS32200100	125	44	125	Nero	33,79

IRONTEAM

vedi pag. 328



FBLET012007



FBLET004007



FBLET005007



FBLET016007



FBLET014007



FBLET020007



FBL99400008

APPLICAZIONE DELLA LAMPADA SOTTO IL PIANO-PANNELLO FORATO



COMPONENTI



1. Leggio
2. Cassetto a estrazione semplice H=100 mm
3. Coppia piastre portaruote
4. Kit 4 ruote in gomma standard Ø 100 mm



LEGGIO

ART.	L mm	P mm	H mm	RAL	€
FAC9911340004	516	564	316	5012	134,54
FAC9911340008	516	564	316	7035	143,22
FAC9911340039	516	564	316	7016	134,54



CASSETTI AD ESTRAZIONE SEMPLICE 24X27 EH

ART.	dim. utili			kg	%	H frontale cassetto	RAL	€
	L mm	P mm	H mm					
FAC9911180008	398	449	85	50	88%	100	7035	69,44
FAC9911180004	398	449	85	50	88%	100	5012	77,19
FAC9911180039	398	449	85	50	88%	100	7016	69,44



PARETE DI CHIUSURA ANTERIORE PER LEGGIO

ART.	L mm	P mm	H mm	RAL	€
FAC9911350004	454	60	101	5012	17,05
FAC9911350008	454	60	101	7035	17,05
FAC9911350039	454	60	101	7016	17,05



COPPIA PIASTRE PORTARUOTE

ART.	L mm	P mm	H mm	€
FAC9911330099	114	550	13	30,38



KIT RUOTE

ART.	Ø mm	kg set ruote	H mm	materiale			€
FKRD1002107	100	225	128	Gomma standard	2	2	46,81
FKRB1252107	125	300	155	Gomma standard	2	2	52,08
FKRU1252101	125	300	155	Gomma antiriscaldamento sintetica	2	2	56,73
FKRS1252101	125	750	155	Gomma elastica	2	2	90,83



RUOTA GIREVOLE CON FRENO



RUOTA FISSA

COMPONENTI

1. Parete divisorio
2. Kit tubo appendiabiti
3. Piano/pannello forato
4. Piano fessurato
5. Cassetto a estrazione semplice H=100 mm

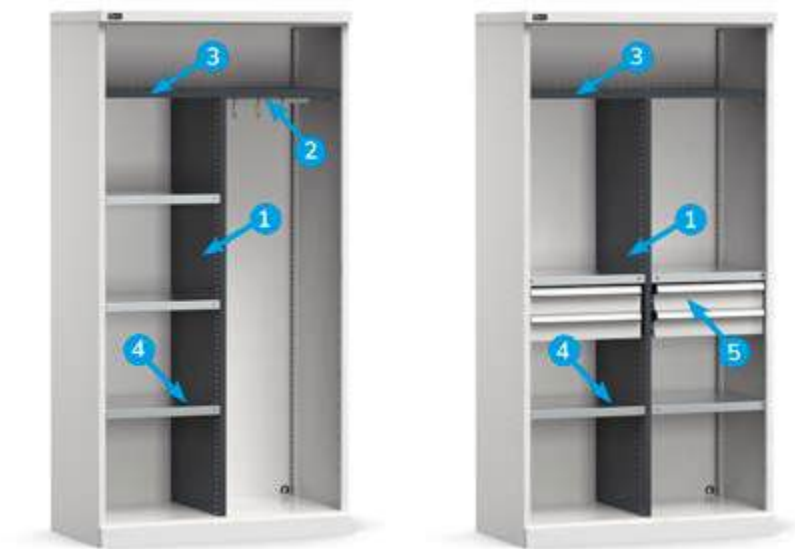

PARETE DIVISORIO

ART.	L mm	P mm	H mm	passo mm	RAL	€
FAC9912260039	44	500	1616	25	7016	84,32

KIT TUBO APPENDIABITI

ART.	L mm	P mm	H mm	KG	finitura	€
FAC9912270099	458	23	56	15	Zincato	11,47

PIANO/PANNELLO FORATO

ART.	L mm	P mm	H mm	KG	RAL	€
FAC9912070039	995	500	30	120-50	7016	58,28

PIANO FESSURATO P=500 mm

ART.	L mm	P mm	H mm	KG	finitura	€
FAC9911010099	484	500	35	120	Zincato	18,29

KIT PIANI FESSURATI P=500 mm

ART.	L mm	P mm	H mm	n. piani	KG	finitura	€
FAC9911020099	484	500	35	2	120	Zincato	28,21
FAC9911030099	484	500	35	3	120	Zincato	41,23

CASSETTI AD ESTRAZIONE SEMPLICE 24X27 EH

ART.	dim. utili			KG		H frontale cassetto	RAL	€
	L mm	P mm	H mm					
FAC9911180008	398	449	85	50	88%	100	7035	69,44
FAC9911180004	398	449	85	50	88%	100	5012	77,19
FAC9911180039	398	449	85	50	88%	100	7016	69,44



L  512 mm



ART.	adatto per cassetto H mm	componenti	€
FFH00500100	100	2 x Divisorio trasversale L=202 mm 1 x Divisorio longitudinale fessurato L=457 mm	10,85



ART.	adatto per cassetto H mm	componenti	€
FFH00500800	100/125	3 x Cassetta divisorio 150x75 mm 6 x Cassetta divisorio 150x150 mm	21,39

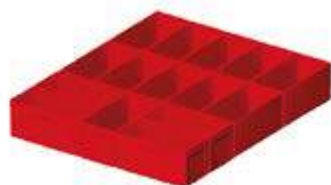

ART.	adatto per cassetto H mm	componenti	€
FFH00500900	100/125	15 x Cassetta divisorio 150x75 mm	26,04

L  1023 mm

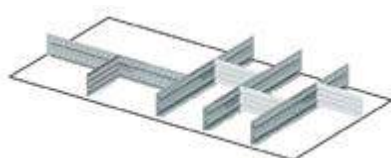

ART.	adatto per cassetto H mm	componenti	€
FFH02000100	100	4 x Divisorio longitudinale fessurato L=457 mm 4 x Divisorio trasversale L=151 mm	26,35

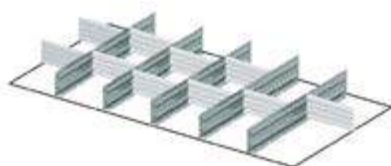

ART.	adatto per cassetto H mm	componenti	€
FFH02000200	100	5 x Divisorio longitudinale fessurato L=457 mm 10 x Divisorio trasversale L=151 mm	36,58



ART.	adatto per cassetto H mm	componenti	€
FFH02000600	100/125	12 x Cassetta divisorio 150x75 mm 12 x Cassetta divisorio 150x150 mm	51,15



MATERIALE DI SEPARAZIONE

L 1193 mm

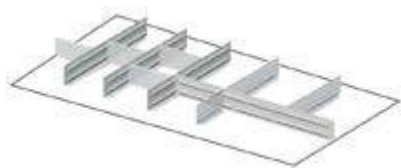

ART.	adatto per cassetto H mm	componenti	€
FFH02500300	100	3 x Divisorio longitudinale fessurato L=457 mm 1 x Divisorio longitudinale fessurato L=610 mm 3 x Divisorio trasversale L=151 mm 2 x Divisorio trasversale L=168 mm 2 x Divisorio trasversale L=304 mm	30,69

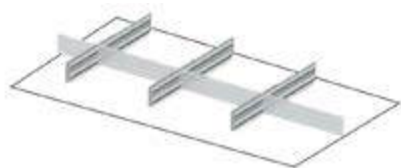

ART.	adatto per cassetto H mm	componenti	€
FFH02500400	100	3 x Divisorio longitudinale fessurato L=457 mm 1 x Divisorio trasversale L=168 mm 3 x Divisorio trasversale L=304 mm	23,87

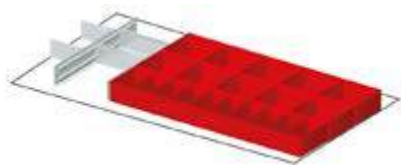

ART.	adatto per cassetto H mm	componenti	€
FFH02500600	100	10 x Cassetta divisorio 150x75 mm 10 x Cassetta divisorio 150x150 mm 2 x Divisorio longitudinale fessurato L=457 mm 2 x Divisorio trasversale L=134 mm 2 x Divisorio trasversale L=202 mm	51,77



START

PRO

PRO+

ARMADI CON PORTE SCORREVOLI

PERFOM

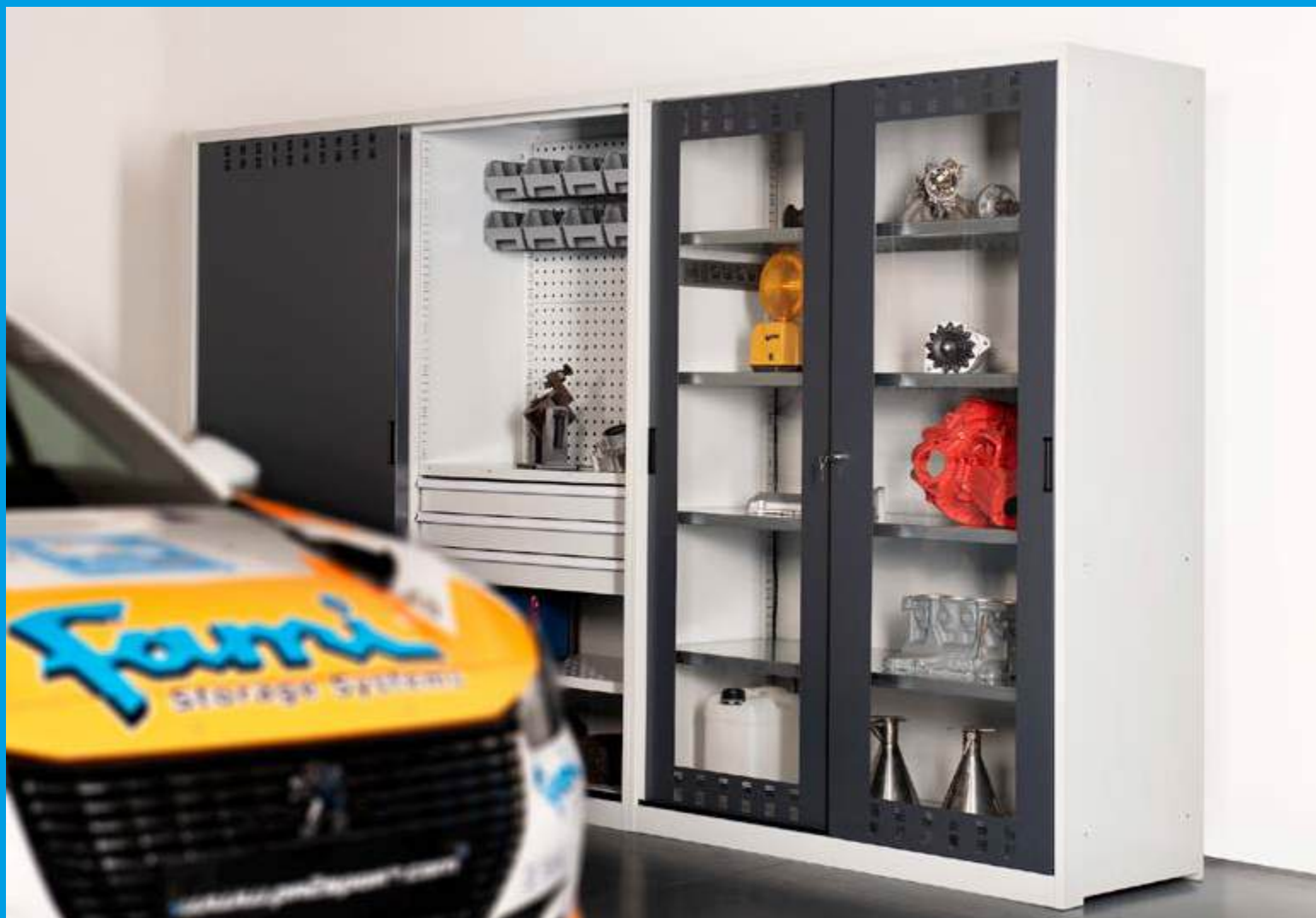

L'armadio a porte scorrevoli Perfom è perfetto per essere installato in aree di passaggio o se si cerca un **arredo salvaspazio** con un'elevata capacità di stoccaggio. Può presentare **tre larghezze** (1020, 1428 o 2040 mm) e **due altezze** (915 o 2000 mm) e **porte lisce, fessurate o fessurate in policarbonato**. Indipendentemente dal modello scelto, la **profondità** è di **600 mm** e può ospitare una vasta gamma di componenti come piani fessurati, pannelli forati, cassetti, vasche stagne e canalette elettriche.



PORTATA 800/1200
KG



GARANZIA PORTE

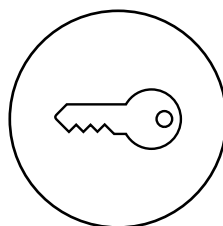

CHIUSURA A
CHIAVE

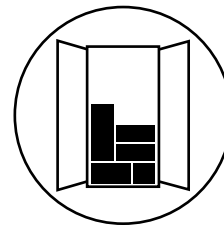

ARMADIO
MONTATO +
ACCESSORI
CONFEZIONATI
ALL'INTERNO





ART.	L mm	P mm	H mm	KG	RAL	€
PERFOM21001	1020	600	2000	1200	7035+7016	884,43
PERFOM21002	1020	600	2000	1200	7035	884,43
PERFOM21003	1020	600	2000	1200	5012	884,43

Composto da:

qtà	descrizione
1	Armadio con porte scorrevoli
1	Kit 4 piani fessurati

[CONFIGURE](#)



ART.	L mm	P mm	H mm	KG	RAL	€
PERFOM23001	1020	600	2000	1200	7035+7016	1004,40

Composto da:

qtà	descrizione	
1	Armadio con porte scorrevoli fessurate	
2	Kit 2 vasche stagne interne di raccolta liquidi capacità 19 L	vedi pag. 492

[CONFIGURE](#)







ART.	L mm	P mm	H mm	KG	RAL	€
PERFOM25001	1020	600	2000	1200	7035+7016	1084,07

Composto da:

qtà	descrizione
1	Armadio con porte scorrevoli fessurate in policarbonato
1	Kit 4 piani fessurati

[CONFIGURE](#)





ART.	L mm	P mm	H mm		RAL	€
 PERFOM20001	1020	600	915	800	7035+7016	627,44
 PERFOM20002	1020	600	915	800	7035	627,44
 PERFOM20003	1020	600	915	800	5012	627,44



Composto da:

qtà	descrizione
1	Armadio con porte scorrevoli
1	Piano fessurato



[CONFIGURE](#) 

ART.	L mm	P mm	H mm		RAL	€
 PERFOM22001	1020	600	915	800	7035+7016	710,83

Composto da:

qtà	descrizione		
1	Armadio con porte scorrevoli fessurate		
1	Kit 2 vasche stagne interne di raccolta liquidi capacità 19 L		vedi pag. 492

[CONFIGURE](#) 

ART.	L mm	P mm	H mm		RAL	€
 PERFOM24001	1020	600	915	800	7035+7016	768,80

Composto da:

qtà	descrizione
1	Armadio con porte scorrevoli fessurate in policarbonato
1	Piano fessurato

[CONFIGURE](#) 

PORTATA



RAL 7035 + RAL 7016



RAL 5012



RAL 7035



ART.	L mm	P mm	H mm	KG	RAL	€
 PERFOM21004	1428	600	2000	1200	7035+7016	1150,72
 PERFOM21005	1428	600	2000	1200	7035	1150,72
 PERFOM21006	1428	600	2000	1200	5012	1150,72

Composto da:

qtà	descrizione
1	Armadio con porte scorrevoli
2	Kit 2 piani fessurati

[CONFIGURE](#) 



ART.	L mm	P mm	H mm	KG	RAL	€
 PERFOM25002	1428	600	2000	1200	7035+7016	1474,36

Composto da:

qtà	descrizione
1	Armadio con porte scorrevoli fessurate in policarbonato
2	Kit 2 piani fessurati

[CONFIGURE](#) 





ART.	L mm	P mm	H mm	KG	RAL	€
PERFOM20004	1428	600	915	800	7035+7016	790,19
PERFOM20005	1428	600	915	800	7035	790,19
PERFOM20006	1428	600	915	800	5012	790,19

Composto da:

qtà	descrizione
1	Armadio con porte scorrevoli
1	Piano fessurato

[CONFIGURE](#)



ART.	L mm	P mm	H mm	KG	RAL	€
PERFOM24002	1428	600	915	800	7035+7016	925,97

Composto da:

qtà	descrizione
1	Armadio con porte scorrevoli fessurate in policarbonato
1	Piano fessurato

[CONFIGURE](#)



PORTATA



RAL 7035 + RAL 7016



RAL 5012



RAL 7035



ART.	L mm	P mm	H mm	KG per vano	RAL	€
PERFOM21010	2040	600	2000	1200	7035+7016	1966,95
PERFOM21011	2040	600	2000	1200	7035	1966,95
PERFOM21012	2040	600	2000	1200	5012	2061,81

Composto da:

qtà	descrizione
1	Armadio con porte scorrevoli
6	Cassetto a estrazione semplice H=100 mm
2	Kit 4 piani fessurati

[CONFIGURE](#)



ART.	L mm	P mm	H mm	KG per vano	RAL	€
PERFOM23004	2040	600	2000	1200	7035+7016	2222,70

Composto da:

qtà	descrizione
1	Armadio con porte scorrevoli fessurate
3	Kit 2 piani/pannelli forati
1	Piano fessurato
1	Piano interno in multiplex
1	Cassetto a estrazione semplice H=100 mm
2	Canaletta elettrica per multiprese
1	Supporto laterale per multiprese
3	Multipresa schuko a 4 scomparti
4	Multipresa schuko a 2 scomparti
2	Cavo di collegamento wieland schuko/francese
1	Cavo di collegamento wieland con spine in/out
1	Coppia squadrette a L
1	Snodo per piastra
1	Piastra porta monitor con standard VESA
1	Mensola porta oggetti reversibile



PATENTED

[CONFIGURE](#)



ART.	L mm	P mm	H mm	KG per vano	RAL	€
PERFOM25004	2040	600	2000	1200	7035+7016	2168,14

Composto da:

qtà	descrizione
1	Armadio con porte scorrevoli fessurate in policarbonato
4	Kit 2 vasche stagne interne di raccolta liquidi capacità 19 L



vedi pag. 492

[CONFIGURE](#)





ART.	L mm	P mm	H mm	 per vano	RAL	€
 PERFOM21007	2040	600	2000	1200	7035+7016	1498,23
 PERFOM21008	2040	600	2000	1200	7035	1498,23
 PERFOM21009	2040	600	2000	1200	5012	1498,23

Composto da:



qtà	descrizione
1	Armadio con porte scorrevoli
2	Kit 4 piani fessurati

CONFIGURE 





ART.	L mm	P mm	H mm	 per vano	RAL	€
 PERFOM23003	2040	600	2000	1200	7035+7016	1738,17

Composto da:

qtà	descrizione		
1	Armadio con porte scorrevoli fessurate		
4	Kit 2 vasche stagne interne di raccolta liquidi capacità 19 L		vedi pag. 492

CONFIGURE 



ART.	L mm	P mm	H mm	 per vano	RAL	€
 PERFOM25003	2040	600	2000	1200	7035+7016	1928,20

Composto da:

qtà	descrizione
1	Armadio con porte scorrevoli fessurate in policarbonato
2	Kit 4 piani fessurati

CONFIGURE 









54x27 EH

78x27 EH

54+54x27 EH

2040 mm 600 mm





ART.	L mm	P mm	H mm	 per vano	RAL	€
 PERFOM20007	2040	600	915	800	7035+7016	1031,99
 PERFOM20008	2040	600	915	800	7035	1031,99
 PERFOM20009	2040	600	915	800	5012	1031,99

Composto da:



qtà	descrizione
1	Armadio con porte scorrevoli
2	Piano fessurato

[CONFIGURE](#) 





ART.	L mm	P mm	H mm	 per vano	RAL	€
 PERFOM22002	2040	600	915	800	7035+7016	1198,77

Composto da:

qtà	descrizione		
1	Armadio con porte scorrevoli fessurate		
2	Kit 2 vasche stagne interne di raccolta liquidi capacità 19 L		vedi pag. 492

[CONFIGURE](#) 



ART.	L mm	P mm	H mm	 per vano	RAL	€
 PERFOM24003	2040	600	915	800	7035+7016	1220,47



Composto da:

qtà	descrizione
1	Armadio con porte scorrevoli fessurate in policarbonato
2	Piano fessurato

[CONFIGURE](#) 







ARMADIO CON PORTE SCORREVOLI 54X27 EH

ART.	L mm	P mm	H mm	KG	RAL	€
  FAA2010C000PD	1020	600	915	800	7035+7016	602,33
 FAA2010C00008	1020	600	915	800	7035	602,33
 FAA2010C00004	1020	600	915	800	5012	602,33



ARMADIO CON PORTE SCORREVOLI 78X27 EH

ART.	L mm	P mm	H mm	KG	RAL	€
  FAA2014C000PD	1428	600	915	800	7035+7016	746,48
 FAA2014C00008	1428	600	915	800	7035	746,48
 FAA2014C00004	1428	600	915	800	5012	746,48



ARMADIO CON PORTE SCORREVOLI 54+54X27 EH

ART.	L mm	P mm	H mm	KG per vano	RAL	€
  FAA2020C000PD	2040	600	915	800	7035+7016	981,77
 FAA2020C00008	2040	600	915	800	7035	981,77
 FAA2020C00004	2040	600	915	800	5012	981,77



ARMADIO CON PORTE SCORREVOLI 54X27 EH

ART.	L mm	P mm	H mm	KG	RAL	€
  FAA2110C000PD	1020	600	2000	1200	7035+7016	787,40
 FAA2110C00008	1020	600	2000	1200	7035	787,40
 FAA2110C00004	1020	600	2000	1200	5012	787,40



ARMADIO CON PORTE SCORREVOLI 78X27 EH

ART.	L mm	P mm	H mm	KG	RAL	€
  FAA2114C000PD	1428	600	2000	1200	7035+7016	985,80
 FAA2114C00008	1428	600	2000	1200	7035	985,80
 FAA2114C00004	1428	600	2000	1200	5012	985,80



ARMADIO CON PORTE SCORREVOLI 54+54X27 EH

ART.	L mm	P mm	H mm	KG per vano	RAL	€
  FAA2120C000PD	2040	600	2000	1200	7035+7016	1304,17
 FAA2120C00008	2040	600	2000	1200	7035	1304,17
 FAA2120C00004	2040	600	2000	1200	5012	1304,17



PORTATA



RAL 7035 + RAL 7016



RAL 5012



RAL 7035



ARMADIO CON PORTE SCORREVOLI FESSURATE 54X27 EH



ART.	L mm	P mm	H mm	KG	RAL	€
FAA2210C000PD	1020	600	915	800	7035+7016	602,33



ARMADIO CON PORTE SCORREVOLI FESSURATE 78X27 EH



ART.	L mm	P mm	H mm	KG	RAL	€
FAA2214C000PD	1428	600	915	800	7035+7016	746,48



ARMADIO CON PORTE SCORREVOLI FESSURATE 54+54X27 EH



ART.	L mm	P mm	H mm	KG per vano	RAL	€
FAA2220C000PD	2040	600	915	800	7035+7016	981,77



ARMADIO CON PORTE SCORREVOLI FESSURATE 54X27 EH



ART.	L mm	P mm	H mm	KG	RAL	€
FAA2310C000PD	1020	600	2000	1200	7035+7016	787,40



ARMADIO CON PORTE SCORREVOLI FESSURATE 78X27 EH



ART.	L mm	P mm	H mm	KG	RAL	€
FAA2314C000PD	1428	600	2000	1200	7035+7016	985,80



ARMADIO CON PORTE SCORREVOLI FESSURATE 54+54X27 EH



ART.	L mm	P mm	H mm	KG per vano	RAL	€
FAA2320C000PD	2040	600	2000	1200	7035+7016	1304,17



ARMADIO CON PORTE SCORREVOLI FESSURATE IN POLICARBONATO 54X27 EH



ART.	L mm	P mm	H mm	KG	RAL	€
FAA2410C000PD	1020	600	915	800	7035+7016	743,69



ARMADIO CON PORTE SCORREVOLI FESSURATE IN POLICARBONATO 78X27 EH



ART.	L mm	P mm	H mm	KG	RAL	€
FAA2414C000PD	1428	600	915	800	7035+7016	882,26



ARMADIO CON PORTE SCORREVOLI FESSURATE IN POLICARBONATO 54+54X27 EH



ART.	L mm	P mm	H mm	KG per vano	RAL	€
FAA2420C000PD	2040	600	915	800	7035+7016	1170,25



ARMADIO CON PORTE SCORREVOLI FESSURATE IN POLICARBONATO 54X27 EH



ART.	L mm	P mm	H mm	KG	RAL	€
FAA2510C000PD	1020	600	2000	1200	7035+7016	987,04



ARMADIO CON PORTE SCORREVOLI FESSURATE IN POLICARBONATO 78X27 EH



ART.	L mm	P mm	H mm	KG	RAL	€
FAA2514C000PD	1428	600	2000	1200	7035+7016	1309,44



ARMADIO CON PORTE SCORREVOLI FESSURATE IN POLICARBONATO 54+54X27 EH



ART.	L mm	P mm	H mm	KG per vano	RAL	€
FAA2520C000PD	2040	600	2000	1200	7035+7016	1734,14



PORTATA

RAL 7035 + RAL 7016



TOP IN ACCIAIO INOX SATINATO

ART.	L mm	P mm	H mm	materiale	€
FGG601006AX000A	1020	600	32	MDF	211,73
FGG601406AX000A	1428	600	32	MDF	269,70
FGG602006AX000A	2040	600	32	MDF	358,36



TOP IN ACCIAIO GOMMATO

ART.	L mm	P mm	H mm	materiale	€
FGG601006AG0007	1020	600	32	MDF	218,86
FGG601406AG0007	1428	600	32	MDF	265,36
FGG602006AG0007	2040	600	32	MDF	363,63



TOP IN MULTIPLEX

ART.	L mm	P mm	H mm	materiale	€
FGG601006BE0000	1020	600	30	Multiplex	123,38
FGG601406BE0000	1428	600	30	Multiplex	111,91
FGG602006BE0000	2040	600	30	Multiplex	148,18



PIANO FESSURATO P=500 mm

ART.	L mm	P mm	H mm		finitura	€
FAC9912010099	995	500	35	120	Zincato	25,11
FAC9814010099	1403	500	35	100	Zincato	43,71



KIT PIANI FESSURATI P=500 mm

ART.	L mm	P mm	H mm	n. piani		finitura	€
FAC9912020099	995	500	35	2	120	Zincato	49,60
FAC9912030099	995	500	35	3	120	Zincato	73,16
FAC9912040099	995	500	35	4	120	Zincato	97,03
FAC9814020099	1403	500	35	2	100	Zincato	82,46



COMPONENTI

PIANO/PANNELLO FORATO

Applicabile in 3 diverse posizioni:

Pannello forato verticale

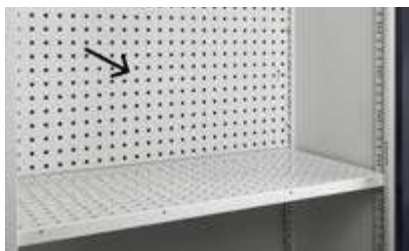

Piano orizzontale



Mensola forata a 4 bordi



PIANO/PANNELLO FORATO

ART.	L mm	P mm	H mm	KG	dim. foro mm	passo mm	RAL	€
FAC9912070039	995	500	30	120-50	10x10	38	7016	58,28
FAC9912070008	995	500	30	120-50	10x10	38	7035	67,27
FAC9912070004	995	500	30	120-50	10x10	38	5012	67,27

KIT PIANI-PANNELLI FORATI

ART.	L mm	P mm	H mm	n. piani	KG	dim. foro mm	passo mm	RAL	€
FAC9912080008	995	500	30	2	120-50	10x10	38	7035	129,27
FAC9912080004	995	500	30	2	120-50	10x10	38	5012	129,27
FAC9912080039	995	500	30	2	120-50	10x10	38	7016	111,60

CASSETTI AD ESTRAZIONE SEMPLICE 54X27 EH



ART.	dim. utili			KG		H frontale cassetto	RAL	€
	L mm	P mm	H mm					
FAC9912180008	908	449	85	50	88%	100	7035	78,12
FAC9912180004	908	449	85	50	88%	100	5012	93,93
FAC9912180039	908	449	85	50	88%	100	7016	78,12

CASSETTI AD ESTRAZIONE TELESCOPICA 54X27 EH



ART.	dim. utili			KG		H frontale cassetto	RAL	€
	L mm	P mm	H mm					
FAC9912190008	908	449	85	100	100%	100	7035	107,57
FAC9912190004	908	449	85	100	100%	100	5012	122,14
FAC9912190039	908	449	85	100	100%	100	7016	107,57
FAC9912210008	908	449	135	100	100%	150	7035	119,97
FAC9912210004	908	449	135	100	100%	150	5012	128,65
FAC9912210039	908	449	135	100	100%	150	7016	119,97



PORTATA



ESTRAZIONE



RAL 5012



RAL 7016



RAL 7035



ZINCATO

COMPONENTI



VASCHE STAGNE INTERNE RACCOLTA LIQUIDI

ART.	L mm	P mm	H mm	KG	L	finitura	€
FAC9911090099	484	500	42	50	9	Zincato	52,70
FAC9912090099	995	500	42	50	19	Zincato	56,73

KIT VASCHE STAGNE INTERNE RACCOLTA LIQUIDI

ART.	L mm	P mm	H mm	KG	L	n. vasche	finitura	€
FAC9911100099	484	500	42	50	9	2	Zincato	98,58
FAC9912100099	995	500	42	50	19	2	Zincato	108,50



CANALETTA ELETTRICA PER MULTIPRESE

ART.	L mm	P mm	H mm	RAL	€
FAC9912220039	1008	64	140	7016	35,03



SCHEMA MULTIPRESE PER CANALETTA ELETTRICA



- 1 magnetotermico
- 2 multipresa 4 scomparti
- 3 multipresa 2 scomparti
- 4 USB ricarica

- 1 magnetotermico
- 2 multipresa 4 scomparti
- 3 multipresa 2 scomparti
- 4 USB ricarica



Applicazione canaletta elettrica sulla **parte superiore** del **piano-pannello forato**



Applicazione canaletta elettrica sulla **parte inferiore** del **piano-pannello forato**



Canaletta elettrica **integrabile** con **piano-pannello forato** in posizione verticale



SUPPORTO LATERALE PER MULTIPRESA

ART.	L mm	P mm	H mm	RAL	€
FAC9912240039	10	463	77	7016	19,84

SCHEMA MULTIPRESE PER SUPPORTO LATERALE

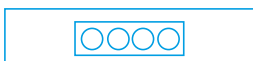

multipresa 4 scomparti



Esempio di applicazione con:
 1 supporto art. FAC9912240039
 1 multipresa art. FBLET005007
 1 cavo di collegamento art. FBLET016007

COMPONENTI



GRIGLIA PER VENTOLE

ART.	L mm	P mm	H mm	RAL	€
FAC9912230039	994	123	136	7016	41,54

Esempio di applicazione con:
 1 griglia art. FAC9912230039
 2 ventole art. FAS32200100
 1 multipresa art. FBLET005007
 1 cavo di collegamento art. FBLET016007



Applicazione griglia nella **parte superiore** dell'armadio **senza** l'ausilio del **piano-pannello forato**



Applicazione griglia nella **parte superiore** dell'armadio **con** l'ausilio del **piano-pannello forato**



Applicazione griglia nella **parte inferiore** dell'armadio **con** l'ausilio del **piano-pannello forato**



VENTOLA 230 V SENZA GRIGLIA CON SPINA SCHUKO

ART.	L mm	P mm	H mm	colore	€
FAS32200100	125	44	125	Nero	33,79

IRONTEAM

vedi pag. 328



FBLET012007



FBLET004007



FBLET005007



FBLET016007



FBLET014007



FBLET020007



FBL99400008

APPLICAZIONE DELLA LAMPADA SOTTO IL PIANO-PANNELLO FORATO



PORTATA



CAPACITÀ



RAL 7016



ZINCATO

COMPONENTI

1. Parete divisorio
2. Kit tubo appendiabiti
3. Piano/pannello forato
4. Piano fessurato
5. Cassetto a estrazione semplice H=100 mm

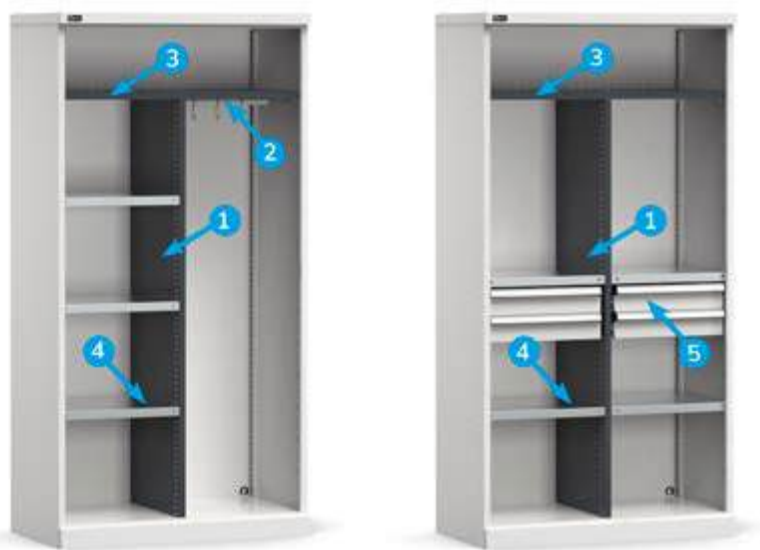

PARETE DIVISORIO

ART.	L mm	P mm	H mm	passo mm	RAL	€
FAC9912260039	44	500	1616	25	7016	84,32

KIT TUBO APPENDIABITI

ART.	L mm	P mm	H mm	KG	finitura	€
FAC9912270099	458	23	56	15	Zincato	11,47

PIANO/PANNELLO FORATO

ART.	L mm	P mm	H mm	KG	RAL	€
FAC9912070039	995	500	30	120-50	7016	58,28

PIANO FESSURATO P=500 mm

ART.	L mm	P mm	H mm	KG	finitura	€
FAC9911010099	484	500	35	120	Zincato	18,29

KIT PIANI FESSURATI P=500 mm

ART.	L mm	P mm	H mm	n. piani	KG	finitura	€
FAC9911020099	484	500	35	2	120	Zincato	28,21
FAC9911030099	484	500	35	3	120	Zincato	41,23

CASSETTI A ESTRAZIONE SEMPLICE 24X27 EH

ART.	dim. utili			KG		H frontale cassetto	RAL	€
	L mm	P mm	H mm					
FAC9911180008	398	449	85	50	88%	100	7035	69,44
FAC9911180004	398	449	85	50	88%	100	5012	77,19
FAC9911180039	398	449	85	50	88%	100	7016	69,44



MATERIALE DI SEPARAZIONE

L 512 mm



ART.	adatto per cassetto H mm	componenti	€
FFH00500100	100	2 x Divisorio trasversale L=202 mm 1 x Divisorio longitudinale fessurato L=457 mm	10,85



ART.	adatto per cassetto H mm	componenti	€
FFH00500800	100/125	3 x Cassetta divisorio 150x75 mm 6 x Cassetta divisorio 150x150 mm	21,39

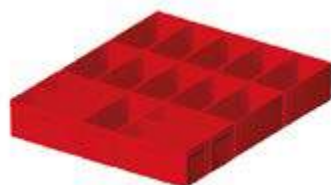

ART.	adatto per cassetto H mm	componenti	€
FFH00500900	100/125	15 x Cassetta divisorio 150x75 mm	26,04

L 1023 mm

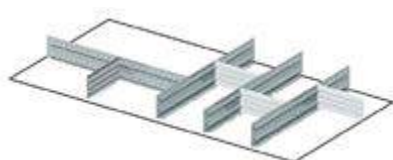

ART.	adatto per cassetto H mm	componenti	€
FFH02000100	100	4 x Divisorio longitudinale fessurato L=457 mm 4 x Divisorio trasversale L=151 mm	26,35

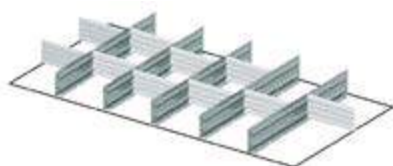

ART.	adatto per cassetto H mm	componenti	€
FFH02000200	100	5 x Divisorio longitudinale fessurato L=457 mm 10 x Divisorio trasversale L=151 mm	36,58



ART.	adatto per cassetto H mm	componenti	€
FFH02000600	100/125	12 x Cassetta divisorio 150x75 mm 12 x Cassetta divisorio 150x150 mm	51,15



DIM. INTERNEL x P



PORTATA



ESTRAZIONE



RAL 5012



RAL 7016



RAL 7035



ZINCATO

START

PRO

PRO+

ARMADI SPOGLIATOIO

PERFOM



Realizzati in robusta lamiera d'acciaio, gli armadi spogliatoio facilitano la custodia di indumenti e abiti di lavoro. Ogni scomparto ha una **profondità di 500 mm** ed è chiuso da una porta con feritoie per la circolazione dell'aria e **serratura a cilindro con chiave**. La configurazione con **divisorio sporco/pulito** e **teito inclinato** li rende adatti ad essere impiegati negli ambienti che richiedono un elevato grado di pulizia e che devono rispondere alla normativa HACCP. Gli armadi spogliatoio possono essere ulteriormente arricchiti con **piedini in polipropilene** resistenti all'acqua e **panche** singole di varie dimensioni.

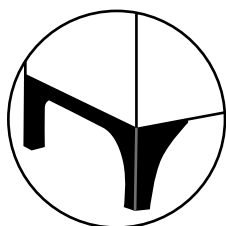

**PIEDINI IN
POLIPROPILENE
FACILE PULIZIA**

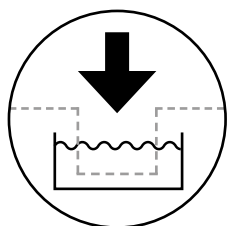

**VERNICIATURA IN
ELETTROFORESI**

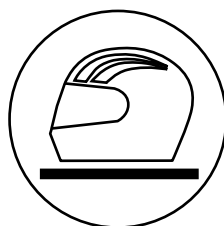

**VERSIONE CON VANO
PORTA CASCO**

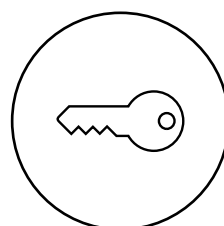

CHIUSURA A CHIAVE



ARMADIO SPOGLIATOIO A 4 SCOMPARTI

ART.	Lmm	Pmm	Hmm	n. scomparti	RAL	€
 PERFOMAN01	1195	502	1950	4	7035	509,33

Composto da:

qtà	descrizione
1	Armadio spogliatoio a tetto orizzontale a 4 scomparti
1	Coppia piedini per armadio spogliatoio

[CONFIGURE](#) 



ARMADIO SPOGLIATOIO A 3 SCOMPARTI CON DIVISORIO

ART.	Lmm	Pmm	Hmm	n. scomparti	RAL	€
 PERFOMAN02	1195	502	1950	3	7035	494,14

Composto da:

qtà	descrizione
1	Armadio spogliatoio a tetto orizzontale a 3 scomparti
1	Coppia piedini per armadio spogliatoio

[CONFIGURE](#) 



ARMADIO SPOGLIATOIO A 4 SCOMPARTI CON TETTO INCLINATO

ART.	Lmm	Pmm	Hmm	n. scomparti	RAL	€
 PERFOMAN03	1195	502	2170	4	7035	583,42

Composto da:

qtà	descrizione
1	Armadio spogliatoio a tetto orizzontale a 4 scomparti
1	Tetto inclinato aggiuntivo
1	Coppia piedini per armadio spogliatoio

[CONFIGURE](#) 



ARMADIO SPOGLIATOIO A 3 SCOMPARTI CON DIVISORIO E TETTO INCLINATO

ART.	Lmm	Pmm	Hmm	n. scomparti	RAL	€
 PERFOMAN04	1195	502	2170	3	7035	568,23

Composto da:

qtà	descrizione
1	Armadio spogliatoio a tetto orizzontale a 3 scomparti
1	Tetto inclinato aggiuntivo
1	Coppia piedini per armadio spogliatoio

[CONFIGURE](#) 



ARMADIO SPOGLIATOIO A 2 SCOMPARTI

ART.	L mm	P mm	H mm	n. scomparti	RAL	€
 FAN1302C00108	608	502	1750	2	7035	289,54

[CONFIGURE](#) 

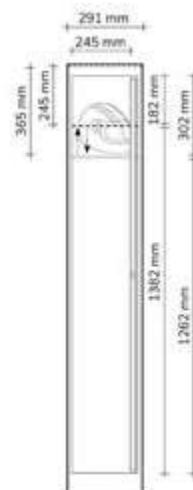

TETTO INCLINATO AGGIUNTIVO

ART.	L mm	P mm	H mm	RAL	€
 FAN51400008	607	502	220	7035	52,70



ARMADIO SPOGLIATOIO A 3 SCOMPARTI

ART.	L mm	P mm	H mm	n. scomparti	RAL	€
 FAN1303C00108	900	502	1750	3	7035	371,69

[CONFIGURE](#) 

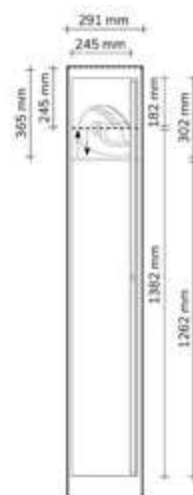

TETTO INCLINATO AGGIUNTIVO

ART.	L mm	P mm	H mm	RAL	€
 FAN51600008	899	502	220	7035	64,17



ARMADIO SPOGLIATOIO A 4 SCOMPARTI

ART.	L mm	P mm	H mm	n. scomparti	RAL	€
 FAN1304C00108	1192	502	1750	4	7035	495,38

[CONFIGURE](#) 

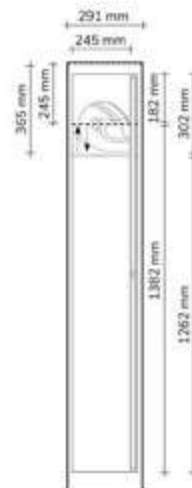

TETTO INCLINATO AGGIUNTIVO

ART.	L mm	P mm	H mm	RAL	€
 FAN51800008	1191	502	220	7035	74,09



COPPIA PIEDINI PER ARMADIO SPOGLIATOIO

ART.	L mm	P mm	H mm	colore	€
 FRR23100001	135	500	180/200	Grigio scuro	13,95



ARMADIO SPOGLIATOIO A 2 SCOMPARTI CON DIVISORIO

ART.	L mm	P mm	H mm	n. scomparti	RAL	€
 FAN1502C03108	802	502	1750	2	7035	352,16

[CONFIGURE](#) 

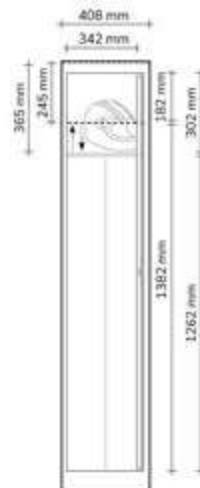

TETTO INCLINATO AGGIUNTIVO

ART.	L mm	P mm	H mm	RAL	€
 FAN51500008	801	502	220	7035	56,11



ARMADIO SPOGLIATOIO A 3 SCOMPARTI CON DIVISORIO

ART.	L mm	P mm	H mm	n. scomparti	RAL	€
 FAN1503C03108	1192	502	1750	3	7035	480,19

[CONFIGURE](#) 

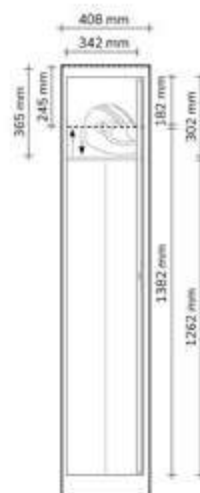

TETTO INCLINATO AGGIUNTIVO

ART.	L mm	P mm	H mm	RAL	€
 FAN51800008	1191	502	220	7035	74,09



SISTEMA DI FISSAGGIO

Il sistema di fissaggio brevettato si compone di una giunzione in polipropilene che integra una piastra forata per avvitarle le gambe alle doghe. Inoltre, funge anche da tappo, chiudendo la doga lateralmente.

PIEDINO REGOLABILE

Il piedino regolabile in altezza tramite vite è dotato di un supporto in polipropilene ad alta resistenza, che previene danni durante la pulizia e la formazione di ruggine in ambienti umidi o su pavimenti bagnati.

COMPOSIZIONI MODULARI

Tutti gli elementi presentano fori laterali per il fissaggio tramite sistema a vite, consentendo la creazione di strutture modulari, solide e compatte.



PANCHINA SINGOLA A 3 DOGHE L= 1000 mm

ART.	L mm	P mm	H mm	KG	RAL	€
FCP1010030001	1017	375	435	300	7000	112,53
FCP1010030008	1017	375	435	300	7035	112,53



PANCHINA SINGOLA A 3 DOGHE L= 1500 mm

ART.	L mm	P mm	H mm	KG	RAL	€
FCP1015030001	1502	375	435	300	7000	136,09
FCP1015030008	1502	375	435	300	7035	136,09



PANCHINA SINGOLA A 3 DOGHE L= 2000 mm

ART.	L mm	P mm	H mm	KG	RAL	€
FCP1020030001	2034	375	435	400	7000	192,51
FCP1020030008	2034	375	435	400	7035	192,51



PORTATA



RAL 7000





RAL 7035





PANCHINA SINGOLA A 3 DOGHE CON SCHIENALE L= 1000 mm

ART.	L mm	P mm	H mm	 KG	RAL	€
 CHILL1001	1017	406	1900	300	7035	307,52

qtà	descrizione
1	Panchina singola a 3 doghe
1	Telaio con appendiabiti e mensola





PANCHINA SINGOLA A 3 DOGHE CON SCHIENALE L= 1500 mm

ART.	L mm	P mm	H mm	 KG	RAL	€
 CHILL1501	1502	406	1900	300	7035	351,54

qtà	descrizione
1	Panchina singola a 3 doghe
1	Telaio con appendiabiti e mensola



PANCHINA SINGOLA A 3 DOGHE CON SCHIENALE L= 2000 mm

ART.	L mm	P mm	H mm	 KG	RAL	€
 CHILL2001	2034	406	1900	400	7035	413,85

qtà	descrizione
1	Panchina singola a 3 doghe
1	Telaio con appendiabiti e mensola



PORTATA



RAL 7035

SISTEMI PORTAUTENSILI CNC

NC



Le soluzioni NC presentano apposite boccole e telai per l'organizzazione sicura e ordinata di mandrini e altri utensili tipicamente impiegati nei macchinari a controllo numerico. Le **boccole in ABS** sono resistenti ad urti, possono essere facilmente pulite e sono disponibili in diverse dimensioni in base alla tipologia di strumento da contenere. Sono posizionate su **telai orizzontali o inclinati** che possono essere installati direttamente su un supporto da banco, su un carrello o inseriti in armadi all'interno di cassette o in sostituzione dei ripiani.

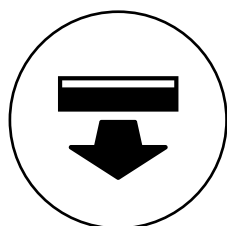

**CASSETTI AD
ESTRAZIONE TOTALE**



**ARMADIO PORTATA
1200 KG**

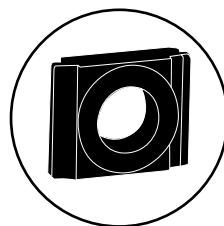

**VASTA GAMMA DI
BOCCOLE**

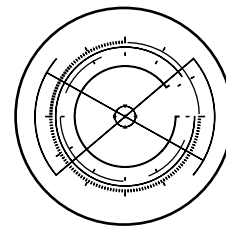

CONFIGURABILE













PORTA UTENSILI



[CONFIGURE](#)









[CONFIGURE](#)

ART.	L mm	P mm	H mm	KG	n. coppia telai per armadio	n. coppia telai per cassetto	n. cassetti	n. boccole	tipo boccole	RAL	€
 PERFORMNC01	1023	555	2000	1200	2	-	-	84	ISO 40	7035	931,86
 PERFORMNC02	1023	555	2000	1200	2	-	-	84	ISO 40	5012	931,86
 PERFORMNC03	1023	555	2000	1200	2	-	-	50	ISO 50	7035	863,04
 PERFORMNC04	1023	555	2000	1200	2	-	-	50	ISO 50	5012	863,04
 PERFORMNC05	1023	555	2000	1200	2	-	-	60	HSKA63-B80	7035	928,14
 PERFORMNC06	1023	555	2000	1200	2	-	-	60	HSKA63-B80	5012	928,14
 PERFORMNC07	1023	555	2000	1200	1	1	2	84	ISO 40	7035	1127,47
 PERFORMNC08	1023	555	2000	1200	1	1	2	84	ISO 40	5012	1156,61
 PERFORMNC09	1023	555	2000	1200	1	1	2	50	ISO 50	7035	1058,65
 PERFORMNC10	1023	555	2000	1200	1	1	2	50	ISO 50	5012	1087,79
 PERFORMNC11	1023	555	2000	1200	1	1	2	60	HSKA63-B80	7035	1123,75
 PERFORMNC12	1023	555	2000	1200	1	1	2	60	HSKA63-B80	5012	1152,89



[CONFIGURE](#)

ART.	L mm	P mm	H mm	KG senza ruote	KG set ruote	n. telai	n. boccole	tipo boccole	RAL	€
 COMBINC01	1064	512	892	500	825	3	35	ISO 40	7035+7000	535,99
 COMBINC02	1064	512	892	500	825	3	35	ISO 40	5012+7000	535,99
 COMBINC03	1064	512	892	500	825	3	25	ISO 50	7035+7000	518,94
 COMBINC04	1064	512	892	500	825	3	25	ISO 50	5012+7000	518,94
 COMBINC05	1064	512	892	500	825	3	25	HSKA63-B80	7035+7000	534,44
 COMBINC06	1064	512	892	500	825	3	25	HSKA63-B80	5012+7000	534,44



PORTATA



RAL 7035+RAL 7000



RAL 5012+RAL 7000





RAL 5012

































RAL 7035



TELAIO PORTA BOCCOLE DA BANCO

ART.	L mm	P mm	H mm	RAL	€
 FNC20100008	565	450	351	7035	106,02
 FNC20100004	565	450	351	5012	105,09

BOCCOLA

ART.	tipo	multiplo d'ordine	q.tà max					€
								
 FNC95100003	ISO 30	7	7	21	42	35	21	2,48
 FNC95300003	ISO 40	7	7	21	42	35	21	2,48
 FNC95400003	ISO 45	6	6	18	30	30	18	2,79
 FNC95500003	ISO 50	5	5	15	25	20	15	2,79
 FNC95600003	VDI30	7	7	21	42	35	21	3,41
 FNC95700003	VDI40	5	5	15	30	30	15	3,41
 FNC95800003	VDI50	5	5	15	30	30	15	4,34
 FNC95900003	VDI60	5	5	15	25	20	15	7,75
 FNC97200003	CONO MORSE 2	7	7	21	42	35	21	3,41
 FNC97300003	CONO MORSE 3	7	7	21	42	35	21	3,41
 FNC97400003	CONO MORSE 4	7	7	21	42	35	21	3,41
 FNC97500003	CONO MORSE 5	5	5	15	30	30	15	3,41
 FNC92700003	CAPTO C3	7	7	21	42	35	21	4,34
 FNC92750003	CAPTO C4	5	5	15	30	30	15	4,34
 FNC92800003	CAPTO C5	5	5	15	30	30	15	4,34
 FNC92850003	CAPTO C6	5	5	15	30	30	15	4,34
 FNC92900003	CAPTO C8	5	5	15	20	20	15	4,34
 FNC92100003	HSKA32-B40	7	7	21	42	35	21	3,41
 FNC92200003	HSKA40-B50	7	7	21	42	35	21	3,41
 FNC92300003	HSKA50-B63	5	5	15	30	30	15	3,41
 FNC92400003	HSKA63-B80	5	5	15	30	30	15	3,41
 FNC92500003	HSKA80-B100	5	5	15	20	20	15	4,34
 FNC92600003	HSK A100-B125	5	5	15	20	20	15	4,34
 FNC96400003	2"	6	6	18	30	30	18	4,65
 FNC96500003	2" 1/4	5	5	15	25	20	15	7,75

COMPONENTI



ARMADIO CON PORTE A BATTENTE 54X27 EH

ART.	L mm	P mm	H mm	KG	RAL	€
FAA1420C000PD	1023	555	2000	1200	7035+7016	440,82
FAA1420C00008	1023	555	2000	1200	7035	440,82
FAA1420C00004	1023	555	2000	1200	5012	440,82

CASSETTI AD ESTRAZIONE TELESCOPICA 54X27 EH



ART.	dim. utili			KG		H frontale cassetto	RAL	€
	L mm	P mm	H mm					
FAC9912190008	908	449	85	100	100%	100	7035	107,57
FAC9912190004	908	449	85	100	100%	100	5012	122,14
FAC9912190039	908	449	85	100	100%	100	7016	107,57
FAC9912210008	908	449	135	100	100%	150	7035	119,97
FAC9912210004	908	449	135	100	100%	150	5012	128,65
FAC9912210039	908	449	135	100	100%	150	7016	119,97



TELAIO PORTA BOCCOLE A 3 FILE PER CASSETTO COMPLETO DI SUPPORTI - CONFEZIONE 2 PEZZI

boccole escluse

ART.	L mm	P mm	H mm	RAL	€
FNC5140S101	894	446	142/180	7000	121,83



TELAIO PORTA BOCCOLE A 3 FILE PER ARMADIO - CONFEZIONE 2 PEZZI

ART.	L mm	P mm	H mm	KG	RAL	€
FNC5160S101	965	444	68	150	7000	141,36



RUOTA GIREVOLE



RUOTA GIREVOLE CON FRENO



RUOTA FISSA

CARRELLO PORTA UTENSILI CON RUOTE

ART.	L mm	P mm	H mm	KG senza ruote	ruote					RAL	€
					Ø mm	materiale	KG set ruote				
FCNF1001056	1064	512	892	500	125	Nylon	825	2	2	7035+7000	449,19
FCNF1001051	1064	512	892	500	125	Nylon	825	2	2	5012+7000	449,19



PORTATA



ESTRAZIONE



RAL 7035+RAL 7016



RAL 7035+RAL 7000



RAL 5012+RAL 7000



RAL 5012



RAL 7000



RAL 7016



RAL 7035

SISTEMI DI STOCCAGGIO SOSTANZE PERICOLOSE

ECOLOGIA



Le vasche di raccolta prevengono gli sversamenti accidentali di sostanze pericolose ed inquinanti, in ottemperanza al D.Lgs. N.152/2006 e D.Lgs. N.81/2008. Attenzione! Si ricorda di non stoccare nella stessa vasca sostanze chimiche che a contatto tra loro possano reagire e di verificare la compatibilità delle sostanze pericolose stoccate con il materiale di fabbricazione di vasca e griglia. La capacità dei contenitori stoccabili sopra ogni vasca e le informazioni fornite, non esaustive né vincolanti, sono valide per il territorio italiano. Per altri Paesi, attenersi alle disposizioni specifiche vigenti nel Paese di utilizzo e contattare le autorità locali competenti per maggiori informazioni.



VASCHE DI RACCOLTA + RIPIANI E VASCHE PERFORM IN ACCIAIO

Idonee a liquidi infiammabili delle categorie **GHS 1 – 3** e liquidi inquinanti per le acque delle categorie **GHS 1 – 4**.

Non sono ammesse **sostanze corrosive**.

VASCHE DI RACCOLTA IN PE

Idonee a liquidi inquinanti per le acque delle categorie **GHS 1 – 4**.

Non sono ammesse **sostanze infiammabili**.



BENNE

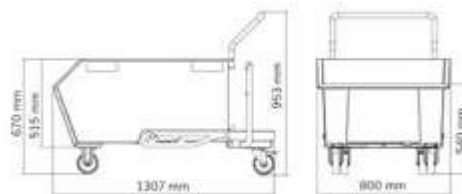
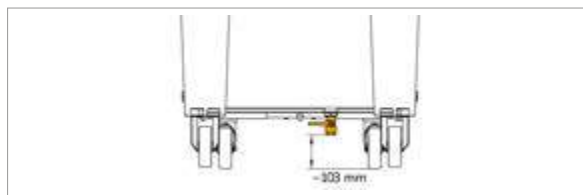

CE

PATENTED

BENNA PORTAROTTAMI RIBALTABILE CAPACITÀ 300 L CON RUOTE PREDISPOSTA PER GRIGLIA E RUBINETTO

ART.	Lmm	Pmm	Hmm	L	KG	ruote						RAL	€
						Ø mm	H mm	materiale	KG set ruote	↻	⌵		
FAXEPR030060039	1307	800	953	300	800	125	155	Nylon	825	2	2	7016	697,19
FAXEPR030060004	1307	800	953	300	800	125	155	Nylon	825	2	2	5012	697,19

Benna fornita smontata

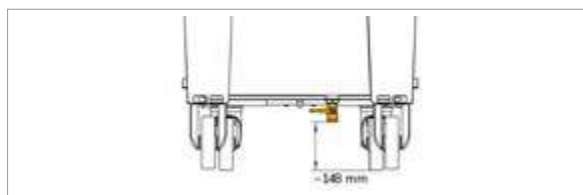

CE

PATENTED

BENNA PORTAROTTAMI RIBALTABILE CAPACITÀ 500 L CON RUOTE PREDISPOSTA PER GRIGLIA E RUBINETTO

ART.	Lmm	Pmm	Hmm	L	KG	ruote						RAL	€
						Ø mm	H mm	materiale	KG set ruote	↻	⌵		
FAXEPR050060039	1412	800	970	500	1000	160	200	Nylon	1050	2	2	7016	890,01
FAXEPR050060004	1412	800	970	500	1000	160	200	Nylon	1050	2	2	5012	890,01

Benna fornita smontata



PORTATA



CAPACITÀ



RUOTA FISSA



RUOTA GIREVOLE CON FRENO



RAL 5012

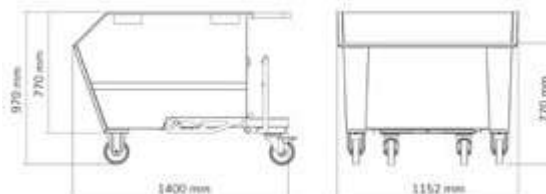
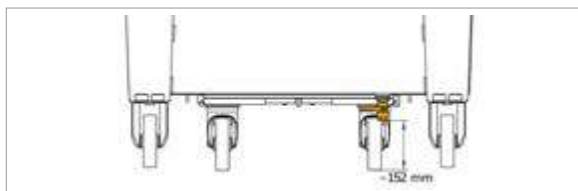

RAL 7016

BENNE

CE

BENNA PORTAROTTAMI RIBALTABILE CAPACITÀ 750 L CON RUOTE PREDISPOSTA PER GRIGLIA E RUBINETTO

ART.	L mm	P mm	H mm	L	KG	ruote						RAL	€
						Ø mm	H mm	materiale	KG set ruote	↻	⌵		
FAXEPR075060039	1400	1152	970	750	1350	160	200	Nylon	1050	2	2	7016	995,10
FAXEPR075060004	1400	1152	970	750	1350	160	200	Nylon	1050	2	2	5012	995,10

Benna fornita smontata

CILINDRO IDRAULICO PER IL RIBALTAMENTO FRENATO DELLA BENNA

CILINDRO IDRAULICO PER BENNA

ART.	L mm	P mm	H mm	€
FAXEAC004000007	401/671	42	42	98,89

RUBINETTO FRONTALE PER LO SCARICO DEI LIQUIDI RESIDUI

KIT RUBINETTO + GRIGLIA

ART.	L mm	P mm	H mm	adatto per	€
FAXEAC001000099	700	388	25	FAXEPR0300600	93,00
FAXEAC003000099	685	388	25	FAXEPR0500600	93,00
FAXEAC002000099	1028	388	25	FAXEPR0750600	112,53

PORTA BIG BAG



CE

PATENTED

Telaio fornito smontato su palletta

PORTA BIG BAG REGOLABILE IN ALTEZZA

ART.	L mm	P mm	H mm	KG	RAL	€
 FAXEBB1002H0039	1090	1084	1205/1395	1000	7016	372,00





Big bag escluso

- Gambe regolabili in altezza (1205 - 1395 mm) per ospitare big bag di due misure diverse
- Ripiani inferiori lisci per maggiore sostegno al sacco
- Portata testata: 1000 kg
- Sovrapposizione: 1+2 telai
- Possibilità di inserire e sfilare il big bag anche in caso di telai sovrapposti
- Imballo in cartone su pallet non fumigato



CONTENITORE ADR CON COPERCHIO - OMOLOGATO 11H2/Y

ART.	L mm	P mm	H mm	KG	€
 FAX1091B3Y00001	1200	1000	830	360	488,25

 N. pezzi max sovrapponibili: 4 (portata statica max. 1388 kg)



PORTATA



CAPACITÀ



RUOTA FISSA



RUOTA GIREVOLE CON FRENO



RAL 5012



RAL 7016



VASCA CONICA DI RACCOLTA CAPACITÀ 200 L

ART.	L mm	P mm	H mm	L	RAL	€
ECO1314	1310	800	351	200	7016	266,60
ECO1302	1310	800	351	200	5012	266,60

Composto da:

qtà	descrizione
1	Vasca conica di raccolta capacità 200 L
2	Kit 2 doghe
1	Kit 2 pettini per vasca conica



vedi pag. 492



VASCA DI RACCOLTA CAPACITÀ 200 L

ART.	L mm	P mm	H mm	L	RAL	€
ECO1315	1300	805	400	200	7016	305,66
ECO1303	1300	805	400	200	5012	305,66

Composto da:

qtà	descrizione
1	Vasca di raccolta capacità 200 L
2	Kit 2 doghe
1	Kit 2 pettini L=800 mm



vedi pag. 492



VASCA DI RACCOLTA CAPACITÀ 300 L

ART.	L mm	P mm	H mm	L	RAL	€
ECO1316	1300	1205	400	300	7016	379,44
ECO1304	1300	1205	400	300	5012	379,44

Composto da:

qtà	descrizione
1	Vasca di raccolta capacità 300 L
3	Kit 2 doghe
1	Kit 2 pettini L=1200 mm



vedi pag. 492



VASCA DI RACCOLTA CAPACITÀ 400 L

ART.	L mm	P mm	H mm	L	RAL	€
ECO1318	1300	1222	400	400	7016	408,89
ECO1306	1300	1222	400	400	5012	408,89

Composto da:

qtà	descrizione
1	Vasca di raccolta capacità 300 L
3	Kit 2 doghe
1	Kit 2 pettini L=1200 mm
1	Kit 2 tappi con guarnizioni

Grazie all'utilizzo del kit tappi la capacità della vasca da 300 litri aumenta a 400 litri



vedi pag. 492



VASCA DI RACCOLTA CAPACITÀ 800 L

ART.	L mm	P mm	H mm	L	RAL	€
ECO1319	1300	2422	400	800	7016	817,78
ECO1307	1300	2422	400	800	5012	817,78

Composto da:

qtà	descrizione
2	Vasca di raccolta capacità 300 L
6	Kit 2 doghe
2	Kit 2 pettini L=1200 mm
1	Kit di accoppiamento vasche
1	Kit 2 tappi con guarnizioni



vedi pag. 492

Fusti esclusi



Esempio accoppiamento vasche:

1. Kit di accoppiamento vasche (composto da profilo in acciaio zincato salvagoccia e collettore con due guarnizioni)
2. Kit 2 tappi con guarnizioni





VASCA DI RACCOLTA CAPACITÀ 300 L CON PORTA FUSTI

ART.	L mm	P mm	H mm	L	RAL	€
ECO1322	1300	1205	787	300	7016	504,06
ECO1311	1300	1205	787	300	5012	530,72

Composto da:

qtà	descrizione
1	Vasca di raccolta capacità 300 L
2	Kit 2 doghe
1	Porta fusti per 2 fusti



vedi pag. 492

Fusti esclusi



VASCA DI RACCOLTA CAPACITÀ 200 L CON RUOTE

ART.	L mm	P mm	H mm	L	RAL	€
ECO1320	1491	800	1018	200	7016	434,62
ECO1308	1491	800	1018	200	5012+7016	434,62

Composto da:

qtà	descrizione
1	Vasca di raccolta capacità 200 L
2	Kit 2 doghe
1	Kit 2 pettini L=800 mm
1	Maniglia per vasca
1	Kit 4 ruote in nylon Ø 125 mm



vedi pag. 492

Fusti esclusi





VASCA DI RACCOLTA CAPACITÀ 1000 L

ART.	L mm	P mm	H mm	L	RAL	€
ECO1317	1600	1300	640	1000	7016	745,86
ECO1305	1600	1300	640	1000	5012	745,86

Composto da:

qtà	descrizione
1	Vasca di raccolta capacità 1000 L
4	Kit 2 doghe
2	Kit 2 pettini L=800 mm



vedi pag. 492

Cisterna esclusa



VASCA DI RACCOLTA CAPACITÀ 1000 L CON TELAIO

ART.	L mm	P mm	H mm	L	RAL	€
ECO1321	1600	1306	1065	1000	7016	1010,60
ECO1309	1600	1306	1065	1000	5012	1037,57

Composto da:

qtà	descrizione
1	Vasca di raccolta capacità 1000 L
4	Kit 2 doghe
1	Telaio per vasca di raccolta



vedi pag. 492

Cisterna esclusa





VASCHE DI RACCOLTA



vedi pag. 492

Cisterne escluse

VASCA DI RACCOLTA CAPACITÀ 1100 L CON TELAI

ART.	L mm	P mm	H mm	ℓ	RAL	€
 ECO1323	1306	3222	825	1100	7016	1685,16
 ECO1313	1306	3222	825	1100	5012	1739,10

Composto da:

qtà	descrizione
2	Vasca di raccolta capacità 300 L
1	Vasca di raccolta capacità 200 L
8	Kit 2 doghe
2	Telaio per vasca di raccolta
1	Kit 2 tappi con guarnizioni
2	Kit di accoppiamento vasche

Grazie all'utilizzo del kit tappi la capacità della vasca da 300 litri aumenta a 400 litri, mentre il volume di contenimento della vasca da 200 litri aumenta a 300 litri.



Esempio accoppiamento vasche:

1. Vasca di raccolta capacità 300 L
2. Vasca di raccolta capacità 200 L
3. Kit 2 tappi con guarnizioni
4. Kit di accoppiamento vasche (composto da profilo in acciaio zincato salvagoccia e collettore con due guarnizioni)

VASCHE DI RACCOLTA



vedi pag. 492



Cisterne escluse

VASCA DI RACCOLTA CAPACITÀ 1200 L

ART.	L mm	P mm	H mm	L	RAL	€
ECO1324	1300	3627	400	1200	7016	1226,67
ECO1325	1300	3627	400	1200	5012	1226,67

Composto da:

qtà	descrizione
3	Vasca di raccolta capacità 300 L
9	Kit 2 doghe
3	Kit 2 pettini L=1200 mm
2	Kit di accoppiamento vasche
1	Kit 2 tappi con guarnizioni



Esempio accoppiamento vasche:

1. Kit di accoppiamento vasche (composto da profilo in acciaio zincato salvagoccia e collettore con due guarnizioni)
2. Kit 2 tappi con guarnizioni

1

2



CAPACITÀ



RAL 5012



RAL 7016

VASCHE DI RACCOLTA



SUPPORTO IN POLIETILENE PER RIALZO

ART.	L mm	P mm	H mm	per fusti		colore	€
				n.	L		
FAX002068000005	465	610	410	1	200	Giallo	153,45
FAX002070000005	1200	780	255	2	200	Giallo	374,48



VASCA DI RACCOLTA IN POLIETILENE CON GRIGLIA PER FUSTI

ART.	L mm	P mm	H mm	L	per fusti		colore	€
					n.	L		
FAX002064000005	925	800	420	225	1	200	Giallo	364,87
FAX002065000005	1350	800	420	305	2	200	Giallo	652,55
FAX002066000005	1350	1350	490	500	4	200	Giallo	891,25



vedi pag. 492



VASCA DI RACCOLTA IN POLIETILENE CON GRIGLIA PER CISTERNA

ART.	L mm	P mm	H mm	L	per cisterna		colore	€
					n.	L		
FAX002067000005	1350	1350	970	1050	1	1000	Giallo	1283,40



vedi pag. 492



ARMADI DI SICUREZZA



CONFIGURE

ART.	L mm	P mm	H mm	KG	RAL	€
PERFORM12013	1048	600	1027	800	1004	502,20
PERFORM12014	1048	600	1027	800	7035+7016	502,20
PERFORM12015	1048	600	1027	800	7035	502,20
PERFORM12016	1048	600	1027	800	5012	502,20

Composto da:

qtà	descrizione
1	Armadio con porte a battente fessurate
1	Piano fessurato
1	Vasca stagna esterna di raccolta liquidi capacità 59 L



vedi pag. 492



CONFIGURE

ART.	L mm	P mm	H mm	KG	RAL	€
PERFORM12017	1023	555	1000	800	1004	466,24
PERFORM12018	1023	555	1000	800	7035+7016	466,24
PERFORM12019	1023	555	1000	800	7035	466,24
PERFORM12020	1023	555	1000	800	5012	466,24

Composto da:

qtà	descrizione
1	Armadio con porte a battente fessurate
1	Kit 2 vasche stagne interne di raccolta liquidi capacità 19 L



vedi pag. 492



CONFIGURE

ART.	L mm	P mm	H mm	KG	RAL	€
PERFORM12025	1048	600	1027	800	6011	502,20

Composto da:

qtà	descrizione
1	Armadio con porte a battente fessurate
1	Piano fessurato
1	Vasca stagna esterna di raccolta liquidi capacità 59 L



vedi pag. 492



- PORTATA
- CAPACITÀ
- RAL 7035+RAL 7016
- RAL 1004
- RAL 5012
- RAL 6011
- RAL 7035



[CONFIGURE](#)

ART.	L mm	P mm	H mm	KG	RAL	€
PERFOM14056	1048	600	2027	1200	6011	633,33

Composto da:

qtà	descrizione
1	Armadio con porte a battente fessurate
1	Kit 3 piani fessurati
1	Vasca stagna esterna di raccolta liquidi capacità 59 L



vedi pag. 492



[CONFIGURE](#)

ART.	L mm	P mm	H mm	KG	RAL	€
PERFOM14057	1023	555	2000	1200	6011	657,82

Composto da:

qtà	descrizione
1	Armadio con porte a battente fessurate
2	Kit 2 vasche stagne interne di raccolta liquidi capacità 19 L



vedi pag. 492



ART.	L mm	P mm	H mm	KG	RAL	€
PERFOM14058	1023	555	2000	1200	7035	791,74

Composto da:

qtà	descrizione
1	Armadio con porte a battente fessurate in policarbonato
2	Kit 2 vasche stagne interne di raccolta liquidi capacità 19 L



vedi pag. 492

ECOLOGIA

ARMADI DI SICUREZZA

BENNE	PORTA BIG BAG	CONTENITORE ADR	VASCHE DI RACCOLTA	ARMADI DI SICUREZZA
-------	---------------	-----------------	--------------------	----------------------------



CONFIGURE

ART.	L mm	P mm	H mm	KG	RAL	€
PERFOM14025	1048	600	2027	1200	1004	644,18
PERFOM14026	1048	600	2027	1200	7035+7016	633,33
PERFOM14027	1048	600	2027	1200	7035	633,33
PERFOM14028	1048	600	2027	1200	5012	633,33

Composto da:

qtà	descrizione
1	Armadio con porte a battente fessurate
1	Kit 3 piani fessurati
1	Vasca stagna esterna di raccolta liquidi capacità 59 L



vedi pag. 492



CONFIGURE

ART.	L mm	P mm	H mm	KG	RAL	€
PERFOM14029	1023	555	2000	1200	1004	668,67
PERFOM14030	1023	555	2000	1200	7035+7016	657,82
PERFOM14031	1023	555	2000	1200	7035	657,82
PERFOM14032	1023	555	2000	1200	5012	657,82

Composto da:

qtà	descrizione
1	Armadio con porte a battente fessurate
2	Kit 2 vasche stagne interne di raccolta liquidi capacità 19 L



vedi pag. 492



PORTATA	RAL 7035+RAL 7016	RAL 1004	RAL 5012	RAL 6011	RAL 7035

CARRELLI PER OFFICINA

CLEVER-COMBI



Clever e Combi sono pratici carrelli per la movimentazione di prodotti e attrezzatura nell'ambiente di lavoro. In particolare, **Clever** è un innovativo **carrello componibile** che può essere impiegato anche come carrello officina grazie alla possibilità di personalizzarlo con ripiani o piano di lavoro in legno, cassetti, pannelli forati, porte, ganci e accessori Iron Team. **Combi**, invece, presenta uno o due **pianali** che lo rendono ideale all'utilizzo in **magazzino** per la movimentazione di semilavorati o prodotti.

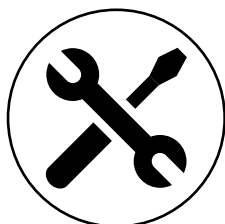

FACILI DA
MONTARE



PORTATA PIANI 100
KG

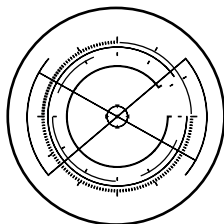

CONFIGURABILE

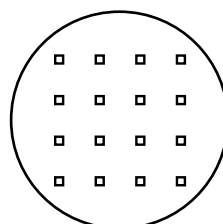



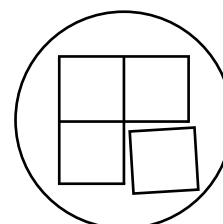

FORI QUADRI
10X10



COMPONIBILI



ART.	L mm	P mm	H mm	 senza ruote	 set ruote	RAL	€
 CLEVER0903	908	515	819	300	225	7035	159,03
 CLEVER0904	908	515	819	300	225	5012	159,03

Composto da:

qtà	descrizione
1	Carrello smontato senza ruote
1	Kit 4 ruote in gomma standard Ø 100 mm

[CONFIGURE](#) 







ART.	L mm	P mm	H mm	 senza ruote	 set ruote	RAL	€
 CLEVER0905	908	515	819	300	225	7035	201,81
 CLEVER0906	908	515	819	300	225	5012	201,81

Composto da:

qtà	descrizione
1	Carrello smontato senza ruote
1	Piano aggiuntivo
1	Kit 4 ruote in gomma standard Ø 100 mm

[CONFIGURE](#) 



ART.	L mm	P mm	H mm	 senza ruote	 set ruote	RAL	€
 CLEVER0907	908	515	846	300	300	7035	211,73
 CLEVER0908	908	515	846	300	300	5012	211,73

Composto da:

qtà	descrizione
1	Carrello smontato senza ruote
1	Piano aggiuntivo
1	Kit 4 ruote in gomma antitraccia sintetica Ø 125 mm

[CONFIGURE](#) 



PORTATA



RAL 5012



RAL 7035



ART.	L mm	P mm	H mm	senza ruote	set ruote	RAL	€
CLEVER1003	1028	615	819	300	225	7035	178,25
CLEVER1004	1028	615	819	300	225	5012	178,25

Composto da:

qtà	descrizione
1	Carrello smontato senza ruote
1	Kit 4 ruote in gomma standard Ø 100 mm

[CONFIGURE](#)



ART.	L mm	P mm	H mm	senza ruote	set ruote	RAL	€
CLEVER1005	1028	615	846	300	300	7035	234,67
CLEVER1006	1028	615	846	300	300	5012	234,67

Composto da:

qtà	descrizione
1	Carrello smontato senza ruote
1	Piano aggiuntivo
1	Kit 4 ruote in gomma standard Ø 125 mm

[CONFIGURE](#)



ART.	L mm	P mm	H mm	senza ruote	set ruote	RAL	€
CLEVER1007	1028	615	846	300	300	7035	239,32
CLEVER1008	1028	615	846	300	300	5012	239,32

Composto da:

qtà	descrizione
1	Carrello smontato senza ruote
1	Piano aggiuntivo
1	Kit 4 ruote in gomma antitraccia sintetica Ø 125 mm

[CONFIGURE](#)



ART.	L mm	P mm	H mm	senza ruote	set ruote	RAL	€
CLEVER1009	1028	615	868	300	300	7035	297,91
CLEVER1010	1028	615	868	300	300	5012	297,91

Composto da:

qtà	descrizione
1	Carrello smontato senza ruote
1	Piano in legno con supporti
1	Kit 4 ruote in gomma antitraccia sintetica Ø 125 mm

[CONFIGURE](#)



ART.	L mm	P mm	H mm	senza ruote	set ruote	RAL	€
CLEVER1011	1030	615	846	300	300	7035	313,72
CLEVER1012	1030	615	846	300	300	5012	313,72

Composto da:

qtà	descrizione
1	Carrello smontato senza ruote
1	Piano aggiuntivo
2	Pannello laterale forato
1	Kit 4 ruote in gomma antitraccia sintetica Ø 125 mm

[CONFIGURE](#)



ART.	L mm	P mm	H mm	senza ruote	set ruote	RAL	€
CLEVER1013	1030	615	868	300	300	7035	372,31
CLEVER1014	1030	615	868	300	300	5012	372,31

Composto da:

qtà	descrizione
1	Carrello smontato senza ruote
1	Piano in legno con supporti
2	Pannello laterale forato
1	Kit 4 ruote in gomma antitraccia sintetica Ø 125 mm

[CONFIGURE](#)



PORTATA



RAL 5012



RAL 7035



ART.	L mm	P mm	H mm	senza ruote	set ruote	RAL	€
CLEVER1015	1030	630	868	300	300	7035	426,56
CLEVER1016	1030	630	868	300	300	5012	426,56

Composto da:

qtà	descrizione
1	Carrello smontato senza ruote
1	Piano in legno con supporti
2	Pannello laterale forato
1	Pannello posteriore forato
1	Kit 4 ruote in gomma antitraccia sintetica Ø 125 mm

[CONFIGURE](#)



ART.	L mm	P mm	H mm	senza ruote	set ruote	RAL	€
CLEVER1017	1030	655	868	300	300	7035	584,66
CLEVER1018	1030	655	868	300	300	5012	584,66

Composto da:

qtà	descrizione
1	Carrello smontato senza ruote
1	Piano in legno con supporti
2	Pannello laterale forato
1	Pannello posteriore forato
1	Coppia porte a battente
1	Kit 4 ruote in gomma antitraccia sintetica Ø 125 mm

[CONFIGURE](#)



ART.	L mm	P mm	H mm	senza ruote	set ruote	RAL	€
CLEVER1019	1028	615	846	300	300	7035+7016	346,27
CLEVER1020	1028	615	846	300	300	5012	353,09

Composto da:

qtà	descrizione
1	Carrello smontato senza ruote
1	Piano aggiuntivo
1	Armadio L=500 mm con 1 cassetto H=150 mm
1	Kit 4 ruote in gomma antitraccia sintetica Ø 125 mm

[CONFIGURE](#)



ART.	L mm	P mm	H mm	senza ruote	set ruote	RAL	€
CLEVER1021	1030	633	1538	300	300	7035	461,59
CLEVER1022	1030	633	1538	300	300	5012	461,59

Composto da:

qtà	descrizione
1	Carrello smontato senza ruote
1	Piano in legno con supporti
2	Pannello laterale forato
1	Pannello posteriore forato
1	Coppia montanti per fissaggio pannello
1	Kit 4 ruote in gomma antitraccia sintetica Ø 125 mm

[CONFIGURE](#)



ART.	L mm	P mm	H mm	senza ruote	set ruote	RAL	€
CLEVER1023	1030	658	1538	300	300	7035	673,94
CLEVER1024	1030	658	1538	300	300	5012	673,94

Composto da:

qtà	descrizione
1	Carrello smontato senza ruote
1	Piano in legno con supporti
2	Pannello laterale forato
2	Pannello posteriore forato
1	Coppia montanti per fissaggio pannello
1	Coppia porte a battente
1	Kit 4 ruote in gomma antitraccia sintetica Ø 125 mm

[CONFIGURE](#)



ART.	L mm	P mm	H mm	senza ruote	set ruote	RAL	€
CLEVER1025	1028	654	1538	300	300	7035+7016	494,14
CLEVER1026	1028	654	1538	300	300	5012	500,96

Composto da:

qtà	descrizione
1	Carrello smontato senza ruote
1	Piano in legno con supporti
1	Pannello posteriore forato
1	Coppia montanti per fissaggio pannello
1	Armadio L=500 mm con 1 cassetto H=150 mm
1	Kit 4 ruote in gomma antitraccia sintetica Ø 125 mm

[CONFIGURE](#)



PORTATA



RAL 7035 + RAL 7016



RAL 5012



RAL 7035



CONFIGURE

ART.	L mm	P mm	H mm	senza ruote	set ruote	RAL	€
CLEVER1027	1347	633	1538	300	300	7035	717,34
CLEVER1028	1347	633	1538	300	300	5012	717,34

Composto da:

qtà	descrizione
1	Carrello smontato senza ruote
1	Piano in legno con supporti
2	Pannello laterale forato
1	Pannello posteriore forato
1	Coppia montanti per fissaggio pannello
1	Mensola grande reversibile
1	Barra aggancio per contenitori Picking Box mis. 1/2
1	Kit 3 contenitori Picking Box Air mis. 2
1	Porta bombolette a 6 posti
2	Porta silicone inclinato a 2 posti
1	Kit porta rotolo con carta Ø=240 mm
2	Calamita completa di clip e vite - confezione 10 pezzi
1	Kit 4 ruote in gomma antitraccia sintetica Ø 125 mm



CONFIGURE



ART.	L mm	P mm	H mm	KG senza ruote	KG set ruote	RAL	€
CLEVER1029	1347	658	1538	300	300	7035	1101,12
CLEVER1030	1347	658	1538	300	300	5012	1101,12

Composto da:

qtà	descrizione
1	Carrello smontato senza ruote
1	Piano in legno con supporti
2	Pannello laterale forato
2	Pannello posteriore forato
1	Coppia montanti per fissaggio pannello
1	Coppia porte a battente
1	Kit porta rotolo con carta Ø=240 mm
1	Porta bombolette a 6 posti
2	Mensola grande reversibile
1	Cestino capacità 30 L
1	Cavo di collegamento wieland schuko/francese
1	Multipresa schuko a 4 scomparti
1	Multipresa schuko a 2 scomparti
1	Supporto multipresa a 4 scomparti
1	Supporto multipresa a 2 scomparti
2	Calamita completa di clip e vite - confezione 10 pezzi
1	Kit 4 ruote in gomma antitraccia sintetica Ø 125 mm



PORTATA







RAL 5012



RAL 7035









CARRELLO SMONTATO SENZA RUOTE

ART.	L mm	P mm	H mm	KG	RAL	€
 FCR10S0X208	908	515	691	300	7035	112,22
 FCR10S0X204	908	515	691	300	5012	112,22
 FCR11S0X208	1028	615	691	300	7035	131,44
 FCR11S0X204	1028	615	691	300	5012	131,44







KIT RUOTE

ART.	Ø mm	KG set ruote	H mm	materiale			€
 FKRD1002107	100	225	128	Gomma standard	2	2	46,81
 FKRB1252107	125	300	155	Gomma standard	2	2	52,08
 FKRU1252101	125	300	155	Gomma antitraccia sintetica	2	2	56,73
 FKRS1252101	125	750	155	Gomma elastica	2	2	90,83



PIANO AGGIUNTIVO

ART.	L mm	P mm	H mm	adatto per	KG	RAL	€
 FCR10120108	810	510	35	Carrello Clever Small	100	7035	42,78
 FCR10120104	810	510	35		100	5012	42,78
 FCR11120108	930	610	35	Carrello Clever Large	100	7035	51,15
 FCR11120104	930	610	35		100	5012	51,15





PANNELLO POSTERIORE FORATO

ART.	L mm	P mm	H mm	adatto per	dim. foro mm	passo mm	RAL	€
 FCR11150108	895	22	690	Carrello Clever Large	10x10	38	7035	54,25
 FCR11150104	895	22	690		10x10	38	5012	54,25

 Per l'installazione sulla parte superiore del carrello è necessario ordinare la coppia montanti



COPIA MONTANTI PER FISSAGGIO PANNELLO

ART.	L mm	P mm	H mm	RAL	€
 FCR10170139	45	35	650	7016	35,03

 Per l'installazione sulla parte superiore del carrello è necessario ordinare la coppia montanti



COPIA PORTE A BATTENTE

ART.	L mm	P mm	H mm	adatto per	dim. foro mm	passo mm	RAL	€
 FCR11160108	936	44	690	Carrello Clever Large	10x10	38	7035	158,10
 FCR11160104	936	44	690		10x10	38	5012	158,10



PANNELLO LATERALE FORATO

ART.	L mm	P mm	H mm	adatto per	dim. foro mm	passo mm	RAL	€
 FCR11140108	573	7	688	Carrello Clever Large	10x10	38	7035	37,20
 FCR11140104	573	7	688		10x10	38	5012	37,20



PORTATA



RUOTA FISSA



RUOTA GIREVOLE CON FRENO



RAL 5012



RAL 7016



RAL 7035

COMPONENTI





PIANO IN LEGNO CON SUPPORTI

ART.	L mm	P mm	H mm	adatto per	KG	€
 FCR11130100	930	610	51	Carrello Clever Large	100	109,74



ARMADIO L=500 MM CON 1 CASSETTO H=150 MM

ART.	L mm	P mm	H mm	KG	RAL	€
 FBG03S50C0001PD	500	630	210	80	7035+7016	106,95
 FBG03S50C000104	500	630	210	80	5012	113,77

IRONTEAM

vedi pag. 320



FBLIT020099
FBLIT0610LQ



FBL95410000

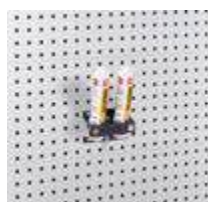

FBLIT008039



FBLIT004039



FBLIT010039



FBLIT017039



FBLET012007



FBLET004007



FBLET005007



FBLET016007



CARELLO CON BASE IN ACCIAIO CON RUOTE

ART.	L mm	P mm	H mm	senza ruote	ruote			RAL	€			
					Ø mm	materiale	set ruote					
FCEP1052004	1095	700	1000	500	200	Gomma standard	615	1	1	2	5012	371,38



CARELLO CON BASE IN ACCIAIO CON RUOTE

ART.	L mm	P mm	H mm	senza ruote	ruote			RAL	€			
					Ø mm	materiale	set ruote					
FCEB1050308	1135	700	915	500	125	Gomma standard	300	1	1	2	7035	185,07
FCEB1050304	1135	700	915	500	125	Gomma standard	300	1	1	2	5012	198,09



CARELLO CON BASE IN ACCIAIO CON RUOTE

ART.	L mm	P mm	H mm		ruote		RAL	€
					Ø mm			
FCR00210008	555	445	845	150	100	4	7035	139,50
FCR00210004	555	445	845	150	100	4	5012	147,25



PORTATA



RUOTA FISSA



RUOTA GIREVOLE



RUOTA GIREVOLE CON FRENO



RAL 7035 + RAL 7016



RAL 5012



RAL 7035

CARRELLI COMPONENTIBILI MULTIUSO

BIN CART



Il carrello Bin Cart è caratterizzato da una **struttura base composta da telaio e montanti biasolati** che può essere allestita con una **vasta gamma di componenti** per adattarlo a seconda delle necessità dell'operatore. Ripiani, pannelli forati, supporti, ganci e profili per contenitori trasformano Bin Cart in carrelli per picking magazzino, porta pneumatici, 5S Lean Production, portaminuteria, rastrelliera, per imbracature e molto altro. Sono disponibili in **tre diverse larghezze** (700, 1000 o 1500 mm), **due altezze** (1201 e 1809 mm) e possono presentare ruote in gomma standard, gomma antitraccia sintetica o gomma elastica.

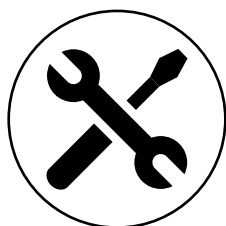

**FACILI DA
MONTARE**



**PORTATA
CARRELLO 300 KG**

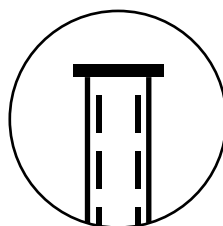

**MONTANTE
FORATO PASSO 38
MM**

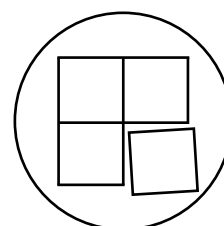

COMPONIBILI

BIN CART



CONFIGURE

PATENTED*

CARRELLO CON 192 PICKING BOX AIR

ART.	L mm	P mm	H mm	KG	colore contenitori	RAL	€
BINCART1050	1067	668	1384	300		7016	639,22
BINCART1052	1067	668	1384	300		7016	639,22
BINCART1053	1067	668	1384	300		7016	639,22
BINCART1054	1067	668	1384	300		7016	639,22
BINCART1055	1067	668	1384	300		7016	639,22

Completo di:

qtà	descrizione
192	Contenitore in polipropilene Picking Box Air mis. 1



CONFIGURE

PATENTED*

CARRELLO CON 120 PICKING BOX AIR

ART.	L mm	P mm	H mm	KG	colore contenitori	RAL	€
BINCART1056	1067	668	1384	300		7016	616,90
BINCART1058	1067	668	1384	300		7016	616,90
BINCART1059	1067	668	1384	300		7016	616,90
BINCART1060	1067	668	1384	300		7016	616,90
BINCART1061	1067	668	1384	300		7016	616,90

Completo di:

qtà	descrizione
48	Contenitore in polipropilene Picking Box Air mis. 1
72	Contenitore in polipropilene Picking Box Air mis. 2



CONFIGURE

PATENTED*

CARRELLO CON 100 PICKING BOX AIR

ART.	L mm	P mm	H mm	KG	colore contenitori	RAL	€
BINCART1062	1067	668	1384	300		7016	600,16
BINCART1064	1067	668	1384	300		7016	600,16
BINCART1065	1067	668	1384	300		7016	600,16
BINCART1066	1067	668	1384	300		7016	600,16
BINCART1067	1067	668	1384	300		7016	600,16

Completo di:

qtà	descrizione
48	Contenitore in polipropilene Picking Box Air mis. 1
36	Contenitore in polipropilene Picking Box Air mis. 2
16	Contenitore in polipropilene Picking Box Air mis. 3A2



PORTATA



RAL 7016

BIN CART



CONFIGURE

PATENTED*

CARELLO CON 132 PICKING BOX AIR

ART.	L mm	P mm	H mm	KG	colore contenitori	RAL	€
BINCART1068	1067	668	1384	300		7016	570,40
BINCART1070	1067	668	1384	300		7016	570,40
BINCART1071	1067	668	1384	300		7016	570,40
BINCART1072	1067	668	1384	300		7016	570,40
BINCART1073	1067	668	1384	300		7016	570,40

Completo di:

qtà	descrizione
96	Contenitore in polipropilene Picking Box Air mis. 1
36	Contenitore in polipropilene Picking Box Air mis. 2



CONFIGURE

PATENTED*

CARELLO CON 48 PICKING BOX AIR

ART.	L mm	P mm	H mm	KG	colore contenitori	RAL	€
BINCART1074	1067	668	1384	300		7016	613,18
BINCART1076	1067	668	1384	300		7016	613,18
BINCART1077	1067	668	1384	300		7016	613,18
BINCART1078	1067	668	1384	300		7016	613,18
BINCART1079	1067	668	1384	300		7016	613,18

Completo di:

qtà	descrizione
48	Contenitore in polipropilene Picking Box Air mis. 3A2



CONFIGURE

PATENTED*

CARELLO CON VISUAL BOX

ART.	L mm	P mm	H mm	KG	colore cassettiere	RAL	€
BINCART0701	761	668	1384	300		7016	624,34

Completo di:

qtà	descrizione
2	Cassettiere Visual Box con 3 cassette
2	Cassettiere Visual Box con 4 cassette
4	Cassettiere Visual Box con 5 cassette
6	Cassettiere Visual Box con 6 cassette

BIN CART



CONFIGURE

PATENTED*

ART.	L mm	P mm	H mm	KG	RAL	€
BINCART1007	1067	668	1543	300	7016	461,28

Composto da:

qtà	descrizione
1	Carrello smontato senza ruote
1	Coppia piastre di supporto per profilo in alluminio
3	Profilo in alluminio
1	Pannello forato/mensola con 1 bordo fermacasse
1	Pensile con porta
3	Barra aggancio per contenitori Picking Box mis. 1/2
3	Kit 4 contenitori Picking Box Air mis. 1
1	Kit 4 ruote in gomma antitraccia sintetica Ø 125 mm



CONFIGURE

PATENTED*

ART.	L mm	P mm	H mm	KG	RAL	€
BINCART1006	1067	668	1992	300	7016	388,74

Composto da:

qtà	descrizione
1	Carrello smontato senza ruote
2	Coppia piastre di supporto per profilo in alluminio
6	Profilo in alluminio
1	Kit 4 ruote in gomma antitraccia sintetica Ø 125 mm



Courtesy of Autofficina Trento Severino





PORTATA



RAL 7016

BIN CART





ART.	L mm	P mm	H mm	 KG	RAL	€
 BINCART0704	761	668	1384	300	7016	375,41

Composto da:

qtà	descrizione
1	Carrello smontato senza ruote
4	Pannello forato/mensola con 1 bordo fermacasse
3	Kit staffe per fissaggio pannelli a parete
1	Kit 4 ruote in gomma antitraccia sintetica Ø 125 mm

[CONFIGURE](#) 





ART.	L mm	P mm	H mm	 KG	RAL	€
 BINCART1008	1067	668	1384	300	7016	406,41

Composto da:

qtà	descrizione
1	Carrello smontato senza ruote
4	Pannello forato/mensola con 1 bordo fermacasse
3	Kit staffe per fissaggio pannelli a parete
1	Kit 4 ruote in gomma antitraccia sintetica Ø 125 mm

[CONFIGURE](#) 



ART.	L mm	P mm	H mm	 KG	RAL	€
 BINCART1501	1552	668	1384	300	7016	450,12



Composto da:

qtà	descrizione
1	Carrello smontato senza ruote
4	Pannello forato/mensola con 1 bordo fermacasse
3	Kit staffe per fissaggio pannelli a parete
1	Kit 4 ruote in gomma antitraccia sintetica Ø 125 mm

[CONFIGURE](#) 

BIN CART





ART.	L mm	P mm	H mm		RAL	€
 BINCART0705	761	668	1992	300	7016	498,79

Composto da:

qtà	descrizione
1	Carrello smontato senza ruote
6	Pannello forato/mensola con 1 bordo fermacasse
4	Kit staffe per fissaggio pannelli a parete
1	Kit 4 ruote in gomma antitraccia sintetica Ø 125 mm

[CONFIGURE](#) 





ART.	L mm	P mm	H mm		RAL	€
 BINCART1009	1067	668	1992	300	7016	541,88

Composto da:

qtà	descrizione
1	Carrello smontato senza ruote
6	Pannello forato/mensola con 1 bordo fermacasse
4	Kit staffe per fissaggio pannelli a parete
1	Kit 4 ruote in gomma antitraccia sintetica Ø 125 mm

[CONFIGURE](#) 



ART.	L mm	P mm	H mm		RAL	€
 BINCART1502	1552	668	1992	300	7016	605,74

Composto da:

qtà	descrizione
1	Carrello smontato senza ruote
6	Pannello forato/mensola con 1 bordo fermacasse
4	Kit staffe per fissaggio pannelli a parete
1	Kit 4 ruote in gomma antitraccia sintetica Ø 125 mm

[CONFIGURE](#) 



PORTATA



RAL 7016

BIN CART



ART.	L mm	P mm	H mm	 KG	RAL	€
BINCART0706	761	668	1992	300	7016	423,46

Composto da:

qtà	descrizione
1	Carrello smontato senza ruote
2	Pannello forato/mensola con 1 bordo fermacasse
2	Kit staffe per fissaggio pannelli a parete
1	Profilo in alluminio
10	Gancio porta cavi P=171 mm
1	Kit 4 ruote in gomma antitraccia sintetica Ø 125 mm

[CONFIGURE](#) 



ART.	L mm	P mm	H mm	 KG	RAL	€
BINCART1010	1067	668	1992	300	7016	447,33

Composto da:

qtà	descrizione
1	Carrello smontato senza ruote
2	Pannello forato/mensola con 1 bordo fermacasse
2	Kit staffe per fissaggio pannelli a parete
1	Profilo in alluminio
10	Gancio porta cavi P=171 mm
1	Kit 4 ruote in gomma antitraccia sintetica Ø 125 mm

[CONFIGURE](#) 



ART.	L mm	P mm	H mm	 KG	RAL	€
BINCART1503	1552	668	1992	300	7016	487,94

Composto da:

qtà	descrizione
1	Carrello smontato senza ruote
2	Pannello forato/mensola con 1 bordo fermacasse
2	Kit staffe per fissaggio pannelli a parete
1	Profilo in alluminio
10	Gancio porta cavi P=171 mm
1	Kit 4 ruote in gomma antitraccia sintetica Ø 125 mm

[CONFIGURE](#) 



BIN CART



ART.	L mm	P mm	H mm	KG	RAL	€
BINCART0707	761	668	1384	300	7016	283,03

Composto da:

qtà	descrizione
1	Carrello smontato senza ruote
1	Profilo in alluminio
10	Gancio porta cavi P=171 mm
1	Kit 4 ruote in gomma antitraccia sintetica Ø 125 mm

[CONFIGURE](#)



ART.	L mm	P mm	H mm	KG	RAL	€
BINCART1011	1067	668	1384	300	7016	294,81

Composto da:

qtà	descrizione
1	Carrello smontato senza ruote
1	Profilo in alluminio
10	Gancio porta cavi P=171 mm
1	Kit 4 ruote in gomma antitraccia sintetica Ø 125 mm

[CONFIGURE](#)



Attrezzatura esclusa



ART.	L mm	P mm	H mm	KG	RAL	€
BINCART1504	1552	668	1384	300	7016	315,27

Composto da:

qtà	descrizione
1	Carrello smontato senza ruote
1	Profilo in alluminio
10	Gancio porta cavi P=171 mm
1	Kit 4 ruote in gomma antitraccia sintetica Ø 125 mm

[CONFIGURE](#)





PORTATA



RAL 7016

BIN CART





ART.	L mm	P mm	H mm	 KG	RAL	€
 BINCART0708	761	668	1384	300	7016	411,68

Composto da:

qtà	descrizione
1	Carrello smontato senza ruote
2	Profilo in alluminio
6	Coppia supporti P=266 mm
1	Kit 4 ruote in gomma antitraccia sintetica Ø 125 mm

[CONFIGURE](#) 



ART.	L mm	P mm	H mm	 KG	RAL	€
 BINCART1012	1067	668	1384	300	7016	427,80

Composto da:



qtà	descrizione
1	Carrello smontato senza ruote
2	Profilo in alluminio
6	Coppia supporti P=266 mm
1	Kit 4 ruote in gomma antitraccia sintetica Ø 125 mm

[CONFIGURE](#) 



Attrezzatura esclusa



ART.	L mm	P mm	H mm	 KG	RAL	€
 BINCART1505	1552	668	1384	300	7016	458,49

Composto da:



qtà	descrizione
1	Carrello smontato senza ruote
2	Profilo in alluminio
6	Coppia supporti P=266 mm
1	Kit 4 ruote in gomma antitraccia sintetica Ø 125 mm

[CONFIGURE](#) 



BIN CART





ART.	L mm	P mm	H mm		RAL	€
 BINCART0709	761	668	1992	300	7016	462,83

Composto da:

qtà	descrizione
1	Carrello smontato senza ruote
1	Pannello forato/mensola con 1 bordo fermacasse
1	Kit porta rotolo con carta Ø=240 mm
1	Mensola piccola reversibile
2	Profilo in alluminio
3	Coppia supporti P=421 mm
1	Kit 4 ruote in gomma antitraccia sintetica Ø 125 mm

[CONFIGURE](#) 





ART.	L mm	P mm	H mm		RAL	€
 BINCART1013	1067	668	1992	300	7016	625,89

Composto da:

qtà	descrizione
1	Carrello smontato senza ruote
1	Pannello forato/mensola con 1 bordo fermacasse
2	Pensile con porta
2	Profilo in alluminio
3	Coppia supporti P=421 mm
1	Kit 4 ruote in gomma antitraccia sintetica Ø 125 mm

[CONFIGURE](#) 



ART.	L mm	P mm	H mm		RAL	€
 BINCART1506	1552	668	1992	300	7016	611,32

Composto da:

qtà	descrizione
1	Carrello smontato senza ruote
1	Pannello forato/mensola con 1 bordo fermacasse
1	Pensile con porta
2	Mensola grande reversibile
2	Profilo in alluminio
3	Coppia supporti P=421 mm
1	Kit 4 ruote in gomma antitraccia sintetica Ø 125 mm

[CONFIGURE](#) 





PORTATA

RAL 7016



CONFIGURE 

PATENTED

ART.	L mm	P mm	H mm	 KG	RAL	€
 BINCART1005	1067	668	1677	300	7016	473,37

Composto da:

qtà	descrizione
1	Carrello smontato senza ruote
3	Pannello non forato/mensola
1	Pannello forato/mensola con 1 bordo fermacasse
1	Coppia squadrette a L
1	Snodo per piastra

qtà	descrizione
1	Piastra porta monitor con standard VESA
1	Supporto multipresa a 4 scomparti
1	Multipresa schuko a 4 scomparti
1	Cavo di collegamento wieland schuko/francese
1	Kit 4 ruote in gomma antitraccia sintetica Ø 125 mm



BIN CART



CONFIGURE 

Contenitori esclusi



ART.	L mm	P mm	H mm	 KG	RAL	€
 BINCART1004	1067	668	1384	300	7016	331,70

Composto da:

qtà	descrizione
1	Carrello smontato senza ruote
3	Pannello forato/mensola con 1 bordo fermacasse
1	Profilo in alluminio
1	Kit 4 ruote in gomma antitraccia sintetica Ø 125 mm



PORTATA





RAL 7016



[CONFIGURE](#)

Banco escluso

ART.	L mm	P mm	H mm	 KG	RAL	€
 BINCART1014	2513	850	2267	300	7016	1093,99

Composto da:

qtà	descrizione
1	Carrello smontato senza ruote
1	Kit 2 supporti inclinati con binario
1	Lampada doppia
3	Pannello forato/mensola con 1 bordo fermacasse
4	Kit 2 contenitori Picking Box Air mis. 3A2
2	Braccio estensibile per montante
1	Kit 4 ruote in gomma antitraccia sintetica Ø 125 mm



qtà	descrizione
2	Piastra porta monitor con standard VESA
1	Pannello per Picking Box
5	Barra aggancio per contenitori Picking Box mis. 1/2
5	Kit 4 contenitori Picking Box Air mis. 1
1	Pannello per Visual Box
2	Cassettiera Visual Box con 6 cassetti
1	Cassettiera Visual Box con 5 cassetti

BIN CART



[CONFIGURE](#)

Banco escluso

ART.	L mm	P mm	H mm		RAL	€
 BINCART1507	2998	850	2267	300	7016	1147,62

Composto da:

qtà	descrizione
1	Carrello smontato senza ruote
3	Pannello forato/mensola con 1 bordo fermacasse
1	Kit 2 supporti inclinati con binario
1	Lampada doppia
2	Braccio estensibile per montante
2	Piastra porta monitor con standard VESA
1	Pannello per Picking Box

qtà	descrizione
4	Barra aggancio per contenitori Picking Box mis. 1/2
4	Kit 4 contenitori Picking Box Air mis. 1
1	Pannello per Visual Box
2	Cassettiera Visual Box con 6 cassetti
1	Cassettiera Visual Box con 5 cassetti
36	Contenitore in polipropilene Picking Box Air mis. 2
1	Kit 4 ruote in gomma antitraccia sintetica Ø 125 mm



PORTATA





RAL 7016

COMPONENTI

L ➔ 700 mm



CARRELLO SMONTATO SENZA RUOTE

ART.	L mm	P mm	H mm	KG	per lato	RAL	€
 FBC10070039	709	668	1228	300	150	7016	113,77
 FBC15070039	709	668	1836	300	150	7016	143,22

PROFILO IN ALLUMINIO

ART.	L mm	P mm	H mm	KG	materiale	€
 FBC25070000	705	35	60	40	Alluminio	16,43



COPPIA SUPPORTI PARZIALI PER VISUAL BOX

ART.	L mm	P mm	H mm	KG	RAL	€
 FBC30070139	649	50	319	75	7016	23,87



COPPIA SUPPORTI TOTALI PER VISUAL BOX

ART.	L mm	P mm	H mm	KG	RAL	€
 FBC30070239	649	50	1153	150	7016	35,65



COMPONENTI

L → 700 mm



PANNELLO NON FORATO/MENSOLA

Può essere utilizzato come chiusura della base del carrello

ART.	L mm	P mm	H mm	KG	RAL	€
FBL76580008	647	31	494	25-50	7035	39,68



PANNELLO FORATO/MENSOLA CON 1 BORDO FERMACASSE

ART.	L mm	P mm	H mm	dim. foro mm	passo mm	RAL	€
FBL76080108	647	40	456	10x10	38	7035	38,44
FBL76080104	647	40	456	10x10	38	5012	45,88

VISUAL BOX



CASSETTIERA VISUAL BOX

ART.	multiplo d'ordine	dim. ingombro			cassetti				colore	€
		L mm	P mm	H mm	n.	L mm	P mm	H mm		
FAXVBCH00900001	1	600	68	78	9	56	43	47	Grigio scuro	12,40
FAXVBCH00600001	1	600	96	112	6	88	65	70	Grigio scuro	14,57
FAXVBCH00500001	1	600	140	168	5	108	98	107	Grigio scuro	23,25
FAXVBCH00400001	1	600	178	206	4	138	127	134	Grigio scuro	32,24
FAXVBCH00300001	1	600	210	242	3	180	145	161	Grigio scuro	39,37

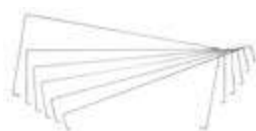

FERMO PER CASSETTIERA VISUAL BOX

ART.	adatto per	€
FAXVBCHL0900099	FAXVBCH009000	1,86
FAXVBCHL0600099	FAXVBCH006000	1,86
FAXVBCHL0500099	FAXVBCH005000	1,86
FAXVBCHL0400099	FAXVBCH004000	1,86
FAXVBCHL0300099	FAXVBCH003000	1,86



PORTATA



RAL 5012



RAL 7016



RAL 7035





ALLUMINIO

COMPONENTI

L ➔ 1000 mm



CARRELLO SMONTATO SENZA RUOTE

ART.	L mm	P mm	H mm	KG	KG per lato	RAL	€
 FBC10100039	1015	668	1228	300	150	7016	121,21
 FBC15100039	1015	668	1836	300	150	7016	150,97

PROFILO IN ALLUMINIO

ART.	L mm	P mm	H mm	KG	materiale	€
 FBC25100000	1011	35	60	40	Alluminio	20,77



PROFILO IN ALLUMINIO PER PICKING BOX AIR

ART.	L mm	P mm	H mm	KG	materiale	€
 FBC25100300	1011	35	118	80	Alluminio	27,90





PANNELLO NON FORATO/MENSOLA

Può essere utilizzato come chiusura della base del carrello

ART.	L mm	P mm	H mm	KG	RAL	€
 FBL76680008	953	31	494	25-50	7035	48,67

PANNELLO FORATO/MENSOLA CON 1 BORDO FERMACASSE

ART.	L mm	P mm	H mm	dim. foro mm	passo mm	RAL	€
 FBL76170108	953	40	456	10x10	38	7035	44,33
 FBL76170104	953	40	456	10x10	38	5012	56,11



BIN CART

COMPONENTI

L → 1000 mm



1

CONTENITORE CON FONDO RINFORZATO - DIM. INGOMBRO (mm): L=108 P=173 H=76

ART.	multiplo d'ordine	mis.	dim. utili			L	colore	€
			L mm	P mm	H mm			
FPB0001R051LQ	48	1	65	128	71	1	■	1,24
FPB0001R05132	48	1	65	128	71	1	■	1,24
FPB0001R0511Z	48	1	65	128	71	1	■	1,24
FPB0001R0512Y	48	1	65	128	71	1	■	1,24
FPB0001R0514Q	48	1	65	128	71	1	■	1,24



2

CONTENITORE CON FONDO RINFORZATO - DIM. INGOMBRO (mm): L=160 P=234 H=127

ART.	multiplo d'ordine	mis.	dim. utili			L	colore	€
			L mm	P mm	H mm			
FPB0002R051LQ	36	2	95	170	121	3,8	■	2,17
FPB0002R05132	36	2	95	170	121	3,8	■	2,17
FPB0002R0511Z	36	2	95	170	121	3,8	■	2,17
FPB0002R0512Y	36	2	95	170	121	3,8	■	2,17
FPB0002R0514Q	36	2	95	170	121	3,8	■	2,17



3A2

CONTENITORE CON FONDO RINFORZATO - DIM. INGOMBRO (mm): L=224 P=354 H=147

ART.	multiplo d'ordine	mis.	dim. utili			L	colore	€
			L mm	P mm	H mm			
FPB03A2R051LQ	16	3A2	157	278	140	9,4	■	5,58
FPB03A2R05132	16	3A2	157	278	140	9,4	■	5,58
FPB03A2R0511Z	16	3A2	157	278	140	9,4	■	5,58
FPB03A2R0512Y	16	3A2	157	278	140	9,4	■	5,58
FPB03A2R0514Q	16	3A2	157	278	140	9,4	■	5,58



COPPIA PIASTRE DI SUPPORTO PER PROFILO IN ALLUMINIO

ART.	L mm	P mm	H mm	KG	RAL	€
FBC40100039	524	104	3	80	7016	28,21



1. Profilo in alluminio
2. Coppia piastre di supporto per profilo in alluminio
3. Gancio porta cavi P=221 mm

PORTATA

CAPACITÀ

RAL 5012

RAL 7016

RAL 7035

ALLUMINIO

COMPONENTI

L ➔ 1500 mm



CARRELLO SMONTATO SENZA RUOTE

ART.	L mm	P mm	H mm	KG	per lato	RAL	€
 FBC10150039	1500	668	1228	300	150	7016	131,44
 FBC15150039	1500	668	1836	300	150	7016	164,61



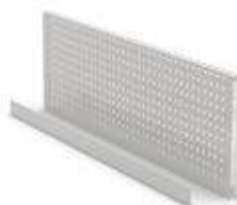

PROFILO IN ALLUMINIO

ART.	L mm	P mm	H mm	KG	materiale	€
 FBC25150000	1496	35	60	40	Alluminio	31,00



PANNELLO FORATO/MENSOLA CON 1 BORDO FERMACASSE

ART.	L mm	P mm	H mm	dim. foro mm	passo mm	RAL	€
 FBL76320108	1438	40	456	10x10	38	7035	52,70
 FBL76320104	1438	40	456	10x10	38	5012	74,71





BIN CART

COMPONENTI

L → 700 - 1000 - 1500 mm





GANCIO PORTA CAVI

ART.	L mm	P mm	H mm	KG	€
 FBC35100099	28	171	84	10	9,61
 FBC35150099	28	221	84	10	9,92
 FBC35200099	28	271	84	10	10,54









COPPIA SUPPORTI

ART.	dim. ingombro			dim. utili	KG	RAL	€
	L mm	P mm	H mm	P mm			
 FBC45030008	36	300	136	266	70	7035	34,72
 FBC45040008	36	455	136	421	50	7035	38,44



KIT RUOTE

ART.	Ø mm	KG set ruote	H mm	materiale			€
 FKRD1002107	100	225	128	Gomma standard	2	2	46,81
 FKRB1252107	125	300	155	Gomma standard	2	2	52,08
 FKRU1252101	125	300	155	Gomma antitraccia sintetica	2	2	56,73
 FKRS1252101	125	750	155	Gomma elastica	2	2	90,83

IRON TEAM

vedi pag. 320



FBLIT020099
FBLIT0610LQ



FBL95410000



FBLIT008039



FBLIT004039



FBLIT010039



FBLIT017039



FBLET012007



FBLET004007



FBLET005007



FBLET016007



PORTATA



RUOTA FISSA



RUOTA GIREVOLE CON FRENO



RAL 5012



RAL 7016



RAL 7035



ALLUMINIO

START

PRO

PRO+

ARREDO GARAGE





GARAGE

CARATTERISTICHE



TUTTO PARTE DAL PIANO

I moduli inferiori dispongono di un piano di lavoro di profondità 630 mm che consente di disporre di spazi ampi per poter lavorare in comodità.



LO SCORRERE DELL'ANTA

Gli armadi ad ante scorrevoli aumentano la capacità di stoccaggio della postazione di lavoro riducendo gli ingombri e gli ostacoli che deriverebbero dall'utilizzo di armadi ad ante a battente.



L'ARMADIO SEGRETO

L'armadio tecnico è ideato per celare all'interno rulli per arrotolatori e cavi elettrici, così da rendere visibili solo i componenti necessari per il lavoro.



Courtesy of Trident Motorsport

GARAGE



IL BASCULANTE DEL GARAGE

Aperture basculanti possono essere inserite nei moduli inferiori per sfruttare spazi che altrimenti sarebbero inutilizzati. Facilitano la differenziazione dei rifiuti, contribuendo a mantenere la postazione di lavoro pulita e in ordine.



DIETRO L'ANGOLO

Il modulo ad angolo può essere arricchito con un massimo di 4 prese elettriche e 2 arrotolatori. Permette di sfruttare al massimo gli spazi e di disporre di un piano di lavoro di notevoli dimensioni.



IL CASSETTO DELLE MERAVIGLIE

Estrazione del 100% e portata di 70 kg rendono i cassetti la custodia ideale per attrezzatura e utensili per il lavoro. L'estrazione totale permette di avere una visuale completa dell'interno e facilita il prelievo del materiale stoccato.



GARAGE



STOCCAGGIO SOSPESO

Il pensile con apertura a Vasistas silenziosa può essere installato a muro oppure su parete forata e permette di avere a disposizione un ulteriore luogo per l'organizzazione del materiale di lavoro.



AUTOPORTANTE

Tutte le soluzioni che compongono l'arredo Garage non necessitano di fissaggio a muro. Le diverse strutture come moduli e pensili sono autoportanti.



PIEDINI REGOLABILI

I piedini consentono di regolare l'altezza dei moduli di arredo officina, con un intervallo che varia da 0 a 2 cm.



GARAGE

MODULI

Il sistema modulare permette l'integrazione di più moduli per creare strutture che possono adattarsi facilmente alle dimensioni dell'ambiente in cui devono essere installate. I moduli sono disponibili in 7 diverse larghezze, da un minimo di 512 mm ad un massimo di 2040 mm, e si suddividono in moduli base, piani di lavoro, pensili, armadi, cassettiere e angolari.



512

714

1020

1193

1428

1734

2040

TOP IN VARIE TIPOLOGIE



Acciaio **inox** satinato



Acciaio **gommato**



Legno **multiplex**



Courtesy of Trident Motorsport

GARAGE

TUTTI I COLORI PIÙ UNO!

In base all'ambiente in cui è installato o in base ai colori aziendali, l'arredo Garage può essere monocolore o bicolore. Sono a disposizione, infatti, fino a 12 colori RAL per personalizzare la struttura e i frontali.

STRUTTURA

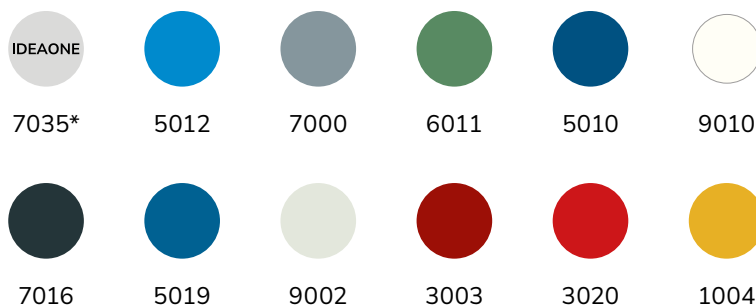

FRONTALI

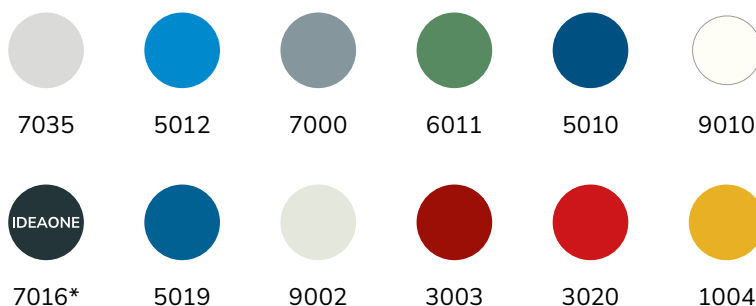

*La struttura e i frontali nei colori **Ideaone** RAL 7035 + RAL 7016 sono pronti a magazzino.

GARAGE

BEST SELLER



714
mm

1020

1428

1734

2040

CORNER

FLEXA



512
mm

1023

1020

1427

2040



CONFIGURE

ART.	L mm	P mm	H mm	top	RAL	€
GARAGE086	3306	2694	2000	Inox satinato	7035+7016	7781,00
GARAGE087	3306	2694	2000	Acciaio gommato	7035+7016	7789,06

GARAGE

BEST SELLER



714
mm

1020

1428

1734

2040

CORNER

FLEXA



512
mm

1023

1020

1427

2040



RAL 7035 + RAL 7016

GARAGE

BEST SELLER



714
mm

1020

1428

1734

2040

CORNER

FLEXA



512
mm

1023

1020

1427

2040



CONFIGURE

ART.	L mm	P mm	H mm	top	RAL	€
GARAGE090	3063	640	2000	Inox satinato	7035+7016	4185,31
GARAGE091	3063	640	2000	Acciaio gommato	7035+7016	4190,58

GARAGE

BEST SELLER



714
mm

1020

1428

1734

2040

CORNER

FLEXA



512
mm

1023

1020

1427

2040



CONFIGURE

ART.	Lmm	Pmm	H mm	top	RAL	€
GARAGE088	8976	640	2000	Inox satinato	7035+7016	10627,73
GARAGE089	8976	640	2000	Acciaio gommato	7035+7016	10624,32



CONFIGURE

ART.	Lmm	Pmm	H mm	top	RAL	€
GARAGE104	2757	640	2000	Inox satinato	7035+7016	3410,93
GARAGE105	2757	640	2000	Acciaio gommato	7035+7016	3397,60



RAL 7035 + RAL 7016

GARAGE

BEST SELLER



714
mm

1020

1428

1734

2040

CORNER

FLEXA



512
mm

1023

1020

1427

2040



CONFIGURE

ART.	L mm	P mm	H mm	top	RAL	€
GARAGE106	5515	640	2000	Inox satinato	7035+7016	8374,96
GARAGE107	5515	640	2000	Acciaio gommato	7035+7016	8348,30



CONFIGURE

ART.	L mm	P mm	H mm	top	RAL	€
GARAGE094	1940	640	2000	Inox satinato	7035+7016	2553,47
GARAGE095	1940	640	2000	Acciaio gommato	7035+7016	2549,13

GARAGE

BEST SELLER



714
mm

1020

1428

1734

2040

CORNER

FLEXA



512
mm

1023

1020

1427

2040



CONFIGURE

ART.	L mm	P mm	H mm	top	RAL	€
GARAGE096	1940	640	2000	Inox satinato	7035+7016	2698,86
GARAGE097	1940	640	2000	Acciaio gommato	7035+7016	2694,52



RAL 7035 + RAL 7016

GARAGE

BEST SELLER



714
mm

1020

1428

1734

2040

CORNER

FLEXA



512
mm

1023

1020

1427

2040



[CONFIGURE](#)

ART.	L mm	P mm	H mm	top	RAL	€
GARAGE110	5712	640	2000	Inox satinato	7035+7016	8012,57
GARAGE111	5712	640	2000	Acciaio gommato	7035+7016	7995,21



[CONFIGURE](#)

ART.	L mm	P mm	H mm	top	RAL	€
GARAGE092	2142	640	2000	Inox satinato	7035+7016	3445,65
GARAGE093	2142	640	2000	Acciaio gommato	7035+7016	3394,50

GARAGE

BEST SELLER



714
mm

1020

1428

1734

2040

CORNER

FLEXA



512
mm

1023

1020

1427

2040



CONFIGURE

ART.	L mm	P mm	H mm	top	RAL	€
GARAGE098	1428	640	2000	Inox satinato	7035+7016	2059,33
GARAGE099	1428	640	2000	Acciaio gommato	7035+7016	2054,99



RAL 7035 + RAL 7016

GARAGE

BEST SELLER



714
mm

1020

1428

1734

2040

CORNER

FLEXA



512
mm

1023

1020

1427

2040



[CONFIGURE](#)

ART.	L mm	P mm	H mm	top	RAL	€
GARAGE108	5508	640	2000	Inox satinato	7035+7016	7823,16
GARAGE109	5508	640	2000	Acciaio gommato	7035+7016	7796,50



[CONFIGURE](#)

ART.	L mm	P mm	H mm	top	RAL	€
GARAGE100	2041	640	2000	Inox satinato	7035+7016	2318,80
GARAGE101	2041	640	2000	Acciaio gommato	7035+7016	2324,07

GARAGE

BEST SELLER



714
mm

1020

1428

1734

2040

CORNER

FLEXA



512
mm

1023

1020

1427

2040



CONFIGURE

ART.	L mm	P mm	H mm	top	RAL	€
GARAGE102	2041	640	2000	Inox satinato	7035+7016	2597,18
GARAGE103	2041	640	2000	Acciaio gommato	7035+7016	2602,45



RAL 7035 + RAL 7016





GARAGE

BEST SELLER



714
mm

1020

1428

1734

2040

CORNER

FLEXA



512
mm

1023

1020

1427

2040



3D

MODULO - DIM. (mm): L=714 P=640 H=2000

ART.	top	RAL	€
GARAGE001	Inox satinato	7035+7016	1516,21
GARAGE002	Acciaio gommato	7035+7016	1469,40



3D

MODULO - DIM. (mm): L=714 P=640 H=2000

ART.	top	RAL	€
GARAGE003	Inox satinato	7035+7016	1242,79
GARAGE004	Acciaio gommato	7035+7016	1195,98



3D

MODULO - DIM. (mm): L=714 P=640 H=2000

ART.	top	RAL	€
GARAGE005	Inox satinato	7035+7016	1328,66
GARAGE006	Acciaio gommato	7035+7016	1281,85



3D

MODULO - DIM. (mm): L=714 P=640 H=2000

ART.	RAL	€
GARAGE007	7035+7016	1636,49



3D

MODULO - DIM. (mm): L=714 P=640 H=2000

ART.	top	RAL	€
GARAGE008	Inox satinato	7035+7016	1435,61
GARAGE009	Acciaio gommato	7035+7016	1388,80



3D

MODULO - DIM. (mm): L=714 P=640 H=2000

ART.	top	RAL	€
GARAGE010	Inox satinato	7035+7016	1388,18
GARAGE011	Acciaio gommato	7035+7016	1341,37

GARAGE

BEST SELLER



714
mm

1020

1428

1734

2040

CORNER
FLEXA



512
mm

1023

1020

1427

2040



3D

MODULO - DIM. (mm): L=1020 P=640 H=2000

ART.	top	RAL	€
GARAGE012	Inox satinato	7035+7016	1662,53
GARAGE013	Acciaio gommato	7035+7016	1669,66



3D

MODULO - DIM. (mm): L=1020 P=640 H=2000

ART.	top	RAL	€
GARAGE014	Inox satinato	7035+7016	1606,42
GARAGE015	Acciaio gommato	7035+7016	1613,55



3D

MODULO - DIM. (mm): L=1020 P=640 H=2000

ART.	top	RAL	€
GARAGE016	Inox satinato	7035+7016	1349,74
GARAGE017	Acciaio gommato	7035+7016	1356,87



3D

MODULO - DIM. (mm): L=1020 P=640 H=2000

ART.	top	RAL	€
GARAGE018	Inox satinato	7035+7016	1444,91
GARAGE019	Acciaio gommato	7035+7016	1452,04



3D

MODULO - DIM. (mm): L=1020 P=640 H=2000

ART.	top	RAL	€
GARAGE020	Inox satinato	7035+7016	1528,30
GARAGE021	Acciaio gommato	7035+7016	1535,43



3D

MODULO - DIM. (mm): L=1020 P=640 H=2000

ART.	top	RAL	€
GARAGE022	Inox satinato	7035+7016	1586,27
GARAGE023	Acciaio gommato	7035+7016	1593,40

GARAGE

BEST SELLER



714
mm

1020

1428

1734

2040

CORNER

FLEXA



512
mm

1023

1020

1427

2040



3D

MODULO - DIM. (mm): L=1428 P=640 H=2000

ART.	top	RAL	€
GARAGE024	Inox satinato	7035+7016	2057,47
GARAGE025	Acciaio gommato	7035+7016	2053,13



3D

MODULO - DIM. (mm): L=1428 P=640 H=2000

ART.	top	RAL	€
GARAGE026	Inox satinato	7035+7016	2471,01
GARAGE027	Acciaio gommato	7035+7016	2466,67



3D

MODULO - DIM. (mm): L=1428 P=640 H=2000

ART.	top	RAL	€
GARAGE028	Inox satinato	7035+7016	2202,86
GARAGE029	Acciaio gommato	7035+7016	2198,52



3D

MODULO - DIM. (mm): L=1428 P=640 H=2000

ART.	top	RAL	€
GARAGE030	Inox satinato	7035+7016	1646,10
GARAGE031	Acciaio gommato	7035+7016	1641,76



3D

MODULO - DIM. (mm): L=1428 P=640 H=2000

ART.	top	RAL	€
GARAGE032	Inox satinato	7035+7016	1781,88
GARAGE033	Acciaio gommato	7035+7016	1777,54



3D

MODULO - DIM. (mm): L=1428 P=640 H=2000

ART.	top	RAL	€
GARAGE034	Inox satinato	7035+7016	2143,34
GARAGE035	Acciaio gommato	7035+7016	2139,00

GARAGE

BEST SELLER



714
mm

1020

1428

1734

2040

CORNER

FLEXA



512
mm

1023

1020

1427

2040

3D



MODULO - DIM. (mm): L=1734 P=640 H=2000

ART.	top	RAL	€
GARAGE036	Inox satinato	7035+7016	3150,84
GARAGE037	Acciaio gommato	7035+7016	3137,51

3D



MODULO - DIM. (mm): L=1734 P=640 H=2000

ART.	top	RAL	€
GARAGE038	Inox satinato	7035+7016	3200,44

3D



MODULO - DIM. (mm): L=1734 P=640 H=2000

ART.	top	RAL	€
GARAGE039	Inox satinato	7035+7016	2882,69
GARAGE040	Acciaio gommato	7035+7016	2869,36

3D



MODULO - DIM. (mm): L=1734 P=640 H=2000

ART.	top	RAL	€
GARAGE041	Inox satinato	7035+7016	2793,10
GARAGE042	Acciaio gommato	7035+7016	2779,77

3D



MODULO - DIM. (mm): L=1734 P=640 H=2000

ART.	top	RAL	€
GARAGE043	Inox satinato	7035+7016	2934,46
GARAGE044	Acciaio gommato	7035+7016	2921,13

3D



MODULO - DIM. (mm): L=1734 P=640 H=2000

ART.	top	RAL	€
GARAGE045	Inox satinato	7035+7016	2823,17
GARAGE046	Acciaio gommato	7035+7016	2809,84

GARAGE

BEST SELLER



714
mm

1020

1428

1734

2040

CORNER

FLEXA



512
mm

1023

1020

1427

2040



3D

MODULO - DIM. (mm): L=2040 P=640 H=2000

ART.	top	RAL	€
GARAGE047	Inox satinato	7035+7016	2903,15
GARAGE048	Acciaio gommato	7035+7016	2908,42



3D

MODULO - DIM. (mm): L=2040 P=640 H=2000

ART.	top	RAL	€
GARAGE049	Inox satinato	7035+7016	3597,55
GARAGE050	Acciaio gommato	7035+7016	3602,82



3D

MODULO - DIM. (mm): L=2040 P=640 H=2000

ART.	top	RAL	€
GARAGE051	Inox satinato	7035+7016	2998,32
GARAGE052	Acciaio gommato	7035+7016	3003,59



3D

MODULO - DIM. (mm): L=2040 P=640 H=2000

ART.	top	RAL	€
GARAGE053	Inox satinato	7035+7016	2557,81
GARAGE054	Acciaio gommato	7035+7016	2563,08



3D

MODULO - DIM. (mm): L=2040 P=640 H=2000

ART.	top	RAL	€
GARAGE055	Inox satinato	7035+7016	2746,29
GARAGE056	Acciaio gommato	7035+7016	2751,56



3D

MODULO - DIM. (mm): L=2040 P=640 H=2000

ART.	top	RAL	€
GARAGE057	Inox satinato	7035+7016	3346,14
GARAGE058	Acciaio gommato	7035+7016	3351,41

GARAGE

BEST SELLER



714
mm

1020

1428

1734

2040

CORNER

FLEXA



512
mm

1023

1020

1427

2040



3D

MODULO - DIM. (mm): L=2040 P=640 H=2000

ART.	top	RAL	€
GARAGE059	Inox satinato	7035+7016	2004,46
GARAGE060	Acciaio gommato	7035+7016	2009,73



3D

MODULO - DIM. (mm): L=2040 P=640 H=2000

ART.	top	RAL	€
GARAGE061	Inox satinato	7035+7016	2590,36
GARAGE062	Acciaio gommato	7035+7016	2595,63



3D

MODULO - DIM. (mm): L=2040 P=640 H=2000

ART.	top	RAL	€
GARAGE063	Inox satinato	7035+7016	3123,25
GARAGE064	Acciaio gommato	7035+7016	3128,52

Courtesy of Trident Motorsport



GARAGE

BEST SELLER



714
mm

1020

1428

1734

2040

CORNER

FLEXA



512
mm

1023

1020

1427

2040



3D

MODULO - DIM. (mm): L=754 P=754 H=2000

ART.	top	RAL	€
GARAGE112	Inox satinato	7035+7016	1087,48
GARAGE113	Acciaio gommato	7035+7016	1094,61



3D

MODULO - DIM. (mm): L=714 P=754 H=2000

ART.	top	RAL	€
GARAGE114	Inox satinato	7035+7016	952,94
GARAGE115	Acciaio gommato	7035+7016	960,07

BEST SELLER



714
mm

1020

1428

1734

2040

CORNER

FLEXA



512
mm

1023

1020

1427

2040



3D

MODULO - DIM. (mm): L=583 P=600 H=921

ART.	RAL	€
GARAGE116	7035+7016	746,48



GARAGE

BEST SELLER



714 mm

1020

1428

1734

2040

CORNER

FLEXA



512 mm

1023

1020

1427

2040

ARMADIO CON PORTA A BATTENTE

Coppia tamponi per armadio



3D

PERFOM - DIM. (mm): L=512 P=640 H=2000



ART.	RAL	€
GARAGE065	7035+7016	496,00



3D

PERFOM - DIM. (mm): L=512 P=640 H=2000



ART.	RAL	€
GARAGE066	7035+7016	650,07



vedi pag. 492

ARMADIO CON PORTE A BATTENTE

BEST SELLER



714 mm

1020

1428

1734

2040

CORNER

FLEXA



512 mm

1023

1020

1427

2040



3D

PERFOM - DIM. (mm): L=1023 P=640 H=2000



ART.	RAL	€
GARAGE068	7035+7016	587,76



3D

PERFOM - DIM. (mm): L=1023 P=640 H=2000



ART.	RAL	€
GARAGE069	7035+7016	822,12



3D

PERFOM - DIM. (mm): L=1023 P=640 H=2000



ART.	RAL	€
GARAGE072	7035+7016	721,68



3D

PERFOM - DIM. (mm): L=1023 P=640 H=2000



ART.	RAL	€
GARAGE073	7035+7016	956,04



GARAGE

BEST SELLER



714
mm

1020

1428

1734

2040

CORNER

FLEXA



512
mm

1023

1020

1427

2040

ARMADIO CON PORTE SCORREVOLI

Coppia montanti



3D

PERFOM - DIM. (mm): L=1020 P=640 H=2000



ART.	RAL	€
GARAGE074	7035+7016	968,75



3D

PERFOM - DIM. (mm): L=1020 P=640 H=2000



ART.	RAL	€
GARAGE076	7035+7016	1168,39

BEST SELLER



714
mm

1020

1428

1734

2040

CORNER

FLEXA



512
mm

1023

1020

1427

2040



3D

PERFOM - DIM. (mm): L=1427 P=640 H=2000



ART.	RAL	€
GARAGE077	7035+7016	1235,04



3D

PERFOM - DIM. (mm): L=1427 P=640 H=2000



ART.	RAL	€
GARAGE079	7035+7016	1558,68

GARAGE

BEST SELLER



714
mm

1020

1428

1734

2040

CORNER

FLEXA



512
mm

1023

1020

1427

2040

ARMADIO CON PORTE SCORREVOLI

Coppia montanti



3D

PERFOM - DIM. (mm): L=2040 P=640 H=2000



ART.	RAL	€
GARAGE080	7035+7016	1604,25



3D

PERFOM - DIM. (mm): L=2040 P=640 H=2000



ART.	RAL	€
GARAGE082	7035+7016	2034,22

ACCESSORI



ARROTOLATORE ELETTRICO CON PRESA SCHUKO



ART.	L cavo m	tipo presa	Volt	Watt	€
MBR13S0V0V00100	20	Schuko	230	1600	578,46



ARROTOLATORE PER ARIA COMPRESSA



ART.	L cavo m	pressione max Mpa	Ø mm	€
MBR13S0V0V00200	14	1,5	10	265,67



RULLO PER ARROTOLATORE



ART.	€
MBR13S0V0V00339	30,07



PIASTRA PER ARROTOLATORE

Da fissare alla parte posteriore dell'armadio



ART.	€
MBR13S0V0V00499	21,39

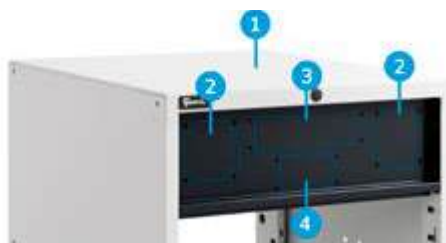

1. Armadio tecnico L=560 mm predisposto per porta
2. Modulo: Rullo per arrotolatore



3. Modulo: Multipresa a 4 scomparti
4. Modulo: Multipresa a 2 scomparti

GARAGE

BEST SELLER



714
mm

1020

1428

1734

2040

CORNER

FLEXA



512
mm

1023

1020

1427

2040

MATERIALE DI SEPARAZIONE

36X27 EH L= 717 mm



ART.	adatto per cassetto H mm	componenti	€
FFH10051000	50/300	3 x Divisorio a 3 canali 9 x Divisorio a 4 canali 12 x Divisorio trasversale L=47 mm 36 x Divisorio trasversale L=36 mm	31,93



ART.	adatto per cassetto H mm	componenti	€
FFH10051300	50/300	18 x Divisorio trasversale L=47 mm 12 x Divisorio trasversale L=73 mm 6 x Divisorio a 2 canali 6 x Divisorio a 3 canali	28,83



ART.	adatto per cassetto H mm	componenti	€
FFH10051500	50/300	20 x Divisorio trasversale L=36 mm 20 x Divisorio trasversale L=47 mm 6 x Divisorio a 3 canali 5 x Divisorio a 4 canali 1 x Porta chiavi a brugola	31,93



ART.	adatto per cassetto H mm	componenti	€
FFH10071800	75	16 x Cassetta divisorio 75x75 mm 8 x Cassetta divisorio 150x75 mm 4 x Cassetta divisorio 150x150 mm	32,55



ART.	adatto per cassetto H mm	componenti	€
FFH10071600	75	12 x Cassetta divisorio 150x75 mm	29,76
FFH10101600	100/125	6 x Cassetta divisorio 150x150 mm	34,72



ART.	adatto per cassetto H mm	componenti	€
FFH10070500	75		16,43
FFH10100500	100/125	2 x Divisorio longitudinale fessurato L=457 mm	17,05
FFH10150500	150/175	3 x Divisorio trasversale L=202 mm	22,63
FFH10200500	200/250		32,24



GARAGE

BEST SELLER



714
mm

1020

1428

1734

2040

CORNER

FLEXA



512
mm

1023

1020

1427

2040

MATERIALE DI SEPARAZIONE

54X27 EH L= 1023 mm



ART.	adatto per cassetto H mm	componenti	€
FFH40051200	50/300	15 x Divisorio trasversale L=36 mm 10 x Divisorio trasversale L=47 mm 6 x Divisorio trasversale L=73 mm 6 x Divisorio a 2 canali 6 x Divisorio a 3 canali 6 x Divisorio a 4 canali	39,68



ART.	adatto per cassetto H mm	componenti	€
FFH40051500	50/300	30 x Divisorio trasversale L=36 mm 10 x Divisorio trasversale L=47 mm 6 x Divisorio a 3 canali 12 x Divisorio a 4 canali	42,16



ART.	adatto per cassetto H mm	componenti	€
FFH40071100	75	18 x Cassetta divisorio 150x150 mm	42,47
FFH40101100	100/125		48,05



ART.	adatto per cassetto H mm	componenti	€
FFH40071300	75	12 x Cassetta divisorio 150x75 mm 12 x Cassetta divisorio 150x150 mm	44,33
FFH40101300	100/125		51,15



ART.	adatto per cassetto H mm	componenti	€
FFH40071600	75	20 x Cassetta divisorio 75x75 mm 14 x Cassetta divisorio 150x75 mm 6 x Cassetta divisorio 150x150 mm	48,98



ART.	adatto per cassetto H mm	componenti	€
FFH40070500	75	4 x Divisorio longitudinale fessurato L=457 mm 2 x Divisorio trasversale L=151 mm 3 x Divisorio trasversale L=202 mm	24,18
FFH40100500	100/125		29,45
FFH40150500	150/175		40,61
FFH40200500	200/250		59,52







Courtesy of Cecchini Racing Team

CONDIZIONI GENERALI DI GARANZIA

Gentile Cliente,

ogni acquisto di prodotti di Fami S.r.l. è accompagnato da una garanzia convenzionale (la "Garanzia"), disciplinata in conformità alle modalità ed ai termini qui di seguito indicati.

1. PREMESSE:

Nelle Condizioni che seguono, i termini sotto indicati avranno il seguente significato:

a) Venditore: Fami S.r.l.

b) Acquirente: qualunque soggetto (persona fisica, società, ente, entità giuridica) che acquisti i Prodotti del Venditore;

c) Prodotto/i: i beni fabbricati, assemblati e/o commercializzati dal Venditore, esclusi i Prodotti a marchio Store Van;

2. OGGETTO DELLA GARANZIA

2.1 Fami S.r.l. garantisce che i Prodotti sono esenti da vizi e conformi alle specifiche tecniche dichiarate dal Venditore.

2.2 Resta inteso che le dimensioni dei Prodotti sono da intendersi tenendo conto dei margini di tolleranza d'uso nel commercio con riferimento al tipo, quantità, qualità dei Prodotti. Il Venditore, pertanto, non garantisce la rispondenza dei Prodotti a particolari specifiche o caratteristiche tecniche o la loro idoneità ad usi particolari diversi rispetto a quelle indicate nelle specifiche tecniche dichiarate da Fami S.r.l. e previste nel manuale d'uso e manutenzione, se non nella misura in cui tali caratteristiche siano state espressamente convenute nel contratto di vendita.

2.3 Qualora venga segnalata dal Cliente ed accertata la presenza di difetti sui Prodotti, il Cliente avrà diritto alla loro riparazione gratuita ovvero, qualora la riparazione risulti impossibile o eccessivamente onerosa, alla sostituzione gratuita del Prodotto, ad insindacabile giudizio del Venditore, con esclusione di ogni ulteriore e diversa obbligazione in capo a Fami S.r.l.

2.4 La Garanzia non pregiudica, e rimangono quindi salvi, i diritti previsti nel Decreto Legislativo 6.9.2005 n. 206 e successive modifiche ed integrazioni (il "Codice del Consumo"), nel caso in cui il Cliente sia qualificabile come "consumatore".

3. CONDIZIONI DI OPERATIVITÀ DELLA GARANZIA

3.1 Ai fini dell'attivazione della Garanzia, il Cliente avrà l'onere di informare Fami S.r.l., nei limiti temporali di cui agli articoli 4 e 5 che seguono, della scoperta di difetti tramite una segnalazione (la "Segnalazione") avente i contenuti indicati nel seguente articolo 5.

3.2 Il Cliente, fatta la Segnalazione, dovrà interrompere immediatamente l'utilizzo del/i Prodotto/i difettoso/i.

3.3 A seguito della ricezione della Segnalazione, il Venditore porrà in essere quanto necessario per accertare l'esistenza, la natura e la consistenza dei difetti e per verificare la tempestività della Segnalazione ai sensi del seguente articolo 5. A tali scopi il Cliente sarà tenuto a rendere disponibile/i il Prodotto/i difettoso/i per la loro ispezione anche tramite l'invio di documentazione fotografica ovvero l'utilizzo di sistemi di videoconferenza. Il Prodotto verrà riparato dal Venditore presso la propria sede, la propria filiale, o presso un proprio rivenditore autorizzato. Il Venditore si riserva la facoltà di riparare il Prodotto presso il Cliente. Qualora sia necessario, il Cliente dovrà provvedere ad inviare a proprie spese il Prodotto difettoso presso uno dei predetti luoghi, così come indicato dal Venditore, fatte salve le norme del Codice del Consumo. Il Venditore trasmetterà al Cliente il nuovo Prodotto o il Prodotto riparato, sostenendo i costi di spedizione.

3.4 La riparazione di un Prodotto difettoso sarà effettuata in tempi congrui rispetto all'entità del difetto.

4. DURATA – PERIODO DI COPERTURA

4.1 La durata della Garanzia per i Prodotti è di 10 anni che decorre dalla data di consegna dei Prodotti, salvo che si tratti di Prodotti commercializzati, componenti elettronici, software e le parti di usura, per i quali viene prevista una garanzia di 12 mesi che decorre, sempre, dalla data di consegna degli stessi. Si precisa che per "data di consegna" si intende la data in cui i Prodotti hanno lasciato i magazzini di Fami S.r.l. per essere consegnati al Cliente, salva diversa previsione nel contratto di vendita.

4.2 Per i Prodotti riparati o sostituiti, la garanzia decorre nuovamente ed ha una durata di 12 mesi dalla riparazione oppure dalla sostituzione. Complessivamente, pertanto, la durata della Garanzia per i Prodotti riparati o sostituiti dal Venditore è di massimo 11 anni ovvero, per i Prodotti commercializzati, componenti elettronici, software e le parti di usura, di massimo 24 mesi dall'inizio della durata della Garanzia di cui al precedente articolo 4.1.

4.3 Alla scadenza del termine di cui al precedente articolo 4.1, il diritto di regresso previsto dall'art. 131 del Codice del Consumo, qualora esso sia applicabile, dovrà intendersi come prescritto ed inammissibile.

5. TEMPI E MODI DELLA SEGNALAZIONE

5.1 Durante il periodo di vigenza della Garanzia, eventuali reclami relativi allo stato dell'imballo, quantità, numero o alle caratteristiche esteriori dei Prodotti (vizi e difetti non occulti e visibili dall'esterno), dovranno essere annotati dal Cliente sulla bolla di consegna, firmando il D.D.T. indicando la dicitura "riserva specifica". Entro e non oltre 2 (due) giorni lavorativi dalla data di ricevimento dei Prodotti, il Cliente dovrà inviare al Venditore, tramite messaggio di posta elettronica al seguente indirizzo assistance@famisp.it, copia della bolla di consegna e relativo rilievo fotografico, fornendo informazioni dettagliate sulle condizioni dei Prodotti e sulla natura dei difetti rilevati.

5.2 Eventuali reclami relativi a difetti non individuabili mediante un diligente controllo al momento del ricevimento (vizi occulti) dovranno essere notificati al Venditore, a pena di decadenza, entro e non oltre 7 (sette) giorni dalla data della scoperta del difetto, tramite messaggio di posta elettronica certificata al seguente indirizzo pec@pec.famisp.it, specificando con precisione il codice prodotto, il lotto (se disponibile), la data di consegna e la natura del difetto.

6. ESCLUSIONI E LIMITAZIONE DELLA RESPONSABILITÀ

6.1 La garanzia non opera con riferimento a Prodotti i cui difetti sono dovuti a: a) operazioni di trasporto; b) mancato rispetto di accorgimenti rientranti nell'ordinaria prassi di manutenzione; negligenza e trascuratezza nell'uso; c) mancata osservanza delle istruzioni fornite dal Venditore per l'utilizzo e/o lo stoccaggio del Prodotto; d) mancato rispetto delle norme d'installazione e/o di ogni altra indicazione o istruzione riportata sulle note tecniche a corredo del Prodotto qualora l'installazione non sia stata curata direttamente dal Venditore; e) manomissioni, manutenzioni in genere, interventi operati al Cliente o da personale non autorizzato dal Venditore; f) uso anomalo e/o improprio del Prodotto, collocazione dello stesso in locali umidi, eccessivamente caldi o freddi, polverosi o aggressivi (presenza di cloro, lacche, vernici o altri agenti chimici e/o tossici) o comunque in locali non idonei alla corretta conservazione dei Prodotti nei limiti in cui tali circostanze non siano state documentate al Venditore prima dell'acquisto dei Prodotti ed il Venditore abbia garantito la tollerabilità dei Prodotti a tali ambienti; g) aggravio dei danni causato dall'utilizzo dei Prodotti da parte del Cliente una volta che si siano manifestati i difetti; h) utilizzo di parti di ricambio, componenti ed accessori non originali o non consigliati dal Venditore (non può essere richiesta la sostituzione o la riparazione di pezzi non originali) e danni provocati al Prodotto dall'uso degli stessi; i) anomalie o difettoso funzionamento dell'alimentazione elettrica; l) corrosioni, incrostazioni o rotture provocate da correnti vaganti, condense, aggressività o acidità dell'acqua, trattamenti disincrostanti effettuati impropriamente, depositi di fanghi o calcare; m) caso fortuito, cause di forza maggiore quali, a titolo esemplificativo e non esaustivo, gelo, surriscaldamento, incendio, furto, eventi naturali (come ad esempio, grandine, trombe d'aria, fulmini, inondazioni, terremoti), atti vandalici, incidenti e altri simili avvenimenti.

6.2 La Garanzia non opera se il prezzo di vendita dei Prodotti non è stato interamente saldato, con la precisazione che qualora il pagamento sia previsto in più scadenze, la Garanzia sarà da subito operativa e rimarrà tale fino a quando le scadenze di pagamento resteranno tempestivamente onorate.

6.3 Il Venditore non è responsabile per eventuali danni che possano, direttamente o indirettamente, derivare a persone, cose o animali, in conseguenza della mancata osservanza di tutte le prescrizioni indicate nel libretto di installazione, uso e manutenzione.

6.4 Il Venditore declina ogni responsabilità relativa a danni indiretti causati dalla difettosità di un Prodotto come, a titolo puramente indicativo ma non esaustivo, il fermo di produzione ovvero la mancata spedizione o cessione a terzi del Prodotto.

6.5 In ogni caso, la responsabilità del Venditore non potrà comunque eccedere il prezzo pagato dal Cliente per il singolo contratto di vendita dal cui contenuto è derivata la fattispecie inerente all'eventuale richiesta di danno e/o risarcimento.

6.6 I Prodotti dovranno essere utilizzati solo ed esclusivamente per gli scopi indicati e nel rispetto delle normative sulla sicurezza, conformemente alle previsioni del manuale di installazione, uso e manutenzione fornito dal Venditore; nel caso in cui il Cliente dovesse utilizzare o rivendere i Prodotti acquistati e/o Prodotti dal Venditore per scopi diversi, lo fa a proprio esclusivo rischio e pericolo, con ogni conseguente responsabilità. In tal caso, è esclusa la responsabilità contrattuale e/o extracontrattuale del Venditore per eventuali danni diretti ed indiretti subiti anche da terzi, nonché in caso di cattiva manutenzione, utilizzo improprio, non osservanza di norme di sicurezza ed altre ipotesi e il Cliente dovrà tenere il Venditore indenne da costi e/o responsabilità che potrebbero derivare a suo carico.

7. FORO COMPETENTE E LEGGE APPLICABILE

7.1 Per qualunque controversia derivante o connessa alle presenti Condizioni Generali di Garanzia quali, a titolo meramente esemplificativo e non esaustivo, controversie relative alla loro esistenza, validità, interpretazione, efficacia, esecuzione, è competente a decidere in via esclusiva il Tribunale di Vicenza, anche qualora il Contratto presenti elementi di internazionalità, fatte salve le norme inderogabili del Codice del Consumo.

7.2 Le presenti Condizioni Generali di Garanzia sono interamente soggette alla legge italiana e interpretati secondo la stessa, anche qualora il Contratto presenti elementi di internazionalità, con espressa esclusione della Convenzione di Vienna del 1980.

CONDIZIONI GENERALI DI VENDITA

1. DEFINIZIONI

1.1 Nel contesto delle presenti Condizioni, i termini di seguito indicati avranno il seguente significato:

- a) Venditore: Fami S.r.l.
- b) Acquirente: qualunque società, ente, entità giuridica che acquisti i Prodotti del Venditore;
- c) Prodotti: i beni fabbricati, assemblati e/o commercializzati dal Venditore;
- d) Ordine: ciascuna proposta di acquisto dei Prodotti inoltrata dall'Acquirente al Venditore;
- e) Conferma d'Ordine: l'accettazione scritta dell'Ordine da parte del Venditore;
- f) Contratto: la vendita conclusa tra il Venditore e l'Acquirente a seguito del ricevimento da parte dell'Acquirente della Conferma d'Ordine.
- g) Parti: il Venditore e l'Acquirente congiuntamente;
- h) Marchi: tutti i marchi di cui il Venditore è proprietario o licenziatario;
- i) Diritti di Proprietà Intellettuale: tutti i diritti di proprietà intellettuale e/o industriale di Fami S.r.l., ivi inclusi, senza limitazione alcuna, i diritti relativi a: brevetti per invenzioni, disegni o modelli, modelli di utilità, Marchi, know-how, specifiche tecniche, dati, software, indipendentemente dalla registrazione o meno di tali diritti, nonché qualsivoglia domanda o registrazione relativa a tali diritti ed ad ogni altro diritto o forma di protezione di natura simile o avente effetto equivalente.

2. DISPOSIZIONI GENERALI

- 2.1 Le presenti Condizioni Generali di Vendita (di seguito, le "Condizioni") formano parte integrante dei Contratti conclusi tra il Venditore e l'Acquirente per la fornitura dei Prodotti.
- 2.2 Le Condizioni si applicano tra Fami S.r.l. (di seguito, "Fami") e l'Acquirente senza la necessità che vi sia un espresso richiamo alle stesse o uno specifico accordo in tal senso. Qualsiasi condizione o termine differente trova applicazione soltanto se confermato per iscritto da parte del Venditore.
- 2.3 Il Venditore si riserva il diritto di modificare, integrare o eliminare qualsiasi previsione delle presenti Condizioni Generali di Vendita, in qualsiasi momento, dandone notizia anche tramite la pagina a ciò dedicata del sito aziendale, restando inteso che tali aggiunte, modifiche o cancellazioni si applicheranno a tutte le Vendite concluse a partire dal 15° giorno successivo alla comunicazione (tramite pubblicazione sul sito web oppure tramite invio di newsletter o qualsivoglia corrispondenza inviata per iscritto) all'Acquirente delle nuove Condizioni di Vendita.
- 2.4 Qualsiasi riferimento a termini commerciali (come EXW, DPA, DPU, DDP, etc.) è da intendersi come richiamo agli Incoterms® della Camera di Commercio Internazionale, nel testo in vigore alla data di stipulazione del Contratto.

3. AMBITO DI APPLICAZIONE

- 3.1 Le presenti Condizioni Generali di Vendita (di seguito, le "Condizioni") si applicano a tutti i Contratti (siano essi conclusi telefonicamente, a mezzo telefax, e-mail o sito internet), ove non espressamente derogate per iscritto dalle Parti e formano parte integrante e sostanziale di ogni Ordine, Conferma d'Ordine, anche se non espressamente citate.
- 3.2 L'Acquirente non può invocare né eccepire condizioni diverse dalle presenti Condizioni. Pertanto, non hanno alcuna validità le eventuali condizioni precisate per iscritto dall'Acquirente sull'Ordine, ovvero in qualsiasi altra fase della trattativa contrattuale nonché successivamente alla Conferma d'Ordine, così come le eventuali condizioni generali di acquisto dell'Acquirente stesso. Qualsiasi condizione scritta o verbale inviata da parte di collaboratori, dipendenti, agenti o rappresentanti del Venditore è priva di valore se non riprodotta nel testo della Conferma d'Ordine o se non confermata per iscritto dal Venditore. In tal senso, l'esecuzione, anche parziale, dell'Ordine da parte di Fami od ogni altro suo adempimento nei confronti dell'Acquirente non valgono e non possono essere interpretati come tacita o implicita accettazione di qualsivoglia condizione generale di contratto che non sia stata espressamente sottoscritta da Fami.
- 3.3 Le Condizioni sono valide esclusivamente per rapporti contrattuali tra Fami e operatori professionali, per cui non troverà alcuna applicazione il D.Lgs. 6 settembre 2005, n. 206 (Codice del Consumo) e successive modifiche.

4. OFFERTE E ORDINI

- 4.1 Le offerte del Venditore non sono da considerarsi vincolanti. Le indicazioni riportate su cataloghi, prospetti e listini non impegnano il Venditore, che si riserva la facoltà di apportare qualsiasi modifica ai Prodotti ed ai relativi prezzi; pertanto, il Venditore si considera vincolato esclusivamente da quanto riportato nella Conferma d'Ordine.
- 4.2 Ciascun Ordine inviato dall'Acquirente, sia direttamente a Fami sia per il tramite degli agenti o dei rappresentanti del Venditore, è da intendersi come una proposta irrevocabile d'acquisto, destinata a rimanere efficace per 30 (trenta) giorni, decorrenti dalla data della sua regolare ricezione da parte del Venditore, salvo esplicita deroga indicata di volta in volta.
- 4.3 L'invio dell'Ordine da parte dell'Acquirente implica l'integrale presa visione e la conoscenza da parte dello stesso di tutte le presenti Condizioni, le quali dovranno quindi intendersi integralmente accettate dall'Acquirente senza limitazioni e riserve.
- 4.4 Gli Ordini e/o le eventuali modifiche degli Ordini effettuati verbalmente o telefonicamente devono essere confermati per iscritto da parte dell'Acquirente. In caso contrario, il Venditore non si assume alcuna responsabilità con riguardo ad eventuali errori o possibili fraintendimenti.
- 4.5 Il Venditore si riserva espressamente di valutare ogni Ordine, non essendo vincolato alla loro accettazione.
- 4.6 Gli Ordini regolarmente accettati dal Venditore mediante Conferma d'Ordine non potranno essere annullati dal Compratore senza il consenso scritto del Venditore.

5. CONCLUSIONE DEL CONTRATTO

- 5.1 Il Contratto potrà dirsi concluso solo a seguito dell'invio di una Conferma d'Ordine da parte di Fami (via e-mail, telefax o altri mezzi telematici equipollenti), con riferimento ad ogni singolo Ordine. In ogni caso, l'emissione della fattura da parte del Venditore oppure l'esecuzione dell'Ordine da parte del Venditore sarà considerata quale conferma.
- 5.2 Qualora la Conferma d'Ordine contenga aggiunte, limitazioni o altre variazioni rispetto all'Ordine, l'assenso dell'Acquirente a tali variazioni si intenderà tacitamente prestato salvo contestazione scritta da far pervenire per iscritto al Venditore entro 2 giorni lavorativi dal ricevimento della stessa.
- 5.3 Modifiche e integrazioni richieste dall'Acquirente successivamente alla conclusione del Contratto non avranno valore ed efficacia se non accettate per iscritto da parte del Venditore, con l'eventuale precisazione dei nuovi termini di consegna, del prezzo e delle modalità di pagamento.
- 5.4 Tutti i Contratti si intendono sempre conclusi presso la sede legale di Fami S.r.l. in Italia, 36027 Rosà (Vi), Via Stazione Rossano n. 13

6. PREZZI

- 6.1. I prezzi dei Prodotti saranno quelli indicati nel listino prezzi del Venditore in vigore al momento della conclusione dell'Ordine o, qualora il Prodotto non sia inserito nel listino prezzi o il listino prezzi non sia disponibile, quelli indicati nella Conferma d'Ordine.
- 6.2 I prezzi dei Prodotti saranno quelli indicati nella Conferma d'Ordine e, salvo patto contrario, si intendono per merce resa franco fabbrica (EXW). Tali prezzi, fatta salva diversa indicazione nella Conferma d'Ordine, non comprendono i costi e le spese di imballaggi speciali, spedizione, assicurazione e trasporto dai locali del Venditore, ogni spesa, tassa o imposta inerente alla vendita dei Prodotti, inclusi i costi di tutte le formalità doganali (a titolo esemplificativo e non esaustivo: dazi, tasse ed altri oneri per l'esportazione dei Prodotti), che restano a carico dell'Acquirente.
- 6.3 Il Venditore si riserva il diritto di effettuare un adeguamento del prezzo nel caso di modifica (a) del Contratto, richiesto dall'Acquirente successivamente alla conclusione dello stesso ed accettato dal Venditore e (b) del tipo della fornitura, del materiale o dell'esecuzione dei Prodotti dovuti all'incompletezza ovvero alla non correttezza delle informazioni e/o della documentazione fornita dall'Acquirente.

7. TERMINI DI PAGAMENTO

- 7.1. Al momento della conclusione del contratto, il Venditore potrà richiedere all'Acquirente il versamento di una caparra confirmatoria pari al 30% del valore della fornitura. Le Parti in ogni caso possono pattuire il versamento di una caparra confirmatoria diversa previo accordo per iscritto nel Contratto.
- 7.2 In caso di mancato versamento della caparra confirmatoria, ove prevista, il Contratto si intende risolto ipso iure ed il Venditore potrà richiedere il pagamento delle somme sin a quel momento maturate, oltre al risarcimento di tutti i danni patrimoniali e non patrimoniali, nonché le spese, anche legali, eventualmente sostenute.
- 7.3 Ove nel Contratto non vengano precisate le condizioni di pagamento, esso dovrà essere effettuato a 30 gg. data fattura fine mese, mediante bonifico bancario. Il pagamento si considera effettuato quando la somma entra nella disponibilità del Venditore presso la sua Banca in Italia. Ove le Parti abbiano pattuito il pagamento anticipato senza ulteriori indicazioni, si presume che il pagamento anticipato si riferisca all'intero prezzo dei Prodotti inclusi nella fornitura. In caso di consegna ripartita in più soluzioni, l'acquirente dovrà, per ognuna di esse, versare l'importo corrispondente alla merce consegnata, salvo diverso accordo scritto previsto nel Contratto.
- 7.4 I pagamenti devono essere effettuati nella valuta concordata ed eventuali spese o commissioni bancarie dovute in relazione al pagamento saranno integralmente a carico dell'Acquirente.
- 7.5 In caso di mancato o ritardato pagamento, anche parziale, da parte dell'Acquirente, il Venditore, salvi tutti gli altri suoi diritti, avrà facoltà di sospendere le ulteriori consegne anche se queste fossero dovute in dipendenza di altri contratti e richiedere l'immediato ed integrale pagamento di tutto il materiale ordinato nonché di differire le proprie consegne per un termine pari al ritardo nei pagamenti, qualunque ne sia l'importo e ciò sino al saldo di tali pagamento e dei relativi interessi moratori.
- 7.6 Sui mancati e ritardati pagamenti il Venditore ha diritto al riconoscimento e al pagamento a suo favore degli interessi di mora ex D.Lgs. 231/2002, oltre alle spese, anche legali, che dovessero ritenersi necessarie per il recupero delle somme a qualsiasi titolo spettanti al Venditore.
- 7.7 Il mancato pagamento anche di una sola fattura comporterà per il Venditore il diritto di risolvere ogni Contratto in essere con l'Acquirente ai sensi dell'art. 1456 c.c. e di sospendere l'esecuzione o la consegna di ogni altra fornitura in corso di esecuzione, salvo in ogni caso il risarcimento integrale del danno conseguito dall'inadempimento o dal ritardo dell'Acquirente. Eventuali ritardi nell'esecuzione degli Ordini o nelle consegne causati da precedenti sospensioni della produzione per mancati pagamenti dell'Acquirente non costituiranno inadempimento del Venditore.
- 7.8 Qualsiasi reclamo o contestazione non darà diritto all'Acquirente di sospendere o ritardare i pagamenti.

8. TERMINI DI CONSEGNA

- 8.1. Il termine di consegna sarà quella indicata nella Conferma d'Ordine e, salvo patto contrario, si intende stabilita ex-works (EXW) presso lo stabilimento del Venditore. Se richiesto ed espressamente pattuito per iscritto nel Contratto, Fami si occuperà del trasporto dei Prodotti a rischio, costi e spese dell'Acquirente. Le eventuali spese di trasporto saranno a carico dell'Acquirente e ciò non inciderà in alcun modo sui rischi della spedizione che resteranno anche essi in capo all'Acquirente al più tardi con la consegna dei Prodotti al primo trasportatore.
- 8.2. La consegna dei Prodotti dovrà avvenire entro il termine indicato nel Contratto, computato in giorni lavorativi, precisato peraltro che i termini di consegna restano puramente indicativi e non sono termini essenziali e, in ogni caso, e, non includono i tempi di trasporto. Il Venditore, quindi, non risponderà del ritardo nella consegna per alcun motivo.
- 8.3. Qualora l'Acquirente richieda al Venditore una variazione del termine di consegna, dovrà effettuare la relativa richiesta per iscritto e procedere comunque al saldo della fornitura entro i termini indicati nell'articolo 7 delle presenti Condizioni. Restano esclusi i soli eventuali costi di custodia, consegna, montaggio, smontaggio e installazione, i quali dovranno essere saldati entro la nuova data di consegna pattuita.
- 8.4. Dal ricevimento dell'avviso di merce pronta l'Acquirente dovrà ritirare la merce nel termine massimo di 10 (dieci) giorni. In difetto, i Prodotti potranno essere stoccati all'aperto, con onere del Venditore da ogni responsabilità e decadenza, a beneficio di quest'ultima, di tutte le garanzie e con addebito all'Acquirente dei costi di movimentazione e magazzinaggio, nonché di ogni altra eventuale spesa, sostenuti dal Venditore, che altresì si riserva la facoltà di far depositare la merce a spese dell'Acquirente.
- 8.5 Entro 10 (dieci) giorni dall'avviso di merce pronta il Venditore avrà la facoltà di emettere regolare fattura.

8.6 In caso di ritardo nel ritiro della merce, comunque approntata, per una qualsiasi ragione non dipendente dalla volontà del Venditore, la consegna si intenderà comunque come eseguita decorsi dieci giorni dalla comunicazione dell'avviso di merce pronta. In tal caso il Venditore avrà il diritto di procedere alla fatturazione e di reclamare l'adempimento delle condizioni di pagamento pattuite e potrà far effettuare l'imballaggio, il trasporto o lo stoccaggio della merce a spese dell'Acquirente, salvo il risarcimento dei danni eventualmente patiti, anche per l'immagazzinamento, la custodia ed il deposito della merce.

9. GARANZIA E RECLAMI

9.1. La regolamentazione sulla Garanzia offerta dal Venditore è contenuta nel documento Condizioni Generali di Garanzia visionabile sul sito www.famispacom.com e, per quanto riguarda esclusivamente i Prodotti a marchio Store Van, nel documento Condizioni Generali di Garanzia visionabile sul sito www.storevan.com.

9.2 Al momento della presa in consegna dei Prodotti, l'Acquirente è tenuto ad esaminare i Prodotti alla presenza del trasportatore incaricato della consegna per verificare l'eventuale presenza di difetti visibili dall'esterno (a titolo esemplificativo e non esaustivo, le quantità e l'imballaggio dei Prodotti, la conformità dei Prodotti rispetto a quanto indicato nella Conferma d'Ordine).

9.3 Eventuali reclami relativi allo stato dell'imballo, quantità, numero o alle caratteristiche esteriori dei Prodotti (vizi e difetti non occulti e visibili dall'esterno), dovranno essere annotati dall'Acquirente sulla bolla di consegna, firmando il D.D.T. indicando la dicitura "riserva specifica". Entro e non oltre 2 (due) giorni lavorativi dalla data di ricevimento dei Prodotti, l'Acquirente dovrà inviare al Venditore, tramite messaggio di posta elettronica al seguente indirizzo assistance@famispacom.it, copia della bolla di consegna e relativo rilievo fotografico, fornendo informazioni dettagliate sulle condizioni dei Prodotti e sulla natura dei difetti rilevati.

9.4 Fatti salvi i termini di durata della Garanzia offerta dal Venditore, eventuali reclami relativi a difetti non individuabili mediante un diligente controllo al momento della presa in consegna dei Prodotti (vizi e difetti occulti) dovranno essere notificati al Venditore, a pena di decadenza, entro e non oltre 7 (sette) giorni dalla data della scoperta del difetto, tramite messaggio di posta elettronica certificata al seguente indirizzo pec@pec.famispacom.it, specificando il codice prodotto, il lotto (se disponibile), la data di consegna e la natura del difetto.

9.5 Qualsiasi Prodotto per il quale non sia stata sollevata alcuna contestazione conformemente alle procedure ed ai termini qui sopra indicati viene considerato approvato ed accettato dall'Acquirente.

9.6 In nessun caso agenti, clienti o intermediari del Venditore hanno il potere di rappresentare ed impegnare quest'ultima nei confronti dell'Acquirente o di altre terze parti. A tal fine ogni comunicazione relativa a vizi e difetti dei Prodotti sarà invalida ed inefficace qualora sia stata fatta ad agenti, clienti o intermediari del Venditore, ovvero in forme o modalità diverse da quelle sopraindicate.

10. RISERVA DI PROPRIETÀ

10.1 I Prodotti rimangono di proprietà del Venditore fino alla data in cui l'Acquirente non abbia provveduto al pagamento dell'intero prezzo degli stessi e di tutte le somme dovute al Venditore.

10.2 Nel caso in cui nel paese in cui l'Acquirente ha la propria sede, per la validità della riserva di proprietà a favore del Venditore sia necessario l'espletamento di formalità amministrative o legali quali, senza alcuna limitazione, la registrazione dei Prodotti in pubblici registri, ovvero l'apposizione sugli stessi di appositi sigilli, l'Acquirente si impegna fin d'ora a collaborare con il Venditore e a porre in essere tutti gli atti necessari al fine di far ottenere a quest'ultimo un valido diritto, anche nei confronti di eventuali soggetti terzi, con riferimento alla riserva di proprietà.

11. FORZA MAGGIORE

11.1 Sia l'Acquirente che Fami potranno sospendere l'esecuzione dei loro obblighi contrattuali quando tale esecuzione sia resa impossibile o irragionevolmente onerosa da un impedimento imprevedibile ed indipendente dalla loro volontà quale a titolo esemplificativo, non esaustivo, scioperi, epidemia e/o pandemia, boicottaggi, serrate, incendi, guerre, sommosse e rivoluzioni, requisizioni, embarghi, interruzioni di energia.

11.2 La Parte che desiderasse avvalersi della presente clausola dovrà comunicare immediatamente per iscritto, a mezzo posta elettronica certificata, all'altra il verificarsi e la cessazione delle circostanze di forza maggiore.

11.3 Qualora la sospensione dovuta a forza maggiore duri più di otto settimane, ciascuna Parte avrà il diritto di risolvere l'Ordine, previo un preavviso di 10 giorni, da comunicarsi all'altra per iscritto, mediante raccomandata con ricevuta di ritorno o mediante comunicazione a mezzo posta elettronica certificata.

11.4 In ogni caso, resta inteso che il Venditore avrà diritto di ottenere il pagamento dei Prodotti eventualmente già consegnati, oltre al rimborso di eventuali spese già sostenute.

12. MUTAMENTO NELLE CONDIZIONI PATRIMONIALI DELL'ACQUIRENTE

12.1 Fami avrà diritto a sospendere l'adempimento delle obbligazioni derivanti dalla fornitura dei Prodotti nel caso in cui le condizioni patrimoniali dell'Acquirente divenissero tali da porre in serio pericolo il conseguimento della controprestazione, salvo che sia prestata idonea garanzia. Resta inteso che il Venditore avrà diritto di ottenere il pagamento dei Prodotti eventualmente già consegnati, oltre al rimborso di eventuali spese già sostenute.

13. PROPRIETÀ INTELLETTUALI

13.1 I Diritti di Proprietà Intellettuale sono di totale ed esclusiva proprietà del Venditore e la loro comunicazione o utilizzo nell'ambito delle presenti Condizioni non crea, in relazione ad essi, alcun diritto o pretesa in capo all'Acquirente. Quest'ultimo si obbliga a non compiere alcun atto incompatibili con la titolarità dei Diritti di Proprietà Intellettuale.

13.2 L'Acquirente dichiara che: a) il Venditore è l'esclusivo titolare dei Marchi; b) si asterrà dall'utilizzare e da registrare marchi simili e/o confondibili con i Marchi; c) utilizzerà i Marchi esclusivamente in ottemperanza alle istruzioni del Venditore ed esclusivamente per i fini di cui alle presenti Condizioni.

14. FORO COMPETENTE E LEGGE APPLICABILE

14.1 Per qualunque controversia derivante o connessa alle presenti Condizioni Generali di vendita e/o al singolo Contratto quali, a titolo meramente esemplificativo e non esaustivo, controversie relative alla loro esistenza, validità, interpretazione, efficacia, esecuzione, è competente a decidere in via esclusiva il Tribunale di Vicenza, anche qualora il Contratto presenti elementi di internazionalità.

14.2 In deroga a quanto sopra stabilito, il Venditore ha comunque la facoltà di portare la controversia davanti al giudice competente presso la sede dell'Acquirente.

14.3 Le presenti Condizioni Generali di vendita e/o ogni singolo Contratto sono interamente soggetti alla legge italiana e interpretati secondo la stessa, anche qualora il Contratto presenti elementi di internazionalità, con espressa esclusione della Convenzione di Vienna del 1980.

15. PRIVACY

15.1. L'Acquirente dichiara di aver ricevuto tutte le informazioni previste ai sensi dell'art. 13 del Regolamento UE n. 2016/679 (GDPR) e presta il consenso al trattamento dei dati personali per le finalità di cui alle presenti condizioni generali di vendita e di essere stato informato che in relazione ai dati conferiti è possibile esercitare i diritti previsti dal D. Lgs. n. 196/2003 e del Regolamento UE n. 2016/679 (GDPR). Il Venditore dichiara che il titolare del trattamento dei dati raccolti è Fami S.r.l., con sede legale in Rosà (VI), Via Stazione Rossano n. 13, partita IVA e codice fiscale 03498610249

16. OSSERVANZA DELLA L. 231/2001

16.1 L'Acquirente prende atto che Fami S.r.l. ha adottato ed attua un Modello di Organizzazione, Gestione e Controllo ex D.lgs. 231/01, con i relativi Codice Etico e Sistema Disciplinare i cui dettagli possono essere visionati sul sito aziendale www.famispacom.com. L'Acquirente aderisce ai principi al succitato Modello di organizzazione, gestione e controllo nonché ai suoi allegati e si impegna a rispettarne i contenuti, i principi, e le procedure e, in generale, ad astenersi da qualsivoglia comportamento atto a configurare le ipotesi di reato indicate nel D.lgs 231/01 e sue successive modifiche ed integrazioni e riportate nel predetto Modello di organizzazione, gestione e controllo. L'Acquirente si impegna inoltre a rispettare e a far rispettare ad eventuali suoi collaboratori, tutti i principi contenuti nella suddetta documentazione ed i Protocolli comportamentali previsti dalla nostra organizzazione ai sensi del D. Lgs. 231/2001 ed allegati al presente contratto. La violazione delle regole previste dai sopracitati documenti rappresenterà grave inadempimento contrattuale.

17. DISPOSIZIONI FINALI

17.1 Qualora una delle Parti ometta di intraprendere un'azione giudiziale o di esercitare un diritto in base alle presenti Condizioni, tale comportamento di acquiescenza non potrà essere interpretato come una definitiva rinuncia ad esercitare in futuro la stessa azione giudiziale o lo stesso diritto.

17.2 La vendita dei Prodotti da parte di Fami all'Acquirente non fa sorgere a favore di quest'ultimo un diritto di esclusiva territoriale né consente all'Acquirente di assumere la qualità di distributore o concessionario di Fami.

17.3 L'invalidità in tutto o in parte di singole disposizioni delle presenti Condizioni non inficia la validità delle restanti previsioni.

BREVETTI

Alcuni componenti sono protetti da modello di design comunitario e/o brevetto di invenzione industriale.

BANCO DA IMBALLAGGIO



WWW.FAMISPA.COM

VIA STAZIONE ROSSANO 13
36027 ROSÀ (VICENZA) ITALIA

TEL. +39 0424 58 54 55

E-MAIL: INFO@FAMISPA.IT

TIMBRO RIVENDITORE