

**EASIER
QUICKER
BETTER**
SHOWER SYSTEMS

HYDRO-BLOK[®]
The BETTER Shower System



NEW FOR 2021/22
Low Profile Shower Pans
for Curb-Less Entry See page 6

SHOWER SYSTEM CATALOG 2022

www.hydroblok.com

CONTENTS

The HYDRO-BLOK System	3
Centre Drain Shower Pans	
Classic Shower Pans	4
Low-Profile Shower Pans	6
Shower Pan Extensions	14
Single Slope Shower Pans	
Standard Single Slope Pans	8
Thin Single Slope Pans	8
Single Slope Extensions	14
HYDRO-BLOK Linear Drain	10
Wallboard and Building Board	13
Tub Conversions	17
Shower Curbs	18
Shower Benches	19
Shower Niches & Caddies	20
System Accessories & Parts	22



All HYDRO-BLOK products are designed and manufactured to the highest quality standards and are certified to international plumbing standards. We stand behind this commitment to quality with the HYDRO-BLOK Lifetime Limited Warranty.



HYDRO-BLOK foam based products are completely free of hexabromocyclododecane (HBCD), a toxic fire retardant once commonly found in foam insulation and building products.

Find a Dealer Near You

Visit our website at www.HYDROBLOK.com to find a distributor or dealer near you.

Interested in becoming a HYDRO-BLOK dealer or distributor? Contact us toll-free at 1 844 588 9559 for more information.

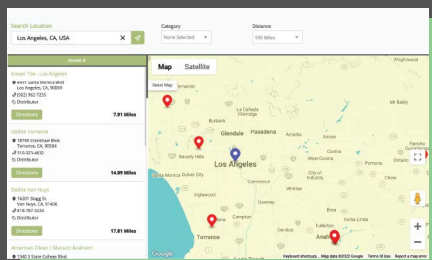

THE HYDRO-BLOK[®] SHOWER SYSTEM

HYDRO-BLOK[®] Shower Systems are a convenient, cost-effective and easy way to build and fully customize a modern, elegant and 100% waterproof shower. Whether you are a Do-It-Yourselfer or contractor, HYDRO-BLOK products help make your next shower installation a breeze.

With HYDRO-BLOK's multiple drain and shower pan options along with our full range of accessories including benches, niches and building board for custom features, anyone can create a stunning custom shower easily and quickly.

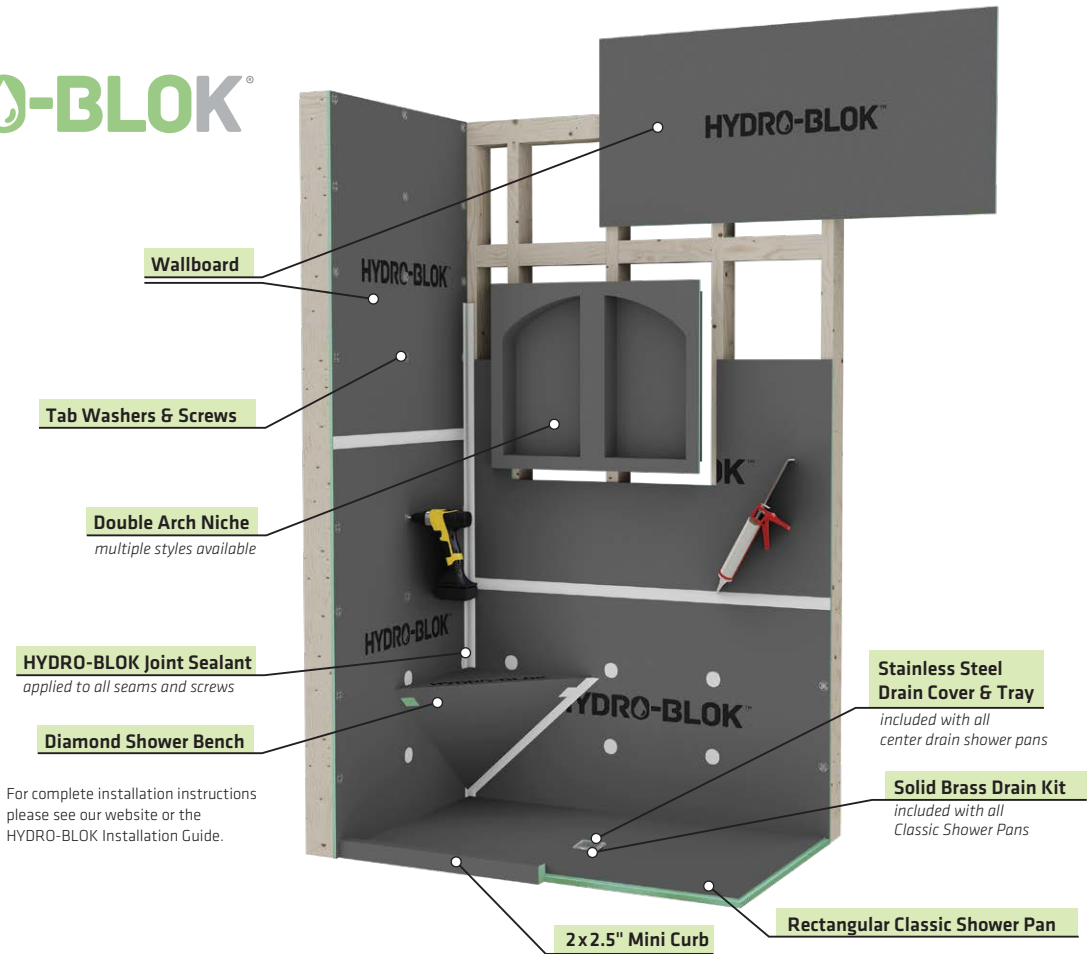

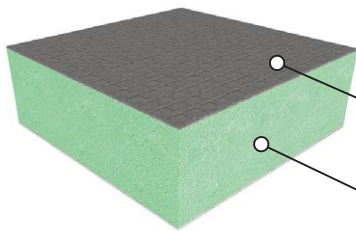

For complete installation instructions please see our website or the HYDRO-BLOK Installation Guide.



Modified cement coating for maximum adhesion of any tile, stone, or mosaics

HCFC-free XPS closed-cell foam interior. 100% waterproof

-  All HYDRO-BLOK foam components can be quickly and easily cut or customized with a utility knife, hand saw, or standard power saw.
-  Applying HYDRO-BLOK joint sealant to all seams and screws creates your final waterproof shower system ready for tile, stone, or mosaic application.
-  Tile or stone can be laid within 1 hour of completing your HYDRO-BLOK shower system installation.



HYDRO-BLOK offers a complete system of Shower Pans, Extensions, Wallboard, Shower Curbs, and Niches to build a fully custom shower. Our Wall and Building Board options let you create tub surrounds, waterproofed floors, custom benches & features easily and quickly.



Lightweight and strong, HYDRO-BLOK components are easily and quickly installed and waterproofed with our Joint Sealant. No additional waterproof membrane is required and you can start tiling in under an hour after installation. All backed by our Limited Lifetime Warranty.

CLASSIC SHOWER PANS

HYDRO-BLOK Classic Shower pans are easy to install and perfect for installing with a curb. Classic pans are available in a range of center-drain sizes and in a typical offset drain tub replacement. They can be quickly and easily customized to fit any shower area by trimming with a power saw or using a HYDRO-BLOK Shower Pan Extension. Every Shower Pan includes a full brass drain kit, stainless steel drain cover & tray, installation template and installation tools.

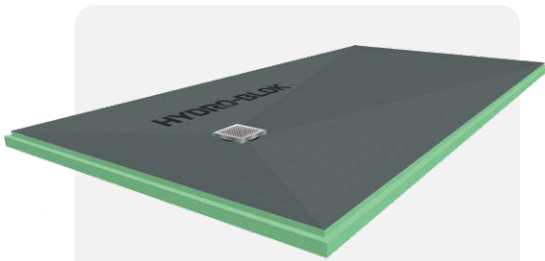
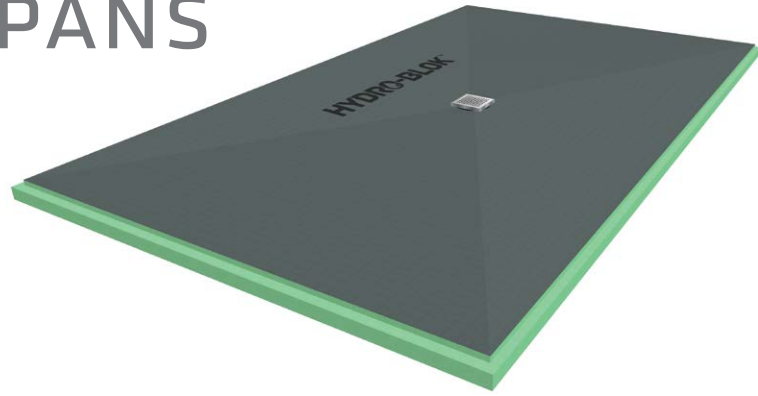

36" x 72" Offset Drain Shower Pans available for tub replacement installs. (see page 17)

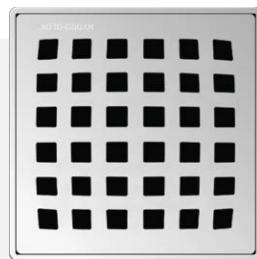

Stylish Stainless Steel Drain cover included (also available in Matte Black, Satin Brass, Polished Chrome or Oil-Rubbed Bronze)



Each Classic Shower Pan includes a ready to install Brass Drain Kit right in the box



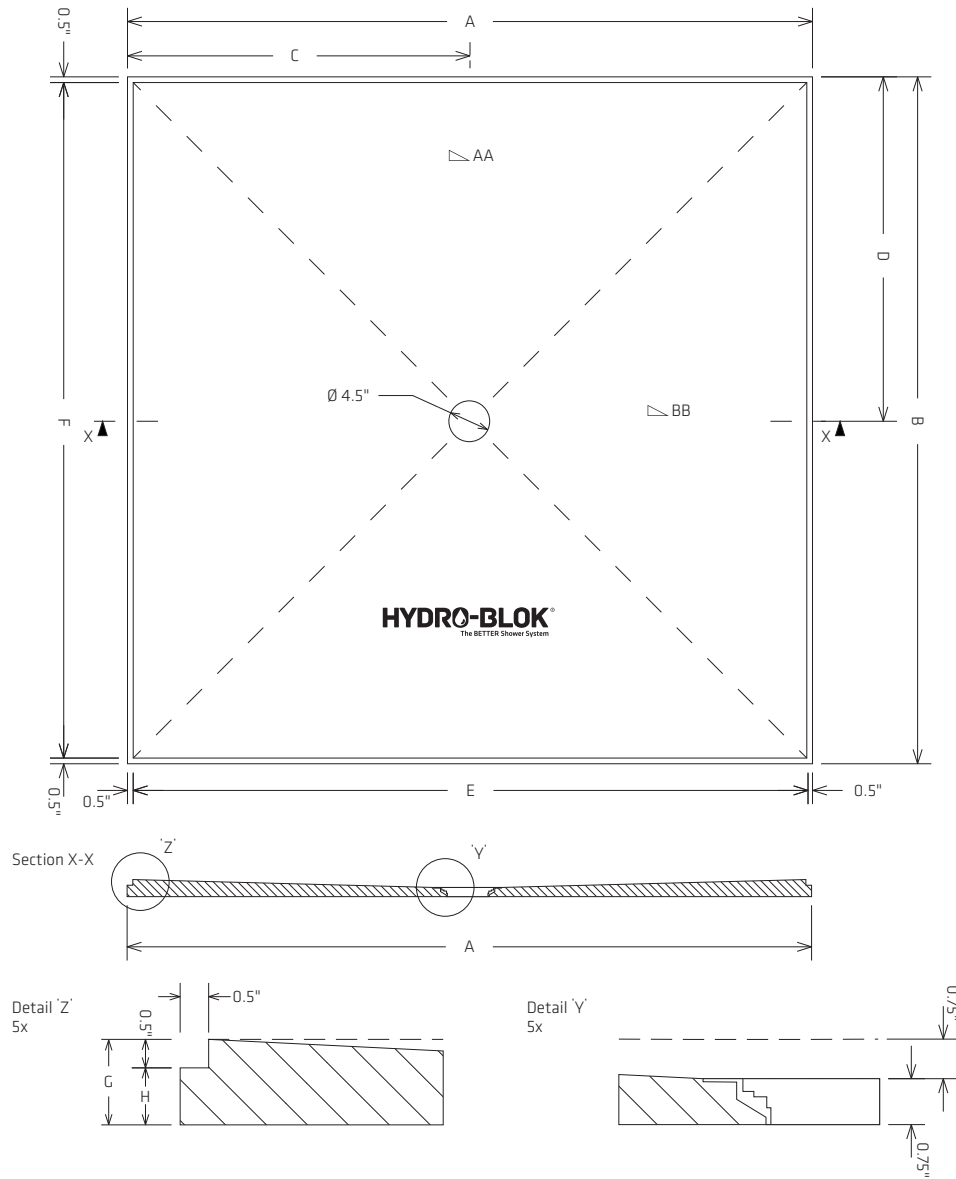

SKU	SIZE	A	B	C	D	E	F	G	H	SLOPE AA	SLOPE BB
HBSP3636	36" x 36"	36	36	18	18	35	35	1.5	1	4.76	4.76
HBSP3648	36" x 48"	36	48	18	24	35	47	1.5	1	4.76	3.45
HBSP3660	36" x 60"	36	60	18	30	35	59	1.5	1	4.76	2.7
HBSP3672	36" x 72"	36	72	18	36	35	71	1.5	1	4.76	2.22
HBSP36720D	36" x 72"	36	72	16	36	35	71	2	1.5	9.09	3.7
	Off-set Drain	* see page 17 for offset drain location dimensions									
HBSP4848	48" x 48"	48	48	24	24	47	47	1.5	1	3.45	3.45
HBSP4860	48" x 60"	48	60	24	30	47	59	1.5	1	3.45	2.7
HBSP4872	48" x 72"	48	72	24	36	47	71	1.5	1	3.45	2.22
HBSP4884	48" x 84"	48	84	24	42	47	83	2	1.5	3.45	1.89
HBSP6060	60" x 60"	60	60	30	30	59	59	1.5	1	2.7	2.7
HBSP6072	60" x 72"	60	72	30	36	59	71	1.5	1	2.7	2.22
HBSP6084	60" x 84"	60	84	30	42	59	83	2	1.5	4.5	3.14
HBSP7272	72" x 72"	72	72	36	36	71	71	1.5	1	2.22	2.22

NEW!

LOW PROFILE SHOWER PANS

HYDRO-BLOK Low Profile Shower Pans combine the same quality and ease of installation of our Classic Shower Pans with an industry-exclusive Low Profile pan and drain design. Install with one of our Shower Curbs or together with the HYDRO-BLOK Sub-Floor Lowering Kit to create an elegant and modern Barrier-Free shower entry.

- 💧 No tools or glue required for pipe connection
- 💧 Accommodates angled drain pipes up to 5 degrees.
- 💧 Flexibility for uncentered drain pipes up to 1/4" per side
- 💧 Lateral movement of drain cover to accommodate your tile layout
- 💧 New adjustable drain cover will accommodate tile thickness from 3/16" to 3/4"
- 💧 Easily adjustable to be perfectly flush to finished tile.

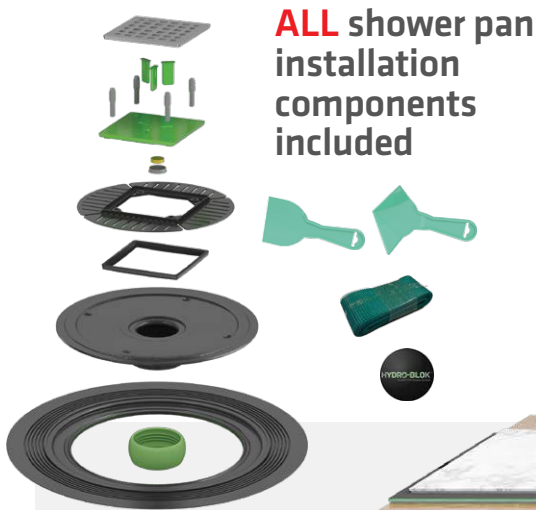
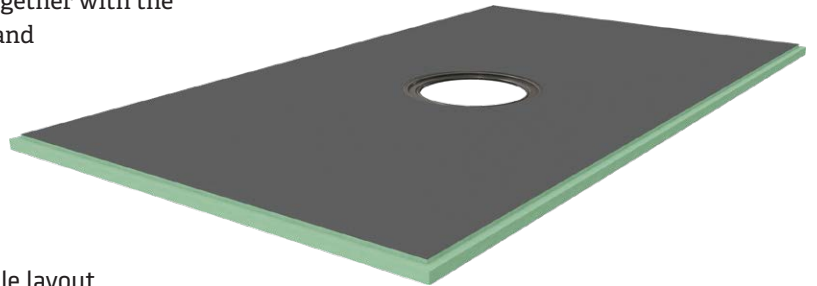

ALL shower pan installation components included

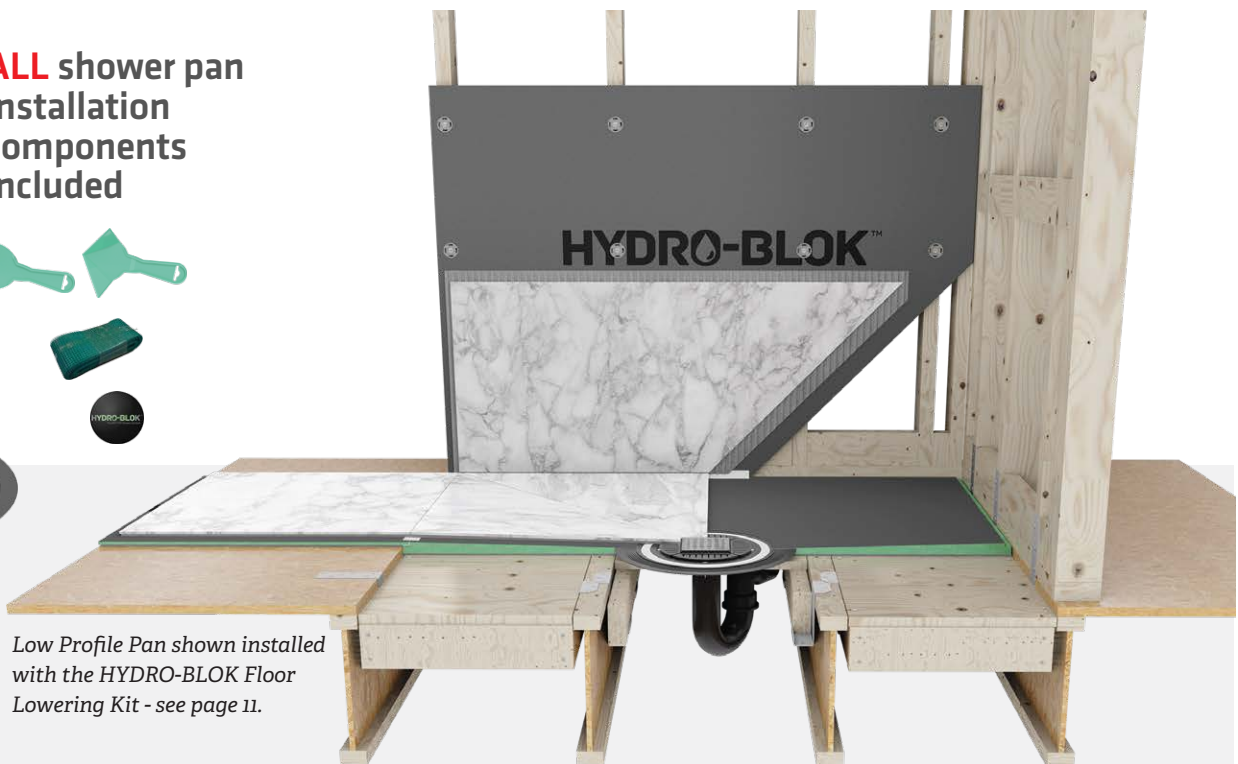

Low Profile Pan shown installed with the HYDRO-BLOK Floor Lowering Kit - see page 11.

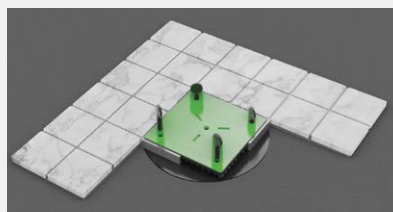

Construction plug and grout over frame is adjustable for tile thickness & laterally for tile layout.

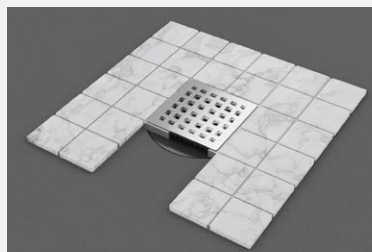

Grout over frame gives a clean finish for your shower.

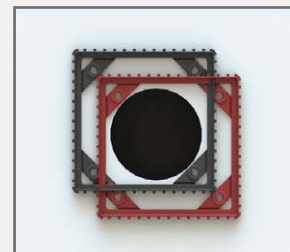

Grate location can be adjusted 1/2" in any direction from center.

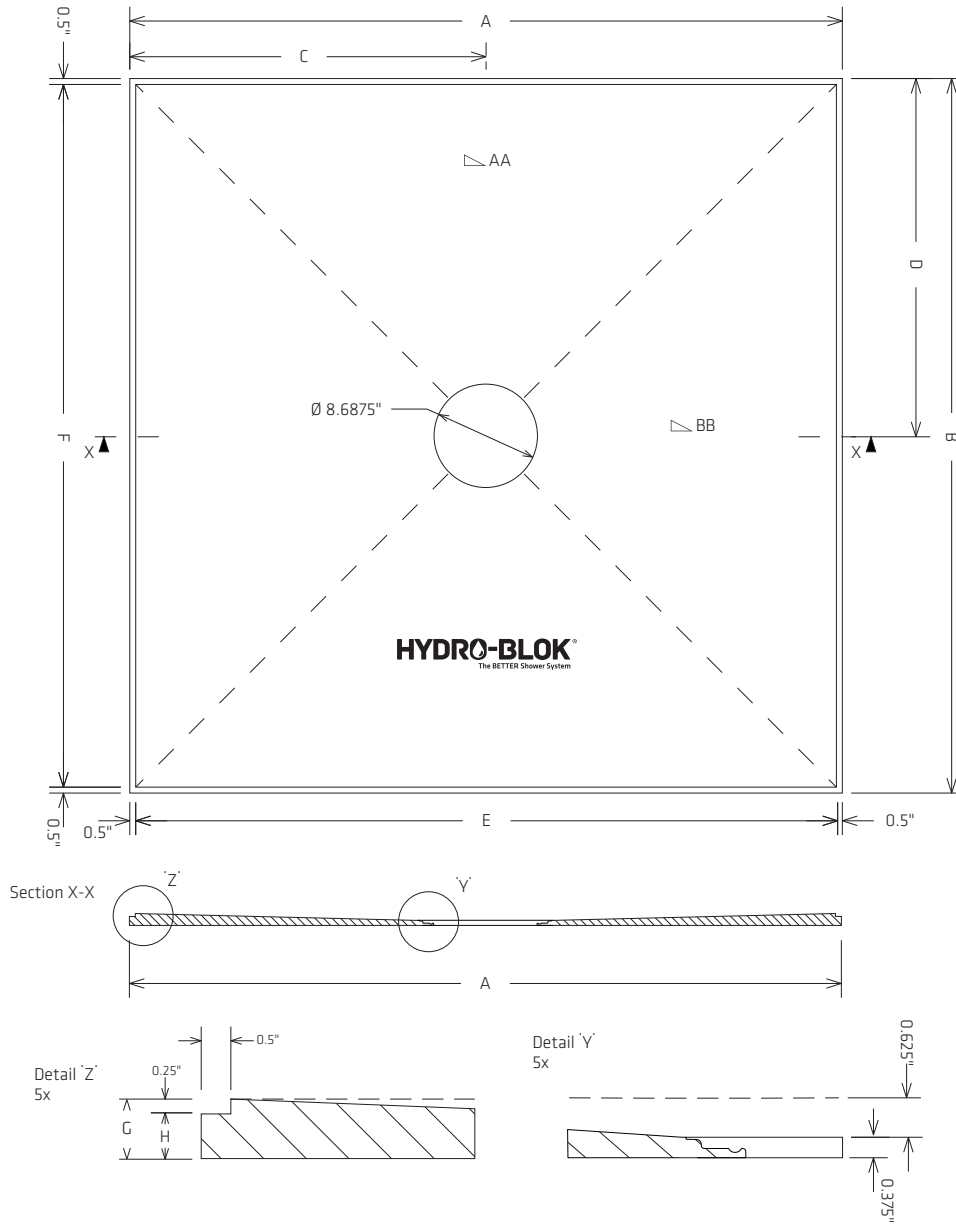

SKU	SIZE	A	B	C	D	E	F	G	H	SLOPE AA	SLOPE BB
HBLPSP3636	36" x 36"	36	36	18	18	35	35	1	0.75	5.3	5.3
HBLPSP3648	36" x 48"	36	48	18	24	35	47	1	0.75	5.3	3.5
HBLPSP3660	36" x 60"	36	60	18	30	35	59	1	0.75	5.3	2.6
HBLPSP3672	36" x 72"	36	72	18	36	35	71	1	0.75	5.3	2.1
HBLPSP36720D	36" x 72"	36	72	16	36	35	71	1.25	1	9	2.9
	Off-set Drain	* see page 17 for offset drain location dimensions									
HBLPSP4848	48" x 48"	48	48	24	24	47	47	1	0.75	3.5	3.5
HBLPSP4860	48" x 60"	48	60	24	30	47	59	1	0.75	3.5	2.6
HBLPSP4872	48" x 72"	48	72	24	36	47	71	1	0.75	3.5	2.1
HBLPSP4884	48" x 84"	48	84	24	42	47	83	1.25	1	3.5	1.7
HBLPSP6060	60" x 60"	60	60	30	30	59	59	1	0.75	2.6	2.6
HBLPSP6072	60" x 72"	60	72	30	36	59	71	1	0.75	2.6	2.1
HBLPSP6084	60" x 84"	60	84	30	42	59	83	1.25	1	3.7	2.4
HBLPSP7272	72" x 72"	72	72	36	36	71	71	1	0.75	2.1	2.1

SINGLE SLOPE SHOWER PANS STANDARD AND THIN

Single Slope Shower Pans

Create a clean, minimalist, modern design for your shower

HYDRO-BLOK Single Slope shower pans together with the HYDRO-BLOK Linear Drain by Ebbe are your solution for a clean, modern appearance. The freedom to use any size of tile or stone on your shower pan allows for unique and creative designs with no visible drain cover on the shower floor.

THIN Single Slope Shower Pans

Build a curb-less shower without lowering your sub-floor

HYDRO-BLOK THIN Single Slope Shower Pans offer a flush entry shower solution with only limited subfloor reconstruction work needed and no floor joist re-structuring. They offer savings in time, cost and re-construction effort needed with no special engineering and structure changes needed.

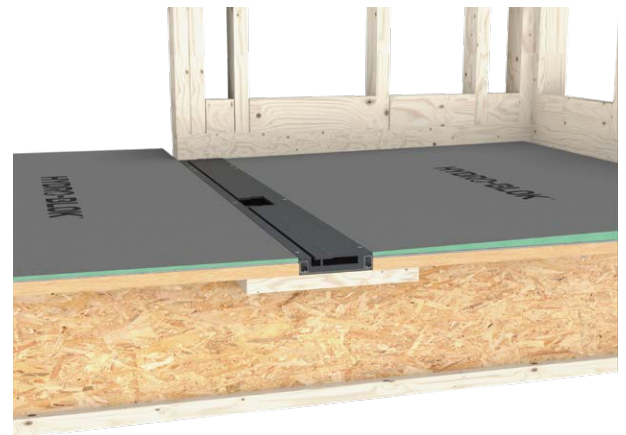
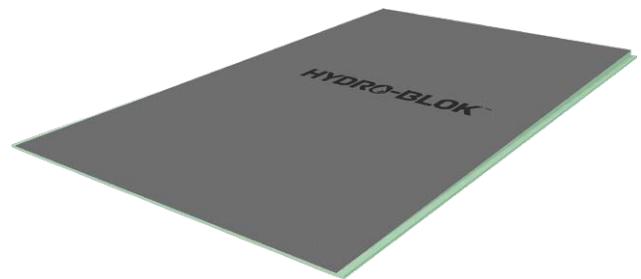
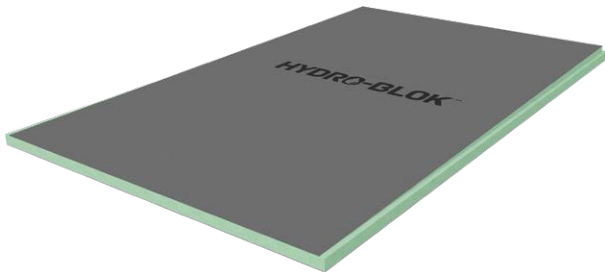

HYDRO-BLOK® Barrier-Free Installation Options

HYDRO-BLOK Thin Single Slope Shower Pans require only the drain area to be lowered to provide barrier free showers in new or renovation installations. HYDRO-BLOK Standard Single

Slope Shower Pans or our new Low-Profile Center Drain pans together with our Sub-Floor Lowering Kit (patent-pending) allow your entire shower area to be set up for a curb-less installation.

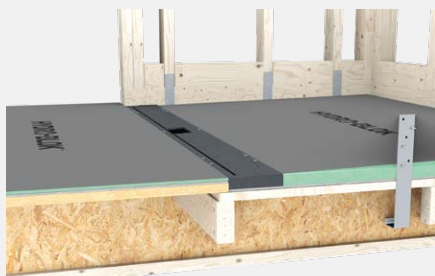

Single Slope Shower Pans

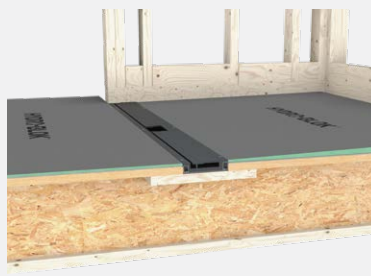

THIN Single Slope Shower Pans



Sub-Floor Lowering Kit

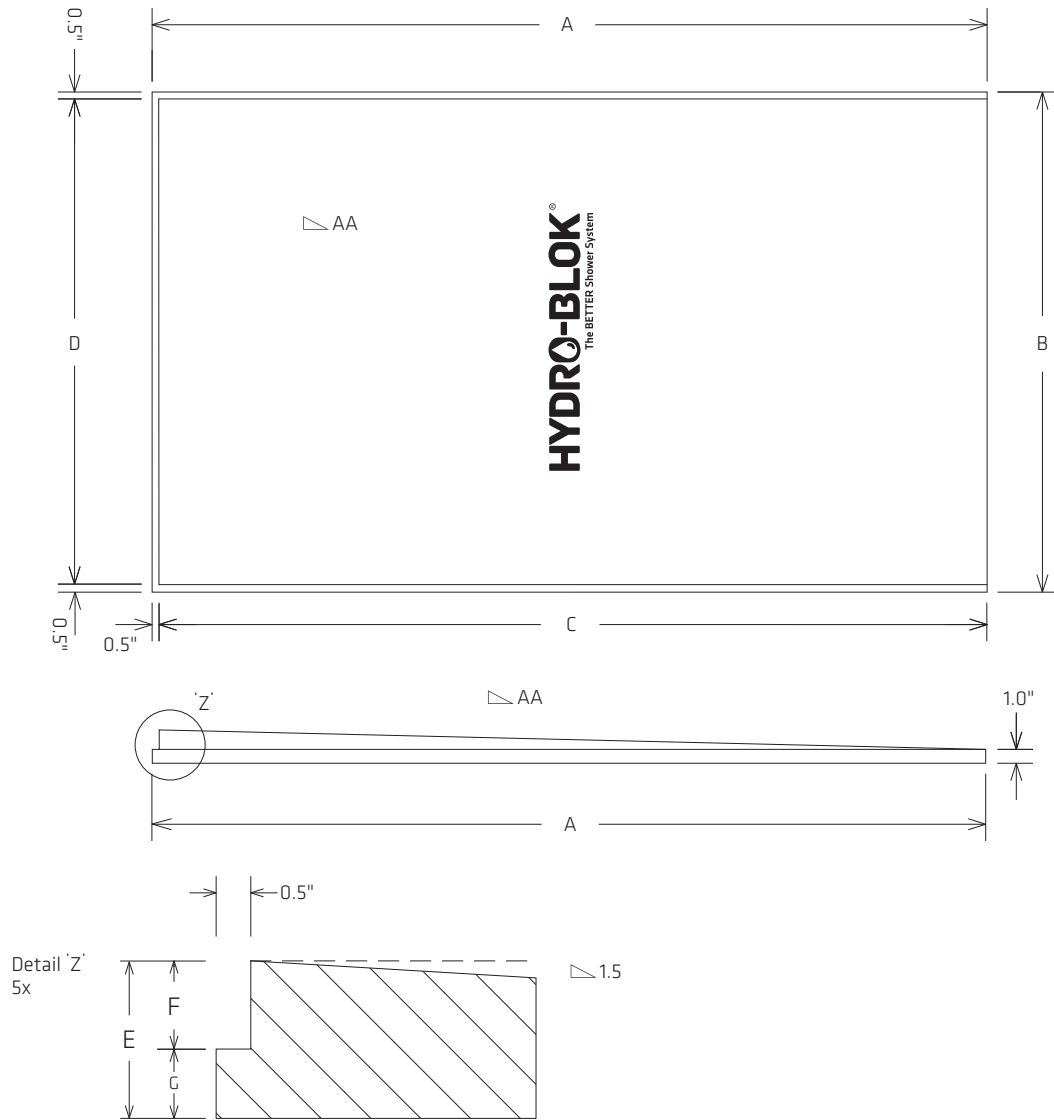

STANDARD SINGLE SLOPE SHOWER PANS

SKU	SIZE	A	B	C	D	E	F	G	SLOPE AA
HBSSSP3660	36" x 60"	60	36	59.5	35	2.25	1.25	1	2.1
HBSSSP6036	60" x 36"	36	60	35.5	59	1.75	0.75	1	2.1
HBSSSP4872	48" x 72"	72	48	71.5	47	2.5	1.5	1	2.1
HBSSSP7248	72" x 48"	48	72	47.5	71	2	1	1	2.1

THIN SINGLE SLOPE SHOWER PANS

SKU	SIZE	A	B	C	D	E	F	G	SLOPE AA
HBTSSSP3660	36" x 60"	60	36	59.5	35	1.5	1.25	0.25	2.1
HBTSSSP6036	60" x 36"	36	60	35.5	59	1	0.75	0.25	2.1
HBTSSSP4872	48" x 72"	72	48	71.5	47	1.75	1.5	0.25	2.1
HBTSSSP7248	72" x 48"	48	72	47.5	71	1.25	1	0.25	2.1

HYDRO-BLOK LINEAR DRAIN BY EBBE

Easy Barrier-Free Elegance

Have you dreamed of a luxurious open-concept shower that seamlessly transitions from your bathroom floor directly into your shower with no barrier or curb?

HYDRO-BLOK® Single Slope Shower Pans with the HYDRO-BLOK Linear Drain by ebbe and our all-new Low-Profile Center Drain Shower Pans are your solutions. The freedom to use any size of tile or stone on your shower pan allows for unique and creative designs and a modern, clean appearance with no metal drain cover visible on the shower floor.

The HYDRO-BLOK Linear Drain by ebbe can be placed anywhere in a shower as it is easily customized to fit any shower space or size for either residential or commercial installations.

Take a look at the new era of shower designs and put yourself in a world of luxury and timeless elegance.



The HYDRO-BLOK Linear Drain by ebbe was designed & produced in partnership with ebbe America, a leader in the plumbing industry and known as an innovative manufacturer of floor drains and associated products.

HYDRO-BLOK Single Slope Shower Pan

End Cap Cover

End Caps

Drain Channel

Drain Body

cut to size and add end caps

2" or 3" Drain Connection

Aluminum Rails

Tile Insert

Access Cover

The 73/8" linear drain body can be cut to fit showers of all sizes or coupled with additional drain bodies for larger showers.

LINEAR DRAIN ACCESSORIES

Linear Drain Access Tray
3/8" 1/4" or 1/2" Tile Thickness



HBLDAFT38 HBLDAFT14 HBLDAFT12

Allows for additional tile thicknesses when installing a linear drain (3/8" inc. with drain kit)

Linear Drain Body Coupler



HBLDCOUP

Join two or more drain bodies together to fit almost any size or space requirements.

Linear Drain Slot Extender Stick



HBLDSLOTEXT

Extend the surface tile drainage gap up to 12" on one or both ends of the line drain.



SUB-FLOOR LOWERING KIT

- 💧 One kit recesses up to 24 sq ft
- 💧 Perfect for I-joists or dimensional lumber because brackets attach to the top chord of joists and studs at parallel walls
- 💧 Wall brackets can be modified for different situations
- 💧 Achieves L/360 or better deflection rating with a live load of 40 PSF and dead load of 20 PSF

Quickly and easily lower your sub-floor for a low profile, curbless ADA, or barrier free shower installation. A perfect compliment for HYDRO-BLOK Single Slope Shower Pans or the NEW Low Profile Center Drain Shower Pans.

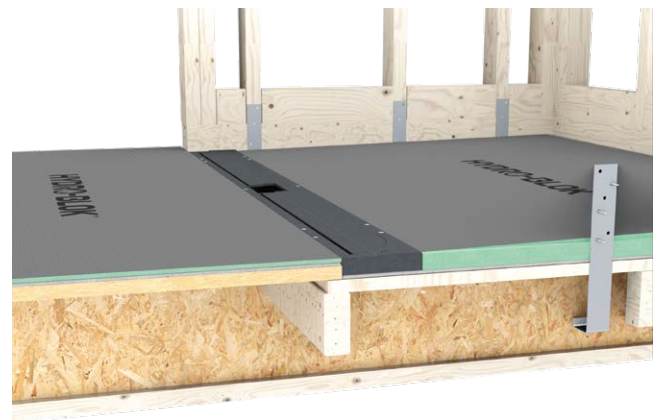

Provides a strong and sturdy base for installing a low profile shower pan for curb-less entry.



Kit includes all brackets and screw required for installation - just add your 2x4" lumber

LINEAR DRAIN INSTALLATION OPTIONS

IN-SIGHT TRIM KIT

The HYDRO-BLOK IN-Sight Trim kit gives the option of having a metal finished edge along the length of the linear drain gap.

IMPORTANT: The IN-Sight Trim Kit is MANDATORY when your Linear Drain is located at the entry to your shower

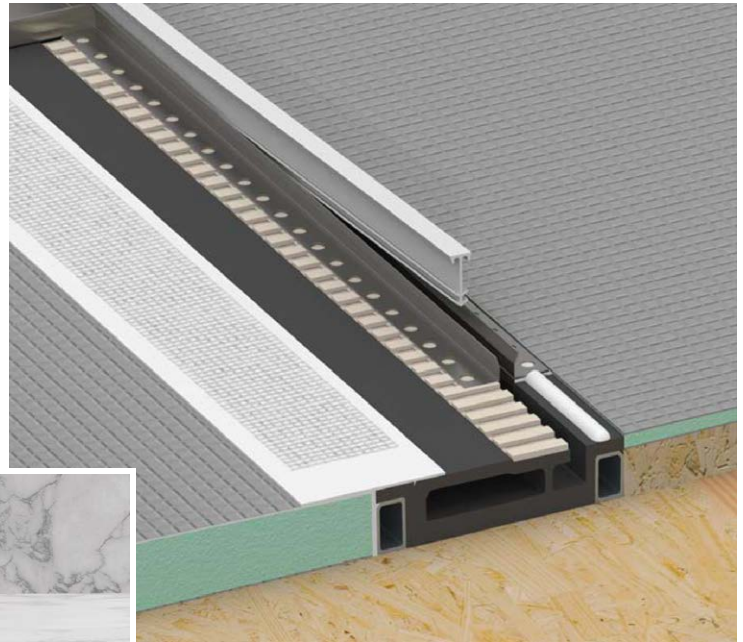

In-Sight Trim Kit Includes:

- 2 pcs In-Sight trim 35 3/4" length
- Metal cut-off wheel
- Temporary gap spacing sticks



TRIM KIT	SKU
IN-Shadow Trim Kit	HBINSHADOW
3/8" IN-Sight Trim Kit	HBINSI38
1/4" IN-Sight Trim Kit	HBINSI14
1/2" IN-Sight Trim Kit	HBINSI12

IN-SHADOW TRIM KIT

The HYDRO-BLOK IN-Shadow Trim kit allows for the installation of the drain so that the drain slot is 'hidden' under the vertical wall tile for a clean & modern look. Cleaning and maintenance remains easy thanks to the removable drain tray.



In-Shadow Trim Kit Includes:

- 2 pcs In-Shadow trim 35 3/4" length
- Metal cut-off wheel
- Temporary foam backer rod



WALLBOARD & BUILDING BOARD

HYDRO-BLOK Wallboard and Building Board products are built with the same high quality construction as the rest of our foam products with a 100% waterproof XPS foam core, covered by fiberglass mesh and then coated in a modified cement coating to provide superior strength and an excellent bonding surface for your tile, stone, glass or mosaics. All boards can be easily cut with a utility knife, hand saw or small circular saw. Building Board is ideal for the construction of custom benches and other features. They can be custom cut to bend around inside or outside corners for creative and unique shower features.

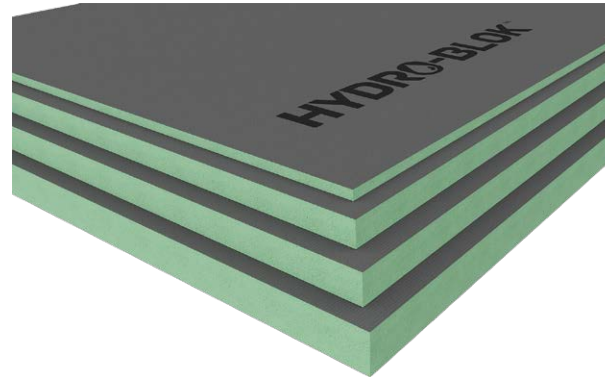

AVAILABLE SIZES & THICKNESSES

SKU	SIZE	DIM A	DIM B	DIM C	USES
HBWB366014	36" x 60" x 1/4" Board	36	60	0.25	Floor Insulation
HBWB366012	36" x 60" x 1/2" Board	36	60	0.5	Wallboard
HBWB486412	48" x 64" x 1/2" Board	48	64	0.5	Wallboard
HBWB489612	48" x 96" x 1/2" Board	48	96	0.5	Wallboard
HBWB366058	36" x 60" x 5/8" Board	36	60	0.625	Commercial or Residential Wallboard
HBWB36601	36" x 60" x 1" Board	36	60	1	Custom Features
HBWB2548112	25" x 48" x 1 1/2" Board	25	48	1.5	All Custom Features - benches, partitions
HBWB3648112	36" x 48" x 1 1/2" Board	36	48	1.5	All Custom Features - benches, partitions
HBWB48602	48" x 60" x 2" Board	48	60	2	Building Board, Benches, Custom Features

Custom shower benches created with HYDRO-BLOK 2" Building Board with dual Linear Drains and floor insulation for a Commercial Steam room project.



Custom curved residential shower bench created with HYDRO-BLOK 2" Building Board - see it built and installed on the HYDRO-BLOK YouTube Channel!

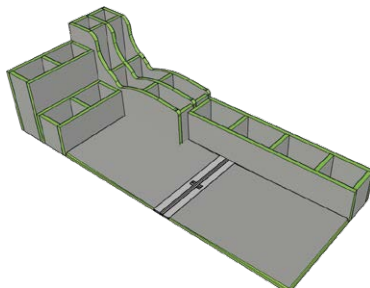

SHOWER PAN EXTENSIONS

CENTER DRAIN & SINGLE SLOPE

Need to make that shower a little larger? Then our line of shower pan extensions is what you need. Start with our corner extension which matches seamlessly to any of our HYDRO-BLOK shower pans to custom build the shower of your dreams. Add our HBSPE2448 24" x 48" Shower Pan Extension to the HYDRO-BLOK Corner Extension and you will soon realize how easy it is to continue your shower floor and maintain proper slope throughout. Built with the same high quality construction and dependability as our full line of shower pans, wallboards and accessories.

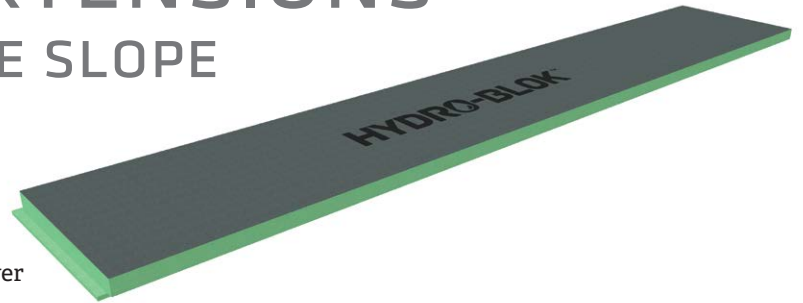

MORE SIZE OPTIONS FROM COMMON SHOWER PANS

4'X4' PAN OPTIONS

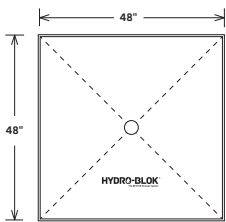

4' x 4' Shower Pan

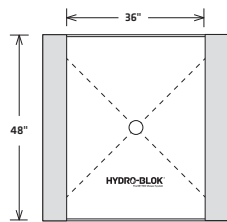

4' x 4' Shower Pan
Cut to Size

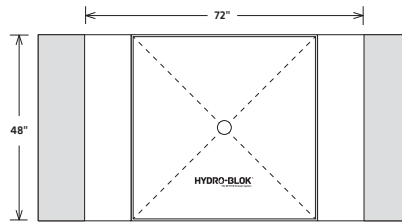

4' x 4' Shower Pan with two 4' x 2'
Pan Extensions Cut to Size

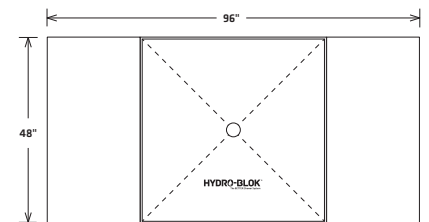

4' x 4' Shower Pan with two
4' x 2' Pan Extensions

3'X5' PAN OPTIONS

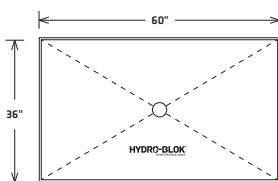

3' x 5' Shower Pan

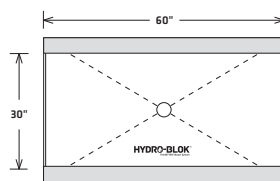

3' x 5' Shower Pan
Cut to Size

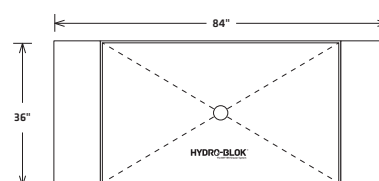

3' x 5' Shower Pan with a 6' x 1'
Pan Extension cut into two sections

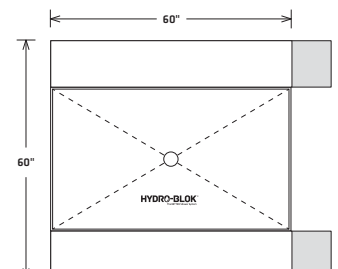

3' x 5' Shower Pan with two
6' x 1' Pan Extensions

3'X6' OFFSET DRAIN PAN OPTIONS

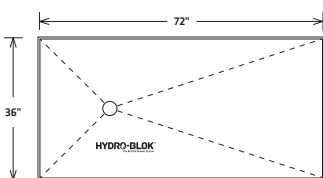

3' x 6' Offset Drain
Shower Pan

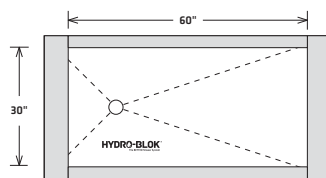

3' x 6' Offset Drain Shower Pan
Cut to Size in all Dimensions

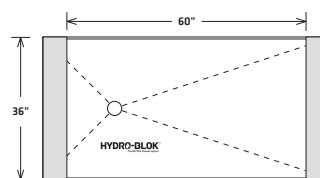

3' x 6' Offset Drain Shower Pan
Cut to Size

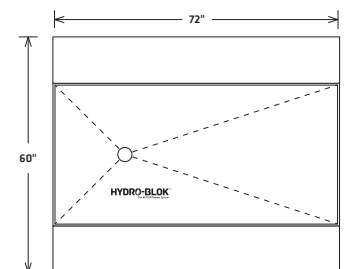

3' x 6' Offset Drain Shower Pan with
two 6' x 1' Pan Extensions

**CLASSIC CORNER SHOWER PAN
EXTENSION 36" X 36"**

HBSPCE3636

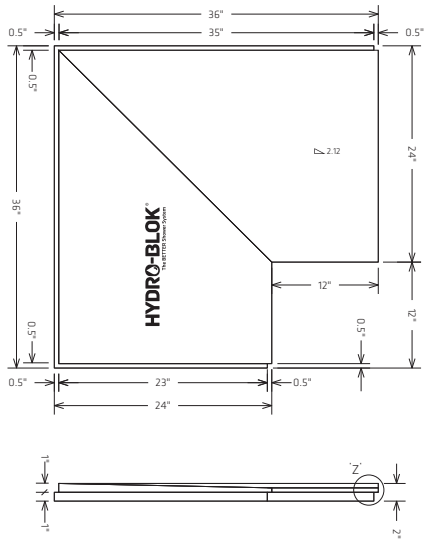

Tileable Surface Slopes
1.5" at inner corner to
2.0" in overall height

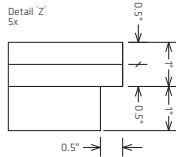

**CLASSIC SHOWER PAN
EXTENSION 12" X 72"**

HBSPE1272

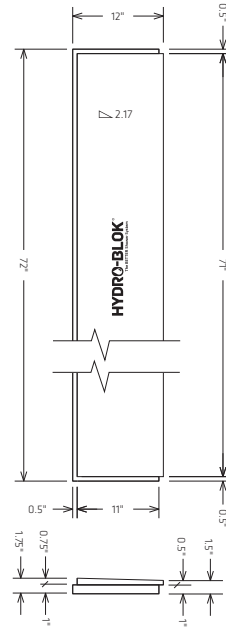

**CLASSIC SHOWER PAN
EXTENSION 24" X 48"**

HBSPE2448

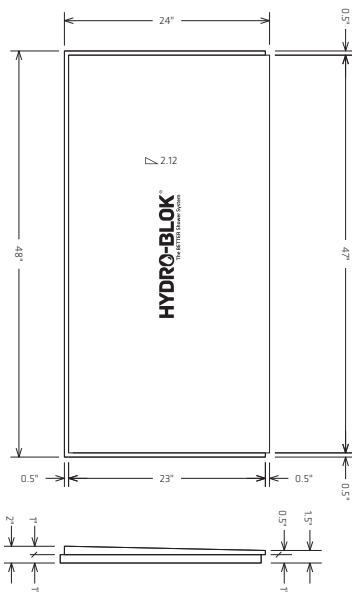

**LOW PROFILE SHOWER PAN
EXTENSION 24" X 48"**

HBLPSPE2448

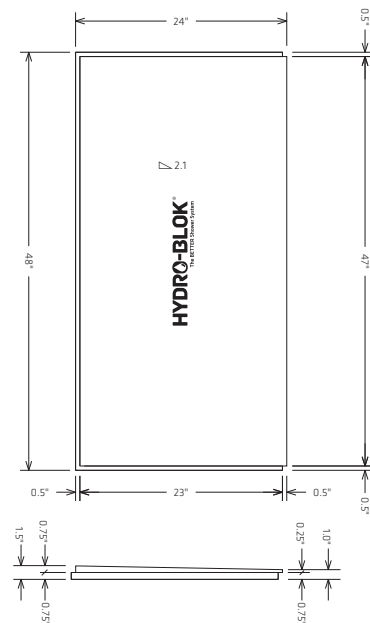

LOW PROFILE SHOWER PAN EXTENSION 12" X 72"

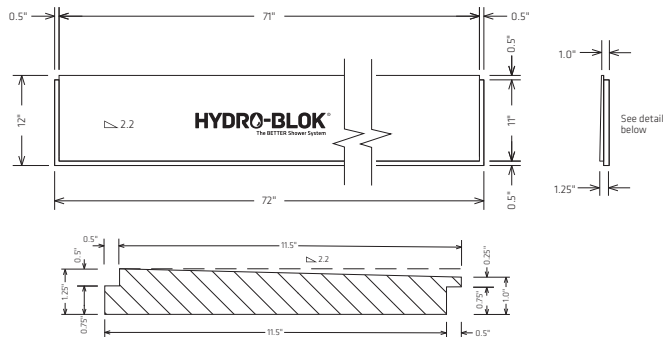

HBLPSPE1272

SINGLE SLOPE SHOWER PAN SIDE EXTENSION 18" X 72"

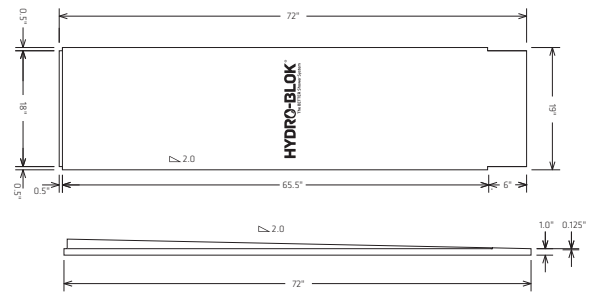

HBSSSPE1872

THIN SINGLE SLOPE SHOWER PAN EXTENSION 72" X 12"

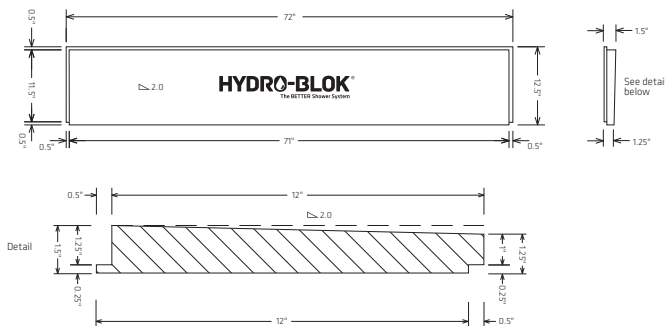

HBTSSSPE7212

SINGLE SLOPE SHOWER PAN EXTENSION 72" X 12"

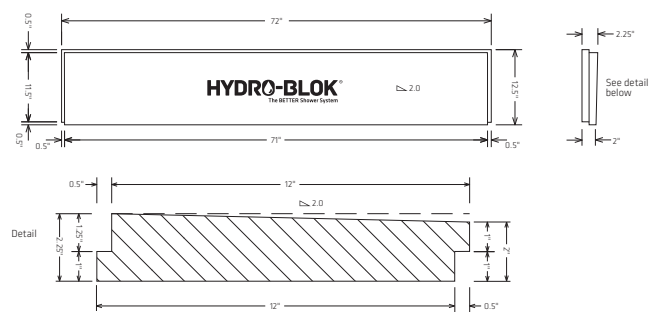

HBSSSPE7212

SHOWER RAMP FOR LOW-PROFILE SHOWER PANS

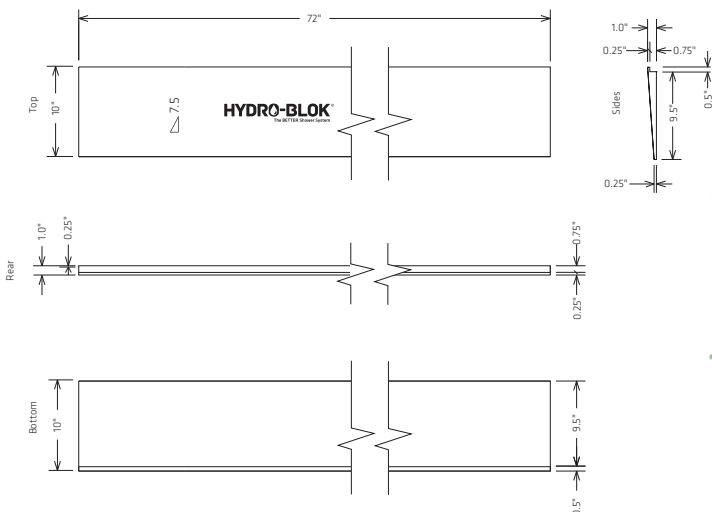

The HYDRO-BLOK EZ Access Shower Ramp is designed to allow easy no-barrier access into a shower. Starting at 1/8" and rising to match our Low Profile shower pans, this ramp provides a smooth transition and entry into any of our showers.

HBLPSR1072

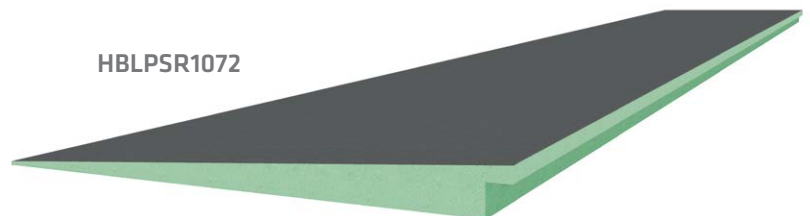

HBSR1272 Shower Ramp also available for HYDRO-BLOK Classic Shower Pans

TUB CONVERSIONS

CLASSIC & LOW PROFILE OFFSET DRAIN PANS

HYDRO-BLOK Offset-Drain Shower Pans are designed to make the conversion of a typical bathtub to a modern tiled shower as easy as possible. With a drain placed 16" from one end, these pans eliminate the need to make any plumbing alterations when installing a shower. The Shower Pans are easy to cut to size with simple tools or extend to fit your space using HYDRO-BLOK Shower Pan Extensions. Offset-Drain Pans are available in Classic version for use with a Shower Curb or as a Low-Profile version allowing the possibility of modern barrier-free entry to your shower conversion.

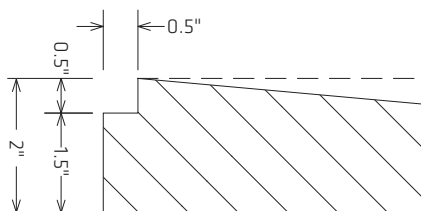
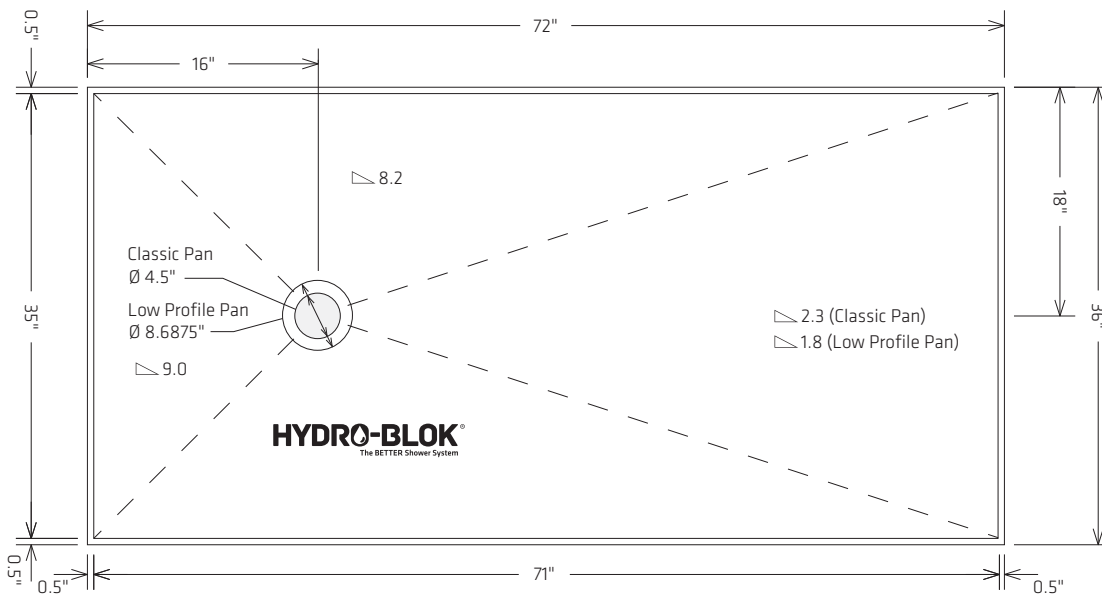
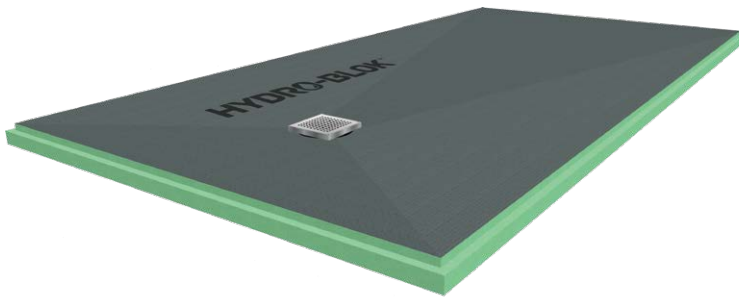

Classic Offset Drain Pan

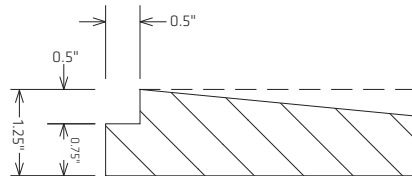

Low Profile Offset Drain Pan

SHOWER CURBS

HYDRO-BLOK Shower Curbs are available in both Standard (4" tall) and Mini (2.5" tall) sizes and feature high-quality construction with a 100% waterproof XPS foam core covered by fiberglass mesh for added strength, and then coated in our modified cement surface for setting your choice of tile, stone, glass or mosaics.

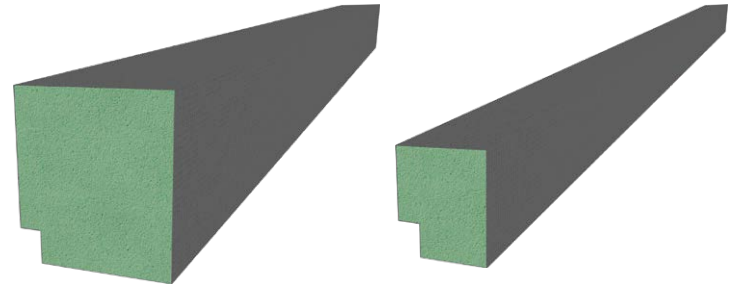

STANDARD 3.5" X 4" SHOWER CURB

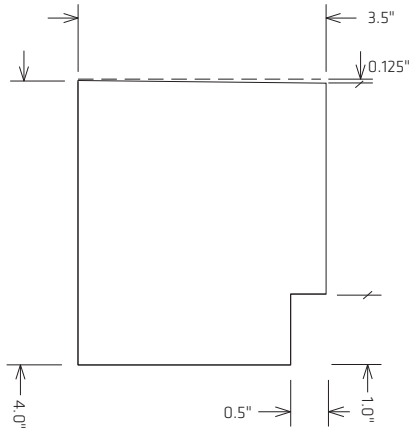

60" HBSC312460 / 96" HBSC312496

MINI 2" X 2.5" SHOWER CURB

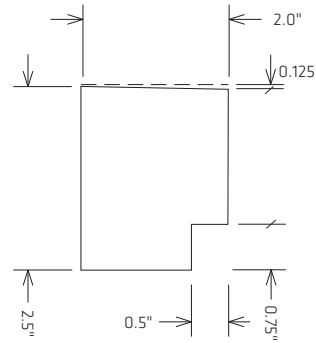

60" HBSCM60 / 84" HBSCM84

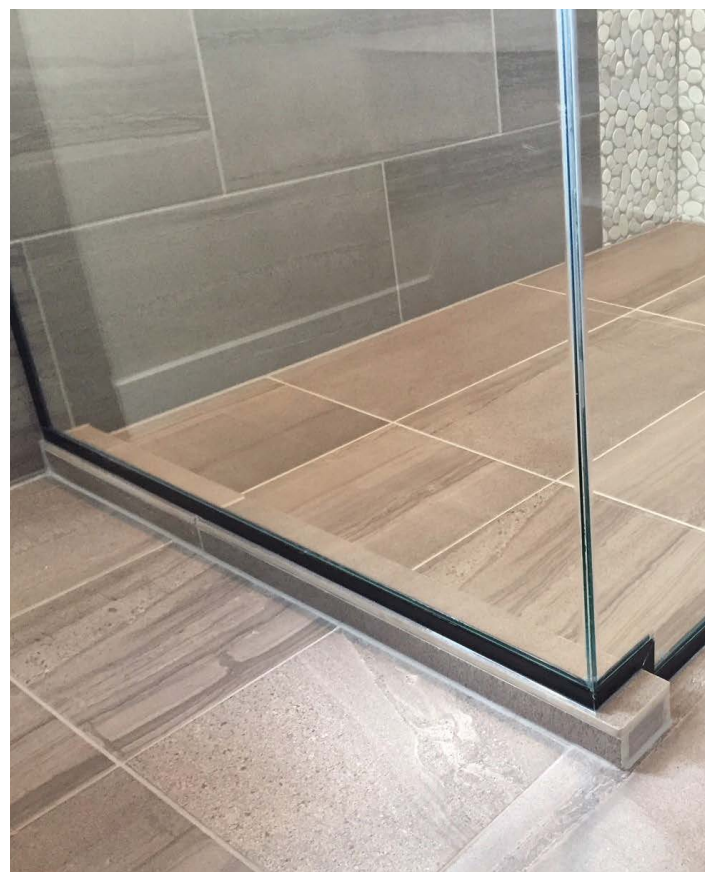

SHOWER BENCHES

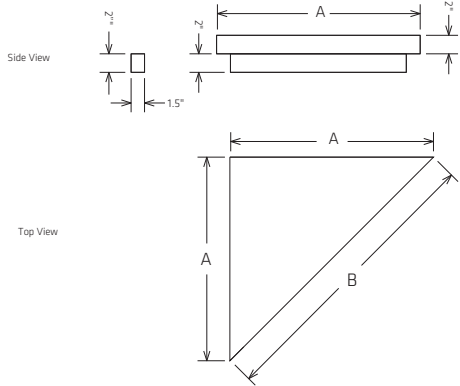

SKU	SIZE	DIM A	DIM B
HBSPL	Large Suspended Bench	22"	31.1"
HBSBM	Medium Suspended Bench	17"	24"

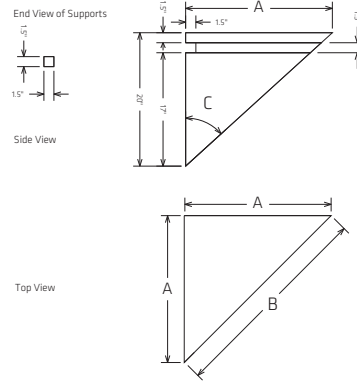

SKU	SIZE	DIM A	DIM B	ANGLE C
HBDPL	Large Diamond Bench	22"	31.1"	47.7°
HBDBM	Med. Diamond Bench	17"	24.06"	40.4°

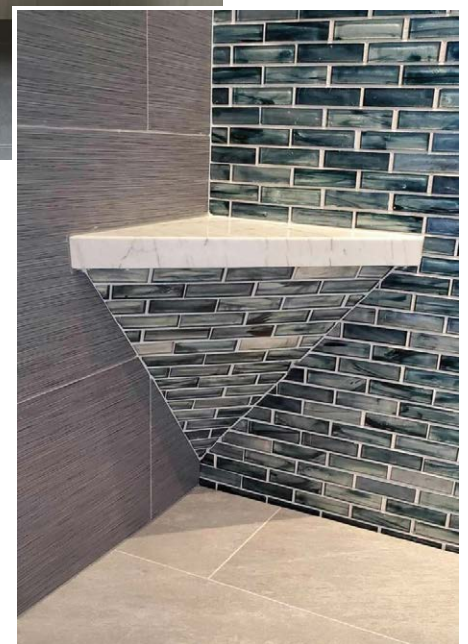

SHOWER NICHE & CADDY

HYDRO-BLOK Shower Niches are available in a range of sizes and styles to make customizing your HYDRO-BLOK Shower System quick and easy without having to worry about custom designs and framing. Our niches are manufactured from a single piece of 100% water-proof XPS foam and then covered in fiberglass mesh and coated in our modified cement coating for both strength and ease of tiling. They install easily on any 16" OC stud wall without modifications. The HYDRO-BLOK Shower Caddy also provides a quick way to add a small storage shelf to any shower system.

16" x 28"
RECESSED
SHOWER NICHE
HBRSN1628

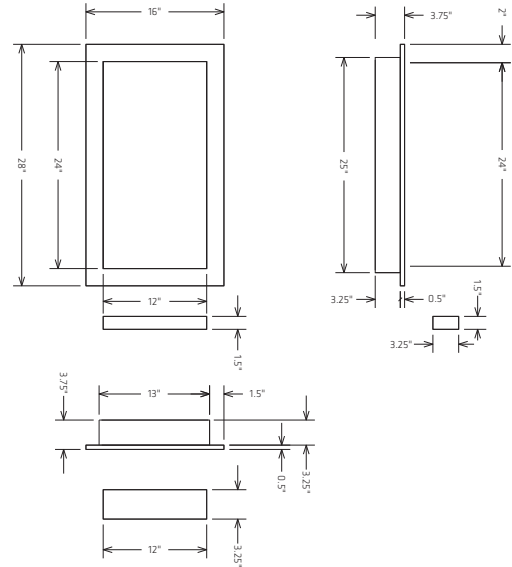
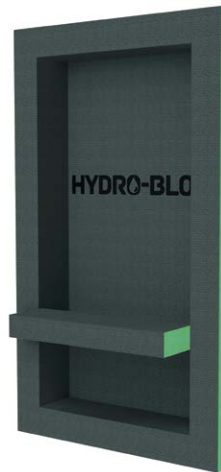

32" x 16"
RECESSED
DOUBLE WIDE
NICHE
HBRDWSN3216

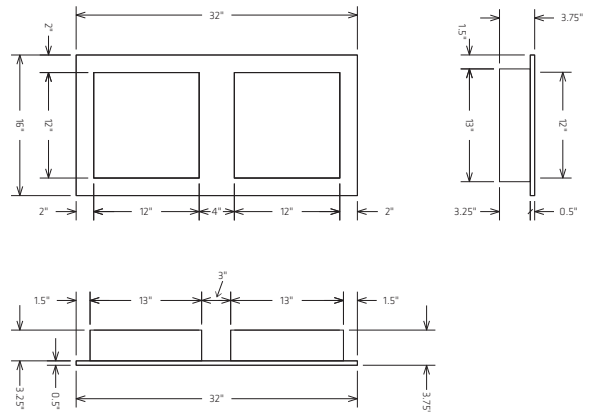
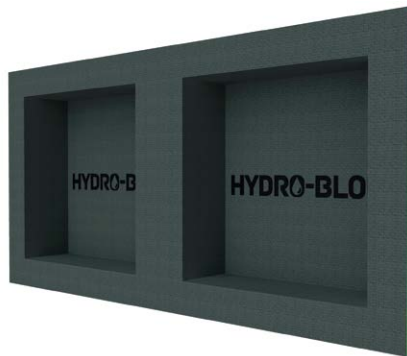

16" x 16"
RECESSED
SHOWER NICHE
HBRSN1616

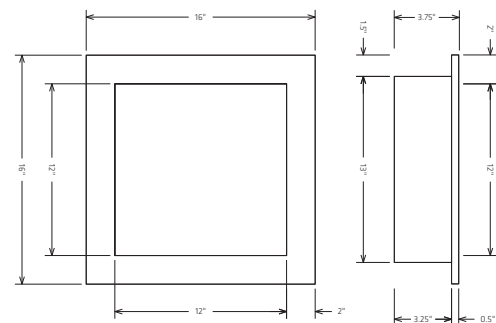
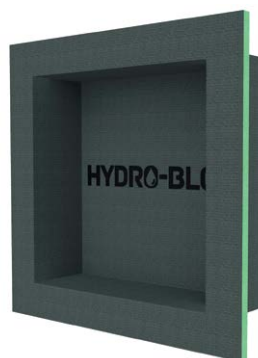

32" X 26"
RECESSED
DOUBLE ARCH
SHOWER NICHE
HBRDASN1616

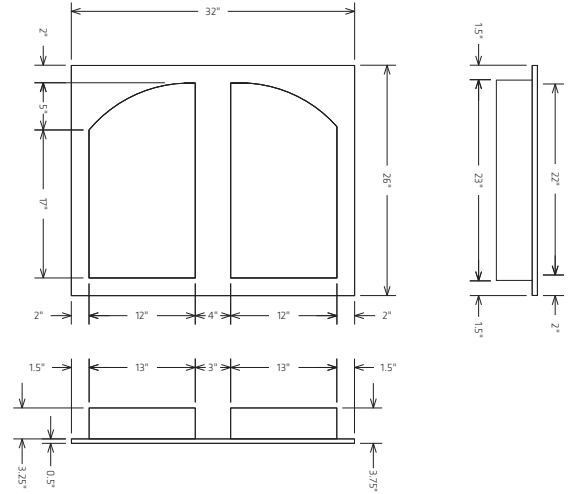
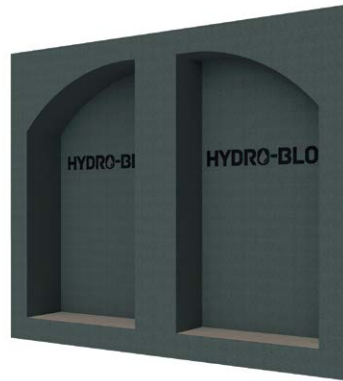

16" X 22"
RECESSED
BARREL HEAD
SHOWER NICHE
HBRBHSN1622

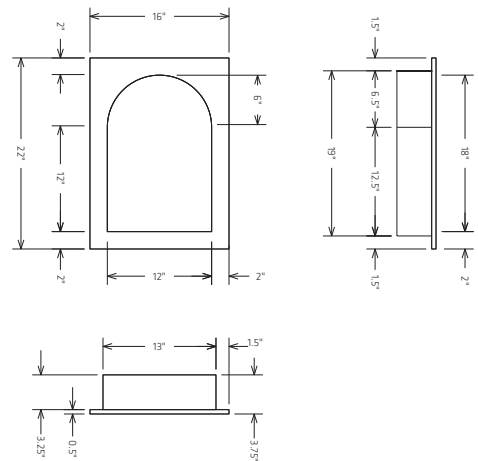

DIAMOND
SHAMPOO
CADDY
8" X 8" X 11"
HBDSC

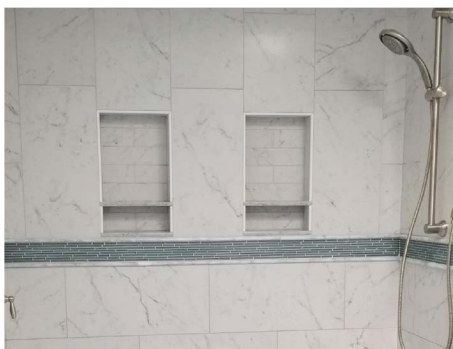
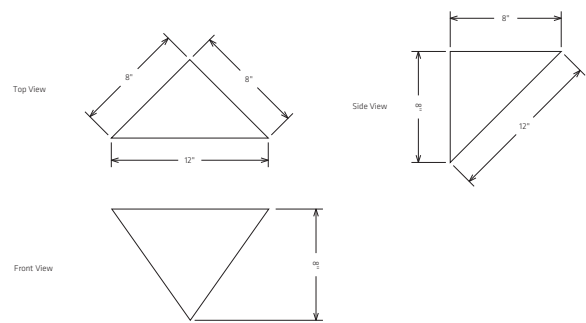

SYSTEM ACCESSORIES & PARTS

HYDRO-BLOK offers a complete lineup of system accessories and tools to help make installing your HYDRO-BLOK Shower System quick and easy. Our Joint Sealant is formulated to be the perfect adhesive/sealant for installing your shower system and is offered in both 10oz cartridges and 20oz sausages for convenience alongside our own high-quality Sausage and Cartridge guns. Our drain covers allow customizing your shower drain to match or compliment a wide variety of available shower fixtures (Stainless Steel cover is included with every shower pan).

OPTIONAL DRAIN COVERS All Classic and Low Profile Shower Pans include a Stainless Steel Drain Cover



HBDCBLACK HBDCBRASS HBDCBRONZE HBDCCHROME

Classic Shower Pan Strainer & Tray in Matte Black, Satin Brass, Bronze or Polished Chrome.

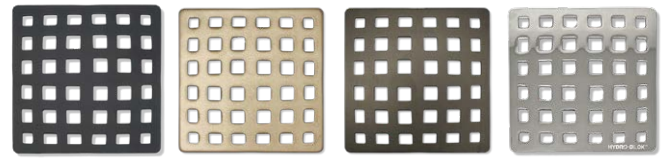

HBLPDCBLACK HBLPDCBRASS HBLPDCBRONZE HBLPDCCHROME

Low Profile Shower Pan Strainer in Matte Black, Satin Brass, Bronze or Polished Chrome

INSTALLATION SUPPLIES



HBJS CART / HBJS SAUS
HYDRO-BLOK Joint Sealant
10oz Cartridge / 20oz Sausage



HBSCREW WASHER 100
HYDRO-BLOK Screws/Washers
Combo Pack 100 pcs each



HBSCREW 1000
HYDRO-BLOK
Screws 1000 pcs



HBWASH 1000
HYDRO-BLOK
Washers 1000 pcs

INSTALLATION TOOLS



HBSAUSGUN
HYDRO-BLOK Sausage Gun



HBCARTGUN
HYDRO-BLOK Cartridge Gun



HBSAUSTIP
HYDRO-BLOK Sausage Gun Tips



HBSPK / HBCPK
Standard & Corner Putty Knives

CLASSIC PAN REPLACEMENT PARTS



HBBDK
Classic Shower Pan
Brass Drain Kit



HBDCTPR
Classic Shower Pan Drain Tray &
Strainer Kit (Stainless Steel)

LOW PROFILE PAN REPLACEMENT PARTS

- HBLPDK Low Profile Pan Drain Kit
- HBLPDFK Low Profile Pan Drain Frame Kit
- HBLPDC Low Profile Pan Drain Cover

HYDRO-BLOK SKUS

SKU	DESCRIPTION
SHOWER PANS & EXTENSIONS (DRAINS INCLUDED WITH PANS)	
HBSP3636	36" x 36" Shower Pan
HBSP3648	36" x 48" Shower Pan
HBSP3660	36" x 60" Shower Pan
HBSP3672	36" x 72" Shower Pan
HBSP36720D	36" x 72" Shower Pan - Offset Drain
HBSP4848	48" x 48" Shower Pan
HBSP4860	48" x 60" Shower Pan
HBSP4872	48" x 72" Shower Pan
HBSP4884	48" x 84" Shower Pan
HBSP6060	60" x 60" Shower Pan
HBSP6072	60" x 72" Shower Pan
HBSP6084	60" x 84" Shower Pan
HBSP7272	72" x 72" Shower Pan
HBSP1272	12" x 72" Pan Extension
HBSP2448	24" x 48" Pan Extension
HBSPCE3636	36" x 36" Corner Pan Extension
LOW PROFILE SHOWER PANS & EXTENSIONS (DRAINS INCLUDED WITH PANS)	
HBLPSP3636	36" x 36" LOW PROFILE Shower Pan
HBLPSP3648	36" x 48" LOW PROFILE Shower Pan
HBLPSP3660	36" x 60" LOW PROFILE Shower Pan
HBLPSP3672	36" x 72" LOW PROFILE Shower Pan
HBLPSP36720D	36" x 72" LOW PROFILE Shower Pan - Offset Drain
HBLPSP4848	48" x 48" LOW PROFILE Shower Pan
HBLPSP4860	48" x 60" LOW PROFILE Shower Pan
HBLPSP4872	48" x 72" LOW PROFILE Shower Pan
HBLPSP4884	48" x 84" LOW PROFILE Shower Pan
HBLPSP6060	60" x 60" LOW PROFILE Shower Pan
HBLPSP6072	60" x 72" LOW PROFILE Shower Pan
HBLPSP6084	60" x 84" LOW PROFILE Shower Pan
HBLPSP7272	72" x 72" LOW PROFILE Shower Pan
HBLPSPE1272	12" x 72" LOW PROFILE Pan Extension
HBLPSPE2448	24" x 48" LOW PROFILE Pan Extension
SINGLE SLOPE SHOWER PANS & EXTENSIONS (FOR USE WITH LINE DRAIN)	
HBSSSP3660	Single Slope 36" x 60" Shower Pan
HBSSSP4872	Single Slope 48" x 72" Shower Pan
HBSSSP6036	Single Slope 60" x 36" Shower Pan
HBSSSP7248	Single Slope 72" x 48" Shower Pan
HBSSSPE1872	Single Slope 18" x 72" Side Extension
HBSSSPE7212	Single Slope 72" x 12" Pan Extension
HBTSSSP3660	THIN Single Slope 36" x 60" Shower Pan
HBTSSSP4872	THIN Single Slope 48" x 72" Shower Pan
HBTSSSP6036	THIN Single Slope 60" x 36" Shower Pan
HBTSSSP7248	THIN Single Slope 72" x 48" Shower Pan
HBTSSSPE7212	THIN Single Slope 72" x 12" Pan Extension
LINEAR DRAIN & ACCESSORIES	
HBLD73	73½" Line Drain Kit
HBFLJCK	24 sq ft Floor Lowering Joist Clip Kit
HBINSHADOW	IN-Shadow Trim
HBINSI38	3/8" IN-Sight Trim
HBINSI14	1/4" IN-Sight Trim
HBINSI12	1/2" IN-Sight Trim
HBLDAFT38	3/8" Access Tray & Trim (comes w/line drain)
HBLDAFT14	1/4" Access Tray & Trim
HBLDAFT12	1/2" Access Tray & Trim
HBLDCOUP	Drain Body Coupler
HBLDSLTEXT	Slot Extender Stick

SKU	DESCRIPTION
SHOWER CURBS & RAMP	
HBSC312460	Standard Curb 60" x 3½" x 4"
HBSC312496	Standard Curb 96" x 3½" x 4"
HBSCM60	MINI Curb 60" x 2" x 2½"
HBSCM84	MINI Curb 84" x 2" x 2½"
HBRS1272	Shower Ramp 12" x 72"
HBLPSR1072	LOW PROFILE Shower Ramp 10" x 72"
WALLBOARD & BUILDING BOARD	
HBWB366014	36" x 60" x ¼" Wallboard
HBWB366012	36" x 60" x ½" Wallboard
HBWB486412	48" x 64" x ½" Wallboard
HBWB489614	4' x 8' x ½" Wallboard
HBWB366058	36" x 60" x 5/8" Wallboard
HBWB36601	36" x 60" x 1" Wallboard
HBWB2548112	25" x 48" x 1½" Wallboard
HBWB3648112	3' x 4' x 1½" Wallboard
HBWB48602	48" x 60" x 2" Wallboard
NICHES & SHOWER CADDY	
HBDS	Diamond Shampoo Caddy 8" x 8"
HBRSN1616	16" x 16" Recessed Niche
HBRSN1628	16" x 28" Recessed Niche
HBRSN1622	16" x 22" Recessed Barrel Head Niche
HBDRWSN3216	32" x 16" Recessed Double Wide Niche
HBDRASN3226	32" x 26" Recessed Double Arch Niche
SHOWER BENCHES	
HBDBM	Diamond Bench Medium 17" x 17"
HBDBL	Diamond Bench Large 22" x 22"
HBDBM	Suspended Bench Medium 17" x 17"
HBDBL	Suspended Bench Large 22" x 22"
SUPPLIES, TOOLS & ACCESSORIES	
HBJSCART	Joint Sealant Cartridges 10 oz.
HBJSSAUS	Joint Sealant Sausages 20 oz.
HBCARTGUN	Cartridge Gun
HBSAUSGUN	Sausage Gun (w/3 tips)
HBSAUSTIP	Sausage Gun Replacement Tip
HBSCREWWASHER100	Screws and Washers (100ct)
HBSCREW1000	Screws (1,000 per bucket)
HBWASH1000	Washers with tabs (1,000/bucket)
HBCPK	Corner Putty Knife
HBSPK	Standard Putty Knife
HBBDK	Brass Drain Kit (replacement)
HBDCPTR	Brushed Stainless Drain Cover & Tray (replacement)
HBDCBLACK	Matte Black Drain Cover & Tray
HBDCBRONZE	Bronze Drain Cover & Tray
HBDCCHROME	Polished Chrome Drain Cover & Tray
HBDCBRASS	Satin Brass Drain Cover & Tray
HBLPDK	LOW PROFILE Drain Kit (replacement)
HBLPDFK	LOW PROFILE Drain Frame Kit (replacement)
HBLPDC	LOW PROFILE Drain Cover (replacement)
HBLPDCBLACK	LOW PROFILE Matte Black Drain Cover
HBLPDCBRONZE	LOW PROFILE Bronze Drain Cover
HBLPDCCHROME	LOW PROFILE Polished Chrome Drain Cover
HBLPDCBRASS	LOW PROFILE Satin Brass Drain Cover

Some SKUs may not be available in all regions. Visit us online at www.HYDROBLOK.com for the most up-to-date list of HYDRO-BLOK products and accessories.

HYDRO-BLOK®

The BETTER Shower System

EASILY INSTALLED and
ready for **STONE** or **TILE**
in only a **FEW HOURS**



RESIDENTIAL & COMMERCIAL

Homeowner, contractor or architect, the HYDRO-BLOK system is cost-effective and easy to learn and install, making it the perfect choice for your next project. Add features such as shower benches, niches and custom designs to your shower with ease and within your budget.

Easy customization, lower costs, and faster installation combined with sophisticated & modern features like the HYDRO-BLOK Linear Drain make HYDRO-BLOK the perfect partner for your next multi-unit residential or hospitality project. Custom manufacturing is available on request.

Visit us online for residential, commercial and hospitality project examples. For technical assistance specifying or quoting any project, please contact your local HYDRO-BLOK sales representative.

Demos and complete instructions at
www.YouTube.com/HYDROBLOK



Your local HYDRO-BLOK dealer is:



HYDROBLOK GRAND INTERNATIONAL LTD.

www.hydroblok.com

info@hydroblok.com

Toll Free: 1 844 588 9559

To contact any of our worldwide distributors, please visit our website or contact us via our toll-free number.