

ARES Plus RT ODIN Plus (Harsh)

The best online protection for all types of IT cabinets



Small offices



Commercial



Networking



Healthcare



Industry



CCTV alarm



1000VA ~ 3000VA

Thanks to its reduced depth, Odin Plus is perfect for short IT cabinets. While Ares RT Plus fits best where the available height is limited.

Features

- Online double conversion
- Wide input voltage range to improve battery life
- Convertible rack/tower with rotating LCD
- Power Factor 0.9 adapted to the majority of the loads
- Battery autonomy on display based on battery capacity and quantity
- Small size - can fit 500mm deep cabinets
- Simplified service: same spares of tower model
- Programmable outlets
- EPO, USB, Comm. Slot and RS232 port
- Battery deep discharge protection

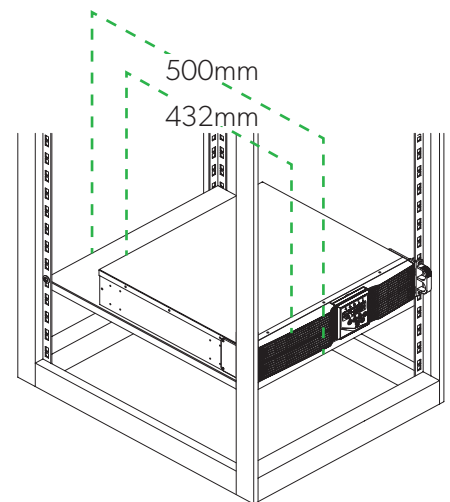

Options

- CEI 0-16 compliant version
- Version with internal extra charger
- ODIN3000 Plus version with 8 batteries
- USB card, dry contact relay card, SNMP/web card
- External bypass switch
- External socket

What's in the Box

- AR1000RT Plus/ODIN1000 Plus:
1 x input power cable
+ 1 x output power cable
- AR2000-3000RT Plus/
ODIN2000-3000 Plus:
1 x input power cable
+ 2 x output power cable

Discover More



Technical Specifications

Model		AR Plus 1000RT	AR Plus 2000RT	AR Plus 3000RT	ODIN Plus 1000/ ODIN Plus 1000H	ODIN Plus 2000/ ODIN Plus 2000H	ODIN Plus 3000/ ODIN Plus 3000H	
Input	Voltage*	110~300Vac						
	Frequency	45~66Hz (Auto sensing)						
	Phase	Single Phase						
	Power Factor	>0.99 @ 100% linear load						
Output	Capacity*	1000VA/900W	2000VA/1800W	3000VA/2700W	1000VA/900W	2000VA/1800W	3000VA/2700W	
	Voltage	200/208/220/230/240 Vac						
	Power factor	0.9						
	THDv	<3% @ 100% Linear load <7% @ 100% non-linear load						
	Voltage regulation	1%						
	Frequency range	±1Hz or ±3Hz (selectable)						
	Crest factor	3:1						
	Output waveform	Pure sinewave						
	Output outlets	3x IEC C13	6x IEC C13	6x IEC C13 + 1x IEC C19	3x IEC C13	6x IEC C13	6x IEC C13 + 1x IEC C19	
	Efficiency	Online Mode	Up to 91%					
ECO Mode		Up to 97%						
Physical	Dimensions (WxHxD, mm)	440x88x405	440x88x600	440x88x600	440x88x405	440x132x432	440x176x432	
	Net Weight (kg)	11.7	21.8	24.6	11.7	23	25	
Battery	Number	3	6	6	3	6	6	
	Voltage	36	72	72	36	72	72	
	Type	Sealed maintenance free lead acid 12Vdc						
	Recharge Time (to 90%)	4 hours						
	Empty Battery Bank	Code	BC060000-0000	BC120000-0000		BC060000-0000	BC120722-0000	
		Max. Quantities	6	12	12	6	12	12
Dimension (WxHxD, mm)		440x88x430	440x88x581		440x88x430	440x176x430		
Display	LCD measures	Voltage/Frequency/Load level/Battery level/Output current/Estimated						
	Self-Diagnostics	Upon power-on, front panel setting & software control, 24-hour routine checking						
Alarm	Audible or Visual	Line failure/Battery low/Transfer to bypass/System fault						
Protection	Full Protection	Overload, over temperature, short circuit, discharge, overcharge						
Environment	Operation Temperature	0~40°C						
	Operation Humidity	0%~90% (without condensing)						
	Altitude	1000m without derating						
	Noise Level	≤50dBA @ 1 metre front						
Interface	Type	RS232, EPO, USB and Comm. Slot						
	Communication slots	Dry contact card, SNMP/Web card, RS485 card						
	Compatible platforms	Microsoft Windows series, Linux, Mac						
Standards & Certifications	Safety & EMC	IEC EN 62040-1, IEC EN 62040-2						
	Performance	IEC EN 62040-3						
	Marks	CE						

Back Panels

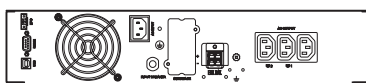

AR Plus 1000RT

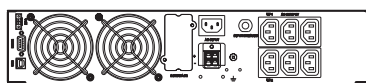

AR Plus 2000RT

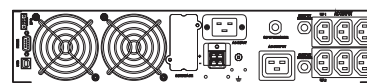

AR Plus 3000RT

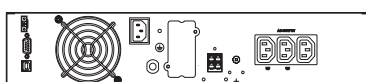

ODIN Plus 1000/ODIN Plus 1000 Harsh

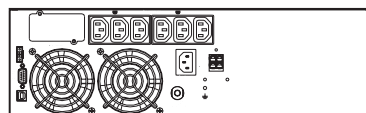

ODIN Plus 2000/ODIN Plus 2000 Harsh

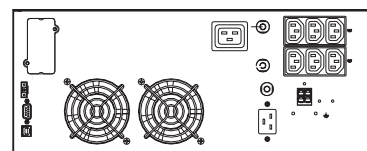

ODIN Plus 3000/ODIN Plus 3000 Harsh

Specifications subject to change without notice

* Based on load percentage

Discover More

