

VivaLIFT![®]

POWER RECLINERS

By Pride[®] Mobility Products Corp.

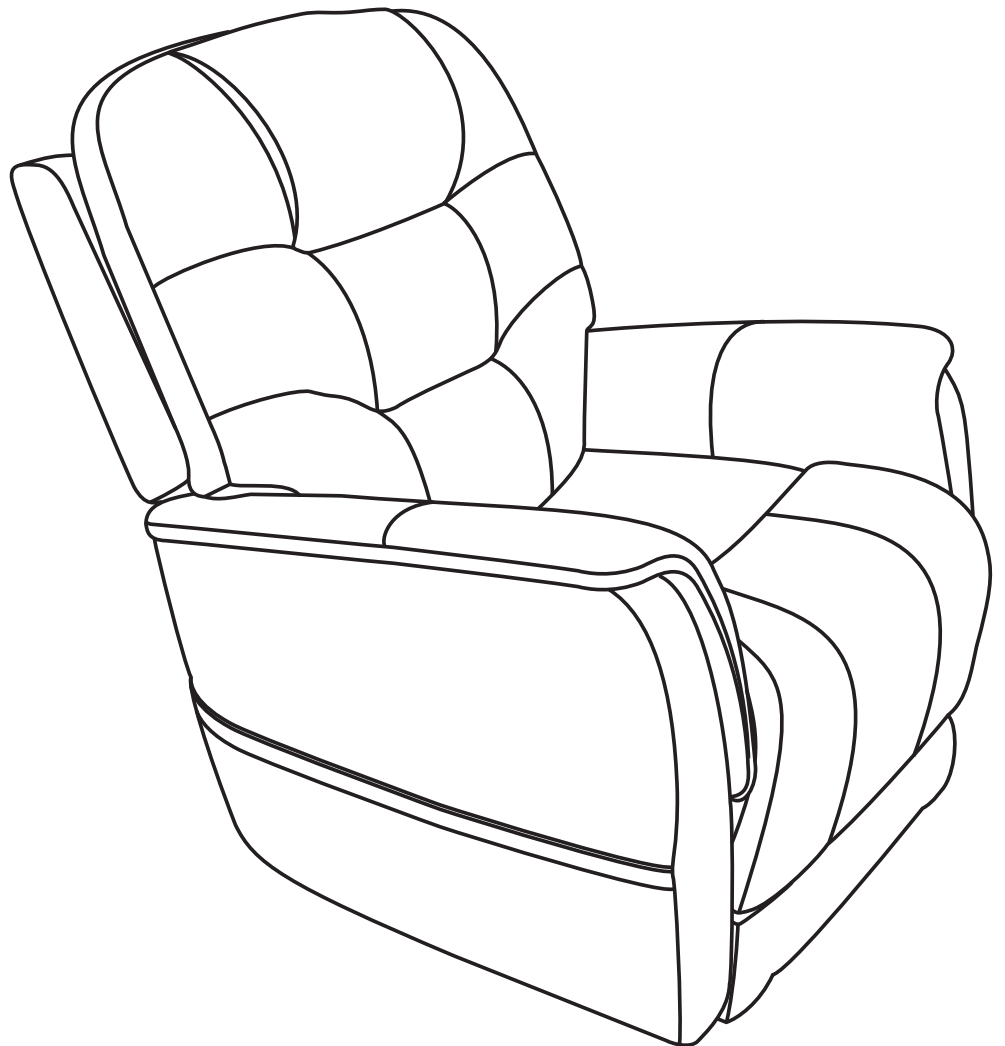

Included in this document: Hand Control Reference Guide, Fabric Care, Chair Assembly and Setup, Warranty, and Weight Capacity

NOTE: This quick reference guide offers basic hand control functions, general care instructions, basic assembly information, warranty information, and weight capacity information for your chair. Before operating the chair, thoroughly read the owner's manual and all other supplemental documents for information on safety, basic operation, and care and maintenance.

The illustrations reflect those hand controls with the highest level of functionality. The hand control you receive may have fewer options, but basic functionality is the same.

The premier feature of the VivaLIFT!® Power Recliner is that you have the ability to adjust your feet and back independently to achieve your perfect position. For example, the seatback can recline until it is horizontal to the floor. To achieve this, press and hold button "8" (as shown in **figure 1**) until it is fully reclined.

HAND CONTROL IDENTIFICATION KEY

1. USB PORT

Use to connect to/charge USB enabled devices.



WARNING! ONLY MFI-certified cables MUST be used when charging iPhone devices. Use of any non MFI-certified cable may result in damage to the device or charging system.

2. HEADREST IN BUTTON

Press and hold to move headrest in.

3. HEADREST OUT BUTTON

Press and hold to move headrest out.

4. LUMBAR SUPPORT IN BUTTON

Press and hold to move lumbar support in.

5. LUMBAR SUPPORT OUT BUTTON

Press and hold to move lumbar support out.

6. UP BUTTON

Press and hold to return all chair power options to the neutral position, while lifting you into an upright position.

7. DOWN BUTTON

Press and hold to lower chair to seated or reclined position.

8. SEATBACK RECLINE BUTTON

Press and hold to recline the seatback.

9. SEATBACK INCLINE BUTTON

Press and hold to raise the seatback.

10. LEG REST UP BUTTON

Press and hold to raise the leg rest.

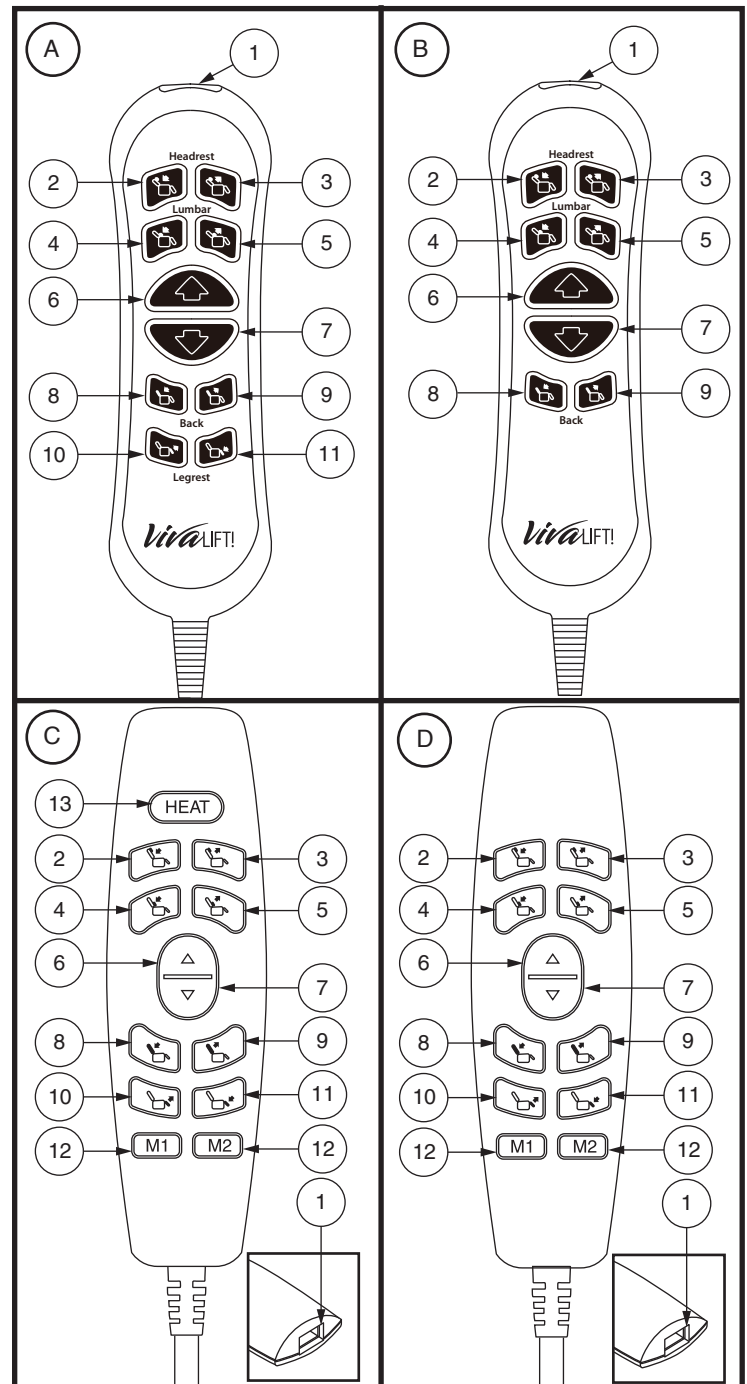

Figure 1. Hand Controls

11. LEG REST DOWN BUTTON

Press and hold to lower the leg rest.

12. MEMORY BUTTONS (HAND CONTROL C ONLY)

Press and hold Memory Button 1 and Memory Button 2. The LEDs on the memory buttons will flash to indicate that the hand control is in “set” mode. Press and hold the desired memory button to set the memory position. The LEDs will stop flashing. To go to a preset memory position, press and hold the desired memory button.

13. HEAT CONTROL BUTTON (HAND CONTROL C ONLY)

Press the heat button to activate the heat function. Press the HEAT button again to cycle intensity through LOW, HIGH and OFF.

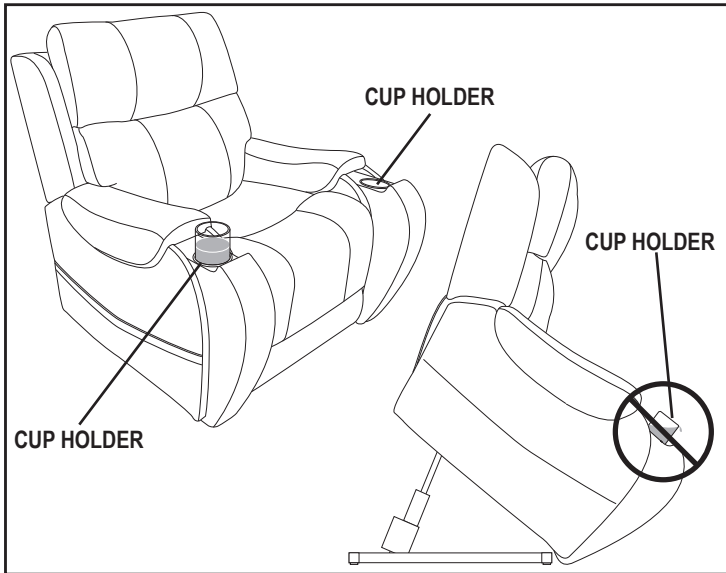

Figure 2. Cup Holder

Follow these steps to properly stand up from your chair:

1. Activate and hold the UP button (switch) to raise your chair.
2. Release the button (switch) when the chair reaches a height where you can stand up comfortably.

WARNING! Do not attempt to stand up until you can stand safely, are steady on your feet, and can bear weight. Pride recommends the use of assistance aids and/or an attendant for enhanced stability.



WARNING! Avoid putting all of your weight on the chair armrests when attempting to stand and do not use the armrests for weight bearing purposes.

If your chair is equipped with cup holders, ensure the cup holders are empty prior to elevating your chair above a seated position to a standing position. **See figure 2.**



WARNING! Any contents in the cup holder may shift or spill when the chair is raised. Remove all contents prior to elevating your chair. Failure to remove all contents from the cup holders prior to elevating your chair above a seated position may result in personal injury or property damage.

WARNING! NEVER place lit tobacco products in the cup holders or attempt to use the cup holders as an ashtray.

FABRIC CARE INSTRUCTIONS

NOTE: Refer to the Care and Maintenance section of the owner's supplied with your chair for complete fabric care, electronics care, and disposal and recycling information.

CHAIR ASSEMBLY AND SETUP

1

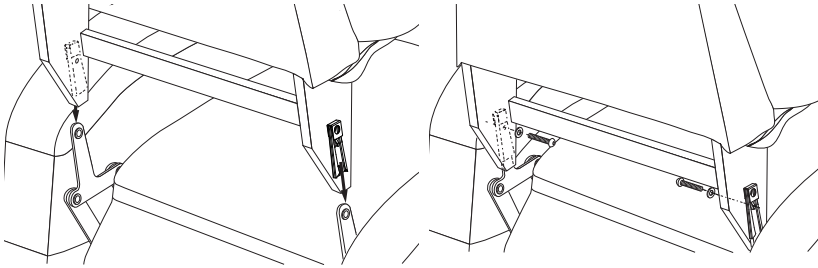

Unpack the chair. Place the hand control on the chair base.

Lay the chair back, face down, on the chair base and route all cables through the wire access point as shown.

2

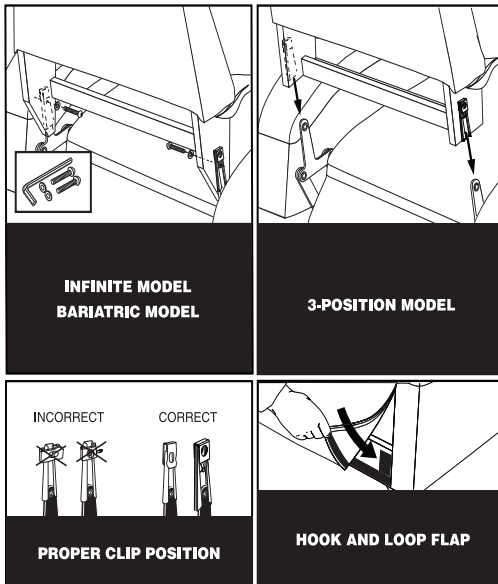
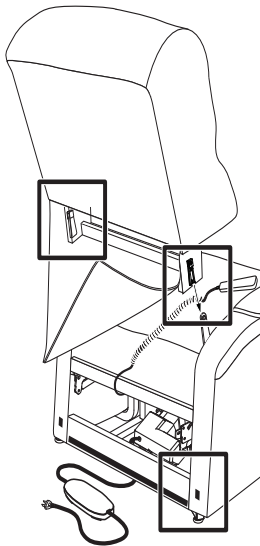

NOTE: If your chair is an Infinite model, refer to the assembly instructions provided with the chair. For the 2-position model, the KD sleeves are located on the inside.

1. Check that the locking clip on the back of the chair is in the vertical position. Reposition if necessary.
2. Drape the hand control and cable over the chair base, then slide the back onto the base. Ensure the hand control cable is routed through the rear of the chair.

NOTE: Depending on chair width, you may need to slide on one side of the back at a time. If this is the case, level the chair-back before pressing down to lock into position.

3. Push firmly on the top of the back to lock into position. You must hear a click from each side of the chair to ensure the back is locked in properly.

NOTE: Pull up on the chair-back to ensure that it is locked in place.

4. Plug in the lumbar and headrest connectors. If your model is Headrest Only, you only need to plug in the Headrest.

3

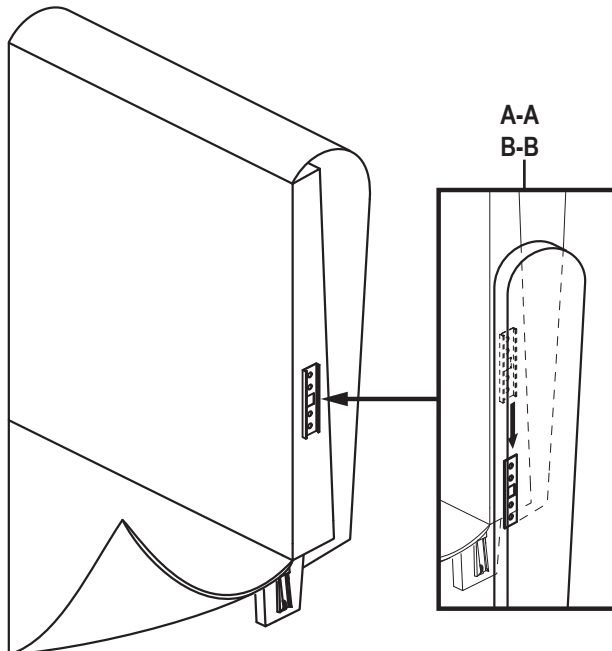

1. If your model has back wings, align the KD sleeves, and slide the wing down into place. Please note there is a label on the brackets. Please assemble them as indicated (A-A and B-B).
2. Connect the power transformer cable to the corresponding plug coming from the back of the chair.
3. Connect the power cord into the power transformer.
4. Connect the power cord into an electrical outlet near where the chair will be used.

4

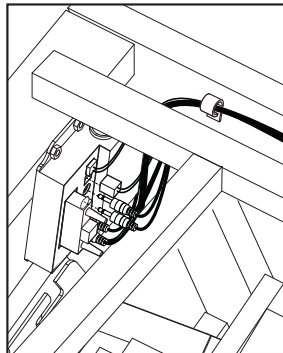
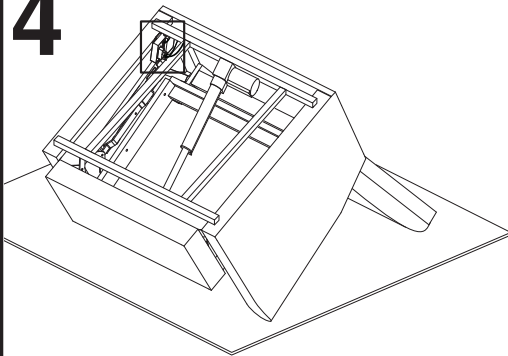

With the chair upside down, locate the junction box in the back corner. Carefully pull the cables, taking up slack, and plug in the three small cables first. Ensure all of the cables are run along the chair base frame and not through the mechanism, and secure wires in clips along the inside chair frame.

5

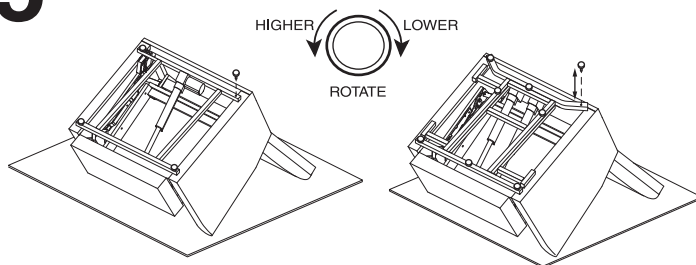

With the chair upside down, insert the leg levelers if not pre-installed, and tighten each leveler evenly. Return the chair to the upright position. If your chair is rocking, adjust the levelers as necessary (tighten to lower or loosen to raise) until the chair is stable.

NOTE: Depending on your kit and chair model, you may have four leg levelers or eight leg levelers.

NOTE: Leg levelers will NOT be pre-installed on chair model PLR3955LT only. For all other models, the leg levelers are installed and will only need adjustment prior to use.

6

Identification Key

1. Control box

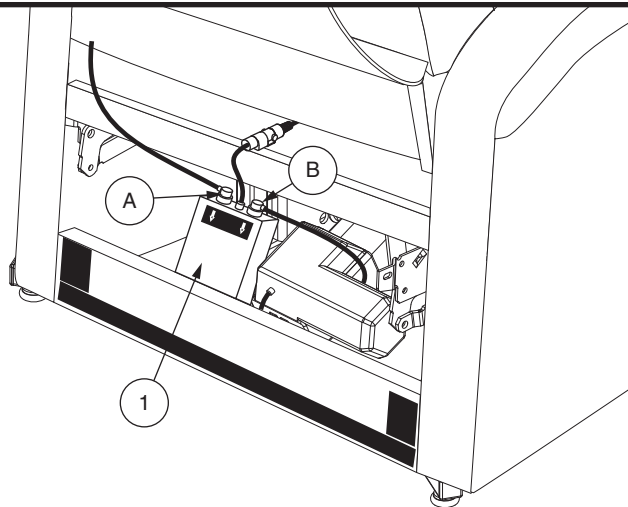

For chairs equipped with a control box, plug the cable marked “A” into the control box’s “A” port, and the cable marked “B” into the control box’s “B” port. Plug the controller cable into the center wire connector.

7

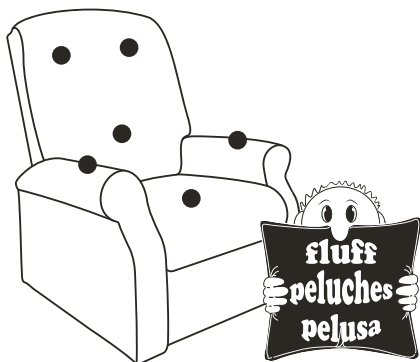

TIP: To ensure quality delivery of your new chair, we have developed a customized packaging system to guard against possible damage that may occur during the transportation and handling of your product. As a result, the packaging components used to protect the product could cause the fibers in the cushioning to appear misshaped upon unpacking. In the event that you experience this, we recommend that you “fluff” the chair cushions to allow air into the cushion fibers. This process will return the cushions to their original shape.

8

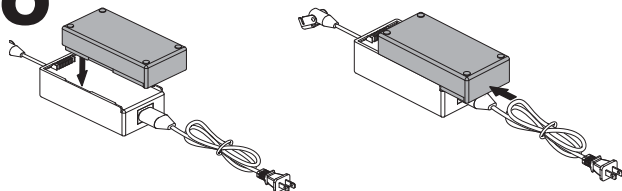

LITHIUM-ION BATTERY PACK INSTALLATION

Your chair is equipped with a lithium-ion battery backup system. Ensure that it is correctly installed onto the external transformer.

NOTE: Fully charge the lithium-ion battery pack prior to first use. The battery pack is fully charged when the LED indicator on the battery pack is green.

9

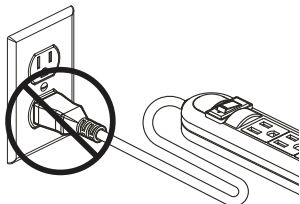
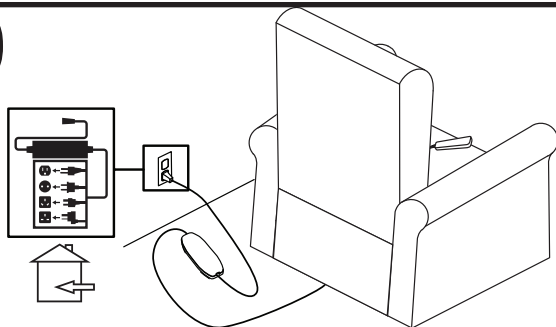

Plug the power cord leading from the external transformer directly into a standard electrical outlet. Route the power cord through the back of the chair. Do not use an extension cord.



WARNING! Do not connect an extension cord to the AC/DC converter or the battery charger. A UL Listed or UL Recognized single outlet plug-style surge protector with a minimum of 1000 joules of protection may be used. The surge protector **MUST** be plugged directly into an electrical outlet.

LIFETIME WARRANTY

Pride offers a lifetime warranty on the lift and recline mechanisms, and chair frame. Pride warrants that the lift and recline mechanisms and chair frame on your lift chair will be free from defects under normal use and service for as long as the chair is in use by the original owner. This lifetime warranty covers the lift and recline mechanisms against metal fatigue, defective welds, and bushings.

NOTE: Pride reserves the right to replace only the part of the lift and recline mechanism, scissor(s) or chair frame that may be defective from workmanship. Misuse and/or abuse are excluded from warranty.

SEVEN-YEAR PRO-RATED LIMITED WARRANTY

For the first four (4) years from the date of purchase, Pride will repair or replace at our option to the original purchaser any of the following parts found upon examination by an authorized representative of Pride to be defective in material and/or workmanship:

- Motor
- Hand Control
- Transformer/Control Box
- Power Headrest
- Power Lumbar

For three (3) additional years, a pro-rated warranty will be made available for the following parts:

- Motor
- Hand Control
- Transformer/Control Box
- Power Headrest
- Power Lumbar

Pride will warrant these components with the following pro-rated schedule:

- **Fifth year:** 25% off suggested retail price
- **Sixth year:** 15% off suggested retail price
- **Seventh year:** 5% off suggested retail price

LITHIUM-ION BATTERY

The Lithium-Ion battery pack is covered by a twelve (12) month (1 year) warranty.

WARRANTY EXCLUSIONS

This warranty does not extend to fabric.

Pride is not responsible or obligated to pay for labor, service calls, shipping, and/or any other charges incurred for repair of the product. All transportation costs and shipping damage incurred while submitting parts for repair or replacement are the responsibility of the purchaser. Please contact your authorized Pride provider for information on the current cost associated with a service visit.

- Circumstances beyond the control of Pride
- Labor, service calls, shipping, and other charges incurred for repair of the product, unless specifically authorized, IN ADVANCE, by Pride
- Repairs and/or modifications made to any part without specific consent from Pride

Exclusions also include components with damage caused by:

- Contamination
- Abuse, misuse, accident, or negligence
- Battery fluid spillage or leakage
- Improper operation, maintenance, or storage
- Commercial use or use other than normal

IMPLIED WARRANTIES

Implied warranties, including those of merchantability and fitness for a particular purpose, are limited to one (1) year from the date of purchase and to the extent permitted by law. Any and all other implied warranties are excluded. This is the exclusive remedy. Liabilities for consequential damages under any and all warranties are excluded.

Some states do not allow limitations on how long an implied warranty lasts or do not allow the exclusion or limitation of incidental or consequential damages. The above limitation or exclusion may not apply to you.

This warranty gives you specific rights, and you may also have other rights which vary from state to state.

WEIGHT CAPACITY

*Viva*LIFT!®









Your chair was developed for your convenience. Your chair has a weight capacity of 400 lbs. (181 kg). Refer to the owner's manual for any additional information concerning your chair.

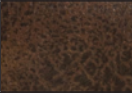
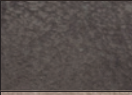

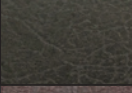
MANDATORY! Stay within the specified weight capacity of your lift chair. Exceeding the weight capacity voids your lift chair warranty.

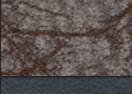





STANDARD
FABRICS

TISSUS
STANDARD

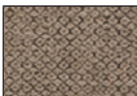
		RADIANCE	ULTRA	ATLAS PLUS / ATLAS PLUS 2	TRANQUIL / TRANQUIL 2	ELEGANCE	LEGACY	METRO	URBANA	PERFECTA 2
	Astro Brown				✓					
	Astro Grey				✓					
	Astro Mushroom				✓					
	Badlands Mushroom			✓						
	Badlands Steel			✓						
	Badlands Walnut			✓						
	Canyon Ocean	✓								
	Canyon Silt	✓								
	Canyon Steel	✓								
	Canyon Walnut	✓								
	Capriccio Slate		✓							
	Capriccio Dove		✓							
	Capriccio Cappuccino		✓							
	Capriccio Smoke		✓							

STANDARD
 FABRICS
 TISSUS
 STANDARD

	RADIANCE	ULTRA	ATLAS PLUS / ATLAS PLUS 2	TRANQUIL / TRANQUIL 2	ELEGANCE	LEGACY	METRO	URBANA	PERFECTA 2
--	----------	-------	---------------------------	-----------------------	----------	--------	-------	--------	------------

	Merino Fawn				✓				✓
	Merino Steel				✓				✓
	Saville Brown				✓	✓	✓	✓	
	Saville Grey			✓		✓	✓	✓	
	Saville Wine			✓		✓	✓	✓	
	Stonewash Granite			✓				✓	
	Stonewash Gun Metal							✓	

OPTIONAL FABRICS*
 TISSUS OPTIONNELS*

	Stonewash Granite			✓	✓				
	Stonewash Gun Metal			✓	✓				

*Note these fabrics may have extended lead-times and additional costs.

*Notez que ces tissus peuvent avoir des délais de livraison prolongés et des coûts supplémentaires

Rev J/December 2022



I N F I N I T Y B 3 8 3 4