

CanadaDocks™



Where *fun* on the water *begins!*

STANDING & FLOATING DOCK KITS



**MADE IN
CANADA**



MADE IN CANADA

You are invited to come to the waterfront, sit back and relax. CanadaDocks unique design allows you to reconfigure, expand, and accessorize your dock as your needs change. The lightweight design makes the docks incredibly easy to install and remove each season. Backed by our 25-year warranty, you will enjoy many years of maintenance-free fun on the water. Proudly MADE IN CANADA.

Where *fun* on the water *begins!*™

- 06 ABOUT US
- 08 SERVICES
- 10 STANDING DOCK KITS OVERVIEW
- 12 RAMP KITS
- 14 STANDING DOCK KITS
- 16 QUICK LINK DOCK KITS
- 18 STANDING HEXAGON DOCK KITS
- 20 CORNER KITS
- 22 TRANSITION KITS

- 26 FLOATING DOCK KITS OVERVIEW
- 28 FLOATING RAMP KITS
- 30 FLOATING DOCK KITS
- 32 FLOATING HEXAGON DOCK KITS
- 36 BOAT LIFTS
- 38 ACCESSORIES
- 50 DOCK SPECIFICATIONS
- 58 DOCK BUILDER

ABOUT US

PREMIUM DOCKS, COUNTLESS CONFIGURATIONS

Since 2006, CanadaDocks Inc. has been a leader in creating innovative products, with the only formed aluminum, bolt-together Dock Kit on the market. Our engineers are prototype specialists who have used automotive manufacturing techniques to design a system that boasts maximum strength and durability. By creating a truss out of a single sheet of marine grade aluminum, we can use less material, resulting in a dock section that is light, strong, and eco-friendly.

Our dock components are produced and packaged in Canada at our ISO 9001 certified facility, where

we maintain the highest standards of quality and workmanship. Our Dock Kits are packaged in boxes allowing easy economical transportation and shipping all over the world. An entire dock can be assembled and installed in only a few hours.

We proudly stand by the integrity of our craftsmanship and offer a 25 year warranty on all dock frames. We guarantee that our dock frames will last for generations giving you peace of mind when choosing a new dock for your waterfront property.



SERVICES

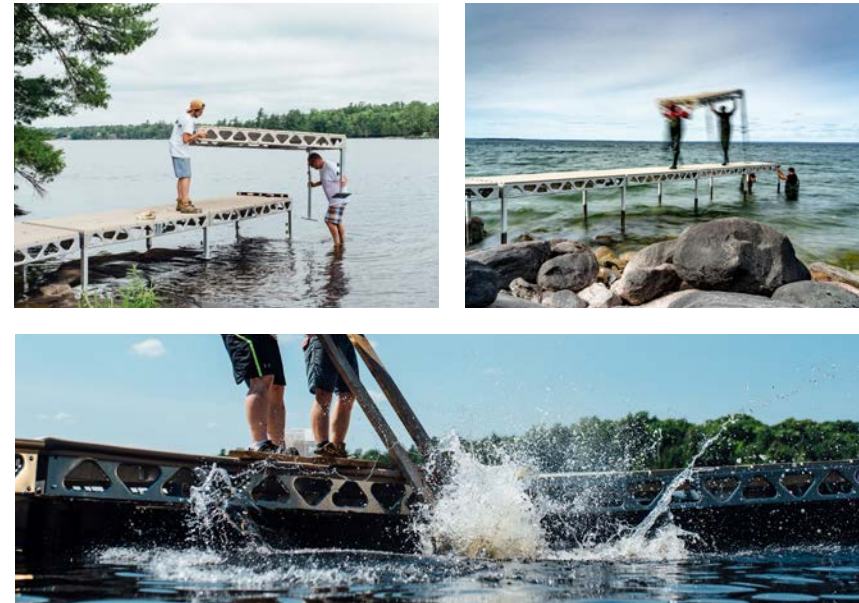

ASSEMBLY

The CanadaDocks aluminum Dock Kits are designed to be assembled by the customer. However, if you prefer you can have one of our authorized dealers assemble the dock for you.

DELIVERY

Our Dock Kits are packed and shipped in lightweight easy to handle boxes. The versatility of our dock system allows our authorized dealers to deliver our products to customers within their territory.

INSTALLATION

Our Dock Kits are designed to make installation and removal as stress-free as possible. You may find that some waterfront locations require tools and the expertise of a professional dock installer, if that's the case we have you covered. Our authorized dealers are experts in CanadaDocks products and are eager to assist with the installation and seasonal removal of your dock.

Find an authorized
CanadaDocks dealer
near you by visiting
CanadaDocks.ca/dealers



STANDING DOCK KITS



ALUMINUM CORNER BRACE

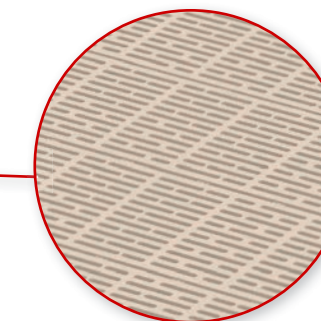

MAINTENANCE FREE DECKING

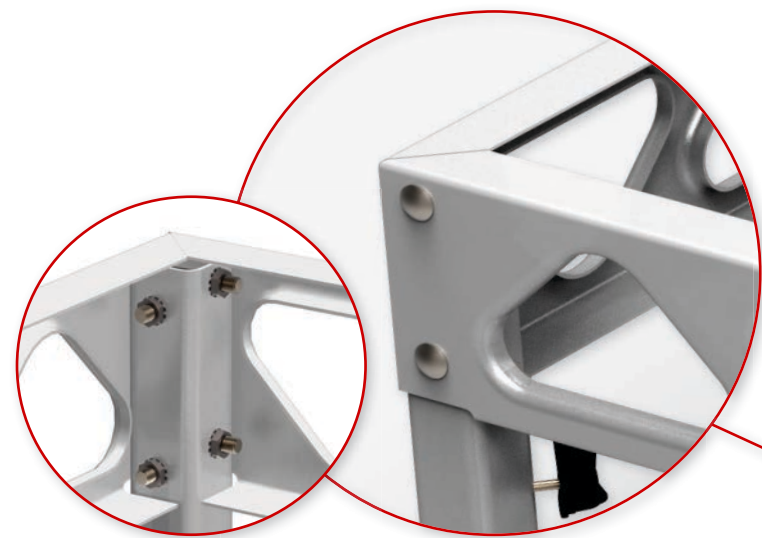

BOLT TOGETHER MARINE GRADE ALUMINUM FORMED FRAME

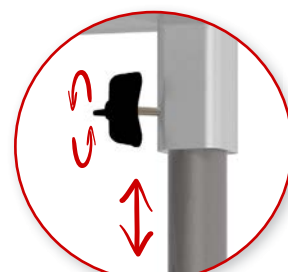

ADJUSTABLE TELESCOPIC LEGS

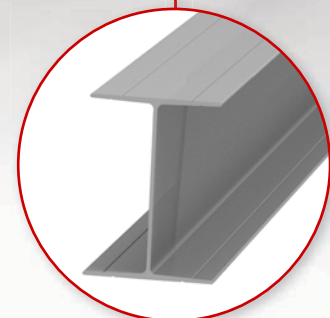

ALUMINUM I JOISTS ON 16" CENTERS



QUICK LINK CONNECTOR ALLOWS FOR EASY INSTALLATION AND REMOVAL

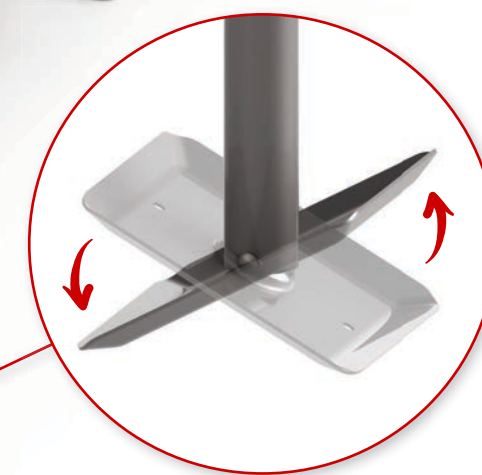

SWIVEL FOOT PAD SELF ADJUSTS TO LAKE BOTTOM

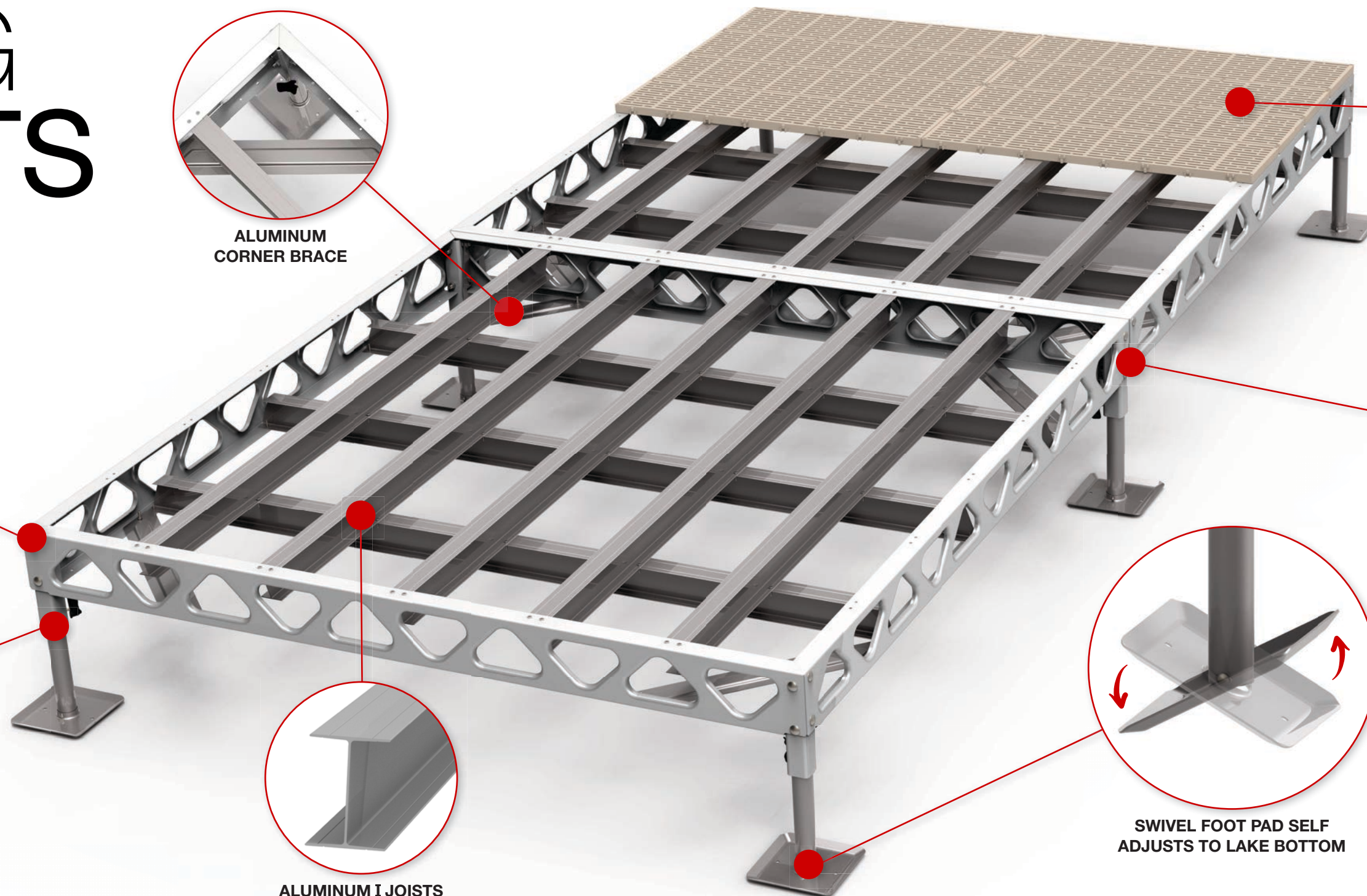

RAMP KITS

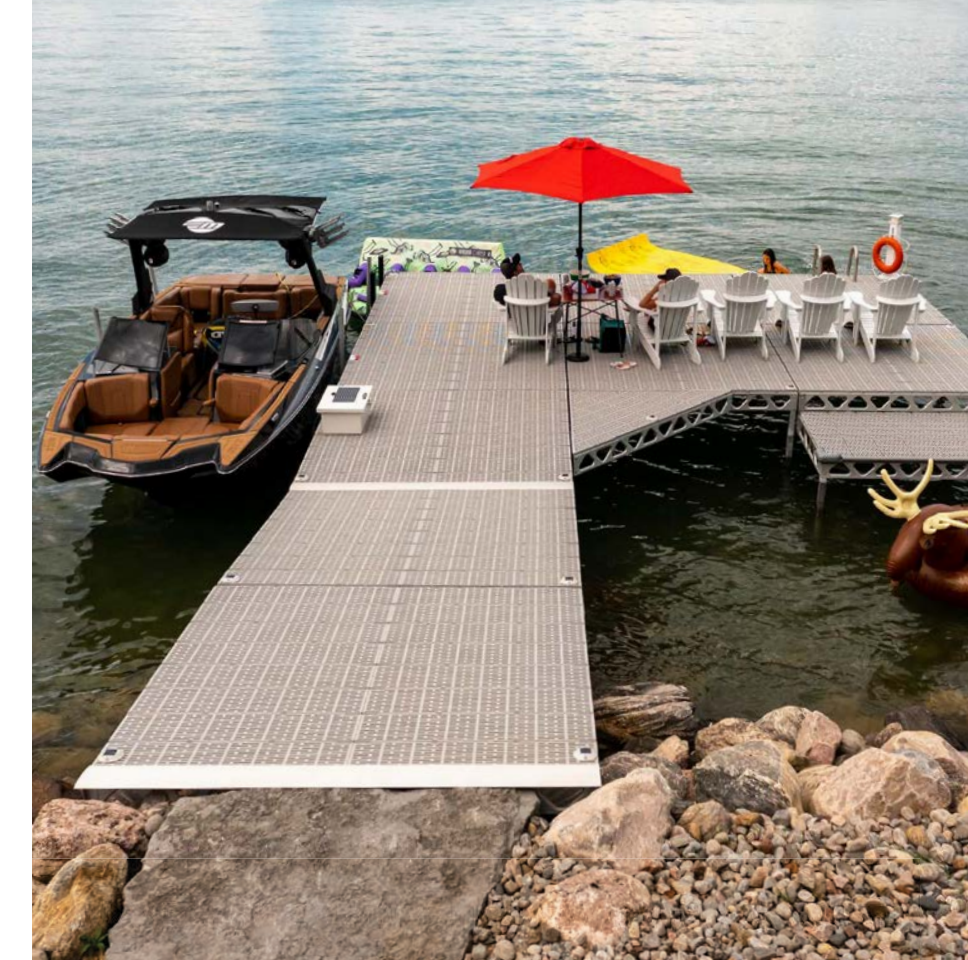
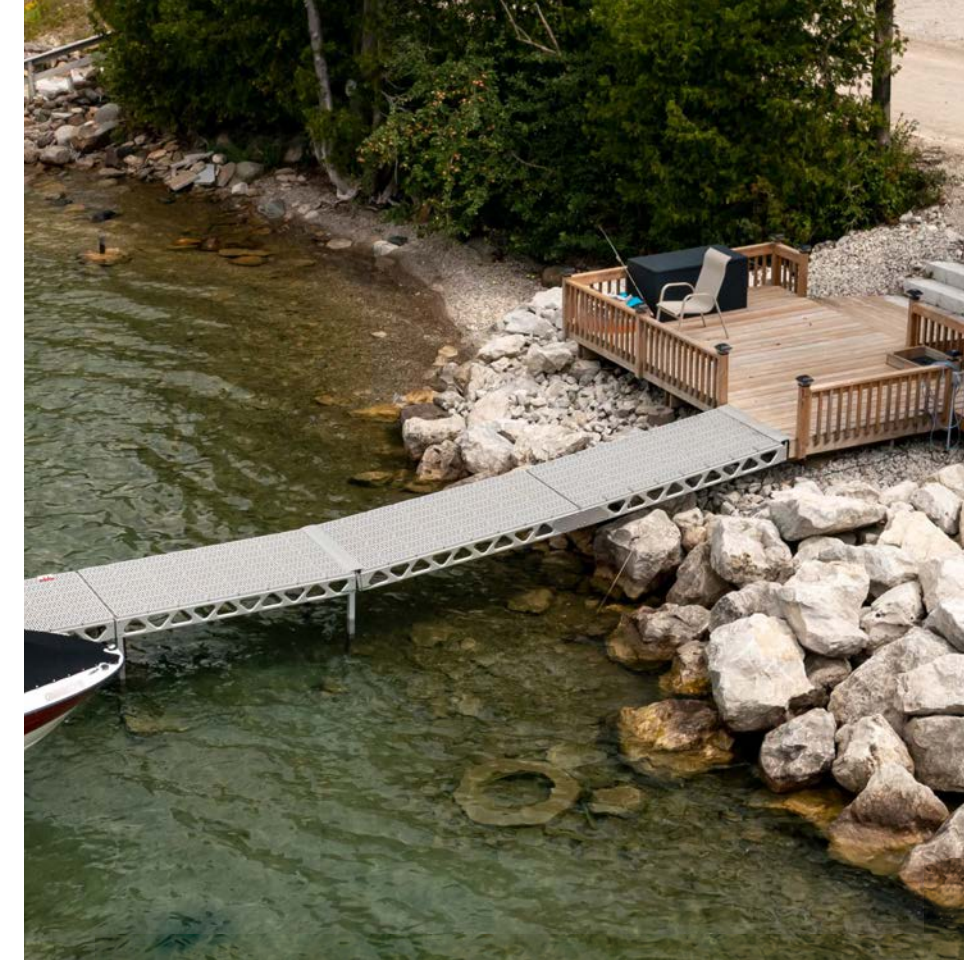

Ramps are an essential part of any dock system. Our Ramp Kits are available in 4' x 8' and 8' x 8' sizes with the ability to extend to 4' x 16' and 8' x 16' using the Ramp Connector Kit. Our Ramp Kits also include a Hinge and Hinge Cover that is used to connect your ramp to your first dock section in your system.



4' x 8' COMPLETE RAMP KIT

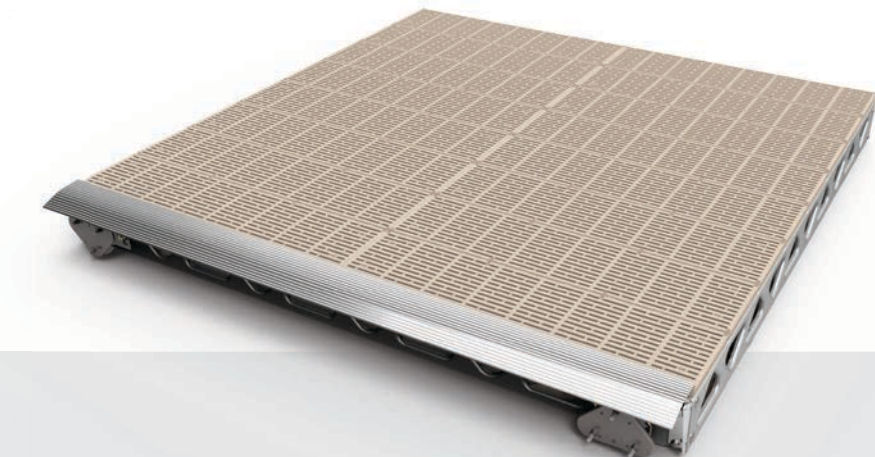

8' x 8' COMPLETE RAMP KIT

NOTABLE FEATURES



MADE IN CANADA



LIGHT WEIGHT



MAINTENANCE FREE



ALWAYS IN STOCK



QUICK ASSEMBLY



ECO FRIENDLY

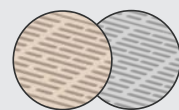

DECKING COLOUR



STANDING DOCK KITS

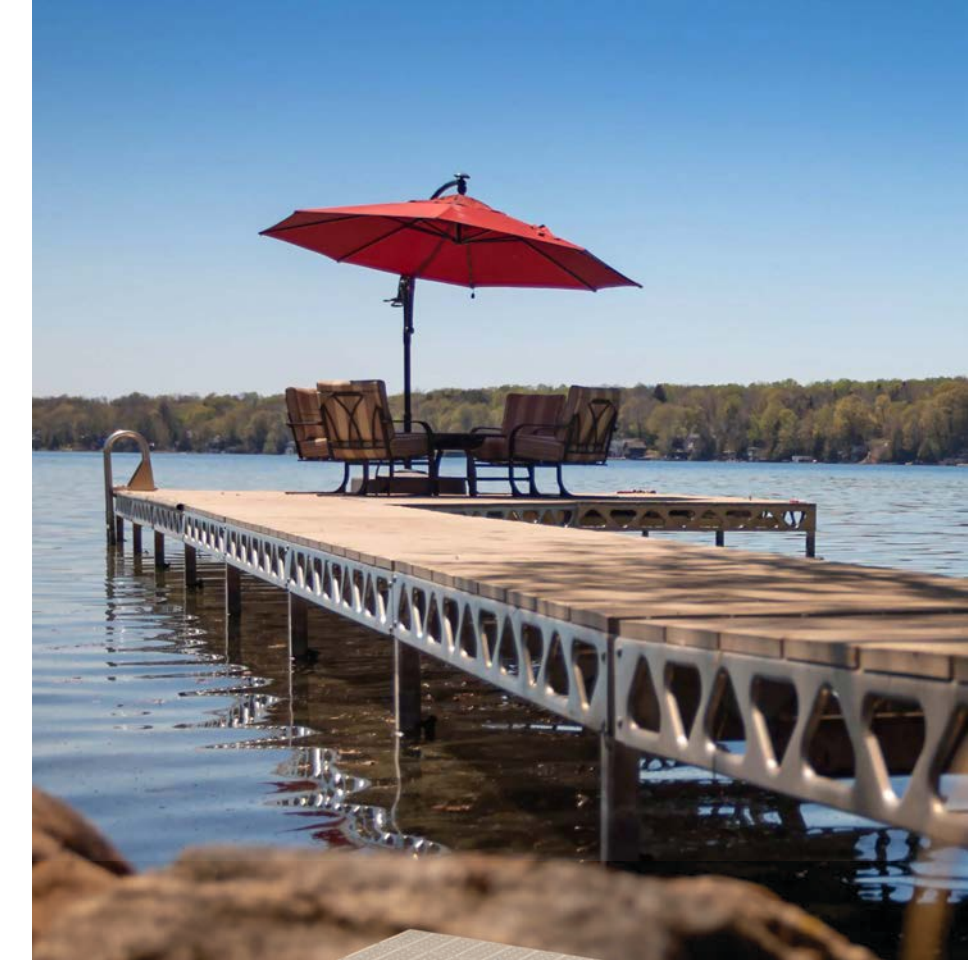
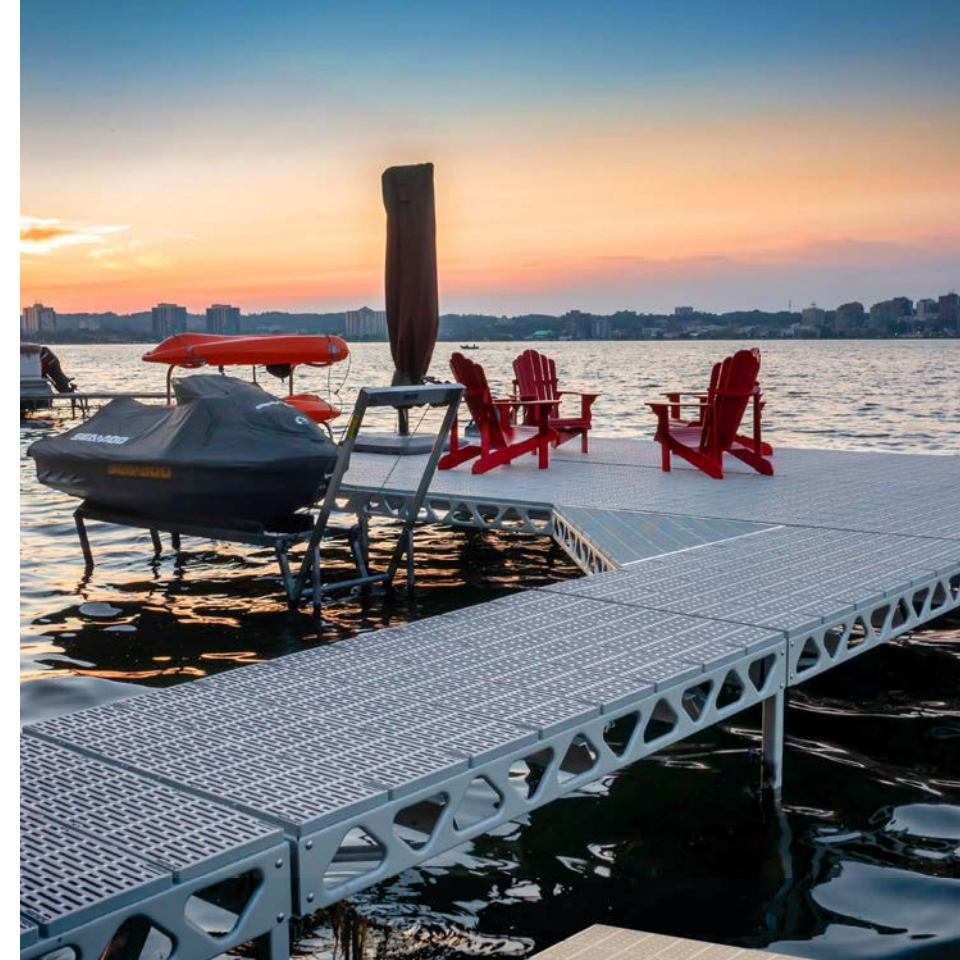

Standing Dock Kits are available with adjustable 1' - 2', 2' - 4' and 4' - 8' leg lengths. Made with CanadaDocks signature aluminum trusses and joists, this dock is lightweight, highly durable and makes a statement. Combined with the Quick Link Dock and connection system, the potential dock configurations are limitless. The modular design also enables easy seasonal installation and removal.



4' x 8' COMPLETE STANDING DOCK KIT



8' x 8' COMPLETE STANDING DOCK KIT

NOTABLE FEATURES



MADE IN CANADA



LIGHT WEIGHT



MAINTENANCE FREE



ALWAYS IN STOCK



TELESCOPIC LEGS



QUICK ASSEMBLY



ECO FRIENDLY

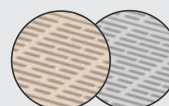

DECKING COLOUR



25 YEAR WARRANTY

QUICK LINK DOCK KITS



The name Quick Link says it all. Our unique standing dock connection system encourages creativity with your dock layout by making connecting and disconnecting sections simple. The connecting bracket and locking system (included) gives you the flexibility to change around your dock configuration to get the most out of your investment.

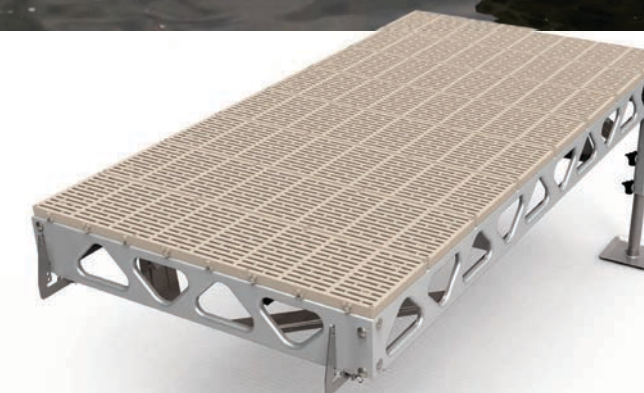

NOTABLE FEATURES



MADE IN CANADA



LIGHT WEIGHT



MAINTENANCE FREE



ALWAYS IN STOCK



TELESCOPIC LEGS



QUICK ASSEMBLY



ECO FRIENDLY

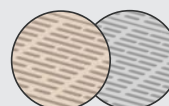

DECKING COLOUR



4' x 8' COMPLETE QUICK LINK DOCK KIT

8' x 8' COMPLETE QUICK LINK DOCK KIT

STANDING HEXAGON DOCK KITS

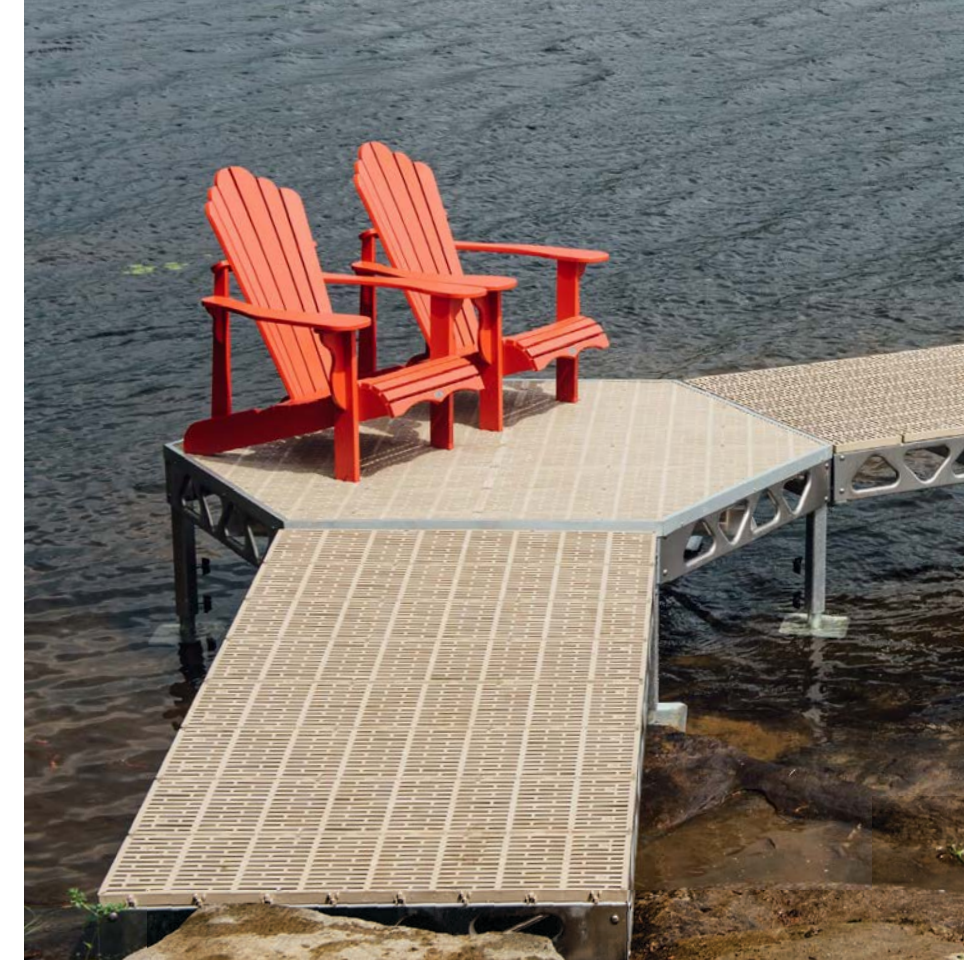

Standing Hexagon Dock Kits are designed to attach seamlessly with other CanadaDocks standing sections. The highly durable, long lasting Hexagons are available in 7' x 8' and 14' x 16' sections and are the perfect platform for relaxation. Just add a few deck chairs, and you've created a 170 sq. ft. patio on the water.



7' X 8' COMPLETE HEXAGON STANDING DOCK KIT

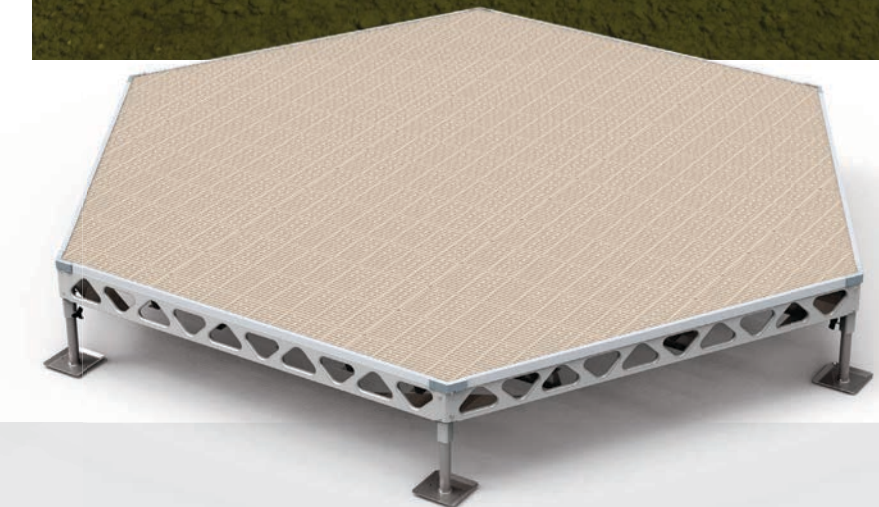

14' X 16' COMPLETE HEXAGON STANDING DOCK KIT

NOTABLE FEATURES



MADE IN CANADA



MAINTENANCE FREE



ALWAYS IN STOCK



TELESCOPIC LEGS



QUICK ASSEMBLY



ECO FRIENDLY

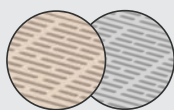

DECKING COLOUR



25 YEAR WARRANTY

CORNER KITS

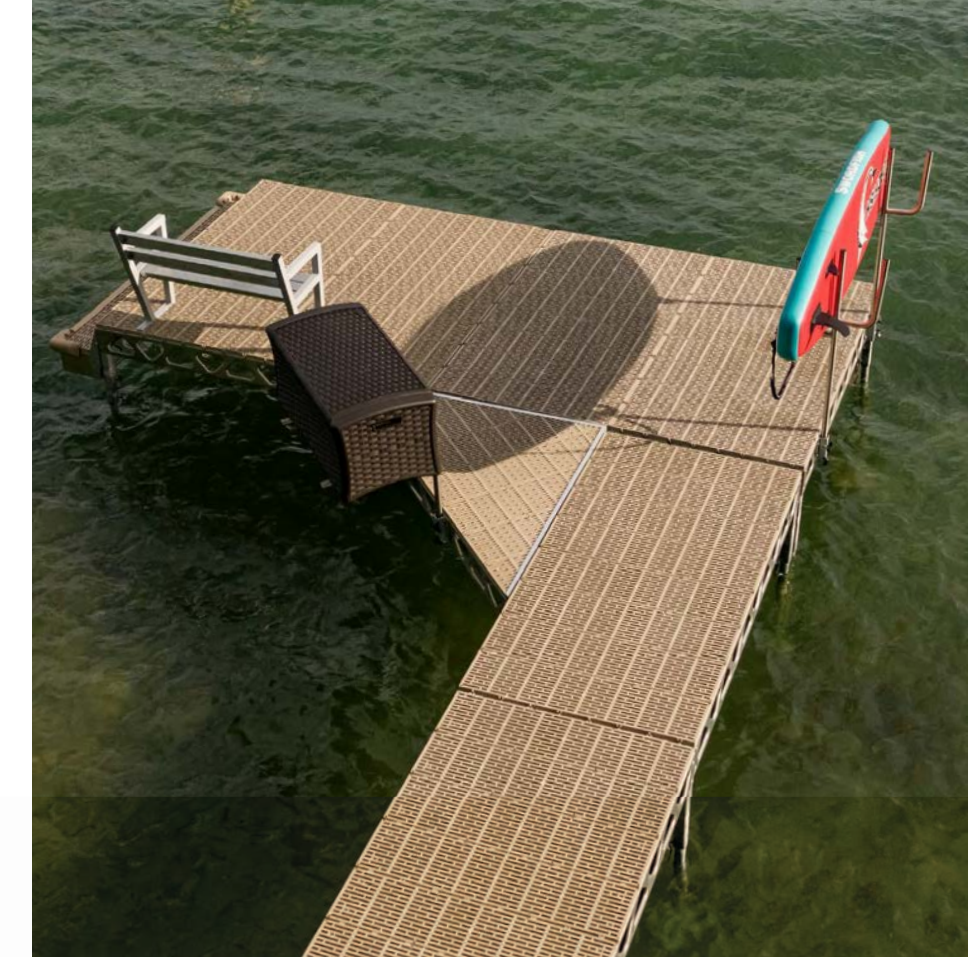
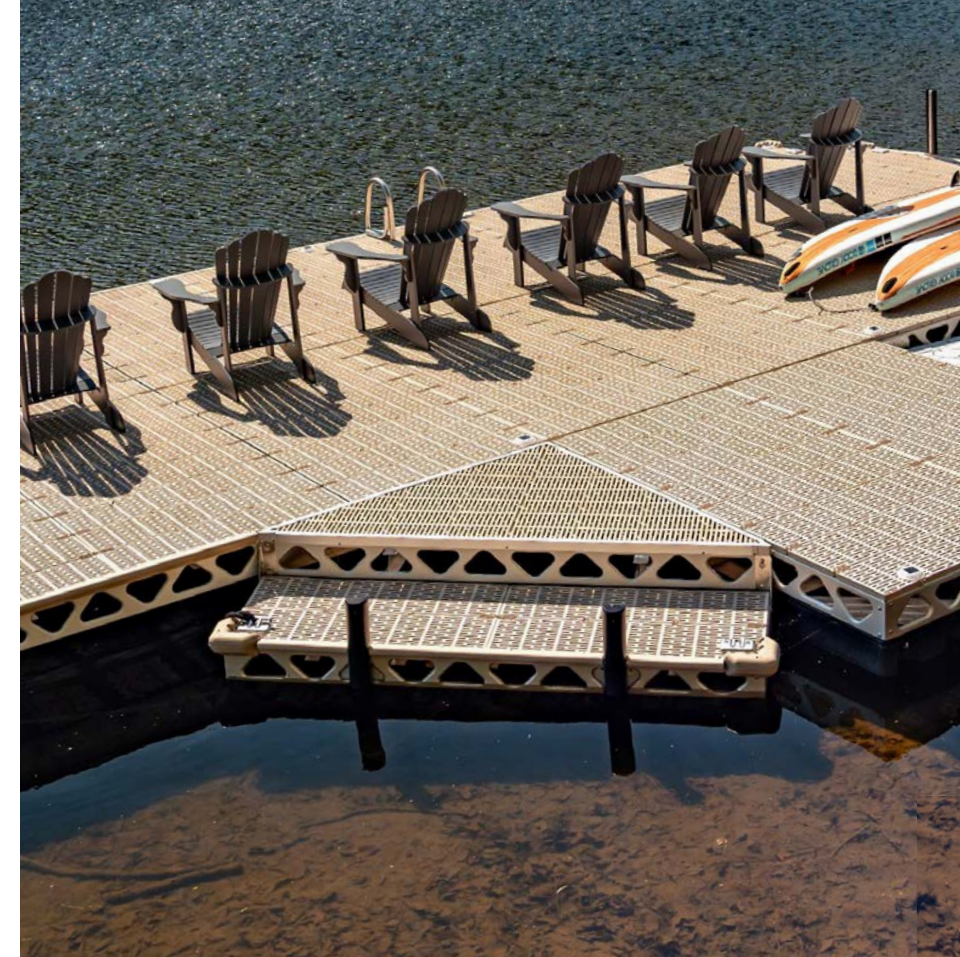

When designing our Dock Kits, we didn't cut any corners. However, when our customers plan their dream dock, we encourage them to cut as many corners as they can with our 4' and 8' Corner Kits. The corners attach to our Standing Dock sections using the included hanging brackets.

NOTABLE FEATURES



MADE IN CANADA



LIGHT WEIGHT



MAINTENANCE FREE



ALWAYS IN STOCK



QUICK ASSEMBLY



ECO FRIENDLY

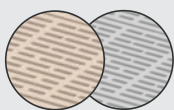

DECKING COLOUR



25 YEAR WARRANTY

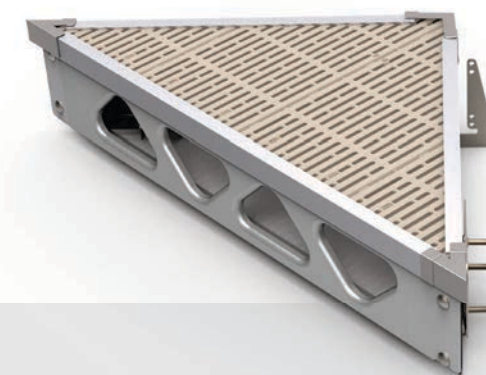

4' COMPLETE CORNER KIT

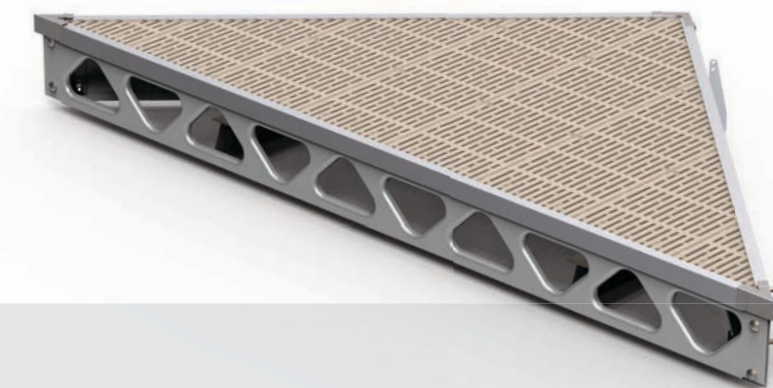

8' COMPLETE CORNER KIT

TRANSITION KITS

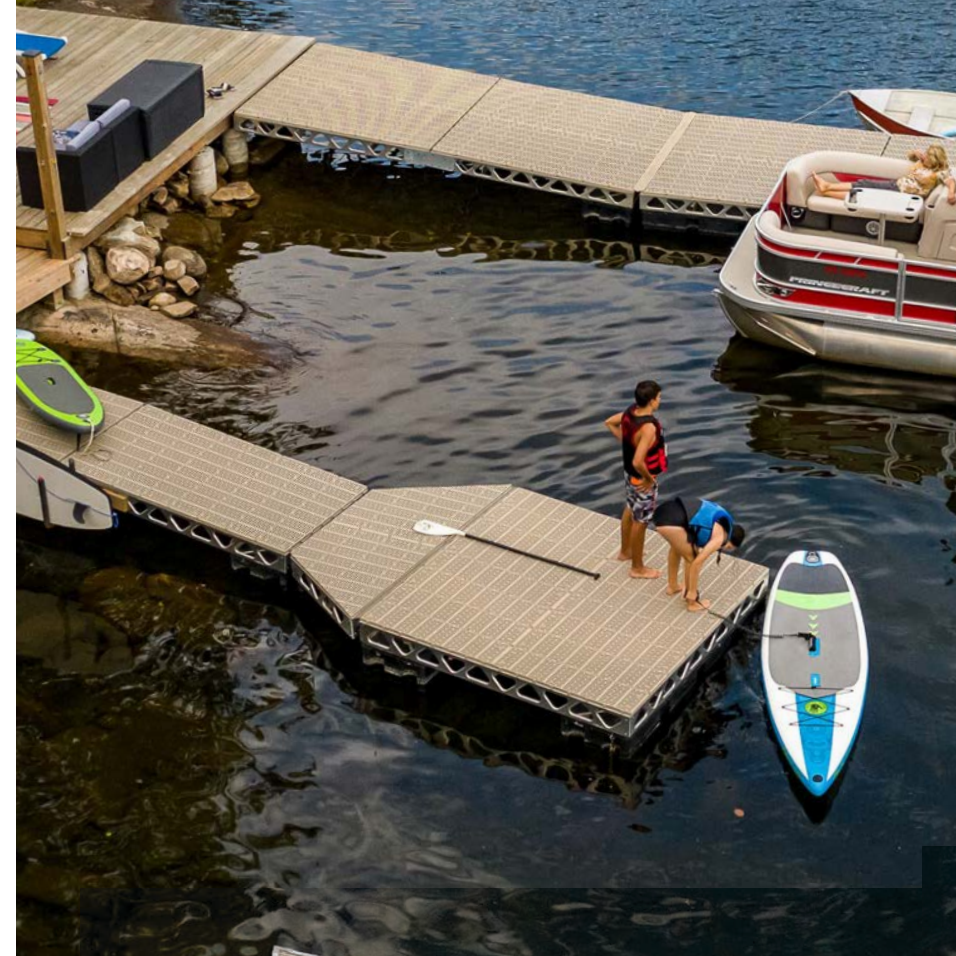

Transition Kits are designed to provide an elegant transition from 4' wide sections to 8' wide sections and vice versa. Although this section is best used as a transition, it can also be used to add extra square footage to the end or side of your dock.



STANDING TRANSITION KIT

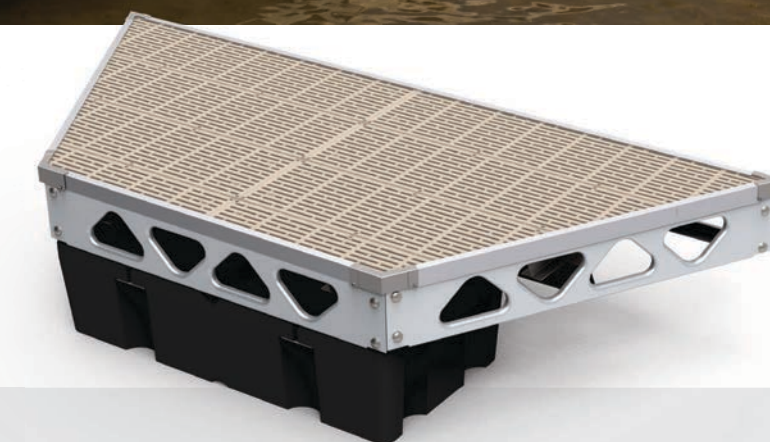

FLOATING TRANSITION KIT

NOTABLE FEATURES

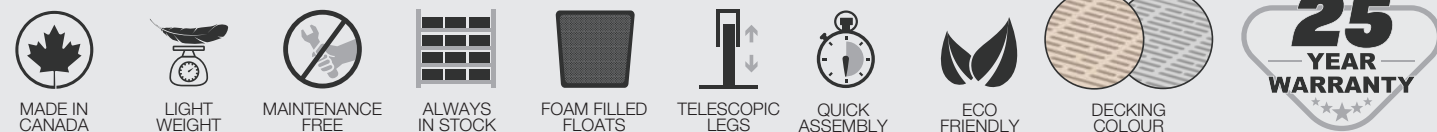



“I would highly recommend CanadaDocks and I have suggested CanadaDocks, and I explain to them the whole system and how it works, and how easy everything about it is in terms of even purchasing and talking with the dealers.

All you have to do is come down and see it. The dock is extremely functional and found it extremely affordable even being locked into a budget.”

Janet Goneau
Pier 31. Bellville, ON

**Scan To Watch
The Full Story**

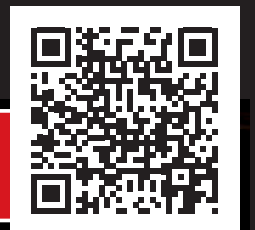

FLOATING DOCK KITS



FOAM FILLED EAGLE FLOATS™

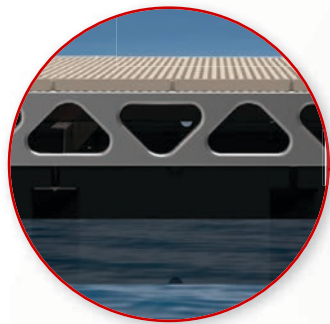

18" FREEBOARD

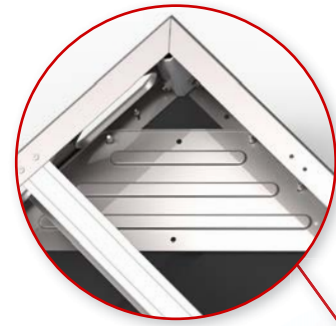

REINFORCED ALUMINUM CORNER BRACE

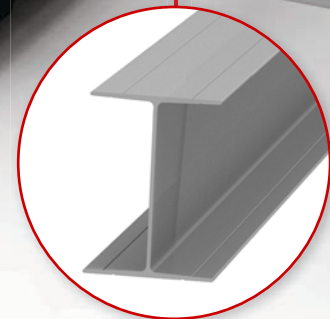

ALUMINUM I JOISTS ON 16" CENTERS

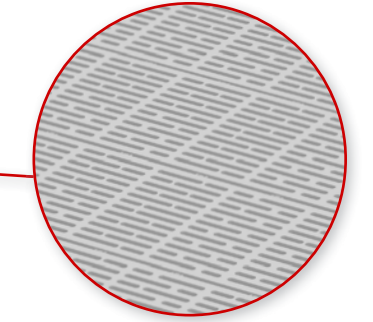
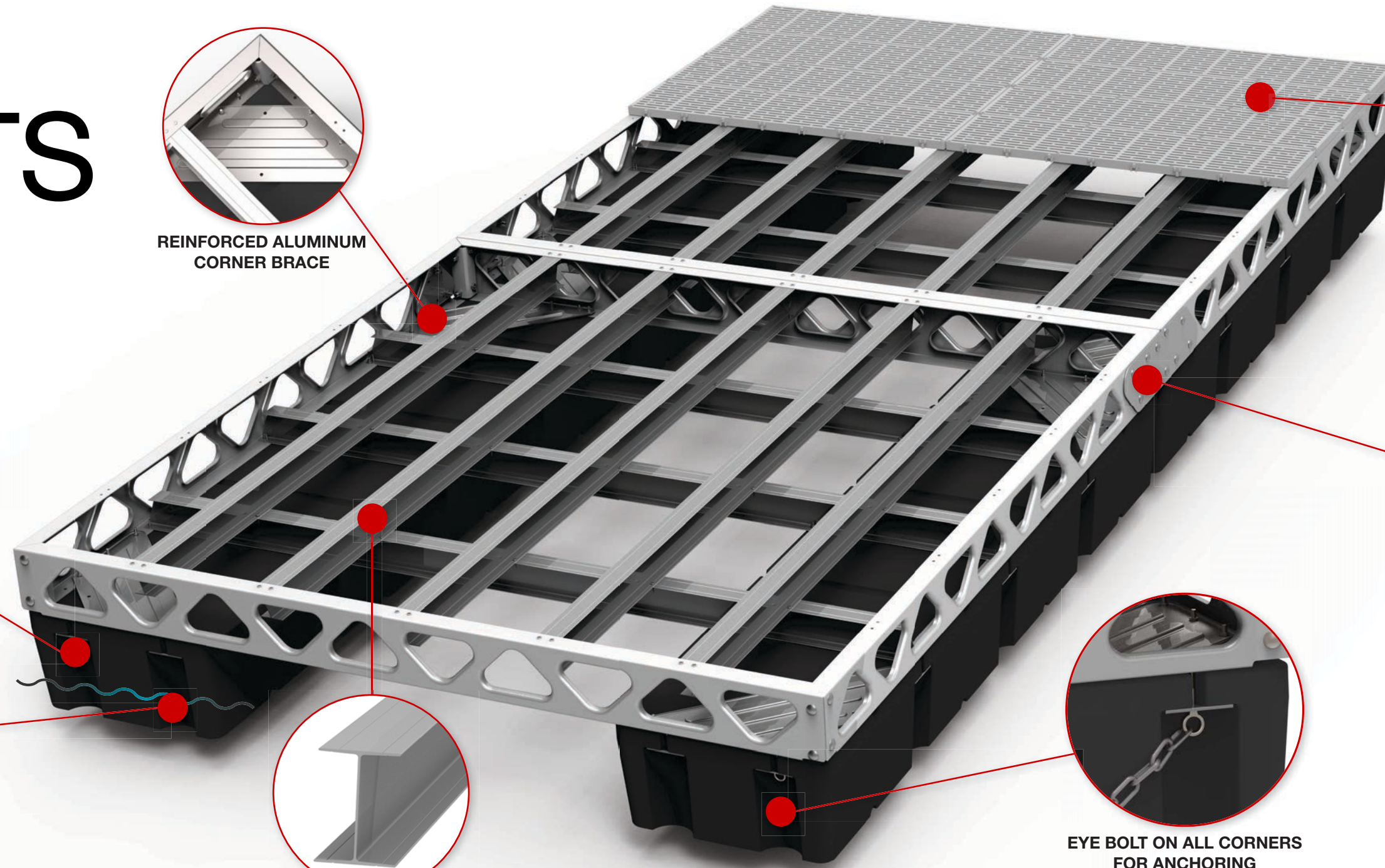

MAINTENANCE FREE DECKING

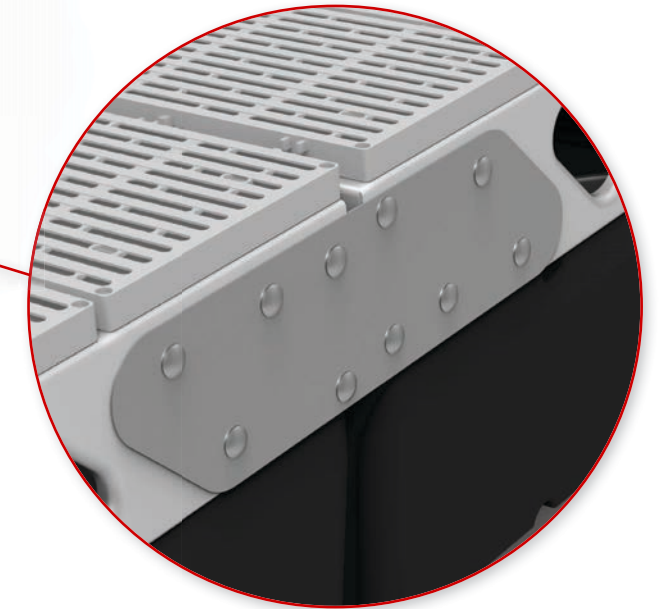

FLOATING DOCK CONNECTOR PLATE



EYE BOLT ON ALL CORNERS FOR ANCHORING

FLOATING RAMP KITS



Our Floating Ramp Kits are available in 4' x 8' and 8' x 8' sizes with the ability to extend to 4' x 16' and 8' x 16' using the Ramp Connector Kit. Each Floating Ramp Kit comes complete with a 4' or 8' float along with a Hinge Kit and Hinge Cover that easily attaches to any floating dock section.

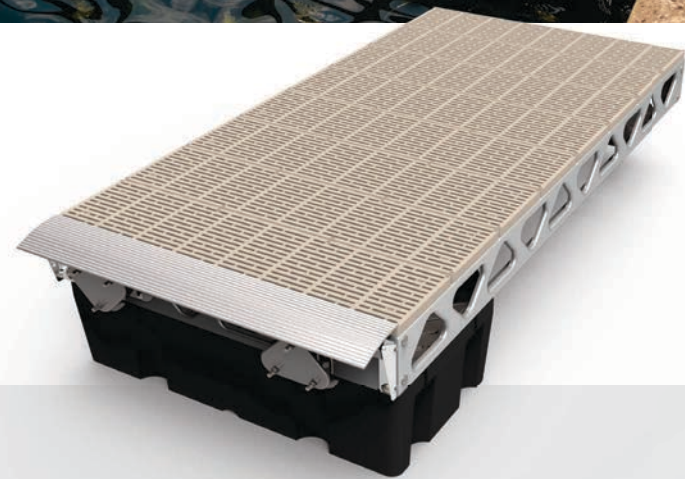

4' x 8' COMPLETE FLOATING RAMP KIT

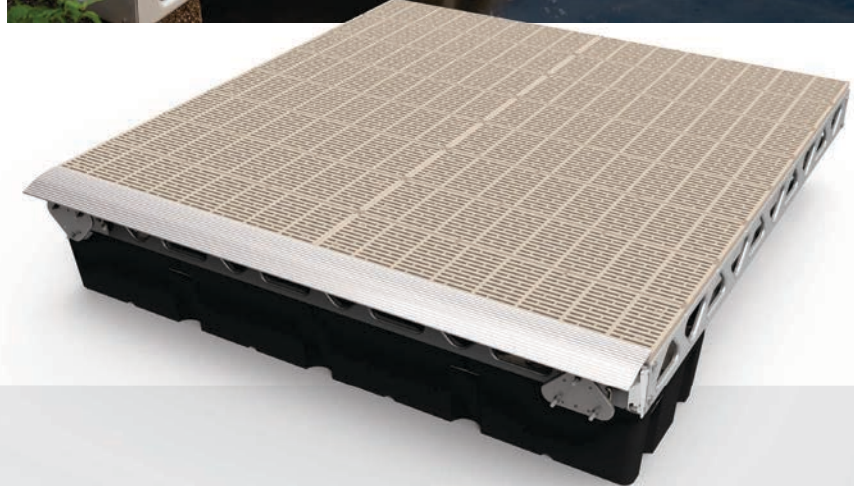

8' x 8' COMPLETE FLOATING RAMP KIT

NOTABLE FEATURES



MADE IN CANADA



LIGHT WEIGHT



MAINTENANCE FREE



ALWAYS IN STOCK



FOAM FILLED FLOATS



QUICK ASSEMBLY



ECO FRIENDLY

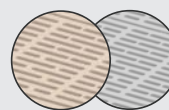

DECKING COLOUR



FLOATING DOCK KITS



Floating Dock Kits are great for lakes with fluctuating water levels or are too deep for a standing dock. Complete Kits come with foam filled Eagle Floats™, aluminum trusses and joists, hardware and maintenance free decking. Using the Floating Dock Connector Kit, 4' x 8' and 8' x 8' docks can be attached to form a large rigid floating dock platform.

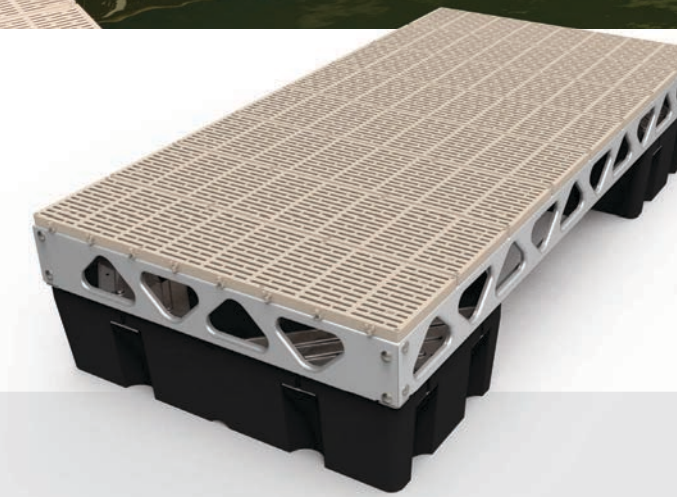

4' X 8' COMPLETE FLOATING DOCK KIT

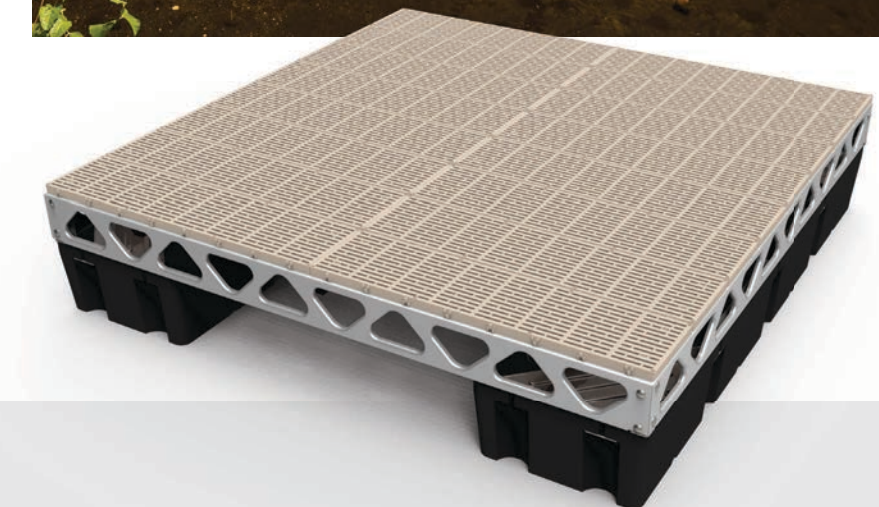

8' X 8' COMPLETE FLOATING DOCK KIT

NOTABLE FEATURES



MADE IN CANADA



LIGHT WEIGHT



MAINTENANCE FREE



ALWAYS IN STOCK



FOAM FILLED FLOATS



QUICK ASSEMBLY



ECO FRIENDLY

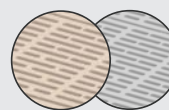

DECKING COLOUR



25 YEAR WARRANTY

FLOATING HEXAGON DOCK KITS

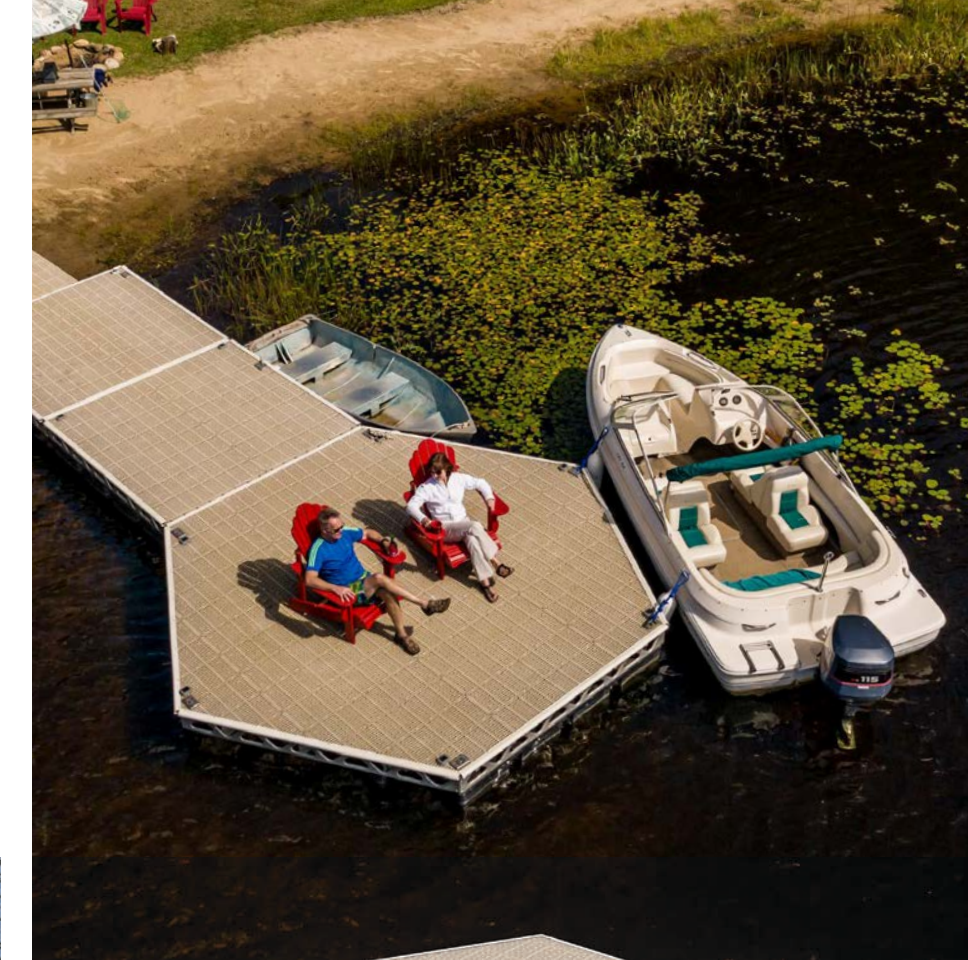
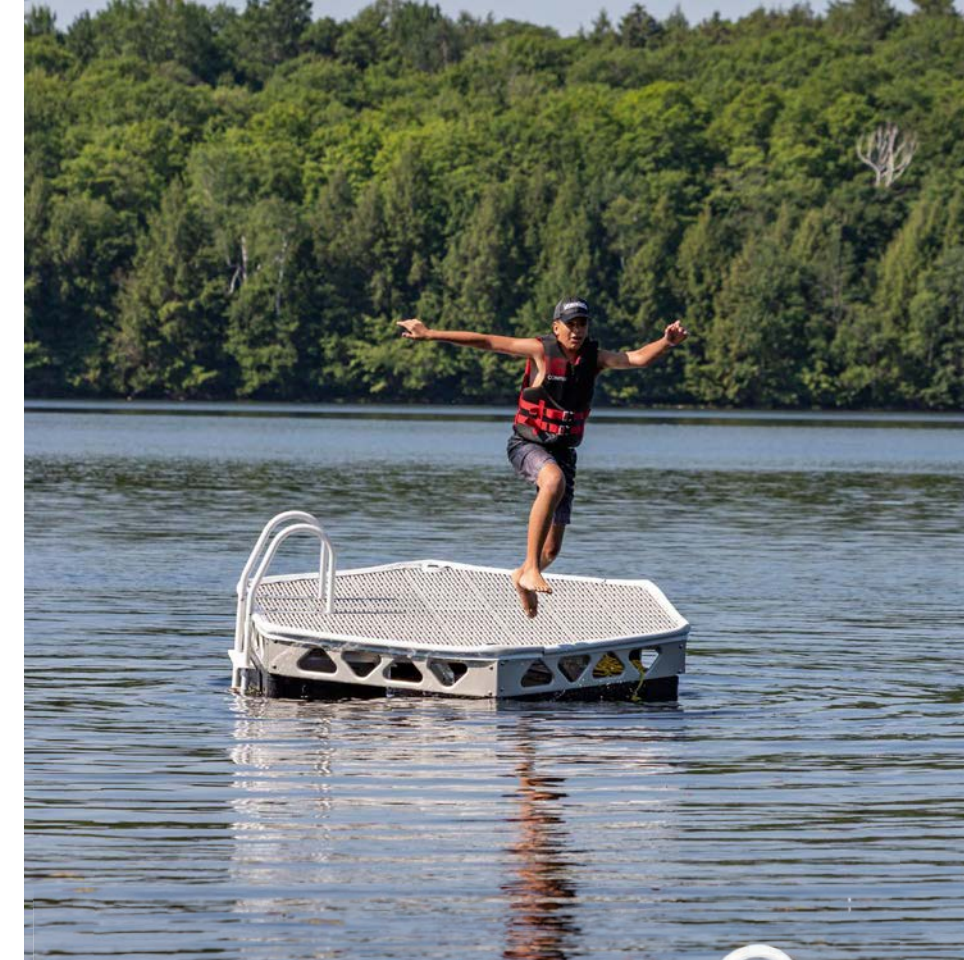

Our Floating Hexagon Kits are a truly unique dock section. The 7' x 8' size makes for a perfect swimming platform to practice your cannon balls from. The 14' x 16' is best used as the family gathering place on the water. Attaching the 14' x 16' Floating Hexagon to the end of your dock creates a 170 sq. ft. outdoor living space.



7' X 8' COMPLETE HEXAGON FLOATING DOCK KIT

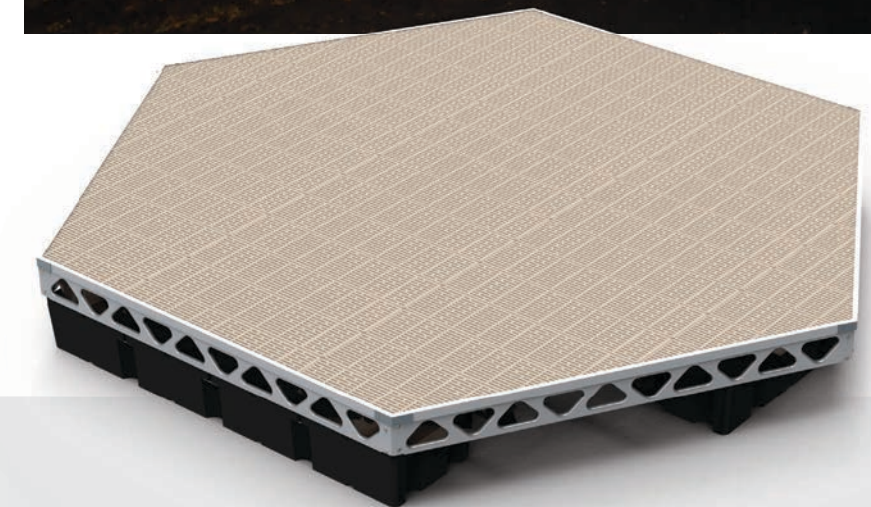

14' X 16' COMPLETE HEXAGON FLOATING DOCK KIT

NOTABLE FEATURES



MADE IN CANADA



MAINTENANCE FREE



ALWAYS IN STOCK



FOAM FILLED FLOATS



ECO FRIENDLY

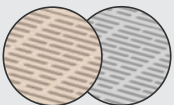

DECKING COLOUR





"I was really surprised how easy the Dock Builder is. I was designing different variations to see what would work. When I was looking at the weights and sizes of everything, the biggest box that came is less than 50 lbs. and 8' long. For us the load in and unloading was perfect.

Anytime you factor in shipping by aircraft and seeing how long this dock is, and the fact everything fit in 2 planes is amazing. It went together very quickly with very minimal waste afterwards."

Robert Watson
Windy Point Lodge. Kabinakagami Lake, ON

[Scan To Watch
The Full Story](#)



BOAT LIFTS



1200 lb. PWC LIFT

Weight Capacity: 1200 lbs / 544 kg
Overall Weight: 150 lbs / 68 kg
Overall Width: 54" / 132 cm
Overall Length: 106" / 269 cm
Bunk Length: 66" / 168 cm

Minimum Water Depth:
2' or at cross bar

Maximum Water Depth:
6" above cross bar



1200 lb. BOAT LIFT

Weight Capacity: 1200 lbs / 544 kg
Overall Weight: 225 lbs / 102 kg
Overall Width: 82" / 208 cm
Overall Length: 96" / 243 cm
Bunk Length: 89" / 226 cm

Minimum Water Depth:
2' or at cross bar

Maximum Water Depth:
6" above cross bar



3000 lb. BOAT LIFT

Weight Capacity: 3000 lbs / 1360 kg
Overall Weight: 500 lbs / 227 kg
Overall Width: 121" / 307 cm
Overall Length: 130" / 330 cm
Bunk Length: 120" / 305 cm

Minimum Water Depth:
2' or at cross bar

Maximum Water Depth:
6" above cross bar

CanadaDocks provides Lifts that are the perfect accessory for boat lovers. Using a boat lift prevents the impact of your boat against the dock during bad weather. Lifting also avoids build up of corrosion, scum and slime from being left in the water. Boats are big investments, why not protect them. These cantilever styled lifts are manufactured using 6061-T6 marine grade aluminum rectangle tubing, adjustable legs with your choice of either an automatic brake winch, hand wheel or an electric winch. All pulleys use grease fittings and bronze bushings to prevent seizing.

ACCESSORIES



LIFESTYLE



STORAGE BOX HOLDER
Attaches to the side of any CanadaDocks dock section. Designed to hold storage boxes of varying sizes.



CANOE & KAYAK RACK
Attaches to the side of any CanadaDocks dock section. Convenient storage for canoes, kayaks, and much more.



CACTUS RACK HOLDER
Attaches to the side of any CanadaDocks dock section. The slots are designed to hold paddle boards, wakeboards and water skis.



UMBRELLA HOLDER
The umbrella holder is designed to quickly hook under the Thruflow decking creating a stable base while taking up a minimal footprint.



BENCH
A light yet very sturdy all-aluminum bench, with cup holders, provides a secure, always available bench for your friends and family.



FLAG POLE KIT
The ideal dock accessory for the true patriot! Wave our nation's flag on your dock with our simple to install flag pole kit. Includes bracket, fiberglass pole and Canadian flag.

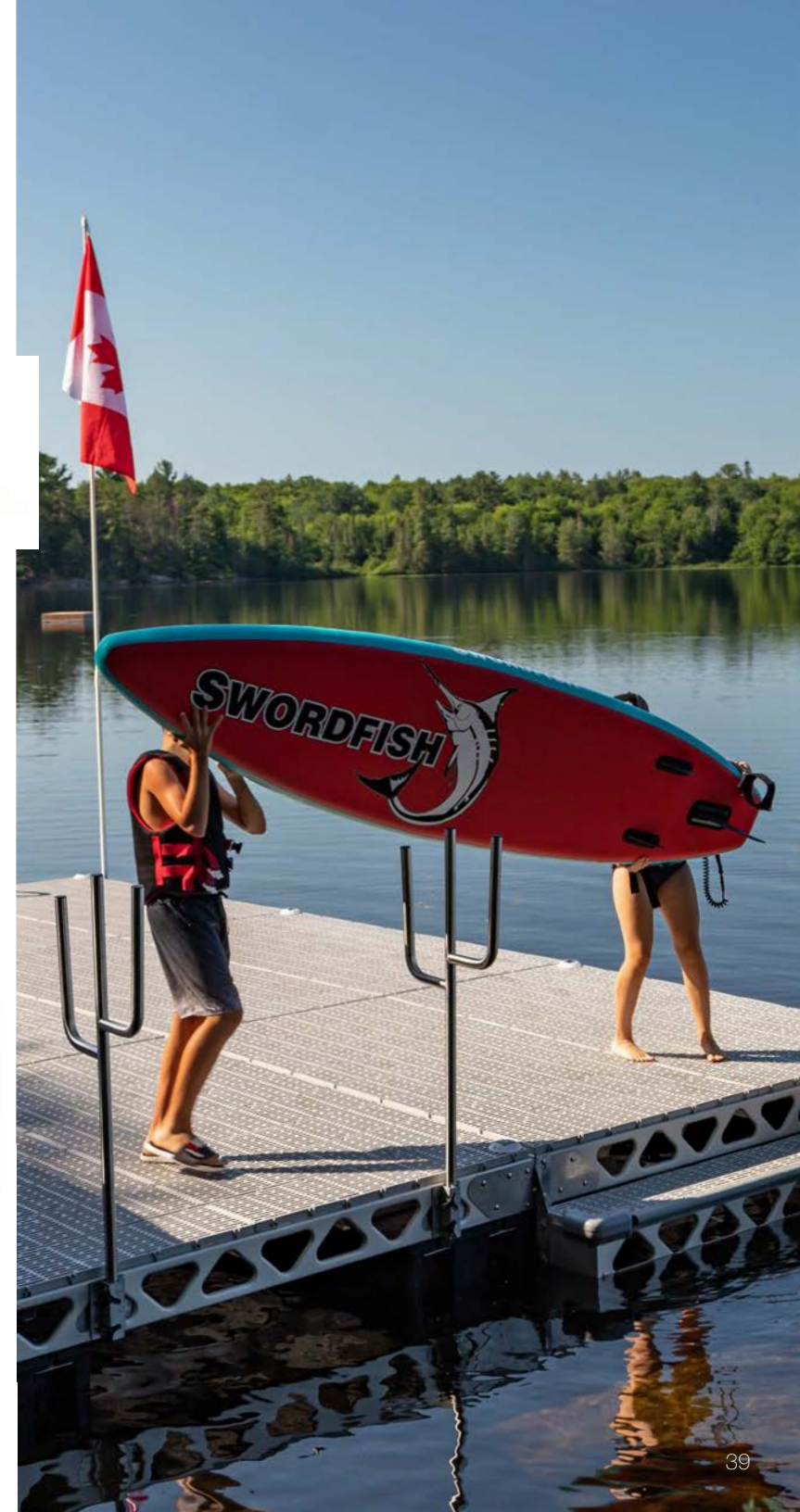

ACCESS PLATFORMS



1'x8' ACCESS PLATFORM
Designed to help you get in and out of your canoe, kayak, etc. Works with both standing and floating docks.



2'x8' ACCESS PLATFORM
Designed to help you get in and out of your canoe, kayak, etc. Works with standing docks only.



4'x8' ACCESS PLATFORM
A much larger platform help you get in and out of your canoe, kayak, etc. Works with standing and floating docks.



DOGGY RAMP
Designed to help your furry friend get in and out of the water safely.

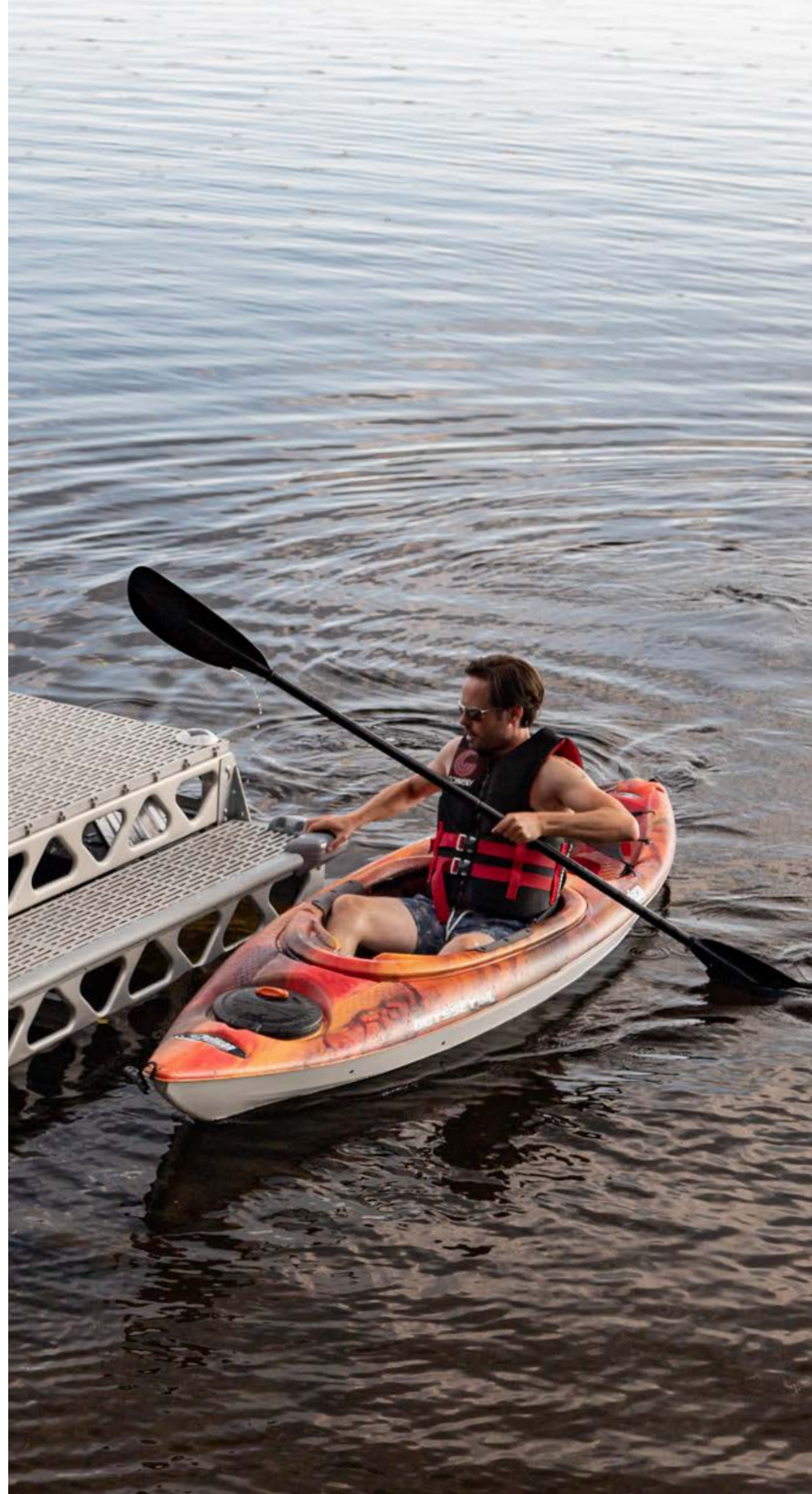

STANDING WHEEL KITS

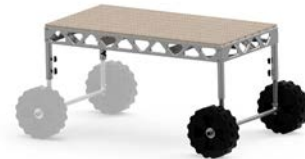

4' STANDING DOCK WHEEL KIT
Wheel kit make installing and removing your standing dock even easier.



8' STANDING DOCK WHEEL KIT
Wheel kit make installing and removing your standing dock even easier.



STANDING HEXAGON DOCK WHEEL KIT
Wheel kit make installing and removing your standing dock even easier.



FLOATING WHEEL KITS



4' FLOATING DOCK WHEEL KIT
Wheel kit make installing and removing your floating dock even easier.



8' FLOATING DOCK WHEEL KIT
Wheel kit make installing and removing your floating dock even easier.



FLOATING HEXAGON DOCK WHEEL KIT
Wheel kit make installing and removing your floating dock even easier.



HINGES & CONNECTORS



HINGE KIT
Connects CanadaDocks floating docks and ramps.



OFFSET HINGE KIT
Connects CanadaDocks ramps and floating docks.



DOUBLE PIN HINGE KIT
Used to connect floating dock sections together with reduced movement that can also be easily disconnected



HANGING T-KIT
Allows attachment of standing docks in a T shaped configuration.



HANGER KIT
Allows attachment of standing docks in an L shaped configuration.

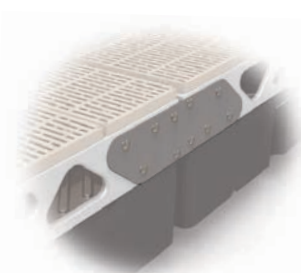

FLOATING DOCK CONNECTOR KIT
Connects 4' x 8' and 8' x 8' floating docks together to create a rigid floating dock.



RAMP CONNECTOR KIT
Connects 4' x 8' and 8' x 8' ramps together to create a rigid 12' or a 16' ramp section.



FLOATING DOCK T CONNECTOR KIT
When forming a T shaped rigid dock using two or more floating dock sections.



LEG EXTENSION
Can be used to extend CanadaDocks telescopic legs. Comes in 8" and 20" extensions. Also available in kits of 4.



STAIRS
All-aluminum stairs, available in 4, 5 or 6 step configurations. Stainless steel handrail sold separately.

LADDERS



STAINLESS STEEL FLIP UP LADDER
Constructed with high grade stainless steel with oversized plastic steps. It also features a flip up attachment. Available in 3, 4 and 5 steps.



STAINLESS STEEL 15° LADDER
Constructed with high grade stainless steel at a 15 degree angle with oversized plastic steps. Available in 3, 4 and 5 steps.



STAINLESS STEEL LADDER
Constructed with high grade stainless steel with oversized plastic steps. Available in 3, 4 and 5 steps.



STAIRS



ALUMINUM LADDER
Highly durable aluminum ladder with extra support and ease of use. Available in 3 or 4 steps.



ALUMINUM FLIP UP LADDER
Aluminum ladder that can be flipped up onto dock while not in use. Available in 3 or 4 steps.



15 DEGREE TECHSTAR FLIP UP 5 STEP LADDER
Ideal for an aging population and families with dogs. Available in 2 colours, Sandstone & Grey.



SOLAR LIGHTS



SOLAR LIGHT POST
A solar light post that adds functionality and lighting to any dock.



SOLAR LIGHT SAFETY RING POST
A solar light post that doubles as a hanger for a safety ring. Great addition to any dock.

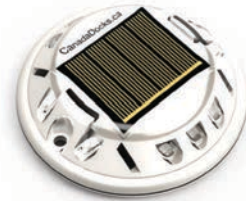

SOLAR DOCK LIGHT
360 Degree Solar Lights are easy to install and ideal for illuminating dock pathways or transition areas such as from dock to shore.



SAFETY RAILINGS



SAFETY GRAB RAIL
Easily connects to all Dock Kits. Assists with getting in and out of your boat or water.



8' ALUMINUM HANDRAIL
The handrail fits 4' x 8' and 8' x 8' Dock Kits.



8' KICK RAIL
Designed for commercial and residential docks to comply with accessibility standards.

CLEATS



POLISHED ALUMINUM CLEAT
Fold down aluminum cleat.



RED & WHITE CLEAT
Fold down powder coated aluminum cleat.



WHITE CLEAT
Fold down powder coated aluminum cleat.



DECKING

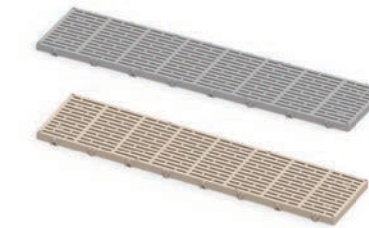

1'x4' THRUFLOW™ PANEL
Engineered polypropylene decking panel. Available in grey or maple colour.



1'x4' THRUFLOW™ PANEL SOL SERIES
Sol Series adds a fully integrated solar panel to the signature interlocking panel design.

FLOATS



4' & 8' FOAM FILLED EAGLE FLOAT™
4'x2'x12" has 13.6 kg (30 lbs) float has a 190 kg (421 lbs) buoyancy.
8'x2'x12" has 29 kg (64 lbs) float has a 380.6 kg (839 lbs) buoyancy.

ANCHORING



150lb CONCRETE ANCHOR
150lb concrete anchor that can be used to secure your standing or floating docks.



REUSABLE ANCHOR MOLD
Make your own anchors at home or the cottage.



CHAIN RETAINER
Attached at the dock leg, the chain retainer allows for attachment of chain to anchor the dock.

STABILITY



STABILITY POST KIT
Stabilizes floating dock section using an auger.



STANDING DEEP WATER LEG BRACES
Designed for longer legs in deep water to provide stability on both 4' and 8' standing docks.



TENSION CORD
It helps to hold the floating dock in place by maintaining tension on the chains and absorbing some jerking caused by waves.

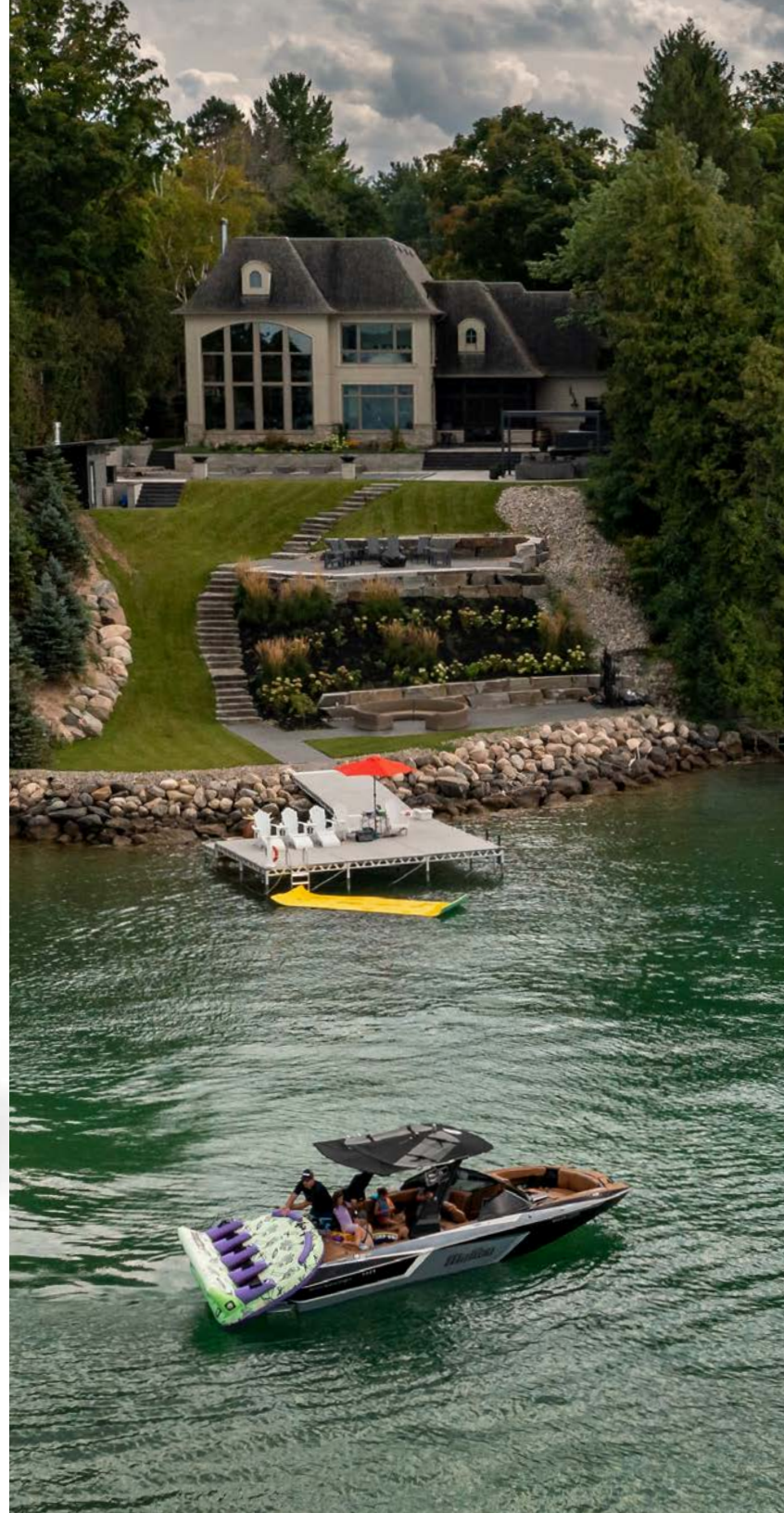

FISHING TRANSITIONS



FISHING ROD HOLDER
Includes bracket, aluminum pole and Scotty Rod Holder.



RAMP TRANSITION
Creates easier wheel chair accessibility and a complete look for your 4' or 8' dock ramp.



HINGE COVER
Available in 4' or 8', to safely cover the gap caused by the hinge that transitions your ramp and dock section.



BUMPERS



P-BUMPER
Bumper available in beige, grey and white. Complete with UV and fungicide inhibitors.



DOLPHIN CORNER BUMPER
Corner bumper, available in beige, grey and white. Complete with UV and fungicide inhibitors.



VERTICAL BUMPER
Robust urethane vertical bumper with adjustable mounting channel.





Miller Lake
Summer House Park, ON

STANDING DOCK KITS

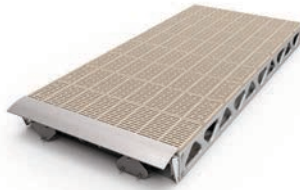

4' X 8' COMPLETE RAMP KIT
120 lbs / 54 kg
(w/o decking - 70 lbs / 31 kg)

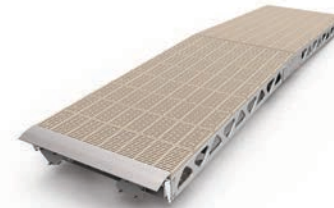

4' X 16' COMPLETE RAMP KIT
260 lbs / 118 kg
(w/o decking - 160 lbs / 72 kg)

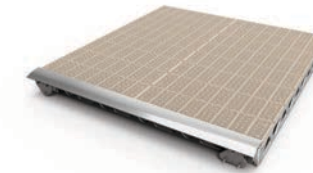

8' X 8' COMPLETE RAMP KIT
220 lbs / 100 kg
(w/o decking - 120 lbs / 54 kg)

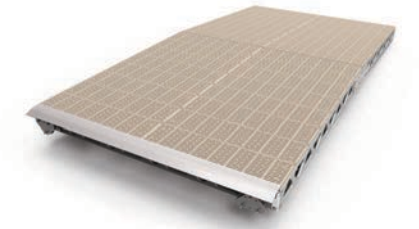

8' X 16' COMPLETE RAMP KIT
445 lbs / 201 kg
(w/o decking - 285 lbs / 129 kg)



140 lbs / 63 kg
(w/o decking - 90 lbs / 40 kg)



4' x 8' COMPLETE STANDING DOCK KIT 2' - 4' LEGS
150 lbs / 68 kg
(w/o decking - 100 lbs / 45 kg)



4' x 8' COMPLETE STANDING DOCK KIT 4' - 8' LEGS
170 lbs / 77 kg
(w/o decking - 120 lbs / 54 kg)

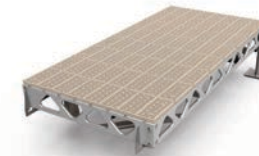

4' x 8' COMPLETE QUICK LINK DOCK KIT 1' - 2' LEGS
130 lbs / 59 kg
(w/o decking - 80 lbs / 36 kg)

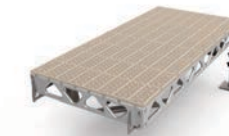

4' x 8' COMPLETE QUICK LINK DOCK KIT 2' - 4' LEGS
135 lbs / 61 kg
(w/o decking - 85 lbs / 38 kg)

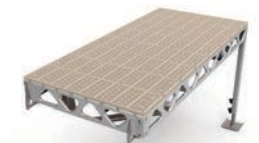

4' x 8' COMPLETE QUICK LINK DOCK KIT 4' - 8' LEGS
145 lbs / 66 kg
(w/o decking - 95 lbs / 43 kg)



8' x 8' COMPLETE STANDING DOCK KIT 1' - 2' LEGS
240 lbs / 109 kg
(w/o decking - 140 lbs / 63 kg)



8' x 8' COMPLETE STANDING DOCK KIT 2' - 4' LEGS
250 lbs / 113 kg
(w/o decking - 150 lbs / 68 kg)



8' x 8' COMPLETE STANDING DOCK KIT 4' - 8' LEGS
270 lbs / 122 kg
(w/o decking - 170 lbs / 77 kg)

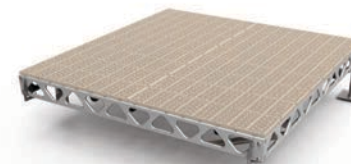

8' x 8' COMPLETE QUICK LINK DOCK KIT 1' - 2' LEGS
230 lbs / 104 kg
(w/o decking - 130 lbs / 59 kg)

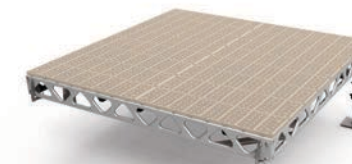

8' x 8' COMPLETE QUICK LINK DOCK KIT 2' - 4' LEGS
235 lbs / 106 kg
(w/o decking - 135 lbs / 61 kg)

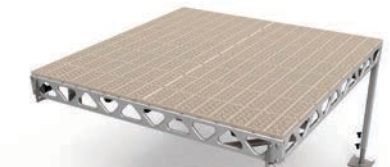

8' x 8' COMPLETE QUICK LINK DOCK KIT 4' - 8' LEGS
245 lbs / 111 kg
(w/o decking - 145 lbs / 66 kg)

STANDING DOCK KITS

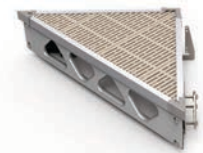

4' COMPLETE CORNER KIT
30 lbs / 13 kg
(w/o decking - 17 lbs / 6 kg)

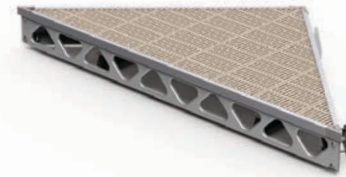

8' COMPLETE CORNER KIT
70 lbs / 32 kg
(w/o decking - 45 lbs / 20 kg)

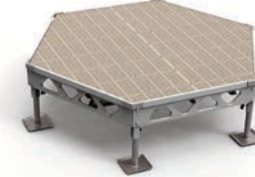

7' x 8' COMPLETE HEXAGON STANDING DOCK KIT 1' - 2' LEGS
220 lbs / 100 kg
(w/o decking - 120 lbs / 54 kg)



7' x 8' COMPLETE HEXAGON STANDING DOCK KIT 2' - 4' LEGS
235 lbs / 106 kg
(w/o decking - 135 lbs / 61 kg)



7' x 8' COMPLETE HEXAGON STANDING DOCK KIT 4' - 8' LEGS
265 lbs / 120 kg
(w/o decking - 165 lbs / 75 kg)



STANDING TRANSITION KIT 1' - 2' LEGS
105 lbs / 47 kg
(w/o decking - 55 lbs / 25 kg)



STANDING TRANSITION KIT 2' - 4' LEGS
115 lbs / 52 kg
(w/o decking - 65 lbs / 29 kg)



STANDING TRANSITION KIT 4' - 8' LEGS
130 lbs / 59 kg
(w/o decking - 80 lbs / 36 kg)

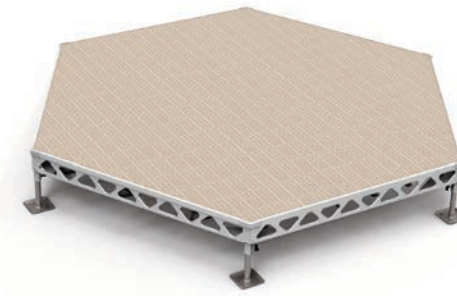

14' x 16' COMPLETE HEXAGON STANDING DOCK KIT 1' - 2' LEGS
665 lbs / 301 kg
(w/o decking - 365 lbs / 165 kg)



14' x 16' COMPLETE HEXAGON STANDING DOCK KIT 2' - 4' LEGS
685 lbs / 311 kg
(w/o decking - 385 lbs / 162 kg)



14' x 16' COMPLETE HEXAGON STANDING DOCK KIT 4' - 8' LEGS
720 lbs / 326 kg
(w/o decking - 420 lbs / 190 kg)

FLOATING DOCK KITS

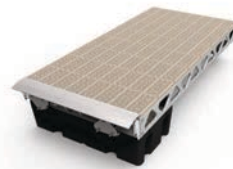

**4' X 8' COMPLETE
FLOATING RAMP KIT**
145 lbs / 66 kg
(w/o decking - 95 lbs / 43 kg)

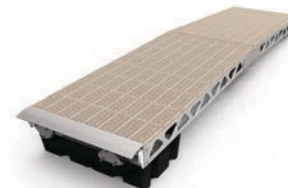

**4' X 16' COMPLETE
FLOATING RAMP KIT**
235 lbs / 106 kg
(w/o decking - 135 lbs / 61 kg)

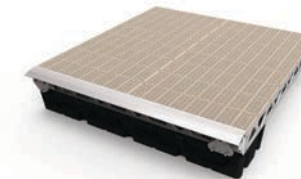

**8' X 8' COMPLETE
FLOATING RAMP KIT**
260 lbs / 118 kg
(w/o decking - 160 lbs / 73 kg)

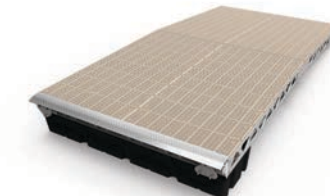

**8' X 16' COMPLETE
FLOATING RAMP KIT**
475 lbs / 215 kg
(w/o decking - 255 lbs / 115 kg)

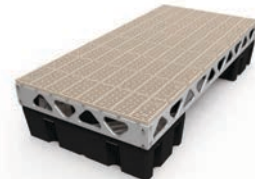

**4' X 8' COMPLETE
FLOATING DOCK KIT**
180 lbs / 82 kg
(w/o decking - 130 lbs / 59 kg)

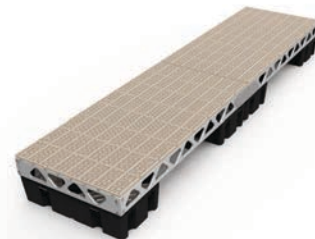

**4' X 16' COMPLETE
FLOATING DOCK KIT**
380 lbs / 172 kg
(w/o decking - 280 lbs / 127 kg)



**4' X 24' COMPLETE
FLOATING DOCK KIT**
585 lbs / 265 kg
(w/o decking - 435 lbs / 197 kg)

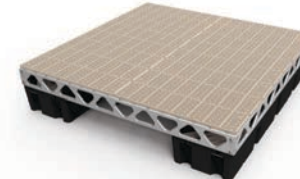

**8' X 8' COMPLETE
FLOATING DOCK KIT**
330 lbs / 150 kg
(w/o decking - 230 lbs / 104 kg)

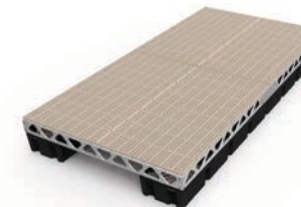

**8' X 16' COMPLETE
FLOATING DOCK KIT**
680 lbs / 308 kg
(w/o decking - 480 lbs / 218 kg)

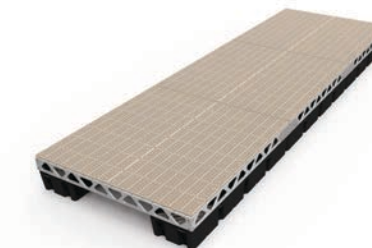

**8' X 24' COMPLETE
FLOATING DOCK KIT**
1025 lbs / 465 kg
(w/o decking - 725 lbs / 329 kg)

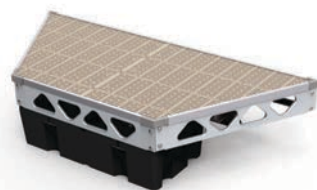

FLOATING TRANSITION KIT
130 lbs / 59 kg
(w/o decking - 80 lbs / 36 kg)

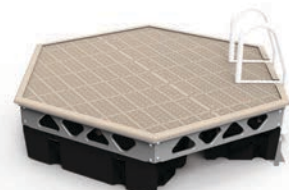

**7' x 8' COMPLETE HEXAGON
FLOATING DOCK KIT**
315 lbs / 143 kg
(w/o decking - 215 lbs / 97 kg)

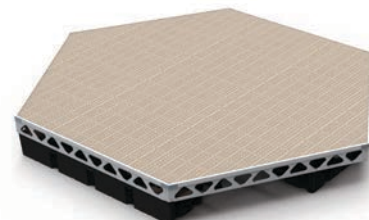

**14' x 16' COMPLETE HEXAGON
FLOATING DOCK KIT**
920 lbs / 417 kg
(w/o decking - 620 lbs / 281 kg)



**8' X 32' COMPLETE
FLOATING DOCK KIT**
1,375 lbs / 624 kg
(w/o decking - 975 lbs / 442 kg)



**8' X 40' COMPLETE
FLOATING DOCK KIT**
1,725 lbs / 782 kg
(w/o decking - 1,225 lbs / 555 kg)



**8' X 48' COMPLETE
FLOATING DOCK KIT**
2,075 lbs / 941 kg
(w/o decking - 1,475 lbs / 669 kg)



Lake Simcoe
Snake Island, ON



 **DESIGN & QUOTE YOUR DOCK ONLINE**
CANADADOCKS.CA/DOCKBUILDER

The CanadaDocks online dock builder allows you to visualize and plan your dock at your convenience.
 Simply visit CanadaDocks.ca/dockbuilder to start configuring the dock of your dreams.

PLAN YOUR DOCK LAYOUT

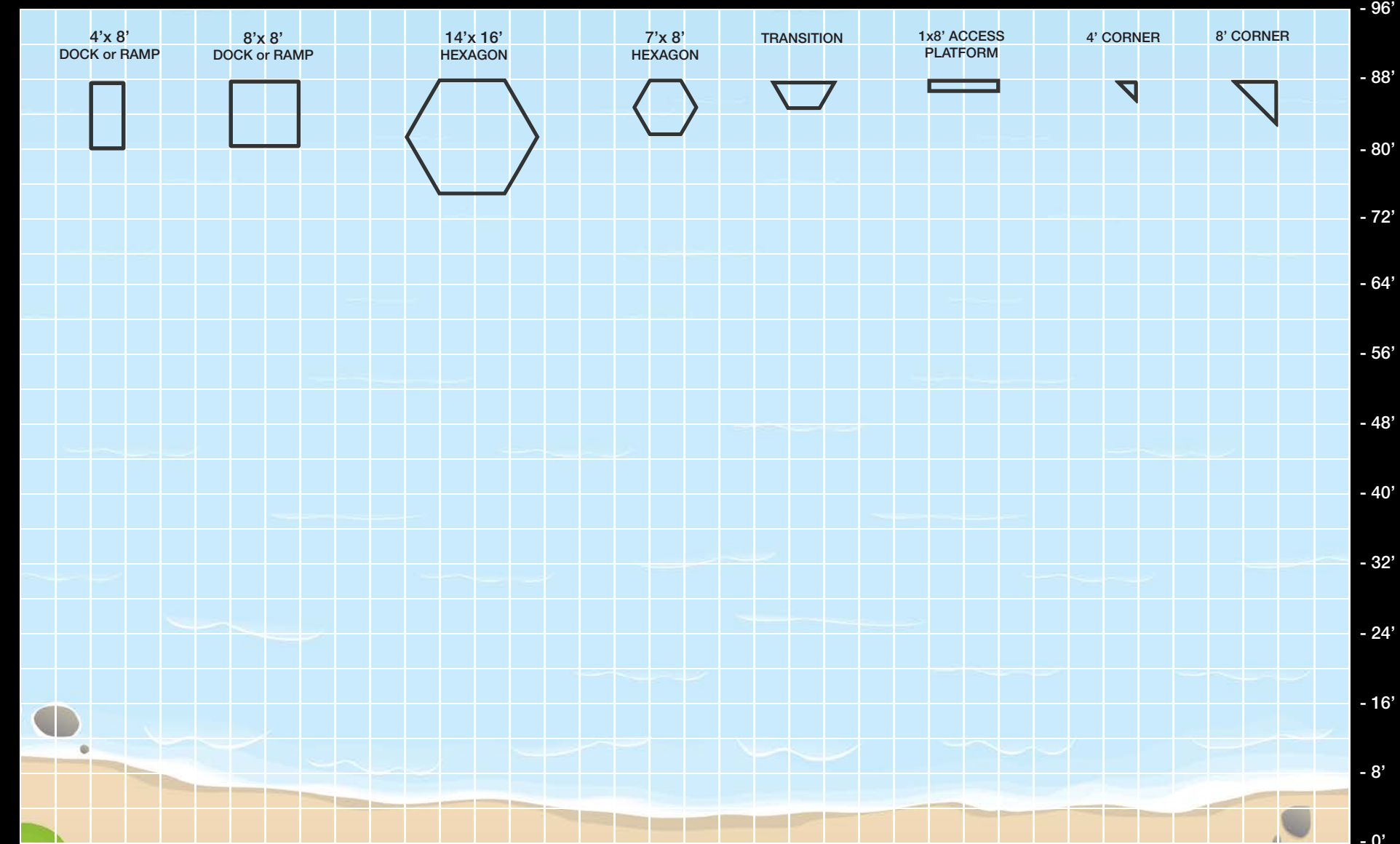

ENDLESS CONFIGURATIONS & CUSTOMIZING

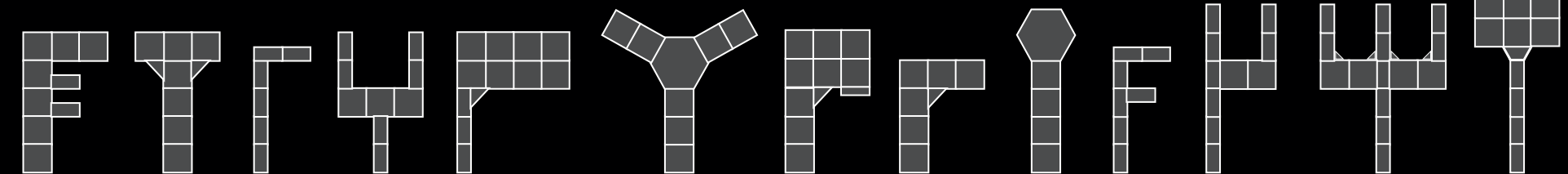



FIND A DEALER NEAR YOU
CANADADOCKS.CA/DEALERS



CanadaDocks Inc.
3690 Adjala-Tecumseth Townline
Beeton, ON L0G 1A0
1.877.434.0359 or 705.434.0359

All specifications and designs are subject to change without prior notice due to ongoing product improvements.

CanadaDocks.ca

