

Fusione a terra
è un altro tassello della
qualità firmata Vezzani



Fusione a cera persa
ogni oggetto è un'opera unica.
La produzione del bronzo avviene
dal metodo più antico e pregiato
della cera persa



Pressofusione



Lucidatura e verniciatura
Ogni fase del ciclo produttivo
aggiunge qualità al prodotto finale.



BRONZO



P. 12
SERIE **VOLO**



P. 26
SERIE **ETRURIA**



P. 32
SERIE **FORMAT**



P. 76
SERIE **ARMONIA**



P. 78
SERIE **RAFFAELLO**



P. 82
SERIE **EDEN**



P. 36
SERIE **HARP**



P. 40
SERIE **NETTUNO**



P. 46
SERIE **SPINNAKER**



P. 88
SERIE **ELEGANT**



P. 90
SERIE **GHIBLI**



P. 92
SERIE **MARSIGLIA**



P. 50
SERIE **AMADEUS**



P. 58
SERIE **GALA**



P. 60
SERIE **MIKI**



P. 96
SERIE **LOUVRE**



P. 98
SERIE **METROPOLITAN**



P. 102
SERIE **HERMITAGE**



P. 62
SERIE **SAMOA**



P. 64
SERIE **SIRIUS**



P. 66
SERIE **STRATOS**



P. 104
SERIE **UFFIZI**



P. 108
SERIE **PALACE**



P. 109
SERIE **HEBRON**



P. 68
SERIE **REGGIO**



P. 72
SERIE **NOVANTA**



P. 74
SERIE **MANTA**



P. 110
SERIE **DENNY ARTAL**



P. 111
SERIE **TRENTO**



ART. 47301 P
↓ 20,5 ↔ 11,5 cm

ART. 47033 P T
↓ 20,5 ↔ 11,5 cm



ART. 47300 P
↓ 12,5 ↔ 6 cm



ART. 47309 P
↓ 13 ↔ 7,5 cm



ART. 49339 P
↓ 17 ↔ 17 cm

ART. 49239 P T
↓ 17 ↔ 17 cm

ART. 47302 R
↓ 20,5 ↔ 11,5 cm

ART. 47047 R
↓ 20,5 ↔ 11,5 cm

ART. 47010 P T
↓ 13 ↔ 7,5 cm

ART. 49340 R
↓ 17 ↔ 17 cm

ART. 49240 R
↓ 17 ↔ 17 cm



ART. 46996 P
↓ 20 ↔ 13,5 cm

ART. 46696 T
↓ 20 ↔ 13,5 cm



ART. 46302 Ø 5 P
↓ 19 ↔ 9 cm

ART. 46002 Ø 5 T
↓ 19 ↔ 9 cm



ART. 46304 Ø 4 P
↓ 13 ↔ 6,5 cm

ART. 46004 Ø 4 T
↓ 13 ↔ 6,5 cm



ART. 31633 7x9 cm
ART. 31663 8x10 cm
ART. 40106 9x12 cm
ART. 40107 11x15 cm
ART. 31664 13x18 cm



ART. 31635 7x9 cm
ART. 31636 8x10 cm
ART. 40126 9x12 cm
ART. 40127 10x15 cm
ART. 40128 11x15 cm
ART. 40139 13x18 cm



ART. 41136 ↓ 15 ↔ 6,5 cm
ART. 41137 ↓ 20 ↔ 9 cm
ART. 41138 ↓ 25 ↔ 11 cm
ART. 41139 ↓ 30 ↔ 13 cm
ART. 41140 ↓ 40 ↔ 18 cm
ART. 41141 ↓ 50 ↔ 21,5 cm

NOVITÀ **NUOVA**
COLORAZIONE **SATÈN**

Finitura lucida



Finitura opaca



Per ordinazioni aggiungere al codice articolo la sigla STL. Disponibile solo sulle serie **RIFLESSI**.
To place orders add to the article code the letter STL. Only available on the **RIFLESSI** series.

Per ordinazioni aggiungere al codice articolo la sigla STO. Disponibile solo sulle serie **RIFLESSI**.
To place orders add to the article code the letter STO. Only available on the **RIFLESSI** series.

Finitura lucida

Finitura opaca

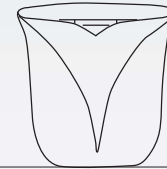

ART. 47301 P **P** ART. 47033 P **T**
 ↓ 20,5 ↔ 11,5 cm ↓ 20,5 ↔ 11,5 cm

ART. 47302 R ART. 47047 R
 ↓ 20,5 ↔ 11,5 cm ↓ 20,5 ↔ 11,5 cm

ART. 49339 P **P** ART. 49239 P **T**
 ↓ 17 ↔ 17 cm ↓ 17 ↔ 17 cm

ART. 49340 R ART. 49240 R
 ↓ 17 ↔ 17 cm ↓ 17 ↔ 17 cm



ART. 47300 P **P** ART. 47309 P **P**
 ↓ 12,5 ↔ 6 cm ↓ 13 ↔ 7,5 cm

ART. 47010 P **T**
 ↓ 13 ↔ 7,5 cm

ART. 46996 P **P** ART. 46696 T **T**
 ↓ 20 ↔ 13,5 cm ↓ 20 ↔ 13,5 cm



ART. 41136 ↓ 15 ↔ 6,5 cm
 ART. 41137 ↓ 20 ↔ 9 cm
 ART. 41138 ↓ 25 ↔ 11 cm

ART. 31636 8x10 cm
 ART. 40126 9x12 cm
 ART. 40128 11x15 cm

ART. 31663 8x10 cm
 ART. 40106 9x12 cm
 ART. 40107 11x15 cm

ART. 46302 Ø 5 P **P** ART. 46002 Ø 5 T **T**
 ↓ 19 ↔ 9 cm ↓ 19 ↔ 9 cm

ART. 46304 Ø 4 P **P** ART. 46004 Ø 4 T **T**
 ↓ 13 ↔ 6,5 cm ↓ 13 ↔ 6,5 cm



Per ordinazioni aggiungere al codice articolo la sigla corrispondente alla colorazione scelta.
 To place orders add to the article code the letter corresponding the selected colouring.

Per ordinazioni aggiungere al codice articolo la sigla corrispondente alla colorazione scelta.
 To place orders add to the article code the letter corresponding the selected colouring.

NOVITÀ



ART. 47301MO P
↓ 20,5 ↔ 11,5 cm



ART. 47300MO P
↓ 12,5 ↔ 6 cm



ART. 47309MO P
↓ 13 ↔ 7,5 cm



ART. 49339MO P
↓ 17 ↔ 17 cm

ART. 47302MO R
↓ 20,5 ↔ 11,5 cm

ART. 47047MO R
↓ 20,5 ↔ 11,5 cm

ART. 47010MO P
↓ 13 ↔ 7,5 cm

ART. 49340MO R
↓ 17 ↔ 17 cm

ART. 49239MO P
↓ 17 ↔ 17 cm

ART. 49240MO R
↓ 17 ↔ 17 cm



ART. 46996MO P
↓ 20 ↔ 13,5 cm

ART. 46696MO T
↓ 20 ↔ 13,5 cm



ART. 46302MO Ø 5
↓ 19 ↔ 9 cm

ART. 46002MO Ø 5
↓ 19 ↔ 9 cm



ART. 46304MO Ø 4
↓ 13 ↔ 6,5 cm

ART. 46004MO Ø 4
↓ 13 ↔ 6,5 cm



ART. 31633MO 7x9 cm
ART. 31663MO 8x10 cm
ART. 40106MO 9x12 cm
ART. 40107MO 11x15 cm
ART. 31664MO 13x18 cm



ART. 31635MO 7x9 cm
ART. 31636MO 8x10 cm
ART. 40126MO 9x12 cm
ART. 40127MO 10x15 cm
ART. 40128MO 11x15 cm
ART. 40139MO 13x18 cm



ART. 41136MO ↓ 15 ↔ 6,5 cm
ART. 41137MO ↓ 20 ↔ 9 cm
ART. 41138MO ↓ 25 ↔ 11 cm
ART. 41139MO ↓ 30 ↔ 13 cm
ART. 41140MO ↓ 40 ↔ 18 cm
ART. 41141MO ↓ 50 ↔ 21,5 cm

NOVITÀ



ART. 47301DU P
↓ 20,5 ↔ 11,5 cm

ART. 47033DU P T
↓ 20,5 ↔ 11,5 cm



ART. 47300DU P P
↓ 12,5 ↔ 6 cm



ART. 47309DU P P
↓ 13 ↔ 7,5 cm



ART. 49339DU P P
↓ 17 ↔ 17 cm

ART. 47302DU R
↓ 20,5 ↔ 11,5 cm

ART. 47047DU R
↓ 20,5 ↔ 11,5 cm

ART. 47010DU P T
↓ 13 ↔ 7,5 cm

ART. 49340DU R
↓ 17 ↔ 17 cm

ART. 49239DU P T
↓ 17 ↔ 17 cm

ART. 49240DU R
↓ 17 ↔ 17 cm



ART. 46996DU P
↓ 20 ↔ 13,5 cm

ART. 46696DU T
↓ 20 ↔ 13,5 cm



ART. 46302DU Ø 5 P
↓ 19 ↔ 9 cm

ART. 46002DU Ø 5 T
↓ 19 ↔ 9 cm



ART. 46304DU Ø 4 P
↓ 13 ↔ 6,5 cm

ART. 46004DU Ø 4 T
↓ 13 ↔ 6,5 cm



ART. 31633DU 7x9 cm
ART. 31663DU 8x10 cm
ART. 40106DU 9x12 cm
ART. 40107DU 11x15 cm
ART. 31664DU 13x18 cm



ART. 31635DU 7x9 cm
ART. 31636DU 8x10 cm
ART. 40126DU 9x12 cm
ART. 40127DU 10x15 cm
ART. 40128DU 11x15 cm
ART. 40139DU 13x18 cm



ART. 41136DU ↓ 15 ↔ 6,5 cm
ART. 41137DU ↓ 20 ↔ 9 cm
ART. 41138DU ↓ 25 ↔ 11 cm
ART. 41139DU ↓ 30 ↔ 13 cm
ART. 41140DU ↓ 40 ↔ 18 cm
ART. 41141DU ↓ 50 ↔ 21,5 cm

primaria lega patinata carrara



ART. 47301CA P
↓ 20,5 ↔ 11,5 cm

ART. 47033CA P T
↓ 20,5 ↔ 11,5 cm

ART. 47302CA R
↓ 20,5 ↔ 11,5 cm

ART. 47047CA R
↓ 20,5 ↔ 11,5 cm



ART. 47301BO P
↓ 20,5 ↔ 11,5 cm

ART. 47033BO P T
↓ 20,5 ↔ 11,5 cm

ART. 47302BO R
↓ 20,5 ↔ 11,5 cm

ART. 47047BO R
↓ 20,5 ↔ 11,5 cm



ART. 49339CA P
↓ 17 ↔ 17 cm

ART. 49239CA P T
↓ 17 ↔ 17 cm



ART. 47309CA P
↓ 13 ↔ 7,5 cm

ART. 47300CA P
↓ 12,5 ↔ 6 cm



ART. 47300BO P
↓ 12,5 ↔ 6 cm



ART. 47309BO P
↓ 13 ↔ 7,5 cm



ART. 49339BO P
↓ 17 ↔ 17 cm

ART. 49239BO P T
↓ 17 ↔ 17 cm

ART. 49340CA R
↓ 17 ↔ 17 cm

ART. 49240CA R
↓ 17 ↔ 17 cm

ART. 47010CA P T
↓ 13 ↔ 7,5 cm

ART. 47010BO P T
↓ 13 ↔ 7,5 cm

ART. 49340BO R
↓ 17 ↔ 17 cm

ART. 49240BO R
↓ 17 ↔ 17 cm



ART. 46996CA P
↓ 20 ↔ 13,5 cm

ART. 46696CA T
↓ 20 ↔ 13,5 cm



ART. 46302CA P
Ø 5 ↓ 19 ↔ 9 cm

ART. 46002CA T
Ø 5 ↓ 19 ↔ 9 cm



ART. 46304CA P
Ø 4 ↓ 13 ↔ 6,5 cm

ART. 46004CA T
Ø 4 ↓ 13 ↔ 6,5 cm



ART. 46304BO P
Ø 4 ↓ 13 ↔ 6,5 cm

ART. 46004BO T
Ø 4 ↓ 13 ↔ 6,5 cm



ART. 46302BO P
Ø 5 ↓ 19 ↔ 9 cm

ART. 46002BO T
Ø 5 ↓ 19 ↔ 9 cm



ART. 46996BO P
↓ 20 ↔ 13,5 cm

ART. 46696BO T
↓ 20 ↔ 13,5 cm

primaria lega patinata botticino



BRONZO



- | | | | | | |
|------------------------------------|------------------------------------|---------------------------------|---------------------------------|--------------------------------|--------------------------------|
| ART. 47301BI P
↓ 20,5 ↔ 11,5 cm | ART. 47033BI P
↓ 20,5 ↔ 11,5 cm | ART. 47300BI P
↓ 12,5 ↔ 6 cm | ART. 47309BI P
↓ 13 ↔ 7,5 cm | ART. 49339BI P
↓ 17 ↔ 17 cm | ART. 49239BI P
↓ 17 ↔ 17 cm |
| ART. 47302BI R
↓ 20,5 ↔ 11,5 cm | ART. 47047BI R
↓ 20,5 ↔ 11,5 cm | | ART. 47010BI P
↓ 13 ↔ 7,5 cm | ART. 49340BI R
↓ 17 ↔ 17 cm | ART. 49240BI R
↓ 17 ↔ 17 cm |



- ART. 46996BI P
↓ 20 ↔ 13,5 cm
- ART. 46696BI T
↓ 20 ↔ 13,5 cm



- ART. 46302BI P
Ø 5 ↓ 19 ↔ 9 cm
- ART. 46002BI T
Ø 5 ↓ 19 ↔ 9 cm



- ART. 46304BI P
Ø 4 ↓ 13 ↔ 6,5 cm
- ART. 46004BI T
Ø 4 ↓ 13 ↔ 6,5 cm



- ART. 31633BI 7x9 cm
- ART. 31663BI 8x10 cm
- ART. 40106BI 9x12 cm
- ART. 40107BI 11x15 cm
- ART. 31664BI 13x18 cm



- ART. 31635BI 7x9 cm
- ART. 31636BI 8x10 cm
- ART. 40126BI 9x12 cm
- ART. 40127BI 10x15 cm
- ART. 40128BI 11x15 cm
- ART. 40139BI 13x18 cm



- ART. 41136BI ↓ 15 cm
- ART. 41137BI ↓ 20 cm
- ART. 41138BI ↓ 25 cm
- ART. 41139BI ↓ 30 cm
- ART. 41140BI ↓ 40 cm
- ART. 41141BI ↓ 50 cm



ART. 47272 P T
↓ 28,5 ↔ 15 cm

ART. 47271 R
↓ 28,5 ↔ 15 cm



ART. 47303 P P
↓ 21 ↔ 11 cm

ART. 47304 R
↓ 21 ↔ 11 cm



ART. 47269 P T
↓ 21 ↔ 11 cm

ART. 47270 R
↓ 21 ↔ 11 cm



ART. 47307 P P
↓ 13,5 ↔ 7 cm

ART. 47267 P T
↓ 13,5 ↔ 7 cm



ART. 49335 P P
↓ 18 ↔ 16,5 cm

ART. 49336 R
↓ 18 ↔ 16,5 cm

ART. 49235 P T
↓ 18 ↔ 16,5 cm

ART. 49236 R
↓ 18 ↔ 16,5 cm



ART. 46694 T
↓ 23,5 ↔ 14 cm



ART. 46303 Ø 5 P
↓ 19,5 ↔ 7,5 cm

ART. 46010 Ø 5 T
↓ 19,5 ↔ 7,5 cm



ART. 46306 Ø 4 P
↓ 14 ↔ 6 cm

ART. 46009 Ø 4 T
↓ 14 ↔ 6 cm



ART. 40152 7x9 cm
ART. 40153 8x10 cm
ART. 40154 9x12 cm
ART. 40155 11x15 cm



ART. 40156 9x12 cm
ART. 40170 10x15 cm
ART. 40171 11x15 cm

Finitura lucida

Finitura opaca



ART. 47272 P **T**
 ↓ 28,5 ↔ 15 cm

ART. 47271 R
 ↓ 28,5 ↔ 15 cm

ART. 47303 P **P** ART. 47269 P **T**
 ↓ 21 ↔ 11 cm ↓ 21 ↔ 11 cm

ART. 47304 R ART. 47270 R
 ↓ 21 ↔ 11 cm ↓ 21 ↔ 11 cm

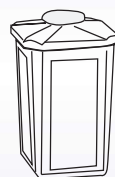

ART. 49335 P **P** ART. 49235 P **T**
 ↓ 18 ↔ 16,5 cm ↓ 18 ↔ 16,5 cm

ART. 49336 R ART. 49236 R
 ↓ 18 ↔ 16,5 cm ↓ 18 ↔ 16,5 cm

ART. 46694 **T**
 ↓ 23,5 ↔ 14 cm

ART. 47307 P **P** ART. 47267 P **T**
 ↓ 13,5 ↔ 7 cm ↓ 13,5 ↔ 7 cm



ART. 41136 ↓ 15 ↔ 6,5 cm
 ART. 41137 ↓ 20 ↔ 9 cm
 ART. 41138 ↓ 25 ↔ 11 cm

ART. 31636 8x10 cm
 ART. 40126 9x12 cm
 ART. 40128 11x15 cm

ART. 31663 8x10 cm
 ART. 40106 9x12 cm
 ART. 40107 11x15 cm

ART. 46303 Ø 5 **P** ART. 46010 Ø 5 **T**
 ↓ 19,5 ↔ 7,5 cm ↓ 19,5 ↔ 7,5 cm

ART. 46306 Ø 4 **P** ART. 46009 Ø 4 **T**
 ↓ 14 ↔ 6 cm ↓ 14 ↔ 6 cm



VEL VERDE LUCIDO
BIL BIANCO LUCIDO
BLL BLU LUCIDO
VIL VIOLA LUCIDO
ROL ROSSO LUCIDO
TOL TORTORA LUCIDO
BEL BEIGE LUCIDO
AZL AZZURRO LUCIDO
STL SATÈN LUCIDO



VEO VERDE OPACO
BIO BIANCO OPACO
BLO BLU OPACO
VIO VIOLA OPACO
ROO ROSSO OPACO
TOO TORTORA OPACO
BEO BEIGE OPACO
AZO AZZURRO OPACO
STO SATÈN OPACO

Per ordinazioni aggiungere al codice articolo la sigla corrispondente alla colorazione scelta,
 To place orders add to the article code the letter corresponding to the selected colouring.

Per ordinazioni aggiungere al codice articolo la sigla corrispondente alla colorazione scelta,
 To place orders add to the article code the letter corresponding to the selected colouring.

NOVITÀ



ART. 47272MO P **T**
↓ 28,5 ↔ 15 cm

ART. 47271MO R
↓ 28,5 ↔ 15 cm



ART. 47303MO P **P**
↓ 21 ↔ 11 cm

ART. 47304MO R
↓ 21 ↔ 11 cm

ART. 47269MO P **T**
↓ 21 ↔ 11 cm

ART. 47270MO R
↓ 21 ↔ 11 cm



ART. 47307MO P **P**
↓ 13,5 ↔ 7 cm

ART. 47267MO P **T**
↓ 13,5 ↔ 7 cm



ART. 49335MO P **P**
↓ 18 ↔ 16,5 cm

ART. 49336MO R
↓ 18 ↔ 16,5 cm

ART. 49235MO P **T**
↓ 18 ↔ 16,5 cm

ART. 49236MO R
↓ 18 ↔ 16,5 cm



ART. 46694MO **T**
↓ 23,5 ↔ 14 cm



ART. 46303MO Ø 5 **P**
↓ 19,5 ↔ 7,5 cm

ART. 46010MO Ø 5 **T**
↓ 19,5 ↔ 7,5 cm



ART. 46306MO Ø 4 **P**
↓ 14 ↔ 6 cm

ART. 46009MO Ø 4 **T**
↓ 14 ↔ 6 cm



ART. 40152MO 7x9 cm
ART. 40153MO 8x10 cm
ART. 40154MO 9x12 cm
ART. 40155MO 11x15 cm



ART. 40156MO 9x12 cm
ART. 40170MO 10x15 cm
ART. 40171MO 11x15 cm



ART. 47312 P
↓ 21 ↔ 11 cm

ART. 47273 P T
↓ 21 ↔ 11 cm



ART. 47315 P
↓ 13 ↔ 7 cm

ART. 47275 P T
↓ 13 ↔ 7 cm



ART. 49312 P
↓ 17,5 ↔ 16,5 cm

ART. 49212 P T
↓ 17,5 ↔ 16,5 cm



ART. 46312 Ø 5 P
↓ 20 ↔ 9 cm

ART. 46012 Ø 5 T
↓ 20 ↔ 9 cm



ART. 46315 Ø 4 P
↓ 13,5 ↔ 7 cm

ART. 46016 Ø 4 T
↓ 13,5 ↔ 7 cm



ART. 46948 P
↓ 19 ↔ 13,5 cm

ART. 46695 T
↓ 19 ↔ 13,5 cm



ART. 31633 7x9 cm
ART. 31663 8x10 cm
ART. 40106 9x12 cm
ART. 40107 11x15 cm
ART. 31664 13x18 cm



ART. 31635 7x9 cm
ART. 31636 8x10 cm
ART. 40126 9x12 cm
ART. 40127 10x15 cm
ART. 40128 11x15 cm
ART. 40139 13x18 cm



ART. 41136 ↓ 15 ↔ 6,5 cm
ART. 41137 ↓ 20 ↔ 9 cm
ART. 41138 ↓ 25 ↔ 11 cm
ART. 41139 ↓ 30 ↔ 13 cm
ART. 41140 ↓ 40 ↔ 18 cm
ART. 41141 ↓ 50 ↔ 21,5 cm

Finitura lucida



VEL
VERDE LUCIDO



ROL
ROSSO LUCIDO



TOL
TORTORA LUCIDO



AZL
AZZURRO LUCIDO



ART. 47312 P
↓ 21 ↔ 11 cm

ART. 47313 R
↓ 21 ↔ 11 cm

ART. 47273 P T
↓ 21 ↔ 11 cm

ART. 47274 R
↓ 21 ↔ 11 cm



ART. 47315 P
↓ 13 ↔ 7 cm

ART. 47316 R
↓ 13 ↔ 7 cm

ART. 47275 P T
↓ 13 ↔ 7 cm

ART. 47276 R
↓ 13 ↔ 7 cm

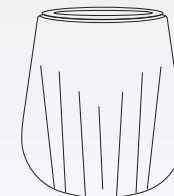

ART. 49312 P
↓ 17,5 ↔ 16,5 cm

ART. 49313 R
↓ 17,5 ↔ 16,5 cm

ART. 49212 P T
↓ 17,5 ↔ 16,5 cm

ART. 49213 R
↓ 17,5 ↔ 16,5 cm



ART. 46312 Ø 5 P
↓ 20 ↔ 9 cm

ART. 46012 Ø 5 T
↓ 20 ↔ 9 cm

ART. 46315 Ø 4 P
↓ 13,5 ↔ 7 cm

ART. 46016 Ø 4 T
↓ 13,5 ↔ 7 cm

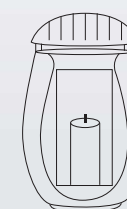

ART. 46948 P
↓ 19 ↔ 13,5 cm

ART. 46695 T
↓ 19 ↔ 13,5 cm

Per ordinazioni aggiungere al codice articolo la sigla corrispondente alla colorazione scelta,
To place orders add to the article code the letter corresponding the selected colouring.

Per ordinazioni aggiungere al codice articolo la sigla corrispondente alla colorazione scelta,
To place orders add to the article code the letter corresponding the selected colouring.



ART. 47305 P
↓ 20 ↔ 12 cm

ART. 47105 P T
↓ 20 ↔ 12 cm

ART. 47306 R
↓ 20 ↔ 12 cm

ART. 47106 R
↓ 20 ↔ 12 cm



ART. 49365 P
↓ 18 ↔ 18 cm

ART. 49165 P T
↓ 18 ↔ 18 cm

ART. 49366 R
↓ 18 ↔ 18 cm

ART. 49166 R
↓ 18 ↔ 18 cm



ART. 46305 Ø 5
↓ 19 ↔ 8,5 cm

ART. 46105 Ø 5 T
↓ 19 ↔ 8,5 cm



ART. 46991 4gg P
↓ 18 ↔ 13 cm

ART. 46901 4gg T
↓ 18 ↔ 13 cm



ART. 40102 8x10 cm
ART. 40100 9x12 cm
ART. 40101 11x15 cm
ART. 40103 13x18 cm
ART. 40104 18x24 cm



ART. 40119 8x10 cm
ART. 40120 9x12 cm
ART. 40122 10x15 cm
ART. 40121 11x15 cm
ART. 40124 13x18 cm
ART. 40123 18x24 cm

Finitura lucida

Finitura opaca



ART. 47305 P $\updownarrow 20 \leftrightarrow 12$ cm
 ART. 47306 R $\updownarrow 20 \leftrightarrow 12$ cm
 ART. 47105 P $\updownarrow 20 \leftrightarrow 12$ cm
 ART. 47106 R $\updownarrow 20 \leftrightarrow 12$ cm

ART. 46991 4gg $\updownarrow 18 \leftrightarrow 13$ cm
 ART. 46901 4gg $\updownarrow 18 \leftrightarrow 13$ cm

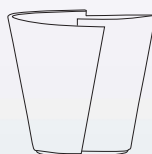

ART. 46305 Ø 5 P $\updownarrow 19 \leftrightarrow 8,5$ cm
 ART. 46105 Ø 5 T $\updownarrow 19 \leftrightarrow 8,5$ cm
 ART. 49365 P $\updownarrow 18 \leftrightarrow 18$ cm
 ART. 49165 P $\updownarrow 18 \leftrightarrow 18$ cm
 ART. 49366 R $\updownarrow 18 \leftrightarrow 18$ cm
 ART. 49166 R $\updownarrow 18 \leftrightarrow 18$ cm



Per ordinazioni aggiungere al codice articolo la sigla corrispondente alla colorazione scelta.
 To place orders add to the article code the letter corresponding to the selected colouring.

Per ordinazioni aggiungere al codice articolo la sigla corrispondente alla colorazione scelta.
 To place orders add to the article code the letter corresponding to the selected colouring.



ART. 47019 P
↓ 28 ↔ 17 cm

ART. 47018 R
↓ 28 ↔ 17 cm



ART. 47515 P
↓ 20 ↔ 12 cm

ART. 47514 R
↓ 20 ↔ 12 cm

ART. 47503 P
↓ 12 ↔ 7 cm

ART. 47502 R
↓ 12 ↔ 7 cm



ART. 49515 P
↓ 18 ↔ 17 cm

ART. 49514 R
↓ 18 ↔ 17 cm



ART. 46018 Ø6
↓ 26 ↔ 14 cm



ART. 46515 Ø5
↓ 19 ↔ 9 cm

ART. 46502 Ø4
↓ 14 ↔ 7 cm



ART. 46943 P
↓ 21 ↔ 13 cm

ART. 46843 T
↓ 21 ↔ 13 cm



ART. 46844 T
↓ 27 ↔ 15 cm



ART. 46960 P
↓ 21 ↔ 13 cm

ART. 46762 T
↓ 21 ↔ 13 cm



ART. 46760 T
↓ 23 ↔ 13 cm



ART. 47021 P
↓ 28 ↔ 17 cm

ART. 47020 R
↓ 28 ↔ 17 cm



ART. 47517 P
↓ 20 ↔ 12 cm

ART. 47516 R
↓ 20 ↔ 12 cm

ART. 47546 P
↓ 12 ↔ 7 cm

ART. 47543 R
↓ 12 ↔ 7 cm



ART. 47017 P
↓ 20 ↔ 12 cm

ART. 47016 R
↓ 20 ↔ 12 cm

ART. 47046 P
↓ 12 ↔ 7 cm

ART. 47043 R
↓ 12 ↔ 7 cm



ART. 49517 P
↓ 18 ↔ 17 cm

ART. 49516 R
↓ 18 ↔ 17 cm

ART. 49017 P
↓ 18 ↔ 17 cm

ART. 49016 R
↓ 18 ↔ 17 cm



ART. 46020 Ø6
↓ 24 ↔ 14 cm



ART. 46517 Ø5
↓ 19 ↔ 9 cm

ART. 46543 Ø4
↓ 14 ↔ 7 cm

ART. 46017 Ø5
↓ 19 ↔ 9 cm

ART. 46043 Ø4
↓ 14 ↔ 7 cm



Finitura lucida

Finitura opaco



ART. 47019 P **T**
 ↓ 28 ↔ 17 cm

ART. 47018 R
 ↓ 28 ↔ 17 cm

ART. 46515 Ø 5 **P**
 ↓ 19 ↔ 9 cm

ART. 46015 Ø 5 **T**
 ↓ 19 ↔ 9 cm

ART. 46502 Ø 4
 ↓ 14 ↔ 7 cm

ART. 46013 Ø 4 **T**
 ↓ 14 ↔ 7 cm

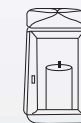

ART. 47515 P **P**
 ↓ 20 ↔ 12 cm

ART. 47514 R
 ↓ 20 ↔ 12 cm

ART. 47503 P
 ↓ 12 ↔ 7 cm

ART. 47502 R
 ↓ 12 ↔ 7 cm

ART. 47015 P **T**
 ↓ 20 ↔ 12 cm

ART. 47014 R
 ↓ 20 ↔ 12 cm

ART. 47013 P
 ↓ 12 ↔ 7 cm

ART. 47012 R
 ↓ 12 ↔ 7 cm

ART. 49515 P **P**
 ↓ 18 ↔ 17 cm

ART. 49514 R
 ↓ 18 ↔ 17 cm

ART. 49015 P **T**
 ↓ 18 ↔ 17 cm

ART. 49014 R
 ↓ 18 ↔ 17 cm

ART. 46018 Ø 6 **T**
 ↓ 26 ↔ 14 cm

ART. 46844 P **T**
 ↓ 27 ↔ 15 cm

ART. 46943 **P**
 ↓ 21 ↔ 13 cm

ART. 46843 **T**
 ↓ 21 ↔ 13 cm



VEL VERDE LUCIDO

BIL BIANCO LUCIDO

BLL BLU LUCIDO

VIL VIOLA LUCIDO

ROL ROSSO LUCIDO

TOL TORTORA LUCIDO

BEL BEIGE LUCIDO

AZL AZZURRO LUCIDO

STL SATÈN LUCIDO

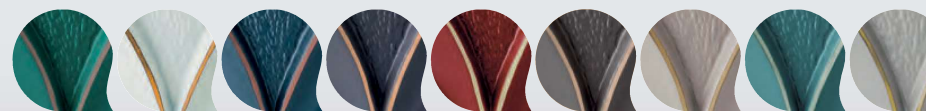

VEO VERDE OPACO

BIO BIANCO OPACO

BLO BLU OPACO

VIO VIOLA OPACO

ROO ROSSO OPACO

TOO TORTORA OPACO

BEO BEIGE OPACO

AZO AZZURRO OPACO

STO SATÈN OPACO

Per ordinazioni aggiungere al codice articolo la sigla corrispondente alla colorazione scelta,
 To place orders add to the article code the letter corresponding to the selected colouring.

Per ordinazioni aggiungere al codice articolo la sigla corrispondente alla colorazione scelta,
 To place orders add to the article code the letter corresponding to the selected colouring.

NOVITÀ



ART. 47019MO P T
↓ 28 ↔ 17 cm

ART. 47018MO R
↓ 28 ↔ 17 cm



ART. 47515MO P P
↓ 20 ↔ 12 cm

ART. 47514MO R
↓ 20 ↔ 12 cm

ART. 47503MO P
↓ 12 ↔ 7 cm

ART. 47502MO R
↓ 12 ↔ 7 cm



ART. 49515MO P P
↓ 18 ↔ 17 cm

ART. 49514MO R
↓ 18 ↔ 17 cm

ART. 49015MO P T
↓ 18 ↔ 17 cm

ART. 49014MO R
↓ 18 ↔ 17 cm



ART. 46018MO Ø6 T
↓ 26 ↔ 14 cm



ART. 46515MO Ø5 P
↓ 19 ↔ 9 cm

ART. 46502MO Ø4
↓ 14 ↔ 7 cm

ART. 46015MO Ø5 T
↓ 19 ↔ 9 cm

ART. 46013MO Ø4
↓ 14 ↔ 7 cm



ART. 46960MO P
↓ 21 ↔ 13 cm

ART. 46762MO T
↓ 21 ↔ 13 cm



ART. 46760MO T
↓ 23 ↔ 13 cm



ART. 31633MO 7x9 cm
ART. 31663MO 8x10 cm
ART. 40106MO 9x12 cm
ART. 40107MO 11x15 cm
ART. 31664MO 13x18 cm



ART. 31635MO 7x9 cm
ART. 31636MO 8x10 cm
ART. 40126MO 9x12 cm
ART. 40127MO 10x15 cm
ART. 40128MO 11x15 cm
ART. 40139MO 13x18 cm



ART. 41136MO ↓ 15 ↔ 6,5 cm
ART. 41137MO ↓ 20 ↔ 9 cm
ART. 41138MO ↓ 25 ↔ 11 cm
ART. 41139MO ↓ 30 ↔ 13 cm
ART. 41140MO ↓ 40 ↔ 18 cm
ART. 41141MO ↓ 50 ↔ 21,5 cm



ART. 47208 P ↓ 28 ↔ 16 cm	ART. 47337 P ↓ 21 ↔ 13 cm	ART. 47237 P ↓ 21 ↔ 13 cm	ART. 47331 P ↓ 13 ↔ 7 cm	ART. 47259 P ↓ 13 ↔ 7,5 cm	ART. 49337 P ↓ 20 ↔ 17 cm	ART. 49237 P ↓ 20 ↔ 17 cm
ART. 47209 R ↓ 28 ↔ 16 cm	ART. 47338 R ↓ 21 ↔ 13 cm	ART. 47238 R ↓ 21 ↔ 13 cm	ART. 47332 R ↓ 13 ↔ 7 cm	ART. 47260 R ↓ 13 ↔ 7,5 cm	ART. 49338 R ↓ 20 ↔ 17 cm	ART. 49238 R ↓ 20 ↔ 17 cm



ART. 46331 Ø 4 ↓ 13,5 ↔ 7,5 cm	ART. 46337 Ø 5 ↓ 20 ↔ 9 cm	ART. 46798 ↓ 25 ↔ 14 cm	ART. 46926 ↓ 20 ↔ 14 cm
ART. 46259 Ø 4 ↓ 13,5 ↔ 7,5 cm	ART. 46237 Ø 5 ↓ 20 ↔ 9 cm		ART. 46797 ↓ 20 ↔ 14 cm



ART. 46919 P ↓ 17 ↔ 12 cm	ART. 31633 7x9 cm	ART. 31635 7x9 cm	ART. 41136 ↓ 15 ↔ 6,5 cm
ART. 46795 T ↓ 17 ↔ 12 cm	ART. 31663 8x10 cm	ART. 31636 8x10 cm	ART. 41137 ↓ 20 ↔ 9 cm
	ART. 40106 9x12 cm	ART. 40126 9x12 cm	ART. 41138 ↓ 25 ↔ 11 cm
	ART. 40107 11x15 cm	ART. 40127 10x15 cm	ART. 41139 ↓ 30 ↔ 13 cm
	ART. 31664 13x18 cm	ART. 40128 11x15 cm	ART. 41140 ↓ 40 ↔ 18 cm
		ART. 40139 13x18 cm	ART. 41141 ↓ 50 ↔ 21,5 cm

NOVITÀ



ART. 47208DU P
↓ 28 ↔ 16 cm

ART. 47209DU R
↓ 28 ↔ 16 cm



ART. 47337DU P
↓ 21 ↔ 13 cm

ART. 47338DU R
↓ 21 ↔ 13 cm



ART. 47331DU P
↓ 13 ↔ 7 cm

ART. 47332DU R
↓ 13 ↔ 7 cm



ART. 49337DU P
↓ 20 ↔ 17 cm

ART. 49338DU R
↓ 20 ↔ 17 cm

ART. 47237DU P
↓ 21 ↔ 13 cm

ART. 47238DU R
↓ 21 ↔ 13 cm

ART. 47259DU P
↓ 13 ↔ 7,5 cm

ART. 47260DU R
↓ 13 ↔ 7,5 cm

ART. 49237DU P
↓ 20 ↔ 17 cm

ART. 49238DU R
↓ 20 ↔ 17 cm



ART. 46331DU Ø 4
↓ 13,5 ↔ 7,5 cm

ART. 46259DU Ø 4
↓ 13,5 ↔ 7,5 cm



ART. 46337DU Ø 5
↓ 20 ↔ 9 cm

ART. 46237DU Ø 5
↓ 20 ↔ 9 cm



ART. 46798DU
↓ 25 ↔ 14 cm



ART. 46926DU
↓ 20 ↔ 14 cm



ART. 46919DU
↓ 17 ↔ 12 cm

ART. 46797DU
↓ 20 ↔ 14 cm

ART. 46795DU
↓ 17 ↔ 12 cm



ART. 31633DU 7x9 cm
ART. 31663DU 8x10 cm
ART. 40106DU 9x12 cm
ART. 40107DU 11x15 cm
ART. 31664DU 13x18 cm



ART. 31635DU 7x9 cm
ART. 31636DU 8x10 cm
ART. 40126DU 9x12 cm
ART. 40127DU 10x15 cm
ART. 40128DU 11x15 cm
ART. 40139DU 13x18 cm



ART. 41136DU ↓ 15 ↔ 6,5 cm
ART. 41137DU ↓ 20 ↔ 9 cm
ART. 41138DU ↓ 25 ↔ 11 cm
ART. 41139DU ↓ 30 ↔ 13 cm
ART. 41140DU ↓ 40 ↔ 18 cm
ART. 41141DU ↓ 50 ↔ 21,5 cm



ART. 47647 P
↓ 28 ↔ 17 cm

ART. 47147 P T
↓ 28 ↔ 17 cm

ART. 47648 R
↓ 28 ↔ 17 cm

ART. 47148 R
↓ 28 ↔ 17 cm



ART. 47646 P
↓ 20 ↔ 13 cm

ART. 47146 P T
↓ 20 ↔ 13 cm

ART. 47645 R
↓ 20 ↔ 13 cm

ART. 47145 R
↓ 20 ↔ 13 cm



ART. 47655 P
↓ 13 ↔ 7 cm

ART. 47155 P T
↓ 13 ↔ 7 cm

ART. 47654 R
↓ 13 ↔ 7 cm

ART. 47154 R
↓ 13 ↔ 7 cm



ART. 49657 P
↓ 19 ↔ 17 cm

ART. 49157 P T
↓ 19 ↔ 17 cm

ART. 49656 R
↓ 19 ↔ 17 cm

ART. 49156 R
↓ 19 ↔ 17 cm



ART. 46647 Ø 6
↓ 27 ↔ 13 cm

ART. 46147 Ø 6
↓ 27 ↔ 13 cm



ART. 46645 Ø 5
↓ 19 ↔ 9,5 cm

ART. 46145 Ø 5
↓ 19 ↔ 9,5 cm



ART. 46654 Ø 4
↓ 13 ↔ 7 cm

ART. 46154 Ø 4
↓ 13 ↔ 7 cm



ART. 49662 P
↓ 16 ↔ 19 cm

ART. 49663 R
↓ 16 ↔ 19 cm



ART. 49507 P
↓ 11,5 ↔ 37,5 cm



ART. 46653 Ø 5
↓ 19 ↔ 10 cm



ART. 46930 P
↓ 18 ↔ 13 cm

ART. 46830 T
↓ 18 ↔ 13 cm

ART. 46831
↓ 22 ↔ 17 cm



ART. 46825 T
↓ 27 ↔ 15 cm



ART. 47469 P T
↓ 8 ↔ 17 cm

ART. 47468 R
↓ 8 ↔ 17 cm



ART. 46895 T
Ø 5 ↓ 16 ↔ 9 cm

NOVITÀ



ART. 47647DU P
↓ 28 ↔ 17 cm

ART. 47147DU P T
↓ 28 ↔ 17 cm

ART. 47646DU P P
↓ 20 ↔ 13 cm

ART. 47146DU P T
↓ 20 ↔ 13 cm

ART. 47655DU P P
↓ 13 ↔ 7 cm

ART. 47155DU P T
↓ 13 ↔ 7 cm

ART. 47648DU R
↓ 28 ↔ 17 cm

ART. 47148DU R
↓ 28 ↔ 17 cm

ART. 47645DU R
↓ 20 ↔ 13 cm

ART. 47145DU R
↓ 20 ↔ 13 cm

ART. 47654DU R
↓ 13 ↔ 7 cm

ART. 47154DU R
↓ 13 ↔ 7 cm



ART. 49657DU P P
↓ 19 ↔ 17 cm

ART. 49157DU P T
↓ 19 ↔ 17 cm

ART. 46647DU Ø 6 P
↓ 27 ↔ 13 cm

ART. 46645DU Ø 5 P
↓ 19 ↔ 9,5 cm

ART. 46654DU Ø 4 P
↓ 13 ↔ 7 cm

ART. 49656DU R
↓ 19 ↔ 17 cm

ART. 49156DU R
↓ 19 ↔ 17 cm

ART. 46147DU Ø 6 T
↓ 27 ↔ 13 cm

ART. 46145DU Ø 5 T
↓ 19 ↔ 9,5 cm

ART. 46154DU Ø 4 T
↓ 13 ↔ 7 cm



ART. 49662DU P P
↓ 16 ↔ 19 cm

ART. 49663DU R
↓ 16 ↔ 19 cm



ART. 46653DU Ø 5 P
↓ 19 ↔ 10 cm



ART. 46930DU P
↓ 18 ↔ 13 cm

ART. 46830DU T
↓ 18 ↔ 13 cm



ART. 46825DU T
↓ 27 ↔ 15 cm



ART. 47469DU P T
↓ 8 ↔ 17 cm

ART. 47468DU R
↓ 8 ↔ 17 cm



ART. 46895DU T
Ø 5 ↓ 16 ↔ 9 cm



ART. 47566 P
↓ 28 ↔ 17 cm

ART. 47565 R
↓ 28 ↔ 17 cm



ART. 47199 P
↓ 28 ↔ 17 cm

ART. 47198 R
↓ 28 ↔ 17 cm



ART. 47564 P
↓ 20 ↔ 13 cm

ART. 47558 R
↓ 20 ↔ 13 cm

ART. 47159 P
↓ 20 ↔ 13 cm

ART. 47158 R
↓ 20 ↔ 13 cm



ART. 47561 P
↓ 13 ↔ 7 cm

ART. 47563 R
↓ 13 ↔ 7 cm

ART. 47157 P
↓ 13 ↔ 7 cm

ART. 47156 R
↓ 13 ↔ 7 cm

ART. 49659 P
↓ 20 ↔ 13 cm

ART. 49658 R
↓ 20 ↔ 13 cm

ART. 49159 P
↓ 20 ↔ 13 cm

ART. 49158 R
↓ 20 ↔ 13 cm



ART. 46598 Ø 6
↓ 27 ↔ 13 cm

ART. 46198 Ø 6
↓ 27 ↔ 13 cm



ART. 46558 Ø 5
↓ 19 ↔ 9,5 cm

ART. 46158 Ø 5
↓ 19 ↔ 9,5 cm



ART. 46557 Ø 4
↓ 13 ↔ 7 cm

ART. 46156 Ø 4
↓ 13 ↔ 7 cm



ART. 49660 P
↓ 16 ↔ 19 cm

ART. 49661 R
↓ 16 ↔ 19 cm



ART. 49509 P
↓ 11,5 ↔ 37,5 cm



ART. 46652 Ø 5
↓ 19 ↔ 10 cm



ART. 46998
↓ 18 ↔ 13 cm

ART. 46898
↓ 18 ↔ 13 cm

ART. 46899
↓ 22 ↔ 17 cm



ART. 46700
↓ 27 ↔ 15 cm



ART. 47471 P
↓ 8 ↔ 17 cm

ART. 47470 R
↓ 8 ↔ 17 cm



ART. 46701
Ø 5 ↓ 16 ↔ 9 cm



ART. 47472 R
↓ 13 ↔ 17 cm

ART. 47473 P
↓ 13 ↔ 17 cm



ART. 46702
↓ 13 ↔ 17 cm

primaria lega patinata carrara

primaria lega patinata botticino



ART. 47647CA P
↓ 28 ↔ 17 cm
ART. 47648CA R
↓ 28 ↔ 17 cm
ART. 47147CA P
↓ 28 ↔ 17 cm
ART. 47148CA R
↓ 28 ↔ 17 cm

ART. 47647BO P
↓ 28 ↔ 17 cm
ART. 47648BO R
↓ 28 ↔ 17 cm
ART. 47147BO P
↓ 28 ↔ 17 cm
ART. 47148BO R
↓ 28 ↔ 17 cm



ART. 47646CA P
↓ 20 ↔ 13 cm
ART. 47645CA R
↓ 20 ↔ 13 cm
ART. 47146CA P
↓ 20 ↔ 13 cm
ART. 47145CA R
↓ 20 ↔ 13 cm

ART. 47655CA P
↓ 13 ↔ 7 cm
ART. 47654CA R
↓ 13 ↔ 7 cm
ART. 47155CA P
↓ 13 ↔ 7 cm
ART. 47154CA R
↓ 13 ↔ 7 cm

ART. 47655BO P
↓ 13 ↔ 7 cm
ART. 47654BO R
↓ 13 ↔ 7 cm
ART. 47155BO P
↓ 13 ↔ 7 cm
ART. 47154BO R
↓ 13 ↔ 7 cm

ART. 47646BO P
↓ 20 ↔ 13 cm
ART. 47645BO R
↓ 20 ↔ 13 cm
ART. 47146BO P
↓ 20 ↔ 13 cm
ART. 47145BO R
↓ 20 ↔ 13 cm



ART. 49657CA P
↓ 19 ↔ 17 cm
ART. 49656CA R
↓ 19 ↔ 17 cm
ART. 49157CA P
↓ 19 ↔ 17 cm
ART. 49156CA R
↓ 19 ↔ 17 cm

ART. 49662CA P
↓ 16 ↔ 19 cm
ART. 49663CA R
↓ 16 ↔ 19 cm

ART. 47469CA P
↓ 8 ↔ 17 cm
ART. 47468CA R
↓ 8 ↔ 17 cm

ART. 47469BO P
↓ 8 ↔ 17 cm
ART. 47468BO R
↓ 8 ↔ 17 cm

ART. 49662BO P
↓ 16 ↔ 19 cm
ART. 49663BO R
↓ 16 ↔ 19 cm

ART. 49657BO P
↓ 19 ↔ 17 cm
ART. 49656BO R
↓ 19 ↔ 17 cm
ART. 49157BO P
↓ 19 ↔ 17 cm
ART. 49156BO R
↓ 19 ↔ 17 cm



ART. 46647CA P
Ø 6 ↓ 27 ↔ 13 cm

ART. 46645CA P
Ø 5 ↓ 19 ↔ 9,5 cm

ART. 46654CA P
Ø 4 ↓ 13 ↔ 7 cm

ART. 46653CA P
Ø 5 ↓ 19 ↔ 10 cm

ART. 46895CA T
Ø 5 ↓ 16 ↔ 9 cm

ART. 46895BO T
Ø 5 ↓ 16 ↔ 9 cm

ART. 46653BO P
Ø 5 ↓ 19 ↔ 10 cm

ART. 46654BO P
Ø 4 ↓ 13 ↔ 7 cm

ART. 46645BO P
Ø 5 ↓ 19 ↔ 9,5 cm

ART. 46647BO P
Ø 6 ↓ 27 ↔ 13 cm

ART. 46147CA T
Ø 6 ↓ 27 ↔ 13 cm

ART. 46145CA T
Ø 5 ↓ 19 ↔ 9,5 cm

ART. 46154CA T
Ø 4 ↓ 13 ↔ 7 cm

ART. 46154BO T
Ø 4 ↓ 13 ↔ 7 cm

ART. 46145BO T
Ø 5 ↓ 19 ↔ 9,5 cm

ART. 46147BO T
Ø 6 ↓ 27 ↔ 13 cm



ART. 46930CA 4GG P
↓ 18 ↔ 13 cm
ART. 46830CA 4GG T
↓ 18 ↔ 13 cm
ART. 46831CA 6GG T
↓ 22 ↔ 17 cm

ART. 46960CA 4GG P
↓ 21 ↔ 13 cm
ART. 46762CA 4GG T
↓ 21 ↔ 13 cm
ART. 46825CA 8GG T
↓ 27 ↔ 15 cm

ART. 47467CA P T
↓ 13 ↔ 17 cm
ART. 47466CA R T
↓ 13 ↔ 17 cm

ART. 47467BO P T
↓ 13 ↔ 17 cm
ART. 47466BO R T
↓ 13 ↔ 17 cm

ART. 46960BO 4GG P
↓ 21 ↔ 13 cm
ART. 46762BO 4GG T
↓ 21 ↔ 13 cm
ART. 46825BO 8GG T
↓ 27 ↔ 15 cm

ART. 46930BO 4GG P
↓ 18 ↔ 13 cm
ART. 46830BO 4GG T
↓ 18 ↔ 13 cm
ART. 46831BO 6GG T
↓ 22 ↔ 17 cm



ART. 47215 P T
↓ 28 ↔ 18 cm

ART. 47216 R
↓ 28 ↔ 18 cm



ART. 47319 P P
↓ 20 ↔ 12 cm

ART. 47219 P T
↓ 20 ↔ 12 cm

ART. 47320 R
↓ 20 ↔ 12 cm

ART. 47220 R
↓ 20 ↔ 12 cm



ART. 49319 P P
↓ 17 ↔ 17 cm

ART. 49219 P T
↓ 17 ↔ 17 cm

ART. 49320 R
↓ 17 ↔ 17 cm

ART. 49220 R
↓ 17 ↔ 17 cm



ART. 46765 T
↓ 25 ↔ 16 cm



ART. 46959 P
↓ 19 ↔ 13,5 cm

ART. 46759 T
↓ 19 ↔ 13,5 cm



ART. 46319 Ø5 P
↓ 20 ↔ 8,5 cm

ART. 46219 Ø5 T
↓ 20 ↔ 8,5 cm



ART. 47217 P T
↓ 28 ↔ 18 cm

ART. 47218 R
↓ 28 ↔ 18 cm



ART. 47321 P P
↓ 20 ↔ 12 cm

ART. 47221 P T
↓ 20 ↔ 12 cm

ART. 47322 R
↓ 20 ↔ 12 cm

ART. 47222 R
↓ 20 ↔ 12 cm



ART. 49321 P P
↓ 17 ↔ 17 cm

ART. 49221 P T
↓ 17 ↔ 17 cm

ART. 49322 R
↓ 17 ↔ 17 cm

ART. 49222 R
↓ 17 ↔ 17 cm



ART. 46767 T
↓ 25 ↔ 16 cm



ART. 46966 P
↓ 19 ↔ 13,5 cm

ART. 46766 T
↓ 19 ↔ 13,5 cm



ART. 46321 Ø5 P
↓ 20 ↔ 8,5 cm

ART. 46221 Ø5 T
↓ 20 ↔ 8,5 cm



ART. 47055 P
↓ 28 ↔ 17 cm

ART. 47053 R
↓ 28 ↔ 17 cm



ART. 47550 P
↓ 19 ↔ 10,5 cm
ART. 47551 R
↓ 19 ↔ 10,5 cm
ART. 47678 P
↓ 12 ↔ 7 cm
ART. 47689 R
↓ 12 ↔ 7 cm

ART. 47050 P
↓ 19 ↔ 10,5 cm
ART. 47051 R
↓ 19 ↔ 10,5 cm
ART. 47178 P
↓ 12 ↔ 7 cm
ART. 47189 R
↓ 12 ↔ 7 cm



ART. 49560 P
↓ 17 ↔ 17 cm
ART. 49060 P
↓ 17 ↔ 17 cm
ART. 49561 R
↓ 17 ↔ 17 cm
ART. 49061 R
↓ 17 ↔ 17 cm



ART. 46560 Ø5
↓ 19 ↔ 8 cm
ART. 46678 Ø4
↓ 13 ↔ 7 cm

ART. 46060 Ø5
↓ 19 ↔ 8 cm
ART. 46178 Ø4
↓ 13 ↔ 7 cm



ART. 49562 P
↓ 18 ↔ 18,5 cm



ART. 46562 Ø5
↓ 18 ↔ 11,5 cm



ART. 46930 P
↓ 18 ↔ 13 cm
ART. 46830
↓ 18 ↔ 13 cm
ART. 46831
↓ 22 ↔ 17 cm



ART. 47152 P
↓ 28 ↔ 17 cm
ART. 47149 R
↓ 28 ↔ 17 cm



ART. 47650 P
↓ 19 ↔ 10,5 cm
ART. 47651 R
↓ 19 ↔ 10,5 cm
ART. 47676 P
↓ 12 ↔ 7 cm
ART. 47677 R
↓ 12 ↔ 7 cm

ART. 47150 P
↓ 19 ↔ 10,5 cm
ART. 47151 R
↓ 19 ↔ 10,5 cm
ART. 47176 P
↓ 12 ↔ 7 cm
ART. 47177 R
↓ 12 ↔ 7 cm



ART. 49654 P
↓ 17 ↔ 17 cm
ART. 49154 P
↓ 17 ↔ 17 cm
ART. 49655 R
↓ 17 ↔ 17 cm
ART. 49155 R
↓ 17 ↔ 17 cm



ART. 49564 P
↓ 18 ↔ 18,5 cm



ART. 46564 Ø5
↓ 18 ↔ 11,5 cm



ART. 46650 Ø5
↓ 19 ↔ 8 cm
ART. 46676 Ø4
↓ 13 ↔ 7 cm

ART. 46150 Ø5
↓ 19 ↔ 8 cm
ART. 46176 Ø4
↓ 13 ↔ 7 cm



ART. 47213 P **T**
↓ 28 ↔ 17 cm

ART. 47212 R
↓ 28 ↔ 17 cm



ART. 47310 P **P**
↓ 20 ↔ 12 cm

ART. 47311 R
↓ 20 ↔ 12 cm

ART. 47210 P **T**
↓ 20 ↔ 12 cm

ART. 47211 R
↓ 20 ↔ 12 cm



ART. 49310 P **P**
↓ 18 ↔ 17 cm

ART. 49311 R
↓ 18 ↔ 17 cm

ART. 49210 P **T**
↓ 18 ↔ 17 cm

ART. 49211 R
↓ 18 ↔ 17 cm



ART. 46212 Ø6 **T**
↓ 26 ↔ 14 cm



ART. 46310 Ø5 **P**
↓ 19 ↔ 10 cm

ART. 46210 Ø5 **T**
↓ 19 ↔ 10 cm



ART. 46952 **P**
↓ 18 ↔ 13 cm

ART. 46756 **T**
↓ 18 ↔ 13 cm

ART. 46757
↓ 22 ↔ 17 cm



ART. 46960 **P**
↓ 21 ↔ 13 cm

ART. 46762 **T**
↓ 21 ↔ 13 cm



ART. 46760 **T**
↓ 23 ↔ 13 cm



ART. 31633 7x9 cm
ART. 31663 8x10 cm
ART. 40106 9x12 cm
ART. 40107 11x15 cm
ART. 31664 13x18 cm

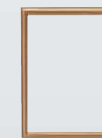

ART. 31635 7x9 cm
ART. 31636 8x10 cm
ART. 40126 9x12 cm
ART. 40127 10x15 cm
ART. 40128 11x15 cm
ART. 40139 13x18 cm



ART. 41136 ↓ 15 ↔ 6,5 cm
ART. 41137 ↓ 20 ↔ 9 cm
ART. 41138 ↓ 25 ↔ 11 cm
ART. 41139 ↓ 30 ↔ 13 cm
ART. 41140 ↓ 40 ↔ 18 cm
ART. 41141 ↓ 50 ↔ 21,5 cm



ART. 47081 P
↓ 28 ↔ 14 cm



ART. 47577 P
↓ 20 ↔ 9 cm



ART. 47077 P
↓ 20 ↔ 9 cm



ART. 49590 P
↓ 19 ↔ 11,5 cm



ART. 49573 P
↓ 17,5 ↔ 15,5 cm

ART. 49073 P
↓ 17,5 ↔ 15,5 cm

ART. 47101 R
↓ 28 ↔ 14 cm

ART. 47578 R
↓ 20 ↔ 9 cm

ART. 47078 R
↓ 20 ↔ 9 cm

ART. 49574 R
↓ 17,5 ↔ 15,5 cm

ART. 49074 R
↓ 17,5 ↔ 15,5 cm



ART. 46081 Ø6
↓ 24 ↔ 12 cm



ART. 46577 Ø5
↓ 20 ↔ 9 cm

ART. 46077 Ø5
↓ 20 ↔ 9 cm



ART. 46946 P
↓ 18 ↔ 13 cm

ART. 46846 T
↓ 18 ↔ 13 cm



PORTAORCHIDEA
con biadesivo
ART. 47637 P
↓ 12 ↔ 5 cm

ART. 46847
↓ 22 ↔ 17 cm



ART. 35200 9x12 cm
ART. 35210 11x15 cm



ART. 35230 9x12 cm
ART. 35240 10x15 cm
ART. 35250 11x15 cm



ART. 31633 7x9 cm
ART. 31663 8x10 cm
ART. 40106 9x12 cm
ART. 40107 11x15 cm
ART. 31664 13x18 cm



ART. 31635 7x9 cm
ART. 31636 8x10 cm
ART. 40126 9x12 cm
ART. 40127 10x15 cm
ART. 40128 11x15 cm
ART. 40139 13x18 cm



ART. 41136 ↓ 15 ↔ 6,5 cm
ART. 41137 ↓ 20 ↔ 9 cm
ART. 41138 ↓ 25 ↔ 11 cm
ART. 41139 ↓ 30 ↔ 13 cm
ART. 41140 ↓ 40 ↔ 18 cm
ART. 41141 ↓ 50 ↔ 21,5 cm



ART. 47693 P
↓ 28 ↔ 18 cm

ART. 47193 P T
↓ 28 ↔ 18 cm



ART. 47691 P
↓ 20 ↔ 13 cm

ART. 47191 P T
↓ 20 ↔ 13 cm



ART. 49691 P
↓ 18 ↔ 17 cm

ART. 49191 P T
↓ 18 ↔ 17 cm

ART. 47692 R
↓ 28 ↔ 18 cm

ART. 47192 R
↓ 28 ↔ 18 cm

ART. 47690 R
↓ 20 ↔ 13 cm

ART. 47190 R
↓ 20 ↔ 13 cm

ART. 49690 R
↓ 18 ↔ 17 cm

ART. 49190 R
↓ 20 ↔ 10 cm



ART. 46930 P
↓ 18 ↔ 13 cm

ART. 46830 T
↓ 18 ↔ 13 cm

ART. 46690 Ø 5
↓ 20 ↔ 9 cm

ART. 46190 Ø 5 T
↓ 20 ↔ 9 cm

ART. 46691 Ø 6
↓ 23 ↔ 10 cm

ART. 46191 Ø 6 T
↓ 23 ↔ 10 cm



ART. 41136 ↓ 15 ↔ 6,5 cm
ART. 41137 ↓ 20 ↔ 9 cm
ART. 41138 ↓ 25 ↔ 11 cm
ART. 41139 ↓ 30 ↔ 13 cm
ART. 41140 ↓ 40 ↔ 18 cm
ART. 41141 ↓ 50 ↔ 21,5 cm



ART. 31633 7x9 cm
ART. 31663 8x10 cm
ART. 40106 9x12 cm
ART. 40107 11x15 cm
ART. 31664 13x18 cm

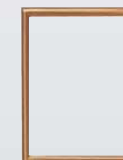

ART. 31635 7x9 cm
ART. 31636 8x10 cm
ART. 40126 9x12 cm
ART. 40127 10x15 cm
ART. 40128 11x15 cm
ART. 40139 13x18 cm



ART. 35200 9x12 cm
ART. 35210 11x15 cm



ART. 35230 9x12 cm
ART. 35240 10x15 cm
ART. 35250 11x15 cm

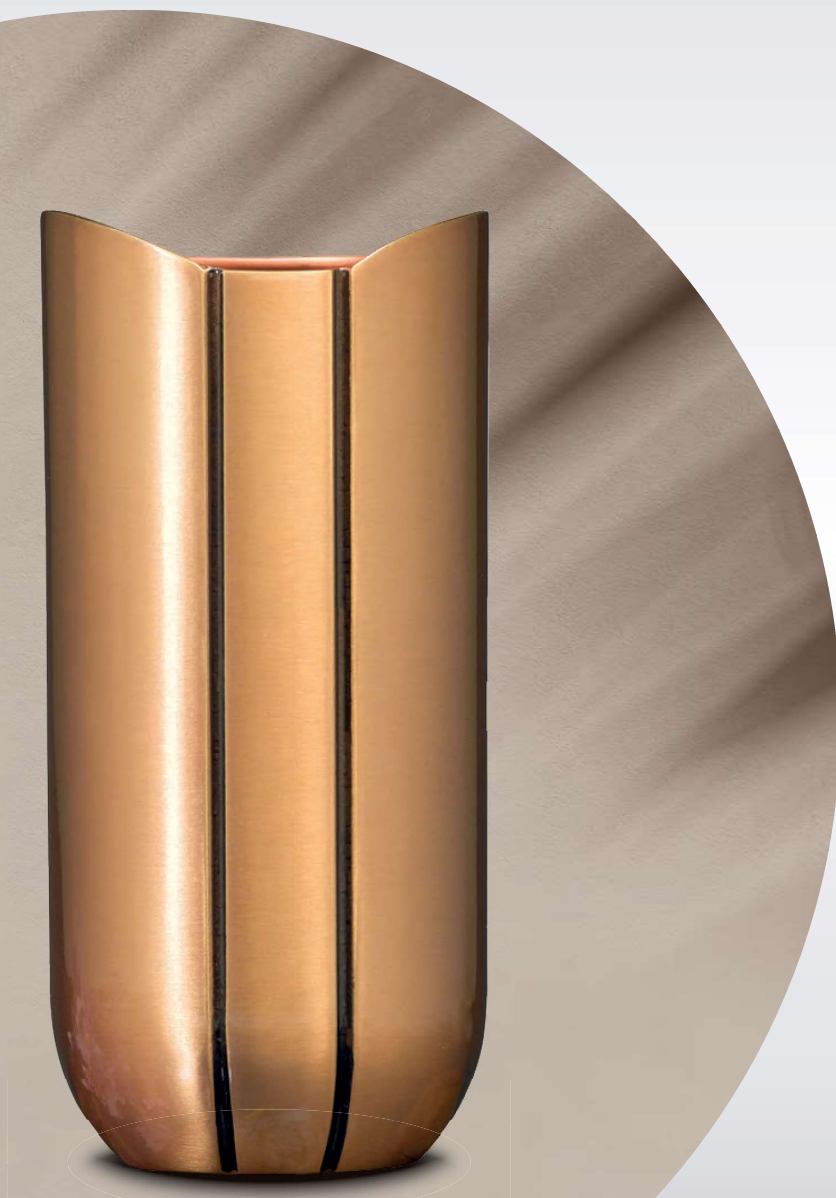

ART. 47530 R **P**
↓ 28 ↔ 14 cm



ART. 47526 R **P**
↓ 20 ↔ 10 cm



ART. 47508 P **P**
↓ 13 ↔ 6 cm



ART. 49526 R **P**
↓ 17 ↔ 14 cm

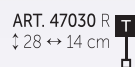

ART. 47030 R **T**
↓ 28 ↔ 14 cm

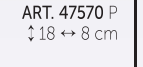

ART. 47570 P
↓ 18 ↔ 8 cm

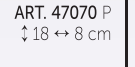

ART. 47070 P
↓ 18 ↔ 8 cm

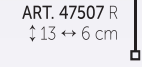

ART. 47507 R
↓ 13 ↔ 6 cm

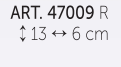

ART. 47009 R
↓ 13 ↔ 6 cm

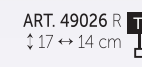

ART. 49026 R **T**
↓ 17 ↔ 14 cm

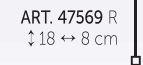

ART. 47569 R
↓ 18 ↔ 8 cm

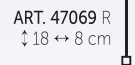

ART. 47069 R
↓ 18 ↔ 8 cm



ART. 46533 Ø 6 **P**
↓ 26 ↔ 11 cm



ART. 46526 Ø 5 **P**
↓ 19 ↔ 9 cm



ART. 46508 Ø 4 **P**
↓ 13 ↔ 6 cm



ART. 41248 12x5 cm
ART. 41249 15x6 cm
ART. 41250 20x8 cm
ART. 41251 25x10 cm
ART. 41252 30x13 cm
ART. 41253 40x16 cm
ART. 41254 50x20 cm

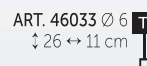

ART. 46033 Ø 6 **T**
↓ 26 ↔ 11 cm

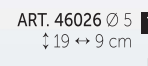

ART. 46026 Ø 5 **T**
↓ 19 ↔ 9 cm



ART. 46008 Ø 4 **T**
↓ 13 ↔ 6 cm



ART. 31660 9x12 cm
ART. 31661 11x15 cm
ART. 31662 13x18 cm



ART. 31665 9x12 cm
ART. 31666 11x15 cm
ART. 31667 13x18 cm



ART. 35197 9x12 cm
ART. 35198 11x15 cm
ART. 35199 13x18 cm



ART. 35194 9x12 cm
ART. 35195 11x15 cm
ART. 35196 13x18 cm



ART. 47538 R **P** ↓ 28 ↔ 14 cm



ART. 47525 R **P** ↓ 20 ↔ 10 cm



ART. 49536 R **P** ↓ 17 ↔ 14 cm



ART. 46538 **P** Ø 6 ↓ 26 ↔ 11 cm



ART. 46525 **P** Ø 5 ↓ 19 ↔ 9 cm



ART. 41120 12x5 cm
ART. 41121 15x6 cm
ART. 41122 20x8 cm
ART. 41123 25x10 cm

ART. 46038 **T** Ø 6 ↓ 26 ↔ 11 cm

ART. 46025 **T** Ø 5 ↓ 19 ↔ 9 cm



ART. 31668 9x12 cm
ART. 31669 11x15 cm
ART. 31670 13x18 cm



ART. 31671 9x12 cm
ART. 31672 11x15 cm
ART. 31673 13x18 cm



ART. 35205 9x12 cm
ART. 35206 11x15 cm
ART. 35207 13x18 cm



ART. 35202 9x12 cm
ART. 35203 11x15 cm
ART. 35204 13x18 cm



ART. 47035 P
↓ 28 ↔ 18 cm

ART. 47036 R
↓ 28 ↔ 18 cm



ART. 47534 P
↓ 21 ↔ 13 cm

ART. 47537 R
↓ 21 ↔ 13 cm



ART. 47034 P
↓ 21 ↔ 13 cm

ART. 47037 R
↓ 21 ↔ 13 cm

ART. 49534 P
↓ 18 ↔ 16 cm

ART. 49537 R
↓ 18 ↔ 16 cm

ART. 49034 P
↓ 18 ↔ 16 cm

ART. 49037 R
↓ 18 ↔ 16 cm



ART. 46035 Ø 6
↓ 27 ↔ 14 cm



ART. 46534 Ø 5
↓ 20 ↔ 11 cm



ART. 46827
↓ 25 ↔ 14 cm



ART. 46924
↓ 20 ↔ 14 cm



ART. 46927
↓ 17 ↔ 12 cm

ART. 46034 Ø 5
↓ 20 ↔ 11 cm

ART. 46823
↓ 20 ↔ 14 cm

ART. 46826
↓ 17 ↔ 12 cm



ART. 40130 7x9 cm
ART. 40131 8x10 cm
ART. 40132 9x12 cm
ART. 40133 11x15 cm
ART. 40134 13x18 cm
ART. 40135 18x24 cm



ART. 40140 7x9 cm
ART. 40141 8x10 cm
ART. 40142 9x12 cm
ART. 40143 10x15 cm
ART. 40144 11x15 cm
ART. 40145 13x18 cm
ART. 40146 18x24 cm



ART. 35307 9x12 cm
ART. 35308 11x15 cm
ART. 35309 13x18 cm



ART. 35296 9x12 cm
ART. 35138 10x15 cm
ART. 35297 11x15 cm
ART. 35316 13x18 cm



ART. 47522 P
↓ 28 ↔ 15 cm

ART. 47022 P T
↓ 28 ↔ 15 cm

ART. 47523 R
↓ 28 ↔ 15 cm

ART. 47023 R
↓ 28 ↔ 15 cm



ART. 47524 R P
↓ 21 ↔ 12 cm

ART. 47024 R T
↓ 21 ↔ 12 cm



ART. 49525 P P
↓ 19 ↔ 17 cm

ART. 49025 P T
↓ 19 ↔ 17 cm

ART. 49524 R
↓ 19 ↔ 17 cm

ART. 49024 R
↓ 19 ↔ 17 cm



ART. 46523 Ø 6 P
↓ 23 ↔ 10 cm

ART. 46023 Ø 6 T
↓ 23 ↔ 10 cm



ART. 46524 Ø 5 P
↓ 19 ↔ 8 cm

ART. 46024 Ø 5 T
↓ 19 ↔ 8 cm



ART. 49202 R P
↓ 12 ↔ 10 cm

ART. 49102 R T
↓ 12 ↔ 10 cm



ART. 46831 T
↓ 22 ↔ 17 cm



ART. 46930 P
↓ 18 ↔ 13 cm

ART. 46830 T
↓ 18 ↔ 13 cm



ART. 40130 7x9 cm
ART. 40131 8x10 cm
ART. 40132 9x12 cm
ART. 40133 11x15 cm
ART. 40134 13x18 cm
ART. 40135 18x24 cm



ART. 40140 7x9 cm
ART. 40141 8x10 cm
ART. 40142 9x12 cm
ART. 40143 10x15 cm
ART. 40144 11x15 cm
ART. 40145 13x18 cm
ART. 40146 18x24 cm



ART. 33010 10x5 cm
ART. 33012 12x5 cm
ART. 33015 15x6 cm
ART. 33020 20x6 cm
ART. 33025 25x8 cm
ART. 33030 30x8 cm
ART. 33040 40x10 cm
ART. 33050 50x12 cm



ART. 47003 R
↓ 50 ↔ 23 cm



ART. 47001 P
↓ 28 ↔ 16 cm



ART. 47500 P
↓ 20 ↔ 11 cm



ART. 47504 P
↓ 12 ↔ 8 cm



ART. 49500 P
↓ 18 ↔ 16 cm

ART. 47007 R
↓ 28 ↔ 16 cm

ART. 47506 R
↓ 20 ↔ 11 cm

ART. 47006 R
↓ 20 ↔ 11 cm

ART. 47509 R
↓ 12 ↔ 8 cm

ART. 49501 R
↓ 18 ↔ 16 cm

ART. 47002 R
↓ 40 ↔ 23 cm

ART. 47609 P
↓ 17 ↔ 10 cm

ART. 47109 P
↓ 17 ↔ 10 cm

ART. 47004 P
↓ 12 ↔ 8 cm

ART. 49100 P
↓ 18 ↔ 16 cm

ART. 47608 R
↓ 17 ↔ 10 cm

ART. 47108 R
↓ 17 ↔ 10 cm

ART. 47011 R
↓ 12 ↔ 8 cm

ART. 49101 R
↓ 18 ↔ 16 cm



ART. 46817 T
↓ 25 ↔ 14 cm



ART. 46913 P
↓ 20 ↔ 14 cm



ART. 46916 P
↓ 17 ↔ 12 cm



ART. 46001 T
Ø 6 ↓ 27 ↔ 15 cm



ART. 46500 P
Ø 5 ↓ 20 ↔ 9 cm



ART. 46503 P
Ø 4 ↓ 14 ↔ 6 cm

ART. 46813 T
↓ 20 ↔ 14 cm

ART. 46816 T
↓ 17 ↔ 12 cm

ART. 46000 T
Ø 5 ↓ 20 ↔ 9 cm

ART. 46003 T
Ø 4 ↓ 14 ↔ 6 cm



ART. 46915 P
↓ 9 ↔ 8 cm

ART. 46815 T
↓ 9 ↔ 8 cm



ART. 40600 P
19 ↔ 15 cm



ART. 40301 P
Ø 5 ↓ 19 ↔ 13 cm



ART. 40102 8x10 cm
ART. 40100 9x12 cm
ART. 40101 11x15 cm
ART. 40103 13x18 cm
ART. 40104 18x24 cm



ART. 40119 8x10 cm
ART. 40120 9x12 cm
ART. 40122 10x15 cm
ART. 40121 11x15 cm
ART. 40124 13x18 cm
ART. 40123 18x24 cm



ART. 41000 15x8 cm
ART. 41001 20x11 cm
ART. 41002 25x14 cm
ART. 41003 30x14 cm



ART. 41005 15x8 cm
ART. 41006 20x11 cm
ART. 41007 25x14 cm
ART. 41008 30x14 cm



ART. 47541 R **P**
 ↓ 28 ↔ 19 cm



ART. 47131 R **T**
 ↓ 28 ↔ 19 cm



ART. 47630 R **P**
 ↓ 21 ↔ 14 cm



ART. 47130 R **T**
 ↓ 21 ↔ 14 cm



ART. 49535 R **P**
 ↓ 19 ↔ 17 cm



ART. 49035 R **T**
 ↓ 19 ↔ 17 cm



ART. 46630 Ø 5 **P**
 ↓ 19 ↔ 10 cm

ART. 46130 Ø 5 **T**
 ↓ 19 ↔ 10 cm



ART. 46831 **T**
 ↓ 22 ↔ 17 cm



ART. 46930 **P**
 ↓ 18 ↔ 13 cm

ART. 46830 **T**
 ↓ 18 ↔ 13 cm



ART. 40130 7x9 cm
 ART. 40131 8x10 cm
 ART. 40132 9x12 cm
 ART. 40133 11x15 cm
 ART. 40134 13x18 cm
 ART. 40135 18x24 cm



ART. 40140 7x9 cm
 ART. 40141 8x10 cm
 ART. 40142 9x12 cm
 ART. 40143 10x15 cm
 ART. 40144 11x15 cm
 ART. 40145 13x18 cm
 ART. 40146 18x24 cm



ART. 41248 12x5 cm
 ART. 41249 15x6 cm
 ART. 41250 20x8 cm
 ART. 41251 25x10 cm
 ART. 41252 30x13 cm
 ART. 41253 40x16 cm
 ART. 41254 50x20 cm



ART. 47667 R **P**
↓ 28 ↔ 19 cm

ART. 47167 R **T**
↓ 28 ↔ 19 cm



ART. 47666 R **P**
↓ 21 ↔ 14 cm

ART. 47166 R **T**
↓ 21 ↔ 14 cm



ART. 49683 R **P**
↓ 19 ↔ 17 cm

ART. 49183 R **T**
↓ 19 ↔ 17 cm



ART. 46666 Ø 5 **P**
↓ 19 ↔ 10 cm

ART. 46166 Ø 5 **T**
↓ 19 ↔ 10 cm



ART. 46964 **P**
↓ 18 ↔ 13 cm

ART. 46864 **T**
↓ 18 ↔ 13 cm

ART. 46872
↓ 22 ↔ 17 cm



ART. 46806 **T**
↓ 27 ↔ 15 cm



ART. 40182 9 x 12 cm
ART. 40183 11 x 15 cm
ART. 40195 13 x 18 cm

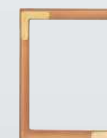

ART. 40187 9x12 cm
ART. 40188 11x15 cm
ART. 40196 13x18 cm



ART. 35303 9x12 cm
ART. 35304 11x15 cm
ART. 35317 13x18 cm



ART. 35312 9x12 cm
ART. 35313 11x15 cm
ART. 35318 13x18 cm



ART. 41120 12x5 cm
ART. 41121 15x6 cm
ART. 41122 20x8 cm
ART. 41123 25x10 cm



ART. 47117 R T
↓ 50 ↔ 22 cm



ART. 47116 R T
↓ 40 ↔ 22 cm



ART. 47612 R P
↓ 20 ↔ 11 cm



ART. 47624 P P
↓ 12 ↔ 7 cm



ART. 47186 P T
↓ 12 ↔ 7 cm

ART. 49531 P P
↓ 18 ↔ 17 cm

ART. 47112 R T
↓ 20 ↔ 11 cm

ART. 47623 R P
↓ 12 ↔ 7 cm

ART. 47185 R P
↓ 12 ↔ 7 cm

ART. 49131 P T
↓ 18 ↔ 17 cm



ART. 46925 P
↓ 21 ↔ 14 cm



ART. 46513 Ø 6 P
↓ 28 ↔ 11 cm



ART. 46612 Ø 5 P
↓ 20 ↔ 8 cm



ART. 46623 Ø 4 P
↓ 14 ↔ 8 cm

ART. 46871 T
↓ 21 ↔ 14 cm

ART. 46113 Ø 6 T
↓ 28 ↔ 11 cm

ART. 46112 Ø 5 T
↓ 20 ↔ 8 cm

ART. 46185 Ø 4 T
↓ 14 ↔ 8 cm



ART. 31633 7x9 cm
ART. 31663 8x10 cm
ART. 40106 9x12 cm
ART. 40107 11x15 cm
ART. 31664 13x18 cm



ART. 31635 7x9 cm
ART. 31636 8x10 cm
ART. 40126 9x12 cm
ART. 40127 10x15 cm
ART. 40128 11x15 cm
ART. 40139 13x18 cm



ART. 41136 ↓ 15 ↔ 6,5 cm
ART. 41137 ↓ 20 ↔ 9 cm
ART. 41138 ↓ 25 ↔ 11 cm
ART. 41139 ↓ 30 ↔ 13 cm
ART. 41140 ↓ 40 ↔ 18 cm
ART. 41141 ↓ 50 ↔ 21,5 cm



ART. 47115 R **T**
↓ 50 ↔ 22 cm



ART. 47114 R **T**
↓ 40 ↔ 22 cm



ART. 47501 P **P**
↓ 20 ↔ 11 cm



ART. 47622 P **P**
↓ 12 ↔ 7 cm



ART. 49530 P **P**
↓ 18 ↔ 17 cm

ART. 47610 R **T**
↓ 20 ↔ 11 cm

ART. 47621 R **T**
↓ 12 ↔ 7 cm

ART. 49130 P **T**
↓ 18 ↔ 17 cm

ART. 47104 P **T**
↓ 20 ↔ 11 cm

ART. 47184 P **T**
↓ 12 ↔ 7 cm

ART. 47110 R **T**
↓ 20 ↔ 11 cm

ART. 47175 R **T**
↓ 12 ↔ 7 cm



ART. 46925 **P**
↓ 21 ↔ 14 cm



ART. 46511 Ø 6 **P**
↓ 28 ↔ 11 cm



ART. 46610 Ø 5 **P**
↓ 20 ↔ 8 cm



ART. 46621 Ø 4 **P**
↓ 14 ↔ 8 cm

ART. 46871 **T**
↓ 21 ↔ 14 cm

ART. 46111 Ø 6 **T**
↓ 28 ↔ 11 cm

ART. 46110 Ø 5 **T**
↓ 20 ↔ 8 cm

ART. 46184 Ø 4 **T**
↓ 14 ↔ 8 cm



ART. 31633 7x9 cm
ART. 31663 8x10 cm
ART. 40106 9x12 cm
ART. 40107 11x15 cm
ART. 31664 13x18 cm

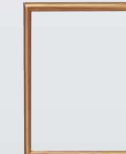

ART. 31635 7x9 cm
ART. 31636 8x10 cm
ART. 40126 9x12 cm
ART. 40127 10x15 cm
ART. 40128 11x15 cm
ART. 40139 13x18 cm



ART. 41136 ↓ 15 ↔ 6,5 cm
ART. 41137 ↓ 20 ↔ 9 cm
ART. 41138 ↓ 25 ↔ 11 cm
ART. 41139 ↓ 30 ↔ 13 cm
ART. 41140 ↓ 40 ↔ 18 cm
ART. 41141 ↓ 50 ↔ 21,5 cm

primaria lega patinata carrara



ART. 47610CA R **P**
↓ 20 ↔ 11 cm



ART. 47610BO R **P**
↓ 20 ↔ 11 cm

ART. 47110CA R **T**
↓ 20 ↔ 11 cm

ART. 47110BO R **T**
↓ 20 ↔ 11 cm



ART. 47622CA P **P**
ART. 47621CA R **R**
↓ 12 ↔ 7 cm

ART. 47184CA P **T**
ART. 47175CA R **R**
↓ 12 ↔ 7 cm



ART. 47622BO P **P**
ART. 47621BO R **R**
↓ 12 ↔ 7 cm

ART. 47184BO P **T**
ART. 47175BO R **R**
↓ 12 ↔ 7 cm



ART. 49530CA P **P**
↓ 18 ↔ 17 cm

ART. 49130CA P **T**
↓ 18 ↔ 17 cm



ART. 47635CA P **P**
↓ 11 ↔ 3,5 cm



ART. 47635BO P **P**
↓ 11 ↔ 3,5 cm



ART. 49530BO P **P**
↓ 18 ↔ 17 cm

ART. 49130BO P **T**
↓ 18 ↔ 17 cm



ART. 46511CA Ø 6 **P**
↓ 28 ↔ 11 cm



ART. 46610CA Ø 5 **P**
↓ 20 ↔ 8 cm



ART. 46621CA Ø 4 **P**
↓ 12 ↔ 7 cm



ART. 46925CA **P**
6GG
↓ 21 ↔ 14 cm

ART. 46871CA **T**
6GG
↓ 21 ↔ 14 cm



ART. 46925BO **P**
6GG
↓ 21 ↔ 14 cm

ART. 46871BO **T**
6GG
↓ 21 ↔ 14 cm



ART. 46621BO Ø 4 **P**
↓ 12 ↔ 7 cm



ART. 46610BO Ø 5 **P**
↓ 20 ↔ 8 cm



ART. 46511BO Ø 6 **P**
↓ 28 ↔ 11 cm

ART. 46111CA Ø 6 **T**
↓ 28 ↔ 11 cm

ART. 46110CA Ø 6 **T**
↓ 20 ↔ 8 cm

ART. 46184CA Ø 4 **T**
↓ 12 ↔ 7 cm

ART. 46184BO Ø 4 **T**
↓ 12 ↔ 7 cm

ART. 46110BO Ø 6 **T**
↓ 20 ↔ 8 cm

ART. 46111BO Ø 6 **T**
↓ 28 ↔ 11 cm

primaria lega patinata botticino





ART. 47102 P T
↓ 28 ↔ 14 cm



ART. 47600 P P ART. 47100 P T
↓ 20 ↔ 11 cm ↓ 20 ↔ 11 cm



ART. 46102 Ø 6 T
↓ 27 ↔ 13 cm



ART. 46600 Ø 5 P ART. 46100 Ø 5 T
↓ 19 ↔ 8 cm ↓ 19 ↔ 8 cm



ART. 46821 T
↓ 25 ↔ 14 cm



ART. 46922 P ART. 46822 T
↓ 20 ↔ 14 cm ↓ 20 ↔ 14 cm



ART. 46920 P ART. 46820 T
↓ 17 ↔ 11 cm ↓ 17 ↔ 11 cm



ART. 31633 7x9 cm
ART. 31663 8x10 cm
ART. 40106 9x12 cm
ART. 40107 11x15 cm
ART. 31664 13x18 cm

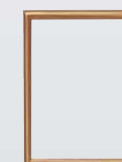

ART. 31635 7x9 cm
ART. 31636 8x10 cm
ART. 40126 9x12 cm
ART. 40127 10x15 cm
ART. 40128 11x15 cm
ART. 40139 13x18 cm



ART. 41136 ↓ 15 ↔ 6,5 cm
ART. 41137 ↓ 20 ↔ 9 cm
ART. 41138 ↓ 25 ↔ 11 cm
ART. 41139 ↓ 30 ↔ 13 cm
ART. 41140 ↓ 40 ↔ 18 cm
ART. 41141 ↓ 50 ↔ 21,5 cm



ART. 47663 R P
↓ 20 ↔ 13 cm

ART. 47662 P
↓ 13 ↔ 8 cm

ART. 47661 R
↓ 13 ↔ 8 cm



ART. 49672 R P
↓ 18 ↔ 18 cm

ART. 49172 R T
↓ 18 ↔ 18 cm



Con goccia Parete
ART. 49673 R P
↓ 17 ↔ 30 cm

Con goccia terreno
ART. 49173 R T
↓ 17 ↔ 30 cm

Senza goccia
ART. 49674 R

Senza goccia
ART. 49174 R



ART. 46663 Ø 5 P
↓ 19 ↔ 9 cm

ART. 46662 Ø 4
↓ 13 ↔ 7 cm

ART. 46163 Ø 5 T
↓ 19 ↔ 9 cm

ART. 46162 Ø 4
↓ 13 ↔ 7 cm



ART. 47887 P T
↓ 8 ↔ 17 cm

ART. 47886 R
↓ 8 ↔ 17 cm



ART. 47889 P T
↓ 8 ↔ 17 cm

ART. 47888 R
↓ 8 ↔ 17 cm



ART. 46804 T
↓ 27 ↔ 15 cm



ART. 46914 P
↓ 17 ↔ 12 cm

ART. 46814 T
↓ 17 ↔ 12 cm

ART. 46824
↓ 25 ↔ 17 cm



ART. 41011 ↓ 15 ↔ 10 cm
ART. 41012 ↓ 20 ↔ 11 cm
ART. 33108 ↓ 30 ↔ 12 cm



ART. 40201 9x12 cm
ART. 40202 11x15 cm
ART. 40203 13x18 cm



ART. 40204 9x12 cm
ART. 40205 10x15 cm
ART. 40206 11x15 cm
ART. 40207 13x18 cm



ART. 35236 9x12 cm
ART. 35237 10x15 cm
ART. 35238 11x15 cm
ART. 35239 13x18 cm



ART. 35212 9x12 cm
ART. 35213 11x15 cm
ART. 35214 13x18 cm

fusione a terra



fusione a terra



ART. 47520 R P
↓ 20,5 ↔ 12 cm



ART. 47518 R P
↓ 20,5 ↔ 12 cm



ART. 47246 R T
↓ 20,5 ↔ 12 cm



ART. 47242 R T
↓ 20,5 ↔ 12 cm



ART. 47599 R P
↓ 12 ↔ 7,5 cm

ART. 47256 R T
↓ 12 ↔ 7,5 cm

ART. 47657 R P
↓ 12 ↔ 7,5 cm

ART. 47257 R T
↓ 12 ↔ 7,5 cm



ART. 46520 Ø 5 P
↓ 21 ↔ 9,5 cm

ART. 46220 Ø 5 T
↓ 21 ↔ 9,5 cm



ART. 49502 R P
↓ 18 ↔ 17,5 cm

ART. 49206 R T
↓ 18 ↔ 17,5 cm



ART. 49503 R P
↓ 18 ↔ 17,5 cm

ART. 49203 R T
↓ 18 ↔ 17,5 cm



ART. 46518 Ø 5 P
↓ 21 ↔ 9,5 cm

ART. 46218 Ø 5 T
↓ 21 ↔ 9,5 cm



ART. 46588 Ø 4 P
↓ 13 ↔ 7,5 cm

ART. 46245 Ø 4 T
↓ 13 ↔ 7,5 cm



ART. 31786 7x9 cm
ART. 31787 8x10 cm
ART. 31759 9x12 cm
ART. 31760 11x15 cm



ART. 31788 7x9 cm
ART. 31789 8x10 cm
ART. 31761 9x12 cm
ART. 31762 10x15 cm
ART. 31763 11x15 cm



ART. 41042 ↓ 15 cm
ART. 41043 ↓ 20 cm
ART. 41044 ↓ 25 cm
ART. 41045 ↓ 30 cm
ART. 41046 ↓ 40 cm



ART. 46589 Ø 4 P
↓ 13 ↔ 7,5 cm

ART. 46246 Ø 4 T
↓ 13 ↔ 7,5 cm



ART. 31786 7x9 cm
ART. 31787 8x10 cm
ART. 31759 9x12 cm
ART. 31760 11x15 cm



ART. 31788 7x9 cm
ART. 31789 8x10 cm
ART. 31761 9x12 cm
ART. 31762 10x15 cm
ART. 31763 11x15 cm



ART. 41042 ↓ 15 cm
ART. 41043 ↓ 20 cm
ART. 41044 ↓ 25 cm
ART. 41045 ↓ 30 cm
ART. 41046 ↓ 40 cm

fusione a terra



ART. 47519 R **P**
↓ 20,5 ↔ 12 cm



ART. 47243 R **T**
↓ 20,5 ↔ 12 cm



ART. 47521 R **P**
↓ 20,5 ↔ 12 cm



ART. 47251 R **T**
↓ 20,5 ↔ 12 cm

ART. 47658 R **P**
↓ 12 ↔ 7,5 cm

ART. 47258 R **T**
↓ 12 ↔ 7,5 cm



ART. 46519 Ø 5 **P**
↓ 21 ↔ 9,5 cm

ART. 46213 Ø 5 **T**
↓ 21 ↔ 9,5 cm



ART. 49504 R **P**
↓ 18 ↔ 17,5 cm

ART. 49204 R **T**
↓ 18 ↔ 17,5 cm



ART. 49511 R **P**
↓ 18 ↔ 17,5 cm

ART. 49205 R **T**
↓ 18 ↔ 17,5 cm



ART. 46521 Ø 5 **P**
↓ 17 ↔ 9,5 cm

ART. 46222 Ø 5 **T**
↓ 17 ↔ 9,5 cm



fusione a terra



ART. 46591 Ø 4 **P**
↓ 13 ↔ 7,5 cm

ART. 46251 Ø 4 **T**
↓ 13 ↔ 7,5 cm



ART. 31786 7x9 cm
ART. 31787 8x10 cm
ART. 31759 9x12 cm
ART. 31760 11x15 cm



ART. 31788 7x9 cm
ART. 31789 8x10 cm
ART. 31761 9x12 cm
ART. 31762 10x15 cm
ART. 31763 11x15 cm



ART. 41042 ↓ 15 cm
ART. 41043 ↓ 20 cm
ART. 41044 ↓ 25 cm
ART. 41045 ↓ 30 cm
ART. 41046 ↓ 40 cm



ART. 46929 **P**
↓ 18 ↔ 13 cm

ART. 46409 **T**
↓ 18 ↔ 13 cm



ART. 31790 9x12 cm
ART. 31791 11x15 cm



ART. 31792 9x12 cm
ART. 31793 10x15 cm
ART. 31794 11x15 cm



ART. 41004 ↓ 15 cm
ART. 41009 ↓ 20 cm
ART. 41010 ↓ 25 cm
ART. 41015 ↓ 30 cm
ART. 41016 ↓ 40 cm

fusione a terra

fusione a terra



ART. 47547 R P
↓ 20 ↔ 12 cm



ART. 47604 R P ART. 47224 R T
↓ 20 ↔ 12 cm ↓ 20 ↔ 12 cm

ART. 47253 R T
↓ 20 ↔ 12 cm



ART. 49624 R P ART. 49224 R T
↓ 18 ↔ 18,5 cm ↓ 18 ↔ 18,5 cm



ART. 49512 R P ART. 49207 R T ART. 46547 Ø 5 P ART. 46242 Ø 5 T
↓ 18 ↔ 18,5 cm ↓ 18 ↔ 18,5 cm ↓ 17 ↔ 9,5 cm ↓ 17 ↔ 9,5 cm



ART. 46624 Ø 5 P ART. 46224 Ø 5 T
↓ 17 ↔ 9,5 cm ↓ 17 ↔ 9,5 cm



ART. 49821
↓ 21,5 ↔ 57 cm- Interno Rame



ART. 46931 P
↓ 18 ↔ 13 cm



ART. 31795 9x12 cm
ART. 31796 11x15 cm



ART. 31797 9x12 cm
ART. 31798 10x15 cm
ART. 31799 11x15 cm



ART. 41047 ↓ 15 cm
ART. 41048 ↓ 20 cm
ART. 41049 ↓ 25 cm
ART. 41050 ↓ 30 cm
ART. 41051 ↓ 40 cm



ART. 31718 9x12 cm
ART. 31719 11x15 cm



ART. 31715 9x12 cm
ART. 31716 10x15 cm
ART. 31717 11x15 cm



ART. 41042 ↓ 15 cm
ART. 41043 ↓ 20 cm
ART. 41044 ↓ 25 cm
ART. 41045 ↓ 30 cm
ART. 41046 ↓ 40 cm



ART. 46932 P
↓ 18 ↔ 13 cm

ART. 46832 T
↓ 18 ↔ 13 cm

fusione a terra con inserto in bagno oro 24 K



ART. 47652 R P
↓ 20,5 ↔ 11 cm

ART. 47252 R T
↓ 20,5 ↔ 12 cm



ART. 47617 R P
↓ 20,5 ↔ 11 cm

ART. 47227 R T
↓ 20,5 ↔ 12 cm



ART. 49617 R P
↓ 19 ↔ 16 cm

ART. 49217 R T
↓ 19 ↔ 16 cm



ART. 46617 Ø 5 P
↓ 16,5 ↔ 9 cm

ART. 46217 Ø 5 T
↓ 16,5 ↔ 9 cm



ART. 49627 R P
↓ 19 ↔ 15 cm

ART. 49227 R T
↓ 19 ↔ 15 cm



ART. 46627 Ø 5 P
↓ 16,5 ↔ 9 cm

ART. 46227 Ø 5 T
↓ 16,5 ↔ 9 cm



ART. 46917 P
↓ 19 ↔ 12,5 cm



ART. 31767 9x12 cm
ART. 31768 11x15 cm



ART. 31769 9x12 cm
ART. 31771 10x15 cm



ART. 41042 ↓ 15 cm
ART. 41043 ↓ 20 cm
ART. 41044 ↓ 25 cm
ART. 41045 ↓ 30 cm
ART. 41046 ↓ 40 cm



ART. 46940 P
↓ 19 ↔ 12,5 cm



ART. 31740 9x12 cm
ART. 31741 11x15 cm



ART. 31742 9x12 cm
ART. 31744 10x15 cm



ART. 41042 ↓ 15 cm
ART. 41043 ↓ 20 cm
ART. 41044 ↓ 25 cm
ART. 41045 ↓ 30 cm
ART. 41046 ↓ 40 cm

fusione a terra



fusione a terra

fusione a terra



ART. 47583 R **P**
↓ 20,5 ↔ 11 cm

ART. 47255 R **T**
↓ 20,5 ↔ 12 cm



ART. 47553 R **P**
↓ 20,5 ↔ 11 cm

ART. 47254 R **T**
↓ 20,5 ↔ 12 cm



ART. 49518 R **P**
↓ 19 ↔ 15 cm

ART. 49209 R **T**
↓ 19 ↔ 15 cm



ART. 46583 Ø 5 **P**
↓ 16,5 ↔ 9 cm

ART. 46244 Ø 5 **T**
↓ 16,5 ↔ 9 cm



ART. 49513 R **P**
↓ 19 ↔ 15 cm

ART. 49208 R **T**
↓ 19 ↔ 15 cm



ART. 46522 Ø 5 **P**
↓ 16,5 ↔ 9 cm

ART. 46243 Ø 5 **T**
↓ 16,5 ↔ 9 cm



ART. 46944 **P**
↓ 19 ↔ 12,5 cm



ART. 31806 9x12 cm
ART. 31807 11x15 cm



ART. 31808 9x12 cm
ART. 31809 11x15 cm



ART. 41047 ↓ 15 cm
ART. 41048 ↓ 20 cm
ART. 41049 ↓ 25 cm
ART. 41050 ↓ 30 cm
ART. 41051 ↓ 40 cm



ART. 46942 **P**
↓ 19 ↔ 12,5 cm



ART. 31802 9x12 cm
ART. 31803 11x15 cm



ART. 31804 9x12 cm
ART. 31805 11x15 cm



ART. 41004 ↓ 15 cm
ART. 41009 ↓ 20 cm
ART. 41010 ↓ 25 cm
ART. 41015 ↓ 30 cm
ART. 41016 ↓ 40 cm

fusione a terra



ART. 47605 R **P**
↓ 20,5 ↔ 13,5 cm

ART. 47225 R **T**
↓ 20,5 ↔ 13,5 cm



ART. 47607 R **P**
↓ 20 ↔ 13,5 cm

ART. 47247 R **T**
↓ 20 ↔ 13,5 cm

ART. 47250 R
↓ 29 ↔ 15 cm

ART. 47248 R
↓ 29 ↔ 15 cm



ART. 49625 R **P**
↓ 18 ↔ 18,5 cm

ART. 49225 R **T**
↓ 18 ↔ 18,5 cm



ART. 46605 Ø 5 **P**
↓ 17 ↔ 9,5 cm

ART. 46225 Ø 5 **T**
↓ 17 ↔ 9,5 cm

ART. 46250 Ø 5
↓ 22,5 ↔ 11,5 cm



ART. 49620 R **P**
↓ 18 ↔ 18,5 cm

ART. 49020 R **T**
↓ 18 ↔ 18,5 cm



ART. 46607 Ø 5 **P**
↓ 17 ↔ 9,5 cm

ART. 46247 Ø 5 **T**
↓ 17 ↔ 9,5 cm

ART. 46248 Ø 5
↓ 22,5 ↔ 11,5 cm



ART. 46934 **P**
↓ 18 ↔ 13 cm

ART. 46834 **T**
↓ 18 ↔ 13 cm



ART. 31786 7x9 cm
ART. 31787 8x10 cm
ART. 31759 9x12 cm
ART. 31760 11x15 cm



ART. 31788 7x9 cm
ART. 31789 8x10 cm
ART. 31761 9x12 cm
ART. 31762 10x15 cm
ART. 31763 11x15 cm



ART. 41042 ↓ 15 cm
ART. 41043 ↓ 20 cm
ART. 41044 ↓ 25 cm
ART. 41045 ↓ 30 cm
ART. 41046 ↓ 40 cm



ART. 46937 **P**
↓ 18 ↔ 13 cm

ART. 46680 **T**
↓ 18 ↔ 13 cm



ART. 31786 7x9 cm
ART. 31787 8x10 cm
ART. 31759 9x12 cm
ART. 31760 11x15 cm



ART. 31788 7x9 cm
ART. 31789 8x10 cm
ART. 31761 9x12 cm
ART. 31762 10x15 cm
ART. 31763 11x15 cm



ART. 41042 ↓ 15 cm
ART. 41043 ↓ 20 cm
ART. 41044 ↓ 25 cm
ART. 41045 ↓ 30 cm
ART. 41046 ↓ 40 cm

fusione a terra



fusione a terra



ART. 47641 R P
↓ 21 ↔ 13,5 cm

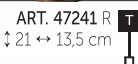

ART. 47241 R T
↓ 21 ↔ 13,5 cm



ART. 47618 R P
↓ 21 ↔ 13,5 cm

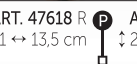

ART. 47228 R T
↓ 21 ↔ 13,5 cm



ART. 49615 R P
↓ 18 ↔ 19 cm

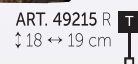

ART. 49215 R T
↓ 18 ↔ 19 cm



ART. 49631 R P
↓ 18 ↔ 19 cm

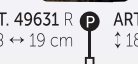

ART. 49228 R T
↓ 18 ↔ 19 cm



ART. 46641 Ø 5 P
↓ 17 ↔ 10,5 cm

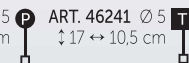

ART. 46241 Ø 5 T
↓ 17 ↔ 10,5 cm



ART. 49824 R P
↓ 22 ↔ 56,5 cm



ART. 46608 Ø 5 P
↓ 17 ↔ 10,5 cm

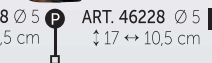

ART. 46228 Ø 5 T
↓ 17 ↔ 10,5 cm



ART. 49823 R P
↓ 22 ↔ 56,5 cm



ART. 46903 P
↓ 19 ↔ 12,5 cm



ART. 31786 7x9 cm
ART. 31787 8x10 cm
ART. 31759 9x12 cm
ART. 31760 11x15 cm



ART. 31788 7x9 cm
ART. 31789 8x10 cm
ART. 31761 9x12 cm
ART. 31762 10x15 cm
ART. 31763 11x15 cm



ART. 41042 ↓ 15 cm
ART. 41043 ↓ 20 cm
ART. 41044 ↓ 25 cm
ART. 41045 ↓ 30 cm
ART. 41046 ↓ 40 cm



ART. 46945 P
↓ 19 ↔ 12,5 cm



ART. 31730 9x12 cm
ART. 31731 11x15 cm



ART. 31732 9x12 cm
ART. 31733 10x15 cm
ART. 31734 11x15 cm



ART. 41042 ↓ 15 cm
ART. 41043 ↓ 20 cm
ART. 41044 ↓ 25 cm
ART. 41045 ↓ 30 cm
ART. 41046 ↓ 40 cm

fusione a terra con inserto a cera persa



fusione a terra con inserto in acciaio inox microfuso

fusione a terra con inserto in acciaio inox microfuso in bagno oro 24k



ART. 47640 R P ART. 47226 R T
 ↓ 21 ↔ 13,5 cm ↓ 21 ↔ 13,5 cm



ART. 47649 R P ART. 47249 R T
 ↓ 21 ↔ 13,5 cm ↓ 21 ↔ 13,5 cm



ART. 49630 R P ART. 49226 R T
 ↓ 18 ↔ 19 cm ↓ 18 ↔ 19 cm



ART. 49616 R P ART. 49216 R T
 ↓ 18 ↔ 19 cm ↓ 18 ↔ 19 cm



ART. 46606 Ø 5 P
 ↓ 17 ↔ 10,5 cm



ART. 46226 Ø 5 T
 ↓ 17 ↔ 10,5 cm

ART. 49822 R P
 ↓ 22 ↔ 56,5 cm



ART. 46649 Ø 5 P
 ↓ 17 ↔ 10,5 cm



ART. 46249 Ø 5 T
 ↓ 17 ↔ 10,5 cm

ART. 49825 R P
 ↓ 22 ↔ 56,5 cm



ART. 46933 P
 ↓ 19 ↔ 12,5 cm

ART. 46833 T
 ↓ 19 ↔ 12,5 cm



ART. 31735 9x12 cm
 ART. 31736 11x15 cm



ART. 31737 9x12 cm
 ART. 31738 10x15 cm
 ART. 31739 11x15 cm



ART. 41042 ↓ 15 cm
 ART. 41043 ↓ 20 cm
 ART. 41044 ↓ 25 cm
 ART. 41045 ↓ 30 cm
 ART. 41046 ↓ 40 cm



ART. 46912 P
 ↓ 19 ↔ 12,5 cm

ART. 46828 T
 ↓ 19 ↔ 12,5 cm



ART. 31747 9x12 cm
 ART. 31748 11x15 cm



ART. 31764 9x12 cm
 ART. 31765 10x15 cm
 ART. 31766 11x15 cm



ART. 41042 ↓ 15 cm
 ART. 41043 ↓ 20 cm
 ART. 41044 ↓ 25 cm
 ART. 41045 ↓ 30 cm
 ART. 41046 ↓ 40 cm

fusione a terra

fusione a cera persa



ART. 47619 R P ART. 47229 R T
 ↓ 20 ↔ 11,5 cm ↓ 20 ↔ 11,5 cm



ART. 47626 R P ART. 47126 R T
 ↓ 20 ↔ 13,5 cm ↓ 20 ↔ 13,5 cm
 ART. 47121 R T
 ↓ 28 ↔ 20 cm



ART. 49614 R P ART. 49229 R T
 ↓ 19 ↔ 16 cm ↓ 19 ↔ 16 cm



ART. 46935 P ART. 46835 T
 ↓ 19 ↔ 12,5 cm ↓ 19 ↔ 12,5 cm



ART. 49626 R P ART. 49126 R T
 ↓ 16 ↔ 17 cm ↓ 16 ↔ 17 cm



ART. 46904 P ART. 46704 T
 ↓ 18 ↔ 13 cm ↓ 18 ↔ 13 cm
 ART. 46703 T
 ↓ 21 ↔ 17 cm



ART. 46609 Ø 5 P ART. 46229 Ø 5 T
 ↓ 16,5 ↔ 9 cm ↓ 16,5 ↔ 9 cm



ART. 31745 9x12 cm



ART. 31746 9x12 cm



ART. 46626 Ø 5 P ART. 46126 Ø 5 T
 ↓ 21 ↔ 9 cm ↓ 21 ↔ 9 cm
 ART. 46121 Ø 5 T
 ↓ 27 ↔ 13 cm



ART. 31700 9x12 cm
 ART. 31701 11x15 cm



ART. 31720 9x12 cm
 ART. 31721 10x15 cm
 ART. 31722 11x15 cm



ART. 47063A P
↓ 28 ↔ 16 cm



ART. 47532A P
↓ 20 ↔ 10 cm



ART. 49552A P ART. 49052A P
↓ 18 ↔ 15 cm ↓ 18 ↔ 15 cm



ART. 46531A Ø 5
↓ 19 ↔ 8 cm

ART. 46031A Ø 5
↓ 19 ↔ 8 cm



ART. 47067 P
↓ 28 ↔ 13 cm



ART. 47065 P
↓ 28 ↔ 13 cm



ART. 47066 P
↓ 28 ↔ 13 cm



ART. 47068 P
↓ 28 ↔ 13 cm



ART. 46865
↓ 24 ↔ 13 cm



ART. 46856
↓ 27 ↔ 15 cm



ART. 46065 Ø 6
↓ 25 ↔ 12 cm



ART. 46066 Ø 6
↓ 25 ↔ 12 cm



ART. 46068 Ø 6
↓ 25 ↔ 12 cm

SERIE **HOLLY**



ART. 47606 P
↓ 17,5 ↔ 8 cm



ART. 46603 Ø 5
↓ 18,5 ↔ 6,5 cm



ART. 47603
↓ 17,5 ↔ 8 cm



ART. 37204 P
↓ 23 ↔ 10 cm



ART. 37203 P
↓ 18 ↔ 8,5 cm



ART. 37202 P
↓ 14 ↔ 6 cm



ART. 37214 P
↓ 19 ↔ 10,5 cm



ART. 37405 R
↓ 15 ↔ 9 cm
ART. 37406 R
↓ 20 ↔ 10 cm
ART. 37407 R
↓ 24 ↔ 12 cm
ART. 37408 R
↓ 30 ↔ 14 cm



ART. 37206 R
↓ 15 ↔ 9 cm
ART. 37207 R
↓ 20 ↔ 10 cm
ART. 37208 R
↓ 24 ↔ 12 cm
ART. 37209 R
↓ 30 ↔ 14 cm



FIAMMA SINISTRA
ART. 43700 P Ø 6
↓ 29 ↔ 29 cm



FIAMMA DESTRA
ART. 43702 P Ø 6
↓ 29 ↔ 29 cm



ART. 39018 P
↓ 19 ↔ 15 cm



ART. 49505 P
↓ 18 ↔ 13 cm



PORTAFIORE RAME
finitura neutra

ART. 37428
↓ 10 ↔ 5 cm
ART. 37427
↓ 13 ↔ 6 cm
ART. 37426
↓ 18 ↔ 8 cm



PORTAFIORE RAME
finitura renaissance

ART. 37422
↓ 10 ↔ 5 cm
ART. 37421
↓ 13 ↔ 6 cm
ART. 37420
↓ 18 ↔ 8 cm



PORTAFIORE RAME
finitura dorata

ART. 37425
↓ 10 ↔ 5 cm
ART. 37424
↓ 13 ↔ 6 cm
ART. 37423
↓ 18 ↔ 8 cm



ART. 37404 P
↓ 23 ↔ 10 cm



ART. 37403 P
↓ 18 ↔ 8,5 cm



ART. 37402 P
↓ 14 ↔ 6 cm



ART. 37418 P
↓ 19 ↔ 10,5 cm



ART. 37412 R
↓ 17 ↔ 11 cm



ART. 37417 P
↓ 16 ↔ 10,5 cm

ART. 37413 R
↓ 20 ↔ 11 cm



ART. 37411 R
↓ 20 ↔ 10 cm



ART. 36156 Ø 5
↓ 19 ↔ 10 cm



Ribaltina ART. 36060
↓ 17,5 ↔ 38 4,8 cm



ART. 46590 Ø 5
↓ 23 ↔ 7 cm



ART. 36153 Ø 5 P
↓ 16 ↔ 9 cm



ART. 36013 Ø 5 T
↓ 17 ↔ 9 cm



ART. 36012 Ø 4 T
↓ 13 ↔ 7 cm



ART. 36152 Ø 4 P
↓ 13 ↔ 7 cm



ART. 36353
↓ 13 ↔ 11 cm

ART. 37217 R
↓ 22 ↔ 10 cm

ART. 36020 Ø 5
↓ 22 ↔ 10 cm

ART. 36203
↓ 16 ↔ 11 cm



ART. 47315 P
↓ 13 ↔ 7 cm

ART. 46315 Ø 4 P
↓ 13,5 ↔ 7 cm

ART. 47307 P
↓ 13,5 ↔ 7 cm

ART. 46306 Ø 4 P
↓ 14 ↔ 6 cm

ART. 47307MO P
↓ 13,5 ↔ 7 cm

ART. 46306MO Ø 4 P
↓ 14 ↔ 6 cm

ART. 47546 P
↓ 12 ↔ 7 cm

ART. 46543 Ø 4 P
↓ 14 ↔ 7 cm

ART. 47503 P
↓ 12 ↔ 7 cm

ART. 46502 Ø 4 P
↓ 14 ↔ 7 cm

ART. 47503MO P
↓ 12 ↔ 7 cm

ART. 46502MO Ø 4 P
↓ 14 ↔ 7 cm

ART. 47316 R
↓ 13 ↔ 7 cm

ART. 46016 Ø 4 T
↓ 13,5 ↔ 7 cm

ART. 47267 P T
↓ 13,5 ↔ 7 cm

ART. 46009 Ø 4 T
↓ 14 ↔ 6 cm

ART. 47267MO P T
↓ 13,5 ↔ 7 cm

ART. 46009MO Ø 4 T
↓ 14 ↔ 6 cm

ART. 47543 R
↓ 12 ↔ 7 cm

ART. 46043 Ø 4 T
↓ 14 ↔ 7 cm

ART. 47502 R
↓ 12 ↔ 7 cm

ART. 46013 Ø 4 T
↓ 14 ↔ 7 cm

ART. 47502MO R
↓ 12 ↔ 7 cm

ART. 46013MO Ø 4 T
↓ 14 ↔ 7 cm

ART. 47275 P T
↓ 13 ↔ 7 cm

ART. 47276 R
↓ 13 ↔ 7 cm

ART. 47046 P T
↓ 12 ↔ 7 cm

ART. 47043 R
↓ 12 ↔ 7 cm

ART. 47013 P T
↓ 12 ↔ 7 cm

ART. 47012 R
↓ 12 ↔ 7 cm

ART. 47013MO P T
↓ 12 ↔ 7 cm

ART. 47012MO R
↓ 12 ↔ 7 cm



ART. 47309 P
↓ 13 ↔ 7,5 cm

ART. 46304 Ø 4 P
↓ 13 ↔ 6,5 cm

ART. 47309MO P
↓ 13 ↔ 7,5 cm

ART. 46304MO Ø 4 P
↓ 13 ↔ 6,5 cm

ART. 47309DU P
↓ 13 ↔ 7,5 cm

ART. 46304DU Ø 4 P
↓ 13 ↔ 6,5 cm

ART. 47655 P
↓ 13 ↔ 7 cm

ART. 47155 P T
↓ 13 ↔ 7 cm

ART. 46654 Ø 4 P
↓ 13 ↔ 7 cm

ART. 47655DU P
↓ 13 ↔ 7 cm

ART. 47155DU P T
↓ 13 ↔ 7 cm

ART. 46654DU Ø 4 P
↓ 13 ↔ 7 cm

ART. 47010 P T
↓ 13 ↔ 7,5 cm

ART. 46004 Ø 4 T
↓ 13 ↔ 6,5 cm

ART. 47010MO P T
↓ 13 ↔ 7,5 cm

ART. 46004MO Ø 4 T
↓ 13 ↔ 6,5 cm

ART. 47010DU P T
↓ 13 ↔ 7,5 cm

ART. 46004DU Ø 4 T
↓ 13 ↔ 6,5 cm

ART. 47654 R
↓ 13 ↔ 7 cm

ART. 47154 R
↓ 13 ↔ 7 cm

ART. 46154 Ø 4 T
↓ 13 ↔ 7 cm

ART. 47654DU R
↓ 13 ↔ 7 cm

ART. 47154DU R
↓ 13 ↔ 7 cm

ART. 46154DU Ø 4 T
↓ 13 ↔ 7 cm



ART. 47678 P
↓ 12 ↔ 7 cm

ART. 47178 P T
↓ 12 ↔ 7 cm

ART. 46678 Ø 4 P
↓ 13 ↔ 7 cm

ART. 47676 P
↓ 12 ↔ 7 cm

ART. 47176 P T
↓ 12 ↔ 7 cm

ART. 46676 Ø 4 P
↓ 13 ↔ 7 cm

ART. 47662 P
↓ 13 ↔ 8 cm

ART. 47162 P T
↓ 13 ↔ 8 cm

ART. 46662 Ø 4 P
↓ 13 ↔ 7 cm

ART. 47561 P
↓ 13 ↔ 7 cm

ART. 47157 P T
↓ 13 ↔ 7 cm

ART. 46557 Ø 4 P
↓ 13 ↔ 7 cm

ART. 47689 R
↓ 12 ↔ 7 cm

ART. 47189 R
↓ 12 ↔ 7 cm

ART. 46178 Ø 4 T
↓ 13 ↔ 7 cm

ART. 47677 R
↓ 12 ↔ 7 cm

ART. 47177 R
↓ 12 ↔ 7 cm

ART. 46176 Ø 4 T
↓ 13 ↔ 7 cm

ART. 47661 R
↓ 13 ↔ 8 cm

ART. 47161 R
↓ 13 ↔ 8 cm

ART. 46162 Ø 4 T
↓ 13 ↔ 7 cm

ART. 47563 R
↓ 13 ↔ 7 cm

ART. 47156 R
↓ 13 ↔ 7 cm

ART. 46156 Ø 4 T
↓ 13 ↔ 7 cm



ART. 47508 P
↓ 13 ↔ 6 cm



ART. 47008 P T
↓ 13 ↔ 6 cm

ART. 46508 Ø 4
↓ 13 ↔ 6 cm



ART. 47504 P
↓ 12 ↔ 8 cm

ART. 47004 P T
↓ 13 ↔ 7 cm



ART. 46503 Ø 4
↓ 14 ↔ 6 cm

ART. 47507 R
↓ 13 ↔ 6 cm

ART. 47009 R
↓ 13 ↔ 6 cm

ART. 46008 Ø 4
↓ 13 ↔ 6 cm

ART. 47509 R
↓ 12 ↔ 8 cm

ART. 47011 R
↓ 12 ↔ 8 cm

ART. 46003 Ø 4
↓ 14 ↔ 6 cm



ART. 47599 R P
↓ 12 ↔ 7,5 cm

ART. 46588 Ø 4
↓ 13 ↔ 7,5 cm



ART. 47657 R P
↓ 12 ↔ 7,5 cm

ART. 46589 Ø 4
↓ 13 ↔ 7,5 cm



ART. 47658 R P
↓ 12 ↔ 7,5 cm

ART. 46591 Ø 4
↓ 13 ↔ 7,5 cm



ART. 47257 R T
↓ 12 ↔ 7,5 cm

ART. 46246 Ø 4
↓ 13 ↔ 7,5 cm

ART. 47258 R T
↓ 12 ↔ 7,5 cm

ART. 46251 Ø 4
↓ 13 ↔ 7,5 cm

Finitura Folk

Finitura Blues



ART. 47624 P
↓ 12 ↔ 7 cm

ART. 47186 P T
↓ 12 ↔ 7 cm

ART. 46623 Ø 4
↓ 14 ↔ 8 cm



ART. 47622 P
↓ 12 ↔ 7 cm

ART. 47184 P T
↓ 12 ↔ 7 cm



ART. 46621 Ø 4
↓ 14 ↔ 8 cm

ART. 47623 R
↓ 12 ↔ 7 cm

ART. 47185 R
↓ 12 ↔ 7 cm

ART. 46185 Ø 4
↓ 14 ↔ 8 cm

ART. 47621 R
↓ 12 ↔ 7 cm

ART. 47175 R
↓ 12 ↔ 7 cm

ART. 46184 Ø 4
↓ 14 ↔ 8 cm



ART. 47611 P
cm ↓ 11 ↔ 5 cm



ART. 46611 P
Ø 4 cm
↓ 10,5 ↔ 5 cm



ART. 47540 P
↓ 12 ↔ 5 cm

ART. 47040 P T
↓ 13 ↔ 7 cm



ART. 46540 Ø 4
↓ 12 ↔ 5 cm

ART. 46040 Ø 4
↓ 13 ↔ 5 cm



ART. 47331 P
↓ 13 ↔ 7 cm

ART. 47259 P T
↓ 13,5 ↔ 7,5 cm

ART. 46331 Ø 4
↓ 13,5 ↔ 7,5 cm



ART. 47331DU P
↓ 13 ↔ 7 cm

ART. 47259DU P T
↓ 13,5 ↔ 7,5 cm



ART. 46331DU Ø 4
↓ 13,5 ↔ 7,5 cm

ART. 47332 R
↓ 13 ↔ 7 cm

ART. 47260 R
↓ 13 ↔ 7,5 cm

ART. 46259 Ø 4
↓ 13,5 ↔ 7,5 cm

ART. 47332DU R
↓ 13 ↔ 7 cm

ART. 47260DU R
↓ 13 ↔ 7,5 cm

ART. 46259DU Ø 4
↓ 13,5 ↔ 7,5 cm



ART. 47505 R P
↓ 15,5 ↔ 4,5 cm

ART. 47005 R T
↓ 15,5 ↔ 4,5 cm



ART. 47300 P
↓ 12,5 ↔ 6 cm



ART. 47635 P
↓ 11 ↔ 3,5 cm



con biadesivo
ART. 47637 P
↓ 12 ↔ 5 cm



ART. 47331BI P
↓ 13 ↔ 7 cm

ART. 47332BI R
↓ 13 ↔ 7 cm

ART. 47259BI P
↓ 13,5 ↔ 7,5 cm

ART. 47260BI R
↓ 13 ↔ 7,5 cm



ART. 46331BI Ø 4 P
↓ 13,5 ↔ 7,5 cm

ART. 46259BI Ø 4 T
↓ 13,5 ↔ 7,5 cm

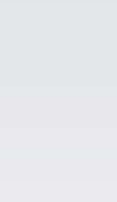

ART. 47331CA P
↓ 13 ↔ 7 cm

ART. 47332CA R
↓ 13 ↔ 7 cm

ART. 47259CA P
↓ 13,5 ↔ 7,5 cm

ART. 47260CA R
↓ 13 ↔ 7,5 cm



ART. 46331CA Ø 4 P
↓ 13,5 ↔ 7,5 cm

ART. 46259CA Ø 4 T
↓ 13,5 ↔ 7,5 cm



ART. 47655CA P
↓ 13 ↔ 7 cm

ART. 47654CA R
↓ 13 ↔ 7 cm

ART. 47155CA P
↓ 13 ↔ 7 cm

ART. 47154CA R
↓ 13 ↔ 7 cm



ART. 46654CA P
Ø 4 ↓ 13 ↔ 7 cm

ART. 46154CA T
Ø 4 ↓ 13 ↔ 7 cm



ART. 47655BO P
↓ 13 ↔ 7 cm

ART. 47654BO R
↓ 13 ↔ 7 cm

ART. 47155BO P
↓ 13 ↔ 7 cm

ART. 47154BO R
↓ 13 ↔ 7 cm



ART. 46654BO P
Ø 4 ↓ 13 ↔ 7 cm

ART. 46154BO T
Ø 4 ↓ 13 ↔ 7 cm



ART. 47331BO P
↓ 13 ↔ 7 cm

ART. 47332BO R
↓ 13 ↔ 7 cm

ART. 47259BO Ø 4 T
↓ 13,5 ↔ 7,5 cm

ART. 47260BO R
↓ 13 ↔ 7,5 cm

ART. 46331BO Ø 4 P
↓ 13,5 ↔ 7,5 cm

ART. 46259BO Ø 4 T
↓ 13,5 ↔ 7,5 cm



ART. 47678CA P
13x7 cm



ART. 46678CA P
Ø cm 4 - 12x7 cm



ART. 47504CA P
12x8 cm



ART. 46503CA P
Ø cm 4 - 14x6 cm



ART. 47309BI P
↓ 13 ↔ 7,5 cm

ART. 47010BI P
↓ 13 ↔ 7,5 cm



ART. 46304BI Ø 4 P
↓ 13 ↔ 6,5 cm

ART. 46004BI Ø 4 T
↓ 13 ↔ 6,5 cm



ART. 47309BO P
↓ 13 ↔ 7,5 cm

ART. 47010BO P
↓ 13 ↔ 7,5 cm



ART. 46304BO Ø 4 P
↓ 13 ↔ 6,5 cm

ART. 46004BO Ø 4 T
↓ 13 ↔ 6,5 cm



ART. 47309CA P
↓ 13 ↔ 7,5 cm

ART. 47010CA P
↓ 13 ↔ 7,5 cm



ART. 46304CA Ø 4 P
↓ 13 ↔ 6,5 cm

ART. 46004CA Ø 4 T
↓ 13 ↔ 6,5 cm



ART. 47622CA P
↓ 12 ↔ 7 cm

ART. 47621CA R
↓ 12 ↔ 7 cm



ART. 47184CA P
↓ 12 ↔ 7 cm

ART. 47175CA R
↓ 12 ↔ 7 cm

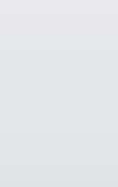

ART. 46621CA Ø 4 P
↓ 12 ↔ 7 cm

ART. 46184CA Ø 4 T
↓ 12 ↔ 7 cm



ART. 47622BO P
↓ 12 ↔ 7 cm

ART. 47621BO R
↓ 12 ↔ 7 cm



ART. 47184BO P
↓ 12 ↔ 7 cm

ART. 47175BO R
↓ 12 ↔ 7 cm



ART. 46621BO Ø 4 P
↓ 12 ↔ 7 cm

ART. 46184BO Ø 4 T
↓ 12 ↔ 7 cm



ART. 47300BI P
↓ 12,5 ↔ 6 cm



ART. 47300BO P
↓ 12,5 ↔ 6 cm



ART. 47300CA P
↓ 12,5 ↔ 6 cm



ART. 47635CA P
↓ 11 ↔ 3,5 cm



ART. 47635BO P
↓ 11 ↔ 3,5 cm

Finitura lucida e finitura opaca



NOVITÀ



ART. 47659 P
↓ 14 ↔ 7,5 cm



ART. 47659 P
↓ 13 ↔ 5,5 cm



ART. 47659BO P
↓ 13 ↔ 5,5 cm



ART. 47659CA P
↓ 13 ↔ 5,5 cm



ART. 47659MO P
↓ 13 ↔ 5,5 cm



ART. 47659DU P
↓ 13 ↔ 5,5 cm



Per ordinazioni aggiungere al codice articolo la sigla corrispondente alla colorazione scelta.
To place orders add to the article code the letter corresponding the selected colouring.



Finitura lucida e finitura opaca



ART. 47653 P
↓ 14 ↔ 7,5 cm



ART. 47653 P
↓ 14 ↔ 7,5 cm



ART. 47653BO P
↓ 14 ↔ 7,5 cm



ART. 47653CA P
↓ 14 ↔ 7,5 cm



ART. 47653MO P
↓ 14 ↔ 7,5 cm



ART. 47653DU P
↓ 14 ↔ 7,5 cm



A tutta la serie **UNITED** e **UNITED RIFLESSI** possono essere abbinati e forniti a parte gli accessori:
73709- interno
90457- lumino a pile Ø 3 ↓ 10

Per ordinazioni aggiungere al codice articolo la sigla corrispondente alla colorazione scelta.
To place orders add to the article code the letter corresponding the selected colouring.

Pannello solare regolabile con accumulatore



ART. 36090
↓ 12 ↔ 11 cm



ART. 46875
↓ 27 ↔ 15 cm



ART. 46876
↓ 27 ↔ 15 cm



ART. 46877
↓ 24 ↔ 13 cm



ART. 47453 P
↓ 6 ↔ 16 cm



ART. 47452 P
↓ 3 ↔ 16 cm



ART. 47476 R
Ø 15 cm

ART. 47459 R
↓ 6 ↔ 16 cm

ART. 47458 R
↓ 3 ↔ 16 cm

LAMPADE A CERO 4 CRISTALLI



ART. 46860
↓ 26 ↔ 14 cm



ART. 46859
↓ 22 ↔ 14 cm



ART. 46851
↓ 22 ↔ 14 cm



ART. 46852
↓ 26 ↔ 14 cm



ART. 46870 Ø 6
↓ 20 ↔ 10 cm



ART. 46868 Ø 5
↓ 17 ↔ 10 cm



ART. 46869 Ø 6
↓ 16 ↔ 10 cm



ART. 46867 Ø 5
↓ 15 ↔ 10 cm



ART. 46758 Ø 6
↓ 15,5 ↔ 16 cm



ART. 46711
↓ 7 ↔ 16 cm



ART. 46710
↓ 2 ↔ 12 cm



ART. 36310 P
↓ 7 ↔ 15,5 cm



ART. 47874 P
↓ 4 ↔ 15,5 cm



ART. 46749 Ø 6
↓ 16 ↔ 9 cm



ART. 46748 Ø 5
↓ 13,5 ↔ 9 cm



ART. 47469 P
↓ 8 ↔ 17 cm



ART. 46895
Ø 5 ↓ 16 ↔ 9 cm

ART. 47875 R
↓ 4 ↔ 15,5 cm

ART. 47468 R
↓ 8 ↔ 17 cm



ART. 47892 R
↓ 5 Ø 19 cm

ART. 47893 P
↓ 5 Ø 19 cm



ART. 47474 P
↓ 3 ↔ 16 cm

ART. 47475 R
↓ 3 ↔ 16 cm



ART. 47890 R
↓ 3 Ø 13,5 cm

ART. 47895 P
↓ 3 Ø 13,5 cm



ART. 36303
↓ 12 ↔ 18,5 cm



ART. 37303 P
↓ 10 ↔ 18 cm



ART. 37304 P
↓ 1,5 ↔ 17,5 cm



ART. 46893
Ø 6 ↓ 3 cm Ø 13,5 cm



ART. 46892
Ø 5 ↓ 2 cm Ø 9 cm



ART. 47887 P
↓ 8 ↔ 17 cm

ART. 47886 R
↓ 8 ↔ 17 cm



ART. 47889 P
↓ 8 ↔ 17 cm

ART. 47888 R
↓ 8 ↔ 17 cm



ART. 36300 P
↓ 12 ↔ 18,5 cm



ART. 37300 P
↓ 10 ↔ 18 cm



ART. 37301 P
↓ 1,5 ↔ 17,5 cm



ART. 47870 P
↓ 4,5 ↔ 15 cm

ART. 47871 R
↓ 4,5 ↔ 15 cm



ART. 47872 P
↓ 9,5 ↔ 19,5 cm

ART. 47873 R
↓ 9,5 ↔ 19,5 cm



ART. 46718 Ø 5
↓ 4 ↔ 9 cm

ART. 46719 Ø 6
↓ 4 ↔ 9 cm

PLAFONIERA PARETE



ART. 46735
↓ 10,5 ↔ 19,5 cm



ART. 46720
↓ 9,5 ↔ 19,5 cm

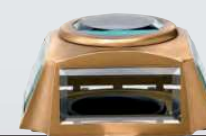

ART. 46721
↓ 10,5 ↔ 19,5 cm



ART. 40785 R
↓ 12,5 ↔ 24 cm



ART. 40788 R
↓ 12,5 ↔ 24 cm

FIORIERE

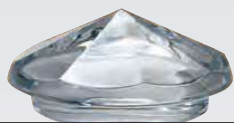

ART. 83851

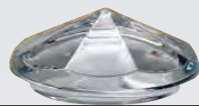

ART. 83849

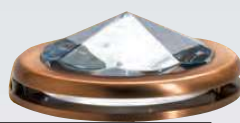

ART. 46768
Ø 12 cm

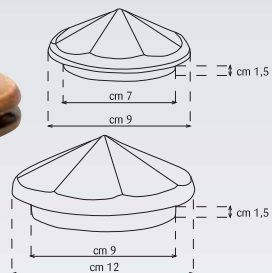

INCASSO



ART. 46717
Ø 12 cm



ART. 46713
Ø 12 cm



ART. 46710
Ø 12 cm



ART. 46732
Ø 12 cm



ART. 46733
Ø 12 cm



ART. 36035
Ø 12 cm



ART. 36033
Ø 12 cm

PORTINA



ART. 85047

FIAMMA PER PORTINA



ART. 46947
Ø 12 cm



ART. 36024
a soffitto
Ø 12 cm



FIAMMA BLU
ART. 46769B
h. 9 cm - Ø 12 cm



FIAMMA AMBRA
ART. 46769A
h. 9 cm - Ø 12 cm



FIAMMA ROSA
ART. 46769R
h. 9 cm - Ø 12 cm



FIAMMA VERDE ACQUA
ART. 46769V
h. 9 cm - Ø 12 cm



ART. 46769
h. 9 cm - Ø 12 cm



ART. 36025
Ø 9 cm



ART. 36026
Ø 9 cm



ART. 36034
Ø 9 cm



ART. 36027
Ø 9 cm

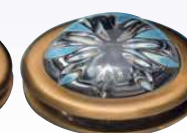

ART. 36028
Ø 9 cm



ART. 36029
Ø 9 cm



ART. 36030
Ø 9 cm



ART. 36036
Ø 9 cm



ART. 36023
a soffitto
Ø 9 cm



ART. 36031
Ø 5,5 cm

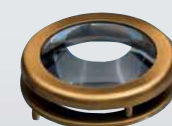

ART. 46796
Ø 5,5 cm
Compreso interno
ART. 73709

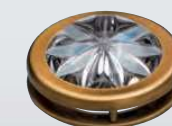

ART. 36032
Ø 5,5 cm



ART. 36037
Ø 5,5 cm



ART. 36022
a soffitto
Ø 5,5 cm



ART. 46717CA
Ø 12 cm



ART. 46733CA
Ø 12 cm



ART. 46675CA
Ø 12 cm



ART. 46732CA
Ø 12 cm



ART. 46717BO
Ø 12 cm



ART. 46733BO
Ø 12 cm



ART. 46675BO
Ø 12 cm



ART. 46732BO
Ø 12 cm



ART. 46713CA
Ø 12 cm



ART. 46710CA
Ø 12 cm



ART. 46947CA
Ø 12 cm



ART. 36025CA
Ø 9 cm



ART. 46713BO
Ø 12 cm



ART. 46710BO
Ø 12 cm



ART. 46947BO
Ø 12 cm



ART. 36025BO
Ø 9 cm



ART. 36034CA
Ø 9 cm



ART. 36027CA
Ø 9 cm



ART. 36026CA
Ø 9 cm



ART. 36029CA
Ø 9 cm



ART. 36034BO
Ø 9 cm



ART. 36027BO
Ø 9 cm



ART. 36026BO
Ø 9 cm



ART. 36029BO
Ø 9 cm



ART. 36036CA
Ø 9 cm



ART. 36032CA
Ø 5,5 cm



ART. 36031CA
Ø 5,5 cm



ART. 36037CA
Ø 5,5 cm



ART. 46796CA
Ø 5,5 cm
Compreso interno
ART. 73709



ART. 36036BO
Ø 9 cm



ART. 36032BO
Ø 5,5 cm



ART. 36031BO
Ø 5,5 cm



ART. 36037BO
Ø 5,5 cm



ART. 46796BO
Ø 5,5 cm
Compreso interno
ART. 73709

GHIERA DORATA



ART. 36083 Ø 5
↓ 12 ↔ 7 cm



ART. 36086 Ø 5
↓ 2 ↔ 9 cm



ART. 16074
fiamma Ø 5
↓ 12 ↔ 8,5 cm

INOX



ART. 16076
fiamma Ø 5
↓ 12 ↔ 7 cm

INOX



ART. 16077
fiamma Ø 4
↓ 8,5 ↔ 6 cm

ART. 16077SF
solo ghiera Ø 5
↓ 12 ↔ 7 cm

ART. 16077SF
solo ghiera Ø 4
↓ 8,5 ↔ 6 cm

P.L.P. BRONZO



ART. 36087 Ø 5
↓ 12 ↔ 7 cm



ART. 36089 Ø 4
↓ 9 ↔ 6 cm

OTIPRINT



CARRARA
ART. 36081CA Ø 5
↓ 12 ↔ 7 cm



BIANCO
ART. 36081BI Ø 5
↓ 12 ↔ 7 cm



BOTTICINO
ART. 36081BO Ø 5
↓ 12 ↔ 7 cm



ART. 36081
Ø 5
↓ 12 ↔ 7 cm

ART. 36081SF
↓ 12 ↔ 7 cm
solo ghiera Ø 5



ART. 36080 Ø 4
↓ 8,5 ↔ 6 cm

ART. 36080SF
↓ 8,5 ↔ 6 cm
solo ghiera Ø 4



ART. 36082 Ø 4
↓ 9,5 ↔ 3,5 cm

ART. 36088 Ø 5
↓ 13 ↔ 6,5 cm
con attacco Ø 4



CARRARA
ART. 36080CA Ø 4
↓ 8,5 ↔ 6 cm



BIANCO
ART. 36080BI Ø 4
↓ 8,5 ↔ 6 cm



BOTTICINO
ART. 36080BO Ø 4
↓ 8,5 ↔ 6 cm



fiamma cristallo
ART. 85028 Ø 5
↓ 12 cm



fiamma cristallo
ART. 85027 Ø 5
↓ 12 cm



fiamma cristallo
ART. 85026 Ø 5
↓ 12 cm



fiamma cristallo
ART. 85061 Ø 5



fiamma cristallo
ART. 85071 Ø 5
ART. 85067 Ø 4



fiamma cristallo
ART. 85052 Ø 5
ART. 85037 Ø 4



fiamma cristallo
ART. 85079 Ø 5



fiamma venezia (vetro)
ART. 85054 Ø 4
ART. 85055 Ø 5
ART. 85076 Ø 6



fiamma cristallo
ART. 85087 Ø 5



fiamma cristallo
ART. 85077 Ø 5
ART. 85036 Ø 4



fiamma roma (vetro)
ART. 85049 Ø 5
ART. 85034 Ø 4



ART. 36410 Ø 8
↓ 95 ↔ 63 cm



ART. 43523
↓ 88 ↔ 38 cm
fiamma Ø 6



ART. 43524
↓ 88 ↔ 38 cm
fiamma Ø 8



ART. 43527
↓ 94 ↔ 25 cm
fiamma Ø 6



ART. 43531
↓ 98 ↔ 27 cm
fiamma Ø 8



ART. 43520 Ø 8
↓ 125 ↔ 33 cm



ART. 36400 Ø 8
↓ 85 ↔ 40 cm



ART. 43529
↓ 92 ↔ 25 cm
per fiamma Ø 6



ART. 43528
↓ 94 ↔ 27 cm
fiamma Ø 6



ART. 43526
↓ 88 ↔ 38 cm
fiamma Ø 6



ART. 43525
↓ 88 ↔ 38 cm
fiamma Ø 6



ART. 31634 6x8 cm
ART. 31633 7x9 cm
ART. 31663 8x10 cm
ART. 40106 9x12 cm
ART. 40107 11x15 cm
ART. 31664 13x18 cm



ART. 31635 7x9 cm
ART. 31636 8x10 cm
ART. 40126 9x12 cm
ART. 40127 10x5 cm
ART. 40128 11x5 cm
ART. 40139 13x18 cm



ART. 31634SH 6x8 cm
ART. 31633SH 7x9 cm
ART. 31663SH 8x10 cm
ART. 40106SH 9x12 cm
ART. 40107SH 11x15 cm
ART. 31664SH 13x18 cm



ART. 31635SH 7x9 cm
ART. 31636SH 8x10 cm
ART. 40126SH 9x12 cm
ART. 40127SH 10x15 cm
ART. 40128SH 11x15 cm
ART. 40139SH 13x18 cm



ART. 40152 7x9 cm
ART. 40153 8x10 cm
ART. 40154 9x12 cm
ART. 40155 11x15 cm



ART. 40156 9x12 cm
ART. 40170 10x15 cm
ART. 40171 11x15 cm



ART. 40102 8x10 cm
ART. 40100 9x12 cm
ART. 40101 11x15 cm
ART. 40103 13x18 cm
ART. 40104 18x24 cm



ART. 40119 8x10 cm
ART. 40120 9x12 cm
ART. 40121 11x15 cm
ART. 40122 10x15 cm
ART. 40124 13x18 cm
ART. 40123 18x24 cm

OTIPRINT



CARRARA
ART. 31633CA 7x9 cm
ART. 31663CA 8x10 cm
ART. 40106CA 9x12 cm
ART. 40107CA 11x15 cm
ART. 31664CA 13x18 cm



CARRARA
ART. 31635CA 7x9 cm
ART. 31636CA 8x10 cm
ART. 40126CA 9x12 cm
ART. 40127CA 10x15 cm
ART. 40128CA 11x15 cm
ART. 40139CA 13x18 cm



BOTTICINO
ART. 31633BO 7x9 cm
ART. 31663BO 8x10 cm
ART. 40106BO 9x12 cm
ART. 40107BO 11x15 cm
ART. 31664BO 13x18 cm



BOTTICINO
ART. 31635BO 7x9 cm
ART. 31636BO 8x10 cm
ART. 40126BO 9x12 cm
ART. 40127BO 10x15 cm
ART. 40128BO 11x15 cm
ART. 40139BO 13x18 cm

CON INSERTO TITANIO



ART. 40201 9x12 cm
ART. 40202 11x15 cm
ART. 40203 13x18 cm



ART. 40204 9x12 cm
ART. 40205 10x15 cm
ART. 40206 11x15 cm
ART. 40207 13x18 cm

CON INSERTO BAGNO ORO 24 K



ART. 40182 9x12 cm
ART. 40183 11x15 cm
ART. 40195 13x18 cm
ART. 40168 18x24 cm



ART. 40187 9x12 cm
ART. 40188 11x15 cm
ART. 40196 13x18 cm
ART. 40169 18x24 cm



BIANCO
ART. 31633BI 7x9 cm
ART. 31663BI 8x10 cm
ART. 40106BI 9x12 cm
ART. 40107BI 11x15 cm
ART. 31664BI 13x18 cm



BIANCO
ART. 31635BI 7x9 cm
ART. 31636BI 8x10 cm
ART. 40126BI 9x12 cm
ART. 40127BI 10x15 cm
ART. 40128BI 11x15 cm
ART. 40139BI 13x18 cm



ART. 40160 9x12 cm
ART. 40161 11x15 cm
ART. 40162 13x18 cm



ART. 40165 9x12 cm
ART. 40166 11x15 cm
ART. 40167 13x18 cm



Inclinazione a richiesta su tutti i tipi cornici



Inclinazione a richiesta su tutti i tipi cornici



ART. 40108 9x12 cm
ART. 40109 11x15 cm
ART. 40110 13x18 cm



ART. 40111 9x12 cm
ART. 40112 11x15 cm
ART. 40113 13x18 cm



ART. 40114 9x12 cm
ART. 40115 11x15 cm
ART. 40116 13x18 cm



ROSA
ART. 38606 7x4 cm



ROSA
ART. 38607 7x4 cm



ART. 31630 8x10 cm
ART. 31631 9x12 cm
ART. 31632 11x15 cm



ART. 31630SH 8x10 cm
ART. 31631SH 9x12 cm
ART. 31632SH 11x15 cm



ART. 31621 7x9 cm
ART. 31622 8x10 cm
ART. 31623 9x12 cm
ART. 31624 11x15 cm
ART. 31625 13x18 cm
ART. 31626 18x24 cm



ART. 31674 6x8 cm
ART. 40130 7x9 cm
ART. 31675 7x10 cm
ART. 40131 8x10 cm



ART. 40140 7x9 cm
ART. 40141 8x10 cm
ART. 40142 9x12 cm
ART. 40143 10x15 cm



ART. 31659
Ø 10 cm



ART. 40148 9x12 cm
ART. 40149 11x15 cm



ART. 40150 9x12 cm
ART. 40151 11x15 cm

Inclinazione
a richiesta
su tutti i tipi cornici



ART. 31640 8x10 cm
ART. 31641 9x12 cm
ART. 31642 11x15 cm



ART. 31650 9x12 cm
ART. 31651 11x15 cm
ART. 31652 13x18 cm

CORNICI CON COPERCHIO



ART. 31696 6x8 cm
ART. 31775 7x9 cm
ART. 31776 8x 0 cm
ART. 31777 9x 2 cm



Inclinazione a richiesta su tutti i tipi cornici

CON INSERTO BAGNO ORO 24 K

CON INSERTO TITANIO



ART. 35235 9x12 cm
ART. 35245 10x15 cm
ART. 35255 11x15 cm
ART. 35247 13x18 cm

ART. 35275 9x12 cm
ART. 35215 11x15 cm
ART. 35248 13x18 cm

ART. 35312 9x12 cm
ART. 35313 11x15 cm
ART. 35318 13x18 cm

ART. 35303 9x12 cm
ART. 35304 11x15 cm
ART. 35317 13x18 cm

ART. 35236 9x12 cm
ART. 35237 10x15 cm
ART. 35238 11x15 cm
ART. 35239 13x18 cm

ART. 35212 9x12 cm
ART. 35213 11x15 cm
ART. 35214 13x18 cm



NOVITÀ



NOVITÀ



ART. 35296 9x12 cm
ART. 35138 10x15 cm
ART. 35297 11x15 cm
ART. 35316 13x18 cm

ART. 35256 9x12 cm
ART. 35257 10x15 cm
ART. 35258 11x15 cm
ART. 35259 13x18 cm

ART. 35307 9x12 cm
ART. 35308 11x15 cm
ART. 35309 13x18 cm

ART. 35320 9x12 cm
ART. 35321 10x15 cm
ART. 35322 13x18 cm

ART. 35300 9x12 cm
ART. 35301 11x15 cm
ART. 35302 13x18 cm

ART. 35136 9x12 cm
ART. 35137 11x15 cm

*Cornice a titolo d'esempio.
Non inclusa nel prezzo.*



ART. 35231 9x12 cm
ART. 35241 10x15 cm
ART. 35251 11x15 cm

ART. 35201 9x12 cm
ART. 35211 11x15 cm
ART. 35220 13x18 cm
ART. 35270 18x24 cm

ART. 35293 9x12 cm
ART. 35294 11x15 cm
ART. 35295 13x18 cm

ART. 35290 9x12 cm
ART. 35139 10x15 cm
ART. 35291 11x15 cm
ART. 35292 13x18 cm

ART. 35130
per cornice 17x13,5 cm

ART. 35133
per cornice 18x14,5 cm

ART. 35285 9x12 cm
ART. 35287 10x15 cm
ART. 35286 11x15 cm

ART. 35280 9x12 cm
ART. 35281 11x15 cm

ART. 35131
per cornice 22x17,5 cm

ART. 35134
per cornice 22x18 cm

Il prezzo di listino è comprensivo della base con incisione
dei nome, cognome e data.

ART. 35132
per cornice 26,5x20,5 cm

ART. 35135
per cornice 26,5x21 cm



ART. 35230 9x12 cm
ART. 35240 10x15 cm
ART. 35250 11x18 cm

ART. 35200 9x12 cm
ART. 35210 11x15 cm



ART. 38415
applicazione cornice inclinata

Applicazione adottata
per inclinare qualsiasi tipo
di cornice ovale e rettangolare.



MEZZOTONDO
ART. 33106 P
↓ 30 ↔ 13 cm
ART. 33111
↓ 40 ↔ 17 cm
ART. 33116
↓ 50 ↔ 22 cm

MEZZOTONDO
ART. 41011 P
↓ 15 ↔ 10 cm
ART. 41012
↓ 20 ↔ 11 cm
ART. 33108
↓ 30 ↔ 13 cm
ART. 33113
↓ 40 ↔ 17 cm
ART. 33118
↓ 50 ↔ 22 cm

MEZZOTONDO
ART. 33107 P
↓ 30 ↔ 13 cm
ART. 33112
↓ 40 ↔ 17 cm
ART. 33117
↓ 50 ↔ 22 cm

MEZZOTONDO
ART. 33109 P
↓ 30 ↔ 13 cm
ART. 33114
↓ 40 ↔ 17 cm
ART. 33119
↓ 50 ↔ 22 cm



ART. 41271 P
↓ 47 ↔ 23 cm

ART. 41270 P
↓ 39 ↔ 21 cm

ART. 41269 P
↓ 30 ↔ 16,5 cm

ART. 41268 P
↓ 20 ↔ 10,5 cm

ART. 41267 P
↓ 10 ↔ 5,5 cm



ART. 41277 P
↓ 80 ↔ 32 cm

ART. 41278 T
↓ 82 ↔ 32 cm



ART. 41275 P
↓ 78 ↔ 36,5 cm

ART. 41279 T
↓ 40 ↔ 21 cm

ART. 41280
↓ 50 ↔ 23 cm

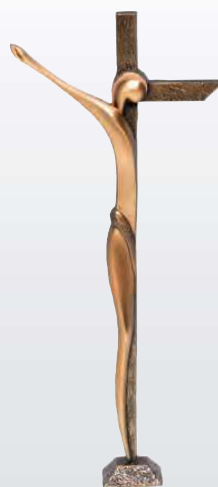

ART. 41276 T
↓ 80 ↔ 36,5 cm



ART. 41136 P
↓ 15 ↔ 6,5 cm
ART. 41137
↓ 20 ↔ 9 cm
ART. 41138
↓ 25 ↔ 11 cm
ART. 41139
↓ 30 ↔ 13 cm
ART. 41140
↓ 40 ↔ 18 cm
ART. 41141
↓ 50 ↔ 21,5 cm



ART. 41142 P
↓ 20 ↔ 9 cm
ART. 41143
↓ 25 ↔ 11 cm
ART. 41144
↓ 30 ↔ 13 cm
ART. 41145
↓ 40 ↔ 18 cm
ART. 41147
↓ 50 ↔ 21,5 cm



ART. 41148 P
↓ 15 ↔ 6,5 cm
ART. 41149
↓ 20 ↔ 9 cm
ART. 41157
↓ 25 ↔ 11 cm
ART. 41158
↓ 30 ↔ 13 cm
ART. 41159
↓ 40 ↔ 18 cm
ART. 41160
↓ 50 ↔ 21,5 cm



- ART. 33010 ↓ 10 ↔ 5 cm P
- ART. 33012 ↓ 12 ↔ 5 cm
- ART. 33015 ↓ 15 ↔ 6 cm
- ART. 33020 ↓ 20 ↔ 6 cm
- ART. 33025 ↓ 25 ↔ 8 cm
- ART. 33030 ↓ 30 ↔ 8 cm
- ART. 33040 ↓ 40 ↔ 10 cm
- ART. 33050 ↓ 50 ↔ 12 cm
- ART. 33060 ↓ 60 ↔ 12 cm
- ART. 33070 ↓ 70 ↔ 12 cm
- ART. 33080 ↓ 80 ↔ 14 cm
- ART. 33090 ↓ 90 ↔ 14 cm
- ART. 33099 ↓ 100 ↔ 14 cm



- ART. 33010SH ↓ 10 ↔ 5 cm P
- ART. 33012SH ↓ 12 ↔ 5 cm
- ART. 33015SH ↓ 15 ↔ 6 cm
- ART. 33020SH ↓ 20 ↔ 6 cm
- ART. 33025SH ↓ 25 ↔ 8 cm
- ART. 33030SH ↓ 30 ↔ 8 cm
- ART. 33030SH ↓ 30 ↔ 8 cm
- ART. 33040SH ↓ 40 ↔ 10 cm
- ART. 33050SH ↓ 50 ↔ 12 cm



- ART. 33215 ↓ 15 ↔ 6 cm P
- ART. 33220 ↓ 20 ↔ 6 cm
- ART. 33225 ↓ 25 ↔ 8 cm
- ART. 33230 ↓ 30 ↔ 8 cm
- ART. 33240 ↓ 40 ↔ 10 cm



ART. 41266 P
↓ 50 ↔ 20 cm



ART. 41256 P
↓ 50 ↔ 20 cm



ART. 41026 P
↓ 45 ↔ 23 cm



ART. 41028 P
↓ 45 ↔ 23 cm



ART. 41025 P
↓ 45 ↔ 23 cm



ART. 41265 P
↓ 40 ↔ 16 cm



ART. 41255 P
↓ 40 ↔ 16 cm

OTIPRINT



- BIANCO
- ART. 41136BI ↓ 15 cm
- ART. 41137BI ↓ 20 cm
- ART. 41138BI ↓ 25 cm
- ART. 41139BI ↓ 30 cm
- ART. 41140BI ↓ 40 cm
- ART. 41141BI ↓ 50 cm



- CARRARA
- ART. 41136CA ↓ cm 15
- ART. 41137CA ↓ cm 20
- ART. 41138CA ↓ cm 25
- ART. 41139CA ↓ cm 30
- ART. 41140CA ↓ cm 40
- ART. 41141CA ↓ cm 50



- BOTTICINO
- ART. 41136BO ↓ cm 15
- ART. 41137BO ↓ cm 20
- ART. 41138BO ↓ cm 25
- ART. 41139BO ↓ cm 30
- ART. 41140BO ↓ cm 40
- ART. 41141BO ↓ cm 50



ART. 41171 ↓ 40 ↔ 18 cm P

ART. 41172 ↓ 50 ↔ 21,5 cm



ART. 41120 ↓ 12 ↔ 5 cm P

ART. 41121 ↓ 15 ↔ 6 cm

ART. 41122 ↓ 20 ↔ 8 cm

ART. 41123 ↓ 25 ↔ 10 cm



ART. 41248 P
 ↓ 12 ↔ 5 cm
 ART. 41249
 ↓ 15 ↔ 6 cm
 ART. 41250
 ↓ 20 ↔ 8 cm
 ART. 41251
 ↓ 25 ↔ 10 cm
 ART. 41252
 ↓ 30 ↔ 13 cm
 ART. 41253
 ↓ 40 ↔ 16 cm
 ART. 41254
 ↓ 50 ↔ 20 cm



ART. 41260 P
 ↓ 20 ↔ 8 cm
 ART. 41261
 ↓ 25 ↔ 10 cm
 ART. 41272
 ↓ 30 ↔ 13 cm
 ART. 41273
 ↓ 40 ↔ 16 cm
 ART. 41274
 ↓ 50 ↔ 20 cm



ART. 41262 P
 ↓ 30 ↔ 13 cm
 ART. 41263
 ↓ 40 ↔ 16 cm
 ART. 41264
 ↓ 50 ↔ 20 cm



ART. 41225 P
 ↓ 30 ↔ 12 cm



ART. 41226 P
 ↓ 40 ↔ 16 cm



ART. 41215 P
 ↓ 30 ↔ 12 cm
 ART. 41216
 ↓ 40 ↔ 16 cm



ART. 41220 P
 ↓ 30 ↔ 12 cm
 ART. 41221
 ↓ 40 ↔ 16 cm



ART. 41205 P
 ↓ 30 ↔ 12 cm
 ART. 41206
 ↓ 40 ↔ 16 cm



ART. 41283 P
 ↓ 40 ↔ 16 cm
 ART. 41284
 ↓ 50 ↔ 20 cm



ART. 41293 P
 ↓ 40 ↔ 16 cm
 ART. 41294
 ↓ 50 ↔ 20 cm



ART. 41282 P
 ↓ 30 ↔ 13 cm



ART. 31426 T
 ↓ 26 ↔ 11 cm



ART. 31438 T
 ↓ 38 ↔ 16 cm



ART. 41005 P
 ↓ 15 ↔ 8 cm
 ART. 41006
 ↓ 20 ↔ 11 cm
 ART. 41007
 ↓ 25 ↔ 14 cm
 ART. 41008
 ↓ 30 ↔ 14 cm

ART. 41000 P
 ↓ 15 ↔ 8 cm
 ART. 41001
 ↓ 20 ↔ 11 cm
 ART. 41002
 ↓ 25 ↔ 14 cm
 ART. 41003
 ↓ 30 ↔ 14 cm

ART. 41027 P
 ↓ 20 ↔ 13 cm

ART. 41018 ↓ 10 ↔ 5 cm P
 ART. 41019 ↓ 20 ↔ 10 cm P
 ART. 41023 ↓ 30 ↔ 14 cm P
 ART. 41024 ↓ 40 ↔ 16 cm P
 ART. 41029 ↓ 50 ↔ 16 cm P

ART. 41189 ↓ 10 ↔ 5 cm P
 ART. 41190 ↓ 20 ↔ 10 cm P
 ART. 41191 ↓ 30 ↔ 14 cm P
 ART. 41192 ↓ 40 ↔ 16 cm P
 ART. 41193 ↓ 50 ↔ 16 cm P

ART. 41194 ↓ 10 ↔ 5 cm P
 ART. 41195 ↓ 20 ↔ 10 cm P
 ART. 41196 ↓ 30 ↔ 14 cm P
 ART. 41197 ↓ 40 ↔ 16 cm P
 ART. 41198 ↓ 50 ↔ 16 cm P



ART. 41038 P
 ↓ 12 ↔ 5,5 cm

ART. 41039 P
 ↓ 20 ↔ 9 cm

ART. 41040 P
 ↓ 12 ↔ 7 cm

ART. 41041 P
 ↓ 20 ↔ 11 cm

ART. 41124 ↓ 10 ↔ 5 cm P
 ART. 41125 ↓ 20 ↔ 10 cm P
 ART. 41126 ↓ 30 ↔ 14 cm P
 ART. 41127 ↓ 40 ↔ 16 cm P
 ART. 41128 ↓ 50 ↔ 16 cm P

ART. 41109 ↓ 10 ↔ 5 cm P
 ART. 41110 ↓ 20 ↔ 10 cm P
 ART. 41111 ↓ 30 ↔ 14 cm P
 ART. 41112 ↓ 40 ↔ 16 cm P
 ART. 41113 ↓ 50 ↔ 16 cm P

ART. 41129 ↓ 10 ↔ 5 cm P
 ART. 41130 ↓ 20 ↔ 10 cm P
 ART. 41131 ↓ 30 ↔ 14 cm P
 ART. 41132 ↓ 40 ↔ 16 cm P
 ART. 41133 ↓ 50 ↔ 16 cm P

CROCI DA TAGLIO LASER



ART. 41237 ↓ 10 cm P
 ART. 41238 ↓ 12 cm P
 ART. 41239 ↓ 15 cm P
 ART. 41240 ↓ 20 cm P
 ART. 41241 ↓ 25 cm P

ART. 41242 ↓ 10 cm P
 ART. 41243 ↓ 12 cm P
 ART. 41244 ↓ 15 cm P
 ART. 41245 ↓ 20 cm P
 ART. 41246 ↓ 25 cm P

ART. 41227 ↓ 10 cm P
 ART. 41228 ↓ 12 cm P
 ART. 41229 ↓ 15 cm P
 ART. 41230 ↓ 20 cm P
 ART. 41231 ↓ 25 cm P

ART. 41232 ↓ 10 cm P
 ART. 41233 ↓ 12 cm P
 ART. 41234 ↓ 15 cm P
 ART. 41235 ↓ 20 cm P
 ART. 41236 ↓ 25 cm P

ART. 41100 ↓ 10 ↔ 5 cm P
 ART. 41101 ↓ 20 ↔ 10 cm P
 ART. 41102 ↓ 30 ↔ 14 cm P
 ART. 41103 ↓ 40 ↔ 16 cm P
 ART. 41104 ↓ 50 ↔ 16 cm P

In base alla dimensione possono subire variazioni nella forma.

In base alla dimensione possono subire variazioni nella forma.



ART. 32325 ↓ 25 ↔ 17 cm
ART. 32330 ↓ 30 ↔ 22 cm



ART. 32000 ↓ 8 ↔ 3 cm
ART. 32010 ↓ 10 ↔ 4 cm
ART. 32015 ↓ 15 ↔ 5 cm
ART. 32020 ↓ 20 ↔ 7 cm
ART. 32025 ↓ 25 ↔ 8 cm



ART. 32210 ↓ 10 ↔ 9 cm
ART. 32215 ↓ 15 ↔ 13 cm
ART. 32220 ↓ 20 ↔ 17 cm
ART. 32225 ↓ 25 ↔ 21 cm



ART. 32257
↓ 70 ↔ 54 cm



ART. 32256
↓ 50 ↔ 36 cm



ART. 32255
↓ 60 ↔ 45 cm



ART. 32040
↓ 40 ↔ 28 cm



ART. 32241
↓ 80 ↔ 75 cm
CERA PERSA



ART. 32242
↓ 120 ↔ 115 cm
CERA PERSA



ART. 32243
↓ 160 ↔ 149 cm
CERA PERSA

NOVITÀ



ART. 35156
↓ 12 ↔ 6,5 cm



ART. 35157
↓ 16 ↔ 8,5 cm



ART. 35158
↓ 20 ↔ 10,5 cm



ART. 35126
↓ 12 ↔ 9 cm
ART. 35123
↓ 16,5 ↔ 11 cm
ART. 35128
↓ 24 ↔ 16 cm



BIANCO
ART. 35126BI
↓ cm 12 ↔ 6 cm
ART. 35123BI
↓ cm 16,5 ↔ 11 cm
ART. 35128BI
↓ cm 24 ↔ 16 cm



CARRARA
ART. 35126CA
↓ cm 12 ↔ 6 cm
ART. 35123CA
↓ cm 16,5 ↔ 11 cm
ART. 35128CA
↓ cm 24 ↔ 16 cm



BOTTICINO
ART. 35126BO
↓ cm 12 ↔ 6 cm
ART. 35123BO
↓ cm 16,5 ↔ 11 cm
ART. 35128BO
↓ cm 24 ↔ 16 cm

OTIPRINT



ART. 35411
↓ 12,5 ↔ 8 cm



ART. 35412
↓ 17 ↔ 10,5 cm



ART. 35413
↓ 25 ↔ 16 cm



ART. 35118
↓ 15 ↔ 12 cm
fusione a terra



ART. 35041
↓ 19 ↔ 13 cm
fusione a terra



ART. 35024
↓ 20 ↔ 14 cm
fusione a terra



ART. 35017
↓ 21 ↔ 16,6 cm
fusione a terra



ART. 35020
↓ 13 ↔ 8 cm



ART. 35022
↓ 17,5 ↔ 10,5 cm



ART. 35023
↓ 27 ↔ 16 cm



ART. 35106
↓ 12 ↔ 6 cm
ART. 35107
↓ 18 ↔ 9 cm



ART. 35030
↓ 27 ↔ 20 cm



ART. 35051
↓ 26 ↔ 22 cm
fusione a terra



ART. 35035
↓ 33 ↔ 22 cm
fusione a terra



ART. 35028
↓ 30 ↔ 7,5 cm



Statua
ART. 48075 terreno
↓ 30 ↔ 7,5 cm



Statua
ART. 48076 parete
↓ 30 ↔ 7,5 cm

NOVITÀ



ART. 35161
↓ 11,5 ↔ 6,5 cm



ART. 35162
↓ 16 ↔ 8,5 cm



ART. 35163
↓ 19,5 ↔ 10,5 cm



ART. 35049
↓ 36 ↔ 26 cm
fusione a terra



Madonna del Carmine
ART. 35027
↓ 35 ↔ 18 cm



Madonna del Carmine
ART. 35026
↓ 38 ↔ 17 cm



ART. 35063
↓ 13,5 ↔ 8,5 cm



ART. 35064
↓ 18 ↔ 11,5 cm



ART. 35068
↓ 27 ↔ 17 cm

OTIPRINT



ART. 48541
↓ 43 ↔ 30 cm
fusione a terra



ART. 35046
↓ 25,5 ↔ 19,5 cm
fusione a terra



Busto
• ART. 48202
↓ 32 ↔ 28 cm
fusione a terra



ART. 35127
↓ 12 ↔ 9 cm
ART. 35124
↓ 16,5 ↔ 11 cm
ART. 35129
↓ 24 ↔ 16 cm



BIANCO
ART. 35127BI
↓ cm 12 ↔ 9 cm
ART. 35124BI
↓ cm 16,5 ↔ 11 cm
ART. 35129BI
↓ cm 24 ↔ 16 cm



CARRARA
ART. 35127CA
↓ cm 12 ↔ 9 cm
ART. 35124CA
↓ cm 16,5 ↔ 11 cm
ART. 35129CA
↓ cm 24 ↔ 16 cm



BOTTICINO
ART. 35127BO
↓ cm 12 ↔ 9 cm
ART. 35124BO
↓ cm 16,5 ↔ 11 cm
ART. 35129BO
↓ cm 24 ↔ 16 cm



ART. 35105
↓ 9 ↔ 12 cm



ART. 35114
↓ 15 ↔ 13 cm



ART. 35067
↓ 17 ↔ 13 cm



ART. 35042
↓ 19 ↔ 13 cm
fusione a terra



ART. 35034
↓ 33 ↔ 22 cm
fusione a terra



ART. 48508
↓ 35 ↔ 25 cm
fusione a terra



Cristo nazareno
ART. 35039
↓ 35 ↔ 27,5 cm



ART. 35025
↓ 20 ↔ 14 cm
fusione a terra



ART. 35099
↓ 24 ↔ 16 cm



ART. 35045
↓ 25,5 ↔ 19,5 cm
fusione a terra



ART. 35048
↓ 36 ↔ 26 cm
fusione a terra



ART. 48540
↓ 47 ↔ 30 cm
fusione a terra



ART. 35016
↓ 21 ↔ 16,6 cm
fusione a terra



ART. 35052
↓ 26 ↔ 20 cm
fusione a terra



ART. 35031
↓ 27 ↔ 20 cm



ART. 48205
↓ 41 ↔ 33 ↔ 21 cm
fusione a terra

**BUSTI
CRISTO**



ART. 48208
↓ 41 ↔ 33 ↔ 21 cm
fusione a terra

NOVITÀ



ART. 35164
↓ 12,5 ↔ 8 cm



ART. 35165
↓ 17 ↔ 11 cm



ART. 35166
↓ 20 ↔ 13 cm



ART. 35032
↓ 27 ↔ 30 cm



ART. 35018
↓ 27 ↔ 22,5 cm
fusione a terra



ART. 35044
↓ 32,5 ↔ 22 cm
fusione a terra

OTIPRINT



ART. 35078
↓ 13 ↔ 13 cm
ART. 35079
↓ 17 ↔ 17 cm
ART. 35080
↓ 24 ↔ 26 cm



BIANCO
ART. 35078BI
↓ cm 13 ↔ 13 cm
ART. 35079BI
↓ cm 17 ↔ 17 cm
ART. 35080BI
↓ cm 24 ↔ 26 cm



CARRARA
ART. 35078CA
↓ cm 13 ↔ 13 cm
ART. 35079CA
↓ cm 17 ↔ 17 cm
ART. 35080CA
↓ cm 24 ↔ 26 cm



BOTTICINO
ART. 35078BO
↓ cm 13 ↔ 13 cm
ART. 35079BO
↓ cm 17 ↔ 17 cm
ART. 35080BO
↓ cm 24 ↔ 26 cm



ART. 35047
↓ 33 ↔ 25,5 cm
fusione a terra



ART. 35053
↓ 32 ↔ 31,5 cm
fusione a terra



ART. 35043
↓ 22,5 ↔ 12,5 cm
fusione a terra



ART. 35081
↓ 14,5 ↔ 10,5 cm
ART. 35082
↓ 19 ↔ 14 cm
ART. 35083
↓ 28,5 ↔ 21 cm



ART. 35055
↓ 32 ↔ 24 cm
fusione a terra



ART. 35050
↓ 44 ↔ 37 cm
fusione a terra

PARTICOLARE **PIETÀ**



ART. 48529
 ↓ 48 ↔ 13 cm
 fusione a terra



ART. 48542
 ↓ 49 ↔ 49 cm
 fusione a terra



ART. 48532
 ↓ 51 ↔ 30 cm
 ART. 48539
 ↓ 34 ↔ 19 cm
 fusione a terra



ART. 48537
 ↓ 50 ↔ 37 cm
 fusione a terra



Papa Wojtyla
 ART. 35084
 ↓ 12,5 ↔ 11 cm
 fusione a terra



Papa Wojtyla
 ART. 35085
 ↓ 17,5 ↔ 15 cm
 fusione a terra



Papa Wojtyla
 ART. 35086
 ↓ 25,5 ↔ 22 cm
 fusione a terra



Papa Wojtyla
 ART. 35087
 ↓ 15 ↔ 11 cm



Papa Wojtyla
 ART. 35088
 ↓ 20 ↔ 15 cm



Papa Wojtyla
 ART. 35089
 ↓ 26,5 ↔ 19,5 cm



Targa S. Francesco da Paola
 ART. 35406
 ↓ 18 ↔ 12,5 cm
 fusione a terra



Medaglione Papa Giovanni XXIII
 ART. 35410
 ↓ 20,5 ↔ 17 cm
 fusione a terra



Medaglione S. Antonio
 ART. 35033
 ↓ 21 ↔ 13 cm



Medaglione Santa Rita
 ART. 35029
 ↓ 22 ↔ 13 cm
 fusione a terra



Padre Pio
ART. 35057
↓ 12,5 ↔ 12 cm
ART. 35058
↓ 17,5 ↔ 17 cm
ART. 35059
fusione a terra
↓ 22 ↔ 22 cm



Padre Pio
ART. 35056
↓ 20 ↔ 18 cm
fusione a terra



ART. 35010
↓ 8,5 ↔ 4 cm
ART. 35011
↓ 12 ↔ 6 cm
ART. 35012
↓ 17 ↔ 7,5 cm
fusione a terra



ART. 35013
↓ 8,5 ↔ 4 cm
ART. 35014
↓ 12 ↔ 6 cm
ART. 35015
↓ 17 ↔ 8 cm
fusione a terra



Ultima cena
ART. 35096
↓ 8 ↔ 24 cm



Padre Pio
ART. 35061
↓ 34 ↔ 34 cm
fusione a terra



Busto Padre Pio
ART. 48203
↓ 42 ↔ 34 ↗ 30 cm
fusione cera persa



ART. 35404
↓ 7,5 ↔ 12 cm
fusione a terra



ART. 35091
↓ 8 ↔ 8 cm

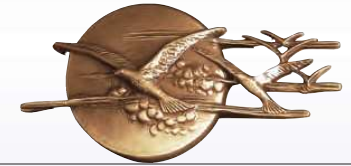

ART. 35090
↓ 8 ↔ 15,5 cm



Med. San Giuseppe
ART. 35037
↓ 39,5 ↔ 13,5 cm



Med. Sant'Antonio
ART. 35036
↓ 40,5 ↔ 13 cm



Med. Sacro Cuore
ART. 35038
↓ 43 ↔ 17 cm



Targa Vergine del Pilar
ART. 35040
↓ 43 ↔ 23 cm



Targa nonno con bambino
ART. 35402
↓ 10 ↔ 10 cm
fusione a terra



Applicazioni mani giunte con fissaggio viti
ART. 35097 ↓ 10 ↔ 8 cm
con biadesivo
ART. 35098 ↓ 10 ↔ 8 cm



ART. 35092
↓ 10 ↔ 7 cm



ART. 35093
↓ 10 ↔ 11,5 cm



Targa gioco bocce
ART. 35403
↓ 10,5 ↔ 13 cm
fusione a terra



Targa caminetto
ART. 35405
↓ 12,5 ↔ 11 cm
fusione a terra



Deposizione
ART. 48538
↓ 31 ↔ 50 cm
fusione a terra



ART. 35125
↓ 16,5 ↔ 10 cm



ART. 35094
↓ 15 ↔ 12,5 cm



ART. 35095
↓ 18 ↔ 10 cm



Ultima Cena
ART. 48502
↓ 35 ↔ 100 cm
fusione a terra



Targa angelo sx
ART. 35401
↓ 20 ↔ 13 cm
fusione a terra



Targa angelo dx
ART. 35400
↓ 20 ↔ 13 cm
fusione a terra



ART. 35021
↓ 32 ↔ 20 cm
fusione a terra



Cristo
ART. 38854
↓ 40 ↔ 37 cm
fusione cera persa



Particolare Pietà
ART. 38860
↓ 45 ↔ 40 cm
fusione cera persa



ART. 38455
↓ 10 ↔ 22 cm



ART. 38454
↓ 13 ↔ 19 cm



ART. 38453
↓ 14 ↔ 16 cm



Deposizione
ART. 38852
↓ 45 ↔ 80 cm
fusione cera persa



Particolare Pietà
ART. 48520
↓ 60 ↔ 45 cm
fusione a terra



Pietà
ART. 48522
↓ 65 ↔ 50 cm
fusione a terra



Crocefissione
ART. 38859
↓ 55 ↔ 40 cm
fusione a terra



Crocefissione
ART. 48543
↓ 50 ↔ 40 cm
fusione a terra



Crocefisso
ART. 38833
↓ 57 ↔ 43 cm
fusione a terra



Targa
ART. 48544
↓ 64 ↔ 44 cm
fusione a terra

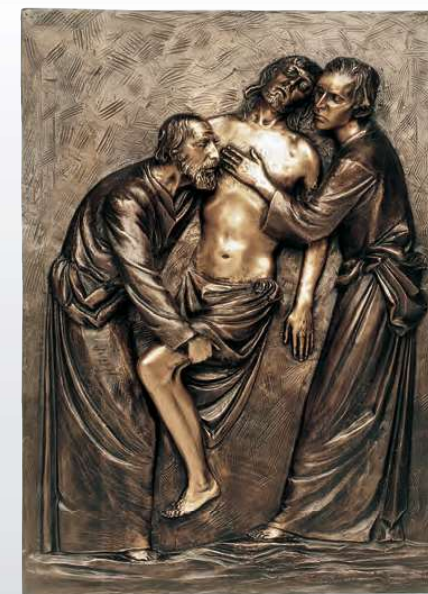

Deposizione
ART. 48580
↓ 70 ↔ 50 cm
fusione cera persa



Resurrezione
ART. 48525
↓ 75 ↔ 100 cm
fusione a terra



Sacra Famiglia
ART. 38831
↓ 80 ↔ 120 cm
fusione a terra



Resurrezione
ART. 38853
↓ 77 ↔ 85 cm
fusione cera persa



Resurrezione
ART. 38856
↓ 80 ↔ 40 cm
fusione cera persa



Sacra Famiglia
ART. 48581
↓ 95 ↔ 30 cm
fusione cera persa



Crocefissione
ART. 38832
↓ 110 ↔ 110 cm
fusione a terra



Deposizione
ART. 38861
↓ 100 ↔ 60 cm
fusione cera persa



ART. 48070
↓ 29 ↔ 9 cm



ART. 48075 **T**
↓ 30 ↔ 7,5 cm



ART. 48076 **P**
↓ 30 ↔ 7,5 cm



ART. 48077
↓ 40 ↔ 12,5 12 cm



ART. 48174
↓ 40 ↔ 15 cm



ART. 48200
↓ 41,5 ↔ 14,5 8 cm



ART. 48091
↓ 45 ↔ 26 ↗ 39 cm



ART. 48020
↓ 45 ↔ 23 ↗ 34 cm



ART. 48101
↓ 45 ↔ 30 ↗ 20 cm
fusione cera persa



ART. 48172
↓ 45 ↔ 23 ↗ 29 cm



ART. 48042
↓ 45 ↔ 23 ↗ 34 cm



ART. 48041
↓ 45 ↔ 26 ↗ 39 cm



ART. 48189
↓ 46 ↔ 20 cm



ART. 48194
↓ 46 ↔ 20 cm



ART. 48071
↓ 49 ↔ 14 ↗ 12 cm



ART. 48177
↓ 60 ↔ 22 cm



ART. 48178
↓ 67 ↔ 22 cm



ART. 48182
↓ 60 ↔ 22 cm



ART. 48165
↓ 60 ↔ 21 cm



ART. 48087
↓ 60 ↔ 18, 18 cm



ART. 38213
↓ 65 ↔ 14, 12 cm



Manto colorato
ART. 48193
↓ 60 ↔ 22 cm



ART. 48180
↓ 60 ↔ 22 cm



ART. 48053
↓ 65 ↔ 30, 37 cm
fusione cera persa



ART. 48054
↓ 65 ↔ 40, 37 cm
fusione cera persa



ART. 48146
 † 63 ↔ 28 cm
 fusione cera persa



finitura blues
 ART. 48034
 † 63 ↔ 28 cm
 fusione cera persa



finitura folk
 ART. 48160
 † 63 ↔ 28 cm
 fusione cera persa



ART. 48149
 † 64,5 ↔ 20 cm
 fusione cera persa



ART. 48150
 † 64 ↔ 18,5 cm
 fusione cera persa



ART. 38287
 † 80 ↔ 35 cm
 fusione cera persa



ART. 48147
 † 63 ↔ 22,5 cm
 fusione cera persa



finitura blues
 ART. 48033
 † 63 ↔ 22,5 cm
 fusione cera persa



finitura folk
 ART. 48159
 † 63 ↔ 22,5 cm
 fusione cera persa



ART. 48060
 † 80 ↔ 25 † 20 cm
 fusione cera persa



ART. 48066
 † 85 ↔ 25 † 16 cm



ART. 48065
 † 85 ↔ 33 † 23 cm



ART. 38259
↓ 75 ↔ 76 ↗ 55 cm
fusione cera persa

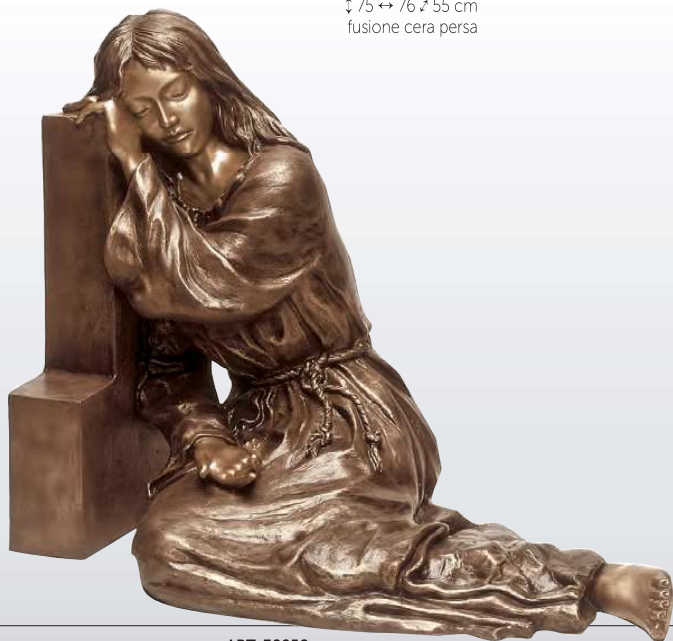

ART. 38258
↓ 80 ↔ 100 ↗ 60 cm
fusione cera persa



ART. 48050
↓ 100 ↔ 25 ↗ 24 cm
fusione cera persa



ART. 38288
↓ 105 ↔ 50 ↗ 30 cm
fusione cera persa



ART. 48119
↓ 110 ↔ 35 ↗ 32 cm
fusione cera persa



ART. 48052
↓ 100 ↔ 55 cm
fusione cera persa



ART. 48141
↓ 108 ↔ 55 ↗ 60 cm
fusione cera persa



ART. 38276
↓ 112 ↔ 53 cm
fusione cera persa



ART. 48069
↓ 110 ↔ 53 cm
fusione cera persa



Madonna di Lourdes
ART. 48116
↓ 80 ↔ 20 ↗ 20 cm
ART. 48117
↓ 110 ↔ 35 ↗ 30 cm
ART. 48118
↓ 150 ↔ 45 ↗ 42 cm
fusione cera persa



ART. 48055
↓ 105 ↔ 25 ↗ 25 cm
fusione cera persa



ART. 38289
↓ 125 ↔ 50
fusione cera persa



ART. 38253
↓ 125 ↔ 40 ↗ 60 cm
fusione cera persa



Madonna
ART. 38251
↓ 155 ↔ 40 ↗ 35 cm
fusione cera persa



Madonna
ART. 38290
↓ 175 ↔ 72, ↑ 53 cm
fusione cera persa



Madonna con Bambino
ART. 48135
↓ 185 ↔ 74, ↑ 49 cm
fusione cera persa



ART. 48080
↓ 29 ↔ 9 cm



ART. 48078
↓ 40 ↔ 16, ↑ 13 cm



ART. 48081
↓ 49 ↔ 14, ↑ 13 cm



ART. 48181
↓ 60 ↔ 22 cm



Manto colorato
ART. 48192
↓ 60 ↔ 22 cm



ART. 48166
↓ 60 ↔ 20 cm

CRISTO

CRISTO



ART. 48088
 † 60 ↔ 22 † 17 cm
 ART. 48096
 † 80 ↔ 34 † 26 cm

finitura colorata
 ART. 48045
 † 60 ↔ 22 † 17 cm

ART. 48151
 † 64 ↔ 26 cm
 fusione cera persa

ART. 38279
 † 75 ↔ 38 † 20 cm
 fusione cera persa

ART. 38275
 † 80 ↔ 25 † 20 cm
 fusione cera persa



ART. 48148
 † 62,5 ↔ 29,5 cm
 fusione cera persa

finitura folk
 ART. 48161
 † 62,5 ↔ 29,5 cm
 fusione cera persa

finitura blues
 ART. 48024
 † 62,5 ↔ 29,5 cm
 fusione cera persa

ART. 48067
 † 84 ↔ 23 † 16 cm

ART. 48068
 † 85 ↔ 45 † 29 cm



ART. 48106
↓ 100 ↔ 40 ↗ 60 cm
fusione cera persa



ART. 48140
↓ 104 ↔ 73 ↗ 81 cm
fusione cera persa



ART. 48120
↓ 110 ↔ 45 ↗ 32 cm
fusione cera persa



ART. 32244 **P**
↓ 108 ↔ 73 cm

ART. 32245 **T**
↓ 108 ↔ 73 cm
fusione cera persa



ART. 48100
↓ 110 ↔ 40 ↗ 60 cm
fusione cera persa



ART. 48138
↓ 115 ↔ 55 ↗ 47 cm
fusione cera persa



ART. 48137
↓ 120 ↔ 49 ↗ 70 cm
fusione cera persa



ART. 48105
↓ 125 ↔ 85 ↗ 90 cm
fusione cera persa



ART. 48139
↓ 140 ↔ 50 ↗ 165 cm
fusione cera persa



ART. 48114
↓ 136 ↔ 74 ↑ 41 cm
fusione cera persa



ART. 38250
↓ 140 ↔ 55 cm
fusione cera persa



ART. 48113
↓ 145 ↔ 60 ↑ 55 cm
ART. 48154
↓ 119 ↔ 41 ↑ 39 cm
fusione cera persa



ART. 38256
↓ 160 ↔ 48 ↑ 65 cm
fusione cera persa



ART. 48107
↓ 180 ↔ 90 cm
fusione cera persa



ART. 38220
↓ 55 ↔ 45 ↗ 35 cm
fusione cera persa



ART. 48124
↓ 45 ↔ 43 cm
fusione cera persa



ART. 48015
↓ 52 ↔ 36 ↗ 18,5 cm

ART. 48142
↓ 56 ↔ 67 ↗ 31 cm
fusione cera persa



ART. 48123
↓ 63 ↔ 60 ↗ 32 cm
fusione cera persa

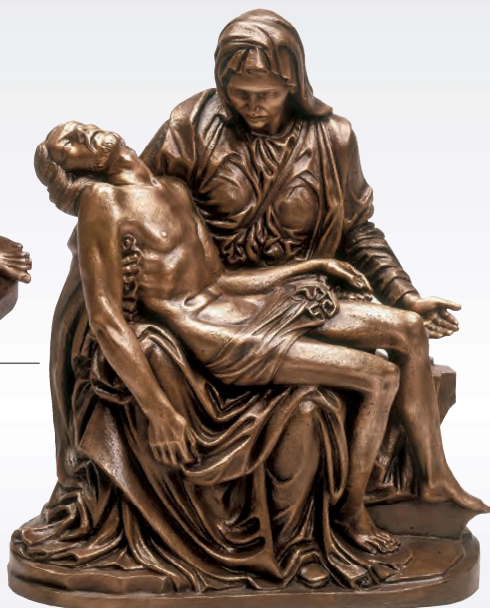

ART. 48001
↓ 70 ↔ 60 ↗ 27 cm
fusione cera persa



ART. 48084
↓ 74 ↔ 53 ↗ 33 cm
fusione cera persa



ART. 38291
↓ 85 ↔ 80 ↗ 55 cm
ART. 38292
↓ 95 ↔ 100 cm
fusione cera persa



ART. 38255
↓ 80 ↔ 110 cm
Pietà con base
ART. 38257
↓ 90 ↔ 110 cm
fusione cera persa



ART. 48000
 ↓ 85 ↔ 70 ↗ 40 cm
 fusione cera persa



ART. 48129
 ↓ 180 cm
 fusione cera persa



Gettafiori
ART. 48196
 ↓ 40 ↔ 15 cm
 fusione cera persa



finitura folk
ART. 48157
 ↓ 40 ↔ 15 cm
 fusione cera persa



finitura blues
ART. 48164
 ↓ 40 ↔ 15 cm
 fusione cera persa



Gettafiori con ali
ART. 48197
 ↓ 46 ↔ 15 cm
 fusione cera persa



finitura folk
ART. 48158
 ↓ 46 ↔ 15 cm
 fusione cera persa



finitura blues
ART. 48171
 ↓ 46 ↔ 15 cm
 fusione cera persa



ART. 48102
↓ 47 ↔ 20 cm
fusione cera persa



ART. 48188
↓ 53 ↔ 20 cm



ART. 48195
↓ 53 ↔ 20 cm



ART. 48199
↓ 66 ↔ 21,5 cm
fusione cera persa



finitura blues
ART. 48163
↓ 66 ↔ 21,5 cm
fusione cera persa



ART. 48198
↓ 60 ↔ 21,5 cm
fusione cera persa



finitura folk
ART. 48155
↓ 60 ↔ 21,5 cm
fusione cera persa



finitura blues
ART. 48162
↓ 60 ↔ 21,5 cm
fusione cera persa



finitura folk
ART. 48156
↓ 66 ↔ 21,5 cm
fusione cera persa



ART. 48109
↑ 90 ↔ 40 ↓ 65 cm
fusione cera persa



parete
ART. 48122
↑ 110 ↔ 50 ↓ 13 cm
fusione cera persa



ART. 48098
↑ 115 ↔ 59 ↓ 14 cm
fusione cera persa



ART. 48110
↑ 80 ↔ 40 ↓ 65 cm
fusione cera persa



ART. 48025
↑ 147 ↔ 34 ↓ 56 cm base 34x56 cm
fusione cera persa



ART. 38254
↓ 135 ↔ 25 cm
fusione cera persa



ART. 48005
base 45x45 cm
↓ 210 ↔ 127 ↗ 120 cm
fusione cera persa



finitura blues
ART. 48006
base 45x45 cm
↓ 210 ↔ 127 ↗ 120 cm
fusione cera persa



finitura folk
ART. 48007
base 45x45 cm
↓ 210 ↔ 127 ↗ 120 cm
fusione cera persa

S. ANTONIO



Aquila
ART. 48206
↓ 29 ↔ 60, 22 cm
fusione cera persa

Aquila
ART. 48207
↓ 42 ↔ 105, 24 cm
fusione cera persa



Statua S. Teresa
ART. 48169
↓ 60 ↔ 17 cm



S. Giuseppe
ART. 48179
↓ 63 ↔ 23 cm



Santa Barbara
ART. 38246
↓ 75 ↔ 30, 20 cm
fusione cera persa



Madonna del Carmine
ART. 48086
↓ 80 ↔ 25, 20 cm
fusione cera persa



ART. 38293
↓ 60 ↔ 20 cm
fusione cera persa



ART. 38294
↓ 80 ↔ 25 cm
fusione cera persa



ART. 38296
↓ 159 ↔ 52, 55 cm
fusione cera persa



ART. 48173
↓ 61 ↔ 21 cm base Ø 16 cm



ART. 38295
↓ 120 ↔ 40 cm
fusione cera persa



ART. 48170
↓ 60 ↔ 19 cm



ART. 48027
↓ 140 ↔ 44 cm
base 39x33 cm
fusione cera persa



ART. 48026
↓ 80 ↔ 26 cm base 24x20 cm
fusione cera persa



ART. 48031
↓ 180 ↔ 54 ↗ 61 cm
fusione cera persa



Papa Giovanni XXIII
ART. 48143
↓ 65 ↔ 26 ↗ 13 cm
fusione cera persa



San Francesco
ART. 48127
↓ 108 ↔ 35 ↗ 42 cm
fusione cera persa



Buon Pastore
ART. 48134
↓ 127 ↔ 46 ↗ 32 cm
fusione cera persa



Papa Wojtyła
ART. 48153
↑ 215 ↔ 110 cm
base 59x55 cm
fusione cera persa



Papa Wojtyła
ART. 48152
↑ 75 ↔ 19 cm
base 19,5x19 cm
fusione cera persa



San Francesco da Paola
ART. 48145
↑ 178 ↔ 67 ↙ 51 cm
fusione cera persa



Anime in volo
ART. 48132
↑ 172 ↔ 95 ↙ 100 cm
fusione cera persa

TRATTAMENTO ZEUS

Il trattamento **ZEUS**, sfruttando la nanotecnologia, crea uno strato inattaccabile da qualsiasi agente esterno, garantendovi

- ▶ DURATA
- ▶ QUALITÀ
- ▶ PROTEZIONE

*Corsivo
Vezzani*

Con l'applicazione della nostra vernice in polvere, la resa del rivestimento e l'effetto nel tempo creati dal trattamento **ZEUS**, aumentano notevolmente per darvi un prodotto che rimane invariato negli anni.



Grazie al nuovo **TRATTAMENTO ZEUS** vi offriamo un prodotto migliorato, resistente e inalterabile nel tempo

- ANTIGRAFFIO •
- ANTICORROSIONE •
- RESISTENZA TERMICA •
- PROTEZIONE DA AGENTI ESTERNI •

Come avviene la protezione dei materiali grazie a queste particelle? Sfruttando la nanotecnologia.

La densità di atomi che i materiali hanno sulla loro superficie è maggiore rispetto al normale: questo influenza e migliora proprietà come la potenza, la resistenza al calore e la durezza. Le nano particelle si dispongono sulla superficie e formano una barriera protettiva invisibile. La superficie quindi risulterà assolutamente inattaccabile da qualsiasi contaminazione esterna. Le particelle del trattamento Zeus, disponendosi nel modo ottimale, garantiscono lo strato protettivo.

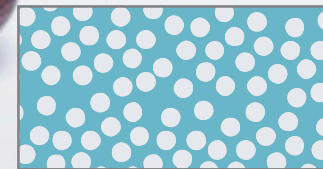

Disposizione Molecole Classica



Disposizione Trattamento Zeus

Corsivo Universal

A B C D E F G a b c d e f g h i
 H I J K L M N j k l m n o p q r
 O P Q R S T U s e t u v w x y
 V W X Y Z 1 2 3 4 5 6 7 8 9 0 ☆ †

13 11 2089
 12 12 1863

IL CORSIVO UNIVERSAL PUO' ESSERE RICHIESTO:

COMPRESSO

Universal

STANDARD

Universal

ALLARGATO

Universal

LE DATE POSSONO ESSERE RICHIESTE:

INCORPORATE NELL'ASTA

13 11 2089

APPOGGIATE NELL'ASTA

12 12 1863

SE AL MOMENTO DELL'ORDINE NON VIENE EFFETTUATA ALCUNA SPECIFICAZIONE, IL CORSIVO VIENE PRODOTTO AUTOMATICAMENTE STANDARD E CON DATE INCORPORATE NELL'ASTA.

ART. 6170	Lettere/Numeri ↓ mm 15	spessore mm 3
ART. 6171	Lettere/Numeri ↓ mm 20	spessore mm 4
ART. 6172	Lettere/Numeri ↓ mm 25	spessore mm 4
ART. 6173	Lettere/Numeri ↓ mm 30	spessore mm 4
ART. 6174	Lettere/Numeri ↓ mm 40	spessore mm 4
ART. 6175	Lettere/Numeri ↓ mm 50	spessore mm 4
ART. 6176	Lettere/Numeri ↓ mm 60	spessore mm 4
ART. 6178	Lettere/Numeri ↓ mm 80	spessore mm 4
ART. 6179	Lettere/Numeri ↓ mm 100	spessore mm 4

Finitura

SHADOW	+ 20%	RIFLESSI	+ 20%
YELLOW	+ 20%	PATINA SCURA	+ 20%
BIANCO	+ 10%	ASTER	+ 60%
ORO	+ 60%	OTIPRINT	+ 60%

Punteggiatura gratuita fino al mm. 50
 Lettere e Numeri sciolti: aumento del 20%

- È possibile richiedere il carattere Corsivo Universal di qualsiasi misura, previo preventivo.
- I numeri sono da intendersi su barretta se non diversamente specificato al momento dell'ordine.
- Negli ordini citare sempre l'altezza delle lettere minuscole a corpo semplice (a-c-m-etc...).
- Le lettere maiuscole hanno un'altezza superiore alle lettere minuscole del 100% circa e vengono conteggiate allo stesso prezzo delle lettere minuscole.
- L'altezza delle date indica sempre il numero con asta compresa.

Free punctuation up to 50 mm.

Loose letters and numbers: 20% increase

- It is possible to ask for the font Universal italics in any size, after a price estimate.
- The numbers are to be meant on underscore of not differently specified at the order.
- In the orders always indicate the height of the lower-case letters in simple type size (a-c-m-etc...).
- The upper case letters are higher by about 100% than the lower-case letters, and are counted in the same way as the lower-case letters.
- The height of the dates are always indicated number included underscore.

Corsivo
Plus

A B C D E F G a b c d e f g h i
H I J K L M N n j k l m n o p q r
Q R S T U u s e t u v w x z
V W X Y Z 1 2 3 4 5 6 7 8 9 0 * †

13 11 2089
12 12 1863

IL CORSIVO PLUS PUO' ESSERE RICHIESTO:

COMPRESSO
Plus
STANDARD
Plus
ALLARGATO
Plus

LE DATE POSSONO ESSERE RICHIESTE:

INCORPORATE NELL'ASTA
13 11 2089
APPOGGIATE NELL'ASTA
12 12 1863

SE AL MOMENTO DELL'ORDINE NON VIENE EFFETTUATA ALCUNA SPECIFICAZIONE, IL CORSIVO VIENE PRODOTTO AUTOMATICAMENTE STANDARD E CON DATE INCORPORATE NELL'ASTA.

ART. 6200 Lettere/Numeri ↓ mm 15 spessore mm 3
ART. 6201 Lettere/Numeri ↓ mm 20 spessore mm 3
ART. 6203 Lettere/Numeri ↓ mm 25 spessore mm 3
ART. 6204 Lettere/Numeri ↓ mm 30 spessore mm 3
ART. 6205 Lettere/Numeri ↓ mm 40 spessore mm 3
ART. 6206 Lettere/Numeri ↓ mm 50 spessore mm 3
ART. 6207 Lettere/Numeri ↓ mm 60 spessore mm 3
ART. 6208 Lettere/Numeri ↓ mm 80 spessore mm 3
ART. 6210 Lettere/Numeri ↓ mm 100 spessore mm 3

Finitura			
SHADOW	+ 20%	RIFLESSI	+ 20%
YELLOW	+ 20%	PATINA SCURA	+ 20%
BIANCO	+ 10%	ASTER	+ 60%
ORO	+ 60%	OTIPRINT	+ 60%

Punteggiatura gratuita fino al mm. 50

Lettere e Numeri sciolti: aumento del 20%

- È possibile richiedere il carattere Corsivo Plus di qualsiasi misura, previo preventivo.
- I numeri sono da intendersi su barretta se non diversamente specificato al momento dell'ordine.
- Negli ordini citare sempre l'altezza delle lettere minuscole a corpo semplice (a-c-m-etc...).
- Le lettere maiuscole hanno un'altezza superiore alle lettere minuscole del 100% circa e vengono conteggiate allo stesso prezzo delle lettere minuscole.
- L'altezza delle date indica sempre il numero con asta compresa.

Free punctuation up to 50 mm.

Loose letters and numbers: 20% increase

- It is possible to ask for the font Plus italics in any size, after a price estimate
- The numbers are to be meant on underscore of not differently specified at the order.
- In the orders always indicate the height of the lower-case letters in simple type size (a-c-m-etc...).
- The upper case letters are higher by about 100% than the lower-case letters, and are counted in the same way as the lower-case letters.
- The height of the dates are always indicated number included underscore.

Corsivo Plus S

A B C D E F G
H I J K L M N
O P Q R S T U
V W X Y Z

a b c d e f g h i
j k l m n o p q r
s t u v w x z
1 2 3 4 5 6 7 8 9 0 ☆ †

ART. 6211 Lettere/Numeri ↓ mm 20 spessore mm 6

ART. 6212 Lettere/Numeri ↓ mm 25 spessore mm 6

ART. 6213 Lettere/Numeri ↓ mm 30 spessore mm 6

ART. 6214 Lettere/Numeri ↓ mm 40 spessore mm 6

Finitura			
SHADOW	+ 20%	RIFLESSI	+ 20%
YELLOW	+ 20%	PATINA SCURA	+ 20%
BIANCO	+ 10%	ASTER	+ 60%
ORO	+ 60%	OTIPRINT	+ 60%

Il corsivo PLUS S può essere richiesto: SOLO STANDARD
The PLUS S may be required: ONLY STANDARD

Date con numeri sciolti = aumento del 20%
Punteggiatura gratuita fino al mm 50

- Negli ordini citare sempre l'altezza delle lettere minuscole a corpo semplice (a-c-m...).
- Le lettere maiuscole hanno un'altezza superiore del 100% circa e vengono conteggiate come le minuscole.
- L'altezza delle date indica sempre il numero con asta compresa.

- Free punctuation up to 50 mm.
Loose letters and numbers: 20% increase
- The numbers are to be meant on underscore of not differently specified at the order.
 - In the orders always indicate the height of the lower-case letters in simple type size (a-c-m-etc...).
 - The upper case letters are higher by about 100% than the lower-case letters, and are counted in the same way as the lower-case letters.
 - The height of the dates are always indicated number included underscore.

LE DATE POSSONO ESSERE RICHIESTE:
INCORPORATE NELL'ASTA
13 11 2089
APPOGGIATE NELL'ASTA
12 12 1863
SE AL MOMENTO DELL'ORDINE NON VIENE EFFETTUATA ALCUNA SPECIFICAZIONE, IL CORSIVO VIENE PRODOTTO AUTOMATICAMENTE STANDARD E CON DATE INCORPORATE NELL'ASTA.

Corsivo Boutique

Bon

ART. 6224 Lettere/Numeri ↓ mm 20 spessore mm 6

ART. 6229 Lettere/Numeri ↓ mm 25 spessore mm 6

ART. 6234 Lettere/Numeri ↓ mm 30 spessore mm 6

ART. 6244 Lettere/Numeri ↓ mm 40 spessore mm 6

- Le date possono essere: incorporate - appoggiate - sciolte.
- I numeri si intendono su barretta.
- Per lettere e numeri singoli aumento del 20%
- Negli ordini citare sempre l'altezza delle lettere a corpo semplice (a-c-m-r).
- Le lettere maiuscole hanno un'altezza doppia delle lettere minuscole e vengono conteggiate allo stesso prezzo delle lettere minuscole.
- Punteggiatura gratuita fino al mm 40
- L'altezza delle date indica sempre il numero con asta compresa.

- The numbers can be requested: on underscore - incorporated - single.
- The numbers are to be meant on underscore if not differently specified at the order.
- For single letters and numbers: increase 20%.
- In the orders always indicate the height of the lower-case letters in simple type size (a-c-m, etc...).
- Capital letters are double of small letters; they have the same price.
- Free punctuation up to mm 40
- The height of the dates are always indicated number included underscore.

A B C D E F G a b c d e f g h i
H I J K L M N j k l m n o p q r
O P Q R S T U s t u v w x z
V W X Y Z 1 2 3 4 5 6 7 8 9 0 ☆ †



SINUOSO COME LE DUNE
DI UN GRANDE DESERTO



ART. 6117	Lettere/Numeri	↓ mm 15	spessore mm 6
ART. 6122	Lettere/Numeri	↓ mm 20	spessore mm 6
ART. 6127	Lettere/Numeri	↓ mm 25	spessore mm 6
ART. 6132	Lettere/Numeri	↓ mm 30	spessore mm 6
ART. 6142	Lettere/Numeri	↓ mm 40	spessore mm 6
ART. 6152	Lettere/Numeri	↓ mm 50	spessore mm 6

Finitura			
SHADOW	+ 20%	RIFLESSI	+ 20%
YELLOW	+ 20%	PATINA SCURA	+ 20%
BIANCO	+ 10%	ASTER	+ 60%
ORO	+ 60%	OTIPRINT	+ 60%

Le date possono essere richieste:

- A corpo unico distanziate con punto
- Sciolte (aumento 20%)
- Non c'è maiuscola, le lettere hanno tutte la stessa altezza
- Non è possibile richiederlo compresso o allargato

Dates can be ordered:

- A a unique piece divided by a point
- Loose (increase by 20%)
- There is no capital letter, letters have all the same height
- It's not possible request it compressed or expanded



- Le date possono essere: incorporate - appoggiate - sciolte.
- I numeri si intendono su barretta
- Per lettere e numeri singoli aumento del 20%.
- Negli ordini citare sempre l'altezza delle lettere a corpo semplice (a-c-m-r).
- Le lettere maiuscole hanno un'altezza doppia delle lettere minuscole e vengono conteggiate allo stesso prezzo delle lettere minuscole.
- Punteggiatura gratuita fino a mm 40.
- L'altezza delle date indica sempre il numero con asta compresa.
- The numbers can be requested: on underscore - incorporated - single.
- The numbers are to be meant on underscore if not differently specified at the order.
- For single letters and numbers: increase 20%.
- In the orders always indicate the height of the lower-case letters in simple type size (a-c-m, etc...).
- Capital letters are double of small letters; they have the same price.
- Free punctuation up to mm 40
- The height of the dates are always indicated number included underscore.

ART. 6223	Lettere/Numeri	↓ mm 20	spessore mm 6
ART. 6228	Lettere/Numeri	↓ mm 25	spessore mm 6
ART. 6233	Lettere/Numeri	↓ mm 30	spessore mm 6
ART. 6243	Lettere/Numeri	↓ mm 40	spessore mm 6

Finitura			
SHADOW	+ 20%	RIFLESSI	+ 20%
YELLOW	+ 20%	PATINA SCURA	+ 20%
BIANCO	+ 10%	ASTER	+ 60%
ORO	+ 60%	OTIPRINT	+ 60%

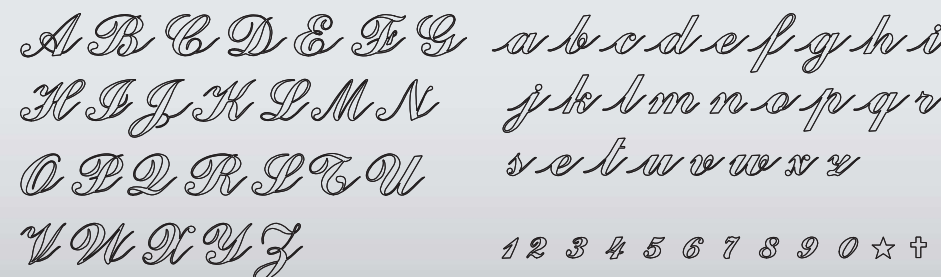

Vezzani
Vezzani
12 10 2006

Il corsivo PLAIN può essere richiesto: SOLO STANDARD

Plain can be ordered: ONLY STANDARD

- Le date possono essere: incorporate - appoggiate - sciolte (con aumento del 20%)

ART. 6116	Lettere/Numeri	↓ mm 15	spessore mm 3
ART. 6121	Lettere/Numeri	↓ mm 20	spessore mm 3
ART. 6126	Lettere/Numeri	↓ mm 25	spessore mm 3
ART. 6131	Lettere/Numeri	↓ mm 30	spessore mm 3
ART. 6141	Lettere/Numeri	↓ mm 40	spessore mm 3
ART. 6151	Lettere/Numeri	↓ mm 50	spessore mm 3
ART. 6161	Lettere/Numeri	↓ mm 60	spessore mm 3
ART. 6181	Lettere/Numeri	↓ mm 80	spessore mm 3
ART. 6195	Lettere/Numeri	↓ mm 100	spessore mm 3

Finitura			
SHADOW	+ 20%	RIFLESSI	+ 20%
YELLOW	+ 20%	PATINA SCURA	+ 20%
BIANCO	+ 10%	ASTER	+ 60%
ORO	+ 60%	OTIPRINT	+ 60%

A B C D E F G H I a b c d e f g h i j k l m
J K L M N O P Q R n o p q r s t u v w x y
S T U V W X Y 1 2 3 4 5 6 7 8 9 0 + ☆ ▲ Ω

Punteggiatura gratuita fino a mm 50

Lettere e Numeri sciolti: aumento del 20%

- È possibile richiedere il carattere Corsivo Plain di qualsiasi misura, previo preventivo.
- I numeri sono da intendersi su barretta se non diversamente specificato al momento dell'ordine.
- Negli ordini citare sempre l'altezza delle lettere minuscole a corpo semplice (a-c-m-etc...)
- Le lettere maiuscole hanno un'altezza superiore alle lettere minuscole del 40% circa e vengono conteggiate allo stesso prezzo delle lettere minuscole.
- L'altezza delle date indica sempre il numero con asta compresa.

Free punctuation up to 50 mm

Loose letters and numbers: 20% increase

- It is possible to ask for the font Plain italics in any size, after a price estimate
- The numbers are to be meant on underscore if not differently specified at the order
- In the orders always indicate the height of the lower-case letters in simple type size (a-c-m-, etc...)
- The upper-case letters are higher by about 40% than the lower-case letters, and are counted in the same way as the lower-case letters
- The height of the dates are always indicated number included underscore.

ANTARES

ART. 6115	Lettere/Numeri	↓ mm 15	spessore mm 2,5
ART. 6120	Lettere/Numeri	↓ mm 20	spessore mm 4
ART. 6125	Lettere/Numeri	↓ mm 25	spessore mm 4
ART. 6130	Lettere/Numeri	↓ mm 30	spessore mm 4
ART. 6140	Lettere/Numeri	↓ mm 40	spessore mm 4
ART. 6150	Lettere/Numeri	↓ mm 50	spessore mm 4
ART. 6160	Lettere/Numeri	↓ mm 60	spessore mm 4
ART. 6180	Lettere/Numeri	↓ mm 80	spessore mm 4
ART. 6191	Lettere/Numeri	↓ mm 100	spessore mm 4
ART. 6192	Lettere/Numeri	↓ mm 120	spessore mm 4
ART. 6193	Lettere/Numeri	↓ mm 150	spessore mm 4
ART. 6194	Lettere/Numeri	↓ mm 200	spessore mm 4

Finitura

SHADOW	+ 20%	RIFLESSI	+ 20%
YELLOW	+ 20%	PATINA SCURA	+ 20%
BIANCO	+ 10%	ASTER	+ 60%
ORO	+ 60%	OTIPRINT	+ 60%

Il carattere ANTARES può essere richiesto: SOLO STANDARD

ANTARES can be ordered: ONLY STANDARD

- È possibile richiedere il carattere Antares di qualsiasi misura previo preventivo.
- I numeri si intendono su barretta.
- Per lettere e numeri singoli aumento del 20%.
- It is possible to ask for the font Antares in upon estimate.
- The numbers are to be meant on underscore if not differently specified at the order.
- For single letters and numbers: increase 20%.

A B C D E F G H I J K L M
 N O P Q R S T U V W X Y
 1 2 3 4 5 6 7 8 9 0 + ☆ ▲ Ω

Corsivo Millennium

IL CORSIVO MILLENNIUM PUÒ ESSERE RICHIESTO:

COMPRESSO

Millennium

STANDARD

Millennium

ALLARGATO

Millennium

LE DATE POSSONO ESSERE RICHIESTE:

INCORPORATE NELL'ASTA

m. 10 12 2003

APPOGGIATE NELL'ASTA

m. 10 12 2003

SE AL MOMENTO DELL'ORDINE NON VIENE EFFETTUATA ALCUNA SPECIFICAZIONE, IL CORSIVO VIENE PRODOTTO AUTOMATICAMENTE STANDARD E CON DATE INCORPORATE NELL'ASTA.

ART. 6235 Lettere/Numeri ↓ mm 12 spessore mm 3

ART. 6216 Lettere/Numeri ↓ mm 15 spessore mm 3

ART. 6221 Lettere/Numeri ↓ mm 20 spessore mm 4

ART. 6226 Lettere/Numeri ↓ mm 25 spessore mm 4

ART. 6231 Lettere/Numeri ↓ mm 30 spessore mm 4

ART. 6241 Lettere/Numeri ↓ mm 40 spessore mm 4

ART. 6251 Lettere/Numeri ↓ mm 50 spessore mm 4

ART. 6261 Lettere/Numeri ↓ mm 60 spessore mm 4

ART. 6281 Lettere/Numeri ↓ mm 80 spessore mm 4

ART. 6292 Lettere/Numeri ↓ mm 100 spessore mm 4

Finitura

SHADOW	+ 20%	RIFLESSI	+ 20%
YELLOW	+ 20%	PATINA SCURA	+ 20%
BIANCO	+ 10%	ASTER	+ 60%
ORO	+ 60%	OTIPRINT	+ 60%

A B C D E F G H I a b c d e f g h i
 J K L M N O P j k l m n o p q r
 Q R S T U V W s e t u v w x z
 X Y Z 1 2 3 4 5 6 7 8 9 0 † ☆ ▲ Ω

Punteggiatura gratuita fino al mm 50

Doratura: aumento del 60%

Lettere e Numeri sciolti: aumento del 20%

- È possibile richiedere il carattere Corsivo Millennium di qualsiasi misura, previo preventivo.
- I numeri sono da intendersi su barretta se non diversamente specificato al momento dell'ordine.
- Negli ordini citare sempre l'altezza delle lettere minuscole a corpo semplice (a-c-m-etc...).
- Le lettere maiuscole hanno un'altezza superiore alle lettere minuscole del 140% circa e vengono conteggiate allo stesso prezzo delle lettere minuscole.
- L'altezza delle date indica sempre il numero con asta compresa.
- Per ART. 6235 non si possono richiedere numeri sciolti e le date sono solo incorporate.

Free punctuation up to 50 mm

Gilding: 60% increase

Loose letters and numbers: 20% increase

- It is possible to ask for the font Millennium italics in any size, after a price estimate.
- The numbers are to be meant on underscore if not differently specified at the order.
- In the orders always indicate the height of the lower-case letters in simple type size (a-c-m-, etc...).
- The upper-case letters are higher by about 140% than the lower-case letters, and are counted in the same way as the lower-case letters.
- The height of the dates are always indicated number included underscore.
- For ART. 6235 loose numbers cannot be required and date are only incorporated.

NOVITÀ

Millennium
Corsivo

ART. 6235MO	Lettere/Numeri	↓ mm 12	spessore mm 3
ART. 6216MO	Lettere/Numeri	↓ mm 15	spessore mm 3
ART. 6221MO	Lettere/Numeri	↓ mm 20	spessore mm 4
ART. 6226MO	Lettere/Numeri	↓ mm 25	spessore mm 4
ART. 6231MO	Lettere/Numeri	↓ mm 30	spessore mm 4
ART. 6241MO	Lettere/Numeri	↓ mm 40	spessore mm 4
ART. 6251MO	Lettere/Numeri	↓ mm 50	spessore mm 4
ART. 6261MO	Lettere/Numeri	↓ mm 60	spessore mm 4
ART. 6281MO	Lettere/Numeri	↓ mm 80	spessore mm 4
ART. 6292MO	Lettere/Numeri	↓ mm 100	spessore mm 4

NOVITÀ

Millennium
Corsivo

ART. 6235DU	Lettere/Numeri	↓ mm 12	spessore mm 3
ART. 6216DU	Lettere/Numeri	↓ mm 15	spessore mm 3
ART. 6221DU	Lettere/Numeri	↓ mm 20	spessore mm 4
ART. 6226DU	Lettere/Numeri	↓ mm 25	spessore mm 4
ART. 6231DU	Lettere/Numeri	↓ mm 30	spessore mm 4
ART. 6241DU	Lettere/Numeri	↓ mm 40	spessore mm 4
ART. 6251DU	Lettere/Numeri	↓ mm 50	spessore mm 4
ART. 6261DU	Lettere/Numeri	↓ mm 60	spessore mm 4
ART. 6281DU	Lettere/Numeri	↓ mm 80	spessore mm 4
ART. 6292DU	Lettere/Numeri	↓ mm 100	spessore mm 4

A B C D E F G H I a b c d e f g h i
 J K L M N O P j k l m n o p q r
 Q R S T U V W s e t u v w x z
 Y Z 1 2 3 4 5 6 7 8 9 0 † ☆ ▲ Ω

Punteggiatura gratuita fino al mm 50

Doratura: aumento del 60%

Lettere e Numeri sciolti: aumento del 20%

- È possibile richiedere il carattere Corsivo Millennium di qualsiasi misura, previo preventivo.
- I numeri sono da intendersi su barretta se non diversamente specificato al momento dell'ordine.
- Negli ordini citare sempre l'altezza delle lettere minuscole a corpo semplice (a-c-m-etc...).
- Le lettere maiuscole hanno un'altezza superiore alle lettere minuscole del 140% circa e vengono conteggiate allo stesso prezzo delle lettere minuscole.
- L'altezza delle date indica sempre il numero con asta compresa.
- Per ART. 6235DU e 6235MO non si possono richiedere numeri sciolti e le date sono solo incorporate.

Free punctuation up to 50 mm

Gilding: 60% increase

Loose letters and numbers: 20% increase

- It is possible to ask for the font Millennium italics in any size, after a price estimate.
- The numbers are to be meant on underscore if not differently specified at the order.
- In the orders always indicate the height of the lower-case letters in simple type size (a-c-m-, etc...).
- The upper-case letters are higher by about 140% than the lower-case letters, and are counted in the same way as the lower-case letters.
- The height of the dates are always indicated number included underscore.
- For ART. 6235DU and 6235MO loose numbers cannot be required and date are only incorporated

Corsivo Millennium

A B C D E F G H a b c d e f g h i
I J K L M N O P j k l m n o p q r
Q R S T U V W s e t u v w x z
X Y Z 1 2 3 4 5 6 7 8 9 0 † ☆ ▲ Ω

FINITURA BOTTICINO

ART. 6235BO	Lettere/Numeri	↓ mm 12	spessore mm 3
ART. 6216BO	Lettere/Numeri	↓ mm 15	spessore mm 3
ART. 6221BO	Lettere/Numeri	↓ mm 20	spessore mm 4
ART. 6226BO	Lettere/Numeri	↓ mm 25	spessore mm 4
ART. 6231BO	Lettere/Numeri	↓ mm 30	spessore mm 4
ART. 6241BO	Lettere/Numeri	↓ mm 40	spessore mm 4
ART. 6251BO	Lettere/Numeri	↓ mm 50	spessore mm 4
ART. 6261BO	Lettere/Numeri	↓ mm 60	spessore mm 4
ART. 6281BO	Lettere/Numeri	↓ mm 80	spessore mm 4
ART. 6292BO	Lettere/Numeri	↓ mm 100	spessore mm 4

FINITURA CARRARA

ART. 6235CA	Lettere/Numeri	↓ mm 12	spessore mm 3
ART. 6216CA	Lettere/Numeri	↓ mm 15	spessore mm 3
ART. 6221CA	Lettere/Numeri	↓ mm 20	spessore mm 4
ART. 6226CA	Lettere/Numeri	↓ mm 25	spessore mm 4
ART. 6231CA	Lettere/Numeri	↓ mm 30	spessore mm 4
ART. 6241CA	Lettere/Numeri	↓ mm 40	spessore mm 4
ART. 6251CA	Lettere/Numeri	↓ mm 50	spessore mm 4
ART. 6261CA	Lettere/Numeri	↓ mm 60	spessore mm 4
ART. 6281CA	Lettere/Numeri	↓ mm 80	spessore mm 4
ART. 6292CA	Lettere/Numeri	↓ mm 100	spessore mm 4

IL CORSIVO MILLENNIUM PUO' ESSERE RICHiesto:

COMPRESSO
Millennium

STANDARD
Millennium

ALLARGATO
Millennium

LE DATE POSSONO ESSERE RICHieste:

INCORPORATE NELL'ASTA
m. 10 12 2003

APPOGGIATE NELL'ASTA
m. 10 12 2003

SE AL MOMENTO DELL'ORDINE NON VIENE EFFETTUATA ALCUNA SPECIFICAZIONE, IL CORSIVO VIENE PRODOTTO AUTOMATICAMENTE STANDARD E CON DATE INCORPORATE NELL'ASTA.

Punteggiatura gratuita fino al mm 50
 Lettere e Numeri sciolti: aumento del 20%

- È possibile richiedere il carattere Corsivo Millennium di qualsiasi misura, previo preventivo.
- I numeri sono da intendersi su barretta se non diversamente specificato al momento dell'ordine.
- Negli ordini citare sempre l'altezza delle lettere minuscole a corpo semplice (a-c-m-etc...).
- Le lettere maiuscole hanno un'altezza superiore alle lettere minuscole del 140% circa e vengono conteggiate allo stesso prezzo delle lettere minuscole.
- L'altezza delle date indica sempre il numero con asta compresa.
- Per ART. 6235BO e 6235CA non si possono richiedere numeri sciolti e le date sono solo incorporate.

Free punctuation up to 50 mm
 Loose letters and numbers: 20% increase

- It is possible to ask for the font Millennium italics in any size, after a price estimate
- The numbers are to be meant on underscore if not differently specified at the order
- In the orders always indicate the height of the lower-case letters in simple type size (a-c-m-, etc...).
- The upper-case letters are higher by about 140% than the lower-case letters, and are counted in the same way as the lower-case letters.
- The height of the dates are always indicated number included underscore.
- For ART. 6235BO and 6235CA loose numbers cannot be required and date are only incorporated

Carattere Digivi

A B C D E F G a b c d e f g h i
 H I J K L M j k l m n o p q r
 X O P Q R S T s e t u u u x z
 U V W X Y Z 1 2 3 4 5 6 7 8 9 0 † ☆

ART. 6217	Lettere/Numeri	↓ mm 15	spessore mm 3
ART. 6222	Lettere/Numeri	↓ mm 20	spessore mm 3
ART. 6227	Lettere/Numeri	↓ mm 25	spessore mm 3
ART. 6232	Lettere/Numeri	↓ mm 30	spessore mm 3
ART. 6242	Lettere/Numeri	↓ mm 40	spessore mm 3
ART. 6252	Lettere/Numeri	↓ mm 50	spessore mm 3
ART. 6262	Lettere/Numeri	↓ mm 60	spessore mm 3
ART. 6282	Lettere/Numeri	↓ mm 80	spessore mm 3
ART. 6293	Lettere/Numeri	↓ mm 100	spessore mm 3

Finitura			
SHADOW	+ 20%	RIFLESSI	+ 20%
YELLOW	+ 20%	PATINA SCURA	+ 20%
BIANCO	+ 10%	ASTER	+ 60%
ORO	+ 60%	OTIPRINT	+ 60%

- Punteggiatura gratuita fino al mm 50
 Lettere e Numeri sciolti: aumento del 20%
- È possibile richiedere il carattere Corsivo Digivi di qualsiasi misura, previo preventivo.
 - Le date possono essere: incorporate - appoggiate - sciolte.
 - I numeri sono da intendersi su barretta se non diversamente specificato al momento dell'ordine.
 - Negli ordini citare sempre l'altezza delle lettere minuscole a corpo semplice (a-c-m-etc..)
 - Le lettere maiuscole hanno un'altezza superiore alle lettere minuscole del 100% circa e vengono conteggiate allo stesso prezzo delle lettere minuscole.
 - L'altezza delle date indica sempre il numero con asta compresa.

IL CORSIVO DIGIVI PUÒ ESSERE RICHIESTO:



- Free punctuation up to 50 mm
 Loose letters and numbers: 20% increase
- It is possible to ask for the font Digivi italics in any size, after a price estimate
 - The numbers can be requested: on underscore - incorporated - single.
 - The numbers are to be meant on underscore if not differently specified at the order
 - In the orders always indicate the height of the lower-case letters in simple type size (a-c-m-, etc..)
 - The upper-case letters are higher by about 140% than the lower-case letters, and are counted in the same way as the lower-case letters.
 - The height of the dates are always indicated number included underscore.

Corsivo Smart

- Le date possono essere: incorporate - appoggiate - sciolte.
- Date con numeri sciolti = aumento del 20%
- Punteggiatura gratuita fino al mm 50
- Negli ordini citare sempre l'altezza delle lettere minuscole a corpo semplice (a-c-m-...).
- Le lettere maiuscole hanno un'altezza superiore del 100% circa e vengono conteggiate come le minuscole
- L'altezza delle date indica sempre il numero con asta compresa.

- The numbers can be requested: on underscore - incorporated - single.
- Free punctuation up to 50 mm.
- Dates with loose numbers: 20% increase
- In the orders always indicate the height of the lower-case letters in simple type size /a-c-m-, etc..)
- The upper case letters are higher by about 100% than the lower-case letters, and are counted in the same way as the lower case letters.
- The height of the dates are always indicated number included underscore.

ART. 6415	Lettere/Numeri	↓ mm 15	spessore mm 2,5
ART. 6420	Lettere/Numeri	↓ mm 20	spessore mm 2,5
ART. 6425	Lettere/Numeri	↓ mm 25	spessore mm 2,5
ART. 6430	Lettere/Numeri	↓ mm 30	spessore mm 2,5
ART. 6440	Lettere/Numeri	↓ mm 40	spessore mm 2,5
ART. 6450	Lettere/Numeri	↓ mm 50	spessore mm 2,5
ART. 6460	Lettere/Numeri	↓ mm 60	spessore mm 2,5
ART. 6480	Lettere/Numeri	↓ mm 80	spessore mm 2,5
ART. 6491	Lettere/Numeri	↓ mm 100	spessore mm 2,5

Finitura			
SHADOW	+ 20%	RIFLESSI	+ 20%
YELLOW	+ 20%	PATINA SCURA	+ 20%
BIANCO	+ 10%	ASTER	+ 60%
ORO	+ 60%	OTIPRINT	+ 60%

A B C D E F G a b c d e f g h i
 H I J K L M N j k l m n o p q r
 O P Q R S T U s e t u v u u x x
 U V W X Y Z 1 2 3 4 5 6 7 8 9 0 ☆ † Ω Δ

Verrani

Verrani

ART. 6118	Lettere/Numeri	↓ mm 15
ART. 6123	Lettere/Numeri	↓ mm 20
ART. 6128	Lettere/Numeri	↓ mm 25
ART. 6133	Lettere/Numeri	↓ mm 30
ART. 6143	Lettere/Numeri	↓ mm 40
ART. 6153	Lettere/Numeri	↓ mm 50
ART. 6163	Lettere/Numeri	↓ mm 60
ART. 6183	Lettere/Numeri	↓ mm 80
ART. 6196	Lettere/Numeri	↓ mm 100

Spessore mm 4

ROL ROSSO LUCIDO	
ROO ROSSO OPACO	
VEL VERDE LUCIDO	TOL TORTORA LUCIDO
VEO VERDE OPACO	TOO TORTORA OPACO
BLL BLU LUCIDO	BEL BEIGE LUCIDO
BLO BLU OPACO	BEO BEIGE OPACO
AZL AZZURRO LUCIDO	BIL BIANCO LUCIDO
AZO AZZURRO OPACO	BIO BIANCO OPACO
VIL VIOLA LUCIDO	STL SATÈN LUCIDO
VIO VIOLA OPACO	STO SATÈN OPACO

Punteggiatura gratuita fino al mm 50

Lettere e Numeri sciolti: aumento del 20%

- È possibile richiedere il carattere Corsivo Reflex1 - Reflex2 di qualsiasi altra misura, previo preventivo.
- I numeri sono da intendersi su barretta.
- Negli ordini citare sempre l'altezza delle lettere minuscole a corpo semplice (a-c-m-etc...).
- Le lettere maiuscole hanno un'altezza superiore alle lettere minuscole del 100% circa e vengono conteggiate allo stesso prezzo delle lettere minuscole.
- L'altezza delle date indica sempre il numero con asta compresa.
- Non è possibile richiederlo compresso o allargato.

Free punctuation up to 50 mm

Loose letters and numbers: 20% increase

- It is possible to ask for the font Corsivo Reflex1 - Reflex2 italics in any size, after a price estimate
- The numbers are to be meant on underscore if not differently specified at the order
- In the orders always indicate the height of the lower-case letters in simple type size (a-c-m-, etc...)
- The upper-case letters are higher by about 100% than the lower-case letters, and are counted in the same way as the lower-case letters.
- The height of the dates are always indicated number included underscore.
- It's not possible request it compressed or expanded.

Per ordinazioni aggiungere al codice articolo la sigla corrispondente alla colorazione scelta,
To place orders add to the article code the letter corresponding the selected colouring.

ART. 6119	Lettere/Numeri	↓ mm 15
ART. 6124	Lettere/Numeri	↓ mm 20
ART. 6129	Lettere/Numeri	↓ mm 25
ART. 6134	Lettere/Numeri	↓ mm 30
ART. 6144	Lettere/Numeri	↓ mm 40
ART. 6154	Lettere/Numeri	↓ mm 50
ART. 6164	Lettere/Numeri	↓ mm 60
ART. 6184	Lettere/Numeri	↓ mm 80
ART. 6197	Lettere/Numeri	↓ mm 100

Spessore mm 4

ROL ROSSO LUCIDO	
ROO ROSSO OPACO	
VEL VERDE LUCIDO	TOL TORTORA LUCIDO
VEO VERDE OPACO	TOO TORTORA OPACO
BLL BLU LUCIDO	BEL BEIGE LUCIDO
BLO BLU OPACO	BEO BEIGE OPACO
AZL AZZURRO LUCIDO	BIL BIANCO LUCIDO
AZO AZZURRO OPACO	BIO BIANCO OPACO
VIL VIOLA LUCIDO	STL SATÈN LUCIDO
VIO VIOLA OPACO	STO SATÈN OPACO

Punteggiatura gratuita fino al mm 50

Lettere e Numeri sciolti: aumento del 20%

- È possibile richiedere il carattere Corsivo Reflex1 - Reflex2 di qualsiasi altra misura, previo preventivo.
- I numeri sono da intendersi su barretta.
- Negli ordini citare sempre l'altezza delle lettere minuscole a corpo semplice (a-c-m-etc...).
- Le lettere maiuscole hanno un'altezza superiore alle lettere minuscole del 100% circa e vengono conteggiate allo stesso prezzo delle lettere minuscole.
- L'altezza delle date indica sempre il numero con asta compresa.
- Non è possibile richiederlo compresso o allargato.

Free punctuation up to 50 mm

Loose letters and numbers: 20% increase

- It is possible to ask for the font Corsivo Reflex1 - Reflex2 italics in any size, after a price estimate
- The numbers are to be meant on underscore if not differently specified at the order
- In the orders always indicate the height of the lower-case letters in simple type size (a-c-m-, etc...)
- The upper-case letters are higher by about 100% than the lower-case letters, and are counted in the same way as the lower-case letters.
- The height of the dates are always indicated number included underscore.
- It's not possible request it compressed or expanded.

Per ordinazioni aggiungere al codice articolo la sigla corrispondente alla colorazione scelta,
To place orders add to the article code the letter corresponding the selected colouring.



ROL
ROSSO LUCIDO
ROO
ROSSO OPACO



VEL
VERDE LUCIDO
VEO
VERDE OPACO



BLL
BLU LUCIDO
BLO
BLU OPACO



AZL
AZZURRO LUCIDO
AZO
AZZURRO OPACO



VIL
VIOLA LUCIDO
VIO
VIOLA OPACO



TOL
TORTORA LUCIDO
TOO
TORTORA OPACO



BEL
BEIGE LUCIDO
BEO
BEIGE OPACO



BIL
BIANCO LUCIDO
BIO
BIANCO OPACO



STL
SATÈN LUCIDO
STO
SATÈN OPACO

ART. 6111	Lettere/Numeri	↓ mm 15
ART. 6112	Lettere/Numeri	↓ mm 20
ART. 6113	Lettere/Numeri	↓ mm 25
ART. 6114	Lettere/Numeri	↓ mm 30
ART. 6145	Lettere/Numeri	↓ mm 40
ART. 6155	Lettere/Numeri	↓ mm 50
ART. 6165	Lettere/Numeri	↓ mm 60
ART. 6185	Lettere/Numeri	↓ mm 80
ART. 6198	Lettere/Numeri	↓ mm 100

Spessore mm 4

Le date possono essere richieste

- A corpo unico distanziate con punto
- Sciolte (aumento 20%)
- Non c'è maiuscola, le lettere hanno tutte la stessa altezza
- Non è possibile richiederlo compresso o allargato.

Dates can be ordered:

- As a unique piece divided by a point
- Loose (increase by 20%)
- There is no capital letter, letters have all the same height
- It's not possible request it compressed or expanded.



ROL
ROSSO LUCIDO



VEL
VERDE LUCIDO



BLL
BLU LUCIDO



AZL
AZZURRO LUCIDO



VIL
VIOLA LUCIDO



TOL
TORTORA LUCIDO



BEL
BEIGE LUCIDO



BIL
BIANCO LUCIDO



STL
SATÈN LUCIDO



ROO
ROSSO OPACO



VEO
VERDE OPACO



BLO
BLU OPACO



AZO
AZZURRO OPACO



VIO
VIOLA OPACO



TOO
TORTORA OPACO



BEO
BEIGE OPACO



BIO
BIANCO OPACO



STO
SATÈN OPACO

ART. 6526	Lettere/Numeri/Stella/Croce	↓ mm 25
ART. 6531	Lettere/Numeri/Stella/Croce	↓ mm 30
ART. 6541	Lettere/Numeri	↓ mm 40
ART. 6551	Lettere/Numeri/Stella/Croce	↓ mm 50
ART. 6596	Trattino	per mm 25-30-40-50
ART. 6597	Virgola	per mm 25-30-40-50
ART. 6598	Accento	per mm 25-30-40-50
ART. 6599	Punto	per mm 25-30-40-50

Si possono richiedere pergamene personalizzate con colorazioni "Riflessi"

Per ordinazioni aggiungere al codice articolo la sigla corrispondente alla colorazione scelta.
To place orders add to the article code the letter corresponding the selected colouring.

Per ordinazioni aggiungere al codice articolo la sigla corrispondente alla colorazione scelta.
To place orders add to the article code the letter corresponding the selected colouring.



Grazie all'esperienza, le competenze e la passione nella lavorazione della porcellana, è nato **ETERNITY**, un progetto sviluppato per creare un corsivo unico e inalterabile nel tempo.

Uno strumento a disposizione della clientela, versatile, completamente personalizzabile, facile da utilizzare, ma soprattutto eterno.

Eternità

Sistema produttivo che lo rende insolubile e inalterabile agli agenti atmosferici e qualsiasi intemperie. Eternity è un prodotto che permane nel tempo garantendo un aspetto sempre integro e attuale.

Praticità

Grazie alla sua particolare composizione in un unico elemento, potrà essere applicato in modo semplice e pratico, facilitando al massimo le operazioni di fissaggio.

Personalizzazione

Potrà essere personalizzato, oltreché con dati e generalità uniche richieste dal cliente, anche con tutte le marmorizzazioni disponibili a catalogo. Sarà quindi possibile ottenere soluzioni uniche che esalteranno al meglio il design del prodotto.



Eternity

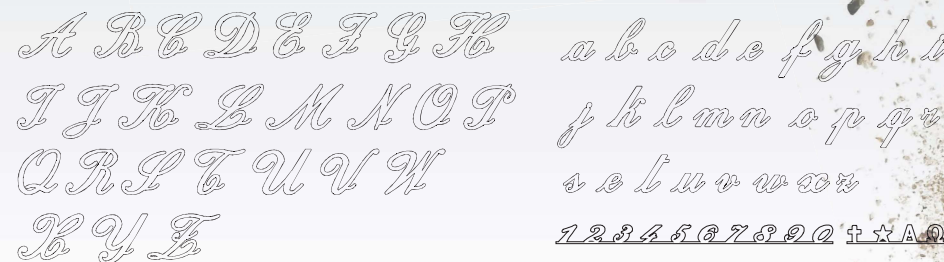

AZZURRO
 ART. 5958AZL ↓ mm 20 spessore mm 7
 ART. 5959AZL ↓ mm 25 spessore mm 7
 ART. 5962AZL ↓ mm 30 spessore mm 7
 ART. 5963AZL ↓ mm 40 spessore mm 7

BIANCO
 ART. 5958BIL ↓ mm 20 spessore mm 7
 ART. 5959BIL ↓ mm 25 spessore mm 7
 ART. 5962BIL ↓ mm 30 spessore mm 7
 ART. 5963BIL ↓ mm 40 spessore mm 7

BLU
 ART. 5958BLL ↓ mm 20 spessore mm 7
 ART. 5959BLL ↓ mm 25 spessore mm 7
 ART. 5962BLL ↓ mm 30 spessore mm 7
 ART. 5963BLL ↓ mm 40 spessore mm 7

VERDE
 ART. 5958VEL ↓ mm 20 spessore mm 7
 ART. 5959VEL ↓ mm 25 spessore mm 7
 ART. 5962VEL ↓ mm 30 spessore mm 7
 ART. 5963VEL ↓ mm 40 spessore mm 7

BEIGE
 ART. 5958BEL ↓ mm 20 spessore mm 7
 ART. 5959BEL ↓ mm 25 spessore mm 7
 ART. 5962BEL ↓ mm 30 spessore mm 7
 ART. 5963BEL ↓ mm 40 spessore mm 7

TORTORA
 ART. 5958TOL ↓ mm 20 spessore mm 7
 ART. 5959TOL ↓ mm 25 spessore mm 7
 ART. 5962TOL ↓ mm 30 spessore mm 7
 ART. 5963TOL ↓ mm 40 spessore mm 7

ROSSO
 ART. 5958ROL ↓ mm 20 spessore mm 7
 ART. 5959ROL ↓ mm 25 spessore mm 7
 ART. 5962ROL ↓ mm 30 spessore mm 7
 ART. 5963ROL ↓ mm 40 spessore mm 7

VIOLA
 ART. 5958VIL ↓ mm 20 spessore mm 7
 ART. 5959VIL ↓ mm 25 spessore mm 7
 ART. 5962VIL ↓ mm 30 spessore mm 7
 ART. 5963VIL ↓ mm 40 spessore mm 7

SATÈNE
 ART. 5958STL ↓ mm 20 spessore mm 7
 ART. 5959STL ↓ mm 25 spessore mm 7
 ART. 5962STL ↓ mm 30 spessore mm 7
 ART. 5963STL ↓ mm 40 spessore mm 7

- È possibile richiedere il carattere Eternity solo nelle misure sopra riportate.
- Non sono disponibili lettere e numeri sciolti.
- Le date sono da intendersi su barretta/appoggiate.
- Negli ordini citare sempre l'altezza delle lettere minuscole a corpo semplice (a-c-m-etc...)
- Le lettere maiuscole hanno un'altezza superiore alle lettere minuscole del 140% circa e vengono conteggiate allo stesso prezzo delle lettere minuscole.
- L'altezza delle date è da intendersi asta compresa.
- Non è possibile richiederlo compresso o allargato.

- It is possible to ask for the font Eternity only in these size.
- Non available loose letters and numbers.
- Dates are to be meant only on underscore.
- In the orders always indicate the height of the lower-case letters in simple type size (a-c-m-, etc...)
- The upper-case letters are higher by about 140% than the lower-case letters, and are counted in the same way as the lower-case letters.
- The height of the dates are always indicated number included underscore.
- It's not possible request it compressed or expanded.



ART. 90340
 † 31,5 ↔ 31,5 ✕ 14 cm
 Display in plexiglass
 8 scritte corsivi bronzo



ART. 90341
 † 31,5 ↔ 31,5 ✕ 14 cm
 Display in plexiglass
 7 scritte corsivi inox



ART. 90339
 † 31,5 ↔ 31,5 ✕ 14 cm
 Display in plexiglass neutro
 personalizzabile



ART. 90313
 † 42 ↔ 29,7 cm



ART. 90312
 † 42 ↔ 29,7 cm
 Display in cartone neutro
 personalizzabile



ART. 6270	Lettere/Numeri/Stella/Croce	↓ mm 48
ART. 6271	Lettere/Numeri/Stella/Croce	↓ mm 28
ART. 6274	Punto	↓ mm 28
ART. 6274-	Trattino	↓ mm 28
ART. 6274,	Virgola	↓ mm 28
ART. 6274'	Accento	↓ mm 28



MAIUSCOLA

MINUSCOLA
CENTRALE

MINUSCOLA
TERMINALE

Aaaa Bbbb Cccc Pppp Qqqq Rrrr

Dddd Eeee Ffff Llll Tttt Uuuu

Gggg Hhhh Kkkk Vvvv Wwww Xxxx

Tttt Jjjj Llll Yyyy Zzzz

Mmm Nnn Ooo

PER COMPOSIZIONI EPIGRAFI AUMENTO DEL 20%

ART. 6000	Lettere Maiuscole	↓ mm 60
ART. 6001	Minuscole centrali	↓ mm 30
ART. 6002	Minuscole terminali	↓ mm 30
ART. 10500	Barra guida per composizione corsivo	
ART. 90606	Confezione cianacrilato gr. 20	

1 2 3 4 5 6 7 8 9 0

n m * † - . ,

1 2 3 4 5 6 7 8 9 0

n m * † ,



f a

* 28. 10. 1693

18 5 3440

1997 n 2385

m 25. 4. 3548

PER COMPOSIZIONI EPIGRAFI AUMENTO DEL 20%

ART. 6003 Num./Stella/Croce /n/m sciolti ↓ 30 mm

ART. 6004 Num./Stella/Croce /n/m per barretta ↓ 30 mm

ART. 6020 Gambetta iniziale per lettera minuscola

ART. 6021 Punto/Trattino/Virgola/Accento per composizioni sciolte

PER COMPOSIZIONI EPIGRAFI AUMENTO DEL 20%

ART. 6022 Punto per composizioni su barrette

ART. 6023 Barretta cm 11

ART. 6024 Barretta cm 18

ART. 6025 Barretta cm 24

ART. 6026 Barretta cm 31

ISTRUZIONI di MONTAGGIO LETTERE SU BARRETTA



1. Allineare sulla guida la composizione spaziando le lettere di circa 1 cm, quindi mettere una goccia di Loctite su ogni lettera.



2. Serrare lettera per lettera premendo energicamente per qualche secondo.



3. A fine composizione provvedere ad un ultimo serraggio di sicurezza premendo l'intera scritta.



4. Dopo aver atteso il tempo necessario per l'indurimento, pochi secondi (vedi istruzioni Loctite), pulire la scritta dalle eccedenze di colla, facendo scorrere velocemente la scritta sulla carta.

5. Riporre infine la scritta sulla guida ed attendere qualche minuto prima di posizionarla in opera. Per un montaggio ottimale si consiglia di applicare almeno un perno nella prima e ultima lettera.



MATERIALE NECESSARIO PER LA COMPOSIZIONE:
BARRA GUIDA
CIANACRILATO
CARTA ASSORBENTE TIPO SCOTTEX



ART. 10500
Barra guida

ISTRUZIONI di MONTAGGIO NUMERI SU BARRETTA



1



2



3



4



5



6



7



ART. 90606
Confezione cianacrilato 20 gr



ART. 6071	Lettere Maiuscole	↓ mm 60
ART. 6072	Lettere Minuscole	↓ mm 30
ART. 6075	Numeri/n/m Stella/Croce	↓ mm 30
ART. 6073	Punto/Trattino/Virgola/Accento	
ART. 6074	Gambetta iniziale per lettera minuscola	

A B C D E

F G H K I

J L M N O

P Q R S T

U V W X Y

Z

1 2 3 4 5 6 7

8 9 0 ★ ✝ - · ;

PER COMPOSIZIONI EPIGRAFI AUMENTO DEL 20%

ART. 6320	Lettere/Numeri/Stella/Croce	↓ mm 20
ART. 6325	Lettere/Numeri/Stella/Croce	↓ mm 25
ART. 6330	Lettere/Numeri/Stella/Croce	↓ mm 30
ART. 6340	Lettere/Numeri/Stella/Croce	↓ mm 40
ART. 6350	Lettere/Numeri	↓ mm 50
ART. 6360	Lettere	↓ mm 60
ART. 6380	Lettere/Numeri	↓ mm 80
ART. 6312	Lettere/Numeri	↓ mm 120

PER COMPOSIZIONI EPIGRAFI AUMENTO DEL 20%

ART. 6396	Trattino	per mm 25-30-40-50-60-80
ART. 6397	Virgola	per mm 25-30-40-50-60-80
ART. 6398	Accento	per mm 25-30-40-50-60-80
ART. 6399	Punto	per mm 25-30-40-50-60-80

A B C D E F

ART. 6321	Lettere/Numeri/Stella/Croce	↓ mm 20
ART. 6326	Lettere/Numeri/Stella/Croce	↓ mm 25
ART. 6331	Lettere/Numeri/Stella/Croce	↓ mm 30
ART. 6341	Lettere/Numeri/Stella/Croce	↓ mm 40
ART. 6351	Lettere/Numeri	↓ mm 50
ART. 6361	Lettere	↓ mm 60
ART. 6381	Lettere/Numeri	↓ mm 80

ART. 6391	Trattino	per mm 25-30-40-50
ART. 6393	Virgola	per mm 25-30-40-50
ART. 6394	Accento	per mm 25-30-40-50
ART. 6395	Punto	per mm 25-30-40-50

L Q S 2 9 4 5 7

ART. 6320MO	Lettere/Numeri/Stella/Croce	↓ mm 20
ART. 6325MO	Lettere/Numeri/Stella/Croce	↓ mm 25
ART. 6330MO	Lettere/Numeri/Stella/Croce	↓ mm 30
ART. 6340MO	Lettere/Numeri/Stella/Croce	↓ mm 40
ART. 6350MO	Lettere/Numeri	↓ mm 50
ART. 6360MO	Lettere	↓ mm 60

ART. 6396MO	Trattino	per mm 25-30-40-50-60-80
ART. 6397MO	Virgola	per mm 25-30-40-50-60-80
ART. 6398MO	Accento	per mm 25-30-40-50-60-80
ART. 6399MO	Punto	per mm 25-30-40-50-60-80

NOVITÀ

CARATTERE **ROMANO OTIPRINT**

A B C

BIANCO

ART. 6320BI	Lettere/Numeri	↓ mm 20
ART. 6325BI	Lettere/Numeri	↓ mm 25
ART. 6330BI	Lettere/Numeri	↓ mm 30
ART. 6340BI	Lettere/Numeri	↓ mm 40
ART. 6350BI	Lettere/Numeri	↓ mm 50
ART. 6360BI	Lettere	↓ mm 60
ART. 6396BI	Trattino	↓ mm 20
ART. 6397BI	Virgola	↓ mm 20
ART. 6398BI	Accento	↓ mm 20
ART. 6399BI	Punto	↓ mm 20

A B C

CARRARA

ART. 6320CA	Lettere/Numeri	↓ mm 20
ART. 6325CA	Lettere/Numeri	↓ mm 25
ART. 6330CA	Lettere/Numeri	↓ mm 30
ART. 6340CA	Lettere/Numeri	↓ mm 40
ART. 6350CA	Lettere/Numeri	↓ mm 50
ART. 6360CA	Lettere	↓ mm 60
ART. 6396CA	Trattino	↓ mm 20
ART. 6397CA	Virgola	↓ mm 20
ART. 6398CA	Accento	↓ mm 20
ART. 6399CA	Punto	↓ mm 20

A B C

BOTTICINO

ART. 6320BO	Lettere/Numeri	↓ mm 20
ART. 6325BO	Lettere/Numeri	↓ mm 25
ART. 6330BO	Lettere/Numeri	↓ mm 30
ART. 6340BO	Lettere/Numeri	↓ mm 40
ART. 6350BO	Lettere/Numeri	↓ mm 50
ART. 6360BO	Lettere	↓ mm 60
ART. 6396BO	Trattino	↓ mm 20
ART. 6397BO	Virgola	↓ mm 20
ART. 6398BO	Accento	↓ mm 20
ART. 6399BO	Punto	↓ mm 20

PER COMPOSIZIONI EPIGRAFI AUMENTO DEL 20%

CARATTERE **ROMANO DUST**

L Q S 2 9 4 5 7

ART. 6320DU	Lettere/Numeri/Stella/Croce	↓ mm 20
ART. 6325DU	Lettere/Numeri/Stella/Croce	↓ mm 25
ART. 6330DU	Lettere/Numeri/Stella/Croce	↓ mm 30
ART. 6340DU	Lettere/Numeri/Stella/Croce	↓ mm 40
ART. 6350DU	Lettere/Numeri	↓ mm 50
ART. 6360DU	Lettere	↓ mm 60

ART. 6396DU	Trattino	per mm 25-30-40-50-60-80
ART. 6397DU	Virgola	per mm 25-30-40-50-60-80
ART. 6398DU	Accento	per mm 25-30-40-50-60-80
ART. 6399DU	Punto	per mm 25-30-40-50-60-80

NOVITÀ

CARATTERE **ROMANO ECONOMY**

A B C

ART. 6328	Lettere/Numeri/Stella/Croce	↓ mm 20
ART. 6329	Lettere/Numeri/Stella/Croce	↓ mm 25
ART. 6338	Lettere/Numeri/Stella/Croce	↓ mm 30
ART. 6348	Lettere/Numeri/Stella/Croce	↓ mm 40
ART. 6358	Lettere/Numeri	↓ mm 50

ART. 6386	Trattino	per mm 25-30-40-50
ART. 6387	Virgola	per mm 25-30-40-50
ART. 6388	Accento	per mm 25-30-40-50
ART. 6389	Punto	per mm 25-30-40-50

A B C D E

J L M N O

U V W X Y

1 2 3 4 5 6 7

F G H K I

P Q R S T

Z

8 9 0 ★ ✝ - · ;

La superficie di adesione deve essere perfettamente piana e levigata - marmo, granito, vetro, cristallo, ecc.
Questo fissaggio rende possibili rapide realizzazioni con la sicurezza di un adesivo resistente a temperatura da -30°C a +100°C

PER COMPOSIZIONI EPIGRAFI AUMENTO DEL 20%

ART. 6327	Lettere/Numeri/Stella/Croce	↓ mm 25
ART. 6332	Lettere/Numeri/Stella/Croce	↓ mm 30
ART. 6342	Lettere/Numeri	↓ mm 40
ART. 6352	Lettere/Numeri	↓ mm 50
ART. 6376	Trattino	per mm 25-30-40-50
ART. 6377	Virgola	per mm 25-30-40-50
ART. 6378	Accento	per mm 25-30-40-50
ART. 6379	Punto	per mm 25-30-40-50



1. Tracciare a matita la linea di posizionamento del carattere, oppure usare un righello.
2. Tracciare a matita la linea di posizionamento del carattere, oppure usare un righello.
3. Togliere la protezione in carta dell'adesivo, avendo cura di non toccarlo con le mani.
4. Posizionare la lettera allineandola al segno a matita. L'applicazione deve essere eseguita a temperatura ambiente.
5. Premere con forza per qualche secondo.



ART. 6325	Lettere/Numeri/Stella/Croce	↓ mm 25
ART. 6330	Lettere speciali/ Lettere/Numeri/Stella/Croce	↓ mm 30
ART. 6340	Lettere/Numeri	↓ mm 40
ART. 6350	Lettere speciali/ Lettere/Numeri/Stella/Croce	↓ mm 50
ART. 6396	Trattino	
ART. 6397	Virgola	
ART. 6398	Accento	
ART. 6399	Punto	



PER ORDINAZIONI CITARE IL NUMERO CORRISPONDENTE ALLA LETTERA SCELTA

ART. 6325	Lettere speciali/ Lettere/Numeri/Stella/Croce	↓ mm 25
ART. 6330	Lettere speciali/ Lettere/Numeri/Stella/Croce	↓ mm 30
ART. 6340	Lettere speciali/ Lettere/Numeri/Stella/Croce	↓ mm 40
ART. 6350	Lettere speciali/ Lettere/Numeri/Stella/Croce	↓ mm 50
ART. 6396	Trattino	
ART. 6397	Virgola	
ART. 6398	Accento	
ART. 6399	Punto	



PER ORDINAZIONI CITARE IL NUMERO CORRISPONDENTE ALLA LETTERA SCELTA

ART. 6325	Lettere/Numeri/Stella/Croce	↓ mm 25
ART. 6330	Lettere speciali/ Lettere/Numeri/Stella/Croce	↓ mm 30
ART. 6340	Lettere/Numeri	↓ mm 40
ART. 6350	Lettere speciali/ Lettere/Numeri/Stella/Croce	↓ mm 50
ART. 6396	Trattino	
ART. 6397	Virgola	
ART. 6398	Accento	
ART. 6399	Punto	

CARATTERE **STAMPATELLO**
SALDATO SU BARRETTA

NOVITÀ



ART. 6054	Lettere/Numeri/Stella/Croce	↓ mm 25
ART. 6055	Lettere/Numeri/Stella/Croce	↓ mm 30
ART. 6056	Lettere/Numeri/Stella/Croce	↓ mm 40
ART. 6057	Lettere/Numeri/Stella/Croce	↓ mm 50

A B C D E F
 G H I J K L
 M N O P Q R
 S T U V W
 X Y Z

a b c d e
 f g h i
 l m n o p
 q r s t u
 v w x y z

1 2 3 4 5 6 7 8 9 0

* † — • • •

mb

MAIUSCOLO	
PER COMPOSIZIONI EPIGRAFI AUMENTO DEL 20%	
ART. 6650	Lettere ↓ mm 50
MINUSCOLO	
PER COMPOSIZIONI EPIGRAFI AUMENTO DEL 20%	
ART. 6625	Lettere/Numeri/Stella/Croce ↓ mm 25
ART. 6635	Lettere/Numeri/Stella/Croce ↓ mm 35
ART. 6692	Trattino per mm 25
ART. 6693	Virgola per mm 25
ART. 6694	Accento per mm 25
ART. 6695	Punto per mm 25
ART. 6696	Trattino per mm 35
ART. 6697	Virgola per mm 35
ART. 6698	Accento per mm 35
ART. 6699	Punto per mm 35



PER COMPOSIZIONI EPIGRAFICHE AUMENTO DEL 20%

ART. 6825	Lettere/Numeri/Stella/Croce	↓ mm 25
ART. 6830	Lettere/Numeri/Stella/Croce	↓ mm 30
ART. 6840	Lettere/Numeri	↓ mm 40
ART. 6850	Lettere	↓ mm 50
ART. 6896	Trattino	per mm 25-30-40
ART. 6897	Virgola	per mm 25-30-40
ART. 6898	Accento	per mm 25-30-40
ART. 6899	Punto	per mm 25-30-40
ART. 6886	Trattino	per mm 50
ART. 6887	Virgola	per mm 50
ART. 6888	Accento	per mm 50
ART. 6889	Punto	per mm 50



A B C D E

F G H K I

J L M N O

P Q R S T

U V W X Y

Z

1 2 3 4 5 6 7

8 9 0 ★ † — … ’

PER COMPOSIZIONI EPIGRAFI AUMENTO DEL 20%

ART. 6526 Lettere/Numeri/Stella/Croce ↓ mm 25

ART. 6531 Lettere/Numeri/Stella/Croce ↓ mm 30

ART. 6541 Lettere/Numeri ↓ mm 40

ART. 6551 Lettere ↓ mm 50

ART. 6561 Lettere ↓ mm 60

ART. 6581 Lettere ↓ mm 80

ART. 6512 Lettere/Numeri/Stella/Croce ↓ mm 120

ART. 6596 Trattino per mm 25-30-40-50-60

ART. 6597 Virgola per mm 25-30-40-50-60

ART. 6598 Accento per mm 25-30-40-50-60

ART. 6599 Punto per mm 25-30-40-50-60

ART. 6591 Punto per mm 80

ART. 6592 Trattino per mm 120

ART. 6086 Accento per mm 50-60

ART. 6593 Virgola per mm 120

ART. 6594 Accento per mm 120

ART. 6595 Punto per mm 120

MM

A B C D E F G H
 I J L M N O P Q R S
 T U V W X Y Z
 1 2 3 4 5 6 7 8 9 0 ★ ✝ - , ;

ART. D6325	Lettere/Numeri/Stella/Croce	↓ mm 25
ART. D6330	Lettere/Numeri/Stella/Croce	↓ mm 30
ART. D6340	Lettere/Numeri	↓ mm 40
ART. D6350	Lettere/Numeri	↓ mm 50
ART. D6360	Lettere	↓ mm 60
ART. D6380	Lettere/Numeri	↓ mm 80
ART. D6396	Trattino	↓ mm 20
ART. D6397	Virgola	↓ mm 25
ART. D6398	Accento	↓ mm 30
ART. D6399	Punto	per mm 25-30-40-50

CONCORD DORATO

A b c

ART. 6010	Lettere	↓ mm 60
ART. 6011	Minuscole centrali	↓ mm 30
ART. 6012	Minuscole terminali	↓ mm 30
ART. 6013	Numero/Stella/Croce/n/m sciolti	
ART. 6014	Numero/Stella/Croce/n/m per barretta	
ART. 6040	Gambetta iniziale per lettere minuscole	
ART. 6041	Punteggiatura per composizioni sciolte	
ART. 6042	Punto per composizioni su barretta	
ART. 6043	Barretta	cm 11
ART. 6044	Barretta	cm 18
ART. 6045	Barretta	cm 24
ART. 6046	Barretta	cm 31

A B C D E F G
 H K I J L M N
 O P Q R S T U
 V W X Y Z
 1 2 3 4 5 6 7
 8 9 0 ★ † - , ;

ART. 5826	Lettere/Numeri/Stella/Croce	↓ mm 25
ART. 5831	Lettere/Numeri/Stella/Croce	↓ mm 30
ART. 5841	Lettere	↓ mm 40
ART. 5851	Lettere	↓ mm 50
ART. 5893	Trattino	per mm 25-30-40-50
ART. 5894	Virgola	per mm 25-30-40-50
ART. 5895	Punto	per mm 25-30-40-50



PAX
ART. 6087
↓ cm 5
ART. 6088
↓ cm 6
ART. 6089
↓ cm 8



ART. 6519
DELTA ↓ cm 4
ART. 6518
DELTA ↓ cm 6



INTERNATIONAL
ART. 6813 ↓ cm 3

INTERNATIONAL
ART. 6815 ↓ cm 5



ART. 6314
ROMANO ↓ cm 4

ART. 6316
ROMANO ↓ cm 6



FEDI
ART. 6432
↓ cm 2,5



DELTA ART. 6517
↓ cm 2,5
DELTA ART. 6513
↓ cm 3
DELTA ART. 6514
↓ cm 4
DELTA ART. 6515
↓ cm 5
DELTA ART. 6516
↓ cm 6



INTERNATIONAL
ART. 6819
↓ cm 5
ART. 6818
↓ cm 4
ART. 6817
↓ cm 3
ART. 6816
↓ cm 2,5



CON PERNO
ART. 6333
↓ cm 2,5
ART. 6334
↓ cm 3
ART. 6335
↓ cm 4
ART. 6336
↓ cm 5
ART. 6337
↓ cm 6



ADESIVA
ART. 6343
↓ cm 2,5
ART. 6344
↓ cm 3
ART. 6345
↓ cm 4
ART. 6346
↓ cm 5
ART. 6337
↓ cm 6



CON PERNO
ART. 6421
↓ cm 2,5
ART. 6422
↓ cm 3
ART. 6423
↓ cm 4
ART. 6424
↓ cm 5
ART. 6431
↓ cm 6

ADESIVA
ART. 6426
↓ cm 2,5
ART. 6427
↓ cm 3
ART. 6428
↓ cm 4
ART. 6429
↓ cm 5



ART. 31424 con adesivo



ART. 31423 con adesivo



ART. 31422 con adesivo



ART. 31421 con adesivo



CONCORD
ART. 6027 ↓ cm 6

CONCORD
ART. 6005 ↓ cm 6

CONCORD CENTRALE
ART. 6006 ↓ cm 3

CONCORD CENTRALE
ART. 6028 ↓ cm 3

CONCORD TERMINALE
ART. 6029 ↓ cm 3



PIPA SLAVA
ROMANO
ART. 6392



ART. 6520
PIPA SLAVA DELTA
ART. 6353
↓ cm 2,5
ART. 6354
↓ cm 4



ART. 6375



ART. 6373



ART. 6374



ART. 6521
TRATTINO DELTA

INTERS POUR CROIX



ART. 31450



ART. 31451



ART. 31454 con adesivo
ART. 31456 no adesivo



ART. 31455 con adesivo
ART. 31457 no adesivo



LIBRI E PERGAMENE



PISTOLA
ART. 90872

CARTUCCIA
ART. 90823

MISCELATORE STATICO
+ UGELLO
ART. 90870



SILICONE
ART. 90604 310 ml.



ACCESSORI VEZZANI SYSTEM

PISTOLA CARTUCCIA MISCELATORE STATICO UGELLO



Comporre la pistola alzando la levetta sulla destra ed inserendo il pezzo di completamento.



Inserire la doppia cartuccia nell'apposita pistola.



Bloccare la cartuccia, abbassando l'apposita chiusura.



Togliere il tappo e il feltrino all'estremità della cartuccia e conservarli.



Inserire il miscelatore statico ad incastro nella cartuccia.



Fare uscire la prima parte del composto e non usarla in modo da avere la sicurezza che quello che si utilizzerà sia giustamente miscelato.



Inserire l'ugello al miscelatore statico.



Introdurre l'ugello nel foro del marmo o granito ed erogare. Alla fine dell'erogazione rilasciare il grilletto ed alzare velocemente e con decisione la pistola per evitare che il componente faccia il filo.



A completamento del lavoro si toglie il miscelatore statico e il relativo ugello e si buttano. Poi si chiude la cartuccia con il feltrino e il tappo originario.

CARATTERISTICHE TECNICHE

- Resina epossidica bicomponente (50% resina - 50% catalizzatore/indurente)
- 20 minuti tempo di indurimento (indicativo secondo la temperatura)
- Scadenza: 1 anno
- Con una cartuccia si fanno in media 10 lapidi

VANTAGGI

- Notevole vantaggio di tempo nella applicazione
- Non bisogna fare pulizia dopo la posa delle lettere
- Nessuno spreco di materiale

ACCORGIMENTI UTILI

- Tenere a portata di mano uno straccetto per pulizia ugello
- Non esporre al sole perchè diventa più liquido
- Se tenuto in frigo fa meno filo



CORSIVO



STAMPATELLO



ROMANO



BASTONE

PERSONALIZZABILI - incisione inclusa nel prezzo



NOVITÀ

- ART. 38820 ↓ 7 ↔ 10 cm
- ART. 38821 ↓ 7,5 ↔ 15 cm
- ART. 38823 ↓ 10 ↔ 20 cm
- ART. 38824 ↓ 15 ↔ 30 cm
- ART. 38826 ↓ 20 ↔ 40 cm

incisione inclusa nel prezzo



PERGAMENA PERSONALIZZABILE CON INCISIONE

- ART. 38713 ↓ 7,5 ↔ 10 cm
- ART. 38736 ↓ 11,5 ↔ 15,5 cm
- ART. 38714 ↓ 15 ↔ 20 cm

SENZA INCISIONE

- ART. 38713L ↓ 7,5 ↔ 10 cm
- ART. 38736L ↓ 11,5 ↔ 15,5 cm
- ART. 38714L ↓ 15 ↔ 20 cm

FINITURA DUST



- ART. 38713DU ↓ 7,5 ↔ 10 cm
- ART. 38736DU ↓ 11,5 ↔ 15,5 cm
- ART. 38714DU ↓ 15 ↔ 20 cm



- ART. 38716DU ↓ 5 ↔ 10 cm
- ART. 38717DU ↓ 7,5 ↔ 15 cm
- ART. 38718DU ↓ 10 ↔ 20 cm
- ART. 38789DU ↓ 15 ↔ 30 cm
- ART. 38790DU ↓ 20 ↔ 40 cm



- ART. 38721DU ↓ 5 ↔ 10 cm
- ART. 38722DU ↓ 7,5 ↔ 15 cm
- ART. 38723DU ↓ 10 ↔ 20 cm
- ART. 38774DU ↓ 15 ↔ 30 cm
- ART. 38775DU ↓ 20 ↔ 40 cm

NOVITÀ



- ART. 38801 ↓ 7,5 ↔ 10 cm
- ART. 38737 ↓ 11,5 ↔ 15,5 cm
- ART. 38810 ↓ 15 ↔ 20 cm



- ART. 38802 ↓ 7,5 ↔ 10 cm
- ART. 38738 ↓ 11,5 ↔ 15,5 cm
- ART. 38811 ↓ 15 ↔ 20 cm



- ART. 38803 ↓ 7,5 ↔ 10 cm
- ART. 38739 ↓ 11,5 ↔ 15,5 cm
- ART. 38812 ↓ 15 ↔ 20 cm



- ART. 38804 ↓ 7,5 ↔ 10 cm
- ART. 38741 ↓ 11,5 ↔ 15,5 cm
- ART. 38813 ↓ 15 ↔ 20 cm



- ART. 38805 ↓ 7,5 ↔ 10 cm
- ART. 38742 ↓ 11,5 ↔ 15,5 cm
- ART. 38814 ↓ 15 ↔ 20 cm



- ART. 38806 ↓ 7,5 ↔ 10 cm
- ART. 38743 ↓ 11,5 ↔ 15,5 cm
- ART. 38815 ↓ 15 ↔ 20 cm

PIASTRE PER INCISIONE TAGLIATE DA LASTRA

PERSONALIZZABILI - incisione inclusa nel prezzo

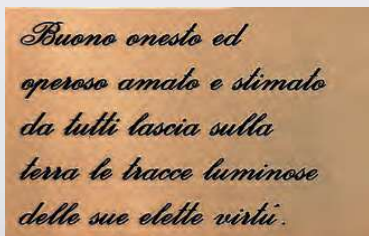

- ART. 30007 ↓ 5 ↔ 10 cm
- ART. 30008 ↓ 10 ↔ 15 cm
- ART. 30009 ↓ 15 ↔ 20 cm



- ART. 38807 ↓ 7,5 ↔ 10 cm
- ART. 38746 ↓ 11,5 ↔ 15,5 cm
- ART. 38816 ↓ 15 ↔ 20 cm



- ART. 38808 ↓ 7,5 ↔ 10 cm
- ART. 38744 ↓ 11,5 ↔ 15,5 cm
- ART. 38817 ↓ 15 ↔ 20 cm

BOTTICINO

CARRARA



ART. 38716 ↓5 ↔ 10 cm
ART. 38717 ↓7,5 ↔ 15 cm
ART. 38718 ↓10 ↔ 20 cm
ART. 38789 ↓15 ↔ 30 cm
ART. 38790 ↓20 ↔ 40 cm



ART. 38721 ↓5 ↔ 10 cm
ART. 38722 ↓7,5 ↔ 15 cm
ART. 38723 ↓10 ↔ 20 cm
ART. 38774 ↓15 ↔ 30 cm
ART. 38775 ↓20 ↔ 40 cm



ART. 38713BO ↓7,5 ↔ 10 cm
ART. 38736BO ↓11,5 ↔ 15,5 cm
ART. 38714BO ↓15 ↔ 20 cm



ART. 38713CA ↓7,5 ↔ 10 cm
ART. 38736CA ↓11,5 ↔ 15,5 cm
ART. 38714CA ↓15 ↔ 20 cm



ART. 38734 ↓6 ↔ 10 cm
ART. 38724 ↓9,5 ↔ 17 cm
ART. 38729 ↓12,5 ↔ 22,5 cm

NOVITÀ



ART. 38726 ↓10 ↔ 10 cm
ART. 38727 ↓14,5 ↔ 15 cm
ART. 38728 ↓19,5 ↔ 20 cm
ART. 38711 ↓29 ↔ 30 cm

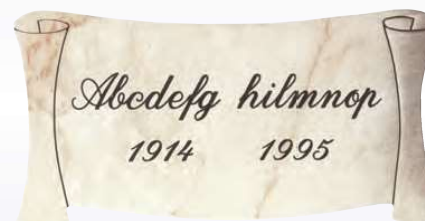

ART. 38721BO ↓5 ↔ 10 cm
ART. 38722BO ↓7,5 ↔ 15 cm
ART. 38723BO ↓10 ↔ 20 cm



ART. 38721CA ↓5 ↔ 10 cm
ART. 38722CA ↓7,5 ↔ 15 cm
ART. 38723CA ↓10 ↔ 20 cm

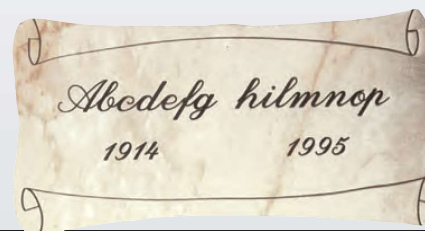

ART. 38716BO ↓5 ↔ 10 cm
ART. 38717BO ↓7,5 ↔ 15 cm
ART. 38718BO ↓10 ↔ 20 cm



ART. 38716CA ↓5 ↔ 10 cm
ART. 38717CA ↓7,5 ↔ 15 cm
ART. 38718CA ↓10 ↔ 20 cm



ART. 38868 bianco e nero
ART. 38869 colori
TARGA ↓ 17 ↔ 30 cm FOTOCERAMICA 7x9 cm



ART. 38844 ↓ 10 ↔ 20 cm



ART. 38846 ↓ 13,5 ↔ 22,5 cm



ART. 38864 bianco e nero
ART. 38865 colori
TARGA ↓ 9 ↔ 15 cm MINIATURA 3,5x4,5 cm



ART. 38862 bianco e nero
ART. 38863 colori
TARGA ↓ 7 ↔ 11 cm MINIATURA 2,5x3,5 cm



ART. 38841 ↓ 18 ↔ 34 cm



ART. 38866 bianco e nero
ART. 38867 colori
TARGA ↓ 13 ↔ 20 cm FOTOCERAMICA 5x7 cm



ART. 38842 ↓ 20 ↔ 34 cm



ART. 38847 ↓ 10 ↔ 20 cm



ART. 38848 ↓ 15,5 ↔ 31 cm



ART. 38849 ↓ 19 ↔ 16 cm



ART. 38837 ↓ 15 ↔ 26 cm



ART. 38840 ↓ 10 ↔ 20 cm
ART. 38836 ↓ 13 ↔ 23 cm



Targhetta INRI
ART. 31202 ↓ 5,5 ↔ 7,5 cm



Targhetta INRI
ART. 31201 ↓ 5 ↔ 4 cm

TARGHE FUSE

PERSONALIZZABILI



SI POSSONO RICHIEDERE TARGHE FUSE IN BRONZO
DI QUALSIASI DIMENSIONE, FINITURA CLASSICA O CON COLORE FONDO A RICHIESTA.



ART. 38510/40 ↓ 10 ↔ 12 cm - Fino a 40 lettere
 ART. 38510/100 ↓ 10 ↔ 12 cm - Fino a 100 lettere
 ART. 38510/150 ↓ 10 ↔ 12 cm - Fino a 150 lettere

ART. 38511/40 ↓ 15 ↔ 18 cm - Fino a 40 lettere
 ART. 38511/100 ↓ 15 ↔ 18 cm - Fino a 100 lettere
 ART. 38511/150 ↓ 15 ↔ 18 cm - Fino a 150 lettere

ART. 38512/40 ↓ 20 ↔ 24 cm - Fino a 40 lettere
 ART. 38512/100 ↓ 20 ↔ 24 cm - Fino a 100 lettere
 ART. 38512/150 ↓ 20 ↔ 24 cm - Fino a 150 lettere

P



ART. 38513/40 ↓ 25 ↔ 30 cm - Fino a 40 lettere
 ART. 38513/100 ↓ 25 ↔ 30 cm - Fino a 100 lettere
 ART. 38513/150 ↓ 25 ↔ 30 cm - Fino a 150 lettere

ART. 38514/40 ↓ 30 ↔ 36 cm - Fino a 40 lettere
 ART. 38514/100 ↓ 30 ↔ 36 cm - Fino a 100 lettere
 ART. 38514/150 ↓ 30 ↔ 36 cm - Fino a 150 lettere

ART. 38515/40 ↓ 40 ↔ 48 cm - Fino a 40 lettere
 ART. 38515/100 ↓ 40 ↔ 48 cm - Fino a 100 lettere
 ART. 38515/150 ↓ 40 ↔ 48 cm - Fino a 150 lettere

P



ART. 38530/40 ↓ 10 ↔ 12 cm - Fino a 40 lettere
 ART. 38530/100 ↓ 10 ↔ 12 cm - Fino a 100 lettere
 ART. 38530/150 ↓ 10 ↔ 12 cm - Fino a 150 lettere

ART. 38531/40 ↓ 15 ↔ 18 cm - Fino a 40 lettere
 ART. 38531/100 ↓ 15 ↔ 18 cm - Fino a 100 lettere
 ART. 38531/150 ↓ 15 ↔ 18 cm - Fino a 150 lettere

ART. 38532/40 ↓ 20 ↔ 24 cm - Fino a 40 lettere
 ART. 38532/100 ↓ 20 ↔ 24 cm - Fino a 100 lettere
 ART. 38532/150 ↓ 20 ↔ 24 cm - Fino a 150 lettere

T



ART. 38533/40 ↓ 25 ↔ 30 cm - Fino a 40 lettere
 ART. 38533/100 ↓ 25 ↔ 30 cm - Fino a 100 lettere
 ART. 38533/150 ↓ 25 ↔ 30 cm - Fino a 150 lettere

ART. 38534/40 ↓ 30 ↔ 36 cm - Fino a 40 lettere
 ART. 38534/100 ↓ 30 ↔ 36 cm - Fino a 100 lettere
 ART. 38534/150 ↓ 30 ↔ 36 cm - Fino a 150 lettere

ART. 38535/40 ↓ 40 ↔ 48 cm - Fino a 40 lettere
 ART. 38535/100 ↓ 40 ↔ 48 cm - Fino a 100 lettere
 ART. 38535/150 ↓ 40 ↔ 48 cm - Fino a 150 lettere

T



ART. 38544
48x23,5 cm



ART. 38558
48x23,5 cm



ART. 38541
30x18,5 cm



ART. 38563
30x18,5 cm



ART. 38566
↓ 20 cm



ART. 38567
↓ 13 cm



ART. 38545
48x23,5 cm



ART. 38560
48x23,5 cm



ART. 38542
30x18,5 cm



ART. 38565
30x18,5 cm



ART. 38570
↓ 20 cm



ART. 38571
↓ 13 cm



ART. 38543
48x23,5 cm



ART. 38559
48x23,5 cm



ART. 38540
30x18,5 cm



ART. 38564
30x18,5 cm



ART. 38568
↓ 20 cm



ART. 38569
↓ 13 cm



ART. 38551
48x22,5 cm

ART. 38588
48x22,5 cm

ART. 38548
30x18,5 cm

ART. 38574
30x18,5 cm

ART. 38579
↓ 20 cm

ART. 38580
↓ 13 cm



ART. 38550
48x22,5 cm

ART. 38561
48x22,5 cm

ART. 38547
30x18,5 cm

ART. 38572
30x18,5 cm

ART. 38575
↓ 20 cm

ART. 38576
↓ 13 cm



ART. 38549
48x22,5 cm

ART. 38562
48x22,5 cm

ART. 38546
30x18,5 cm

ART. 38573
30x18,5 cm

ART. 38577
↓ 20 cm

ART. 38578
↓ 13 cm



ART. 38556
48x19,5 cm



ART. 38553
30x20,5 cm



ART. 38536
↓ 20 cm



ART. 38537
↓ 13 cm



ART. 38557
48x19,5 cm



ART. 38554
30x20,5 cm



ART. 38647
↓ 20 cm



ART. 38648
↓ 13 cm



ART. 38555
48x19,5 cm



ART. 38552
30x20,5 cm



ART. 38538
↓ 20 cm



ART. 38539
↓ 13 cm



ART. 38663
58x20 cm



ART. 38662
44x19 cm



ART. 38661
36x18 cm



ART. 38660
33x18 cm



ART. 38655
33x18 cm



ART. 38656
36x18 cm



ART. 38657
44x19 cm



ART. 38658
58x20 cm



ART. 38670
50x42 cm



ART. 38653
58x20 cm



ART. 38652
44x19 cm



ART. 38651
36x18 cm



ART. 38650
33x18 cm



Sinistro

Destro

ART. 38649
Diritto 25x16 cm
Sinistro 25x16 cm

ART. 38659
Destro 25x16 cm

ART. 38654
Destro 25x16 cm



ART. 38665
50x42 cm



Diritto
ART. 38581 58x20 cm
Sinistro
ART. 38582 58x20 cm
Destro
ART. 38583 58x20 cm



Diritto
ART. 38584 44x19 cm
Sinistro
ART. 38585 44x19 cm
Destro
ART. 38586 44x19 cm



Diritto
ART. 38587 36x18 cm
Sinistro
ART. 38589 36x18 cm
Destro
ART. 38590 36x18 cm



Diritto
ART. 38465 58x20 cm
Sinistro
ART. 38466 58x20 cm
Destro
ART. 38467 58x20 cm



Diritto
ART. 38468 44x19 cm
Sinistro
ART. 38469 44x19 cm
Destro
ART. 38470 44x19 cm



Diritto
ART. 38471 36x18 cm
Sinistro
ART. 38472 36x18 cm
Destro
ART. 38473 36x18 cm



Angolo Sinistro
ART. 38591 50x42 cm
Angolo Destro
ART. 38592 50x42 cm



Diritto
ART. 38593 33x18 cm
Sinistro
ART. 38594 33x18 cm
Destro
ART. 38595 33x18 cm



Diritto
ART. 38462 25x16 cm
Sinistro
ART. 38463 25x16 cm
Destro
ART. 38464 25x16 cm



Angolo Sinistro
ART. 38474 50x42 cm
Angolo Destro
ART. 38475 50x42 cm



Diritto
ART. 38476 33x18 cm
Sinistro
ART. 38477 33x18 cm
Destro
ART. 38478 33x18 cm



Diritto
ART. 38479 25x16 cm
Sinistro
ART. 38492 25x16 cm
Destro
ART. 38493 25x16 cm



Diritto
ART. 38494 58x20 cm
 Sinistro
ART. 38495 58x20 cm
 Destro
ART. 38496 58x20 cm



Diritto
ART. 38497 44x19 cm
 Sinistro
ART. 38498 44x19 cm
 Destro
ART. 38499 44x19 cm



Diritto
ART. 38500 36x18 cm
 Sinistro
ART. 38501 36x18 cm
 Destro
ART. 38502 36x18 cm



Angolo Sinistro
ART. 38503 50x42 cm
 Angolo Destro
ART. 38504 50x42 cm



Diritto
ART. 38505 33x18 cm
 Sinistro
ART. 38506 33x18 cm
 Destro
ART. 38507 33x18 cm



Diritto
ART. 38508 25x16 cm
 Sinistro
ART. 38509 25x16 cm
 Destro
ART. 38520 25x16 cm



ART. 38642
 9x5 cm



ART. 38521
 9x5 cm



ART. 38522
 9x5 cm



ART. 38523
 9x5 cm



ART. 38640
 8x7 cm



ART. 38524
 8x7 cm



ART. 38526
 8x7 cm



ART. 38528
 8x7 cm

ART. 38641
 15x14 cm

ART. 38525
 15x14 cm

ART. 38527
 15x14 cm

ART. 38529
 15x14 cm



ART. 38639
 13x6 cm



ART. 38370
 13x6 cm



ART. 38371
 13x6 cm



ART. 38372
 13x6 cm



ART. 38636
14x9 cm



ART. 38373
14x9 cm



ART. 38375
14x9 cm



ART. 38377
14x9 cm

ART. 38635
20x12 cm

ART. 38374
20x12 cm

ART. 38376
20x12 cm

ART. 38378
20x12 cm



Crisantemo
ART. 38632
13x7 cm



Crisantemo
ART. 38386
13x7 cm



Crisantemo
ART. 38643
8x5 cm



Crisantemo
ART. 38387
8x5 cm



ART. 38609
14x9 cm



ART. 38379
14x9 cm



ART. 38381
14x9 cm



ART. 38383
14x9 cm

ART. 38603
20x12 cm

ART. 38380
20x12 cm

ART. 38382
20x12 cm

ART. 38384
20x12 cm



Viola del pensiero
ART. 38644
9x5 cm



Viola del pensiero
ART. 38388
9x5 cm



Viola del pensiero
ART. 38637
13x7 cm
ART. 38634
19x11 cm



Viola del pensiero
ART. 38389
13x7 cm
ART. 38390
19x11 cm



Stella alpina
ART. 38633
14x7 cm



Stella alpina
ART. 38385
14x7 cm



Margherita
ART. 38631
16x7 cm



Margherita
ART. 38391
16x7 cm



ART. 38610
29x29 cm



ART. 38608
32x24 cm



ART. 38616
35x35 cm Sinistro



ART. 38613
35x13 cm

ART. 38617
35x35 cm Destro



ART. 38638
28x8 cm



ART. 38611
17x10 cm



ART. 38645
31x18 cm



ART. 38646
31x18 cm



ART. 38620
Ø 2,5 cm

ART. 38602
42x12 cm

ART. 38612
25x13 cm

ART. 38625
Ø 5 cm

Regolabile portante



* ART. 30832 Ø cm 4
* ART. 30968 Ø cm 5
* ART. 30969 Ø cm 6
A RICHIESTA PERNO M8



* ART. 43620 Ø cm 3
* ART. 43621 Ø cm 4
* ART. 43622 Ø cm 5
* ART. 43623 Ø cm 6
* ART. 43624 Ø cm 8



ART. 30907 Ø cm 3
ART. 30907M8 Ø cm 3
ART. 30941 Ø cm 5,5
ART. 30941M8 Ø cm 5,5



ART. 30921 Ø cm 3
Perno di Ø 8 MA compreso nel prezzo



Borchia Regolabile Portante
ART. 30940 Ø cm 5,5
Perno di Ø 8 MA compreso nel prezzo
ART. 30962 Ø cm 5
Perno di Ø 12 MA compreso nel prezzo

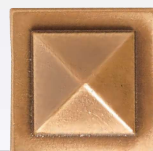

* ART. 30833 cm 3x3
* ART. 30834 cm 4x4
* ART. 30835 cm 5x5
ART. 30835M8 cm 5x5

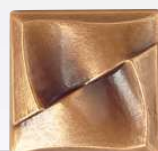

* ART. 43600 cm 3x3
* ART. 43601 cm 4x4
* ART. 43602 cm 5x5
* ART. 43603 cm 6x6



* ART. 30801 Ø cm 2x2
* ART. 30803 Ø cm 3x3
* ART. 30804 Ø cm 4x4
* ART. 30800 Ø cm 4,5x4,5
* ART. 30805 Ø cm 5x5
* ART. 30849 Ø cm 6x6



ART. 30948 Ø cm 3
Perno di Ø 8 MA compreso nel prezzo
ART. 30949 Ø cm 5
Perno di Ø 8 MA compreso nel prezzo



ART. 30958 Ø cm 5
Perno di Ø 8 MA compreso nel prezzo



* ART. 30830 Ø cm 4
* ART. 30831 Ø cm 5



ART. 30964 Ø cm 5
Predisposta per il perno Ø 5 MA non compreso nel prezzo
ART. 30965 Ø cm 5
Predisposta per il perno Ø 10 MA non compreso nel prezzo
ART. 30966 Ø cm 8
Predisposta per il perno Ø 6 MA non compreso nel prezzo
A RICHIESTA PERNO M8



* ART. 30843 Ø cm 3
* ART. 30844 Ø cm 4
* ART. 30845 Ø cm 5

OTIPRINT



BIANCO
* ART. 30832BI Ø cm 4
* ART. 30968BI Ø cm 5
* ART. 30969BI Ø cm 6
A RICHIESTA PERNO M8



CARRARA
* ART. 30832CA Ø cm 4
* ART. 30968CA Ø cm 5
* ART. 30969CA Ø cm 6
A RICHIESTA PERNO M8



BOTTICINO
* ART. 30832BO Ø cm 4
* ART. 30968BO Ø cm 5
* ART. 30969BO Ø cm 6
A RICHIESTA PERNO M8

OTIPRINT



BIANCO
ART. 30948BI Ø cm 3
Perno Ø 8 MA compreso nel prezzo
ART. 30949BI Ø cm 5
Perno Ø 8 MA compreso nel prezzo



CARRARA
ART. 30948CA Ø cm 3
Perno Ø 8 MA compreso nel prezzo
ART. 30949CA Ø cm 5
Perno Ø 8 MA compreso nel prezzo



BOTTICINO
ART. 30948BO Ø cm 3
Perno Ø 8 MA compreso nel prezzo
ART. 30949BO Ø cm 5
Perno Ø 8 MA compreso nel prezzo

AVVERTENZE PER L'UTENTE: le staffe o borchie portanti, raffigurate nel presente catalogo, sono realizzate con materiale di alta qualità da consentire il mantenimento nel tempo delle loro caratteristiche. La funzionalità e la sicurezza delle stesse è condizionata alla corretta installazione che prevede l'utilizzo di due staffe o borchie sul lato inferiore e due sul lato superiore di ogni lastra copriloculo.

NOTE FOR THE USER: the support brackets or load bearing studs, shown in this catalogue, have been made with special quality material that maintains its characteristics with the passing of time. The functionality and safety of these items depend upon their correct installation, which provides for the use of two brackets or studs on the lower side and two on the upper side of each loculus cover slab.

* I prezzi delle borchie si intendono senza perni e sono predisposte di serie per il perno di Ø 5 MA - ART. 91150

Regolabili portanti per marmo da cm 1-2-3
a = spessore marmo

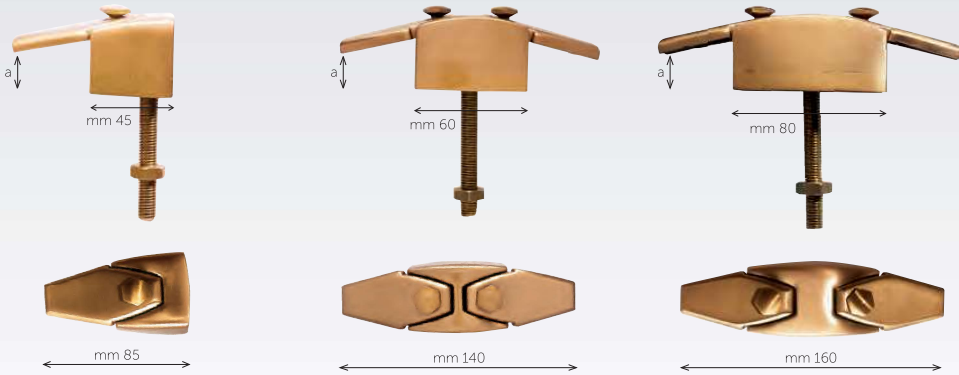

ART. 30770 - a = cm 2-3
Perno da Ø 10 MA x 100 compreso nel prezzo
ART. 30773 - a = cm 2-3
Perno da Ø 8 MA x 100 compreso nel prezzo

ART. 30771 - a = cm 2-3
Perno da Ø 10 MA x 100 compreso nel prezzo
ART. 30774 - a = cm 2-3
Perno da Ø 8 MA x 100 compreso nel prezzo

ART. 30772 - a = cm 2-3
Perno da Ø 10 MA x 100 compreso nel prezzo
ART. 30775 - a = cm 2-3
Perno da Ø 8 MA x 100 compreso nel prezzo

Regolabili portanti per marmo da cm 1-2
a = spessore marmo

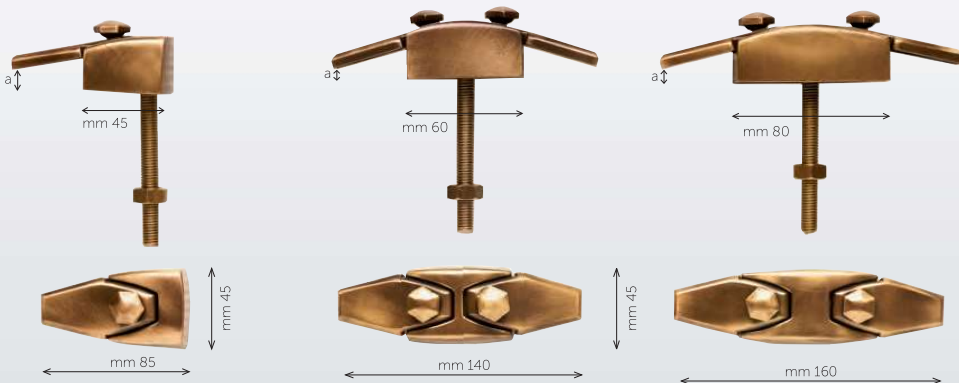

ART. 30930 - a = cm 1-2
Perno da Ø 10 MA x 100 compreso nel prezzo
ART. 30942 - a = cm 1-2
Perno da Ø 8 MA x 100 compreso nel prezzo

ART. 30931 - a = cm 1-2
Perno da Ø 10 MA x 100 compreso nel prezzo
ART. 30943 - a = cm 1-2
Perno da Ø 8 MA x 100 compreso nel prezzo

ART. 30932 - a = cm 1-2
Perno da Ø 10 MA x 100 compreso nel prezzo
ART. 30944 - a = cm 1-2
Perno da Ø 8 MA x 100 compreso nel prezzo

Regolabili portanti per marmo da cm 1-2-3

OTIPRINT

PERNO DA Ø 10 MA COMPRESO NEL PREZZO

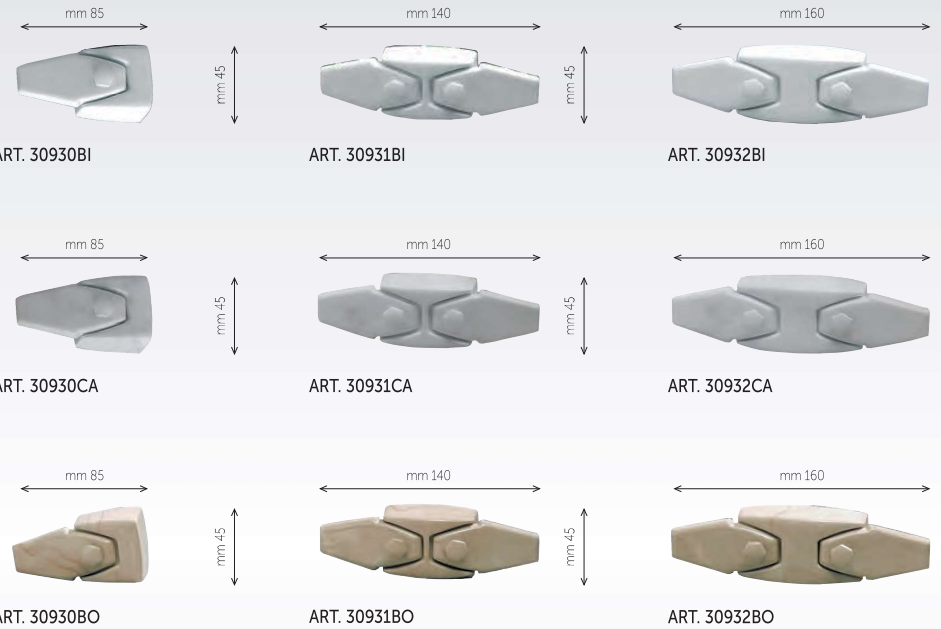

STAFFE PER OSSARIO

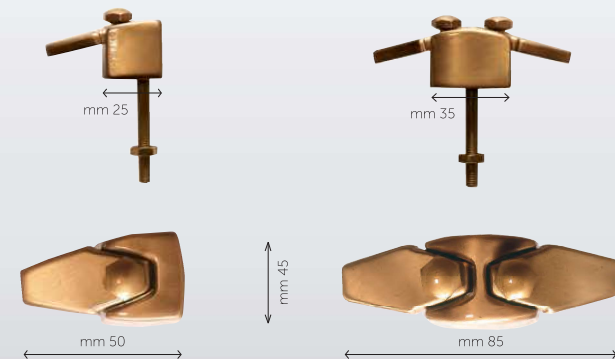

ART. 30977
Perno da Ø 8 MA x 100 compreso nel prezzo

ART. 30978
Perno da Ø 8 MA x 100 compreso nel prezzo

Regolabili portanti per marmo da cm 1-2
a = spessore marmo

CAPPUCCIO BRONZO

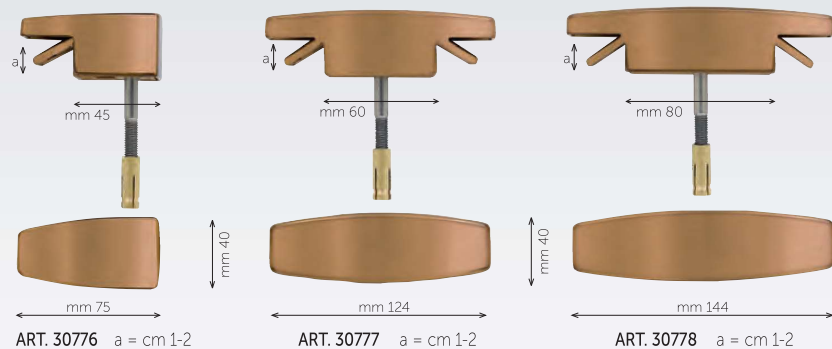

CAPPUCCIO PATINATO BRONZO



CAPPUCCIO PATINATO BRONZO FINITURA CROMATA



VITE INOX CON ESAGONO INCASSO+TASSELLO OTTONE M8 COMPRESI NEL PREZZO

Regolabili portanti per marmo da cm 1-2
a = spessore marmo

CAPPUCCIO PATINATO BOTTICINO



CAPPUCCIO PATINATO BIANCO DI CARRARA



VITE INOX CON ESAGONO INCASSO+TASSELLO OTTONE M8 COMPRESI NEL PREZZO

*Regolabili portanti per marmo da cm 1-2-3
a = spessore marmo*

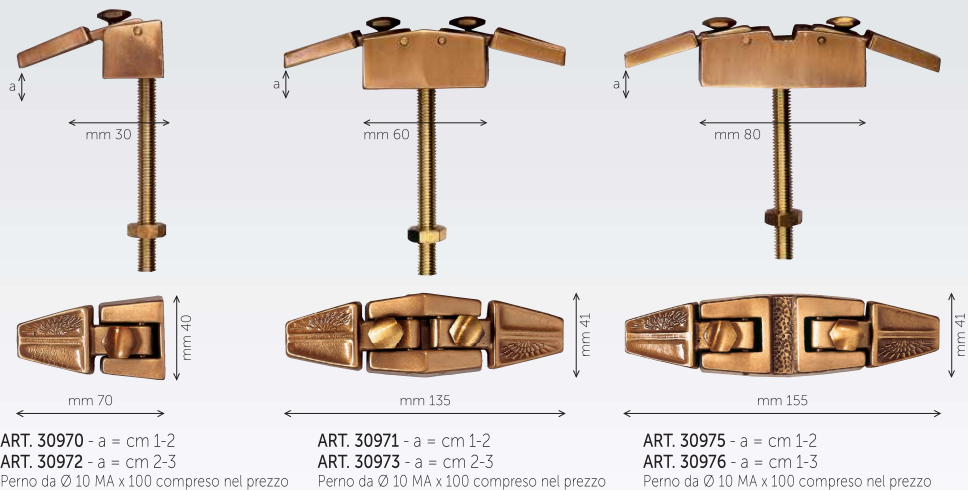

Regolabili non portanti

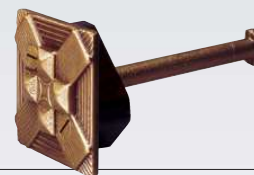
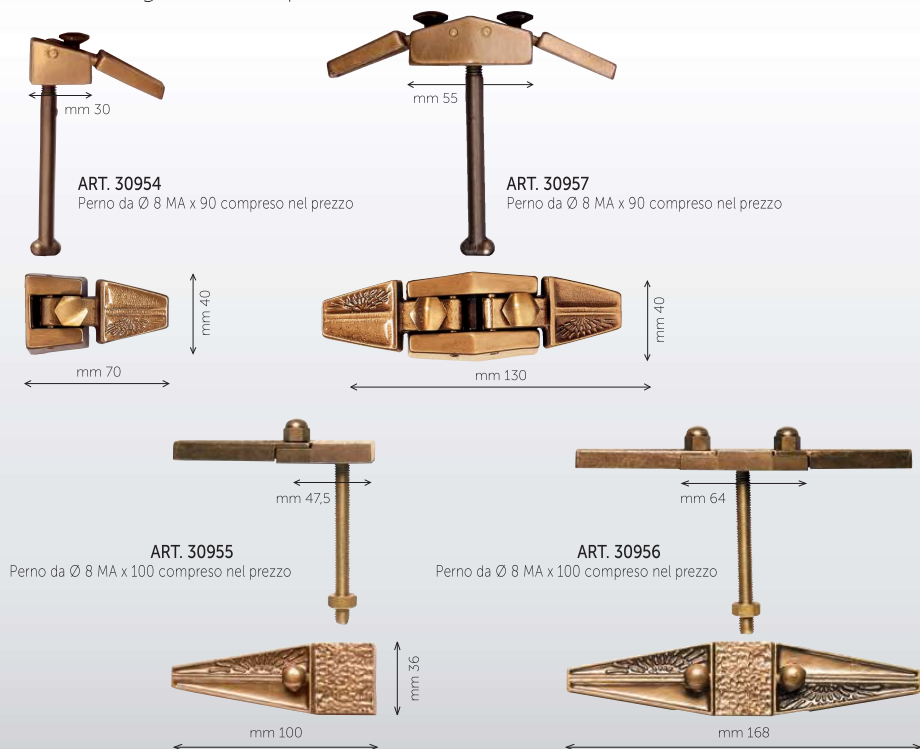

Borchia tipo Ortona
ART. 30840 6x6 cm
Perno Ø 10 MA x 100 compreso nel prezzo



Borchia
ART. 43630 Ø 6x19 cm
Perno Ø 10 MA compreso nel prezzo



Borchia ad innesto
ART. 30847 5x5 cm



Borchia Bottone
ART. 30848 Ø cm 2

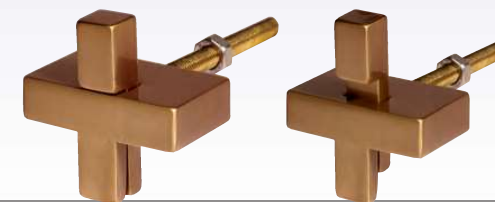

Borchia
ART. 30929 † 6 ↔ 6 cm
Perno Ø 8 MA compreso nel prezzo



ART. 30967 - 8 MA 3x3,5 cm



Chiavarda
ART. 10880
Prezzo della sola chiavarda. Aggiungere il prezzo della borchia desiderata e del perno. Per marmi dello spessore di cm 2-2,5-3-3,5-4-4,5.
Può essere applicata sulle seguenti borchie:
30800 - 30804 - 30813 - 30814 - 30815 - 30816
30823 - 30824 - 30825 - 30826 - 30828 - 30833
30834 - 30843 - 30844 - 30845 - 30854
30863 - 30864 - 30865.
Negli ordinativi citare lo spessore del marmo e il tipo di borchia desiderato.

AVVERTENZE PER L'UTENTE: le staffe o borchie portanti, raffigurate nel presente catalogo, sono realizzate con materiale di alta qualità da consentire il mantenimento nel tempo delle loro caratteristiche. La funzionalità e la sicurezza delle stesse è condizionata alla corretta installazione che prevede l'utilizzo di due staffe o borchie sul lato inferiore e due sul lato superiore di ogni lastra copriloculo.

NOTE FOR THE USER: the support brackets or load bearing studs, shown in this catalogue, have been made with special quality material that maintains its characteristics with the passing of time. The functionality and safety of these items depend upon their correct installation, which provides for the use of two brackets or studs on the lower side and two on the upper side of each loculus cover slab.

NOVITÀ



SU 4 COLONNINE

- ART. 31052 ↓ 11 ↔ 20 ↗ 11 cm
- ART. 31053 ↓ 11 ↔ 25 ↗ 11 cm
- ART. 31054 ↓ 11 ↔ 30 ↗ 11 cm
- ART. 31055 ↓ 11 ↔ 35 ↗ 11 cm

SU 5 COLONNINE

- ART. 31056 ↓ 11 ↔ 40 ↗ 11 cm
- ART. 31057 ↓ 11 ↔ 50 ↗ 11 cm
- ART. 31058 ↓ 11 ↔ 60 ↗ 11 cm
- ART. 31059 ↓ 11 ↔ 70 ↗ 11 cm

NOVITÀ



SU 4 COLONNINE

- ART. 11410 ↓ 11 ↔ 20 ↗ 11 cm
- ART. 11411 ↓ 11 ↔ 25 ↗ 11 cm
- ART. 11412 ↓ 11 ↔ 30 ↗ 11 cm
- ART. 11413 ↓ 11 ↔ 35 ↗ 11 cm

SU 5 COLONNINE

- ART. 11414 ↓ 11 ↔ 40 ↗ 11 cm
- ART. 11415 ↓ 11 ↔ 50 ↗ 11 cm
- ART. 11416 ↓ 11 ↔ 60 ↗ 11 cm
- ART. 11417 ↓ 11 ↔ 70 ↗ 11 cm



SU 2 COLONNINE

- ART. 31070 ↓ 10 ↔ 20 cm
- ART. 31071 ↓ 10 ↔ 25 cm
- ART. 31072 ↓ 10 ↔ 30 cm
- ART. 31073 ↓ 10 ↔ 35 cm

SU 3 COLONNINE

- ART. 31074 ↓ 10 ↔ 40 cm
- ART. 31075 ↓ 10 ↔ 50 cm
- ART. 31076 ↓ 10 ↔ 60 cm
- ART. 31077 ↓ 10 ↔ 70 cm



SU 2 COLONNINE

- ART. 11418 ↓ 10 ↔ 20 cm
- ART. 11419 ↓ 10 ↔ 25 cm
- ART. 11420 ↓ 10 ↔ 30 cm
- ART. 11421 ↓ 10 ↔ 35 cm

SU 3 COLONNINE

- ART. 11422 ↓ 10 ↔ 40 cm
- ART. 11423 ↓ 10 ↔ 50 cm
- ART. 11424 ↓ 10 ↔ 60 cm
- ART. 11425 ↓ 10 ↔ 70 cm



ART. 91570 Ø 5x70
ART. 91580 Ø 6x80
ART. 91590 Ø 8x100
ART. 91599 Ø 10x100



PERNO
ART. 91450 5 MA x50
ART. 91460 5 MA x60
ART. 91470 5 MA x70



INOX
ART. 91155 8 MA x100
ART. 91156 10 MA x100



TASSELLO AD ESPANSIONE
ART. 90157 passo 6 MA
ART. 90155 passo 8 MA
ART. 90156 passo 10 MA



Catena
ART. 31210 Maglia cm 9
Prezzo al metro



Catena
ART. 31215 Maglia cm 9
Prezzo al metro



Catena
ART. 31200 Maglia cm 11
Prezzo al metro



Perno ART. 91340 da TPS mm 40
Perno ART. 91350 da TPS mm 50
Perno ART. 91360 da TPS mm 60
Perno ART. 91370 da TPS mm 70



Perno ART. 91130 3 MA X 35
Perno ART. 91140 4 MA X 50
Perno ART. 91150 5 MA X 50
Perno ART. 91154 6 MA X 60
Perno ART. 91160 5 MA X 60
Perno ART. 91170 5 MA X 70
Perno ART. 91180 5 MA X 80



Patta ART. 30913 cm 8
Patta ART. 30914 cm 10
Patta ART. 30915 cm 12
Predisposte per il perno di Ø 5 MA



Patta ART. 30908 cm 8
Patta ART. 30910 cm 10
Patta ART. 30912 cm 12
Predisposte per il perno di Ø 5 MA



ART. 30684 Ø cm 7
ART. 30685 Ø cm 8
ART. 30693 Ø cm 10



ART. 30690 Ø cm 8
ART. 30691 Ø cm 10

BACCHETTE PER LAMPADE DA APPENDERE



INOX
ART. 10205 † 30
compreso anello



ART. 31205 † 30
compreso anello



Gancio
ART. 38400 Perno Ø 5 MA 4,5x4 cm
ART. 38408 Perno Ø 8 MA 6x5 cm



ART. 38401
Gancio Ø 8 cm



Rosone
ART. 38410
cm 15x12



ART. 30997 cm 5 x 8
sporgenza 12 cm
ART. 30996 cm 5 x 11
sporgenza 15 cm



ART. 38430
Staffa
per portafiori cm 20 e lampada Ø 5



ART. 38435
Staffa
per portafiori cm 28 e lampada Ø 6



ART. 30949



ART. 30931



ART. 30971



ART. 30840

