

# FRAMES

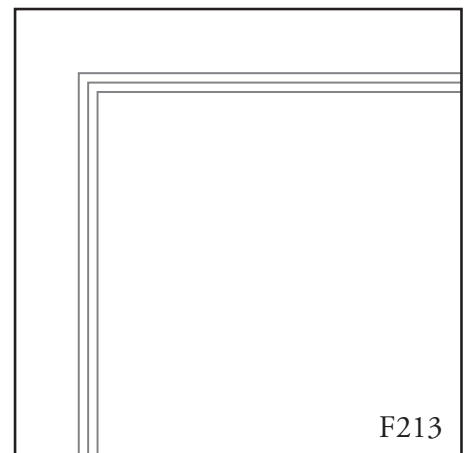

# FRAMES

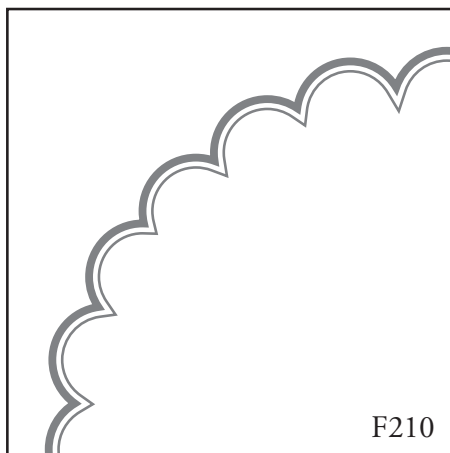
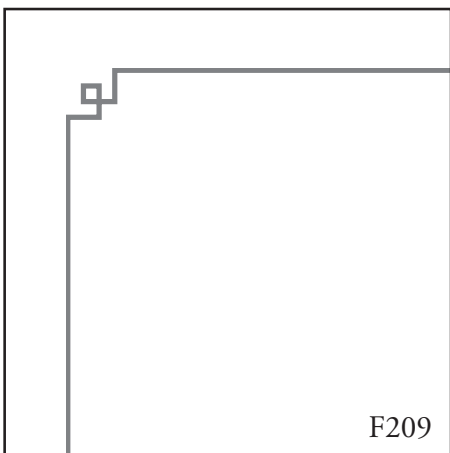
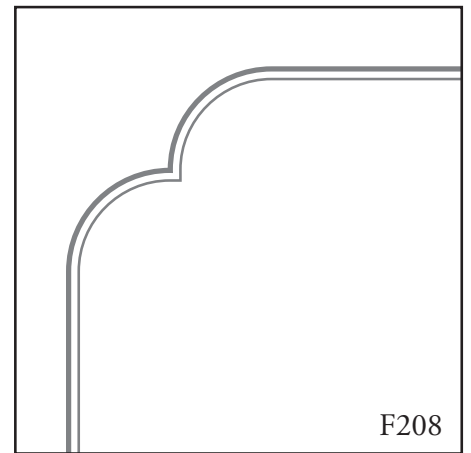
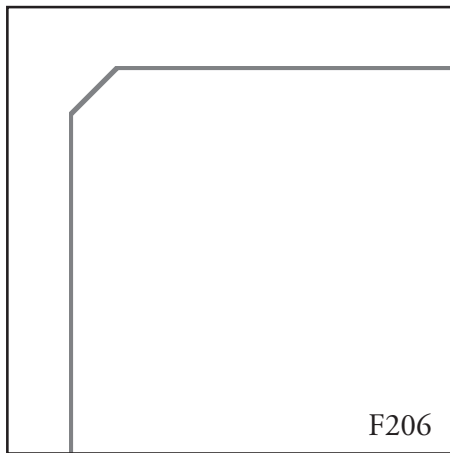
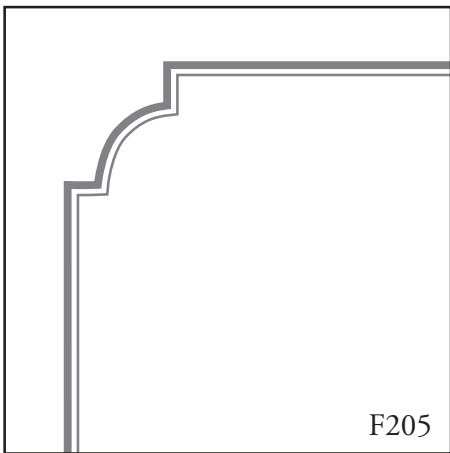
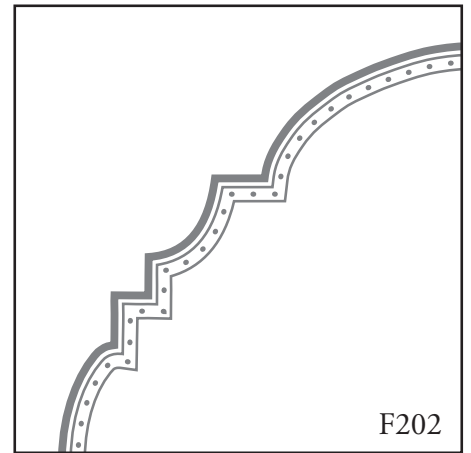
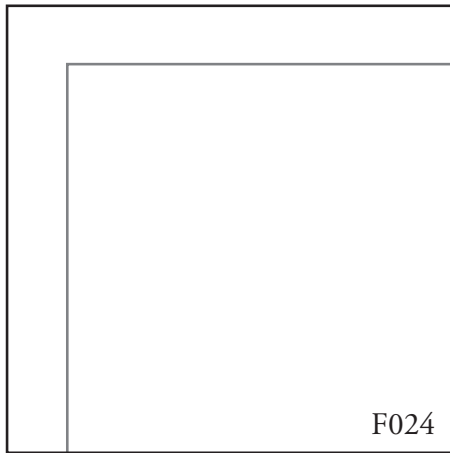
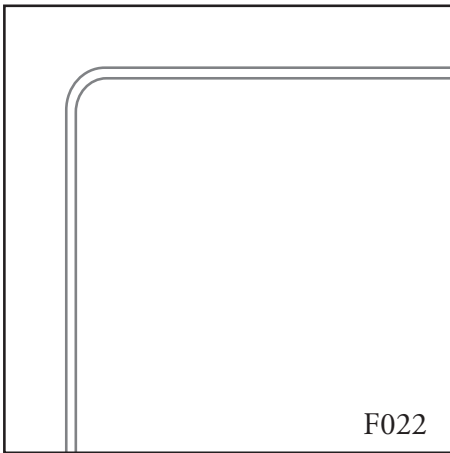
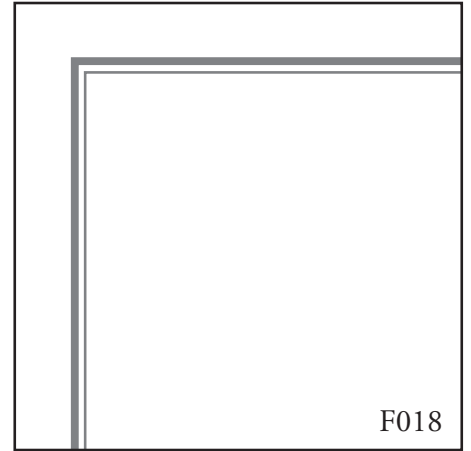
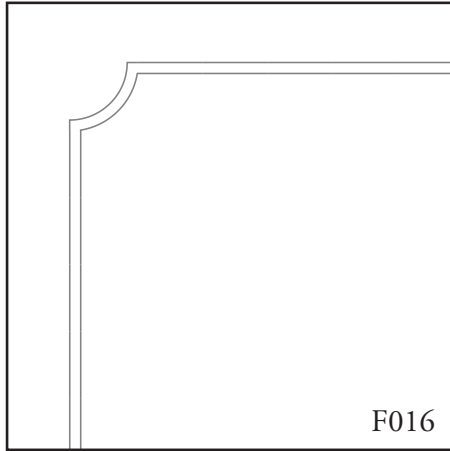
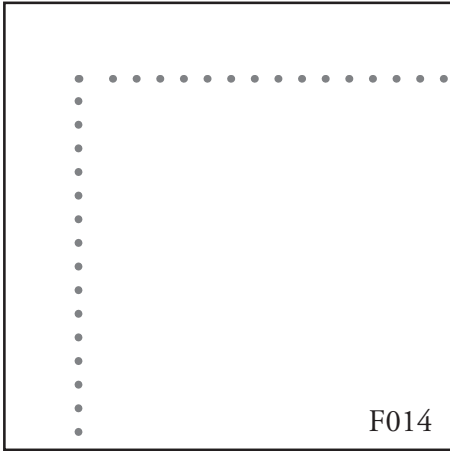
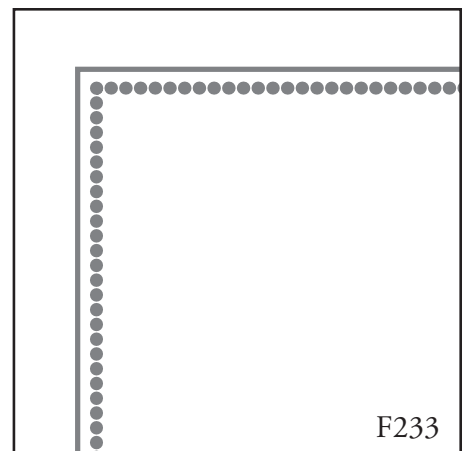
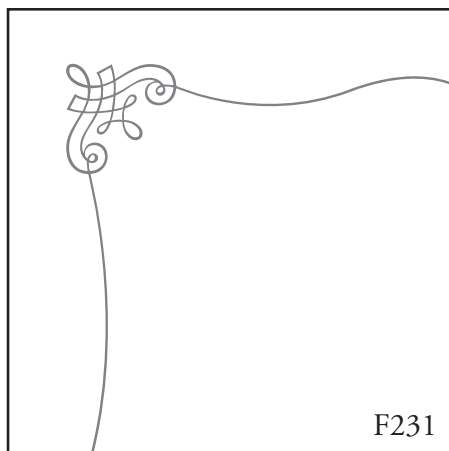
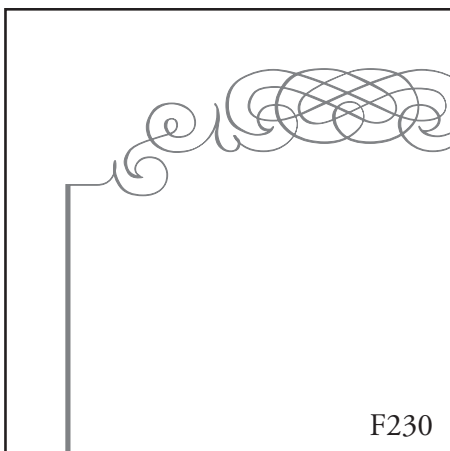
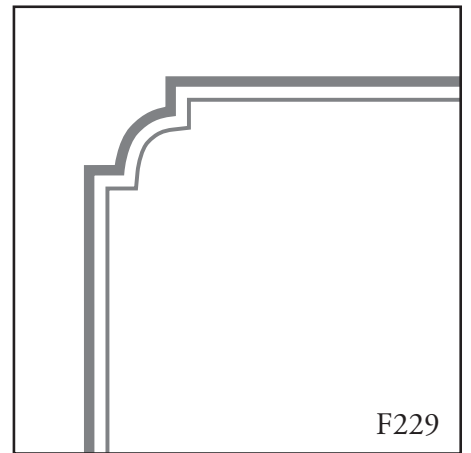
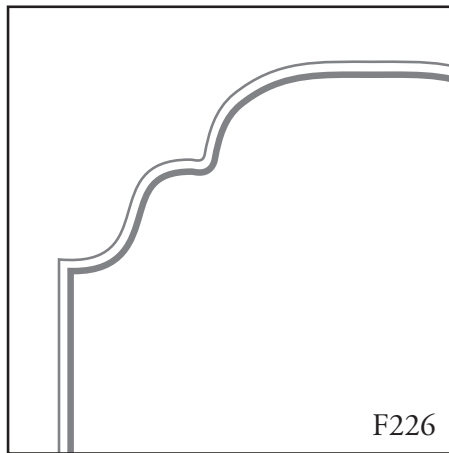
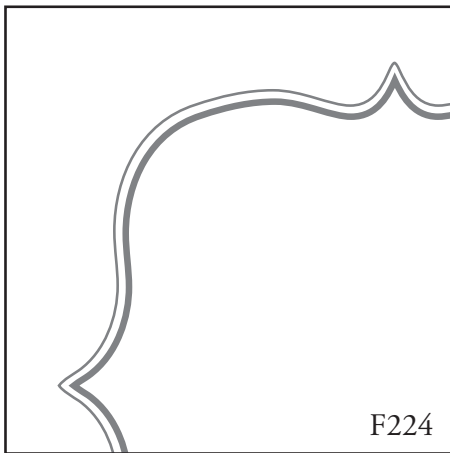
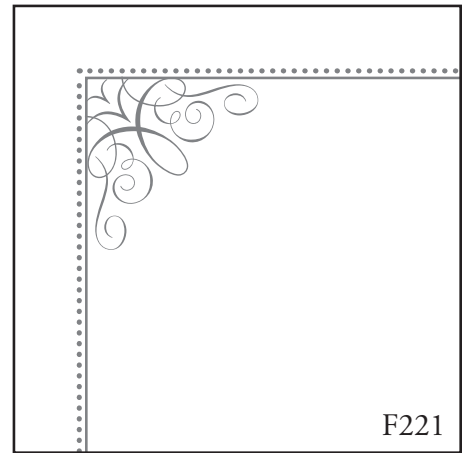
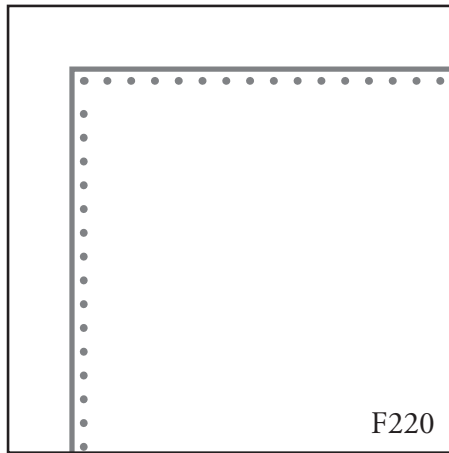
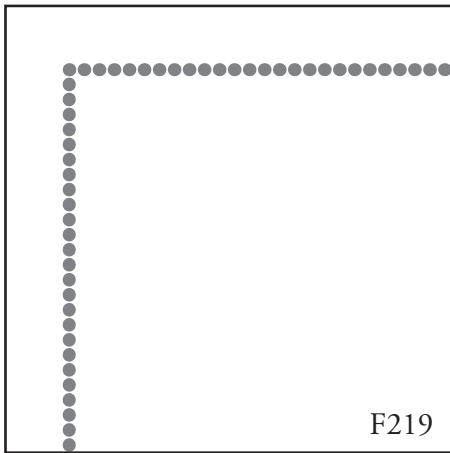
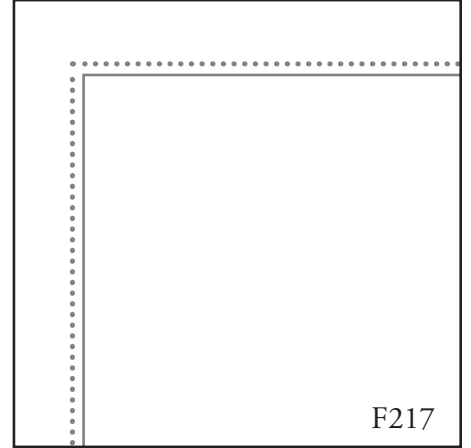
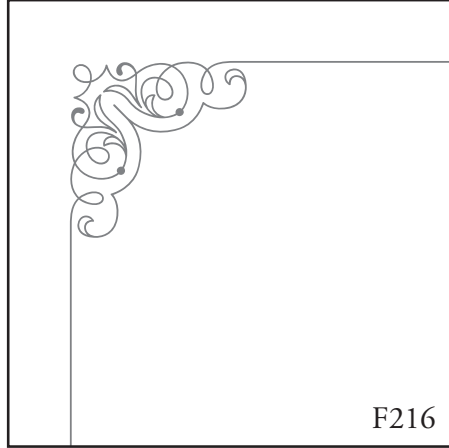
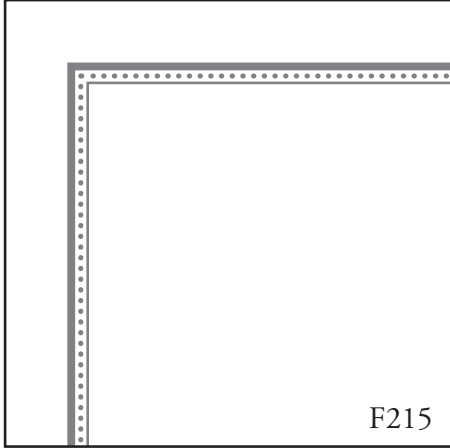

# FRAMES

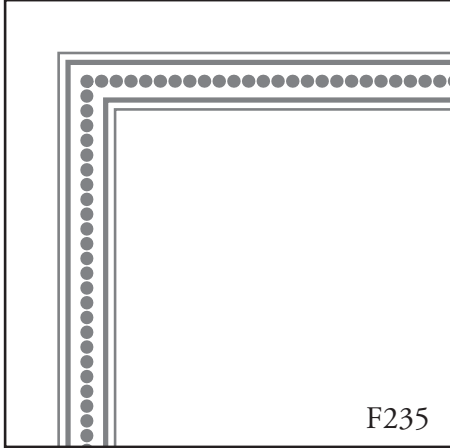

F235

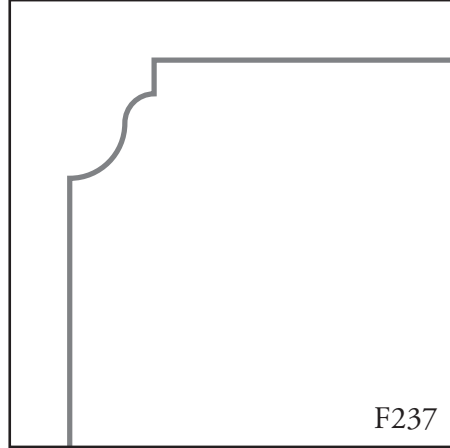

F237

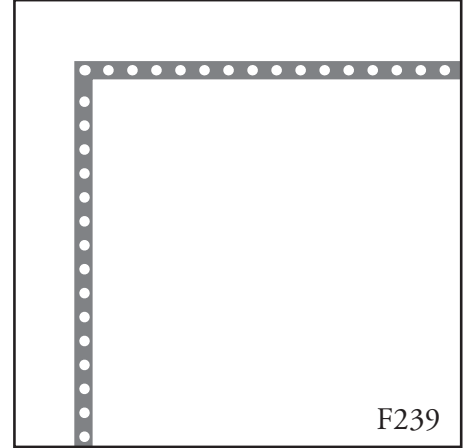

F239

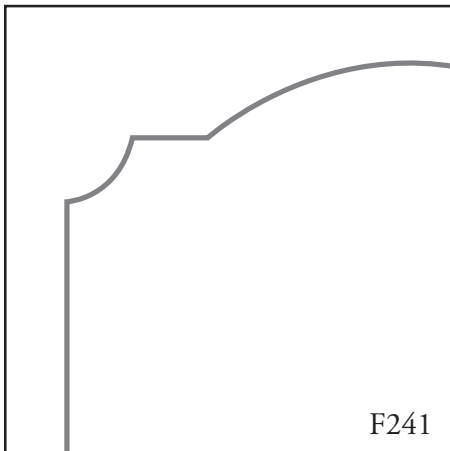

F241

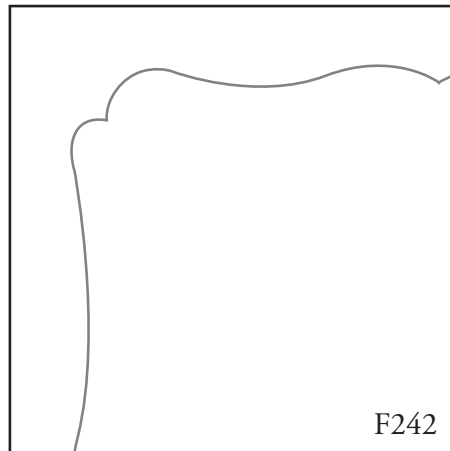

F242

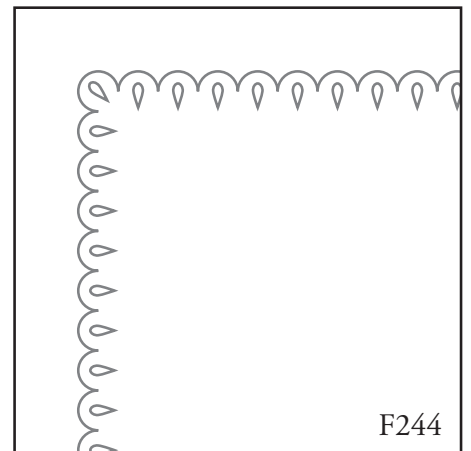

F244

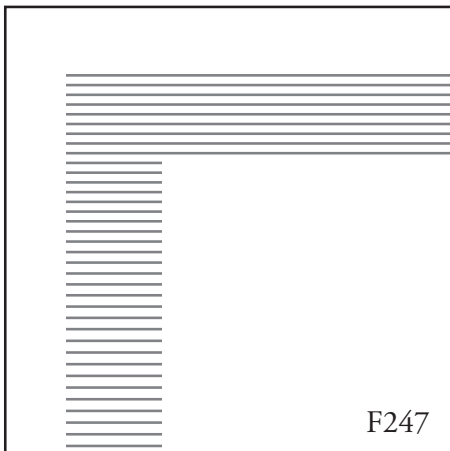

F247



F248

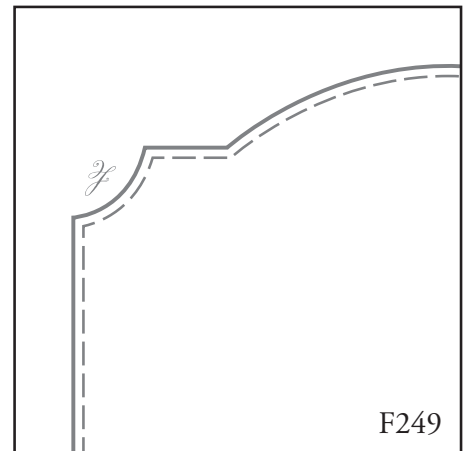

F249

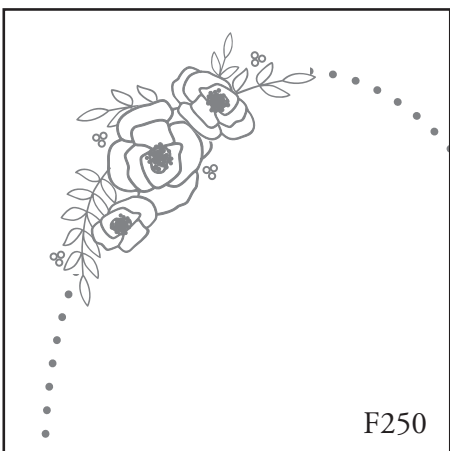

F250

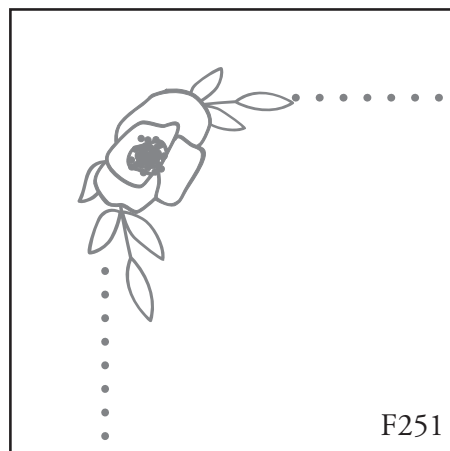

F251

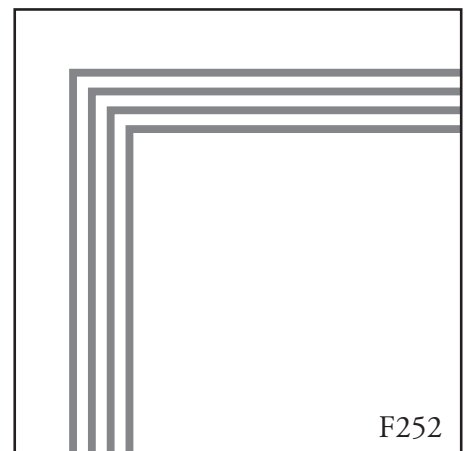

F252

# FRAMES

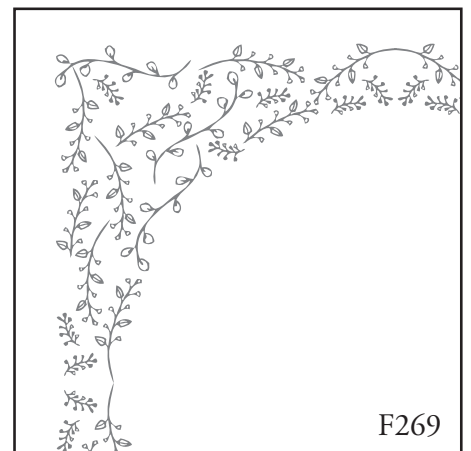
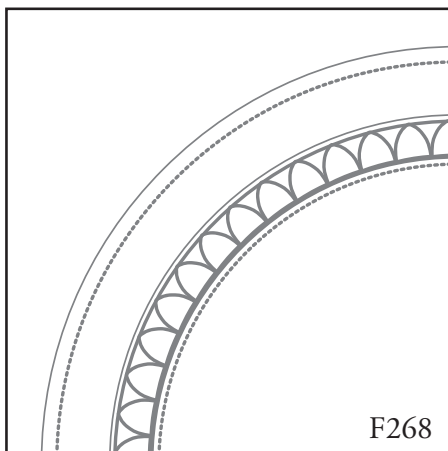
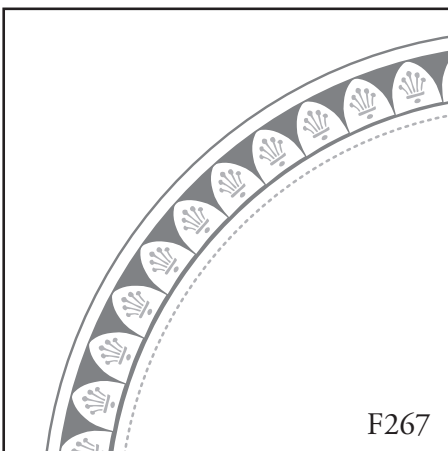
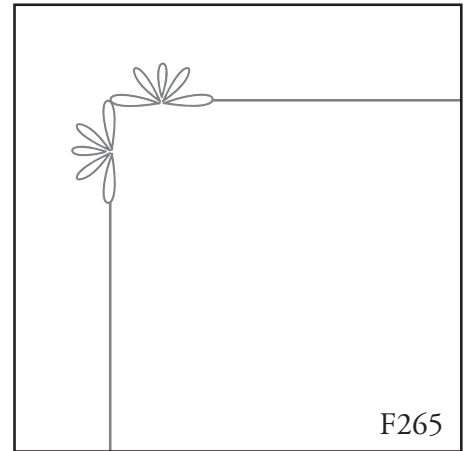
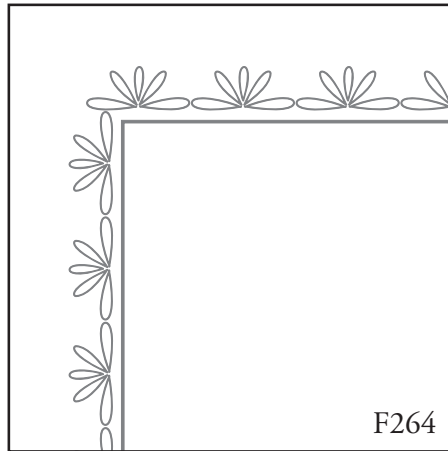
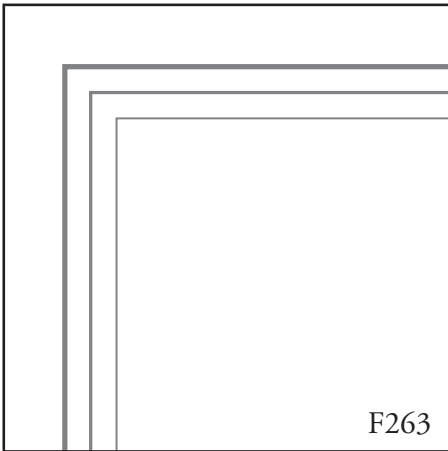
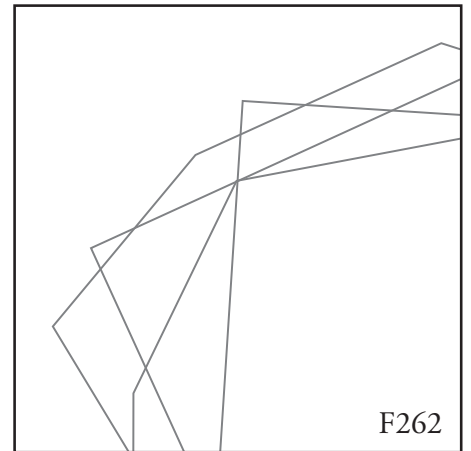
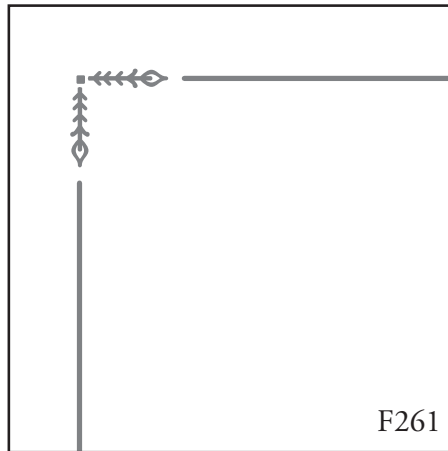
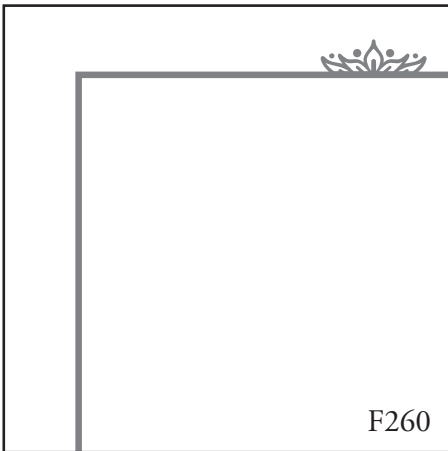
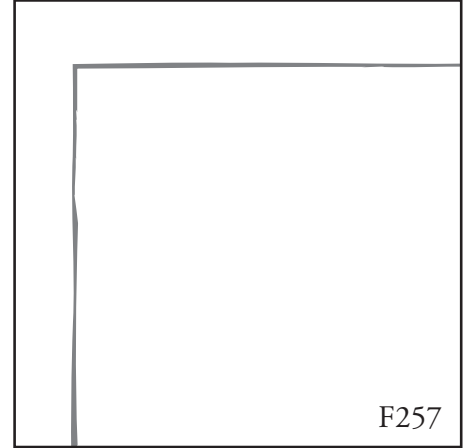
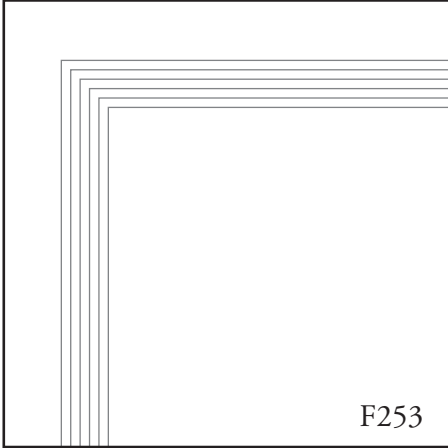

# FRAMES

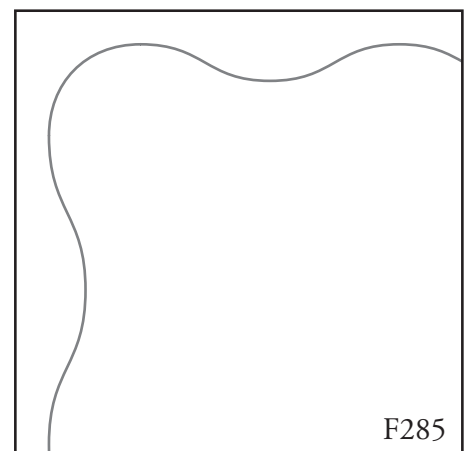
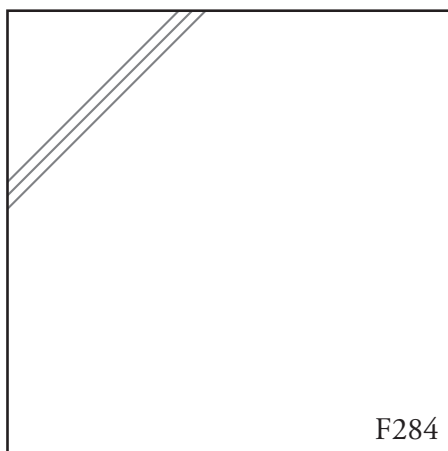
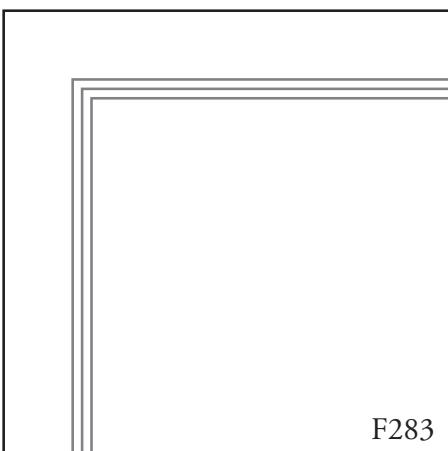
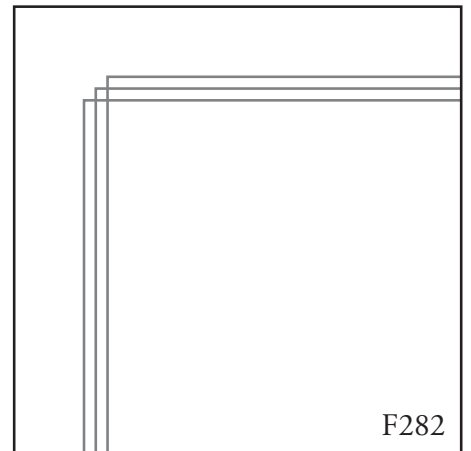
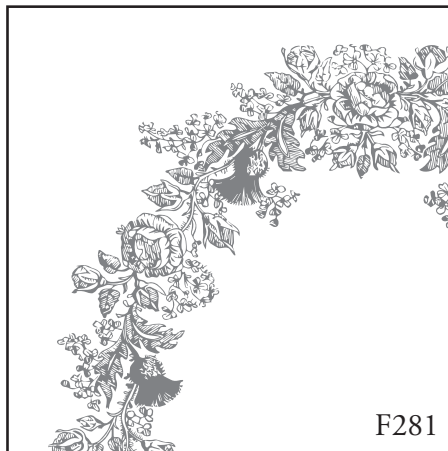
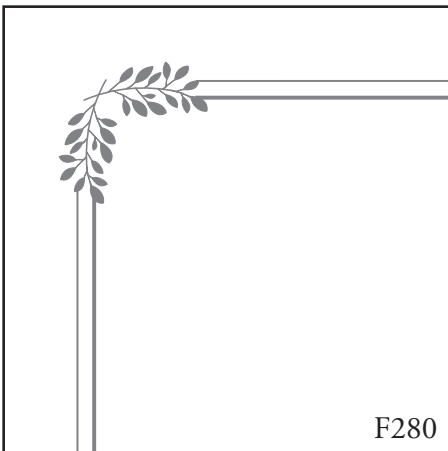
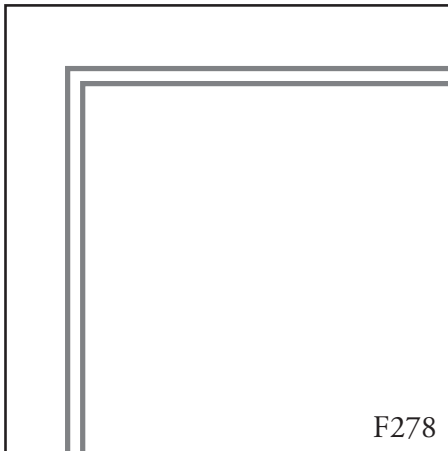
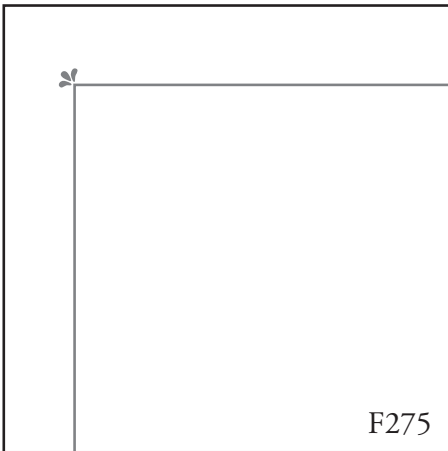
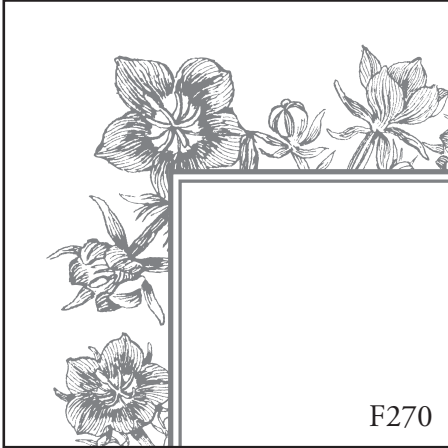

# FRAMES

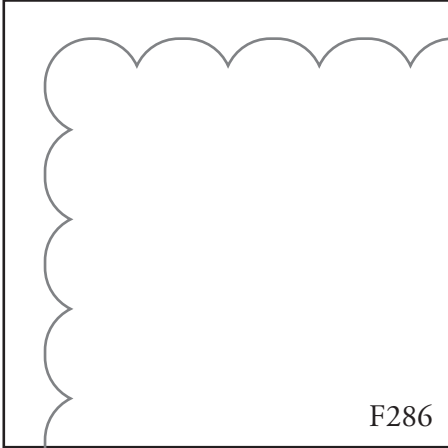

F286

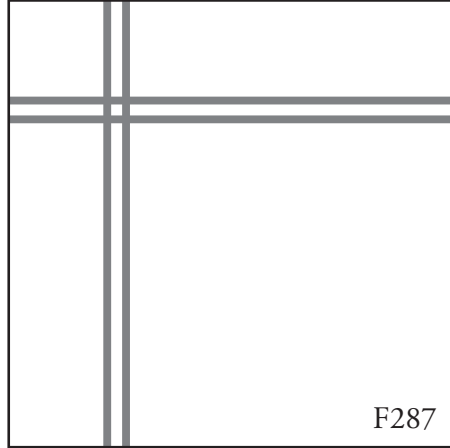

F287

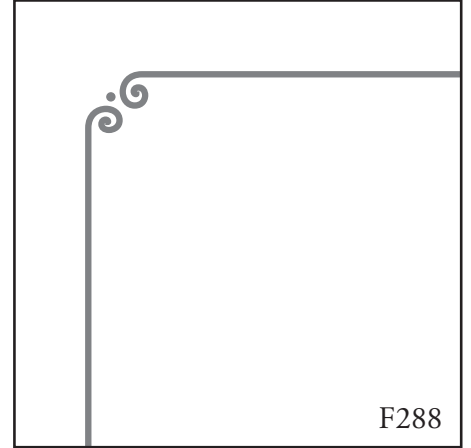

F288

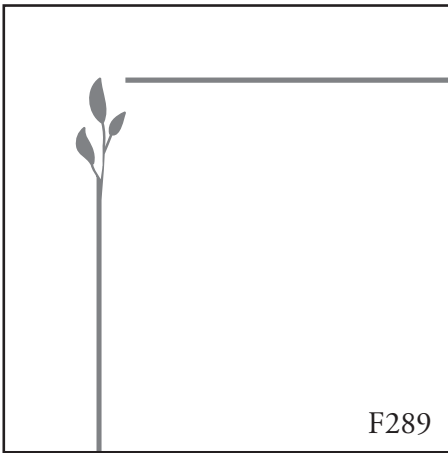

F289



F290



F291

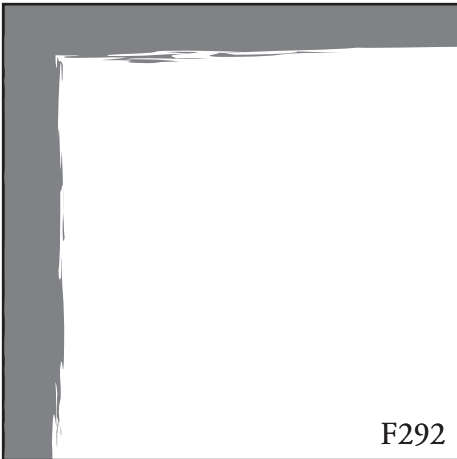

F292



F293