

CALL: (323) 245-5185

FAX: (818) 246-5188

EMAIL: orders@activewindowproducts.com



Model	Tahoe
Series	6900
Finishes	Adobe, Almond, Anodize, Black, Bronze, Tan & White
Type of Grille	Imperial Small Pattern Grille
Standard Sizes	30", 32", 36", 42"
Standard Screening	Fiberglass
Custom Options	Yes, see Pages 27 & 28 for Options
Min Custom Width	16"
Max Custom Width	60"
Max Custom Height	120"
Pet Door Installed	Yes

Model Specifications:

- 3/4" x 2-1/4" x .055 Extruded Frame
- Extruded Corner Locks w/ 4 Screws Per Corner
- 12" - .038 Embossed Kickplate
- 3—1" Extruded Push Bars
- 1-3/4" .050 Side & Bottom Adjustment Channel
- 3 Hinges Riveted to Channel
- Pull Handle Latch W/ Touch n' Go Closer Kit
- Protective Packaging



Model	La Jolla
Series	6300
Finishes	Adobe, Almond, Anodize, Black, Bronze & White
Type of Grille	Imperial Skipmesh Grille
Standard Sizes	30", 32", 36"
Standard Screening	Fiberglass
Custom Options	Yes, see Pages 27 & 28 for Options
Min Custom Width	16"
Max Custom Width	35-1/4"
Max Custom Height	120"
Pet Door Installed	Yes

Model Specifications:

- 3/4" x 2-1/4" x .055 Extruded Frame
- Extruded Corner Locks w/ 4 Screws Per Corner
- 12" - .038 Embossed Kickplate
- 3—1" Extruded Push Bars
- 1-3/4" .050 Side & Bottom Adjustment Channel
- 3 Hinges Riveted to Channel
- Pull Handle Latch W/ Touch n' Go Closer Kit
- Protective Packaging

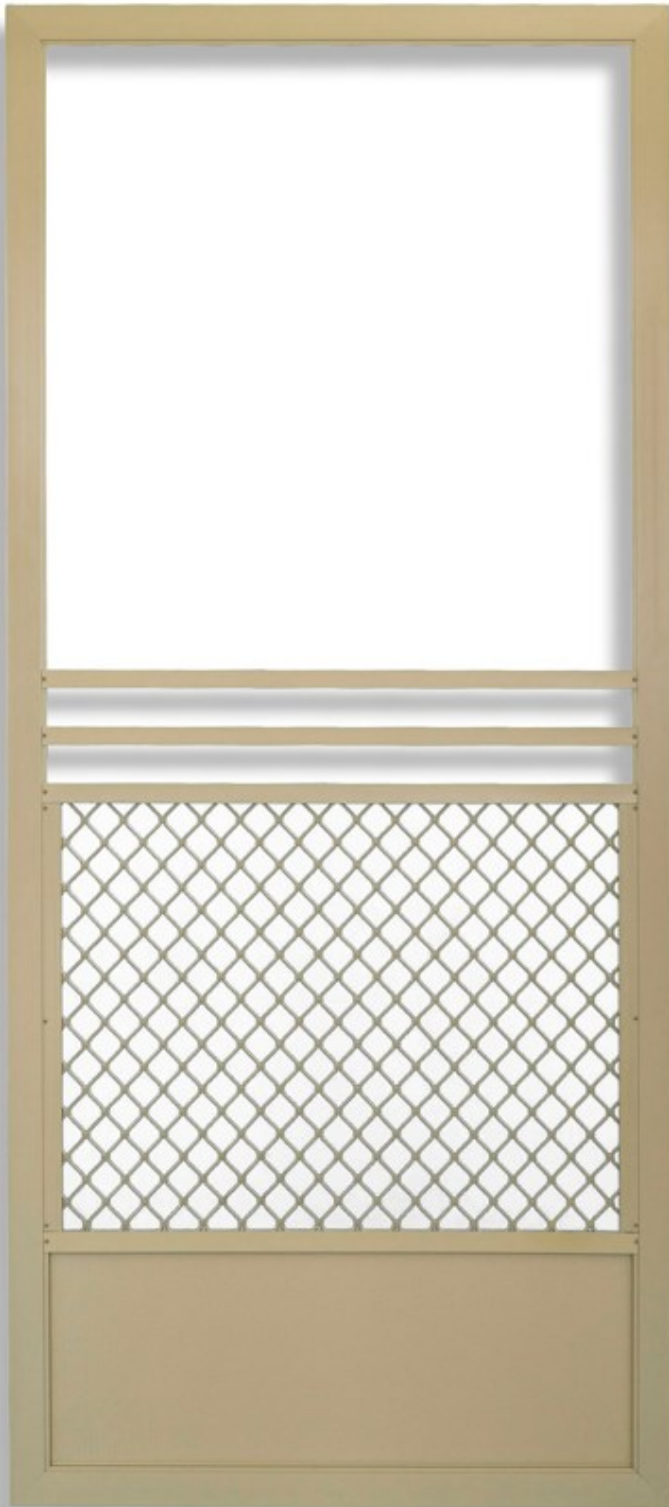

Model	Maverick
Series	7000
Finishes	Adobe, Almond, Anodize, Black, Bronze, Tan & White
Type of Grille	Amplimesh Grille, Plastic Grille Surround
Standard Sizes	30", 32", 36"
Standard Screening	Fiberglass
Custom Options	Yes, see Pages 27 & 28 for Options
Min Custom Width	Not Available
Max Custom Width	Not Available
Max Custom Height	Not Available
Pet Door Installed	Not Available

Model Specifications:

- 3/4" x 2-1/4" x .055 Extruded Frame
- Extruded Corner Locks w/ 4 Screws Per Corner
- 12" - .038 Embossed Kickplate
- 3—1" Extruded Push Bars
- 1-3/4" .050 Side & Bottom Adjustment Channel
- 3 Hinges Riveted to Channel
- Pull Handle Latch W/ Touch n' Go Closer Kit
- Protective Packaging

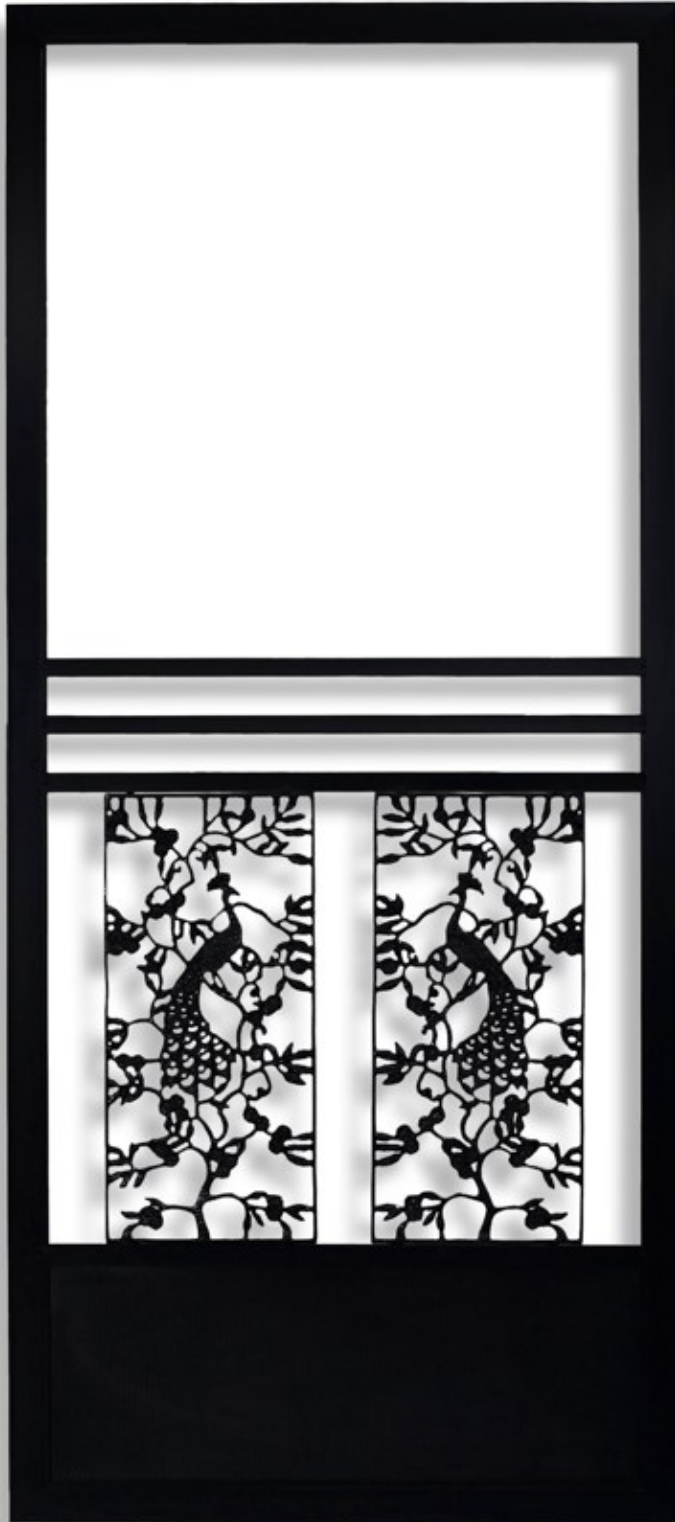

Model	El Dorado
Series	3900
Finishes	Adobe, Almond, Anodize, Black, Bronze, Tan & White
Type of Grille	Peacock Grilles
Standard Sizes	30", 32", 36", 42"
Standard Screening	Fiberglass
Custom Options	Yes, see Pages 27 & 28 for Options
Min Custom Width	26"
Max Custom Width	68"
Max Custom Height	120"
Pet Door Installed	Not Available

Model Specifications:

- 3/4" x 2-1/4" x .055 Extruded Frame
- Extruded Corner Locks w/ 4 Screws Per Corner
- 12" - .038 Embossed Kickplate
- 3—1" Extruded Push Bars
- 1-3/4" .050 Side & Bottom Adjustment Channel
- 3 Hinges Riveted to Channel
- Pull Handle Latch W/ Touch n' Go Closer Kit
- Protective Packaging

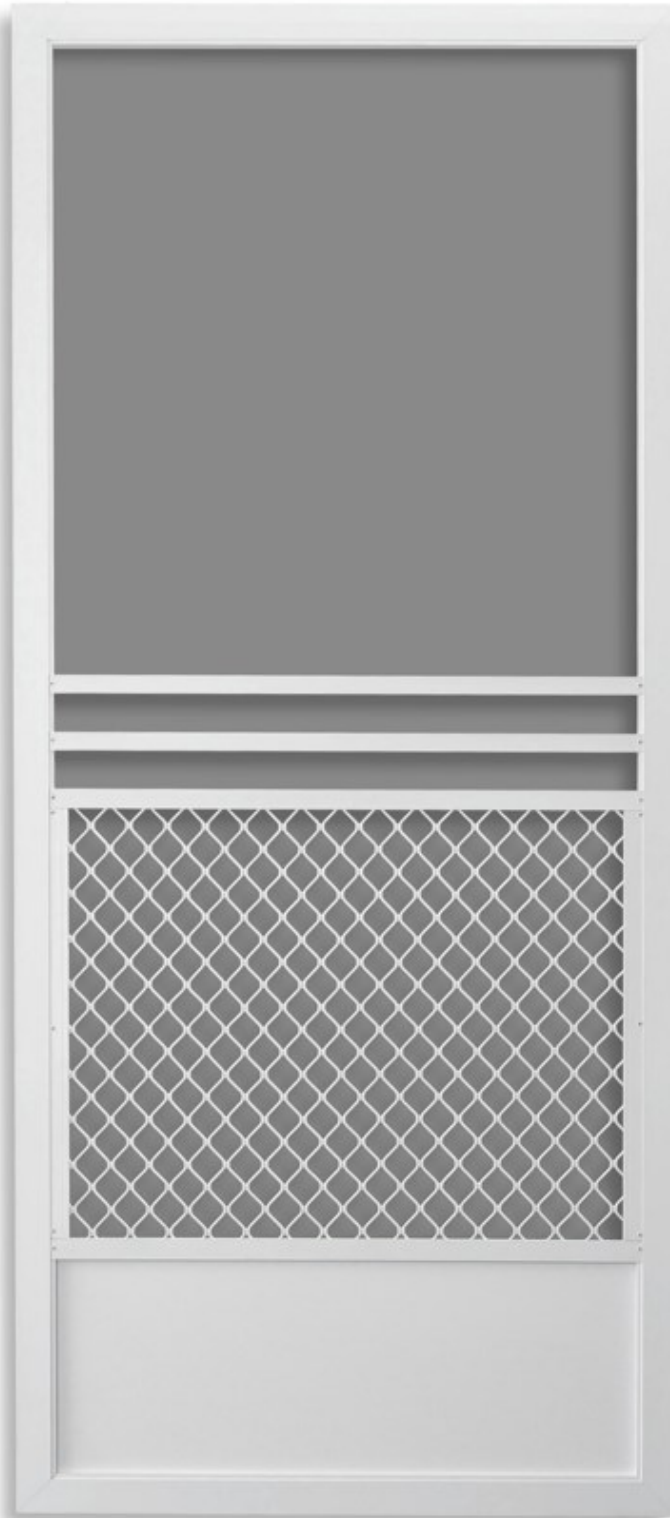

Model	Santa Fe
Series	6700
Finishes	Adobe, Almond, Anodize, Black, Bronze, Tan & White
Type of Grille	Amplimesh Grille, Metal Grille Surround
Standard Sizes	30", 32", 36", 42"
Standard Screening	Fiberglass
Custom Options	Yes, see Pages 27 & 28 for Options
Min Custom Width	16"
Max Custom Width	68" - Sizes Greater than 35-1/4", Grille Turned Sideways
Max Custom Height	120"
Pet Door Installed	Yes

Model Specifications:

- 3/4" x 2-1/4" x .055 Extruded Frame
- Extruded Corner Locks w/ 4 Screws Per Corner
- 12" - .038 Embossed Kickplate
- 3—1" Extruded Push Bars
- 1-3/4" .050 Side & Bottom Adjustment Channel
- 3 Hinges Riveted to Channel
- Pull Handle Latch W/ Touch n' Go Closer Kit
- Protective Packaging



Model	Full Santa Fe
Series	6800
Finishes	Adobe, Almond, Anodize, Black, Bronze, Tan & White
Type of Grille	Amplimesh Grille, Metal Grille Surround
Standard Sizes	30", 32", 36", 42"
Standard Screening	Fiberglass
Custom Options	Yes, see Pages 27 & 28 for Options
Min Custom Width	16"
Max Custom Width	68" - Sizes Greater than 35-1/4", Grille Turned Sideways
Max Custom Height	100" Height Over 79-1/4" Requires Add'l Kickplate
Pet Door Installed	Yes

Model Specifications:

- 3/4" x 2-1/4" x .055 Extruded Frame
- Extruded Corner Locks w/ 4 Screws Per Corner
- 12" - .038 Embossed Kickplate
- 3—1" Extruded Push Bars
- 1-3/4" .050 Side & Bottom Adjustment Channel
- 3 Hinges Riveted to Channel
- Pull Handle Latch W/ Touch n' Go Closer Kit
- Protective Packaging



Model	Protecto
Series	4400
Finishes	Adobe, Almond, Anodize, Black, Bronze, Tan & White
Type of Grille	Amplimesh Grille, Metal Grille Surround
Standard Sizes	30", 32", 36", 42"
Standard Screening	Fiberglass
Custom Options	Yes, see Pages 27 & 28 for Options
Min Custom Width	16"
Max Custom Width	68" - Sizes Greater than 35-1/4", Grille Turned Sideways
Max Custom Height	120"
Pet Door Installed	Yes

Model Specifications:

- 3/4" x 2-1/4" x .055 Extruded Frame
- Extruded Corner Locks w/ 4 Screws Per Corner
- 12" - .038 Embossed Kickplate
- 3—1" Extruded Push Bars
- 1-3/4" .050 Side & Bottom Adjustment Channel
- 3 Hinges Riveted to Channel
- Pull Handle Latch W/ Touch n' Go Closer Kit
- Protective Packaging

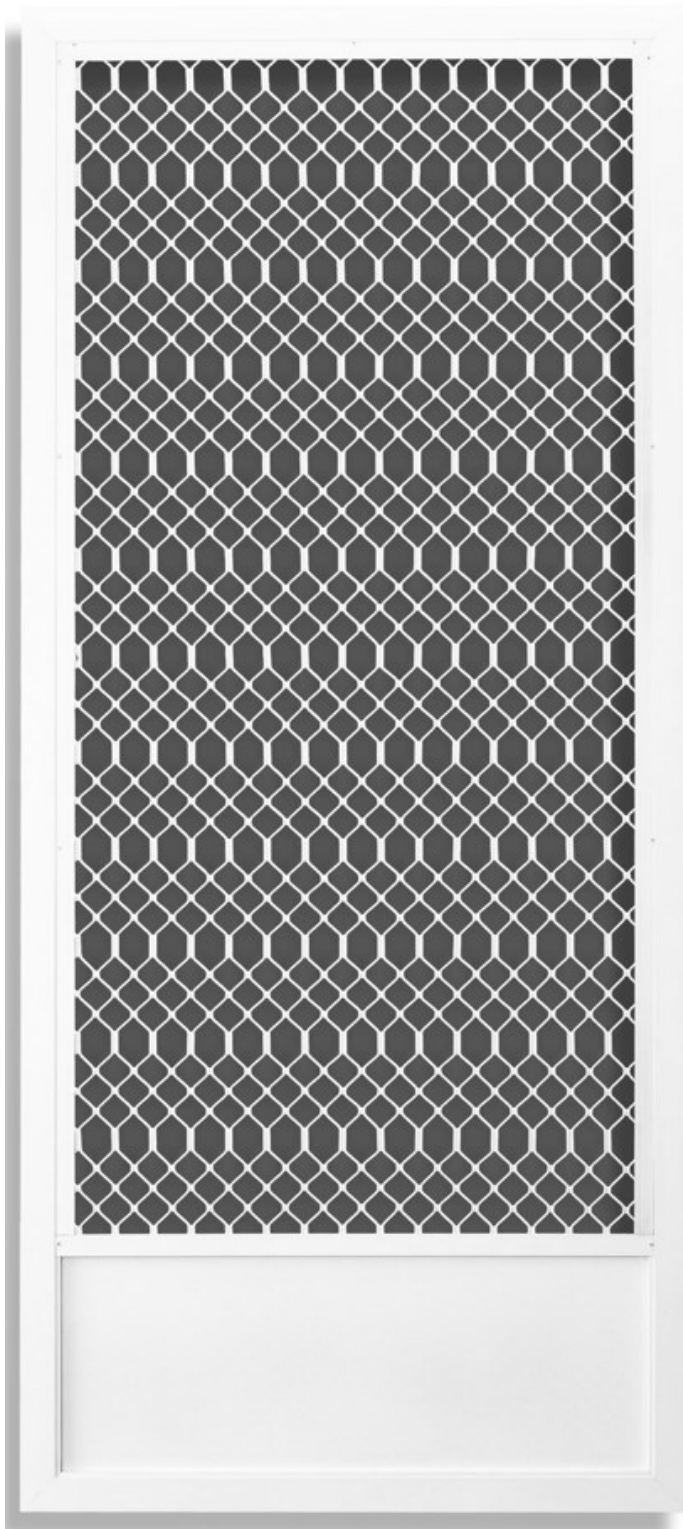

Model	Full Protecto
Series	4800
Finishes	Adobe, Almond, Anodize, Black, Bronze, Tan & White
Type of Grille	Amplimesh Grille, Metal Grille Surround
Standard Sizes	30", 32", 36", 42"
Standard Screening	Fiberglass
Custom Options	Yes, see Pages 27 & 28 for Options
Min Custom Width	16"
Max Custom Width	68" - Sizes Greater than 35-1/4", Grille Turned Sideways
Max Custom Height	100" Height Over 79-1/4" Requires Add'l Kickplate
Pet Door Installed	Yes

Model Specifications:

- 3/4" x 2-1/4" x .055 Extruded Frame
- Extruded Corner Locks w/ 4 Screws Per Corner
- 12" - .038 Embossed Kickplate
- 3—1" Extruded Push Bars
- 1-3/4" .050 Side & Bottom Adjustment Channel
- 3 Hinges Riveted to Channel
- Pull Handle Latch W/ Touch n' Go Closer Kit
- Protective Packaging



Model	Vista
Series	4500
Finishes	Adobe, Almond, Anodize, Black, Bronze, Tan & White
Type of Grille	None
Standard Sizes	30", 32", 36", 42"
Standard Screening	Fiberglass
Custom Options	Yes, see Pages 27 & 28 for Options
Min Custom Width	16"
Max Custom Width	68"
Max Custom Height	120"
Pet Door Installed	Yes—Kickplate Will Match Height of Kickplate

Model Specifications:

- 3/4" x 2-1/4" x .055 Extruded Frame
- Extruded Corner Locks w/ 4 Screws Per Corner
- 4" - .038 Embossed Kickplate
- 1-3/4" .050 Side & Bottom Adjustment Channel
- 3 Hinges Riveted to Channel
- Pull Handle Latch W/ Touch n' Go Closer Kit
- Protective Packaging

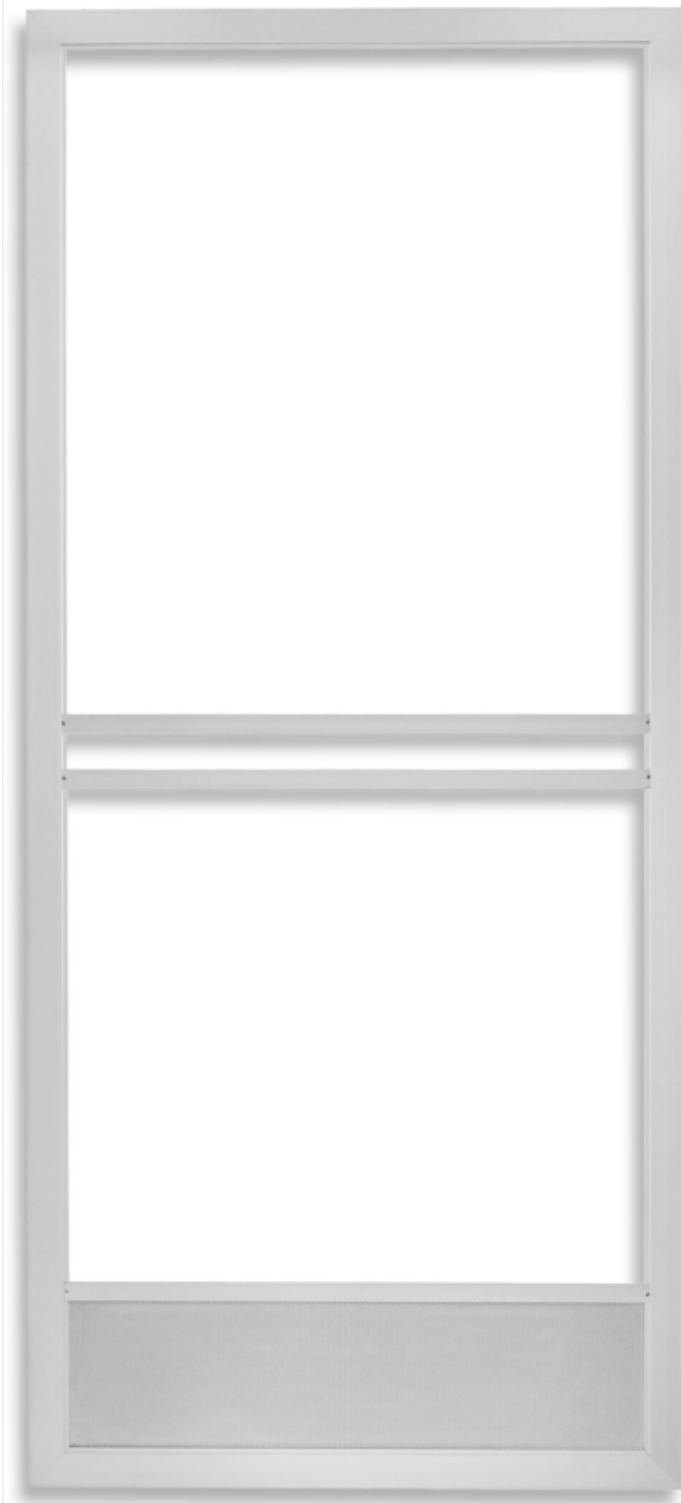

Model	Model E
Series	6000
Finishes	Adobe, Almond, Anodize, Black, Bronze, Tan & White
Type of Grille	None
Standard Sizes	30", 32", 36", 42"
Standard Screening	Fiberglass
Custom Options	Yes, see Pages 27 & 28 for Options
Min Custom Width	16"
Max Custom Width	68"
Max Custom Height	120"
Pet Door Installed	Yes

Model Specifications:

- 3/4" x 2-1/4" x .055 Extruded Frame
- Extruded Corner Locks w/ 4 Screws Per Corner
- 9" - .038 Embossed Kickplate
- 2—1" Extruded Push Bars
- 1-3/4" .050 Side & Bottom Adjustment Channel
- 3 Hinges Riveted to Channel
- Pull Handle Latch W/ Touch n' Go Closer Kit
- Protective Packaging

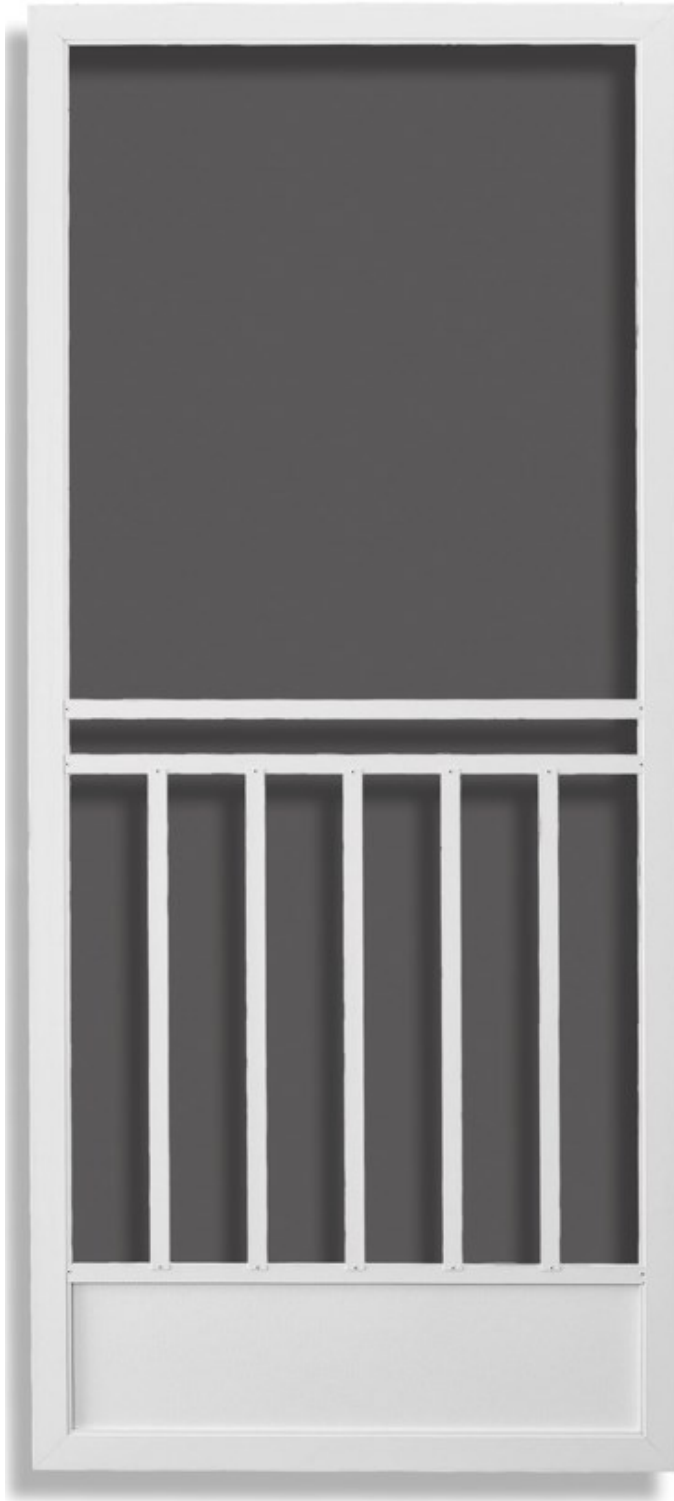

Model	Craftsman
Series	4700
Finishes	Adobe, Almond, Anodize, Black, Bronze, Tan & White
Type of Grille	1" Extruded Push Bar Patter (shown) is Standard for All Sizes
Standard Sizes	30", 32", 36", 42"
Standard Screening	Fiberglass
Custom Options	Yes, see Pages 27 & 28 for Options
Min Custom Width	23-1/4"
Max Custom Width	68"
Max Custom Height	120"
Pet Door Installed	Yes

Model Specifications:

- 3/4" x 2-1/4" x .055 Extruded Frame
- Extruded Corner Locks w/ 4 Screws Per Corner
- 9" - .038 Embossed Kickplate
- 1-3/4" .050 Side & Bottom Adjustment Channel
- 3 Hinges Riveted to Channel
- Pull Handle Latch W/ Touch n' Go Closer Kit
- Protective Packaging

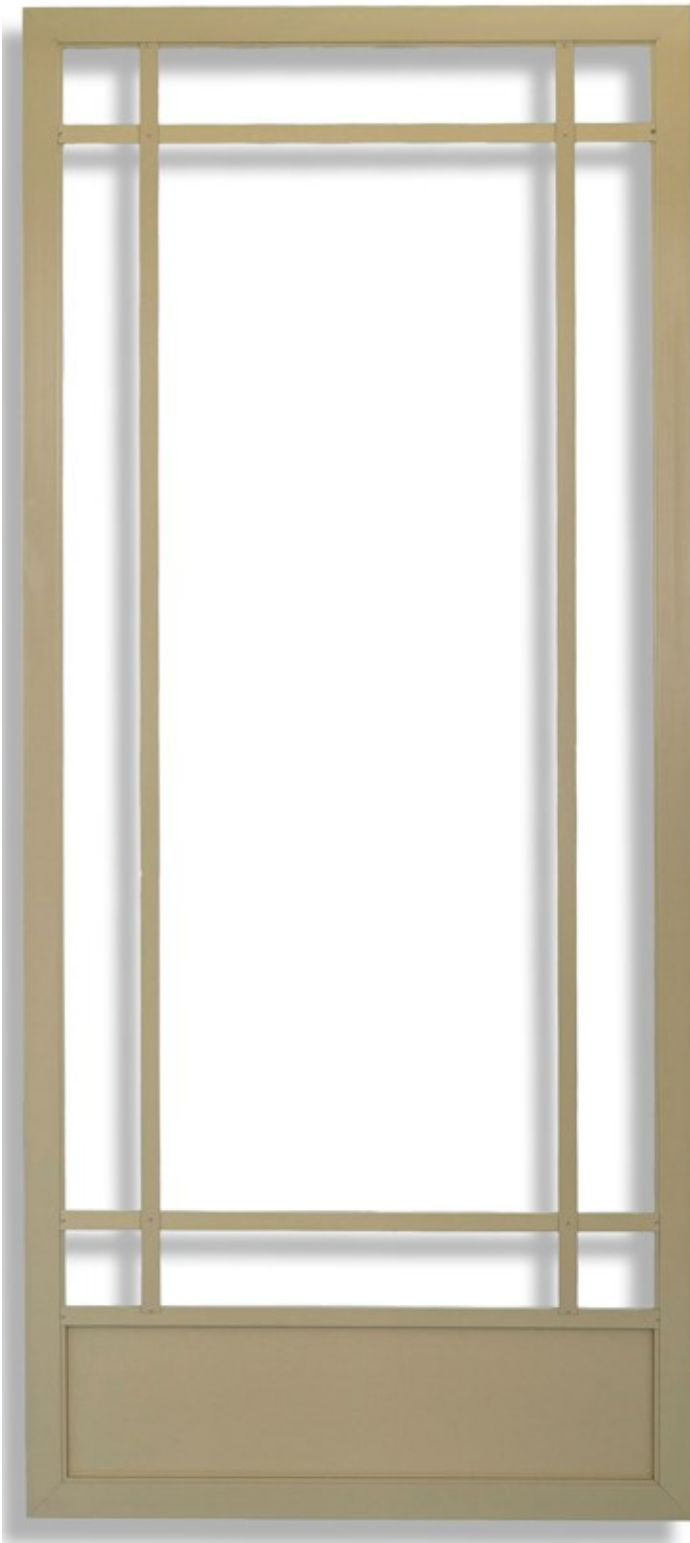

Model	Prairie 9-Lite
Series	4600
Finishes	Adobe, Almond, Anodize, Black, Bronze, Tan & White
Type of Grille	1" Extruded Push Bar Grille 9-Lite (shown) is Standard for All Sizes
Standard Sizes	30", 32", 36", 42"
Standard Screening	Fiberglass
Custom Options	Yes, see Pages 27 & 28 for Options
Min Custom Width	16"
Max Custom Width	68"
Max Custom Height	120"
Pet Door Installed	Yes

Model Specifications:

- 3/4" x 2-1/4" x .055 Extruded Frame
- Extruded Corner Locks w/ 4 Screws Per Corner
- 9" - .038 Embossed Kickplate
- 1-3/4" .050 Side & Bottom Adjustment Channel
- 4" DLO (Daylight Opening)
- 3 Hinges Riveted to Channel
- Pull Handle Latch W/ Touch n' Go Closer Kit
- Protective Packaging



Model	Cape Cod
Series	6500
Finishes	Adobe, Almond, Anodize, Black, Bronze, Tan & White
Type of Grille	1" Extruded Push Bar Grille Divided 15 Lite Pattern (shown) for all
Standard Sizes	30", 32", 36", 42"
Standard Screening	Fiberglass
Custom Options	Yes, see Pages 27 & 28 for Options
Min Custom Width	16"
Max Custom Width	68"
Max Custom Height	120"
Pet Door Installed	Yes

Model Specifications:

- 3/4" x 2-1/4" x .055 Extruded Frame
- Extruded Corner Locks w/ 4 Screws Per Corner
- 9" - .038 Embossed Kickplate
- 1-3/4" .050 Side & Bottom Adjustment Channel
- 3 Hinges Riveted to Channel
- Pull Handle Latch W/ Touch n' Go Closer Kit
- Protective Packaging



Model	Giant
Series	5700
Finishes	Adobe, Almond, Anodize, Black, Bronze, Tan & White
Type of Grille	None
Standard Sizes	30", 32", 36", 42"
Standard Screening	Fiberglass
Custom Options	Yes, see Pages 27 & 28 for Options
Min Custom Width	16"
Max Custom Width	68"
Max Custom Height	120"
Pet Door Installed	Yes

Model Specifications:

- 1" x 2-1/2" x .062 Extruded Frame
- Extruded Corner Locks w/ 4 Screws Per Corner
- 12" - .038 Embossed Kickplate
- 1-3/4" .062 Side & Bottom Adjustment Channel
- 3 Hinges Riveted to Channel
- Pull Handle Latch W/ Touch n' Go Closer Kit
- Protective Packaging

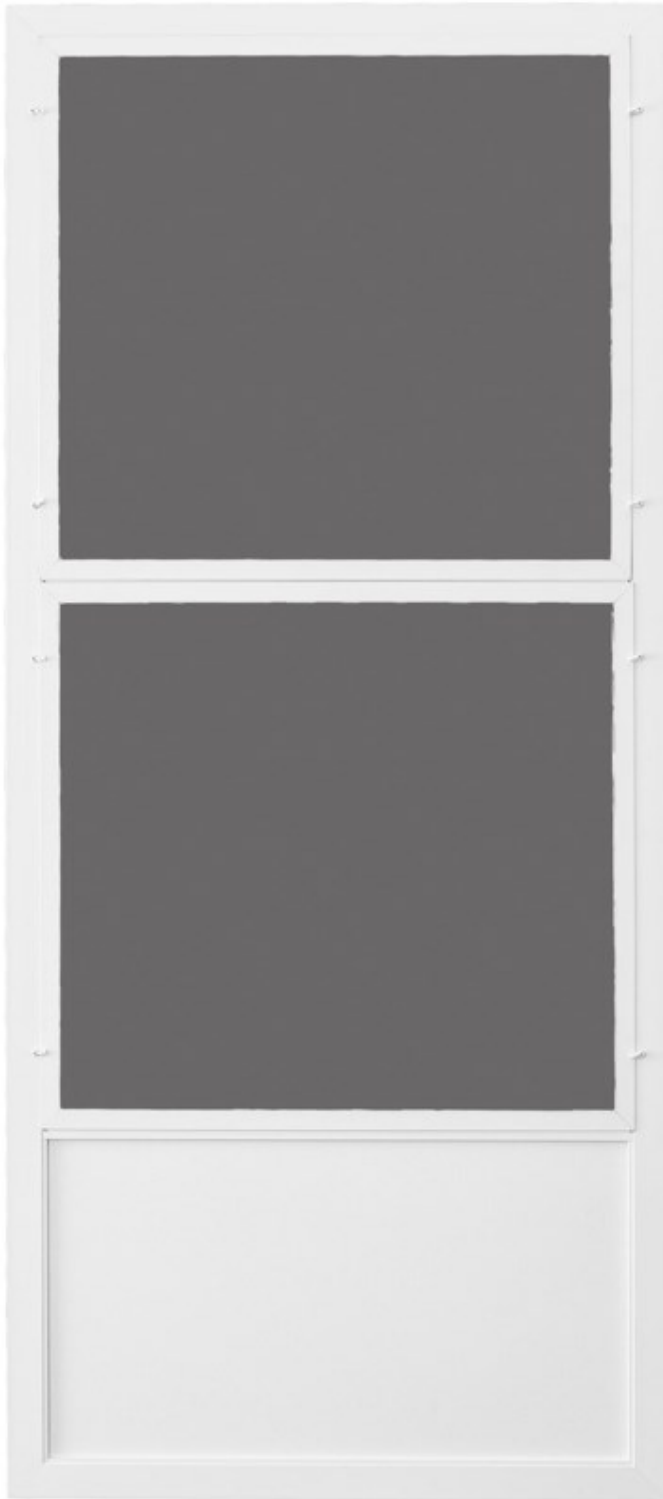

Model	Combo
Series	5100
Finishes	Adobe, Almond, Anodize, Black, Bronze, Tan & White
Type of Grille	None
Standard Sizes	30", 32", 36"
Standard Screening	Fiberglass
Custom Options	Yes, see Pages 27 & 28 for Options
Min Custom Width	16"
Max Custom Width	68"
Max Custom Height	120"
Pet Door Installed	Yes

Model Specifications:

- 3/4" x 2-1/4" x .055 Extruded Frame
- Removable Tempered Glass Panels
- Extruded Corner Locks w/ 4 Screws Per Corner
- 18" - .038 Embossed Kickplate
- 1-3/4" .050 Side & Bottom Adjustment Channel
- 3 Hinges Riveted to Channel
- Pull Handle Latch W/ Heavy Duty Closer Kit
- Protective Packaging



Model/Series	Olympia Full 5500 Olympia Jr. 5600
Finishes	Adobe, Almond, Anodize, Black, Bronze, Tan & White
Standard Sizes	30", 32", 36", 42"
Standard Screening	Fiberglass
Custom Options	Yes, see Pages 27 & 28 for Options
Min Custom Width	16"
Max Custom Width	68"
Max Custom Height	120"
Pet Door Installed	Yes

Model Specifications:

- 1" x 2-1/2" x .062 Extruded Frame
- Extruded Corner Locks w/ 4 Screws Per Corner
- Kickplate: 14-3/4" on Oly Full, 36" on Oly Jr.
- 1-3/4" .062 Side & Bottom Adjustment Channel W/ Weatherstrip
- 3 Hinges Riveted to Channel
- Clear Glass Only
- Pull Handle Latch W/ Heavy Duty Air Closer Kit
- Cylinders Keyed Alike on Request
- Specify Handle Side
- **Olympia Full Features:**
- 2 Vertical Sliding Tempered Glass Panels 29" High, Embossed Kickplate
- **Olympia Jr. Features:**
- 2 Vertical Sliding Tempered Glass Panels 18-1/2" High, 2 Embossed Kickplates
- Protective Packaging



Model	Sentry
Series	4900
Finishes	Adobe, Almond, Anodize, Black, Bronze, Tan & White
Type of Grille	Heavy Duty Extruded 1/4" "Sentry" Amplimesh
Standard Sizes	30", 32", 36", 42"
Standard Screening	Fiberglass
Custom Options	Yes, see Pages 27 & 28 for Options
Min Custom Width	16"
Max Custom Width	49"
Max Custom Height	101"
Pet Door Installed	Yes

Model Specifications:

- 7/8" x 2-7/8" x .060 Extruded Frame
- Extruded Corner Locks w/ 2 Screws Per Corner
- 1-7/8" Side & Bottom Adjustment Channels
- 3 Hinges Riveted to Channel
- Heavy Duty Air Closer
- Lever Handle w/1" Deadbolt & Single Key Cylinder
- Cylinders Keyed Alike on Request @ an Extra Charge
- Protective Packaging



Model	Gibraltar
Series	5000
Finishes	Adobe, Almond, Anodize, Black, Bronze, Tan & White
Type of Grille	Heavy Duty Extruded 1/4" "Gibraltar" Amplimesh
Standard Sizes	30", 32", 36"
Standard Screening	Fiberglass
Custom Options	Yes, see Pages 27 & 28 for
Min Custom Width	16"
Max Custom Width	35-1/4"
Max Custom Height	101"
Pet Door Installed	Yes

Model Specifications:

- 7/8" x 2-7/8" x .060 Extruded Frame
- Extruded Corner Locks w/ 2 Screws Per Corner
- 1-7/8" Side & Bottom Adjustment Channels
- 3 Hinges Riveted to Channel
- Heavy Duty Air Closer
- Lever Handle w/1" Deadbolt & Single Key Cylinder
- Cylinders Keyed Alike on Request @ an Extra Charge
- Protective Packaging

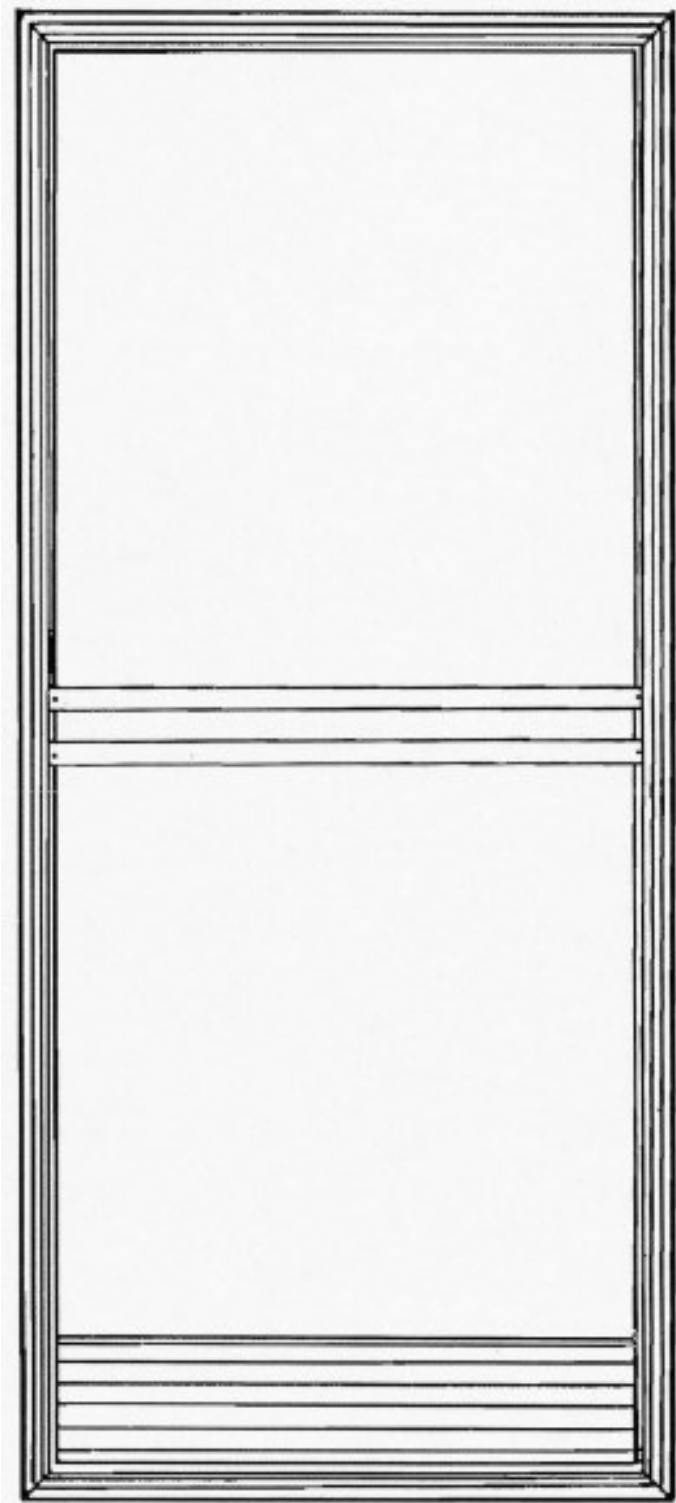

Model	R-32
Series	1600
Finishes	Mill Finish
Type of Grille	None
Standard Sizes	30", 32", 36", 42"
Standard Screening	Fiberglass
Custom Options	Yes, see Pages 27 & 28 for Options
Min Custom Width	16"
Max Custom Width	80"
Max Custom Height	84"
Pet Door Installed	No

Model Specifications:

- 3/4" x 2-1/8" x .032 Roll Formed Frame
- 4 Diecast Insert Corners
- 7" Wireable Kickplate
- 1-1/4" Pushbars (2)
- 1-5/8" Side & Bottom Adjustment Channels
- 2 Hinges Riveted to Channel
- Pull Handle Latch W/ Touch n' Go Closer Kit
- Protective Packaging

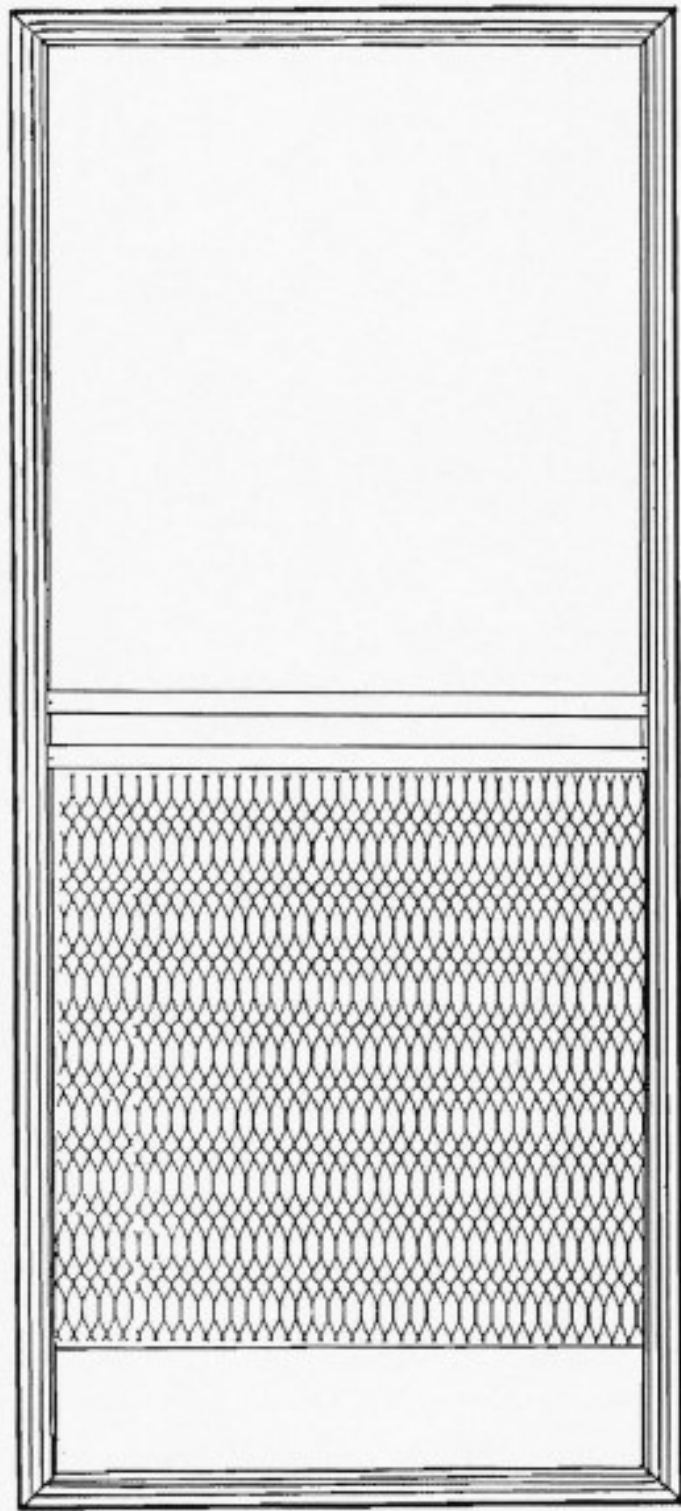

Model	Electra
Series	1900
Finishes	Mill Finish
Type of Grille	Apollo Large Pattern Expanded Metal Grille w/ Plastic Grille Surround
Standard Sizes	30", 32", 36", 42"
Standard Screening	Fiberglass
Custom Options	Yes, see Pages 27 & 28 for
Min Custom Width	16"
Max Custom Width	42" Standard
Max Custom Height	84"
Pet Door Installed	No

Model Specifications:

- 3/4" x 2-1/8" x .032 Roll Formed Frame
- 4 Diecast Insert Corner s
- 7" Wireable Kickplate
- 1-1/4" Pushbars (2)
- 1-5/8" Side & Bottom Adjustment Channels
- 2 Hinges Riveted to Channel
- Pull Handle Latch W/ Touch n' Go Closer Kit
- Protective Packaging



Installation Instructions and Warranty

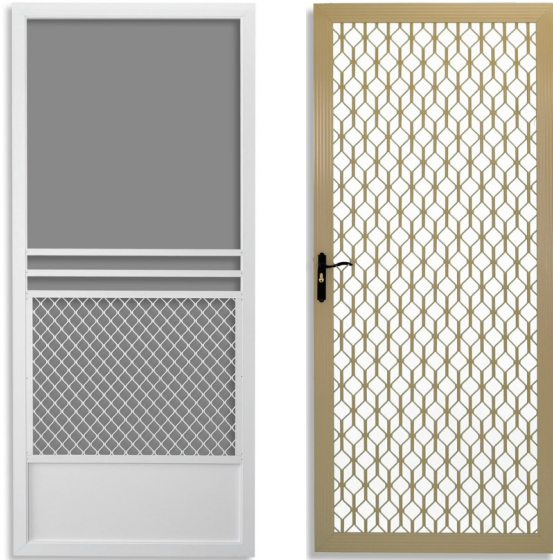

Before installing your new screen door check sizes below to make sure door will fit your opening

Standard Door Sizes

Nominal Size	Net Size	Fits Openings in Width	Fits Openings in Height
30" x 80"	29-1/4" x 79-3/4"	29-5/8" to 30-1/2"	80" to 81"
32" x 80"	31-1/4" x 79-3/4"	31-5/8" to 32-1/2"	80" to 81"
36" x 80"	35-1/4" x 79-3/4"	35-5/8" to 36-1/2"	80" to 81"
42" x 80"	41-1/4" x 79-3/4"	41-5/8" to 42-1/2"	80" to 81"

To the original purchaser, Active Window Products warrants this product and its components parts to be free of defects in materials and workmanship for a period of one year from the date of purchase.

Damage caused by accident, improper installation or abuse, including but not limited to damage caused by pets is specifically excluded from this warranty. Manufacturer's liability on any claim shall not exceed the cost of the product. In no instance shall manufacturer be responsible for consequential damage resulting from the use of this product. This warranty replaces any and all previous warranties, either written, oral or implied and is the only warranty made by this company. This warranty gives you specific legal rights. You may have other rights which vary from state to state.

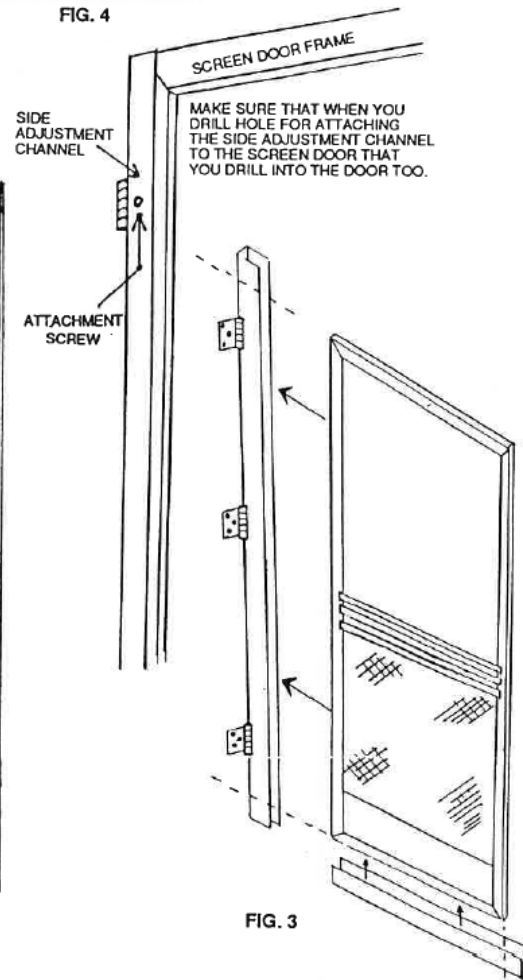
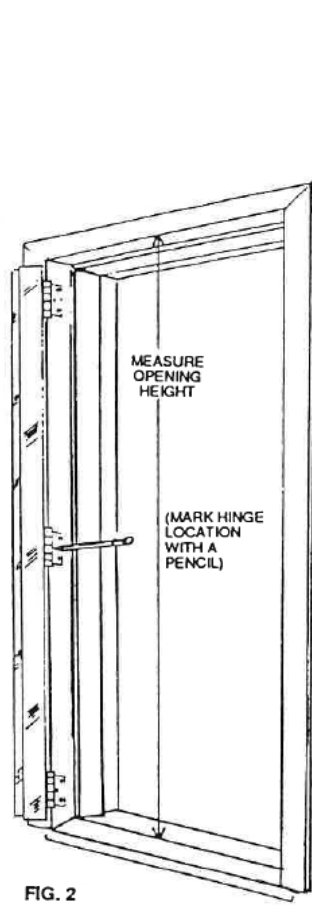
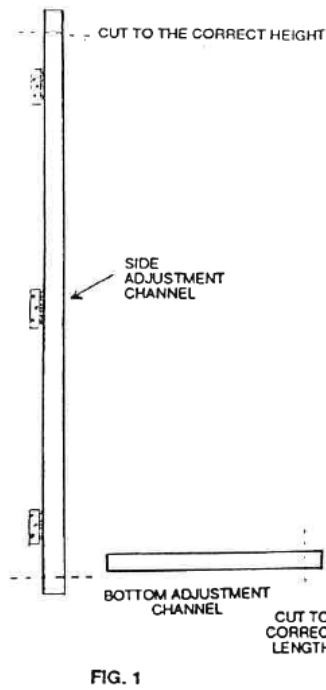

Tools Needed: Drill w/ 1/8" & 5/16" bits, Phillips screwdriver, hammer, hacksaw, tape measure, pencil, file, step stool or ladder.

- #1—Determine if the side channel will be on the left or right side (from outside). Place door into opening to make sure it will fit correctly.
- #2—Measure opening height where the side adjustment channel is be installed. Deduct 1/8"-3/16". If opening is 80", make cut to 79-7/8". (See FIG. #1)
- #3—Position the side adjustment channel into the opening where it will be installed. Allow approximately 1/16" inch clearance between top of the side adjustment channel and wood frame. Hold the side adjustment channel in place and mark through hinge screw holes with a pencil. (See FIG. #2)
- #4—Using 1/8" drill bit, drill holes where you marked.
- #5—Attach side adjustment channel to wood frame using the 9 large (#9x1") screws provided with the hardware pack.
- #6—Carefully slide the screen door, making sure grille is to the outside, into the side adjustment channel. Note: Door will be easier to slip in if you insert one corner first and then ease the rest of the door into the channel. Allow approximately 1/8"-3/16" on the latch side of the door (See FIG. #3)
- #7—Try opening and closing several times to make sure that everything clears. When you are sure that the door is in the proper position with no rubbing or binding, drill two 1/8" holes through the side adjustment channel and screen door frame. These holes should be even with the top and bottom hinge and about 1/2" from the edge. Attach the side adjustment channel to the door using 2 of the 6 small (#8x3/8") screws. Repeat procedure on the inside of the door (See FIG. #4)
- #8—Measure the width of the door from the latch side to the edge of the side adjustment channel. Cut the bottom adjustment channel to this measurement. Smooth any rough edges with the file. (See FIG. #1)
- #9—Insert the vinyl sweep into and slide the bottom adjustment channel onto the bottom of the door. (Note that vinyl sweep should be to the outside). Adjust the bottom adjustment channel so the viny sweep barely touches the threshold. Drill two 1/8" holes approximately 6" from each end and attach to the door with 2 of the small (#8x3/8") screws. (See FIG. #3)
- #10—Install latch following instructions included with the hardware kit. NOTE: BEFORE DRILLING FOR LATCH, MAKE SURE IT WILL NOT HIT AGAINST YOUR HOUSE DOOR KNOB!!!

1. MEASURING

A. Determine where door is to be installed

1. With entry door closed, determine how far door now sticks out
 - A. Is there a need to add a wood stop?
 - B. Is there a need to use a jamb extender?
 - C. Is there a need to rebuild or add a whole new frame?

B. Measure at the previously determined location.

1. Always measure width x height
2. Some doors are handed and require identification
 - A. Always from the outside
 - B. Position of handle—left or right
3. Punching/slotting for handle placement on security & combination doors is dead center
 - A. Note diagram for position of deadbolt and door handle for security & combination doors
 - B. If special placement is desired, state measurement from top of door to center line of handle and which side the handle is on

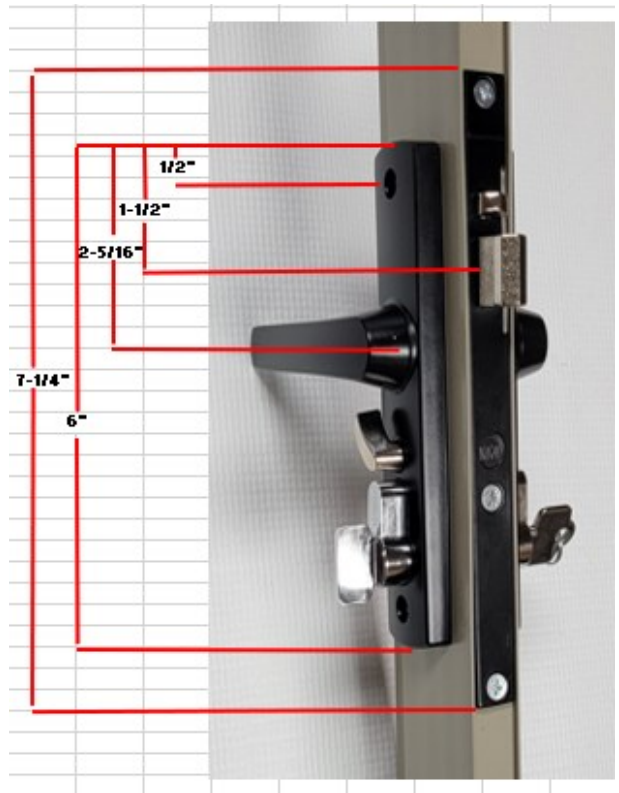

2. ORDERING

A. Standard Doors

1. 30", 32", 36" & 42"x80" are considered standard
 - A. These doors measure 29-1/4", 31-1/4", 35-1/4" & 41-1/4" x 79-3/4"
 - B. The openings these door fit are as follows:
29-5/8" - 30-1/2"; 31-5/8" - 32-1/2"; 35-5/8"-36-1/2" & 41-5/8"-42-1/2" x 80"-81"
2. Order these doors by series number, color and size

B. Special Doors

1. After determining opening size, deductions of 3/4" off width and 1/2" off height should be made to yield the "Net Door Size"
2. Active Window accepts orders for special door in the "Net Door Size" only
 - A. Never mix standard width with NET Height or NET width with standard height
 - B. If width or height is standard, call out the size in NET inches

C. Double Doors

1. After determining opening size, divide the opening into 2 equal parts & address each half (door) as a separate opening
2. Make deductions as stated about to each half (door) and order 2 door at those NET dimensions.



3. Special doors should be ordered following the same format as used for standard doors

- A. Series, Number, Color and S (special)**
- B. The NET door size, after allowances, should be given**
- C. Type of screen cloth**
- D. Any other special customization (delete pushbar, kickplate height, etc.)**
- E. Handing and handle placement applicable to security and combination doors**
- F. To order special height kickplates, measure from bottom of door to top of kickplate holder (Absolute minimum height is 6")**

3. INSTALLING THE DOOR—for detailed instructions see Section 10, page 22

A. Mounting hinged channel

- 1. Cut hinged channel 1-8"-3/16" smaller than opening**
- 2. Average the play between top and bottom and mount with screws**

B. Adjusting the screen door

- 1. Insert door into mounted hinged channel**
- 2. Adjust door to top of hinged channel and approximately 1/8"-3/16" from opening opposite from hinges (This should leave a space approximately 1/8" from side to side)**

C. Mounting bottom channel

- 1. Butt bottom channel up against hinge channel under door and cut length to match adjusted door**
- 2. Install channel and adjust down to threshold**
- 3. Drill and install the set screws**

D. Installing lock and closer

- 1. Using the template found in the hardware kit, follow the printed instructions to drill and install the handle assembly**
- 2. Using the instructions in the hardware kit, mount and adjust the closer**

SCREEN DOORS

FINISH CODES: A = Anodized, AD = Adobe, AL = Almond, B = Black, GR = Gray, M = Mill Finish, T = Tan, W = White & Z = Bronze

Series Number	PG. NO.	DESCRIPTION	FINISH	1-11	12-24	25 & OVER
---------------	---------	-------------	--------	------	-------	-----------

ROLL FORMED SCREEN DOORS - 30", 32", 36"

1600	19	R-32	M	126.36	122.30	118.31
1900	20	ELECTRA	M	162.67	154.75	149.59

EXTRUDED SCREEN DOORS - 30", 32", 36"

3900	4	EL DORADO	A,AD,AL,B,T,W,Z	238.04	225.63	221.20
4400	7	PROTECTO	A	277.43	257.78	252.70
			AD,AL,B,T,W,Z	294.37	273.59	268.17
4500	9	VISTA	A	163.86	153.76	150.61
			AD,AL,B,T,W,Z	179.13	168.12	164.69
4600	12	PRAIRIE	A	180.47	166.72	159.57
			AD,AL,B,T,W,Z	196.82	181.82	174.03
4700	11	CRAFTSMAN	A	180.69	166.92	159.76
			AD,AL,B,T,W,Z	197.05	182.04	174.23
4800	8	PROTECTO FULL	A	427.99	396.70	391.23
			AD,AL,B,T,W,Z	438.10	406.52	401.01
5700	14	GIANT	A	191.82	178.49	174.30
			M	178.27	165.17	160.58
			B,AD,T,W,Z	219.32	206.51	202.32
6000	10	MODEL "E"	A	163.86	153.76	150.61
			M	150.20	140.96	138.10
			AD,AL,B,T,W,Z	179.13	168.12	164.69
6300	2	LA JOLLA	A,AD,AL,B,T,W,Z	214.60	201.91	197.67
6500	13	CAPE COD	A	180.69	166.92	159.76
			AD,AL,B,T,W,Z	197.05	182.04	174.23
6700	5	SANTA FE	A	255.11	237.04	232.36
			AD,AL,B,T,W,Z	270.68	251.58	246.59
6800	6	SANTA FE FULL	A	402.85	373.81	368.74
			AD,AL,B,T,W,Z	402.85	373.81	368.74
6900	1	TAHOE	A	197.11	182.65	177.86
			M	179.01	164.42	159.88
			AD,AL,B,T,W,Z	204.28	188.89	184.41
7000	3	MAVERICK	A	149.64	149.64	149.64
			AD,AL,B,W,Z	149.64	149.64	149.64

For Standard 42" Doors: Call For Quote

N/A= Not Available in 42"

STORM & KEYED LOCK DOORS

FINISH CODES: A = Anodized, AD = Adobe, AL = Almond, B = Black, GR = Gray, M = Mill Finish,
T = Tan, W = White & Z = Bronze

Series Number	PG. NO.	DESCRIPTION	FINISH	1-5	6 & OVER
---------------	---------	-------------	--------	-----	----------

EXTRUDED STORM/COMBINATION DOORS - 30", 32", 36"

				1-5	6/OVER
5100	15	COMBO	A	269.76	239.98
			M	261.68	232.72
			AD,AL,B,T,W,Z	284.48	254.04
5500	16	OLYMPIA FULL	A	482.21	439.93
			M	472.56	431.11
			AD,AL,B,T,W,Z	514.46	469.34
5600	16	OLYMPIA JR	A	421.73	384.87
			M	413.31	377.20
			AL,B,AD,T,W,Z	467.80	426.92

EXTRUDED KEYED LOCK SCREEN DOORS - 30", 32", 36"

4900	17	SENTRY	A,AL,B,AD,T,W,Z	439.85	421.29
5000	18	GIBRALTAR	A,AL,B,AD,T,W,Z	453.50	434.70

For Standard 42" Doors: Call For Quote
N/A= Not Available in 42"

SCREEN DOORS

SPECIAL SCREEN DOORS PRICING

CUSTOM CHARGES FOR: CUSTOM BUILT SCREEN DOORS

Under 35-1/4" x 79 3/4; Width or Height or Both	+	20.00
Width to 41 1/4"; Height to 84" or Both	+	38.00
Width to 41 1/4"; Height to 96" or Both	+	43.00
Width to 48"; Height to 96" or Both	+	48.00
Width to 48"; Height to 108" or Both	+	65.00
Width to 48"; Height to 120" or Both	+	88.00

Note: Add to Standard 36" Door Price.
Call for quotes over 48" wide and over 120" high

CUSTOM CHARGES FOR: SPECIAL SIZE PROTECTO FULL & SANTA FE FULL, COMBINATION/STORM & KEYED LOCK DOORS

Under 35-1/4" x 79 3/4; Width or Height or Both	+	60.00
Width to 41 1/4"; Height to 84" or Both	+	80.00
Width to 41 1/4"; Height to 96" or Both	+	90.00
Width to 48"; Height to 96" or Both	+	100.00

Note: Add to Standard 36" Door Price.
Call for quotes over 48" wide and over 96" high
Call for quotes on all Special Size Storm Doors.

SPECIAL WIRE

Shell Only - No Screening	-	0.00
Fiber 18 x 14 - Gray or Charcoal, Better Vue	+	6.00
Aluminum 18 x 16	+	7.00
Charcoal or Black Alum 18 x 16	+	8.00
Ultra Vue	+	15.00
Sunscreen, Fiber 20 x 30 Tuff Screen, Fiber 20 x 20	+	17.50
Suntex 80%, Petscreen, NO-SEE-UM	+	20.00
Suntex 90%	+	25.00
"SEEVUE" Stainless Steel Wire	+	40.00
Copper/Bronze	+	45.00
Heavy Black Aluminum 14 x 14	+	70.00

Hinges

Additional (per hinge)	+	10.00
Special Placement (per channel)	+	14.00

Note: All Dimensions Must Be Given In Inches and Fractions of an Inch Only. Active Window Will Not be Held Responsible for Errors Caused by Orders Given in any Other Manner.

SCREEN DOORS

PUSH BARS INSTALLED

2" Extruded Push Bar	+	12.00
3" Roll Formed	+	10.00
1-1/4" Roll Formed	+	10.00
1" Extruded Push Bar	+	10.00

SPECIAL HANDLING

Special Placement (per Door)	+	15.00
*Measured from bottom of door to center of pushbar.		
Push Bars Loose (per door)	+	8.00

TEMPERED OR ACRYLIC PANELS

For Security or Screen Doors up to 36" Standard Size	+	140.00
* Note: Tempered Glass: 10-14 Days, Acrylic 3-5 Days		

GRILLES BUILT-IN

Apollo/Imperial W/Plastic Grille Surround: per grille up to 41-1/4"	+	40.00
Protecto/SuperGuard: per grille up to 35-1/4"	+	70.00
Protecto/SuperGuard: per grille up to 41-1/4"	+	80.00

GRILLES INSTALLED

Additional Grilles, Installed (riveted on) Labor + Cost of Grille (Section 13)	+	12.00
--	---	-------

KICK PLATES

Additional Kick Plates, Installed; per Kick Plate		
18"	+	25.00
12"	+	20.00
9"	+	17.00
7" (Roll Formed Door Only)	+	14.00
Cutting Charge for "Cut Down" Kick Plates; per kick plate	+	15.00

PET DOORS

Installation Charge of Medium, Large and X-Large Pet Doors added to the cost of a Pet Door (See Section 22 Page 4)	+	60.00
--	---	-------

SPECIAL PLACEMENT OF LOCK ON STORM & KEYED LOCK DOORS

Per Standard Door only	+	30.00
------------------------	---	-------

NOTE: Please Refer to Section 2 for Swinging Door Component Parts