



2026...



... *il galateo del giardino* ...

... c'è il *fiore* che fa il timido
e si chiude appena piove...

... c'è il *fiore* un po' viziato
e vuole solo zone nuove...

... il *geraneo* si dà tante arie
su quel balcone lui si crede il padrone...

... c'è la *mimosa*

che ogni 8 marzo si inchina alla sua piccina...

... mentre la *rosa* fa' la diva
come in una vecchia favola...

c'è l'*erbaccia* che è un'intrusa
e si siede a capo di tavola...

... il *girasole* un tipo sveglio
che insegue il sole tutto il giorno...

...la *lavanda* è una signora
che profuma tutto intorno...

... e se il *cactus* sembra scontroso e
non vuole mai un abbraccio

è solo perchè ha un cuore tenero
sotto quel brutto impaccio...

... inutile forzarli ognuno ha la sua testa
ma se li tratti bene ogni giorno è una gran festa...

... perchè in fondo un giardino,
diciamocelo chiaramente,

è lo specchio del padrone:
un po' matto e sorridente!





I N D I C E

LINEA PLASTICA EURO3PLAST	pag. 1
LINEA PLASTICA	pag. 10
LINEA PLASTICA ARCA	pag. 11
LINEA BALCONIERE	pag. 14
LINEA GREENER EURO3PLAST	pag. 18
LINEA PORTAVASI PLASTICA	pag. 20
LINEA VASI ORCHIDEE PLASTICA	pag. 25
LINEA UP EURO3PLAST	pag. 26
LINEA MITU PAC EURO3PLAST	pag. 31
LINEA PLASTICA	pag. 38
LINEA KEBE	pag. 39
LINEA ETRIA	pag. 43
LINEA RISERVE D'ACQUA	pag. 53
LINEA RESINA	pag. 54
LINEA TERRACOTTA INDUSTRIALE	pag. 63
LINEA TERRACOTTA MACCHINA	pag. 68
LINEA TERRACOTTA A MANO	pag. 83
LINEA GIARDINO	
LEGNO	pag. 94
GRIGLIATI METALLO	pag. 99
CANNE E TUTORI	pag. 102
STUOIE BAMBOO	pag. 103
STUOIE TELI E TESSUTI	pag. 104
PRATO SINTETICO	pag. 109
LEGACCI ATTREZZATURE E PROTEZIONE	pag. 111
CARIOLE	pag. 128
POMPE SPRUZZINI INNAFFIATOI IRRIGAZIONE	pag. 129
GARDENA	pag. 140
LINEA CONCIMI	
BULBI E SEMI	pag. 147
PROFESSIONALE BARENBRUG	pag. 153
TERRICCI	pag. 161
CONCIMI PROFESSIONALI	pag. 163
CONCIMI DOTTO	pag. 169
CONCIMI COMPO	pag. 173
CONCIMI LINFA	pag. 178
CONCIMI SBM	pag. 182
LINEA GIARDINI PENSILI	pag. 187
LINEA BORDURE	pag. 189
LINEA SASSI E CIOTTOLI	pag. 191



BEST SELLER

A richiesta espositori per vasi Geo e sottovasi Medea dal 20 al 40
 art. 3057 | cm. 63x123x210 | € 700,00

Geo Vaso colorato

		Sottovaso Cons.	G9	L4	M9	03	62	T4	T5	T6		
			Tortora	Rosmarino	Sabbia	Bianco	Antracite	Oceano	Mango	Mattone		
art. 1983	cm. 13 cm 13x10h lt.0,8	Ø cm. 12	•			•	•				(10)	€ 1,00
art. 1972	cm. 15 cm 15x11h lt.1,2	Ø cm. 14	•			•	•				(10)	€ 1,20
art. 1973	cm. 18 cm 18x14h lt.2	Ø cm. 18	•			•	•				(10)	€ 1,70
art. 1974	cm. 20 cm 20x15h lt.2,9	Ø cm. 20	•	•	•	•	•	•	•	•	(10)	€ 2,30
art. 1975	cm. 25 cm 25x19h lt.5,6	Ø cm. 24	•	•	•	•	•	•	•	•	(10)	€ 3,20
art. 1976	cm. 30 cm 30x23h lt.9,7	Ø cm. 28	•	•	•	•	•	•	•	•	(10)	€ 4,90
art. 1977	cm. 35 cm 35x26h lt.15,4	Ø cm. 32	•	•	•	•	•	•	•	•	(10)	€ 5,90
art. 1978	cm. 40 cm 40x30h lt.23,2	Ø cm. 36	•	•	•	•	•	•	•	•	(10)	€ 7,50
art. 1979	cm. 45 cm 45x34h lt.33	Ø cm. 40	•	•	•	•	•				(10)	€ 10,50
art. 1980	cm. 50 cm 50x38h lt.45,3	Ø cm. 44	•	•	•	•	•				(10)	€ 13,90
art. 2058	cm. 55 cm 55x41h lt.60,4	Ø cm. 48	•			•	•				(10)	€ 19,90
art. 1981	cm. 60 cm 60x45h lt.78,4	Ø cm. 52	•			•	•				(5)	€ 26,50
art. 1982	cm. 70 cm 70x53h lt.124,6	Ø cm. 56	•			•	•				(5)	€ 39,90



Geo Vaso Terracotta

SOLO COLORE TERRACOTTA

		Sottovaso Cons.	01	Cotto	
art. 1983	cm. 13 cm 13x10h lt.0,8	Ø cm. 12	•	(10)	€ 0,80
art. 1972	cm. 15 cm 15x11h lt.1,2	Ø cm. 14	•	(10)	€ 1,00
art. 1973	cm. 18 cm 18x14h lt.2	Ø cm. 18	•	(10)	€ 1,50
art. 1974	cm. 20 cm 20x15h lt.2,9	Ø cm. 20	•	(10)	€ 2,00
art. 1975	cm. 25 cm 25x19h lt.5,6	Ø cm. 24	•	(10)	€ 3,00
art. 1976	cm. 30 cm 30x23h lt.9,7	Ø cm. 28	•	(10)	€ 4,50
art. 1977	cm. 35 cm 35x26h lt.15,4	Ø cm. 32	•	(10)	€ 5,60
art. 1978	cm. 40 cm 40x30h lt.23,2	Ø cm. 36	•	(10)	€ 7,00
art. 1979	cm. 45 cm 45x34h lt.33	Ø cm. 40	•	(10)	€ 9,80
art. 1980	cm. 50 cm 50x38h lt.45,3	Ø cm. 44	•	(10)	€ 12,30
art. 2058	cm. 55 cm 55x41h lt.60,4	Ø cm. 48	•	(10)	€ 18,50
art. 1981	cm. 60 cm 60x45h lt.78,4	Ø cm. 52	•	(5)	€ 22,90
art. 1982	cm. 70 cm 70x53h lt.124,6	Ø cm. 56	•	(5)	€ 34,30
art. 1300	cm. 90 cm 90x62h lt.250	Ø cm. 82	•	(1)	€ 110,00
art. 2480C	cm. 80 cm 80x56h lt.168	Ø cm. 74	•	(1)	€ 98,00

“... non puoi cominciare un nuovo capitolo della tua vita se continui a leggere l'ultimo ...”



Medea Sottovaso



Vaso Consigliato			62	L4	M9	01	03	G9	T4	T5	T6		
			Antracite	Rosmarino	Sabbia	Cotto	Bianco	Tortora	Oceano	Mango	Mattone		
art. 1469	cm. 8 (6x1,3h)	Ø cm. 10				•						(25)	€ 0,50
art. 1470	cm. 10 (9x1,4h)	Ø cm.				•						(25)	€ 0,60
art. 1471	cm. 12 (12x2,4h)	Ø cm. 13	•			•	•	•				(25)	€ 0,70
art. 1472	cm. 14 (14x2,7h)	Ø cm. 15	•			•	•	•				(25)	€ 0,80
art. 1473	cm. 16 (16,2x9,2h)	Ø cm. 18				•						(25)	€ 0,90
art. 1474	cm. 18 (18,2x9,2h)	Ø cm.				•						(25)	€ 1,00
art. 1475	cm. 20* (20x3,4h)	Ø cm. 20	•	•	•	•	•	•	•	•	•	(25)	€ 1,50
art. 1476	cm. 22 (22x3,7h)	Ø cm.	•			•		•				(25)	€ 1,60
art. 1477	cm. 24* (24x4h)	Ø cm. 25	•	•	•	•	•	•	•	•	•	(25)	€ 1,80
art. 1478	cm. 26* (26x4,2h)	Ø cm.	•			•		•				(25)	€ 2,20
art. 1479	cm. 28* (28x4,4h)	Ø cm. 30	•	•	•	•	•	•	•	•	•	(25)	€ 2,60
art. 1480	cm. 30 (30x4,4h)	Ø cm.	•			•						(25)	€ 3,30
art. 1481	cm. 32* (32x4,6h)	Ø cm. 35	•	•	•	•	•	•	•	•	•	(25)	€ 4,20
art. 1482	cm. 36 (36x5h)	Ø cm. 40	•			•		•				(25)	€ 5,30
art. 1483	cm. 40* (40x5,4h)	Ø cm. 45	•	•	•	•	•	•	•	•	•	(25)	€ 6,20
art. 1484	cm. 44 (44x5,8h)	Ø cm. 50	•	•	•	•	•	•	•	•	•	(25)	€ 7,20
art. 1485	cm. 48 (48x6,2h)	Ø cm. 55	•	•	•	•	•	•				(25)	€ 9,10
art. 1486	cm. 52 (52x6,7h)	Ø cm. 60	•			•	•	•				(25)	€ 10,00
art. 1487	cm. 56 (56x6,9h)	Ø cm. 70	•			•	•	•				(25)	€ 12,50
art. 1488	cm. 64 (64x7h)	Ø cm.	•			•	•	•				(15)	€ 14,90
art. 1960	cm. 82 (82x8,7h)	Ø cm. 90				•						(5)	€ 24,00

I PREZZI RIPORTATI SONO ESCLUSI DI IVA

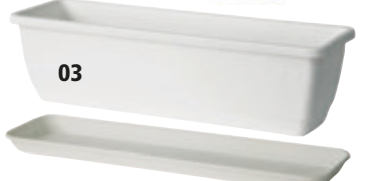

Inis Cassetta

		G9	M9	01	03	62	T4	T5	T6		
		Tortora	Sabbia	Cotto	Bianco	Antracite	Oceano	Mango	Mattone		
art. 1987	cm. 40 (40x19,5x16,4h) lt.8	•	•	•	•	•	•	•	•	(12)	€ 6,20
art. 1988	cm. 50 (50x19,5x16,4h) lt.10	•	•	•	•	•	•	•	•	(12)	€ 6,90
art. 1989	cm. 60 (60x19,5x16,4h) lt.12	•	•	•	•	•	•	•	•	(12)	€ 8,50
art. 2055	cm. 80 (80x19,5x16,4h) lt.17	•	•	•	•	•	•	•	•	(6)	€ 10,80

Inis Sottocassetta

		G9	M9	01	03	62	T4	T5	T6		
		Tortora	Sabbia	Cotto	Bianco	Antracite	Oceano	Mango	Mattone		
art. 1990	cm. 40 (36,6x16,1x3h) lt.8	•	•	•	•	•	•	•	•	(12)	€ 2,50
art. 1991	cm. 50 (46,6x16,1x3h) lt.8	•	•	•	•	•	•	•	•	(12)	€ 3,20
art. 1992	cm. 60 (56,6x16,1x3h) lt.8	•	•	•	•	•	•	•	•	(12)	€ 4,10
art. 2056	cm. 80 (76,6x16,1x3h) lt.8	•	•	•	•	•	•	•	•	(6)	€ 5,20



Gardenie Cassetta

		G9	02	01	62		
		Tortora	Verde	Cotto	Antracite		
art. 2327	cm. 40 40x20x16h lt.8	•	•	•	•	(24)	€ 4,60
art. 2328	cm. 50 50x20x16h lt.10	•	•	•	•	(24)	€ 5,50
art. 2329	cm. 60 60x20x16h lt.12	•	•	•	•	(24)	€ 6,60

Gardenie Sottocassetta

		G9	02	01	62		
		Tortora	Verde	Cotto	Antracite		
art. 2330	cm. 40 40x20x16h lt.8	•	•	•	•	(24)	€ 2,00
art. 2331	cm. 50 50x20x16h lt.10	•	•	•	•	(24)	€ 2,40
art. 2332	cm. 60 60x20x16h lt.12	•	•	•	•	(24)	€ 2,90



Miza Cassetta

		G9	01	62		
		Tortora	Cotto	Antracite		
art. 1897	cm. 40 40x21,7x18h lt.10	•	•	•	(24)	€ 8,80
art. 1898	cm. 50 50x21,7x18h lt.13	•	•	•	(24)	€ 10,20
art. 1899	cm. 60 60x21,7x18h lt.16	•	•	•	(24)	€ 11,50

Miza Sottocassetta

		G9	01	62		
		Tortora	Cotto	Antracite		
art. 1900	cm. 40 40x17,9x3h	•	•	•	(24)	€ 3,60
art. 1901	cm. 50 50x17,9x3h	•	•	•	(24)	€ 4,50
art. 1902	cm. 60 60x17,9x3h	•	•	•	(24)	€ 5,40



a richiesta questa cassetta può essere fornita anche con riserva d'acqua nelle misure: 60 - 80 - 100

Kalis Cassetta

		G9	01		
		Tortora	Cotto		
art. 1941	cm. 50 (50x25x21h) lt.16	•	•	(12)	€ 16,70
art. 1888	cm. 60 (60x25x21h) lt.20	•	•	(12)	€ 19,50
art. 1889	cm. 80 (80x25x21h) lt.28	•	•	(6)	€ 24,50
art. 1890	cm. 100 (100x25x21h) lt.35	•	•	(6)	€ 31,50

Kalis Sottocassetta

		G9	01		
		Tortora	Cotto		
art. 1942	cm. 50 (45,6x20,6x3,5h)	•	•	(12)	€ 6,40
art. 1891	cm. 60 (55,6x20,6x3,5h)	•	•	(12)	€ 7,40
art. 1892	cm. 80 (75,6x20,6x3,5h)	•	•	(6)	€ 9,50
art. 1893	cm. 100 (95,6x20,6x3,5h)	•	•	(6)	€ 11,90

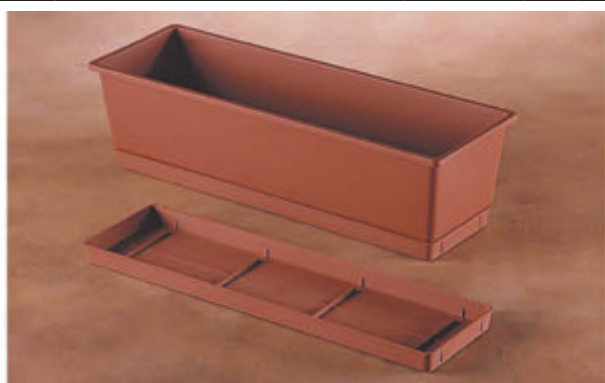

Gerani Cassetta

		01		
		Cotto		
art. 1017	cm. 30 (cm. 30x17x14h) lt.5	•	(25)	€ 4,80
art. 1018	cm. 35 (cm. 35x17x14h) lt.6	•	(25)	€ 5,10
art. 1019	cm. 40 (cm. 40x17x14h) lt.7	•	(25)	€ 5,70



Gerani Sottocassetta

		01		
		Cotto		
art. 1067	cm. 30 (cm. 26x13x3h)	•	(25)	€ 2,70
art. 1068	cm. 35 (cm. 31x13x3h)	•	(25)	€ 3,00
art. 1069	cm. 40 (cm. 36x13x3h)	•	(25)	€ 3,30



Licum Cassetta

		03	01	02		
		Bianco	Cotto	Verde		
art. 1999	cm. 20 (20x12,5x10,8h)	•	•	•	(12)	€ 5,20
art. 2000	cm. 30 (30x12,5x10,8h)	•	•	•	(12)	€ 6,70
art. 2001	cm. 40 (40x12,5x10,8h)	•	•	•	(12)	€ 8,20

I PREZZI RIPORTATI SONO ESCLUSI DI IVA



Akea Cassetta

		G9	01	03	62		
		Tortora	Cotto	Bianco	Antracite		
art. 1680	cm. 50* (50x28x22h) lt.16	●	●	●	●	(6)	€ 13,50
art. 1681	cm. 60* (60x31x26h) lt.26	●	●	●	●	(6)	€ 20,50
art. 1683	cm. 80 (80x39x34h) lt.60	●	●	●	●	(4)	€ 31,50
art. 1684	cm. 100 (100x46x40h) lt.100	●	●	●	●	(2)	€ 47,50

Akea Sottocassetta

		G9	01	03	62		
		Tortora	Cotto	Bianco	Antracite		
art. 1685	cm. 50 (46x22x3h)	●	●	●	●	(6)	€ 5,60
art. 1686	cm. 60 (55x26x3,7h)	●	●	●	●	(6)	€ 8,60
art. 1687	cm. 80 (73x32x4,7h)	●	●	●	●	(4)	€ 11,60
art. 1689	cm. 100 (90x36x5,7h)	●	●	●	●	(2)	€ 20,60



Krea Vaso Quadrato

		G9	01	03	62		
		Tortora	Cotto	Bianco	Antracite		
art. 1702	cm. 25 (25x25x22h) lt.6,5	●	●		●	(10)	€ 6,60
art. 1703	cm. 30 (31x31x26h) lt.12	●	●		●	(10)	€ 10,80
art. 1704	cm. 35 (35x35x30h) lt.17	●	●		●	(10)	€ 16,20
art. 1705	cm. 40 (39x39x34h) lt.24	●	●	●	●	(10)	€ 21,60
art. 1706	cm. 45 (46x46x40h) lt.38	●	●	●	●	(10)	€ 30,60

Krea Sottovaso Quadrato

		G9	01	03	62		
		Tortora	Cotto	Bianco	Antracite		
art. 1707	cm. 25 (22x22x3h)	●	●		●	(10)	€ 3,60
art. 1708	cm. 30 (26x26x3,7h)	●	●		●	(10)	€ 5,50
art. 1709	cm. 35 (29x29x4,2h)	●	●		●	(10)	€ 7,60
art. 1710	cm. 40 (32x32x4,7h)	●	●	●	●	(10)	€ 9,80
art. 1711	cm. 45 (36x36x5,7h)	●	●	●	●	(10)	€ 13,50



Krea Vaso Angolare

art. 1743 | cm. **45** (46x46x40h) It.35 | (5) | € **42,50**

Colori Disponibili:

01 Cotto

Krea Sott. Angolare

art. 1745 | cm. **45** (39x39x5,7h) | (5) | € **16,50**

Colori Disponibili:

01 Cotto

Krea Vaso a Muro

art. 1742 | cm. **45** (46x38x40h) It.27 | (5) | € **38,50**

Colori Disponibili:

01 Cotto

Krea Sott. a Muro

art. 1744 | cm. **45** (36x30x5,7h) | (5) | € **14,50**

Colori Disponibili:

01 Cotto



Vaso Linteo Campana

art. 1662	cm. 14 (14x11h) It.0,9	FINO AD ESAURIMENTO SCORTE	(10)	€ 1,00
art. 1663	cm. 16 (16x13h) It.1,2	FINO AD ESAURIMENTO SCORTE	(10)	€ 1,50
art. 1664	cm. 18 (18x14h) It.1,6		(10)	€ 2,10
art. 1665	cm. 20 (20x16h) It.2,5		(10)	€ 2,90
art. 1666	cm. 25 (25x20h) It.4,8		(10)	€ 4,40
art. 1667	cm. 30 (30x23h) It.8,3		(10)	€ 6,00
art. 1668	cm. 35 (35x27h) It.13,5		(10)	€ 8,50
art. 1669	cm. 40 (40x31h) It.19		(10)	€ 11,70
art. 1670	cm. 45 (45x35h) It.29		(10)	€ 15,70
art. 1671	cm. 50 (50x39h) It.39		(10)	€ 21,60
art. 1672	cm. 60 (60x46h) It.67	FINO AD ESAURIMENTO SCORTE	(5)	€ 29,00
art. 2028	cm. 70 (70x51h) It.100	FINO AD ESAURIMENTO SCORTE	(5)	€ 41,00
art. 2029	cm. 85 (85x57h) It.171	FINO AD ESAURIMENTO SCORTE	(4)	€ 63,00

Colori Disponibili:

01 Cotto



Domus Gerla con sottovaso

art. 1800 | cm. **25** (25x16x18h) It.2,9 | (24) | € **9,50**

art. 1801 | cm. **30** (30x19x21h) It.5,1 | (24) | € **11,50**

01 Cotto

Sottovaso con ruote montate

01

Cotto

art. 1107	cm. 25 (24,8x10,8h)	•	(6)	€ 18,60
art. 1108	cm. 28 (27,8x11h)	•	Fin. Esur.	(6) € 11,50
art. 1109	cm. 31 (30,3x11,1h)	•	Fin. Esur.	(6) € 13,50
art. 1110	cm. 35 (35,4x11,4h)	•	Fin. Esur.	(6) € 15,50
art. 1955	cm. 39 (39x12h)	•	(6)	€ 27,90
art. 1111	cm. 42 (42x12h)	•	Fin. Esur.	(6) € 22,50
art. 1661	cm. 48 (48,4x12,2h)	•	(6)	€ 43,50
art. 1956	cm. 56 (56x13,1h)	•	(6)	€ 56,50



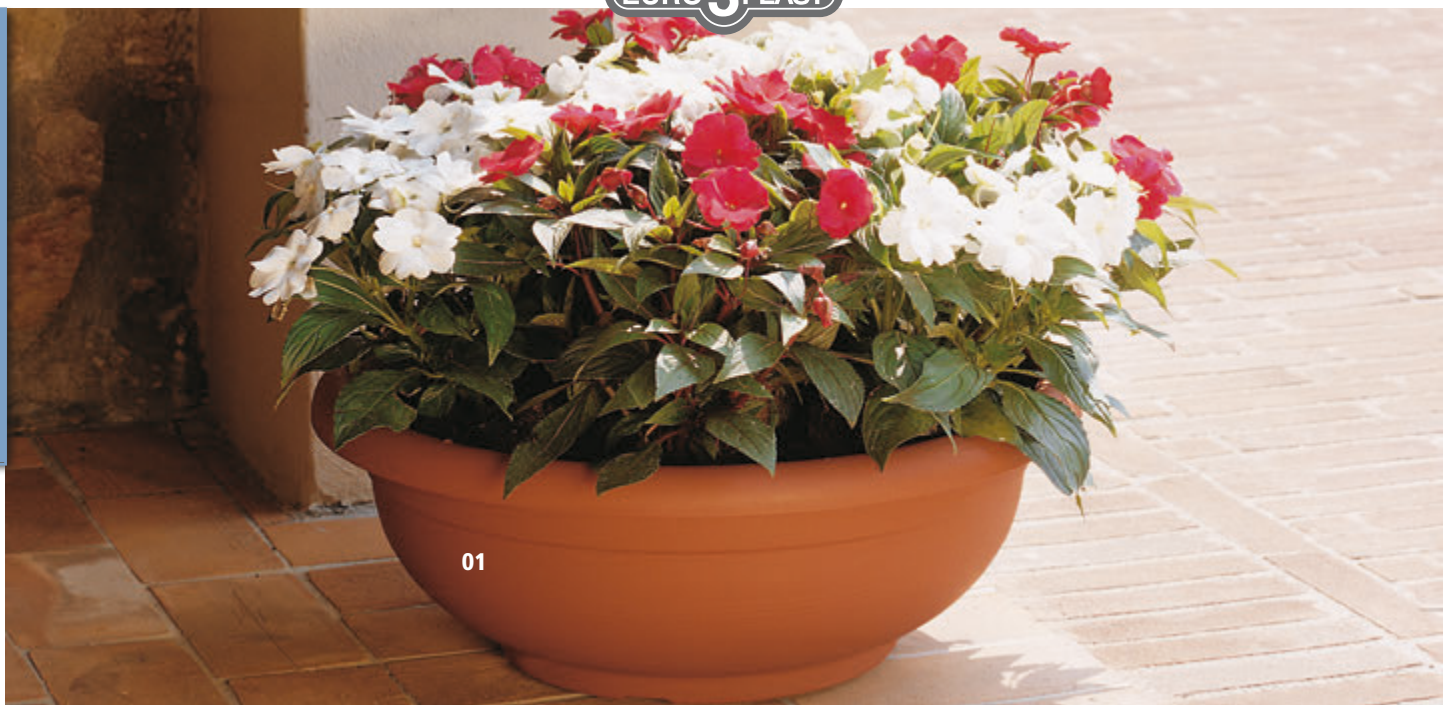

Olimpo Ciotola

art. 1375	cm. 20 (20x8h)	lt.1,4	(10)	€ 3,20
art. 1376	cm. 25 (25x9h)	lt.2,7	(10)	€ 4,90
art. 1359	cm. 30 (30x11h)	lt.4,7	(10)	€ 6,50
art. 1454	cm. 35 (35x13h)	lt.7,5	(10)	€ 9,50
art. 1360	cm. 40 (40x15h)	lt.11	(10)	€ 10,90
art. 1500	cm. 45 (45x17h)	lt.16	(10)	€ 12,80
art. 1361	cm. 50 (50x19h)	lt.22	(10)	€ 15,90
art. 1362	cm. 60 (60x23h)	lt.38	(10)	€ 24,50
art. 1363	cm. 70 (70x27h)	lt.60	(5)	€ 46,90
art. 1455	cm. 90* (190x34h)	lt.128	(2)	€ 68,80



G9 Tortora | 01 Cotto | 62 Antra.

* 90 solo Cotto e Antra. (no Tortora)



Eolia Ciotola con sottovaso montato solo colore Antracite

art. 1909	cm.28 (28x14h)	lt.5,3	FINO AD ESAURIMENTO SCORTE	(24)	€ 3,90
-----------	----------------	--------	----------------------------	------	--------

62 Antracite



Ciotola Libis con sottovaso montato

art. 2427	cm. 25 (225x22h)	lt.3,6	(10)	€ 5,40
art. 2428	cm. 30 (30x13h)	lt.6,4	(10)	€ 6,90
art. 2429	cm. 35 (35x15h)	lt.10	(10)	€ 9,80

G9 Tortora | 01 Cotto | 69 Avorio



Sottovaso Sabbiato

art. 1313	cm. 6 (6x1,3h)	∅	(25)	€ 0,50
art. 1314	cm. 8 (8x1,5h)	∅	(25)	€ 0,50
art. 1229	cm. 10 (9x1,4h)	∅	(25)	€ 0,60
art. 3/12	cm. 12 (12x2,4h)	∅	(25)	€ 0,70
art. 3/14	cm. 14 (14x2,7h)	∅	(25)	€ 0,80
art. 3/16	cm. 16 (16,2x9,2h)	∅	(25)	€ 0,90
art. 3/18	cm. 18 (18x3,2h)	∅	(25)	€ 1,00
art. 3/20	cm. 20 (20x3,4h)	∅	(25)	€ 1,10
art. 3/22	cm. 22 (22x3,7h)	∅	(25)	€ 1,40
art. 3/24	cm. 24 (24x4h)	∅	(25)	€ 1,50
art. 3/26	cm. 26 (26x4,2h)	∅	(25)	€ 1,90
art. 3/28	cm. 28 (28x4,4h)	∅	(25)	€ 2,60
art. 3/30	cm. 30 (30x4,7h)	∅	(25)	€ 2,90
art. 3/35	cm. 35 (35x5h)	∅	(25)	€ 3,90
art. 3/40	cm. 40 (40x5,3h)	∅	(25)	€ 5,40
art. 3/45	cm. 45 (45x5,5h)	∅	(25)	€ 6,50
art. 3/50	cm. 50 (50x5,2h)	∅	(25)	€ 9,30
art. 3/55	cm. 55 (58,6x5,8h)	∅	(25)	€ 12,50
art. 3/60	cm. 60 (63,6x6h)	∅	(25)	€ 15,10



Tree - Espositore con ruote per sottovasi

art. 2154 | cm. 100x212 *(sottovasi esclusi) | € 00,00*



Moplen Sottovaso

art. 1037	cm. 10 (10x2,3h)	∅	(25)	€ 0,40
art. 1/12	cm. 12 (11,9x2,5h)	∅	(25)	€ 0,60
art. 1/14	cm. 14 (13,9x2,2h)	∅	(25)	€ 0,70
art. 1/16	cm. 16 (15,7x3,1h)	∅	(25)	€ 0,80
art. 1/18	cm. 18 (17,9x3,3h)	∅	(25)	€ 0,90
art. 1/20	cm. 20 (19,8x3,5h)	∅	(25)	€ 1,10
art. 1/22	cm. 22 (21,9x3,6h)	∅	(25)	€ 1,20
art. 1/24	cm. 24 (23,9x3,9h)	∅	(25)	€ 1,40
art. 1/26	cm. 26 (25,9x4,2h)	∅	(25)	€ 1,90
art. 1/28	cm. 28 (27,9x4,5h)	∅	(25)	€ 2,20
art. 1/30	cm. 30 (29,8x4,7h)	∅	(25)	€ 2,70
art. 1/35	cm. 35 (34,9x5h)	∅	(25)	€ 3,50
art. 1/40	cm. 40 (39,9x5,2h)	∅	(25)	€ 5,50
art. 1/45	cm. 45 (45x5,5h)	∅	(25)	€ 6,60
art. 1/50	cm. 50 (49,8x5,6h)	∅	(25)	€ 8,50

01 Cotto

02 Verde

ANCHE PER VASI DI TERRACOTTA



Sottovaso Quadro

art. 1170	cm. 29 (28x28x4h)	FINO AD ESAURIMENTO SCORTE	(10)	€ 6,00
art. 1171	cm. 34 (33x33x4h)	FINO AD ESAURIMENTO SCORTE	(10)	€ 7,20
art. 1172	cm. 39 (38x38x5h)	FINO AD ESAURIMENTO SCORTE	(10)	€ 9,00

01 Cotto



Moplen Sottocassetta

art. 2/40	cm. 40 (40x18x5h)	(25)	€ 2,80
art. 2/25	cm. 25 (25x15x4h)	(25)	€ 1,50
art. 2/46	cm. 46 (46x20x5h)	(25)	€ 4,10
art. 2/30	cm. 30 (30x16x4h)	(25)	€ 1,90
art. 2/52	cm. 52 (52x22x5,9h)	(25)	€ 6,90
art. 2/35	cm. 35 (35x17x5h)	(25)	€ 2,40
art. 2/62	cm. 62 (62x20x5,8h)	(25)	€ 8,90

02 Verde

ANCHE PER CASSETTE DI TERRACOTTA



Maxi Sottocassetta

art. 1228	cm. 50 (49x25x4h)	(6)	€ 7,50	art. 1191	cm. 90 (90x40x5h)	(2)	€ 28,20
art. 1168	cm. 80 (82x39x4h)	(4)	€ 24,90	art. 1169	cm. 100 (101x47x5h)	(2)	€ 31,50

01 Cotto

FINO AD ESAURIMENTO SCORTE



Sottocassetta Mini

art. 1238	cm. 30 (30x16x4h)	(25)	€ 2,40	art. 1241	cm. 46 (47x20x5h)	(25)	€ 4,90
art. 1239	cm. 35 (35x17x5h)	(25)	€ 2,90	art. 1242	cm. 52 (53x22x6h)	(25)	€ 8,80
art. 1240	cm. 40 (41x18x5h)	(25)	€ 3,40	art. 1243	cm. 62 (63x23x7h)	(25)	€ 9,90

01 Cotto

I PREZZI RIPORTATI SONO ESCLUSI DI IVA



Fino ad esaurimento Scorte

Azem Fioriera

art. 2010	cm. 30 (30x28h) It.5,7	(12)	€ 9,90
art. 2011	cm. 35 (35x33h) It.9	(6)	€ 13,00
art. 2012	cm. 40 (40x38h) It.13,5	(6)	€ 17,00

01 Cotto



Piedino Plastica

art. 1462 (cm. 7,7x4,1x4,9h) (40) € 1,40 cad.

01 Cotto | 62 Grigio | 45 Cotto chiaro



Azem Ciotola appesa sottovaso montato

art. 2021	cm. 25 (25x25h)	(12)	€ 11,50
art. 2022	cm. 30 (30x28h)	(12)	€ 13,50
art. 2023	cm. 35 (35x32h)	(12)	€ 15,50

01 Cotto



Eolia Ciotola appesa sottovaso montato

art. 1914	cm. 28 (28x17h) It.5,3	(12)	€ 11,00
-----------	------------------------	------	---------

01 Cotto



Vaso Calice Alba

art. 31893	cm. 25x27h	(06)	€ 6,90
art. 31895	cm. 33x35h	(06)	€ 10,90
art. 31891	cm. 43x46h	(06)	€ 17,90



Vaso Piramide con sottovaso

art. 31906	cm. 40x59h	(06)	€ 43,50
------------	------------	------	---------



Vaso Colonna Alba

art. 31903 Antracite	cm. 43x74,5h	(06)	€ 24,90
art. 31904 Terracotta	cm. 43x74,5h	(06)	€ 24,90
art. 31890 Bianco	cm. 43x74,5h	(06)	€ 24,90



Vaso Roma parete con sottovaso Angolo Vittoria con sott.

art. 30900	cm. 52 (52x49h)	(08)	€ 37,50	art. 30215	cm. 45	(10)	€ 39,50
------------	-----------------	------	---------	------------	--------	------	---------

I PREZZI RIPORTATI SONO ESCLUSI DI IVA



Balconetta spazzolata con sottocassetta montata

		TT	AX	EX	TR	BI	RO	AN	SX	GR	VI	VC	FC	GI		
		Tortora	V. Acido	Beige	Cotto	Bianco	Rosso	Antracite	Salvia	Grigio	Viola	V. Lime	Fucsia	Giallo		
art. 55000025	cm. 25 (25x12,5x10,5h)	•			•	•	•	•			•	•	•	•	(24)	€ 2,70
art. 55000035	cm. 35 (35x12,5x10,5h)	•			•	•	•	•			•	•	•	•	(24)	€ 3,40
art. 55000040	cm. 40 (40x18x16,5h)	•	•	•	•	•	•	•	•	•					(12)	€ 7,00
art. 55000050	cm. 50 (50x18x16,5h)	•	•	•	•	•	•	•	•	•					(12)	€ 8,70
art. 55000060	cm. 60 (60x18x16,5h)	•	•	•	•	•	•	•	•	•					(12)	€ 9,90
art. 55000080	cm. 80 (80x18x16,5h)	•	•	•	•	•	•	•	•	•					(6)	€ 15,20



Vaso spazzolato

			TT	AX	EX	TR	BI	RO	AN	SX	GR		
		Sottovaso Cons.	Tortora	Giallo	Beige	Cotto	Bianco	Rosso	Antracite	Salvia	Grigio		
art. 35000022	cm. 22	Ø cm. 22	•	•	•	•	•	•	•	•	•	(24)	€ 2,30
art. 35000025	cm. 25	Ø cm. 25	•	•	•	•	•	•	•	•	•	(24)	€ 3,50
art. 35000030	cm. 30	Ø cm. 30	•	•	•	•	•	•	•	•	•	(24)	€ 5,30
art. 35000035	cm. 35	Ø cm. 35	•	•	•	•	•	•	•	•	•	(24)	€ 7,80
art. 35000040	cm. 40 su richiesta	Ø cm. 40	•	•	•	•	•	•	•	•	•	(12)	€ 10,70
art. 35000045	cm. 45 su richiesta	Ø cm. 45	•	•	•	•	•	•	•	•	•	(12)	€ 15,20

Sottovaso spazzolato

			TT	AX	EX	TR	BI	RO	AN	SX	GR		
		Vaso Consigliato	Tortora	Giallo	Beige	Cotto	Bianco	Rosso	Antracite	Salvia	Grigio		
art. 33100022	cm. 22 (22x3,7h)	Ø cm. 22	•	•	•	•	•	•	•	•	•	(24)	€ 1,10
art. 33100025	cm. 25 (24x4h)	Ø cm. 25	•	•	•	•	•	•	•	•	•	(24)	€ 1,40
art. 33100030	cm. 30 (30x4,4h)	Ø cm. 30	•	•	•	•	•	•	•	•	•	(24)	€ 1,90
art. 33100035	cm. 35 (36x5h)	Ø cm. 35	•	•	•	•	•	•	•	•	•	(24)	€ 2,50
art. 33100040	cm. 40 (40x5,4h) su richiesta	Ø cm. 40	•	•	•	•	•	•	•	•	•	(12)	€ 3,80
art. 33100045	cm. 45 (44x5,8h) su richiesta	Ø cm. 45	•	•	•	•	•	•	•	•	•	(12)	€ 4,90



Vaso quadro economico

CM0014	cm. 14* (14x14x11h)	€ 2,40
CM0018	cm. 18* (18x18x14h)	€ 3,50
CM0022 - 6522	cm. 22 (22x22x18h)	€ 4,40
CM0027 - 6527	cm. 27 (27x27x21h)	€ 6,80
CM0032 - 6532	cm. 32 (32x32x26h)	€ 12,20
CM0038 - 6538	cm. 38 (38x38x30h)	€ 17,70
CM0045 - 6545	cm. 45 (45x45x36h)	€ 25,10
CM0054	cm. 54 (54x54x44h)	€ 44,20

Sottovaso quadrato

CM0012	cm. 12	€ 1,20
CM0016	cm. 16	€ 1,40
CM0020 - 65S22	cm. 20	€ 2,20
CM0025 - 65S27	cm. 25	€ 2,90
CM0030 - 65S32	cm. 30	€ 6,40
CM0036 - 65S38	cm. 36	€ 7,10
CM0042 - 65S45	cm. 42	€ 10,40
CM0050	cm. 50	€ 15,40



Ciotola Campana rotonda

CI001/15	cm. 15 Ø	(24)	€ 1,90
CI001/20	cm. 20 Ø	(24)	€ 2,90
CI001/25	cm. 25 Ø	(18)	€ 3,90
CI001/30	cm. 30 Ø	(12)	€ 4,90
CI001/35	cm. 35 Ø	(12)	€ 5,90



Mastello con manici

art. 320	cm. 50	€ 16,60
art. 320	cm. 55	€ 23,50
art. 320	cm. 60	€ 30,50
art. 320	cm. 70	€ 48,90
art. 320	cm. 80	€ 52,50
art. 320	cm. 96	€ 105,00



Kezar Cassetta con sottocassetta montata

art. 2334	cm. 50 50x20x16h lt.10	(24)	€ 4,50
-----------	-------------------------------	------	---------------

62 Antracite



237



241



238



240



239



Ciottoli in plastica riciclata e atossica (cm. 3/4)

art. 33700004	Busta (25x25h) Pezzatura Busta 17x30	€ 12,50
art. 33701004	Busta (25x25h) Pezzatura Busta 27x30	€ 18,50

Ciottoli in plastica riciclata e atossica (cm. 5/8)

art. 33700008	Busta (50x50h) Pezzatura Busta 27x30	€ 25,80
art. 33701008	Busta (50x50h) Pezzatura Busta 35x30	€ 45,80

I PREZZI RIPORTATI SONO ESCLUSI DI IVA



Cassetta balcone Imagna con sotto montato

art. 305/40	cm. 40 (40x20x18h) lt.7	(24)	€ 5,80
art. 305/50	cm. 50 (50x20x18h) lt.9	(24)	€ 7,50
art. 305/60	cm. 60 (60x20x18h) lt.10	(24)	€ 9,80



Minicassetta Small con sotto montato

art. 707/25	cm. 25 (25x12x9h) lt.2	(24)	€ 2,50
art. 707/30	cm. 30 (30x12x9h) lt.3	(24)	€ 3,00



Cassetta Rett. Liscia con sotto montato

art. 210/40	cm. 40 (40x17x16h) lt.7	(24)	€ 3,90
art. 210/50	cm. 50 (50x17x16h) lt.9	(24)	€ 4,90
art. 210/60	cm. 60 (60x18x16h) lt.10	(24)	€ 5,90



Ciotola Suprema con sotto montato

art. 298/20	cm. 20 (20x12h) lt. 2,5	(12)	€ 2,90
art. 298/25	cm. 25 (25x13h) lt. 4,5	(12)	€ 3,50
art. 298/30	cm. 30 (30x14h) lt. 6,5	(12)	€ 4,90
art. 298/35	cm. 35 (35x15h) lt. 9,5	(12)	€ 6,90
art. 298/40	cm. 40 (40x16h) lt. 14	(12)	€ 8,90

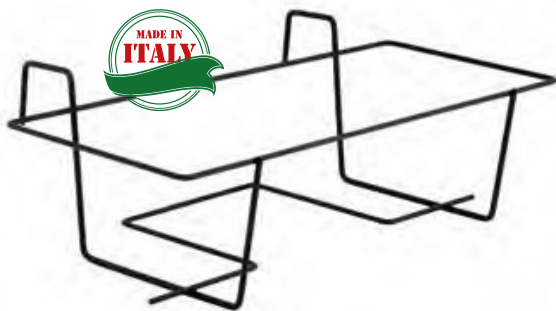

Balconiera Giuly a gancio fisso

cm. 40	cm. 42x21x13h - scatola pz. 8	cad. € 13,90
cm. 50	cm. 52x21x13h - scatola pz. 8	cad. € 14,90
cm. 60	cm. 62x21x13h - scatola pz. 6	cad. € 15,90



Balconiera Giuly a gancio regolabile

cm. 40	cm. 44x21x13h - scatola pz. 6	cad. € 18,90
cm. 50	cm. 54x21x13h - scatola pz. 6	cad. € 20,90
cm. 60	cm. 64x21x13h - scatola pz. 6	cad. € 22,90

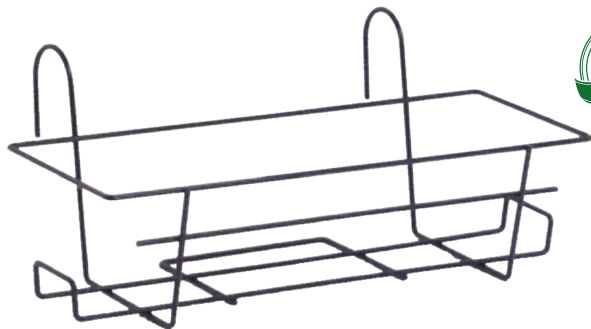

Balconiera Doriella a gancio fisso

cm. 40	cm. 42x21x13h - scatola pz. 8	cad. € 15,90
cm. 50	cm. 52x21x13h - scatola pz. 8	cad. € 17,90
cm. 60	cm. 62x21x13h - scatola pz. 8	cad. € 19,90
cm. 80	cm. 82x21x13h - scatola pz. 8	cad. € 26,90



Balconiera Doriella a gancio regolabile

cm. 40	cm. 44x21x13h - scatola pz. 6	cad. € 22,90
cm. 50	cm. 54x21x13h - scatola pz. 6	cad. € 23,90
cm. 60	cm. 64x21x13h - scatola pz. 6	cad. € 25,90
cm. 80	cm. 84x21x13h - scatola pz. 6	cad. € 33,90

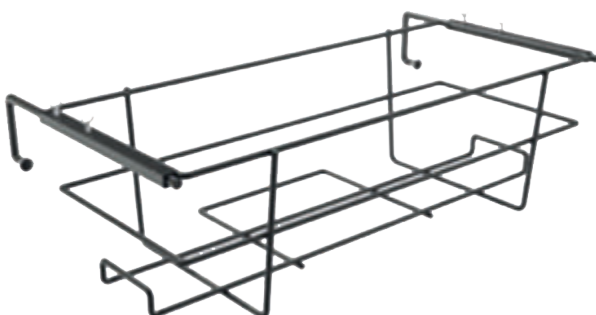

Balconiera Anita regolabile filo 6mm bianco-antracite-verde

cm. 40	cm. 44x23x18h	cad. € 33,90
cm. 50	cm. 54x23x18h	cad. € 35,90
cm. 60	cm. 64x23x18h	cad. € 37,90
cm. 80	cm. 84x23x18h	cad. € 42,90

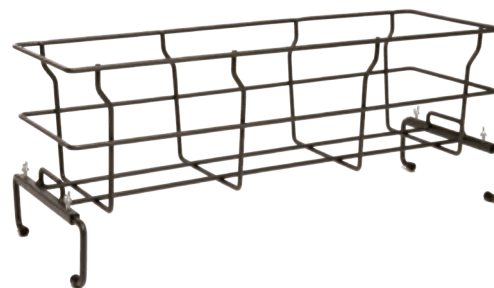

Balconetta Altea da muretto Antracite, Bianco, Verde

ALTMRO50	cm. 50 (52x23x18h)	€ 41,90
ALTMRO60	cm. 60 (62x23x18h)	€ 44,90
ALTMRO80	cm. 80 (82x23x18h)	€ 48,90



Portavaso Daniele

art. DANAF022	cm. 22x17h scatola pz. 10	cad. € 12,90
art. DANAF025	cm. 25x17h scatola pz. 10	cad. € 14,90

Prolunga cm 26 Anita / Altea

Prolunga cm 26 Giuly / Doriella



A richiesta ganci allungabili fino a 26 cm, per tutti i tipi di balconiere allungabili

art.	cm 26 Anita / Altea / Giuly / Doriella	€ 4,90
art.	cm 36 Anita / Altea / Giuly / Doriella	€ 6,90



Cassetta ringhiera Birka con sotto montato

art. 33170040	cm. 40 (40x17x16h) lt.7 (colore Terracotta)	(12)	€ 11,50
art. 33170050	cm. 50 (50x17x16h) lt.9 (colore Terracotta)	(12)	€ 13,50
art. 33160060	cm. 60 (60x17x16h) lt.10 (colore Terracotta)	(10)	€ 17,50



Cassetta ringhiera Pac con riserva acqua

art. KITPAC50BIA	cm. 50 (50x17x16h) lt.9 (colore Bianco)	(12)	€ 12,90
art. KITPAC50SAB	cm. 50 (50x17x16h) lt.9 (colore Sabbia)	(12)	€ 12,90



Kit Balconiera fissa più Cassetta Imagna con sottocassetta

art. KITMAGNA40	cm. 40 (40x20x18h) lt.7	(12)	€ 11,50
art. KITMAGNA50	cm. 50 (50x20x18h) lt.9	(12)	€ 13,50



Kit Arcobaleno Colori (bianco lucido, verde acido, rosso, giallo, lilla, fucsia, arancio, cotto)

art. ARCBF025 | cm 25 (25x11x9,7) Fissa conf. pz. 1 - (BOX colori assortiti pz.18)

€ 12,90



001



005



414



406



022



404

*“... non è mai troppo tardi
per essere ciò
che avresti voluto essere ...”*

FINO ESAURIMENTO SCORTE

**Hydra Vaso
Kit Balcone**

art. 2813002 | cm. 23 cm 23X21h lt.5

001	005	414	406	022	404
Terracotta	Antracite	Fog Grey	Bruno	Bianco	Cedro
•	•	•	•	•	•

€ 19,90

FINO ESAURIMENTO SCORTE

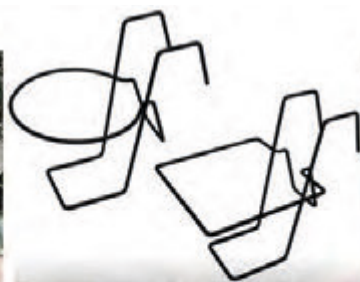

Cotto



Tortora



Antracite



Salvia



Mandorla

Kit Smart Portavaso e Vaso Colori Disponibili sia quadro che tondo

Art. SMAQBF17	QUADRO	cm. 17x17x17h	€ 17,90
Art. SMATBF17	TONDO	cm. 17x17x18h	€ 15,90

I PREZZI RIPORTATI SONO ESCLUSI DI IVA



Marilù Portavaso quadrato con ruote

Art. MARSP	cm. 35 - nero (35x35x5h) conf. pz. 6	cad. € 26,90
Art. MARSP	cm. 40 - nero (40x40x5h) conf. pz. 6	cad. € 29,90
Art. MARSP	cm. 50 - nero (50x50x5h) conf. pz. 4	cad. € 33,90



Doroty Portavaso rotondo con ruote

Art. DOTSP	cm. 30 - nero (30x8h) conf. pz. 5	cad. € 24,90
Art. DOTSP	cm. 35 - nero (35x8h) conf. pz. 5	cad. € 27,90
Art. DOTSP	cm. 40 - nero (40x6h) conf. pz. 5	cad. € 29,90



Portavaso Quadrato Ruote Ferro

Art. 335	cm. 35	€ 23,90
Art. 335	cm. 45	€ 31,90
Art. 335	cm. 55	€ 36,90

Spostavasi regolabile Merlino

Art. MERSP	cm. 25/40 pz. 4	€ 39,90
------------	-----------------	---------

“... finchè saprò emozionarmi
saprò che le delusioni
non hanno vinto ...”



FINO ESAURIMENTO SCORTE



Rossana Portacassetta con ruote

Art. ROSSP	cm. 60 - nero (60x34x5h) conf. pz. 4	cad. € 40,90
Art. ROSSP	cm. 80 - nero (80x40x5h) conf. pz. 4	cad. € 42,90
Art. ROSSP	cm. 100 - nero (100x50x5h) conf. pz. 2	cad. € 49,90

Portavaso Tondo Ruote Ferro

Art. FO425	cm. 25x6,5h	€ 22,90
Art. FO430	cm. 30x6,5h	€ 26,90
Art. FO435	cm. 35x7h	€ 29,90
Art. FO440	cm. 40x7h	€ 31,90
Art. FO450	cm. 50x7,5h	€ 36,90



FINO ESAURIMENTO SCORTE

Portavaso Quadrato Ruote Ferro

Art. FO522	cm. 22x27x6,5h	€ 22,90
Art. FO529	cm. 29x33x6,5h	€ 27,90
Art. FO533	cm. 33x37x6,5h	€ 30,90



FINO ESAURIMENTO SCORTE

Portavaso Rettangolare Ruote Ferro

Art. FO660	cm. 60x30x7,5h	€ 50,90
Art. FO680	cm. 80x36x7,5h	€ 66,90
Art. FO6100	cm. 100x41x7,5h	€ 82,90



**FINO
ESAURIMENTO
SCORTE**

Tellus Vaso



			G9	30	01	62	T4	T6		
		Sottovaso Cons.	Tortora	Salvia	Cotto	Antracite	Oceano	Mattone		
art. 3200	cm. 20 cm 20x18h lt.3,8	Ø cm. 18	•	•	•	•	•	•	(10)	€ 2,60
art. 3201	cm. 25 cm 25x22h lt.7,4	Ø cm. 22	•	•	•	•	•	•	(10)	€ 3,70
art. 3202	cm. 30 cm 30x27h lt.12,5	Ø cm. 26	•	•	•	•	•	•	(10)	€ 5,70
art. 3203	cm. 35 cm 35x31h lt.20	Ø cm. 30	•	•	•	•	•	•	(10)	€ 7,10
art. 3204	cm. 40 cm 40x36h lt.30	Ø cm. 35	•	•	•	•	•	•	(10)	€ 8,90

S.vaso sabbaiato per Tellus



			G9	30	01	62	T4	T6		
		Vaso Cons	Tortora	Salvia	Cotto	Antracite	Oceano	Mattone		
art. 3205	cm. 18 cm 20x18h lt.3,8	Ø cm. 20	•	•	•	•	•	•	(10)	€ 1,20
art. 3206	cm. 22 cm 25x22h lt.7,4	Ø cm. 25	•	•	•	•	•	•	(10)	€ 1,40
art. 3207	cm. 26 cm 30x27h lt.12,5	Ø cm. 30	•	•	•	•	•	•	(10)	€ 2,00
art. 3208	cm. 30 cm 35x31h lt.20	Ø cm. 35	•	•	•	•	•	•	(10)	€ 3,00
art. 3209	cm. 35 cm 40x36h lt.30	Ø cm. 40	•	•	•	•	•	•	(10)	€ 4,10

I PREZZI RIPORTATI SONO ESCLUSI DI IVA



GREENER

Kezar Greener Cassetta con sottocassetta montata

art. 3147	cm. 40	40x20x16h lt.8	(12)	€ 7,80
art. 3148	cm. 50	50x20x16h lt.10	(12)	€ 9,50
art. 3149	cm. 60	60x20x16h lt.12	(12)	€ 11,50
art. 3150	cm. 80	80x20x16h lt.17	(6)	€ 16,50

G9	Tortora	01	Cotto	62	Antracite	30	Verde Salvia
----	---------	----	-------	----	-----------	----	--------------

ESPOSITORE KAI art. 3069 | cm. 65x90x183



Guya Vaso Greener

G9	01	62	30
----	----	----	----

art.	cm.	Sottov. Cons.	Tortora	Terracotta	Antracite	Verde Salvia		
art. 3134	cm. 20	cm 20x15h lt.2,9	Ø cm. 20	•	•	•	(10)	€ 2,30
art. 3135	cm. 25	cm 25x19h lt.5,6	Ø cm. 24	•	•	•	(10)	€ 3,40
art. 3136	cm. 30	cm 30x23h lt.9,7	Ø cm. 28	•	•	•	(10)	€ 5,20
art. 3137	cm. 35	cm 35x26h lt.15,4	Ø cm. 32	•	•	•	(10)	€ 6,50
art. 3138	cm. 40	cm 40x30h lt.23,2	Ø cm. 40	•	•	•	(10)	€ 8,20

Medea Sottovaso

G9	01	62	30
----	----	----	----

art.	cm.	Vaso Cons.	Tortora	Terracotta	Antracite	Verde Salvia		
art. 3139	cm. 20	(18x3,2h)	Ø cm. 20	•	•	•	(5)	€ 1,30
art. 3140	cm. 24*	(24x4h)	Ø cm. 25	•	•	•	(5)	€ 1,70
art. 3141	cm. 28*	(28x4,4h)	Ø cm. 30	•	•	•	(5)	€ 2,50
art. 3142	cm. 32*	(32x4,6h)	Ø cm. 35	•	•	•	(5)	€ 3,90
art. 3143	cm. 36	(36x5h)	Ø cm. 40	•	•	•	(5)	€ 5,80



Coprivaso Fyre

		03	62	D2	E5	X1	Z8	Z9	T4	T5	T6		
		Bianco	Antracite	Oliva	Ruggine	Mirage	Dune	Oasi	Oceano	Mango	Mattone		
art. 3218	cm. 20 (20,5 x 18 h) Lt. 4,3	●	●	●	●	●	●	●	●	●	●	(6)	€ 9,90
art. 3219	cm. 25 (25,5 x 23 h) Lt. 8,7	●	●	●	●	●	●	●	●	●	●	(6)	€ 13,90
art. 3220	cm. 30* (30,5 x 29 h) Lt. 15	●	●	●	●	●	●	●	●	●	●	(6)	€ 18,90
art. 3213	cm. 35* (35,5x34h) Lt. 23,5	●	●	●	●	●	●	●	●	●	●	(6)	€ 23,90
art. 3214	cm. 40* (40,5x39h) Lt. 35,6	●	●	●	●	●	●	●	●	●	●	(6)	€ 34,90

*misure 30, 35, 40 con ruote

I PREZZI RIPORTATI SONO ESCLUSI DI IVA



Coprivaso Over

001	271	238	239	241	246
Clay	Cloud	Black	Forest	Fog	Sand

art. 33706038	cm. 38 (38x36h)	•	•	•	•	•	•	(6)	€ 59,50
art. 33706048	cm. 48 (48x40h)	•	•	•	•	•	•	(6)	€ 89,50
art. 33706058	cm. 58 (58x47h)	•	•	•	•	•	•	(6)	€ 139,50



271



238



246



239



241



Coprivaso Rio

03	62	G9	E5	X1	Z8	Z9
Bianco	Antracite	Oliva	Ruggine	Mirage	Dune	Oasi

art. 3174	cm. 30 (29x29x24h) Lt. 13	•	•	•	•	•	•	(4)	€ 14,60
art. 3175	cm. 35 (34x34x28h) Lt. 20	•	•	•	•	•	•	(4)	€ 22,60
art. 3176	cm. 40 (39x39x32,5h) Lt. 31	•	•	•	•	•	•	(6)	€ 31,60





Colori Disponibili: **311** Snow | **005** Ash | **275** Lagoon | **287** Desert | **288** Clover | **289** Golden Lime | **290** Plum

Coprivaso Tiny

art. 30524007	cm. 7 (7x6,5h)	(10)	€ 2,60
art. 30524008	cm. 8 (8x7,5h)	(10)	€ 2,80
art. 30524010	cm. 10 (9,5x8,5h)	(10)	€ 3,90
art. 30524012	cm. 12 (11,5x10h)	(10)	€ 5,50



Caspò Pomo rotondo

		DLM	ETN	ETR	LAG	MNG	BLD		
		Avorio	Antracite	Tortora	Verde	Ocra	Blu		
art. VA060/15	cm. 15 Ø	•	•	•	•	•	•	(6)	€ 8,90
art. VA060/19	cm. 19 Ø	•	•	•	•	•	•	(6)	€ 12,90
art. VA060/23	cm. 23 Ø	•	•	•	•	•	•	(6)	€ 17,90



Vaso Bamboo rotondo

		DLM	ETN	ETR	LAG	MNG	BLD		
		Avorio	Antracite	Tortora	Verde	Ocra	Blu		
art. VA083/11,5	cm. 11,5 Ø	•	•	•	•	•	•	(10)	€ 3,90
art. VA083/13,5	cm. 13,5 Ø	•	•	•	•	•	•	(10)	€ 4,90
art. VA083/15,5	cm. 15,5 Ø	•	•	•	•	•	•	(10)	€ 5,90

I PREZZI RIPORTATI SONO ESCLUSI DI IVA



62 Antracite | T4 Oceano | T6 Mattone | D2 Oliva | 03 Bianco | E5 Ruggine |
Coprivaso Clivio Cass. Greener art. 3191 cm. 28 (28,5x13x15h) lt. 3 € 8,90



62 Antracite | T4 Oceano | T6 Mattone | D2 Oliva | 03 Bianco | E5 Ruggine |
Coprivaso Clivo Orchidea art. 3189 cm. 12,5 (12,5x15h) lt. 1,1 € 2,90



62 Antracite | T4 Oceano | T6 Mattone | D2 Oliva | 03 Bianco | E5 Ruggine |
Coprivaso Ono
 art. 3180 cm. 11 (11x11x10h) lt. 0,85 € 2,60
 art. 3181 cm. 13 (13x13x12h) lt. 1,4 € 3,40



62 Antracite | T4 Oceano | T6 Mattone | D2 Oliva | 03 Bianco | E5 Ruggine |
Coprivaso Clivo
 art. 3178 cm. 16 (16x16x16h) lt. 2,2 € 3,00
 art. 3177 cm. 14 (14x14x14h) lt. 1,4 € 2,40 art. 3179 cm. 18 (18x18x18h) lt. 3,1 € 3,80



Coprivaso Quadria
 art. 3211 cm. 16 (16x14,5h) Lt. 2,5 pz.6 € 3,80
 art. 3210 cm. 14 (14x12,5h) Lt. 1,7 pz.6 € 2,70 art. 3212 cm. 18 (18x16h) Lt. 3,6 pz.6 € 5,70



Colori Disponibili: T4 Oceano | T5 Mango | T6 Mattone | 03 Bianco |
 62 Antracite | D2 Oliva | E5 Ruggine



“... l'uomo impara
sempre a vivere
quando è troppo tardi ...”



Bianco

Giallo

Mandorla

Portvaso Paglia

art. 34014 - Antracite	cm. 14 (12)	€ 2,90
art. 34019 - Antracite	cm. 19 (12)	€ 3,90
art. 34024 - Antracite	cm. 24 (12)	€ 5,90
art. 34029 - Antracite	cm. 29 (12)	€ 7,90
art. 34016 - Bianco	cm. 14 (12)	€ 2,90
art. 34021 - Bianco	cm. 19 (12)	€ 3,90
art. 34026 - Bianco	cm. 24 (12)	€ 5,90
art. 34031 - Bianco	cm. 29 (12)	€ 7,90



Portvaso Mimosa

art. 30801	cm. 20 (20x13x17h) (24)	€ 2,90
art. 30802	cm. 25 (25x16x20h) (24)	€ 4,90
art. 30803	cm. 30 (30x20x24h) (24)	€ 5,90
art. 30804	cm. 35 (35x26x26h) (24)	€ 7,90



Arancio



Tortora



Rosso



Lilla

Asso Tre posti COLORI ASSORTITI

art. 520	cm. 10								€ 4,70
art. 520	cm. 12								€ 5,80
art. 520	cm. 14								€ 6,90



Tortora



Mandorla



Viola



Bianco



Rosso

Asso Due COLORI ASSORTITI

art. 522	cm. 10							€ 3,40
art. 522	cm. 12							€ 5,50
art. 522	cm. 14							€ 6,50



Viola



Arancio



Giallo



Verde



Tortora



Bianco



Ruggine



Fuxia

Coprivaso Milano

art. 431	cm. 11									€ 1,50
art. 431	cm. 13									€ 2,00
art. 431	cm. 15									€ 2,90
art. 431	cm. 18									€ 4,10
art. 431	cm. 20									€ 5,30
art. 431	cm. 22									€ 9,50
art. 431	cm. 25									€ 9,90



Vaso Iris trasparente

art. VA041/13	cm. 13 Ø (12)	€ 2,90
art. VA041/15	cm. 15 Ø (12)	€ 3,90
art. VA041/17	cm. 17 Ø (12)	€ 4,90

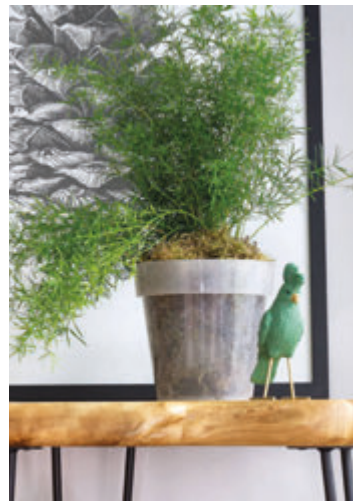

Caspò B-Living trasp.

art. VA024/11	cm. 11 Ø (12)	€ 3,90
art. VA024/13	cm. 13 Ø (12)	€ 4,90
art. VA024/15	cm. 15 Ø (12)	€ 5,90
art. VA024/17	cm. 17 Ø (12)	€ 6,90



Ciotola Living trasp.

art. CI022/20	cm. 20 (20x14,5h) (6)	€ 11,90
art. CI022/35	cm. 35 (35x16h) (6)	€ 15,90

FINO ESAURIMENTO SCORTE



Con Supporto interno disponibile solo le misure 14 e 16

Porto

art. 08083014	cm. 14 (14x15h)	€ 7,90	art. 08083020	cm. 20 (20x20h)	€ 14,50
art. 08083016	cm. 16 (16x16h)	€ 9,50	art. 08083025	cm. 25 (25x25h)	€ 21,90

FINO ESAURIMENTO SCORTE



Madeira trasparente

art. 08035011	cm. 11 (11x10h)	€ 4,00	art. 08035018	cm. 18 (18x16h)	€ 7,90
art. 08035014	cm. 14 (14x12h)	€ 4,90	art. 08035022	cm. 22 (22x20h)	€ 11,90
art. 08035016	cm. 16 (16x14h)	€ 5,90	art. 08035026	cm. 26 (25x23h)	€ 19,90



98 Satin

Clivo Satin vaso

art. 3182	cm. 14 (14x15h)	€ 2,40
art. 3183	cm. 16 (16x15h)	€ 2,90
art. 3184	cm. 18 (18x15h)	€ 3,70

Clivo Satin s/vaso

art. 3185	cm. 12 (12x2,4h)	€ 0,90
art. 3186	cm. 14 (14x2,8h)	€ 1,00
art. 3187	cm. 16 (16x3h)	€ 1,10

FINO ESAURIMENTO SCORTE



Algarve alto

art. 08018026	cm. 26 (15x15x26h)	€ 11,50
art. 08018035	cm. 35 (20x20x35h)	€ 25,90

Coimbra

art. 08082025024	cm. 25 (25x13x12h)	€ 11,90
art. 08082030024	cm. 30 (30x15x14h)	€ 14,90

FINO ESAURIMENTO SCORTE



"... se l'opportunità non bussava costruisci una porta..."

Orchidea

art. 08120014	cm. 14 (13x15h)	€ 7,90
art. 08120016	cm. 16 (15x18h)	€ 8,90

FINO ESAURIMENTO SCORTE



Forature Tecniche

Vaso orchidee Flores

art. 08127014024	cm. 14 (13x15h) (12)	€ 4,90
------------------	----------------------	--------

infrangibile



Fino ad esaurimento Scorte

Dekus Quadro Air

art. 2613	cm. 14 (14x2,3h)	(20)	€ 1,90
art. 2615	cm. 23 (23x3,8h)	(20)	€ 3,90
art. 2616	cm. 27 (27x4,5h)	(20)	€ 5,50
art. 2618	cm. 39 (39x6,3h)	(20)	€ 11,50

Air Sottovaso

art. 2619	cm. 10 (10x2,3h) lt. 1,8	(25)	€ 0,80
art. 2620	cm. 12 (11,9x2,5h) lt. 3,2	(25)	€ 1,30
art. 2621	cm. 14 (13,9x2,2h) lt. 5,3	(25)	€ 1,50
art. 2622	cm. 16 (15,7x3,1h) lt. 7,7	(25)	€ 1,70
art. 2623	cm. 18 (17,9x3,3h) lt. 12,3	(25)	€ 2,10
art. 2624	cm. 20 (19,8x3,5h) lt. 7,7	(25)	€ 2,50
art. 2625	cm. 22 (21,9x3,6h) lt. 12,3	(25)	€ 3,60
art. 2626	cm. 24 (23,9x3,9h) lt. 1,8	(25)	€ 4,30
art. 2627	cm. 26 (25,9x4,2h) lt. 3,2	(25)	€ 4,70
art. 2628	cm. 28 (27,9x4,5h) lt. 5,3	(25)	€ 5,20

infrangibile



art. 2629	cm. 30 (29,8x4,7h) lt. 7,7	(25)	€ 6,90
art. 2630	cm. 35 (34,9x5h) lt. 12,3	(25)	€ 8,80
art. 2631	cm. 40 (39,9x5,2h) lt. 7,7	(25)	€ 12,40
art. 2632	cm. 45 (45x5,5h) lt.	(25)	€ 16,50
art. 2633	cm. 50 (50x5,6h) lt.	(25)	€ 18,90



**Tutta la Linea
Fino ad
esaurimento
Scorte**



Mattone

T6

Mango

T5

Oceano

T4

**Tutta la Linea
Fino ad
esaurimento
Scorte**



*"... il mondo è pieno
di cose ovvie
che nessuno
si prende mai la cura
di osservare"*

Up Vaso e Cassetta a balcone con riserva d'acqua singoli

		G9	M9	O3	62	T4	T5	T6	L2	L4		
		Tortora	Sabbia	Bianco	Antracite	Oceano	Mango	Mattone	Rosso	Rosmarino		
art. 2988	cm. 25 (25x20x23h)	•	•	•	•	•	•	•	•	•	(6)	€ 7,90
art. 3059	cm. 50 (50x21x23h)	•	•	•	•	•	•	•	•	•	(6)	€ 16,90



**Tutta la Linea
Fino ad
esaurimento
Scorte**



Be Up Vaso e Cassetta a balcone con riserva d'acqua doppio

		G9	M9	03	62	L2	L4		
		Tortora	Sabbia	Bianco	Antracite	Rosso	Rosmarino		
art. 3032	cm. 25 (33x25x25h)	•	•	•	•	•	•	(6)	€ 14,90
art. 3048	cm. 50 (49,5x33x23h)	•	•	•	•	•	•	(6)	€ 20,90

I PREZZI RIPORTATI SONO ESCLUSI DI IVA



Rise Up Vaso a balcone con riserva d'acqua singoli

G9	M9	03	62	Z8	09	X1	L2	L4
Tortora	Sabbia	Bianco	Antracite	Dune	Oasi	Mirage	Rosso	Rosmarino

art. 3227	cm. 25 (25x20x23h)	•	•	•	•	•	•	•	(6)	€ 7,90
-----------	--------------------	---	---	---	---	---	---	---	-----	--------



Rise Up Cassetta a balcone con riserva d'acqua singoli

		G9	M9	03	62	Z8	09	01	L2	L4		
art. 3228	cm. 50 (50x21x23h)	Tortora	Sabbia	Bianco	Antracite	Dune	Oasi	Mirage	Rosso	Rosmarino	(6)	€ 7,90

I PREZZI RIPORTATI SONO ESCLUSI DI IVA

A photograph of a lemon tree in a white, tiered pot. The tree is lush green with several yellow lemons hanging from its branches. It is positioned in a modern outdoor setting with a dark wall, a table, and chairs in the background. The text 'MITU PAC' is overlaid in the upper right corner.

MITU PAC

FINO A 100 CM

*“... fai sempre del tuo meglio...
quello che pianti adesso...
lo raccoglierai poi...”*



Vaso Mitu Pac



			G9	L4	M9	01	03	62		
		Sottovaso Consigliato	Tortora	Rosmarino	Sabbia	Cotto	Bianco	Antracite		
art. 2888	cm. 14 (14x12h) lt.1	Ø cm. 12	•	•	•		•	•	(5)	€ 2,70
art. 2889	cm. 16 (16x14) lt.1,7	Ø cm. 14	•	•	•		•	•	(5)	€ 3,70
art. 2890	cm. 18 (18x16) lt.2,5	Ø cm. 16	•	•	•		•	•	(5)	€ 5,00
art. 2878	cm. 20 (20x18) lt.3,4	Ø cm. 18	•	•	•		•	•	(5)	€ 5,60
art. 2842	cm. 25 (25x22h) lt.6,7	Ø cm. 22	•	•	•		•	•	(5)	€ 8,90
art. 2843	cm. 30 (30x27) lt.11,5	Ø cm. 26	•	•	•		•	•	(5)	€ 12,40
art. 2844	cm. 35 (35x31h) lt.18,5	Ø cm. 30	•	•	•		•	•	(5)	€ 18,60
art. 2854	cm. 40 (40x36) lt.28	Ø cm. 36	•	•	•		•	•	(5)	€ 23,30
art. 2898	cm. 50 (50x45) lt.55	Ø cm. 44	•	•	•		•	•	(2)	€ 44,60
art. 2879	cm. 60 (60x53) lt.96	Ø cm. 52	•	•	•		•	•	(2)	€ 67,30
art. 2909	cm. 80 (80x71) lt.228	Ø cm. 64	•	•	•		•	•	(1)	€ 101,00
art. 2983	cm. 100 (88x99) lt.436	Ø cm. 82	•	•	•		•	•	(1)	€ 138,50



“... ci sono due regole nella vita:
n.1 - non mollare mai
n.2 - non dimenticare mai la regola n.1 ...”

Sottovaso Medea per vaso Mitu Pac

			G9	L4	M9	01	03	62		
		Vaso Consigliato	Tortora	Salvia	Sabbia	Cotto	Bianco	Antracite		
art. 1471	cm. 12 (12,8x2,1h)	Ø cm. 14	•	•	•		•	•	(5)	€ 0,70
art. 1472	cm. 14 (14,3x2,4h)	Ø cm. 16	•	•	•		•	•	(5)	€ 0,80
art. 1473	cm. 16 (15,9x2,6h)	Ø cm. 18	•	•	•		•	•	(5)	€ 0,90
art. 1474	cm. 18 (17,9x2,9h)	Ø cm. 20	•	•	•	•	•	•	(5)	€ 1,00
art. 1476	cm. 22 (22x3,7h)	Ø cm. 25	•	•	•	•	•	•	(5)	€ 1,60
art. 1478	cm. 26 (26x4,2h)	Ø cm. 30	•	•	•	•	•	•	(5)	€ 2,20
art. 1480	cm. 30 (30x4,4h)	Ø cm. 35	•	•	•	•	•	•	(5)	€ 3,30
art. 1482	cm. 36 (36x4,4h)	Ø cm. 40	•	•	•	•	•	•	(5)	€ 5,30
art. 1484	cm. 44 (44x5,8h)	Ø cm. 50	•	•	•		•	•	(2)	€ 7,20
art. 1486	cm. 52 (52x6,7)	Ø cm. 60	•	•	•		•	•	(2)	€ 10,00
art. 1488	cm. 64 (64x7)	Ø cm. 80	•	•	•		•	•	(1)	€ 14,90
art. 1960	cm. 82 (82x8,7)	Ø cm. 100	•	•	•		•	•	(1)	€ 24,00



Cassetta Mitu Pac

art. 2886 | cm. 50 (50x18x16,5h) | lt. 10,5 | € 11,90

Sottocassetta Inis

art. 1991 | cm. 50 (46,6x16,1x3h) | lt. 10,5 | € 3,20

Cassetta con riserva d'Acqua

art. 2907 | cm. 50 (50x18x16,5h) | lt. 1 | € 18,50

G9 Tortora | L4 Rosmarino | M9 Sabbia | 03 Bianco | 62 Antracite

G9 Tortora | L4 Rosmarino | M9 Sabbia | 03 Bianco | 62 Antracite



Liken Vaso

art. 3028 | cm. 27 (27x36h) | lt. 13 | € 9,90

art. 3029 | cm. 34 (34x46h) | lt. 26 | € 16,90

art. 3030 | cm. 41 (41x55h) | lt. 45 | € 25,60

G9 Tortora | L2 Rosso | M9 Sabbia | 03 Bianco | 62 Antracite

Sottovaso Medea per vaso Liken

		Vaso Consigliato		G9	L2	M9	03	62		
				Tortora	Rosso	Sabbia	Bianco	Antracite		
art. 1475	cm. 20 (22x3,6h)	Ø cm. 25		•	•	•	•	•	(5)	€ 1,50
art. 1477	cm. 24 (26x3,9h)	Ø cm. 30		•	•	•	•	•	(5)	€ 1,80
art. 1479	cm. 28 (30x4,4h)	Ø cm. 35		•	•	•	•	•	(5)	€ 2,60



G9



M9



62



03



G9



M9



03



62

Mitu Pac Cassetta con fori Sottocassetta Akea

art. 2915 | cm. 100 (99x40x40h) | lt.112 | € 70,50

art. 1689 | cm. 100 (90x36x5,7h) | € 20,50

G9 Tortora | M9 Sabbia | 03 Bianco | 62 Antracite

Mitu Pac Vaso Quadro

art. 2914 | cm. 40 (40x40x40h) | lt.41 | € 35,90

G9 Tortora | M9 Sabbia | 03 Bianco | 62 Antracite

Sottovaso Krea Quadro

art. 1711 | cm. 45 (36x36x5,7h) | € 9,80

“... ci sarà sempre una penna per scrivere il futuro ...”

... ma non ci sarà mai una gomma per cancellare il passato ...”



Mango T5



Oceano T4



Mattone T6



G9



M9



03



07



L2



07

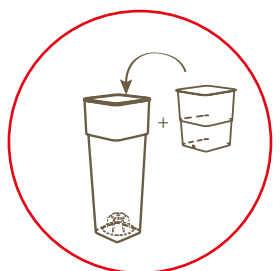

Con container

Vaso DUO Quadro e Tondo Satinato

		G9	M9	03	07	62	T4	T5	T6	L2		
		Tortora	Sabbia	Bianco	Nero	Antracite	Oceano	Mango	Mattone	Rosso		
art. 3014	cm. 80 (37x38x38x80h) lt.69 QUADRO	•	•		•	•	•	•	•		(2)	€ 65,00
art. 3013	cm. 80 (38x39x80h) lt.57 TONDO	•	•	•	•		•	•	•	•	(2)	€ 65,00



“... se qualcosa non ti piace cambiala...
se non puoi cambiarla
cambia
il tuo atteggiamento
ma non lamentarti ...”

Vaso TUIT Lucido

		G9	M9	03	T4	T5		
		Tortora	Sabbia	Bianco	Oceano	Mango		
art. 2785	cm. 33 (33x61h) lt.16		•	•	•	•	(2)	€ 58,00
art. 2858	cm. 40 (40x75h) lt.29	•	•	•	•	•	(2)	€ 79,00

I PREZZI RIPORTATI SONO ESCLUSI DI IVA



Vaso TUIT Raw Satinato

G9	62	30	03	E5	T6
Tortora	Antracite	Verde Salvia	Bianco	Ruggine	Mattone

art. 3216	cm. 33 (33x61h) lt.16	•	•	•	•	•	(2)	€ 62,00
art. 3217	cm. 40 (40x75h) lt.29	•	•	•	•	•	(2)	€ 85,00

I PREZZI RIPORTATI SONO ESCLUSI DI IVA



“... un semplice pensiero positivo al mattino può cambiare l'intera tua giornata ...”

Colori Disponibili:

AN Antracite | **TT** Tortora | **BI** Bianco

Colori Disponibili:

AN Antracite | **TT** Tortora | **BI** Bianco

Stalk Vaso Quadro

022 **406** **005**

		Bianco	Tortora	Antracite		
art. 28123065	cm. 38x65h lt. 21	•	•	•	(5)	€ 110,00
art. 28123080	cm. 38x80h lt. 21	•	•	•	(4)	€ 126,00

Vaso Esprit Quadro Alto

art. E14000530	cm. 39x53h	€ 85,00
art. E14000650	cm. 39x65h	€ 105,00
art. E14000800	cm. 43x80h	€ 125,00

Vaso Esprit Tondo Alto

art. E11000440	cm. 44x53h	€ 70,00
art. E11000460	cm. 46x65h	€ 95,00
art. E11000480	cm. 48x80h	€ 115,00



Stem Vaso Tondo

022 **406** **005**

		Bianco	Tortora	Antracite		
art. 28124065	cm. 38x65h lt. 21	•	•	•	(5)	€ 95,00
art. 28124080	cm. 38x80h lt. 21	•	•	•	(4)	€ 110,00



I PREZZI RIPORTATI SONO ESCLUSI DI IVA



03



E5



03



E5



G9



62



G9



62

Cassetta e vaso Kebe Satinato

	G9	62	03	E5	Z9	Z8		
	Tortora	Antracite	Bianco	Ruggine	Oasi	Dune		

art. 3154	cm. 100 (99,5x39,5x39,5h) lt.102	•	•	•	•	•		(2)	€ 129,90
art. 3157	cm. 40 (39,5x39,5x39,5h) lt.35	•	•	•	•	•		(2)	€ 59,90



*“... osare è perdere momentaneamente l'equilibrio
non osare è perdere se stessi ...”*



SAL



BCO



BR



ANT

Matheria Cassetta cm80x40

art. FI009-CM0080

(79x39x39h) lt.65

Disponibilità in 10/15gg

(2)

€ 149,90

BCO

Biaoco

ANT

Antracite

SAL

Tortora

BR

Ruggine

I PREZZI RIPORTATI SONO ESCLUSI DI IVA

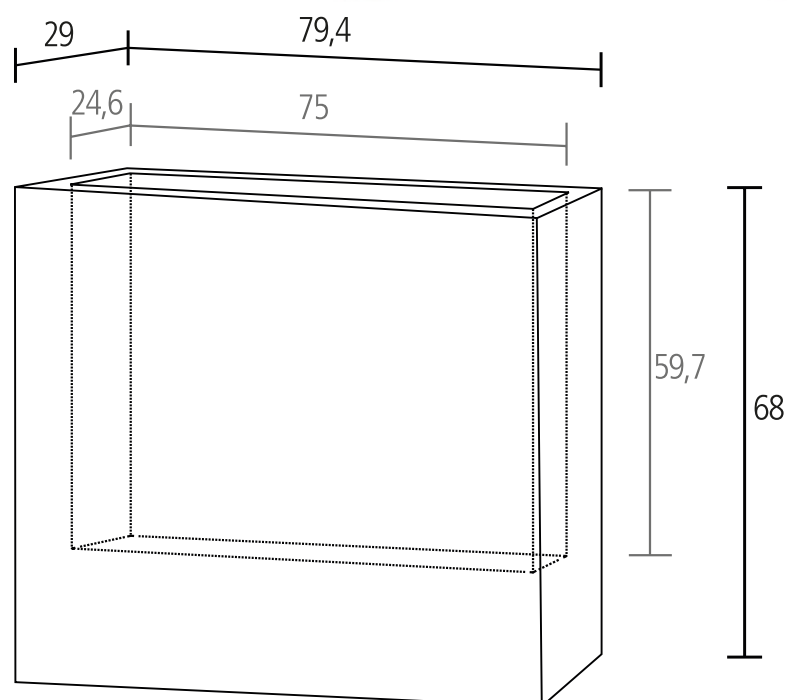

NOVITA'
2026



L'unica cassetta alta con piantumazione a tutta altezza.
Capacità contenimento terra Lt. 105.
Completa di riserva idrica e ruote per eventuali spostamenti.

Cassetta Alta Bruma

4N

Antracite

93

Beige/Tortora

51

Bianco Roccia

art. 070

cm. 79,4x29x68h Lt. 105

(2)

€ 189,90



Tyle vaso alto rotondo

		DLM	ATN	BR	LAG	MMT		
		Avorio	Antracite	Bronzo	Verde	Salvia		
art. CH370/37	cm. 37Ø x 85h	•	•	•	•	•	(2)	€ 129,90

Tyle vaso basso rotondo

art. VA370/50	cm. 50Ø x 45h	•	•	•	•	•	(2)	€ 95,90
art. VA370/60	cm. 60Ø x 55h	•	•	•	•	•	(2)	€ 129,90

Tyle cassetta rettangolare

art. CA370/60	cm. 60 x 30h	•	•	•	•	•	(2)	€ 89,90
art. CA370/80	cm. 80 x 40h	•	•	•	•	•	(2)	€ 105,90





E5



G9



M9



*“... se vuoi qualcosa che non hai mai avuto
devi fare qualcosa che non hai mai fatto ...”*



69



87

**Etria Vaso
doppia parete**



			C2	E5	G9	M9	69	87		
	Mis. Sottovaso		Bianco	Ruggine	Tortora	Sabbia	Avorio	Nero Perla		
art. 2453	cm. 24x20h lt. 5	Ø cm. ----	•	•		•	•	•	(1)	€ 38,00
art. 2318	cm. 34x28h lt. 14	Ø cm. ----	•	•	•	•	•	•	(1)	€ 53,00
art. 2319	cm. 44x36h lt. 30	Ø cm. ----	•	•	•	•	•	•	(1)	€ 90,00
art. 2320	cm. 54x44h lt. 56	Ø cm. ----	•	•	•	•	•	•	(1)	€ 148,00
art. 2447	cm. 64x52h lt. 86	Ø cm. ----	•	•	•	•	•	•	(1)	€ 288,00
art. 2454	cm. 74x61h lt. 131	Ø cm. ----	•	•	•	•	•	•	(1)	€ 397,00



C2



E5



G9



M9



87

**Etria Vaso
parete singola**



Mis. Sottovaso

C2

Bianco

E5

Ruggine

G9

Tortora

M9

Sabbia

87

Nero Perla

art.	cm. 24x20h	lit. 6	Ø cm. ----	•	•	•	•	•		
art. 2860	cm. 24x20h	lit. 6	Ø cm. ----	•	•	•	•	•	(1)	€ 31,00
art. 2861	cm. 34x28h	lit. 18	Ø cm. ----	•	•	•	•	•	(1)	€ 45,00
art. 2862	cm. 44x36h	lit. 39	Ø cm. ----	•	•	•	•	•	(1)	€ 76,00
art. 2863	cm. 54x44h	lit. 73	Ø cm. ----	•	•	•	•	•	(1)	€ 120,00
art. 2864	cm. 64x52h	lit. 123	Ø cm. ----	•	•	•	•	•	(1)	€ 246,00
art. 2865	cm. 74x61h	lit. 192	Ø cm. ----	•	•	•	•	•	(1)	€ 340,00

I PREZZI RIPORTATI SONO ESCLUSI DI IVA

*"...il piacere più grande nella vita
è fare ciò che le persone dicono
non puoi fare..."*

VASO IKON
FINO A MT 2

CHIUSO FINO AL BORDO
O TUTTO APERTO

Colori Disponibili: **G9** Tortora | **C2** Bianco | **87** Nero Perla | **E5** Ruggine

PRODUZIONE ESCLUSIVAMENTE SU RICHIESTA CON MINIMO PRODUTTIVO

Ikon Vaso con fori

Ikon Vaso con fori chiuso lt.767 Ikon sottovaso

art. 2996 | cm. 200x178h | lt.3139

€ 3.750,00 | art. 3012 | cm. 200x178h | lt.767

€ 3.750,00 | art. 3008 | cm. 141x12h

€ 192,00



S3



“...come sarebbe bello potersi dire...
noi ci amiamo tanto... tanto da morire...
qualunque cosa accada... noi questa sera...
ci vediamo a casa ...”



C2



E5



G9



M9



S4



87

Ikon Vaso



Sottovaso Consigliato

				C2	E5	G9	M9	S3	S4	87		
				Bianco	Ruggine	Tortora	Sabbia	Cemento	Granito	Nero Prla		
art. 2603	cm. 40x36h lt.23			•		•				•	(1)	€ 98,00
art. 2604	cm. 50x44h lt.47	2607 cm. 50	€ 22,00	•	•	•	•	•	•	•	(1)	€ 133,00
art. 2605	cm. 60x53h lt.82	2608 cm. 60	€ 30,00	•	•	•	•	•	•	•	(1)	€ 198,00
art. 2896	cm. 70x62h lt.130	2897 cm. 70	€ 35,00	•	•	•	•	•	•	•	(1)	€ 262,00
art. 2541	cm. 80x71h lt.202	2598 cm. 80	€ 40,00	•	•	•	•	•	•	•	(1)	€ 333,00
art. 2542	cm. 100x89h lt.398	2599 cm. 100	€ 54,00	•	•	•	•	•	•	•	(1)	€ 543,00
art. 2543	cm. 120x107h lt.680	2600 cm. 120	€ 70,00	•	•	•	•			•	(1)	€ 835,00
art. 2786	cm. 140x125h lt.1066	2814 cm. 140	€ 85,00	•	•	•				•	(1)	€ 2.050,00
art. 2787	cm. 160x143h lt.1594	2815 cm. 160	€ 101,00	•	•	•				•	(1)	€ 2.370,00

I PREZZI RIPORTATI SONO ESCLUSI DI IVA



C2



87



E5

Ilie Vaso Tondo Satinato

		C2	87	E5		
		Bianco	Nero Perla	Ruggine		
art. 2497	cm. 37x75h lt.13	•	•	•	(2)	€ 187,00
art. 2498	cm. 42x90h lt.19	•	•	•	(2)	€ 255,00
art. 2415	cm. 47x98h lt.26	•	•	•	(2)	€ 317,00
art. 2506	cm. 57x126h lt.54	•	•	•	(2)	€ 482,00



E5



87



C2

Kiam Vaso Quadro Satinato

		C2	87	E5		
		Bianco	Nero Perla	Ruggine		
art. 2499	cm. 35x35x75h lt. 13	•	•	•	(2)	€ 187,00
art. 2500	cm. 40x40x90h lt. 20	•	•	•	(2)	€ 281,00



S4

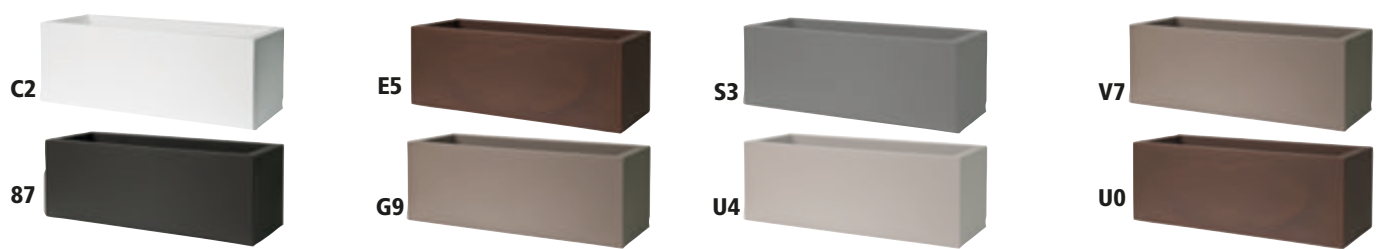

Kube Cassetta

		C2	E5	G9	S3	S4	87	U0	U4	V7		
		Bianco	Ruggine	Tortora	Cemento	Granito	Nero Perla	Lava	Pietra	Creta		
art. 2601	cm. 80 (80x30x30h) lt.77	•	•	•	•	•	•	•	•	•	(1)	€ 241,00
art. 2548	cm. 100 (100x40x40h) lt.77	•	•	•	•	•	•	•	•	•	(1)	€ 307,00

Kube Cassetta con ruote

		C2	E5	G9	S3	S4	87	U0	U4	V7		
		Bianco	Ruggine	Tortora	Cemento	Granito	Nero Perla	Lava	Pietra	Creta		
art. 2753	cm. 80 (80x30x30h) lt.77	•	•	•	•	•	•	•	•	•	(1)	€ 317,00
art. 2590	cm. 100 (100x40x40h) lt.77	•	•	•	•	•	•	•	•	•	(1)	€ 383,00



Kube Vaso Quadro

		C2	E5	G9	S3	S4	87	U0	U4	V7		
		Bianco	Ruggine	Tortora	Cemento	Granito	Nero Perla	Lava	Pietra	Creta		
art. 2538	cm. 30x30x30h lt.9	•	•	•	•	•	•	•	•	•	(1)	€ 67,00
art. 2514	cm. 40x40x40h lt.22	•	•	•	•	•	•	•	•	•	(1)	€ 116,00
art. 2515	cm. 50x50x50h lt.45	•	•	•	•	•	•	•	•	•	(1)	€ 188,00

Kube Vaso Quadro con ruote

		C2	E5	G9	S3	S4	87	U0	U4	V7		
		Bianco	Ruggine	Tortora	Cemento	Granito	Nero Perla	Lava	Pietra	Creta		
art. 2587	cm. 30x30x30h lt.9	•	•	•	•	•	•	•	•	•	(1)	€ 118,00
art. 2588	cm. 40x40x40h lt.22	•	•	•	•	•	•	•	•	•	(1)	€ 168,00
art. 2589	cm. 50x50x50h lt.45	•	•	•	•	•	•	•	•	•	(1)	€ 239,00

I PREZZI RIPORTATI SONO ESCLUSI DI IVA

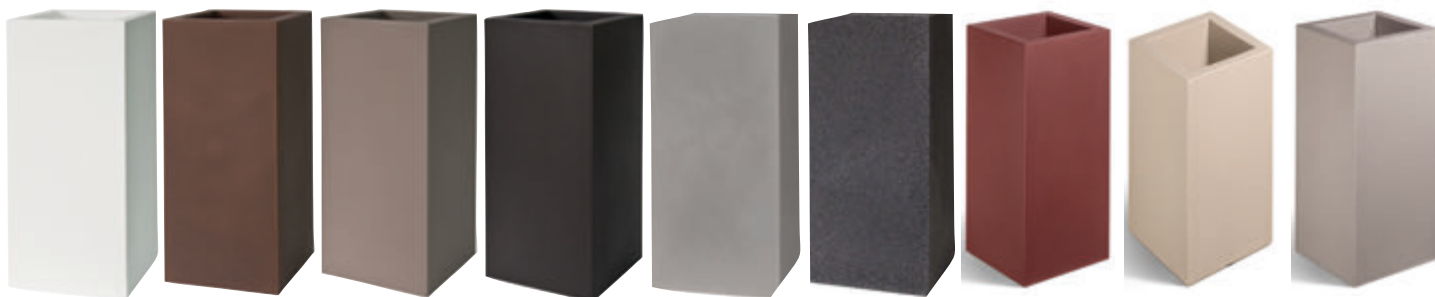

		C2	E5	G9	87	S3	S4	87	U0	U4	V7		
		Bianco	Ruggine	Tortora	Cemento	Granito	Nero Perla	Lava	Pietra	Creta			
art. 2611	cm. cm. 30 (30x30x71h) lt.9	•	•	•	•	•	•	•	•	•	•	(1)	€ 183,00
art. 2612	cm. 40 (40x40x70h) lt.9	•	•	•	•	•	•	•	•	•	•	(1)	€ 248,00

		C2	E5	G9	S3	S4	87	U0	U4	V7		
		Bianco	Ruggine	Tortora	Cemento	Granito	Nero Perla	Lava	Pietra	Creta		
art. 2733	cm. cm. 30 (30x30x71h) lt.9	•	•	•	•	•	•	•	•	•	(1)	€ 235,00
art. 2734	cm. 40 (40x40x70h) lt.9	•	•	•	•	•	•	•	•	•	(1)	€ 298,00

		C2	E5	G9	S3	S4	87	U0	U4	V7		
		Bianco	Ruggine	Tortora	Cemento	Granito	Nero Perla	Lava	Pietra	Creta		
art. 2602	cm. 80 (80x30x70h) lt.32	•	•	•	•	•	•	•	•	•	(1)	€ 346,00
art. 2586	cm. 100 (100x40x70h) lt.77	•	•	•	•	•	•	•	•	•	(1)	€ 433,00

		C2	E5	G9	S3	S4	87	U0	U4	V7		
		Bianco	Ruggine	Tortora	Cemento	Granito	Nero Perla	Lava	Pietra	Creta		
art. 2754	cm. 80 (80x30x70h) lt.32	•	•	•	•	•	•	•	•	•	(1)	€ 422,00
art. 2591	cm. 100 (100x40x70h) lt.77	•	•	•	•	•	•	•	•	•	(1)	€ 509,00

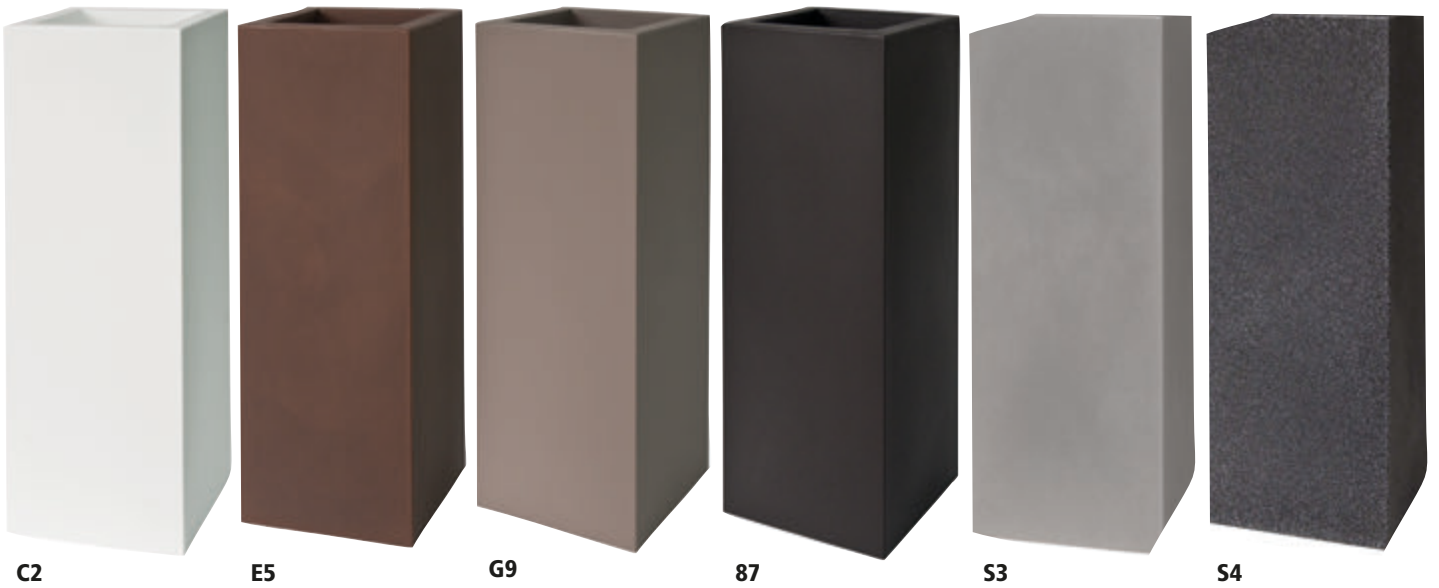

**Kube High Slim
Vaso Alto**

art. 2788 cm. 25 (25x25x70h) lt.8,8

C2	E5	G9	S3	S4	87		
Bianco	Ruggine	Tortora	Cemento	Granito	Nero Perla		
	•	•	•	•	•	(1)	€ 147,00

**Kube High Slim
Cassetta Alta**

art. 2777 cm. 80 (80x25x70h) lt.32

C2	E5	G9	S3	S4	87		
Bianco	Ruggine	Tortora	Cemento	Granito	Nero Perla		
	•	•	•	•	•	(1)	€ 293,00

I PREZZI RIPORTATI SONO ESCLUSI DI IVA

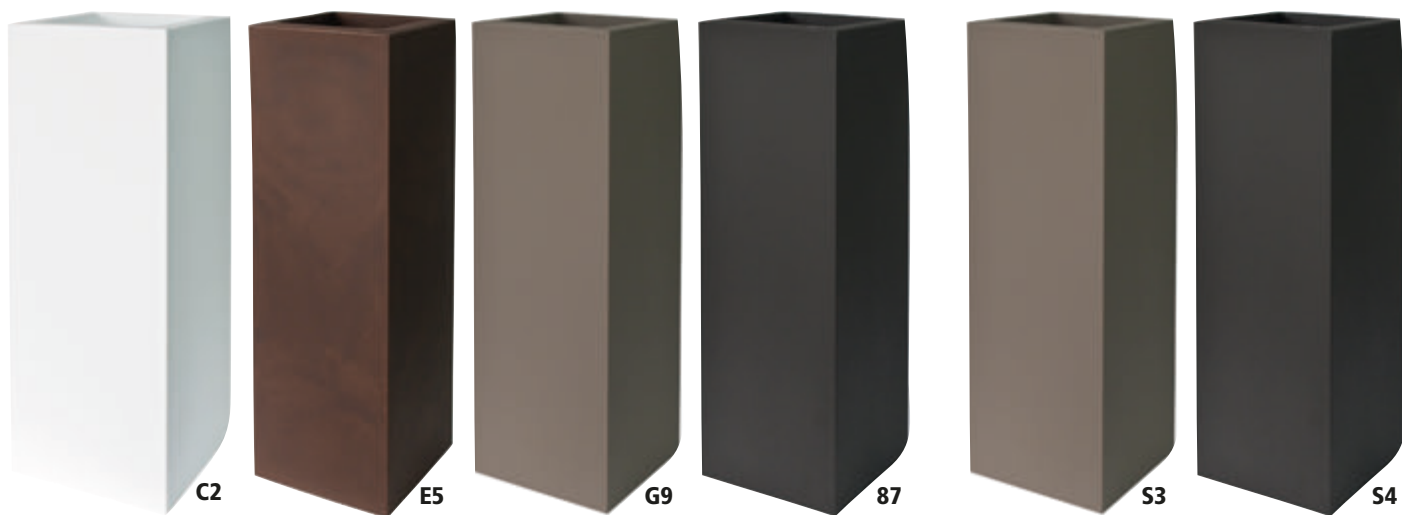

Kube Tower Vaso Alto

art. 2826 cm. 30 (30x30x90h) lt.10

C2	E5	G9	87	S3	S4	87		
Bianco	Ruggine	Tortora	Cemento	Granito	Nero Perla			
	•	•	•	•	•	•	(1)	€ 187,00

Kube Tower Cassetta Alta

art. 2825 cm. 70 (70x30x90h) lt.29

C2	E5	G9	87	S3	S4	87		
Bianco	Ruggine	Tortora	Cemento	Granito	Nero Perla			
	•	•	•	•	•	•	(1)	€ 346,00

I PREZZI RIPORTATI SONO ESCLUSI DI IVA



Etria

U0	V6	U4	V5	87	G9	C2	E5		
Lava	Marea	Pietra	Menta	Nero Perla	Tortora	Bianco	Ruggine		

art. 2904	cm. 18 (18 x 18 x 14,5h) lt. 2,4								(2)	€ 12,90
art. 2860	cm. 24 (24 x 24 x 20h) lt. 6	•	•	•	•				(2)	€ 18,90



Kube

U0	V6	U4	V5	87	G9	C2	E5		
Lava	Marea	Pietra	Menta	Nero Perla	Tortora	Bianco	Ruggine		

art. 2827	cm. 18 (18 x 18 x 18h) lt. 2,7								(2)	€ 12,90
art. 2634	cm. 20 (20 x 20 x 20h) lt. 2,7	•	•	•	•				(2)	€ 21,90



Ikon Simple

U0	V6	U4	V5	87	G9	C2	E5		
Lava	Marea	Pietra	Menta	Nero Perla	Tortora	Bianco	Ruggine		

art. 2635	cm. 20 (20 x 20 x 17,5h) lt. 1,7								(2)	€ 12,90
art. 3063	cm. 30 (30 x 30 x 26h) lt. 11	•	•	•	•				(2)	€ 18,90
art. 3060	cm. 40 (40 x 40 x 35h) lt. 26	•	•	•	•				(2)	€ 31,90



Kube Mini Cassetta e Vaso

C2	G9			
Bianco	Tortora			

art. 2828	cm. 50 (50x18x18h) lt.9		•					(2)	€ 74,00
art. 2776	cm. 60 (60x20x20h) lt.11,5		•					(2)	€ 97,00

LEGENDA ABBINAMENTI RISERVE D'ACQUA

Kube Cassetta

		Kit Riserva d'acqua Abbinabile			
art. 2601	cm. 80	art. A4327	17x51	(1)	€ 53,00
art. 2548	cm. 100	art. A4278	24x72	(1)	€ 59,00

Kube Cassetta con ruote

		Kit Riserva d'acqua Abbinabile			
art. 2753	cm. 80	art. A4327	17x51	(1)	€ 53,00
art. 2590	cm. 100	art. A4278	24x72	(1)	€ 59,00

Kube Vaso Quadro

		Kit Riserva d'acqua Abbinabile			
art. 2538	cm. 30	art. A4255	17x17	(1)	€ 37,00
art. 2514	cm. 40	art. A4241	24x24	(1)	€ 43,00
art. 2515	cm. 50	art. A4242	30x30	(1)	€ 44,00

Kube Vaso Quadro con ruote

		Kit Riserva d'acqua Abbinabile			
art. 2587	cm. 30	art. A4255	17x17	(1)	€ 37,00
art. 2588	cm. 40	art. A4241	24x24	(1)	€ 43,00
art. 2589	cm. 50	art. A4242	30x30	(1)	€ 44,00

Kube High Vaso Alto

		Kit Riserva d'acqua Abbinabile			
art. 2611	cm. 30	art. A4255	17x17	(1)	€ 37,00
art. 2612	cm. 40	art. A4241	24x24	(1)	€ 43,00

Kube High Vaso Alto con ruote

		Kit Riserva d'acqua Abbinabile			
art. 2733	cm. 30	art. A4255	17x17	(1)	€ 37,00
art. 2734	cm. 40	art. A4241	24x24	(1)	€ 43,00

Kube High Cassetta Alta

		Kit Riserva d'acqua Abbinabile			
art. 2602	cm. 80	art. A4327	17x51	(1)	€ 53,00
art. 2586	cm. 100	art. A4278	24x72	(1)	€ 59,00

Kube High Cassetta Alta con ruote

		Kit Riserva d'acqua Abbinabile			
art. 2754	cm. 80	art. A4327	17x51	(1)	€ 53,00
art. 2591	cm. 100	art. A4278	24x72	(1)	€ 59,00

Kube High Slim Vaso Alto

		Kit Riserva d'acqua Abbinabile			
art. 2788	cm. 25	art. A4255	17x17	(1)	€ 37,00

Kube High Slim Cassetta Alta

		Kit Riserva d'acqua Abbinabile			
art. 2777	cm. 80	art. A4327	17x51	(1)	€ 53,00

Kube Tower Vaso Alto

		Kit Riserva d'acqua Abbinabile			
art. 2826	cm. 30	art. A4255	17x17	(1)	€ 37,00

Kube Tower Cassetta Alta

		Kit Riserva d'acqua Abbinabile			
art. 2825	cm. 70	art. A4327	17x51	(1)	€ 53,00

Vaso TUIT Raw Satinato

		Kit Riserva d'acqua Abbinabile			
art. 3216	cm. 33	art. A4374	25x25	(1)	€ 43,00
art. 3217	cm. 40	art. A4430	32x32	(1)	€ 44,00

Ilie Vaso Tondo Satinato

		Kit Riserva d'acqua Abbinabile			
art. 2497	cm. 37	art. A4256	20x20	(1)	€ 42,00
art. 2498	cm. 47	art. A4239	25x25	(1)	€ 43,00
art. 2506	cm. 57	art. A4240	32x32	(1)	€ 44,00

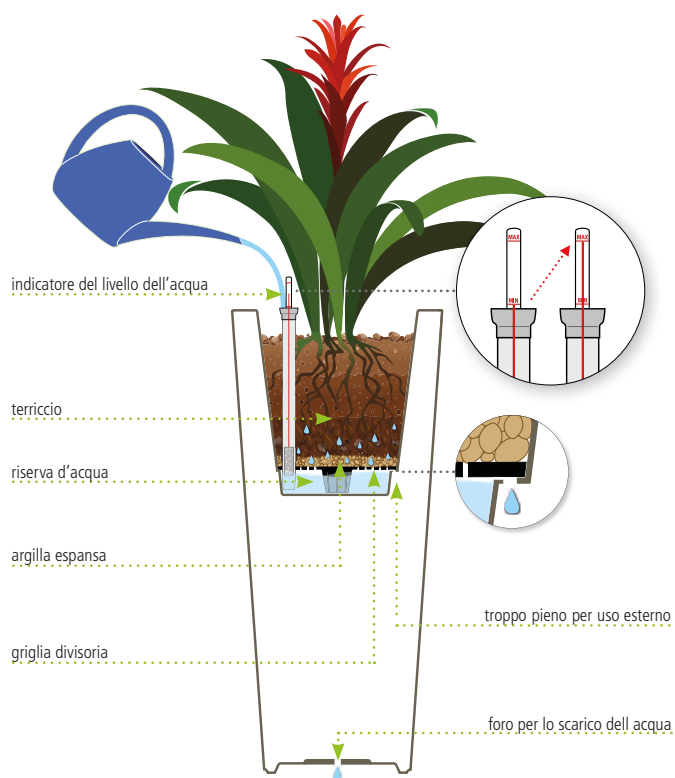

griglia divisoria



argilla espansa



indicatore del livello dell'acqua

“... scegli un lavoro che ami
e non dovrai lavorare
nemmeno un giorno in vita tua ...”



45

45

Vaso Festonato Eur Eur Sottovaso

art. 1712	cm. 40	(39x32h) lt.20	€ 44,00	art. 1719	cm. 28	(28x3,3h)	€ 8,00
art. 1713	cm. 45	(46x37h) lt.27	€ 49,00	art. 1720	cm. 32	(32x3,6h)	€ 10,00
art. 1714	cm. 50	(50x39h) lt.38	€ 59,00	art. 1721	cm. 35	(35x3,8h)	€ 12,00
art. 1715	cm. 55	(55x45h) lt.53	€ 84,00	art. 1722	cm. 37	(37x4,3h)	€ 19,00
art. 2171	cm. 60	(60x48h) lt.71	€ 110,00	art. 2172	cm. 43	(43x5h)	€ 26,00
art. 1716	cm. 65	(64x52) lt.91	€ 129,00	art. 1723	cm. 45	(46x4,7h)	€ 28,00
art. 1717	cm. 70	(69x57) lt.118	€ 150,00	art. 1724	cm. 50	(50x4,8h)	€ 29,00
art. 1718	cm. 75	(75x60h) lt.146	€ 157,00	art. 1725	cm. 54	(50x5,4h)	€ 32,00
art. 1729	cm. 85	(85x60h) lt.215	€ 239,00	art. 1732	cm. 62	(62x5,9h)	€ 38,00
art. 1730	cm. 95	(94x77h) lt.304	€ 366,00	art. 1733	cm. 68	(68x6,1h)	€ 44,00
art. 1731	cm. 110	(106x85h) lt.401	€ 497,00	art. 1734	cm. 73	(73x7,3h)	€ 51,00

Vaso Doppio Bordo Eur Sottovaso D. B. Eur

art. 1746	cm. 35	(35x32h) lt.15	€ 35,00	art. 1790	cm. 25	(26x3,6h)	€ 7,00
art. 1747	cm. 40	(42x37h) lt.24	€ 44,00	art. 1791	cm. 30	(30x3,5h)	€ 10,00
art. 1748	cm. 45	(45x40h) lt.32	€ 49,00	art. 1792	cm. 33	(33x3,3h)	€ 11,00
art. 1749	cm. 50	(51x44h) lt.44	€ 59,00	art. 1793	cm. 36	(37x3,9h)	€ 16,00
art. 1750	cm. 55	(55x47h) lt.60	€ 84,00	art. 1794	cm. 40	(41x4h)	€ 24,00
art. 1751	cm. 60	(60x51h) lt.77	€ 110,00	art. 1795	cm. 43	(44x4,2h)	€ 26,00
art. 1752	cm. 65	(65x56h) lt.100	€ 129,00	art. 1796	cm. 49	(49x4,5h)	€ 28,00
art. 1753	cm. 75	(77x61h) lt.150	€ 157,00	art. 1797	cm. 54	(54x5h)	€ 31,60
art. 1754	cm. 85	(85x68h) lt.210	€ 239,00	art. 1798	cm. 61	(61x5h)	€ 37,00

I PREZZI RIPORTATI SONO ESCLUSI DI IVA

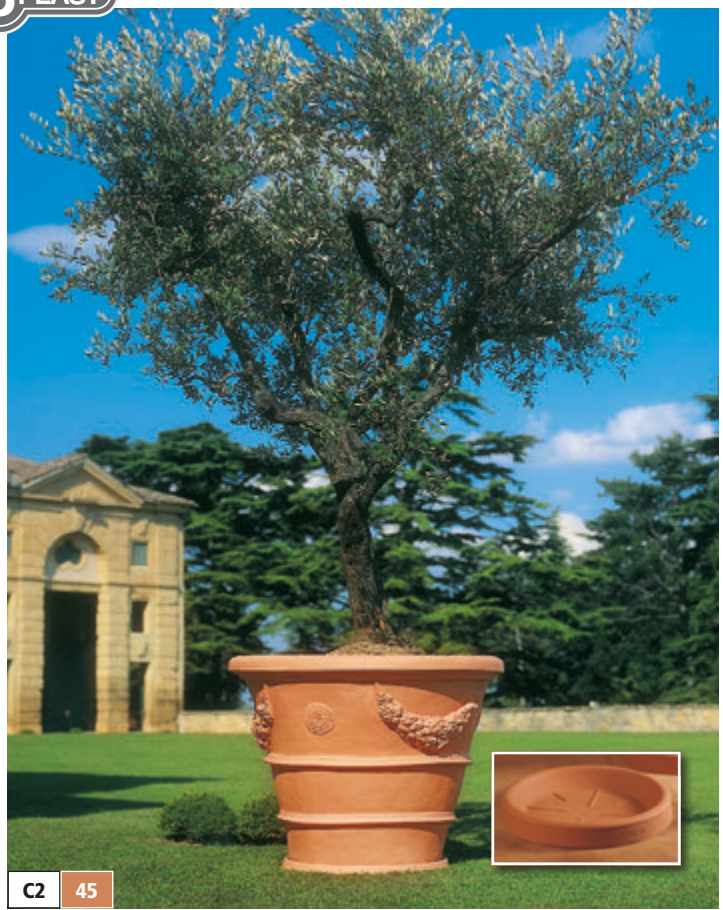
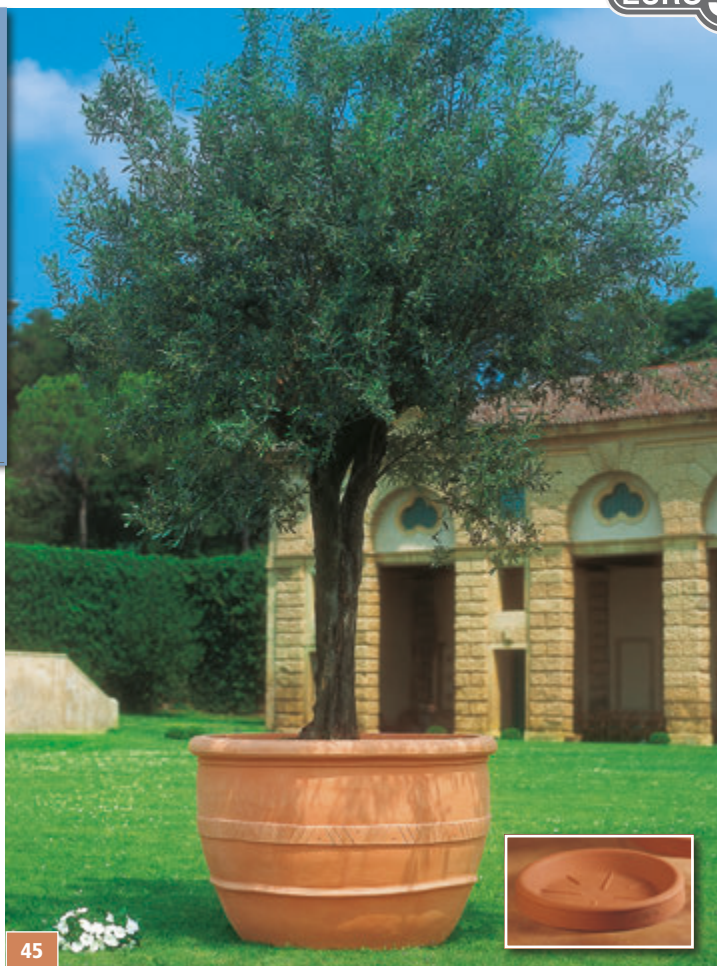

45

Conca Olivum			Sottovaso		
art. 2173	cm. 115 (115x81h)	lt.555 € 1.320,00	art. 2174	cm. 115	€ 108,00
art. 2121	cm. 148 (145x96h)	lt.1100 € 1.946,00	art. 2127	cm. 148	€ 136,00

C2 45

Ornato Vaso			Ornato Sottovaso		
art. 2071	cm. 87 (87x77h)	lt.150 € 391,00	art. 2099	cm. 87 (55x6h)	€ 33,00
art. 2072	cm. 102 (102x78h)	lt.270 € 708,00	art. 2100	cm. 102 (68x6,5h)	€ 49,00
art. 2073	cm. 114 (114x88h)	lt.480 € 1.020,00	art. 2101	cm. 114 (75x6h)	€ 57,00
art. 2074	cm. 150 (150x115h)	lt.850 € 1.495,00	art. 2102	cm. 150 (90x6,7h)	€ 72,00



45

Siepi Vaso a Muro	
art. 2289	cm. 52 (52x27x56h) € 141,00

G9 45

Cilindro Vaso			Sottovaso		
art. 2294	cm. 50 (52x38h)	lt.50 € 115,00	art. 2296	cm. 50	€ 30,00
art. 2165	cm. 60 (62x43h)	lt.80 € 146,00	art. 2170	cm. 60	€ 39,00
art. 2164	cm. 70 (72x50h)	lt.130 € 206,00	art. 2169	cm. 70	€ 44,00
art. 2163	cm. 90 (90x63h)	lt.260 € 403,00	art. 2168	cm. 90	€ 55,00
art. 2162	cm. 110 (110x77h)	lt.480 € 904,00	art. 2167	cm. 110	€ 98,00
art. 2161	cm. 130 (130x91h)	lt.800 € 1.368,00	art. 2166	cm. 130	€ 117,00
art. 2151	cm. 150 (150x102h)	lt.1150 € 1.821,00	art. 2156	cm. 150	€ 131,00



Siepi Cassetta Doppia Parete

Colori Disponibili: **45** Cotto | **G9** Tortora | **87** Nero Perla

art. 2376	cm. 120 (120x55x48) lt.198	€ 425,00
art. 2383	Sottocassetta cm. 120 (127x61x6,8h)	€ 109,00

Siepi Cassetta Mono Parete

art. 2234	cm. 80 (80x39x35h)	€ 168,00
art. 2217	cm. 100 (100x47x41h)	€ 255,00

Siepi Sottocassetta

art. 1887	cm. 80	€ 50,00
art. 1883	cm. 100	€ 65,00



Siepi Vaso Quadro Doppia Parete

art. 2288	cm. 55 (55x55x48) lt.78	€ 167,00
art. 2317	cm. 71 (71x71x62) lt.171	€ 303,00

Siepi Vaso Quadro

art. 2235	cm. 39 (39x39x35h) lt.31	€ 108,00
art. 2216	cm. 47 (47x47x41h) lt.71	€ 128,00

Sottovaso Quadro

art. 2093	cm. 61 (61x61x6,8h)	€ 43,00
art. 2095	cm. 74 (74x74x8h)	€ 69,00

Siepi Sott. Quadro

art. 1630	cm. 42	€ 29,00
art. 1631	cm. 48	€ 35,00

I PREZZI RIPORTATI SONO ESCLUSI DI IVA



Millerighe Eur Vaso Quadro

art. 1810	cm. 30 (31x31x29h) lt.18	€ 71,00
art. 1811	cm. 35 (35x35x32h) lt.28	€ 85,00
art. 1812	cm. 45 (44x44x38h) lt.51	€ 105,00
art. 2283	cm. 55 (55x55x45h) lt.76	€ 141,00

Neze Sott. Quadrato

art. 1629	cm. 36 (36x36x4,5h)	€ 22,00
art. 1630	cm. 42 (42x42x5,2h)	€ 29,00
art. 1631	cm. 48 (49x49x5,6h)	€ 35,00
art. 1632	cm. 54 (55x55x6h)	€ 37,00

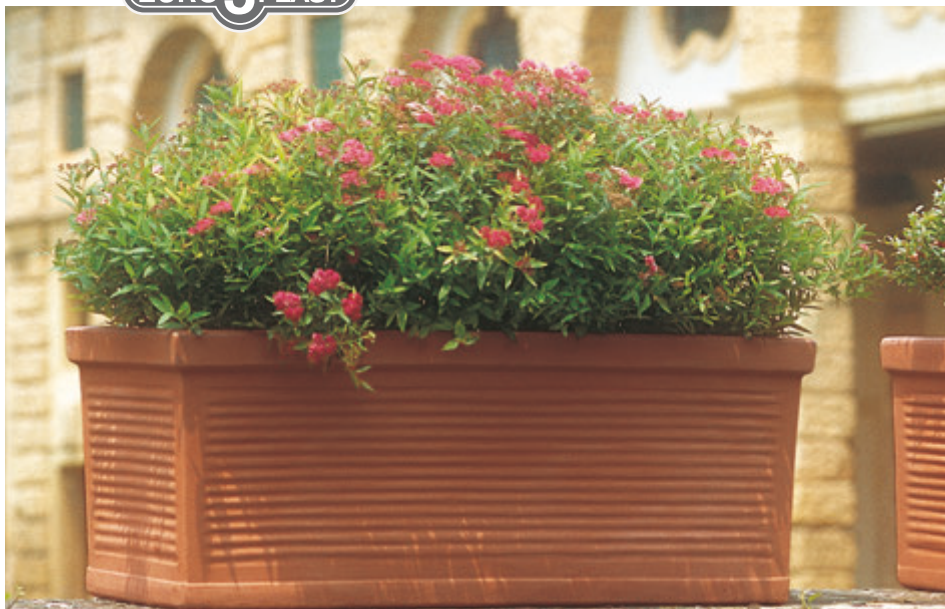

Millerighe Eur Cassetta

Colori Disponibili: **31** Cotto | **45** Cotto Terra di Siena

art. 1805	cm. 60 (58x26x29h) lt.29	€ 79,00
art. 1806	cm. 70 (68x31x29h) lt.45	€ 94,00
art. 1807	cm. 80 (77x35x32) lt.70	€ 128,00
art. 1808	cm. 100 (97x44x38h) lt.128	€ 185,00

Sottocassetta Millerighe

art. 1885	cm. 60 (63x31x4h)	€ 34,00
art. 1886	cm. 70 (72x36x4h)	€ 43,00
art. 1887	cm. 80 (80x40x4h)	€ 50,00
art. 1883	cm. 100 (100x47x4h)	€ 65,00



Balastra Liscia Cassetta

art. 2357	cm. 50 (50x25x26h) lt.25	€ 75,00
art. 2358	cm. 60 (60x25x26h) lt.30	€ 88,00
art. 2359	cm. 80 (80x25x26h) lt.40	€ 128,00
art. 2248	cm. 100 (100x25x26h) lt.50	€ 194,00

Sottocassetta

Colori Disponibili: **31** Cotto | **45** Cotto Terra di Siena

art. 2379	cm. 50 (80x31h)	€ 36,00
art. 2380	cm. 60 (100x31h)	€ 42,00
art. 1824	cm. 80 (80x31h)	€ 50,00
art. 1825	cm. 100 (100x31h)	€ 65,00

“... abbiate il coraggio di seguire il vostro cuore e la vostra intuizione, in qualche modo loro sanno cosa volete realmente diventare, tutto il resto è secondario ...”



Giottus Ciotola

art. 2139	cm. 30 (30x13h)	€ 31,00
art. 2140	cm. 42 (42x17h)	€ 65,00
art. 2141	cm. 55 (55x22h)	€ 85,00
art. 2284	cm. 70 (73x28h) lt.25	€ 165,00
art. 2142	cm. 85 (85x31h)	€ 176,00
art. 2143	cm. 100 (100x36h) lt.11	€ 249,00
art. 2066	cm. 130 (130x43h) lt.16	€ 450,00

Sott. ciotola Giottus

art. 2135	cm. 22 (22x3,4h)	€ 8,50
art. 1546	cm. 30 (30x5h)	€ 21,00
art. 1548	cm. 36 (36x5h)	€ 27,00
art. 1551	cm. 53 (53x5,5h)	€ 46,00
art. 1552	cm. 56 (56x6h)	€ 49,50
art. 1553	cm. 63 (63x7h)	€ 53,00
art. 1587	cm. 77 (77x7,5h)	€ 83,00



Autunno

art. 1537 | cm. 38x32x122h

€ 331,00

Inverno

art. 1539 | cm. 38x32x122h

€ 331,00



Primavera

art. 1540 | cm. 41x33x119h

€ 331,00

Estate

art. 1538 | cm. 37x34x121h

€ 331,00



Venere

art. 1222 | cm. 41x38x165h

€ 520,00



Venere di Milo

art. 1416 | cm. 42x41x162h

€ 520,00



Basamento Pamir

art. 1367 | cm. 43x43x38

€ 156,00



Piedistallo Statua

art. 1223 | cm. 48x38

€ 139,00



Basamento 4 Stagioni

art. 1541 | cm. 45x19

€ 99,00

I PREZZI RIPORTATI SONO ESCLUSI DI IVA



67

Etrusca Fioriera

art. 1939	cm. 25 (25x33h) lt.2	€ 84,00	art. 1181	cm. 50 (48x54h) lt.20	€ 229,00
art. 1944	cm. 40 (38x42h) lt.7	€ 139,00	art. 1213	cm. 65 (61x71h) lt.30	€ 316,00



67

Impero Fioriera

art. 1945	cm. 35 (35x33h) lt.2	€ 136,00	art. 1946	cm. 50 (48x54h) lt.20	€ 256,00
			art. 1237	cm. 65 (61x71h) lt.30	€ 339,00



Colonna Pompei

art. 1297	cm. 210 (43x43x210h)	€ 739,00
-----------	----------------------	----------

Colonna Creta

art. 1298	cm. 110 (44x44x105h)	€ 291,00
-----------	----------------------	----------



Capitello Pompei

art. 1460	cm. 50x50x71h	€ 341,00
-----------	---------------	----------



Colonna Lindos

art. 1604	cm. 40 (36x40h)	€ 109,00
art. 1605	cm. 69 (36x69h)	€ 169,00



Colonna Zetis

art. 2120	cm. 92 (40x92h)	€ 251,00
-----------	-----------------	----------



Colonna Rodi

art. 1659	cm. 236 (45x45x236h)	€ 807,00
-----------	----------------------	----------

Capitello Rodi

art. 1660	cm. 45x45x34h	€ 156,00
-----------	---------------	----------



Colonna Kos

art. 1603	cm. 70 (38x38x70h)	€ 203,00
-----------	--------------------	----------



Vaso Liscio

Colori Disponibili: **IM** Impr. | **AN** Antr. | **BI** Bianco | **CN** Cenere

art. 1380	cm. 40 (40x33h) lt25	€ 42,00
art. 1380	cm. 45 (45x37h) lt38	€ 52,00
art. 1380	cm. 50 (50x42h) lt50	€ 62,00
art. 1380	cm. 55 (55x46h) lt65	€ 72,00
art. 1380	cm. 65 (65x54h) lt100	€ 109,00
art. 1380	cm. 75 (75x62h) lt160	€ 175,00
art. 1380	cm. 135 (135x90h) lt750	€ 890,00



Vaso Festonato

IM SOLO COLORE IMPRUNETA

art. 1390	cm. 40 (40x33h) lt25	€ 42,00
art. 1390	cm. 45 (45x37h) lt38	€ 52,00
art. 1390	cm. 50 (50x42h) lt50	€ 62,00
art. 1390	cm. 55 (55x46h) lt65	€ 72,00
art. 1390	cm. 65 (65x54h) lt100	€ 109,00
art. 1390	cm. 75 (75x62h) lt160	€ 175,00
art. 1390	cm. 90 (90x72h) lt240	€ 329,00



Sott.vaso liscio e festonato

IM Impr. | **AN** Antr. | **BI** Bianco | **CN** Cenere

art. 3310	cm. 40x4,5	€ 5,50
art. 3310	cm. 45x5	€ 6,50
art. 3310	cm. 50x5,3	€ 8,50
art. 3310	cm. 55x5,5	€ 9,50
art. 3310	cm. 65x6	€ 13,50
art. 3310	cm. 75x6,5	€ 18,50



Vaso Festonato

art. 02400030	cm. 30 (30x16x25,1h) lt 8	€ 38,00
art. 02400035	cm. 35 (35x20x29,5h) lt 15	€ 43,00

Vaso Doppio Bordo Liscio

art. 02401030	cm. 30 (30x16,5x25h) lt8	€ 38,00
art. 02401035	cm. 35 (35x20x29,5h) lt15	€ 43,00



Colori Disponibili: **IM** Impr. | **AN** Antr. | **BI** Bianco | **CN** Cenere

Vaso Quadro Liscio

art. 1381	cm. 35 (35x35x30h) lt39	€ 56,00
art. 1381	cm. 41 (45x37h) lt38	€ 75,00
art. 1381	cm. 50 (50x42h) lt50	€ 125,00

Vaso Quadro Rosone

art. 1391	cm. 35 (35x35x30h) lt29	€ 56,00
art. 1391	cm. 41 (41x41x35h) lt51	€ 75,00

I PREZZI RIPORTATI SONO ESCLUSI DI IVA



Cassetta Liscia

Colori Disponibili: **IM** Impr. | **AN** Antr. | **BI** Bianco | **CN** Cenere

art. 1382	cm. 60 (60x29x24h) lt32	€ 70,00
art. 1382	cm. 80 (80x35x30h) lt63	€ 119,00
art. 1382	cm. 100 (100x41x36h) lt108	€ 155,00



Cassetta Festonata

IM SOLO COLORE IMPRUNETA

art. 1392	cm. 60 (60x29x24h) lt32	€ 70,00
art. 1392	cm. 80 (80x35x30h) lt63	€ 119,00
art. 1392	cm. 100 (100x41x36h) lt108	€ 155,00



Cassetta Millerighe

Colori Disponibili: **IM** Impr. | **BI** Bianco

art. 1492	cm. 60 (60x29x24h) lt32	€ 65,00
art. 1492	cm. 80 (80x35x31h) lt65	€ 112,00
art. 1492	cm. 100 (100x42x38h) lt122	€ 151,00

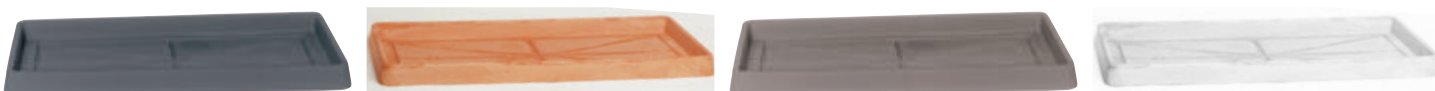

Sottocassetta x cassette festonate, lisce e millerighe

art. 4310	cm. 60 (60x31x3,9h)	€ 31,00
art. 4310	cm. 80 (80x38x4,6h)	€ 41,00
art. 4310	cm. 100 (100x44x4,7h)	€ 54,00



Vaso Parete Liscio

art. 1385 | cm. **50** (50x34x50h) lt65 | € **135,00**

IM SOLO COLORE IMPRUNETA



Sottovaso Parete

art. 8410 | cm. **60** | € **12,00**

Vaso Parete Festonato

art. 1395 | cm. **50** (50x34x50h) lt65 | € **145,00**

IM SOLO COLORE IMPRUNETA



Sottovaso Parete

art. 8410 | cm. **60** | € **12,00**

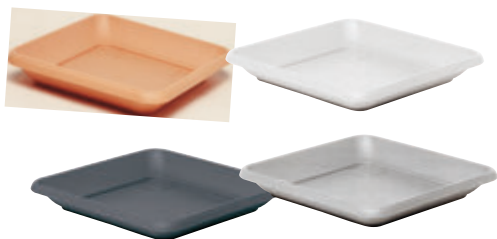

Colori Disponibili:

IM Impr. | **AN** Antr. | **BI** Bianco | **CN** Cenere

Sottovaso Quadro

art. 6310	cm. 35	€ 10,50
art. 6310	cm. 42	€ 14,50

Colori Disponibili: **IM** Impr. | **BI** Bianco

Quadro Millerighe

art. 1491	cm. 35 (35x35x31h) lt31	€ 56,00
art. 1491	cm. 42 (42x42x39h) lt52	€ 75,00





Festonato

		438	430		
		Sabbia	Granata		
art. 02400060	cm. 62x50h lt. 85	•	•	(2)	€ 139,00
art. 02400070	cm. 69x57h lt. 125	•	•	(2)	€ 210,00
art. 02400080	cm. 76x62h lt. 232	•	•	(2)	€ 230,00

*“... i vostri clienti più soddisfatti
sono la vostra
più grande fonte di successo ...”*

I PREZZI RIPORTATI SONO ESCLUSI DI IVA



VASO DOPPIO BORDO LISCIO - INDUSTRIALE

ART.	MIS. cm.	MAG.	CONF.	PREZZO
243500I	35x30,5	MAG.	6	€ 29,90
244000I	40x35	MAG.	6	€ 40,90
244500I	45x38,5	MAG.	4	€ 54,90
245000I	50x42,5	MAG.	4	€ 74,90
245600I	56x45	MAG.	2	€ 96,90
246200I	62x49	MAG.	2	€ 143,90

*“... un buon leader
spinge le persone ad avere fiducia in lui,
un grande leader
spinge le persone ad avere fiducia
in se stesse ...”*

VASO STANDARD

ART.	MIS. cm.	MAG.	CONF.	PREZZO
011100I	11X9,5	MAG.	36	€ 1,70
011300I	13X11	MAG.	36	€ 1,80
011500I	15X13	MAG.	36	€ 2,10
011700I	17X14,2	MAG.	30	€ 2,50
011900I	19X16	MAG.	30	€ 2,90
012100I	21X17,6	MAG.	24	€ 3,40
012300I	23X20	MAG.	24	€ 4,30
012500I	25X21	MAG.	24	€ 5,30
012700I	27X23,2	MAG.	18	€ 6,50
012900I	29X25	MAG.	18	€ 8,40
013100I	31X27	MAG.	12	€ 10,60
013300I	33X28	MAG.	12	€ 12,90
013500I	35X30	MAG.	12	€ 16,00
013700I	37X31,6	MAG.	12	€ 16,90
014000I	40X 32,5	MAG.	8	€ 22,20
014300I	43X35,3	MAG.	8	€ 26,70
014600I	46X38,1	MAG.	8	€ 36,60

VASO CILINDRO RIGATO

ART.	MIS. cm.	MAG.	CONF.	PREZZO
131300I	13X11	MAG.	24	€ 3,20
131800I	18X13	MAG.	24	€ 5,20
132200I	23X17	MAG.	18	€ 7,90
132800I	28X21	MAG.	18	€ 13,50
133400I	33X26	MAG.	12	€ 21,90
134000I	40X28	MAG.	12	€ 34,90
134600I	45X33	MAG.	6	€ 57,90
135400I	55X45	MAG.	6	€ 121,90



VASO MIGNON

ART.	MIS. cm.	MAG.	CONF.	PREZZO
001001-03	3,5x3h	MAG.	72	€ 1,00
001001-04	4,8x4h	MAG.	72	€ 1,10
001001-05	5,7x4,9h	MAG.	72	€ 1,20
001001-06	7x5,9h	MAG.	72	€ 1,30
001001-07	8,1x6,8h	MAG.	72	€ 1,40
001001-08	9,2x7,8h	MAG.	60	€ 1,50
001001-09	10,3x8,7h	MAG.	60	€ 1,60

SOTTOVASO MIGNON

ART.	MIS. cm.	MAG.	CONF.	PREZZO
006060-04	D 4,7	MAG.	25	€ 1,70
006060-05	D 5,8	MAG.	25	€ 1,80
006060-06	D 6,9	MAG.	25	€ 2,00
006060-07	D 7,9	MAG.	25	€ 2,10
006060-08	D 9	MAG.	25	€ 2,30
006060-09	D 10	MAG.	25	€ 2,50
006060-10	D 11,3	MAG.	25	€ 2,70

SOTTOVASO IMPERMEABILE

ART.	MIS. cm.	MAG.	CONF.	PREZZO
031102IB	11x2,4	MAG.	12	€ 2,10
031302IB	13x2,7	MAG.	12	€ 2,20
031502IB	15x2,9	MAG.	12	€ 2,30
031702IB	17x3	MAG.	12	€ 2,70
031902IB	19x3	MAG.	12	€ 3,10
032102IB	21x3,4	MAG.	10	€ 3,80
032302IB	23x3,5	MAG.	10	€ 4,50
032502IB	25x3,5	MAG.	10	€ 5,40
032802IB	27x3,5	MAG.	8	€ 7,80
032502IB	29x3,8	MAG.	8	€ 9,50
033101IB	31x4	MAG.	8	€ 10,90
033302IB	33x3,8	MAG.	8	€ 12,90
033602IB	37x4	MAG.	6	€ 15,90
034202IB	42x5,4	MAG.	6	€ 22,90
034802IB	48x5,7	MAG.	4	€ 36,90
035302IB	52x6,6	MAG.	2	€ 43,90

PIEDINO STANDARD

ART.	MIS. cm.	MAG.	CONF.	PREZZO
936004DI8	7X4	MAG.	20	€ 2,90
936014DI10	10X5	MAG.	20	€ 3,90

PIEDINO ANTICATO

ART.	MIS. cm.	MAG.	CONF.	PREZZO
936404DI8	7X4	MAG.	20	€ 4,90
936414DI10	10X5	MAG.	20	€ 5,90



CIOTOLINA				
ART.	MIS. cm.	MAG.	CONF.	PREZZO
010001-09	D 9,4	MAG.	20	€ 1,40
010001-11	D 11,4	MAG.	20	€ 1,90
010001-13	D 13,2	MAG.	20	€ 3,00
010001-16	D 16,7	MAG.	15	€ 3,90



CIOTOLONE RIGATO				
ART.	MIS. cm.	MAG.	CONF.	PREZZO
0726001	26 X 13	MAG.	12	€ 5,90
0731001	31 X 15,5	MAG.	12	€ 10,90
0736001	36 X 17,5	MAG.	12	€ 15,90
0741001	41 X 19,8	MAG.	6	€ 23,90
0746001	46 X 22	MAG.	6	€ 35,90
0751001	51 X 25	MAG.	6	€ 50,90



CIOTOLA GIARDINETTO				
ART.	MIS. cm.	MAG.	CONF.	PREZZO
0526001	26X11	MAG.	12	€ 5,90
0531001	32X12	MAG.	12	€ 10,90
0537001	37X14	MAG.	12	€ 15,90
0542001	41X17	MAG.	6	€ 21,90
0547001	47X18	MAG.	6	€ 31,90
0552001	52X19,7	MAG.	6	€ 46,90
0562001	62X23	MAG.	4	€ 82,90
0572001	72X24	MAG.	4	€ 135,90
0583001	83X28	MAG.	2	€ 182,90



LETTERA SMALTATA A-D				
ART.	MIS. cm.	MAG.	CONF.	PREZZO
2998009	9x5	MAG.	10	€ 4,90

FINO ESAURIMENTO SCORTE



NUMERO DIPINTO CORNICE				
ART.	MIS. cm.	MAG.	CONF.	PREZZO
2999006	9x5	MAG.	10	€ 4,90

FINO ESAURIMENTO SCORTE



CORNICE TERRACOTTA				
ART.	MIS. cm.	MAG.	CONF.	PREZZO
2999001	16x12	MAG.	10	€ 6,90
2999002	16x18	MAG.	10	€ 8,90
2999003	16x24	MAG.	10	€ 10,90

FINO ESAURIMENTO SCORTE



CASSETTA BALCONE LISCIA				
ART.	MIS. cm.	MAG.	CONF.	PREZZO
704000I	40x15,5H	MAG.	14	€ 17,90
705000I	50x16,5H	MAG.	12	€ 25,90
706000I	60x16,5H	MAG.	8	€ 33,90



CASSETTA ROMA				
ART.	MIS. cm.	MAG.	CONF.	PREZZO
333200I	32x16	MAG.	6	€ 12,90
333700I	37x18	MAG.	6	€ 15,90
334200I	42x19	MAG.	6	€ 19,90
334700I	47x21	MAG.	6	€ 26,90
335200I	52x22	MAG.	6	€ 32,90



SOTTOCASSETTA IMPERMEABILE				
ART.	MIS. cm.	MAG.	CONF.	PREZZO
383202IB	32x16	MAG.	5	€ 10,90
383802IB	38x18	MAG.	5	€ 11,90
384302IB	43x20	MAG.	5	€ 15,90
384802IB	48x21	MAG.	5	€ 18,90
385302IB	53x22	MAG.	5	€ 24,90



VASO PATAVIUM GRAFFIATO				
ART.	MIS. cm.	MAG.	CONF.	PREZZO
691413I	D 14	MAG.	20	€ 3,90
691613I	D 16	MAG.	18	€ 4,90
692013I	D 20	MAG.	18	€ 5,90
692513I	D 25	MAG.	13	€ 8,90
693013I	D 30	MAG.	10	€ 16,90
693513I	D 35	MAG.	9	€ 24,90
694513I	D 45	MAG.	6	€ 57,90
695313I	D 53	MAG.	5	€ nd



CASSETTA GRAFFIATA				
ART.	MIS. cm.	MAG.	CONF.	PREZZO
704013I	40	MAG.	14	€ 22,90
705013I	50	MAG.	12	€ 33,90
706013I	60	MAG.	8	€ 44,90



CIOTOLA BORDATA GRAFFIATA				
ART.	MIS. cm.	MAG.	CONF.	PREZZO
682113I	D 21	MAG.	19	€ 5,90
682513I	D 25	MAG.	18	€ 8,90
683013I	D 30	MAG.	18	€ 14,90
683513I	D 35	MAG.	18	€ 20,90
684013I	D 40	MAG.	15	€ 29,90



GERLA RIGATA

ART.	MIS. cm.	MAG.	CONF.	PREZZO
5025001	25x18,4	MAG.	12	€ 14,90
5030001	30x21,4	MAG.	12	€ 24,90

SALVADANAIO

ART.	MIS. cm.	MAG.	CO.	PREZZO
221150	13X15	MAG.	6	€ 11,90
MFT 128/22	22X22	MAG.	6	€ 16,90
MFT 128/28	28X28	MAG.	4	€ 20,90
MFT 128/33	33X33	MAG.	4	€ 30,90
MFT 128/40	40X40	MAG.	2	€ 53,90
MFT 128/55	55X55	MAG.	2	€ 108,90

CASSETTA CIPRESSI

ART.	MIS. cm.	MAG.	CO.	PREZZO
585260	26X15X13	MAG.	4	€ 22,90
585390	39X15X13	MAG.	2	€ 25,90

CUBO CIPRESSI

ART.	MIS. cm.	MAG.	CO.	PREZZO
586150	15X15X13	MAG.	4	€ 16,90
586180	18X18X15	MAG.	4	€ 22,90
586250	25X25X22	MAG.	2	€ 36,90
586300	30X30X26	MAG.	2	€ 51,90

CILINDRO CIPRESSI

ART.	MIS. cm.	MAG.	CO.	PREZZO
587150	15X13	MAG.	4	€ 16,90
587180	18X15	MAG.	4	€ 21,90
587250	25X22	MAG.	2	€ 29,90
587300	30X26	MAG.	2	€ 41,90





VASO DOPPIO BORDO LISCIO

ART.	MIS. cm.	CONF.	PREZZO
MFT909/36	36X31	9	€ 22,90
MFT909/42	42X36	7	€ 37,90
MFT909/47	47X41	7	€ 47,90
MFT909/52	52X44	6	€ 69,90
MFT909/58	58X48	6	€ 89,90
MFT909/62	62X52	5	€ 119,90
MFT909/67	67X57	5	€ 139,90

*“... se le formiche si mettono d'accordo
possono spostare un elefante ...”*



CONCA CON BORDONE LISCIA

ART.	MIS. cm.	CONF.	PREZZO
MFT 17/48	48X39	2	€ 109,90
MFT 17/56	56X45	2	€ 139,90
MFT 17/64	64X50	2	€ 199,90
MFT 17/76	76X60	2	€ 279,90
MFT 17/88	88X62	1	€ 549,90
MFT 17/100	100X68	1	€ 899,90
MFT 17/120	120X83	1	€ 1532,90

*“... da soli possiamo fare poco
insieme possiamo fare molto ...”*



CONCA CON BORDONE FESTONATA

ART.	MIS. cm.	CONF.	PREZZO
MFT 18/48	48X39	2	€ 109,90
MFT 18/56	56X47	2	€ 139,90
MFT 18/64	64X50	2	€ 199,90
MFT 18/76	77X62	2	€ 295,90

*“... se non rischi nulla
rischi tutto ...”*



CONCA TOSCANA FESTONATA

ART.	MIS. cm.	CONF.	PREZZO
MFT 14/50	50X36	2	€ 138,90
MFT 14/61	61X44	2	€ 248,90
MFT 14/73	73X53	2	€ 369,90
MFT 14/86	86X62	2	€ 525,90
MFT 14/100	100x68	2	€ 889,90
MFT 14/120	120x83	2	€ 1689,90



CASSETTA LISCIA PESANTE

ART.	MIS. cm.	CONF.	PREZZO
MFT 42/40	40X20X20	2	€ 42,90
MFT 42/50	50X24X24	2	€ 67,90
MFT 42/60	60X27X27	2	€ 95,90
MFT 42/70	70X30X31	2	€ 149,90
MFT 42/80	80X37X37	2	€ 199,90
MFT 42/100	100x45x44	2	€ 359,90



CASSETTA FESTONATA PESANTE

ART.	MIS. cm.	CONF.	PREZZO
MFT 41/40	40X20X20	2	€ 42,90
MFT 41/50	50X24X24	2	€ 67,90
MFT 41/60	60X27X27	2	€ 95,90
MFT 41/70	70X30X31	2	€ 149,90
MFT 41/80	80X37X37	2	€ 199,90
MFT 41/100	100x45x44	2	€ 359,90



CIOTOLA STAND. ANTICA PESANTE

ART.	MIS. cm.	CONF.	PREZZO
MFT352/30	30	6	€ 14,90
MFT352/40	40	6	€ 22,90
MFT352/52	52	4	€ 48,90
MFT352/61	61	4	€ 72,90
MFT352/70	70	2	€ 109,90
MFT352/80	80	2	€ 145,90



CUBO QUADRO LISCIO PESANTE

ART.	MIS. cm.	CONF.	PREZZO
MFT 46/27	27X27X24	4	€ 49,90
MFT 46/33	33X33X29	4	€ 79,90
MFT 46/40	40X40X36	4	€ 123,90
MFT 46/50	50X50X43	4	€ 199,90

CUBO QUADRO CON ROSETTA PESANTE

ART.	MIS. cm.	CONF.	PREZZO
MFT45/27	27X27X24	4	€ 49,90
MFT45/33	33X33X29	4	€ 79,90
MFT45/40	40X40X45	4	€ 123,90
MFT45/50	50X50X43	4	€ 199,90

CUBO QUADRO FESTONATO PESANTE

ART.	MIS. cm.	CONF.	PREZZO
MFT44/27	27X27X24	4	€ 49,90
MFT44/33	33X33X29	4	€ 79,90
MFT44/40	40X40X45	4	€ 123,90
MFT44/50	50X50X43	4	€ 199,90

MEZZO CILINDRO LISCIO

ART.	MIS. cm.	CONF.	PREZZO
MFT 22/43	44x44	2	€ 125,90
MFT 22/50	50X50	2	€ 199,90
MFT 22/60	62X60	2	€ 369,90

MEZZO CILINDRO FESTONATO

ART.	MIS. cm.	CONF.	PREZZO
MFT23/43	44x44	2	€ 125,90
MFT23/43	50X50	2	€ 199,90
MFT23/43	62X60	2	€ 369,90



VASO ANGOLARE LISCIO

ART.	MIS. cm.	CONF.	PREZZO
MFT 98/41	41X55	2	€ 179,90

VASO ANGOLARE FESTONATO

ART.	MIS. cm.	CONF.	PREZZO
MFT 99/41	41X55	2	€ 179,00

TASCA TORNIO FESTONATA

ART.	MIS. cm.	CONF.	PREZZO
MFT 84/20	20X14	2	€ 33,90
MFT 84/30	30X16	2	€ 43,90
MFT 84/38	38X22	2	€ 63,90

TASCA TORNIO LISCIA

ART.	MIS. cm.	CONF.	PREZZO
MFT 83/20	20x14	2	€ 23,90
MFT 83/30	30x16	2	€ 33,90
MFT 83/38	38x22	2	€ 59,90

VASACCIO A CALICE

ART.	MIS. cm.	CONF.	PREZZO
MFT 102/35	30x35	2	€ 119,90
MFT 102/42	42x44	2	€ 189,90

CIOTOLA COPPETTA PESANTE

ART.	MIS. cm.	CONF.	PREZZO
MFT 166/18	18	2	€ 25,90



ORCIO TOSCANO MONTELUPO

ART.	MIS. cm.	CONF.	PREZZO
MFT 58/50	37X50	1	€ 139,90
MFT 58/55	42X55	1	€ 213,90
MFT 58/64	52X64	1	€ 269,90
MFT 58/73	60X73	1	€ 539,90
MFT 58/80	76X80	1	€ 749,90
MFT 58/85	76X85	1	€ 899,90
MFT 58/90	84X90	1	€ 1099,90
MFT 58/105	96X105	1	€ 1499,90
MFT 58/150	150x150	1	€ 6599,90

MEZZO ORCIO

ART.	MIS. cm.	CONF.	PREZZO
MFT 148/48	48H	2	€ 165,90
MFT 148/73	73H	2	€ 451,90

ORCIO CON TASCHE

ART.	MIS. cm.	CONF.	PREZZO
MFT 59/30	30X27	1	€ 69,90
MFT 59/40	40X32	1	€ 99,90
MFT 59/50	50X37	1	€ 169,90
MFT 59/55	55X42	1	€ 279,90
MFT 59/64	64X52	1	€ 419,90

PORTAOMBRELLI CON ANELLI

ART.	MIS. cm.	CONF.	PREZZO
MFT 63/50	33X50	2	€ 119,90

“... non è mai troppo tardi per essere ciò che avresti voluto essere ...”



PORTAOMBRELLI CILINDRO LISCIO

ART.	MIS. cm.	CONF.	PREZZO
MFT 156/L47	47H	2	€ 59,90

PORTAOMBRELLI CILINDRO ANELLI

ART.	MIS. cm.	CONF.	PREZZO
MTF 156/A47	47H	2	€ 59,90

PORTAOMBRELLI CILINDRO GIGLIO

ART.	MIS. cm.	CONF.	PREZZO
MFT 156/GL42	42H	2	€ 59,90



SFERA GALESTRO

ART.	MIS. cm.	CONF.	PREZZO
PI10530	30x24	4	€ 59,90



SFERA CON BASE

ART.	MIS. cm.	CONF.	PREZZO
MFT151/20	21X27	2	€ 79,90
MFT151/25	27x33	2	€ 109,90
MFT151/30	35x50	2	€ 149,90

“... non si ottiene mai nulla senza fare un po' di casino ...”



PIGNA BASE QUADRATA

ART.	MIS. cm.	CONF.	PREZZO
MFT100/23	19X23	2	€ 59,90
MFT100/63	29X63	2	€ 179,90



PIGNA BASE TONDA

ART.	MIS. cm.	CONF.	PREZZO
MFT101/38	19X38	2	€ 99,90
MFT101/50	23X50	2	€ 119,90
MFT101/60	29X60	2	€ 159,90

PORTAOMBRELLI CON MANICI

ART.	MIS. cm.	CONF.	PREZZO
MFT 61/40	40H	2	€ 89,90
MFT 61/50	50H	2	€ 129,90





COLONNA SCANNELLATA

ART.	MIS. cm.	CONF.	PREZZO
MFT 93/43	28X43	2	€ 79,90
MFT 93/50	31X50	2	€ 99,90

COLONNA LISCIA

ART.	MIS. cm.	CONF.	PREZZO
MFT 94/43	28X43	2	€ 79,90
MFT 94/50	31X50	2	€ 99,90

*“... la testa!
c’è chi l’abbassa
chi la nasconde
e chi la perde!
io preferisco chi la usa ...”*



BASE LISCIA BASSA

ART.	MIS. cm.	CONF.	PREZZO
MFT 96 / 29	29X16	1	€ 41,90
MFT 96 / 37	37X20	1	€ 63,90
MFT 96 / 40	40X25	1	€ 88,90
MFT 96 / 47	47X32	1	€ 141,90
MFT 96 / 57	57X26	1	€ 216,90



BASE PIEDISTALLO GALESTRO

ART.	MIS. cm.	CONF.	PREZZO
MFT 97 / 14	14X15	1	€ 15,90
MFT 97 / 25	20X21	1	€ 21,90
MFT 97 / 30	23X26	1	€ 33,90
MFT 97 / 37	27X30	1	€ 46,90
MFT 97 / 43	33X37	1	€ 65,90



BASE PER ORCIO cm.150

ART.	MIS. cm.	CONF.	PREZZO
MFT 176/53	73X53	1	€ 595,90



BASE STANDARD

ART.	MIS. cm.	CONF.	PREZZO
MFT 375 / 25	25 H	1	€ 16,90
MFT 375 / 31	31 H	1	€ 22,90



CONICO MODERNE

ART.	MIS. cm.	CONF.	PREZZO
561200	20x19	6	€ 17,90
561250	25x23	4	€ 29,90
561300	30x27	4	€ 38,90
561370	37x33	3	€ 66,90
561450	45x40	2	€ 93,90

CILINDRO MODERNE

ART.	MIS. cm.	CONF.	PREZZO
560200	19x19	6	€ 19,90
560250	25x23	4	€ 33,90
560300	30x27	4	€ 48,90
560370	37x33	3	€ 78,90
560450	45x40	2	€ 114,90

VASO MODERNE

ART.	MIS. cm.	CONF.	PREZZO
562200	19x19	6	€ 19,90
562250	25x23	4	€ 29,90
562300	30x27	4	€ 43,90
562370	37x33	3	€ 69,90
562450	45x40	2	€ 105,90

CIOTOLA MODERNE

ART.	MIS. cm.	CONF.	PREZZO
563200	19x8	6	€ 10,90
563300	30x13	4	€ 23,90
563400	38x16	4	€ 38,90
563500	50x22	3	€ 74,90
563600	60x26	2	€ 88,90



CASSETTA RETT. MODERNE			
ART.	MIS. cm.	CONF.	PREZZO
595510	50x20	4	€ 47,90
595610	60x20	4	€ 57,90



VASO QUADRO MODERNE			
ART.	MIS. cm.	CONF.	PREZZO
593150	15x15	6	€ 11,90
593210	20x20	6	€ 21,90
593250	25x25	4	€ 35,90
593310	30x30	4	€ 58,90
593350	35x35	3	€ 91,90
593400	40x40	2	€ 109,90



VASO QUADRATO ALTO MODERNE			
ART.	MIS. cm.	CONF.	PREZZO
593510	25X50H	2	€ 69,90
593600	30X60H	2	€ 99,90
293700	35X70H	2	€ 189,90
293800	40X80H	2	€ 269,90



VASO TONDO ALTO MODERNE			
ART.	MIS. cm.	CONF.	PREZZO
594500	25X50H	2	€ 59,90
594600	30X60H	2	€ 89,90
294700	35X70H	2	€ 189,90
294800	40X80H	2	€ 269,90



CASSETTA BASIC ALTA

ART.	MIS. cm.	CONF.	PREZZO
297060	70X36X60	1	€ 385,90



CUBO BASIC ALTO

ART.	MIS. cm.	CONF.	PREZZO
296060	36X36X60	1	€ 245,90

*“... ci sono cose che impari meglio
nella calma, ed altre
nella tempesta ...”*



CASSETTA BASIC MEDIA

ART.	MIS. cm.	CONF.	PREZZO
297040	70X36X40	1	€ 285,90



CUBO BASIC MEDIO

ART.	MIS. cm.	CONF.	PREZZO
296040	36X36X40	2	€ 145,90

VASO IMPRUNETINO LISCIO

ART.	MIS. cm.	CONF.	PREZZO
245200	21x18	4	€ 23,90



VASO IMPRUNETINO FESTONATO

ART.	MIS. cm.	CONF.	PREZZO
246200	21x18	4	€ 23,90



VASO BARILE FESTONATO

ART.	MIS. cm.	CONF.	PREZZO
241200	30x25	4	€ 23,90



VASO BARILE LISCIO

ART.	MIS. cm.	CONF.	PREZZO
240200	30x25	4	€ 23,90



CUBO LISCIO

ART.	MIS. cm.	CONF.	PREZZO
203160	16x11	4	€ 16,90
203180	18x13,5	2	€ 21,90



CUBO ROSONE

ART.	MIS. cm.	CONF.	PREZZO
202160	16x11	4	€ 16,90
202180	18x13,5	2	€ 21,90



CASSETTA FESTONATA

ART.	MIS. cm.	CONF.	PREZZO
201270	27x14,5x10,5	2	€ 21,90
501320	33x18x16	2	€ 24,90



CASSETTA LISCIA

ART.	MIS. cm.	CONF.	PREZZO
518270	27x15x11	2	€ 21,90
518320	33x18x13	2	€ 24,90





CASSETTA SEMIOVALE

ART.	MIS. cm.	CONF.	PREZZO
780930	31x26x18	2	€ 33,90



OVALE RUSTICO FESTONATO

ART.	MIS. cm.	CONF.	PREZZO
504420	41x26x19	2	€ 39,90
504520	51x31x23	2	€ 69,90



OVALE RUSTICO LISCIO

ART.	MIS. cm.	CONF.	PREZZO
504410	41x20x19	2	€ 39,90
504510	51x31x23	2	€ 69,90



CASSETTA OVALE BONSAI

ART.	MIS. cm.	CONF.	PREZZO
582250	25x16x6,5	2	€ 16,90
582300	30x19x9,5	2	€ 26,90



CASSETTA BONSAI

ART.	MIS. cm.	CONF.	PREZZO
583200	20,5x15x6	2	€ 11,90
583250	24x17x7	2	€ 16,90



CASSETTA BONSAI CON PIEDINO

ART.	MIS. cm.	CONF.	PREZZO
MTF208/42	42x31x12	2	€ 44,90



CASSETTA PRIMULA A DUE

ART.	MIS. cm.	CONF.	PREZZO
589260	28	2	€ 16,90



CASSETTA PRIMULA A TRE

ART.	MIS. cm.	CONF.	PREZZO
586400	40	2	€ 23,90



VASO TRIS ROTONDO

ART.	MIS. cm.	CO.	PREZZO
505003	46x11	2	€ 34,90



VASO DUO ROTONDO

ART.	MIS. cm.	CO.	PREZZO
505002	30x11	2	€ 24,90



CUBO MODERNE MIGNON

ART.	MIS. cm.	CONF.	PREZZO
565200	19x19	6	€ 25,90
565230	23x23	6	€ 43,90



CASSETTA MODERNE MIGNON

ART.	MIS. cm.	CONF.	PREZZO
564400	40x19	6	€ 39,90
564500	50x23	6	€ 69,90



QUADRO MODERNE

ART.	MIS. cm.	CONF.	PREZZO
568108	6x9	8	€ 5,90
568108	9x12	6	€ 8,90



CILINDRO MODERNE

ART.	MIS. cm.	CONF.	PREZZO
568508	8x8	8	€ 5,90
568509	11x9	6	€ 8,90



CASSETTA GRASSE 2 MODERNE

ART.	MIS. cm.	CONF.	PREZZO
568216	6x16	6	€ 8,90
568217	9x24	4	€ 16,90



CASSETTA GRASSE 3 MODERNE

ART.	MIS. cm.	CONF.	PREZZO
568225	6x25	6	€ 12,90
568226	9x35	4	€ 24,90





OVALE GRASSE 2 MODERNE

ART.	MIS. cm.	CONF.	PREZZO
568616	8x16	6	€ 8,90
568617	9x24	4	€ 16,90



OVALE GRASSE 3 MODERNE

ART.	MIS. cm.	CONF.	PREZZO
568725	8x24	6	€ 12,90
568726	9x35	4	€ 24,90



VASO CONICO BASIC

ART.	MIS. cm.	CONF.	PREZZO
577180	18x16	4	€ 12,90
577210	21x19	4	€ 17,90



VASO ORCHIDEE BASIC

ART.	MIS. cm.	CONF.	PREZZO
576180	15x18	4	€ 12,90
576210	19x21	4	€ 17,90



CIOTOLA BASIC

ART.	MIS. cm.	CONF.	PREZZO
578240	24x9	4	€ 13,90



VASO CASPO' BASIC

ART.	MIS. cm.	CONF.	PREZZO
575170	17x15	4	€ 10,90
575190	19x17	4	€ 12,90
575240	24x21	4	€ 17,90



CUBO MODERNE MIGNON

ART.	MIS. cm.	CONF.	PREZZO
568316	17x6	6	€ 12,90



*“... se qualcuno ti dice
che non puoi farcela
quella persona ti sta mostrando
i suoi limiti non i tuoi ...”*



VASO DOPPIO BORDO LISCIO

ART.	MIS. cm.	CONF.	PREZZO
598400	40x35	9	€ 69,90
598450	45x36	7	€ 83,90
298500	50x41	7	€ 131,90
298600	60x50	6	€ 195,90
298700	70x58	6	€ 260,90
298800	80x64	5	€ 340,90
298900	91x71	5	€ 557,90
298990	100x81	5	€ 712,90



VASO DOPPIO BORDO FESTONATO

ART.	MIS. cm.	CONF.	PREZZO
507400	40x35	9	€ 69,90
507450	45x36	7	€ 83,90
299500	50x41	7	€ 145,90
299600	60x50	6	€ 215,90
299700	70x58	6	€ 281,90
299800	80x64	5	€ 378,90
299900	91x71	5	€ 584,90
299990	100x81	5	€ 747,90



CONCA CON BORDONE LISCIA

ART.	MIS. cm.	CONF.	PREZZO
545300	32x26	4	€ 35,90
545400	40x33	4	€ 68,90
545500	51x41	2	€ 159,90
245600	61x54	2	€ 216,90
245700	70x53	2	€ 278,90
245800	80x60	1	€ 381,90
245990	100x80	1	€ 740,90

*“... la forza si ottiene
con i fallimenti!
non con i successi! ...”*



CONCA CON BORDONE FESTONATA

ART.	MIS. cm.	CONF.	PREZZO
546300	32x26	4	€ 35,90
546400	40x33	4	€ 68,90
546500	51x41	2	€ 165,90
246600	61x54	2	€ 227,90
246700	70x53	2	€ 291,90
246800	80x60	1	€ 410,90
246990	100x80	1	€ 769,90



CASSETTA LISCIA PESANTE

ART.	MIS. cm.	CONF.	PREZZO
518400	41x20x20	4	€ 45,90
518500	51x25x23	4	€ 75,90
203060	60x30x30	4	€ 147,90
203070	71x34x30	4	€ 210,90
203080	81x41x35	2	€ 255,90
203099	100x46x43	2	€ 410,90



CASSETTA FESTONATA PESANTE

ART.	MIS. cm.	CONF.	PREZZO
501400	41x20x20	4	€ 45,90
501500	51x25x23	4	€ 75,90
201060	60x30x30	4	€ 159,90
201070	71x34x30	4	€ 219,90
201080	81x41x35	2	€ 269,90
201099	100x46x43	2	€ 419,90



CIOTOLA CON BORDO

ART.	MIS. cm.	CONF.	PREZZO
205400	40x15	6	€ 49,90
205500	50x19	6	€ 75,90
205600	60x22	4	€ 115,90
205700	70x25	4	€ 139,90
205800	80x29	2	€ 199,90
205990	100x36	2	€ 429,90





CUBO QUADRO LISCIO PESANTE

ART.	MIS. cm.	CONF.	PREZZO
503250	26x26x24	4	€ 44,90
503300	31x31x31	4	€ 59,90
204035	34x34x34	4	€ 139,90
204040	41x41x41	2	€ 163,90
204045	45x45x45	2	€ 213,90
204055	55x55x55	1	€ 339,90

CUBO QUADRO FESTONATO PESANTE

ART.	MIS. cm.	CONF.	PREZZO
502250	26x26x24	4	€ 44,90
502300	31x31x31	4	€ 59,90
202035	34x34x34	4	€ 145,90
202040	41x41x41	2	€ 169,90
202045	45x45x45	2	€ 219,90
202055	55x55x55	1	€ 349,90

PILONE CON ROSONE TOSCANO

ART.	MIS. cm.	CONF.	PREZZO
225060	40x40x60	6	€ 257,90
225070	52x52x70	4	€ 375,90

PILONE LISCIO TOSCANO

ART.	MIS. cm.	CONF.	PREZZO
226060	40x40x60	6	€ 247,90
226070	52x52x70	4	€ 365,90



MEZZO CILINDRO LISCIO

ART.	MIS. cm.	CONF.	PREZZO
231520	57x34x61	2	€ 279,90



MEZZO CILINDRO FESTONATO

ART.	MIS. cm.	CONF.	PREZZO
231521	57x34x61	2	€ 289,90



FRAGOLIERA A MURO

ART.	MIS. cm.	CONF.	PREZZO
222545	33X46	1	€ 149,90

*“... la nostra più grande debolezza
sta nel rinunciare,
il modo più sicuro per riuscire
è sempre provarci ancora una volta ...”*



FRAGOLIERA componibile

ART.	MIS. cm.	CONF.	PREZZO
222402	33X35	1	€ 99,90



*“... credi di farcela
e sarai già
a metà strada ...”*



VASO VANVITELLI

ART.	MIS. cm.	CONF.	PREZZO
501765	48x66	1	€ 439,90
501785	58x85	1	€ 593,90



VASO A CALICE

ART.	MIS. cm.	CONF.	PREZZO
537044	45x36	1	€ 205,90

*“... il successo è
la somma di piccoli sforzi
ripetuti
giorno giorno ...”*

VASO ACANTO

ART.	MIS. cm.	CONF.	PREZZO
501945	49x38	1	€ 235,90

COPPA BACCELLATA

ART.	MIS. cm.	CONF.	PREZZO
501845	45x29	1	€ 205,90



COPPA ETRUSCA

ART.	MIS. cm.	CONF.	PREZZO
501236	36x32	1	€ 155,90

COPPA ROMANA

ART.	MIS. cm.	CONF.	PREZZO
501632	35x32	1	€ 165,90

VASO ANDUSE

ART.	MIS. cm.	CONF.	PREZZO
511050	42x48	1	€ 285,90
511060	52x58	1	€ 325,90
511070	62x68	1	€ 445,90

*“... se qualcuno ti dice
che non puoi farcela
quella persona ti sta mostrando
i suoi limiti non i tuoi ...”*





ANFORA TAGLIATA

ART.	MIS. cm.	CONF.	PREZZO
MFT 207/44	44	1	€ 79,90
MFT 207/50	50	1	€ 109,90

*“... una cosa fatta bene,
può sempre
essere fatta meglio ...”*

ANFORA TAGLIATA

ART.	MIS. cm.	CONF.	PREZZO
220020	10x20	6	€ 22,90
220030	18x30	4	€ 40,90
220040	20x40	2	€ 64,90
220050	25x50	2	€ 89,90

ANFORA ANTICA ROMA

ART.	MIS. cm.	CONF.	PREZZO
224120	17x20	4	€ 24,90
224131	24x30	4	€ 36,90
224141	27x40	2	€ 58,90
224130	32x50	2	€ 81,90
224160	37x60	2	€ 105,90
224170	42x70	1	€ 130,90

ANFORA A MURO

ART.	MIS. cm.	CONF.	PREZZO
851250	25x25	1	€ 67,90
851300	30x30	1	€ 87,90
851400	40x40	1	€ 143,90



PORTAOMBRELLI ORCIO ETRUSCO LISCIO

ART.	MIS. cm.	CONF.	PREZZO
221016	30x45	2	€ 79,90



ORCIO PANCIUTO

ART.	MIS. cm.	CONF.	PREZZO
203500	50X50	1	€ 299,90
203600	60X60	1	€ 349,90
203700	70X70	1	€ 529,90
203800	80X80	1	€ 779,90



ANFORA ROMANA

ART.	MIS. cm.	CONF.	PREZZO
590065	31x65	1	€ 206,90
590070	35x70	1	€ 265,90
590095	40x95	1	€ 399,90

*“... non sempre cambiare equivale
a migliorare
ma per migliorare
bisogna cambiare ...”*

FONTANA PANNELLO LIMONI

ART.	MIS. cm.	CONF.	PREZZO
507070P	PANN.32X62	1	€ 109,90
507070G	GERLA 43X62	1	€ 189,90



FONTANELLA 2 PEZZI LISCIA

ART.	MIS. cm.	CONF.	PREZZO
4001007P	PANN.36X47	1	€ 59,90
4001007G	GERLA18X40X25	1	€ 59,90



FONTANELLA 3 PEZZI IMPERO

ART.	MIS. cm.	CONF.	PREZZO
855000	PANN.40X47	1	€ 54,90
855001	GERLA19X40X36	1	€ 83,90
855002	SIFONE 20X20	1	€ 23,90



FONTANA GARDEN

ART.	MIS. cm.	CONF.	PREZZO
507050	55X120	1	€ 889,90



FONTANA LISCIA

ART.	MIS. cm.	CONF.	PREZZO
MFT 170 / L98	42X98	1	€ 329,90



FONT. PAN. A MURO MONTELUPO

ART.	MIS. cm.	CONF.	PREZZO
721701	53X49	1	€ 89,90
721702	GERLA	1	€ 198,90
721703	PIEDE	1	€ 89,90



FONTANA A MATTONCINI

ART.	MIS. cm.	CONF.	PREZZO
MFT 170 / M78	30X78	1	€ 219,90
MFT 170 / M98	42X98	1	€ 359,90



*"... non importa quanto vai piano...
l'importante è non fermarsi ..."*



INVERNO			
ART.	MIS. cm.	CO.	PREZZO
1100204	D 20	2	€ 14,90



PRIMAVERA			
ART.	MIS. cm.	CO.	PREZZO
1100201	D 23	2	€ 14,90



AUTUNNO			
ART.	MIS. cm.	CO.	PREZZO
1100203	D 23	2	€ 14,90



ESTATE			
ART.	MIS. cm.	CO.	PREZZO
1100202	D 23	2	€ 14,90



ECLISSI			
ART.	MIS. cm.	CO.	PREZZO
1100218	D 18	6	€ 10,90
1100225	D 25	6	€ 16,90
1100235	D 35	4	€ 23,90



LUNA			
ART.	MIS. cm.	CO.	PREZZO
281200	D 20	6	€ 8,90
281300	D 30	6	€ 19,90
281400	D 40	4	€ 25,90



IL GIORNO			
ART.	MIS. cm.	CO.	PREZZO
1100906	Cm 26	6	€ 14,90



LA NOTTE			
ART.	MIS. cm.	CO.	PREZZO
1100905	Cm 25	6	€ 14,90



MERIDIANA SOLE			
ART.	MIS. cm.	CO.	PREZZO
281655	46	1	€ 66,90



MERIDIANA ASTRY			
ART.	MIS. cm.	CO.	PREZZO
281623	D 43	6	€ 66,90



MERIDIANA ECLISSI			
ART.	MIS. cm.	CO.	PREZZO
281655	44X33	4	€ 66,90



ROSA DEI VENTI			
ART.	MIS. cm.	CO.	PREZZO
999028	43x43	2	€ 59,90



ATTENTI AL GATTO			
ART.	MIS. cm.	CO.	PREZZO
1100915	17X20	6	€ 9,90



ATTENTI AL CANE			
ART.	MIS. cm.	CO.	PREZZO
1100914	17X20	6	€ 9,90



STELLA			
ART.	MIS. cm.	CO.	PREZZO
1103109	20X20	4	€ 11,90



FERRO DI CAVALLO			
ART.	MIS. cm.	CO.	PREZZO
1103206	19x18	4	€ 11,90



I PREZZI RIPORTATI SONO ESCLUSI DI IVA

RONDINE

ART.	MIS. cm.	CO.	PREZZO
1103001	D 19	2	€ 11,90
1103002	D 25	2	€ 16,90



PIEDINO MATTONE

ART.	MIS. cm.	CO.	PREZZO
1807009	9x5x5	12	€ 3,90



PIEDINO ROTONDO

ART.	MIS. cm.	CO.	PREZZO
1876009	9x9x5	12	€ 3,90



PIEDINO ANGOLARE ZEPPA

ART.	MIS. cm.	CO.	PREZZO
PLQ01	8x3	12	€ 4,90
PLQ02	10x5	12	€ 5,90



PIEDINO ROTONDO ZEPPA

ART.	MIS. cm.	CO.	PREZZO
PLR01	6x3	12	€ 4,90
PLR02	8x5	12	€ 5,90



PIEDINO TRIANG. ANTICATO

ART.	MIS. cm.	CO.	PREZZO
MFT67	12X7X2	50	€ 2,90
PL01 Basso	12X8X2	50	€ 2,90
PL02 Alto	12X8X4	50	€ 4,90



PIEDINO TESTA LEONE F. A MANO

ART.	MIS. cm.	CO.	PREZZO
MFT 112-9	Cm 9	6	€ 7,90
MFT 112-13	Cm 13	6	€ 12,90
MFT 112-15	Cm 15	6	€ 16,90



PIEDINO ABRUZZO

ART.	MIS. cm.	CO.	PREZZO
PA01	10x5x5	12	€ 4,90



*"... non fermarti quando sei stanco
fermati quando hai finito ..."*





CASSETTA-ARMADIO-PANCA-LEGNOmm15IMPREGNATO

Art.	Misura	Tipo	Disp.	Q.tà	Prezzo
*626/17	200LX180PX217HCm	Casetta	15gg	1	€ 1390,00
*626/15	135LX61PX217HCm	Armadio M	15gg	1	€ 650,00
*626/14	85LX46PX177HCm	Armadio S	15gg	1	€ 450,00
*626/M 17	MONTAGGIO IN PIANO	2p. Netto	1gg	1	€ 996,00
*626/M 15	MONTAGGIO IN LOCO	2p. Netto	1gg	1	€ 792,00
*626/M 14	MONTAGGIO IN LOCO	2p. Netto	1gg	1	€ 635,00



"...io devo studiare sodo e preparare me stesso perchè prima o poi verrà il mio momento"



PERGOLA

ARTICOLO

COD.	Misura	Disp.	Q.tà	Prezzo
*785/1	Pergola 3x3 Mt	15 gg	1	€ 390,00
*785/6	Pergola 3x4 Mt	15 gg	1	€ 490,00
*785/4	Pergola 3x6 Mt	15 gg	1	€ 690,00



**PROFILO
CM. 9x9**



**PROFILO
CM. 7x7**

TELO COPERTURA PER PERGOLA

ARTICOLO

IMBALLO

COD.	M	Disp.	Q.tà	Prezzo
*824/14	Copertura 3x3 Mt	15 gg	1	€ 45,00
*824/15	Copertura 3x4 Mt	15 gg	1	€ 55,00
*824/16	Copertura 3x6 Mt	15 gg	1	€ 75,00

PERGOLA SENZA COPERTURA (POSSIBILITA' DI COPERTURA)

Art.	Misura	Tipo	Disp.	Q.tà	Prezzo
*LO/PG300400	300x400x265 Cm	Libero	15 gg	1	€ 1050,00
*LO/PG240300	240x300x265 Cm	Libero	15 gg	1	€ 899,00

I PREZZI RIPORTATI SONO ESCLUSI DI IVA



RECINTO MAREMMA LEGNO NORDICO IMPREGNATO

Articolo	Misura	Forma	Disp.	Q.tà	Prezzo
*624	180X90X3 Cm Maremma	Staccionata	Mag	1	€ 49,90
*624/1	100X90X3 Cm Maremma	Staccionata	Mag	1	€ 39,90

“...il grande errore consiste nel voler anticipare il risultato all'impegno lascia che la natura faccia il suo corso i tuoi risultati arriveranno al momento giusto...”



Recinzione Foro e incavo

Articolo	Misura	Disp.	Q.tà	Prezzo ML
*LO/REC1FI	Interasse 200cm. Pilastro 150cm. (Ø 12cm.) - 1 foro Ø 8cm. - 1 inc. Ø 12cm. Corrimano 200cm. (Ø 12cm.) - Traversa 200cm. (Ø 12cm.)	15 gg	6	€ 145,00

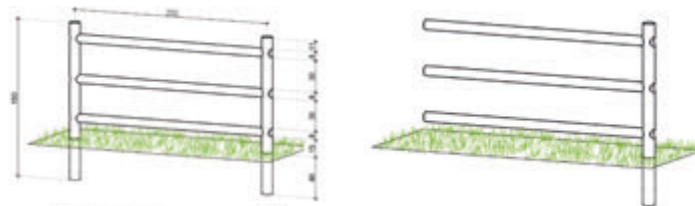

Recinzione Tre Fori

Articolo	Misura	Disp.	Q.tà	Prezzo ML
*LO/REC3FORI	Interasse 200cm. Pilastro 150cm. (Ø 12cm.) - 3 fori Ø 8cm. - Traversa 200cm. (Ø 8cm.)	15 gg	6	€ 135,00

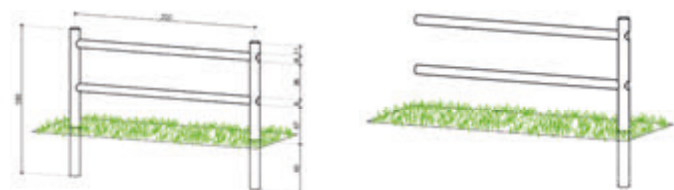

Recinzione Due Fori

Articolo	Misura	Disp.	Q.tà	Prezzo ML
*LO/REC2FORI	Interasse 200cm. Pilastro 150cm. (Ø 12cm.) - 2 fori Ø 8cm. Traversa 200cm. (Ø 8cm.)	15 gg	6	€ 110,00

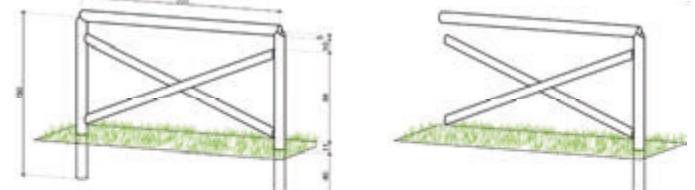

Recinzione Croce di S. Andrea Palo Pieno

Articolo	Misura	Disp.	Q.tà	Prezzo ML
*LO/RECSANDREA	Interasse 200cm. Pilastro 150cm. (Ø 10cm.) - 2 fori Ø 8cm. - inc. Ø 10cm Corrimano 200cm. (Ø 10cm.) - Traversi a Croce 230cm. (Ø 8cm.)	15 gg	6	€ 149,00



PALI IN PINO IMPREGNATI

Articolo	Descrizione	Pz/Banc.	Disp.	Pr. sfuso
*622/22	Ø 6Cm - LUNGH 250Cm	234	Magg.	€ 14,90
*622/15	Ø 6Cm - LUNGH 300Cm	234	Magg.	€ 20,90
*622/18	Ø 8Cm - LUNGH 250	130	Magg.	€ 17,90
*622/21	Ø 8Cm - LUNGH 300Cm	130	Magg.	€ 26,90

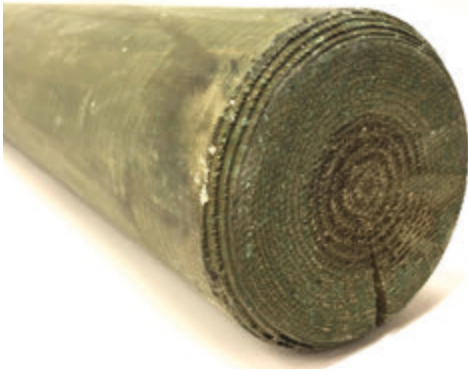

PROFILI IN PINO IMPREGNATI

Articolo	Descrizione	Pz/Ban	Disp.	Pr. sfuso
*624/3	sez 7x7 Cm LUNGH 150 Cm	64	Magg.	€ 19,90
*624	sez 7x7 Cm LUNGH 240 Cm	64	Magg.	€ 29,90
*624/4	sez 7x7 Cm LUNGH 300 Cm	64	Magg.	€ 39,90

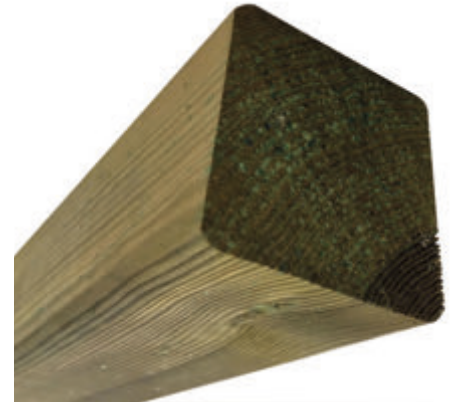

PALI IN PINO IMPREGNATI CON PUNTA

Articolo	Descrizione	Pz/Ban.	Disp.	Pr. sfuso
*622/5	Ø 6Cm - LUNGH 150Cm	256	Magg.	€ 9,90
*622/6	Ø 6Cm - LUNGH 200Cm	234	Magg.	€ 11,90
*622/7	Ø 6Cm - LUNGH 250Cm	234	Magg.	€ 14,90
*PALI08200PU	Ø 6Cm - LUNGH 300Cm	234	Magg.	€ 24,90
*622/8	Ø 8Cm - LUNGH 150Cm	156	Magg.	€ 13,90
*622/9	Ø 8Cm - LUNGH 200Cm	130	Magg.	€ 17,90
*622/10	Ø 8Cm - LUNGH 250Cm	130	Magg.	€ 21,90
*622/11	Ø 8Cm - LUNGH 300Cm	130	Magg.	€ 26,90
*PALI10200PU	Ø 10Cm - LUNGH 200Cm	88	15gg.	€ 38,90
*PALI10250PU	Ø 10Cm - LUNGH 250Cm	88	15gg.	€ 46,90
*PALI10300PU	Ø 10Cm - LUNGH 300Cm	88	15gg.	€ 55,90



PORTAPILASTRO A BICCHIERE PER PALO TONDO

Articolo	Descrizione	Prezzo/cad
*447/10	PIASTRA alloggio palo Ø 10 Cm	€ 11,90
*447/12	PUNTALE alloggio palo Ø 10 Cm	€ 16,90

MEZZI PALI IN PINO IMPREGNATI

Articolo	Descrizione	Pz/Ban.	Disp.	Pr. Ban.
*722/44	Ø 6Cm - LUNGH 200Cm	260	15gg.	€ 10,90
*722/42	Ø 8Cm - LUNGH 250Cm	260	15gg.	€ 12,90
*MZPALI10250	Ø 10Cm - LUNGH 250Cm	176	15gg.	€ 25,90
*MZPALI10300	Ø 10Cm - LUNGH 300Cm	176	15gg.	€ 29,90
*MZPALI10400	Ø 10Cm - LUNGH 300Cm	176	15gg.	€ 38,90



STAFFA A "U" PER FISSAGGIO CORRIMANO

Articolo	Descrizione	Prezzo/cad
*STAU10	collare per corrimano Ø 10 Cm	€ 30,00
*STAU12	collare per corrimano Ø 12 Cm	€ 32,00

PALI IN PINO IMPREGNATI LAVORATI

Articolo	Descrizione	Pz/Ban	Disp.	Pr. sfuso
*PALI121501F1	Ø 12Cm - LUNG 150Cm - 1Foro - 1Incavo	63	15gg.	€ 55,90
*PALI121502F	Ø 12Cm - LUNG 150Cm - 2Fori	63	15gg.	€ 55,90
*PALI141502F	Ø 14Cm - LUNG 150Cm - 2Fori	42	15gg.	€ 76,90
*PALI101501I	Ø 10Cm - LUNG 150Cm - 1Incavo	88	15gg.	€ 35,90
*PALI121501I	Ø 12Cm - LUNG 150Cm - 1Incavo	63	15gg.	€ 56,90
*PALI121503F	Ø 12Cm - LUNG 150Cm - 3Fori	63	15gg.	€ 77,90
*PALI122003F	Ø 12Cm - LUNG 200Cm - 3Fori	63	15gg.	€ 93,90



"...si realizzano sempre le cose in cui credi realmente è il credere in una cosa che la rende possibile..."

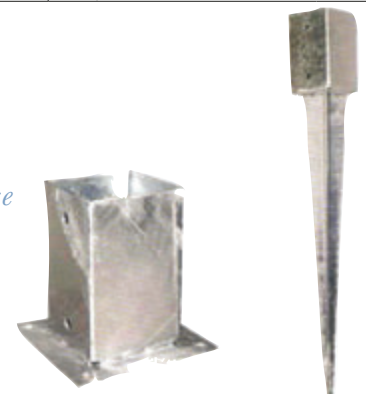
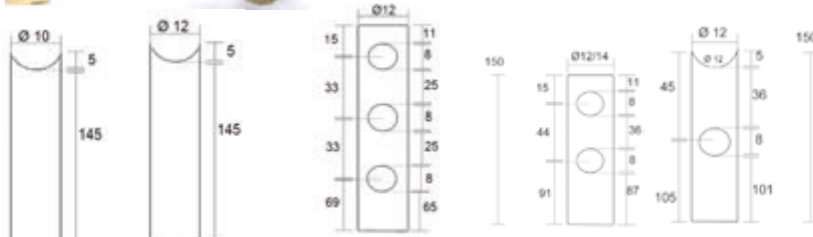

PORTAPILASTRO A BICCHIERE PER PALO QUADRATO

Articolo	Descrizione	Prezzo/cad
*447/2	PIASTRA alloggio palo 7 Cm	€ 8,90
*447	PUNTALE alloggio palo 7 Cm	€ 11,90
*447/3	PIASTRA alloggio palo 9 Cm	€ 9,90
*447/1	PUNTALE alloggio palo 9 Cm	€ 14,90

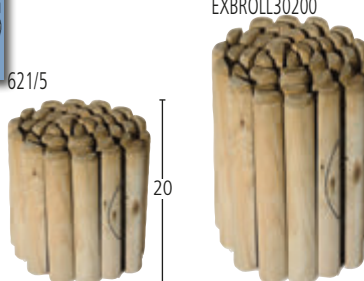
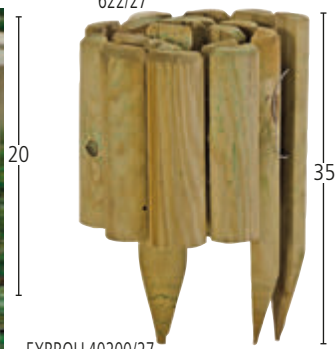

BORDURE PER AIUOLE "ROLLERBORDER E VAMPIRO"

Art.	Misura	Tipo	Disp.	Q.tà	Prezzo
621/5	200LX20HX5Cm	Ro. Bord.	Mag.	1	€ 19,90
EXBROLL30200	200LX30HX5Cm	Ro. Bord.	Mag.	1	€ 31,90
EXBROLL40200	200LX40HX5Cm	Ro. Bord.	Mag.	1	€ 37,90
622/27	110LX20HX5Cm	Ro. Vamp.	Mag.	1	€ 15,90

BORDURE PER AIUOLE "RECINZIONE O VAMPIRO"

Art.	Misura	Tipo	Disp.	Q.tà	Prezzo
622/3	55LX15+15HCm	Vampiro	Mag.	1	€ 6,90
622/20	54LX27+20Cm	Vampiro Arco	Mag.	1	€ 13,90
622/4	75LX20+12HCm	Recinto 75	Mag.	1	€ 8,90
622/2	120LX30+15Cm	Recinto 120	Mag.	1	€ 18,90

"... esperienza è semplicemente il nome che diamo ai nostri errori ..."



TAVOLE IMPREGNATE PER PAVIMENTI

Articolo	Descrizione	Pz/Banc	Disp.	Pr. sfuso
*EX/PAVM38100100	Cm. 100x100x3,8	299	15gg.	€ 102,00

TAVOLE IMPREGNATE PER PAVIMENTI

Articolo	Descrizione	Pz/Banc	Disp.	Pr. sfuso
*629	Cm. 50x50x2,8	52	Magg.	€ 14,90



FINALI LAMIERA ZINCATA O PVC

Articolo	Descrizione	Pz/Banc	Disp.	Pr. sfuso
*447/4	Finale Lam. Zinc. Quadra	12	Magg.	€ 2,90
*447/6	Finale Lam. Zinc. Palla	12	Magg.	€ 5,90
*447/8	Finale PVC Cono	12	Magg.	€ 2,90





Luce Foro 9x9cm
Profilo 3,5x3,5cm

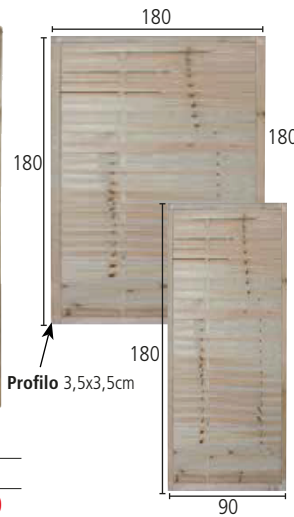
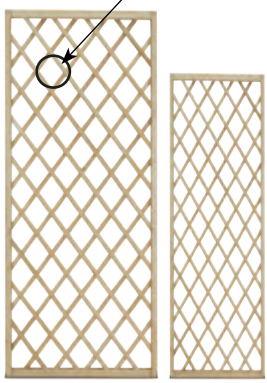

Profilo 3,5x2cm

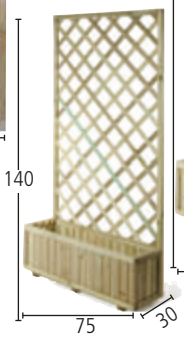
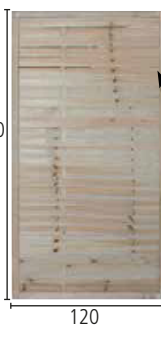

GRIGLIATO FISSO LEGNO NORDICO IMPREGNATO

Articolo	Misura	Forma	Disp.	Q.tà	Prezzo
*628/30	40X180X3 Cm	Rett.	Mag.	1	€ 36,90
*628/31	90X180X3 Cm	Rett.	Mag.	1	€ 55,90
*628/32	90X180X3 Cm	Arco	Mag.	1	€ 71,90
*628/33	100X200X3 Cm	Rett.	Mag.	1	€ 91,90
*628/34	60X180X3 Cm	Rett.	Mag.	1	€ 44,90
*628/35	120X180X3 Cm	Rett.	Mag.	1	€ 67,90
628/TH	TAGLIO A MISURA IN H		7gg	1	€ 115,00
*628/TL	TAGLIO A MISURA IN L		7gg	1	€ 205,00

PANNELLO FRANGIVENTO LEGNO NORDICO IMPREGNATO

Articolo	Misura	Forma	Disp.	Q.tà	Prezzo
*627/0	90X180X2,5Cm	Rett.	Mag.	1	€ 48,90
*627/10	120X180X2,5Cm	Rett.	Mag.	1	€ 124,90
*627/11	180X180X2,5Cm	Rett.	15 gg	1	€ 147,90
*628/TH	TAGLIO A MISURA IN H		7gg	1	€ 115,00
*628/TL	TAGLIO A MISURA IN L		7gg	1	€ 205,00

GRIGLIATO FISSO FIORIERA LEGNO NORDICO IMPREGNATO

Articolo	Misura	Forma	Disp.	Q.tà	Prezzo
*628/20	75X140X3 Cm	Rett.	Mag.	1	€ 97,90
*628/25	75X180X3 Cm	Rett.	Mag.	1	€ 115,90
*628/26	90X180X3 Cm	Rett.	Mag.	1	€ 165,90
*628/TH	TAGLIO A MISURA IN H		7gg	1	€ 115,00
*628/TL	TAGLIO A MISURA IN L	NO			NON POSSIBILE

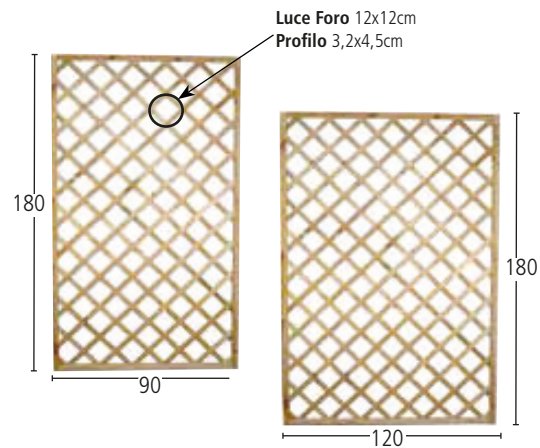
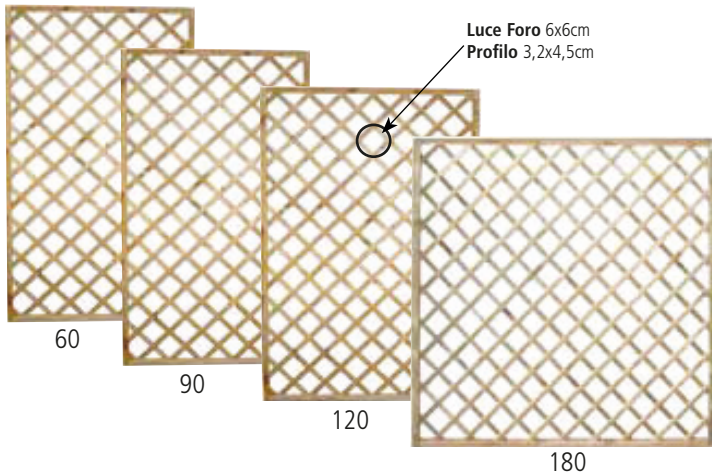

GRIGLIATO FISSO PREMIUM LEGNO NORDICO IMPREGNATO

Articolo	Misura	Forma	Disp.	Q.tà	Prezzo
*ACGRI40180	40X180X4 Cm	Rett.	Mag.	1	€ 85,90
*ACGRI60180	60X180X4 Cm	Rett.	Mag.	1	€ 99,90
*ACGRI90180	90X180X4 Cm	Rett.	Mag.	1	€ 115,90
*ACGRI120180	120X180X4 Cm	Rett.	15gg	1	€ 165,90
*ACGRI180180	180X180X4 Cm	Rett.	15gg	1	€ 210,90
*628/TH	TAGLIO A MISURA IN H		7gg	1	€ 115,90
*628/TL	TAGLIO A MISURA IN L		7gg	1	€ 221,90

GRIGLIATO FISSO LEGNO NORDICO IMPREGNATO

Articolo	Misura	Forma	Disp.	Q.tà	Prezzo
GRIL0090180	90X180X4,5 Cm	Rett.	Mag.	1	€ 89,90
GRIL00120180	120X180X4,5 Cm	Rett.	Mag.	1	€ 109,90
628/TH	TAGLIO A MISURA IN H		7gg	1	€ 115,90
628/TL	TAGLIO A MISURA IN L		7gg	1	€ 205,90



FIORIERA LAVANDA

Articolo	Misura	Forma	Disp.	Q.tà	Prezzo
*UPI/LA363632	cm. 36X36X32 H	Quad.	Mag.	1	€ 190,90
*UPI/LA583632	cm. 58X36X32 H	Rett.	Mag.	1	€ 200,90
*UPI/LA783632	cm. 78X36X32 H	Rett.	Mag.	1	€ 225,90
*UPI/LA1183632	cm. 118X36X32 H	Rett.	Mag.	1	€ 255,90

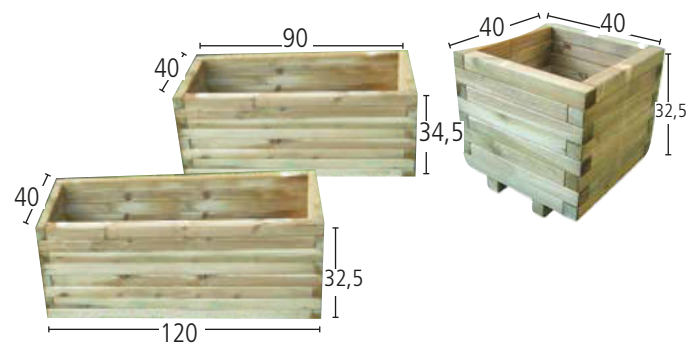

CASSETTE E FIORIERE TULIPANO LEGNO NORDICO IMPREGNATO

Articolo	Misura	Forma	Disp.	Q.tà	Prezzo
*DP/FIO404040	40X40X32,5 Cm	Quadrata	Mag	12	€ 95,90
*DP/FIO409040	40X90X34,5 Cm	Rettangolare	Mag	8	€ 155,90
*DP/FIO4012040	40X120X32,5 Cm	Rettangolare	Mag	6	€ 205,90
*628/TH	TAGLIO A MISURA IN H UN LATO		NO	1	NO
*628/TL	TAGLIO A MISURA IN L UN LATO		NO	1	NO

I PREZZI RIPORTATI SONO ESCLUSI DI IVA

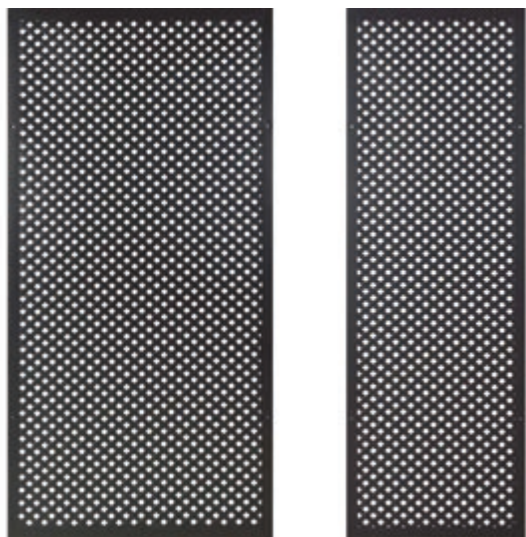

PANNELLI FRANGIVISTA PRIVACY IN METALLO (FORO MINI)

Art.	Misura	Tipo	Disp.	Q.tà	Prezzo
8527	cm L60xH180	Fisso	8 gg	2	€ 139,90
8528	cm L90xH180	Fisso	8 gg	2	€ 169,90

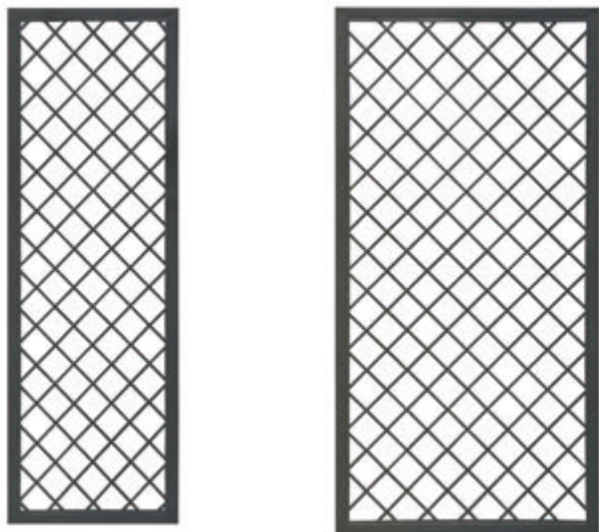

PANNELLI RAMPICANTI IN METALLO (FORO MAXI)

Art.	Misura	Tipo	Disp.	Q.tà	Prezzo
8522	cm L60xH180	Fisso	8 gg	2	€ 111,90
8523	cm L90xH180	Fisso	8 gg	2	€ 129,90

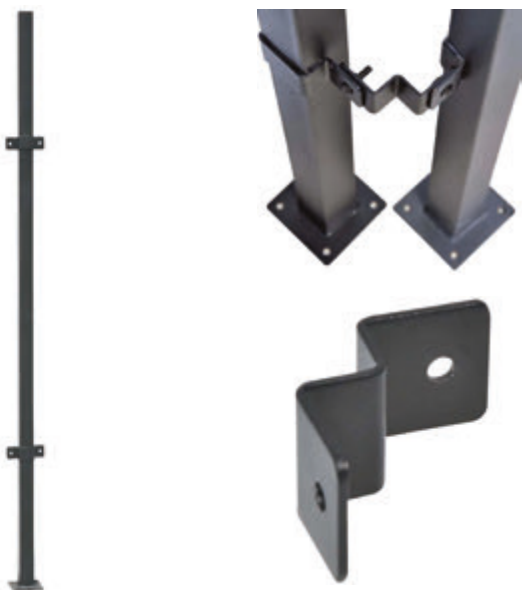

PALE E GIUNTI DI ANCORAGGIO PANNELLI IN METALLO

Art.	Misura	Tipo	Disp.	Q.tà	Prezzo
8547	cm 4,5x4,5xH183	Fisso	8 gg	1	€ 61,90

PANNELLI IN METALLO ZINCATO E VERNICIATO CON POLVERI EPOXIDICHE IN FORNO. Struttura robusta e stabile per creare divisori di prestigio ed alta qualità. Nel colore satinato antracite.

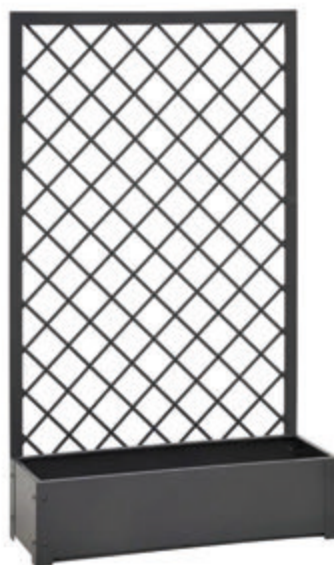

*“... se c'è una cosa
che ho imparato
nella vita
è che
l'apparenza
inganna parecchio ...”*



FIORIERA CON PANNELLO RAMPICATE

Art.	Misura	Tipo	Disp.	Q.tà	Prezzo
8536	cm 90x432xH150	Fisso	8 gg	1	€ 213,90

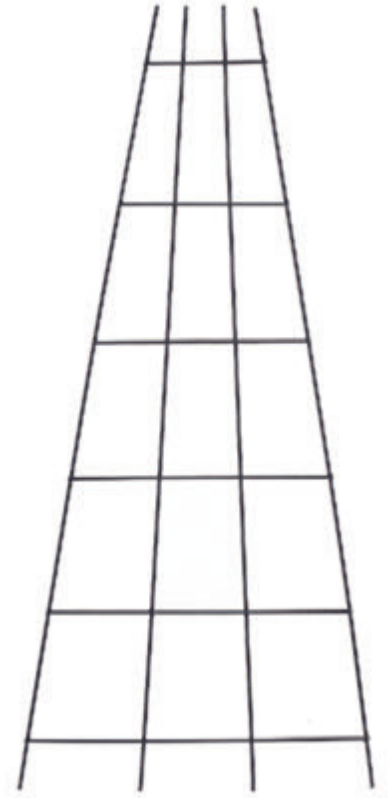

*“... la vita è
per il dieci per cento cosa ti accade
per il novanta per cento
come reagisci ...”*

Grigliato Edera - filo Ø 6mm

Art. EDERP180S	cm. 46x175h (pz.2)	€ 39,90 cad.
Art. EDERP180L	cm. 82 x175h (pz.2)	€ 49,90 cad.

Grigliato Liana - filo Ø 6mm

Art. LIARP150	cm. 70-20x150h (pz.2)	€ 37,90 cad.
---------------	-----------------------	--------------



Coprifioriera Acciaio Eureka Large

Art. EURLAR103ANTR	cm. 103x48,5x43h (Zinc. - Antr.)	€ 119,90
Art. EURLAR103RUG	cm. 103x48,5x43h (Zinc. - Rug.)	€ 119,90
Art. EURLAR103BIA	cm. 103x48,5x43h (Zinc. - Bian.)	€ 119,90

Coprifioriera Acciaio Eureka Media

Art. EURLAR83ANTR	cm. 83x48,5x43h (Zinc. - Antr.)	€ 116,90
Art. EURLAR83RUG	cm. 83x48,5x43h (Zinc. - Rug.)	€ 116,90
Art. EURLAR83BIA	cm. 83x48,5x43h (Zinc. - Bian.)	€ 116,90

Coprifioriera Acciaio Eureka Small

Art. EURLAR48ANTR	cm. 48,5x48,5x43h (Zinc. - Antr.)	€ 109,90
Art. EURLAR48RUG	cm. 48,5x48,5x43h (Zinc. - Rug.)	€ 109,90
Art. EURLAR48BIA	cm. 48,5x48,5x43h (Zinc. - Bian.)	€ 109,90

“... posso accettare la sconfitta
ma non posso accettare
il non provarci ...”



Letizia Arco Rampicante in Ferro Battuto

Art. LETRP130	cm. 130x42x250h	€ 109,90
Art. LETRP140	cm. 140x42x250h	€ 122,90
Art. LETRP153	cm. 153x42x250h	€ 125,90



Scaletta Portavasi 3 ripiani

Art. SCAPV 22	cm. 50x66x70h	€ 91,90
Art. SCAPV 32	cm. 80x96x70h	€ 109,90



Mercurio

cm. 30x80h	€ 46,90
------------	---------



Bordura Iris - filo 6mm

Art. IRIBO	cm. 60x30h conf. pz.4	cad. € 22,90
------------	-----------------------	--------------



Classic Metal Border marrone

Art. 170061	cm. 100x40h	5	€ 78,50
-------------	-------------	---	---------

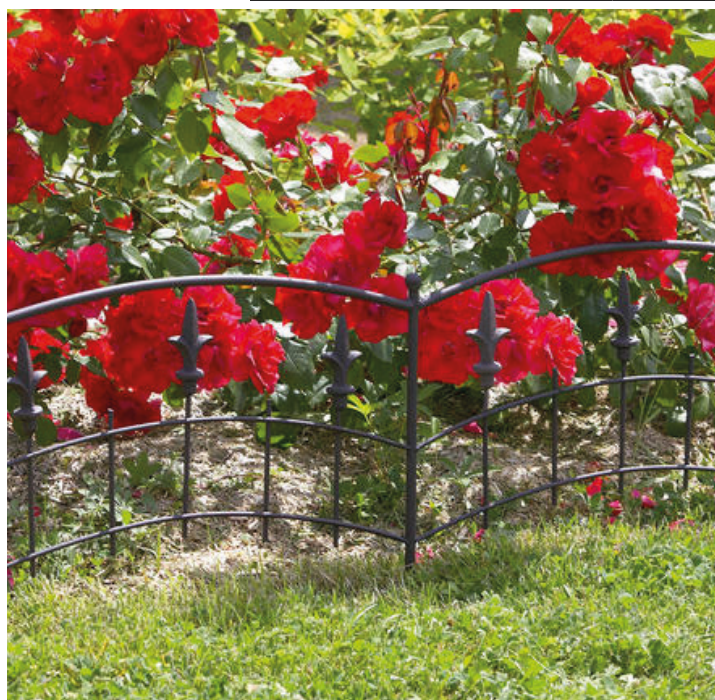

Royal Border marrone

Art. 170060	cm. 100x40h	5	€ 78,50
-------------	-------------	---	---------



*“sii sempre come
il mare
che infrangendosi
contro gli scogli
trova sempre la
forza per
riprovarci”*



TRALICCIO BAMBOO ESTENSIBILE

Art.	Misura	Tipo	Disp.	Q.tà	Prezzo
483	60L x 240H Cm	Estens.	Mag.	1	€ 17,90
261	60L x 180H Cm	Estens.	Mag.	1	€ 15,90
483/4	90L x 240H Cm	Estens.	Mag.	1	€ 21,90
262	90L x 180H Cm	Estens.	Mag.	1	€ 19,90
263	120L x 180H Cm	Estens.	Mag.	1	€ 27,90
264	150L x 180H Cm	Estens.	Mag.	1	€ 33,90
483/2	180L x 240H Cm	Estens.	Mag.	1	€ 44,90
1878	180L x 180H Cm	Estens.	Mag.	1	€ 46,90
1373	200L x 200H Cm	Estens.	Mag.	1	€ 53,90

TRALICCIO LEGNO EXTRA NATURALE O VERDE

Art.	Misura	Tipo	Disp.	Q.tà	Prezzo
802	100L x 200H Cm	Natura	Mag.	1	€ 11,90
802/3	100L x 300H Cm	Natura	Mag.	1	€ 16,90
802/1	150L x 200H Cm	Natura	Mag.	1	€ 17,90
802/6	100L x 200H Cm	Verde	Mag.	1	€ 11,90
802/4	100L x 300H Cm	Verde	Mag.	1	€ 16,90
802/7	150L x 200H Cm	Verde	Mag.	1	€ 17,90

TRALICCIO IN PVC COLORE BIANCO O VERDE

Art.	Misura	Tipo	Disp.	Q.tà	Prezzo
803	100L x 100H Cm	Bianco	Mag.	1	€ 10,90
803/1	100L x 200H Cm	Bianco	Mag.	1	€ 20,90
803/2	100L x 300H Cm	Bianco	Mag.	1	€ 30,90
803/3	100L x 100H Cm	Verde	Mag.	1	€ 10,90
803/4	100L x 200H Cm	Verde	Mag.	1	€ 20,90
803/5	100L x 300H Cm	Verde	Mag.	1	€ 30,90
803/7	160L x 200H Cm	Verde	Mag.	1	€ 31,90



CANNE BAMBOO NATURALE IN BUSTA BLISTER

Art.	Misura	Tipo	Disp.	Q.tà	Prezzo
6652 - 500/1	90 Cm H	8/10 Pz 7	Mag.	1	€ 3,90
6656 - 500/2	120 Cm H	10/12 Pz 4	Mag.	1	€ 3,90
6658 - 500/3	150 Cm H	12/14 Pz 3	Mag.	1	€ 4,20
6660 - 500/4	180 Cm H	12/14 Pz 3	Mag.	1	€ 5,80
6662 - 500/5	210 Cm H	16/18 Pz 2	Mag.	1	€ 4,80



CANNE BAMBOO NATURALE IN MAZZI

Art.	Misura	Tipo	Disp.	Q.tà	Prezzo
*005	90 Cm H	8/10 mm	Mag.	1000	€ 0,30
*007	120 Cm H	10/12 mm	Mag.	500	€ 0,40
*008	150 Cm H	10/12 mm	Mag.	100	€ 0,50
*780	150 Cm H	20/22 mm	Mag.	50	€ 0,90
*744	180 Cm H	12/14 mm	Mag.	100	€ 1,00
*011	180 Cm H	22/24 mm	Mag.	50	€ 1,50
*013	210 Cm H	22/24 mm	Mag.	50	€ 1,60
*255	240 Cm H	22/24 mm	Mag.	50	€ 1,90

BASTONCINI BAMBOO VERDI PER FIORI ESTENSIBILI

Art.	Misura	Tipo	Disp.	Q.tà	Prezzo
6682	40 Cm H Natu.	Pz 25 Busta	Mag.	1	€ 2,90
6684	50 Cm H Natu.	Pz 25 Busta	Mag.	1	€ 2,90
6690	40 Cm H Verdi.	Pz 25 Busta	Mag.	1	€ 2,90
6692	50 Cm H Verdi.	Pz 25 Busta	Mag.	1	€ 2,90
42503	50 Cm H Verdi.	Pz 20 Busta	Mag.	1	€ 2,90



TUTORI IN FERRO PLASTIFICATE DA mm 8 A mm 16

Art.	Misura	Tipo	Disp.	Q.tà	Prezzo
652	90 Cm H	Mazzo 50	Mag.	1	€ 0,90
652/1	120 Cm H	Mazzo 50	Mag.	1	€ 1,30
652/2	150 Cm H	Mazzo 50	Mag.	1	€ 1,60
652/3	180 Cm H	Mazzo 50	Mag.	1	€ 2,90
652/4	210 Cm H	Mazzo 50	Mag.	1	€ 3,40
652/5	240 Cm H	Mazzo 50	Mag.	1	€ 4,90



TUTORI IN BAMBOOCNODO PLASTIFICATE DA mm 8 A mm 16

Art.	Misura	Tipo	Disp.	Q.tà	Prezzo
999/6	Cm 60 H	Mazzo 50	Mag.	1	€ 0,60
999	Cm 100 H	Mazzo 50	Mag.	1	€ 0,80
999/1	Cm 120 H	Mazzo 50	Mag.	1	€ 1,00
999/2	Cm 150 H	Mazzo 50	Mag.	1	€ 1,40
999/3	Cm 180 H	Mazzo 50	Mag.	1	€ 2,10
999/	Cm 210 H	Mazzo 50	Mag.	1	€ 2,50



BASTONI MUSCHIATI PER PIANTE BLISTERATI

Art.	Misura	Tipo	Disp.	Q.tà	Prezzo
16050 - 1401	Dia. 05 H 60 Cm	6 Pz.	Mag.	1	€ 6,90
18050 - 1208	Dia. 05 H 80 Cm	6 Pz.	Mag.	1	€ 7,90
IMB10050 - 1209	Dia. 05 H 100 Cm	6 Pz.	Mag.	1	€ 9,90
IMB12050 - 1210	Dia. 05 H 120 Cm	6 Pz.	Mag.	1	€ 12,90
IMB15050 - 1211	Dia. 05 H 150 Cm	6 Pz.	Mag.	1	€ 15,90

I PREZZI RIPORTATI SONO ESCLUSI DI IVA



STUOIA MEZZA CANNA BAMBOO BEACH 10mm FILO ZINCATO

Art.	Misura	Tipo	Disp.	Q.tà	Prezzo
*770	300L x 150H Cm	Mezzac.	Mag.	1	€ 29,90
*771	300L x 200H Cm	Mezzac.	Mag.	1	€ 36,90
*2083	300L x 250H Cm	Mezzac.	8gg	1	€ 46,90
*268	500L x 150H Cm	Mezzac.	Mag.	1	€ 46,90
*270	500L x 200H Cm	Mezzac.	Mag.	1	€ 61,90



STUOIA CANNA BAMBOO 8/10mm FILO ESTERNO TIME

Art.	Misura	Tipo	Disp.	Q.tà	Prezzo
*715	300L x 100H Cm	Filo Est.	Mag.	1	€ 39,90
*716	300L x 150H Cm	Filo Est.	Mag.	1	€ 59,90
*717	300L x 200H Cm	Filo Est.	Mag.	1	€ 79,90
*1223	300L x 250H Cm	Filo Est.	8gg	1	€ 99,90
*272	500L x 150H Cm	Filo Est.	Mag.	1	€ 99,90
*273	500L x 200H Cm	Filo Est.	Mag.	1	€ 129,90

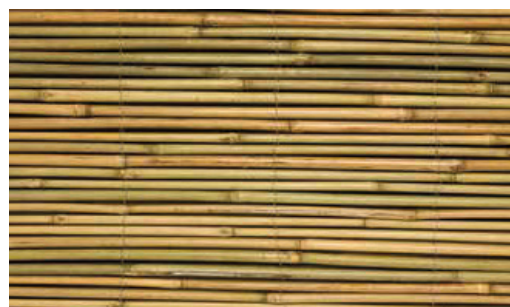

ARELLA CINA DI CANNETTA PULITA CONFEZIONATA

Art.	Misura	Tipo	Disp.	Q.tà	Prezzo
*295	300L x 100H Cm	Arella	Mag.	10	€ 8,90
*296	300L x 150H Cm	Arella	Mag.	5	€ 10,90
*297	300L x 200H Cm	Arella	Mag.	5	€ 17,90
*1290	400L x 250H Cm	Arella	8gg	3	€ 32,90
*710	500L x 100H Cm	Arella	Mag.	5	€ 14,90
*711	500L x 150H Cm	Arella	Mag.	5	€ 21,90
*298	500L x 200H Cm	Arella	Mag.	3	€ 29,90
*1118	500L x 250H Cm	Arella	8gg	2	€ 41,90
*1119	500L x 300H Cm	Arella	8gg	2	€ 49,90



STUOIA ERICA NATURALE BREZZO

Art.	Misura	Tipo	Disp.	Q.tà	Prezzo
*1108	500L x 100H Cm	Erica	Mag.	1	€ 75,90
*1109	500L x 150H Cm	Erica	Mag.	1	€ 110,90
*1110	500L x 200H Cm	Erica	Mag.	1	€ 149,90
*1849	300L x 150H Cm	Erica	Mag.	1	€ 119,90
*1850	300L x 200H Cm	Erica	Mag.	1	€ 159,90



STUOIA CANNA BAMBOO PIENA 15/20mm RIVER

Art.	Misura	Forma	Disp.	Q.tà	Prezzo
*756	300L x 100H Cm	Filo Pas.	Mag.	1	€ 68,90
*758	300L x 150H Cm	Filo Pas.	Mag.	1	€ 104,90
*759	300L x 200H Cm	Filo Pas.	Mag.	1	€ 135,90
*1397	300L x 250H Cm	Filo Pas.	8gg	1	€ 171,90
*2043	300L x 300H Cm	Filo Pas.	Mag.	1	€ 210,90



STUOIA CANNA BAMBOO PIENA VERSILIA - PROFILO UNIFORME

Art.	Misura	Forma	Disp.	Q.tà	Prezzo
*1845	300L x 100H Cm (SOLO SU ORDINAZIONE)	Filo Pas.	8gg	1	€ 79,90
*1846	300L x 150H Cm (SOLO SU ORDINAZIONE)	Filo Pas.	8gg	1	€ 119,90
*1847	300L x 200H Cm (SOLO SU ORDINAZIONE)	Filo Pas.	8gg	1	€ 159,90
*2197	300L x 250H Cm (SOLO SU ORDINAZIONE)	Filo Pas.	8gg	1	€ 195,90





STUOIA PVC DI OCCULTAZIONE BIFACCIALE

Art.	Misura	Forma	Disp.	Q.tà	Prezzo
5520	300L x 100H Cm (Crema)	Filo Nilon	Mag.	2	€ 59,90
5521	300L x 150H Cm (Crema)	Filo Nilon	Mag.	2	€ 82,90
5525	300L x 100H Cm (Verde)	Filo Nilon	Mag.	2	€ 59,90
5526	300L x 150H Cm (Verde)	Filo Nilon	Mag.	2	€ 82,90

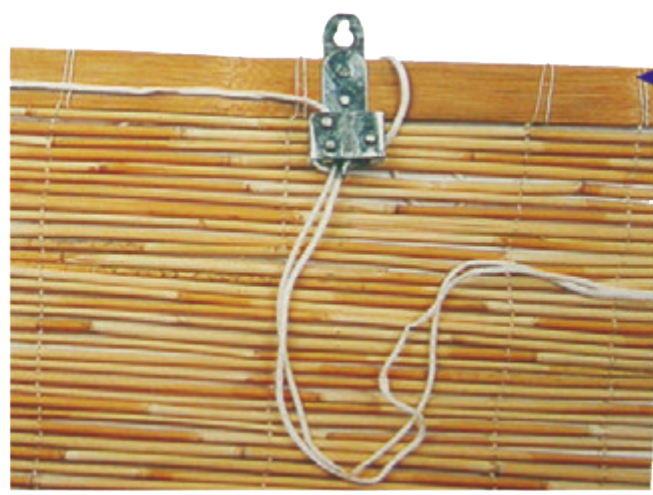

TAPPARELLA CON CARRUCOLA CINA

TAPPARELLA CON CARRUCOLA AFRICA

Art.	Misura	Tipo	Disp.	Q.tà	Prezzo
*400	100L x 160H Cm	Africa	Mag.	1	€ 21,90
*400/1	120L x 250H Cm	Africa	Mag.	1	€ 39,90
*400/2	150L x 300H Cm	Africa	Mag.	1	€ 59,90
*1890	200L x 300H Cm	Africa	Mag.	1	€ 79,90

Art.	Misura	Tipo	Disp.	Q.tà	Prezzo
*9922/1	90L x 180H Cm	Cina	Mag.	1	€ 11,90
*9922/2	100L x 260H Cm	Cina	Mag.	1	€ 16,90
*9922/3	120L x 260H Cm	Cina	Mag.	1	€ 20,90
*9922/4	150L x 300H Cm	Cina	Mag.	1	€ 26,90
*9922/7	180L x 300H Cm	Cina	Mag.	1	€ 33,90
*301	200L x 300H Cm	Cina	Mag.	1	€ 37,90

“se camminassimo solo nelle giornate di sole non raggiungeremo mai la nostra destinazione”



STUOIA LAURO PVC CON RETE OMBREGGIANTE STABILIZZATA UV

Art.	Misura	Tipo	Disp.	Q.tà	Prezzo
864 - 790/8	300L x 100H Cm	Rot.	Mag.	1	€ 68,90
865 - 790/9	300L x 150H Cm	Rot.	Mag.	1	€ 94,90

STUOIA LAURO PVC SENZA RETE OMBREGGIANTE STABILIZZATA UV

Art.	Misura	Tipo	Disp.	Q.tà	Prezzo
862 - 790/6	300L x 100H Cm	Rotolo	Mag.	1	€ 54,90
863 - 790/7	300L x 150H Cm	Rotolo	Mag.	1	€ 79,90

STUOIA EDERA PVC SENZA RETE OMBREGGIANTE STABILIZZATA UV

Art.	Misura	Tipo	Disp.	Q.tà	Prezzo
790/4	300L x 100H Cm	Rotolo	Mag.	1	€ 54,90
790/5	300L x 150H Cm	Rotolo	Mag.	1	€ 79,90

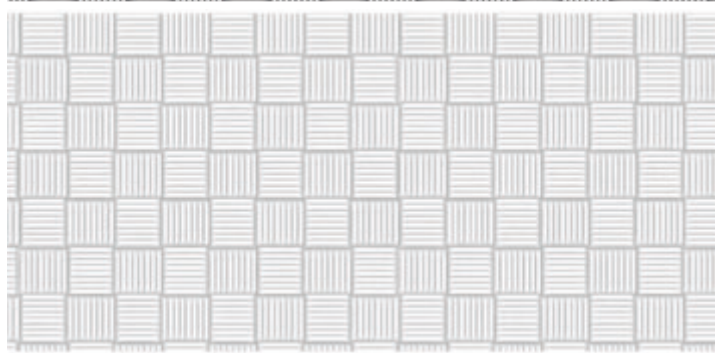
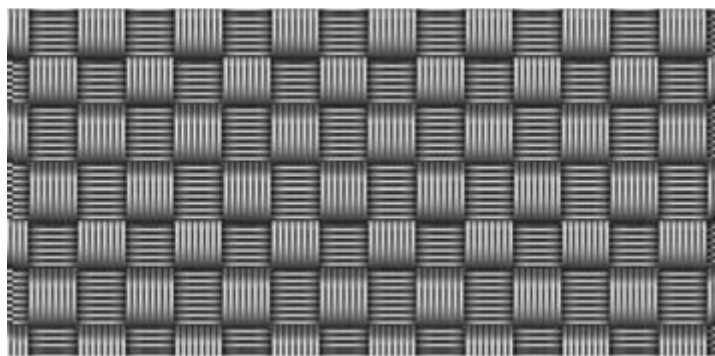
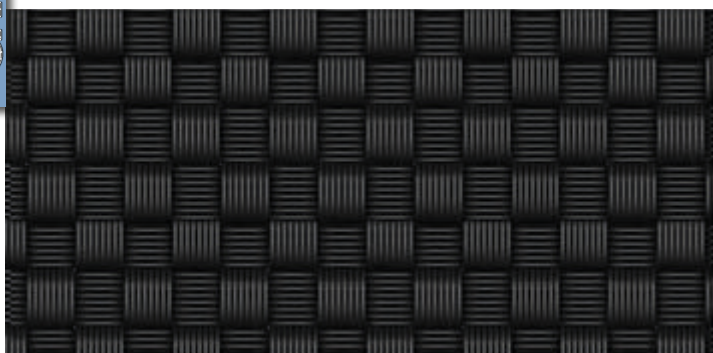
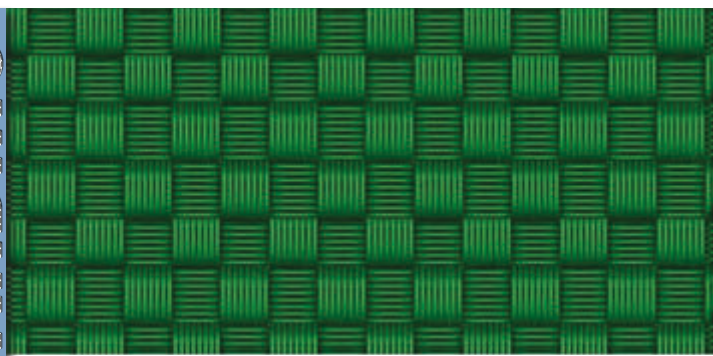

STRISCE FRANGIVISTA PRIVACY IN PVC - 830 gr. al mq - resistente UV

Art.	Misura	Forma	Disp.	Q.tà	Prezzo
8220	cm 19 x 205 (VERDE)	Bobina	Mag.	1	€ 12,90
8221	cm 19 x 205 (ANTRACITE)	Bobina	Mag.	1	€ 12,90

Art.	Misura	Forma	Disp.	Q.tà	Prezzo
8222	cm 19 x 205 (SILVER)	Bobina	Mag.	1	€ 12,90
8223	cm 19 x 205 (BIANCO)	Bobina	Mag.	1	€ 12,90

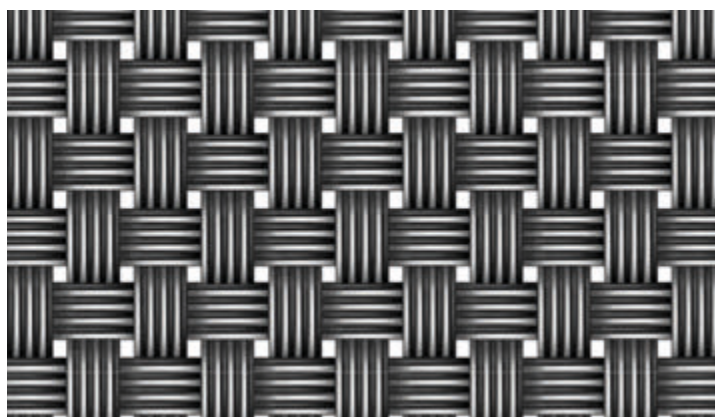

STRISCE FRANGIVISTA PRIVACY IN PVC - 830 gr. al mq - resistente UV

Art.	Misura	Forma	Disp.	Q.tà	Prezzo
8212	mt 1 x 3 (ANTRACITE)	Bobina	Mag.	1	€ 85,90

Art.	Misura	Forma	Disp.	Q.tà	Prezzo
8211	mt 1 x 3 (SILVER)	Bobina	Mag.	1	€ 85,90



TELO OCCHIELLATO VERDE E BLU INVERNALE 120Gr

Art.	Misura	Tipo	Disp.	Q.tà	Prezzo
1835	100H x 5000L Cm	Rot.90Gr	Mag.	1	€ 10,90
216	150H x 1000L Cm	Rot. 90Gr	Mag.	1	€ 24,90
217	200H x 1000L Cm	Rot. 90Gr	Mag.	1	€ 27,90
218	200H x 2000L Cm	Rot. 90Gr	Mag.	1	€ 43,90
174	150H x 10000L Cm	Rot. 90Gr	8gg	1	€ 133,90
175	200H x 10000L Cm	Rot. 90Gr	8gg	1	€ 176,90

RETE OMBREGGIANTE 90/95% OSCURANTE 90/130 Gr Mg

Art.	Misura	Tipo	Dispo.	Q.tà	Prezzo
1318	200LX300H Cm	Occhiell.	Mag.	12	€ 6,90
1319	300LX400H Cm	Occhiell.	Mag.	10	€ 12,90
1599	300LX500H Cm	Occhiell.	Mag.	8	€ 16,90
1320	400LX400H Cm	Occhiell.	Mag.	8	€ 17,90
1321	400LX500H Cm	Occhiell.	Mag.	6	€ 21,90
1322	400LX600H Cm	Occhiell.	Mag.	6	€ 25,90
1323	500LX600H Cm	Occhiell.	Mag.	4	€ 31,90
1690	500LX800H Cm	Occhiell.	Mag.	4	€ 43,90
1324	600LX800H Cm	Occhiell.	Mag.	2	€ 51,90
1691	600LX1000H Cm	Occhiell.	Mag.	2	€ 64,90
1692	800LX1000H Cm	Occhiell.	Mag.	1	€ 85,90
1693	800LX1200H Cm	Occhiell.	Mag.	1	€ 103,90



50 g



TELO ANTIALGA POLIPROPI. 100% STABILIZZATO UV NERO

Art.	Misura	Tipo	Disp.	Q.tà	Prezzo
205	105L x 1000H Cm	NERO / MARRONE	Rot. Mag.	1	€ 26,90
330	210L x 1000H Cm	NERO / MARRONE	Rot. Mag.	1	€ 48,90

TELO TNT BIANCO GR. 50 MQ DA PACCIAMATURA

2314	200L x 10000H Cm		Rot. 8gg.	1	€ 215,90
------	------------------	--	-----------	---	-----------------

TELO PER PACCIAMATURA IN TNT O PE PREFORATO

Art.	Misura	Tipo	Disp.	Q.tà	Prezzo
207	120L x 1000H Cm	Prefor.	Mag.	1	€ 14,90
209	120L x 5000H Cm	Prefor.	Mag.	1	€ 36,90
1838	120L x 10000H Cm	Prefor.	Mag.	1	€ 65,90
203	160L x 500H Cm	Prefor.	Mag.	1	€ 8,90
2083	200L x 1000H Cm	Prefor.	Mag.	1	€ 17,90
1601	160L x 10000 Cm	Prefor.	Mag.	1	€ 43,90
1020	200L x 10000 Cm	Prefor.	8gg.	1	€ 165,90

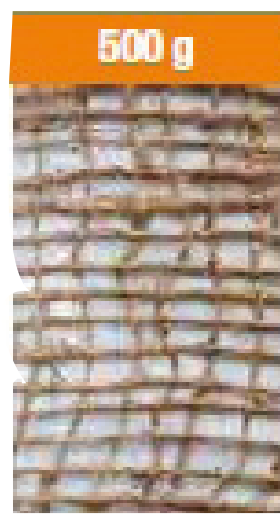

500 g



TELO JUTA PER PACCIAMA. E/O SCARPATE Gr 500

Art.	Misura	Tipo	Disp.	Q.tà	Prezzo
1919	122L x 5000HCm	Rete	Mag.	1	€ 184,90 Gr500



150 g



TELO RETINATO TRASPA.150Gr

Art.	Misura	Tipo	Disp.	Q.tà	Prezzo
1856	200L x 300H Cm	Occhiell.	Mag.	10	€ 12,90
1857	300L x 300H Cm	Occhiell.	Mag.	6	€ 18,90
1858	300L x 400H Cm	Occhiell.	Mag.	4	€ 25,90
1859	400L x 500H Cm	Occhiell.	Mag.	4	€ 42,90



300 g



TELO JUTA PER PACCIAMA. E/O SCARPATE Gr 200/330

Art.	Misura	Tipo	Disp.	Q.tà	Prezzo
1334	100L x 1000HCm	Balla	Mag.	1	€ 49,90 Gr300
798	140L x 1000HCm	Balla	Mag.	1	€ 59,90 Gr300
1335	200L x 1000HCm	Balla	Mag.	1	€ 83,90 Gr300
1918	100L x 10000HCm	Rete	Mag.	1	€ 265,90 Gr500

I PREZZI RIPORTATI SONO ESCLUSI DI IVA



BARBISELF GEOTESSILE NONTESSUTO POLIPROPILENE PER PACCIAMATURA gr.100 mq

Art.	Misura	Tipo	Disp.	Q.tà	Prezzo
BARBISELF100	mt 10L x cm 100H	Bobina	Mag.	1	€ 39,90
BARBISELF200	mt 10L x cm 200H	Bobina	Mag.	1	€ 73,90



BARBIDREN GEOTESSILE POLIESTERE PER GIARDINI PENSILI, FIORIERE gr.200 mq

Art.	Misura	Tipo	Disp.	Q.tà	Prezzo
BARBIDRENAGVC100	mt 50L x cm 100H	Bobina	Mag.	1	€ 115,90
BARBIDRENAGVC200	mt 50L x cm 200H	Bobina	Mag.	1	€ 229,90



NYLON TRASPA. 40MICRO. TELO RETINATO TRASPA.150Gr

Art.	Misura	Tipo	Disp.	Q.tà	Prezzo
212	200L x 500H Cm	Nylon	Mag.	12	€ 12,90
213	200L x 10000 Cm	Nylon	Mag.	12	€ 17,90



BARBICUT FORBICE PROFESSIONALE PER TAGLIARE TESSUTI PACCIAMANTI E TAPPETI ERBOSI

Art.	Misura	Tipo	Disp.	Q.tà	Prezzo
BARBICUT			Mag.	1	€ 46,90



RETE RACCOLTA OLIVE ANTISPINE TELO VERDE

Art.	Misura	Tipo	Disp.	Q.tà	Prezzo
292	5,00 x 10,00Mt	In Busta Pz 1	Mag.	6	€ 50,90
1698	6,00 x 10,00Mt	In Busta Pz 1	Mag.	5	€ 59,90
1131	6,00 x 12,00Mt	In Busta Pz 1	Mag.	4	€ 72,90
1699	8,00 x 10,00Mt	In Busta Pz 1	Mag.	4	€ 72,90
1700	8,00 x 12,00Mt	In Busta Pz 1	Mag.	3	€ 95,90



**SACCO NETTEZZA NERO 80 UM CARTONE DA 20Kg 125 SACCHI CA.
SACCO JUTA 200 Gr Mq POLIPROPILENE 60Gr Mq Prezzo Cad.Uno.**

Art.	Misura	Tipo	Disp.	Q.tà	Prezzo
210	90L x 120H Cm	Nylon Pesante	Mag.	125 pz	€ 7,50 kg.
2184	40L x 70H Cm	Juta 200 Gr	Mag.	100	€ 1,90 Cad.
1920	50L x 80H Cm	Juta 200 Gr	Mag.	100	€ 2,30 Cad.
1921	60L x 100H Cm	Juta 200 Gr	Mag.	100	€ 3,90 Cad.
1780	35L x 65H Cm	Polipro. Kg 25	Mag.	50	€ 0,60 Cad.
2295	45L x 75H Cm	Polipro. Kg 25	Mag.	50	€ 0,80 Cad.
1911	50L x 100H Cm	Polipro. Kg 25	Mag.	50	€ 1,10 Cad.
1783	60L x 120H Cm	Polipro. Kg 25	Mag.	50	€ 1,40 Cad.
2250	70L x 130H Cm	Polipro. Kg 25	Mag.	50	€ 1,70 Cad.



TESSUTO TNT VELO Gr 17

Art.	Misura	Tipo	Disp.	Q.tà	Prezzo
192	1,60 x 5 Mt	Busta 1 Velo	Mag.	20	€ 4,90
193	1,60 x 10 Mt	Busta 1 Velo	Mag.	20	€ 6,90
194	2 x 5 Mt	Busta 1 Velo	Mag.	20	€ 4,90
1658	2 x 10 Mt	Busta 1 Velo	Mag.	20	€ 7,90
1676	2,40 x 10 Mt	Busta 1 Velo	Mag.	20	€ 9,90
195	2 x 15 Mt	Bobina	Mag.	24	€ 12,90

TESSUTO TNT VELO Gr 30

1659	1,60 x 10 Mt	Busta 1 Velo	Mag.	20	€ 9,90
782	2 x 5 Mt	Busta 1 Velo	Mag.	20	€ 6,90
783	2 x 10 Mt	Busta 1 Velo	Mag.	20	€ 11,90
1660	2,40 x 10 Mt	Busta 1 Velo	Mag.	20	€ 12,90
2400	2,00 x 15 Mt	Bobina 1 Velo	Mag.	16	€ 14,90

TESSUTO TNT CAPPUCCIO Gr 17

Art.	Misura	Tipo	Disp.	Q.tà	Prezzo
1951	0,80 x 1 Mt	Busta 4 Cappuccio	Mag.	10	€ 5,90
199	1 x 1,20 Mt	Busta 3 Cappuccio	Mag.	10	€ 5,90
200	1,50 x 1,80 Mt	Busta 2 Cappuccio	Mag.	10	€ 5,90
1193	2 x 2,40 Mt	Busta 1 Cappuccio	Mag.	10	€ 5,90

TESSUTO TNT CAPPUCCIO Gr 30

790	1 x 1,60 Mt	Busta 3 Cappuccio	Mag.	10	€ 6,90
791	1,80 x 2 Mt	Busta 3 Cappuccio	Mag.	10	€ 13,90
1720	2 x 2,60 Mt	Busta 1 Cappuccio	Mag.	10	€ 7,90
1721	2,40 x 3,20 Mt	Busta 1 Cappuccio	Mag.	10	€ 11,90
2272	3,20 x 3,60 Mt	Busta 1 Cappuccio	Mag.	10	€ 16,90



"...ora non è il tempo per pensare a ciò che non hai pensa a quello che puoi fare con ciò che hai..."

RETE ANTI UCCELLI IN PVC DA Gr 36 A Gr 10

Art.	Misura	Tipo	Disp.	Q.tà	Prezzo
1561	2,00 x 5,00 Mt	Gr 10 Mq In Bus.	Mag.	12	€ 3,90
1562	2,00 x 10,00 Mt	Gr 10 Mq In Bus.	Mag.	12	€ 5,90
1563	4,00 x 5,00 Mt	Gr 10 Mq In Bus.	Mag.	8	€ 5,90
1564	4,00 x 10,00 Mt	Gr 10 Mq In Bus.	Mag.	8	€ 12,90
816	4,00 x 100,00 Mt	Gr 36 Mq Bobina	Mag.	5	€ 257,90
817	6,00 x 100,00 Mt	Gr 36 Mq Bobina	Mag.	1	€ 389,90

RETE PER RAMPICANTI IN PVC MAGLIA 15 x 17

Art.	Misura	Tipo	Disp.	Q.tà	Prezzo
221	1,50 x 10,00 Mt	In Busta	Mag.	12	€ 4,90
222	1,50 x 20,00 Mt	In Busta	Mag.	12	€ 10,90
226	2,00 x 5,00 Mt	In Busta	Mag.	12	€ 3,90
227	2,00 x 10,00 Mt	In Busta	Mag.	12	€ 7,90
228	2,00 x 20,00 Mt	In Busta	Mag.	12	€ 13,90
1593	2,00 x 50,00 Mt	Bobina	8gg	6	€ 29,90
1112	2,00 x 100,00 Mt	Bobina	8gg	6	€ 55,90

I PREZZI RIPORTATI SONO ESCLUSI DI IVA

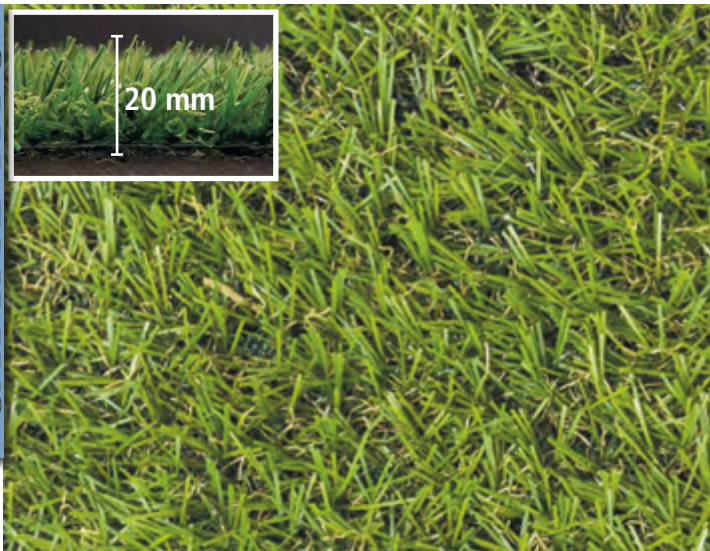

20 mm

ERBA SINTETICA mm 20 Wimbledon

Art.	Misura	Tipo	Disp.	Q.tà	Prezzo
2116	100H x 2500L Cm	Bobina Intera	Mag.	1	€ 15,90 Mq
2117	200H x 2500L Cm	Bobina Intera	Mag.	1	€ 15,90 Mq

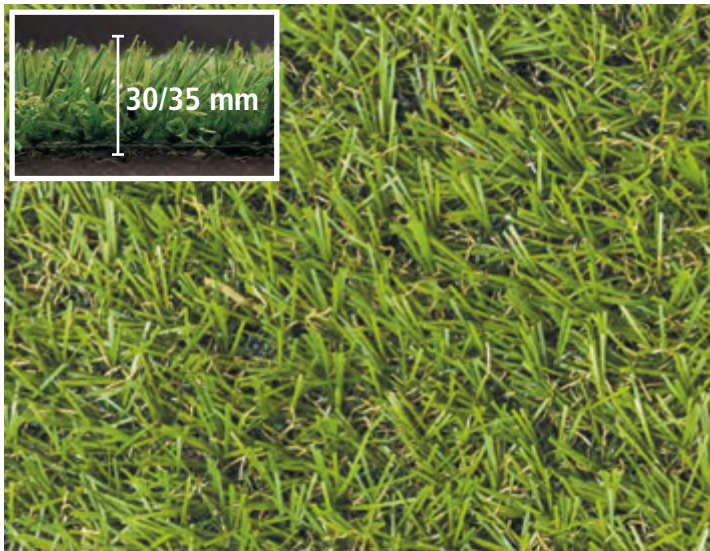

30/35 mm

ERBA SINTETICA mm 30/35 Wimbledon

Art.	Misura	Tipo	Disp.	Q.tà	Prezzo
2345	100H x 2500L Cm	Bobina Intera	Mag.	1	€ 20,90 Mq
2346	200H x 2500L Cm	Bobina Intera	Mag.	1	€ 20,90 Mq

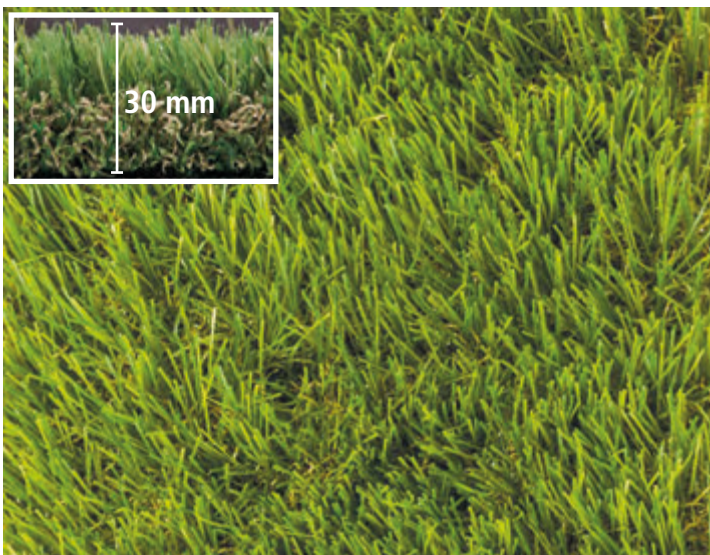

30 mm

ERBA SINTETICA mm 30/33 Eden

Art.	Misura	Tipo	Disp.	Q.tà	Prezzo
2258	100H x 2500L Cm	Bobina Intera	Mag.	1	€ 25,90 Mq
2259	200H x 2500 Cm	Bobina Intera	Mag.	1	€ 25,90 Mq

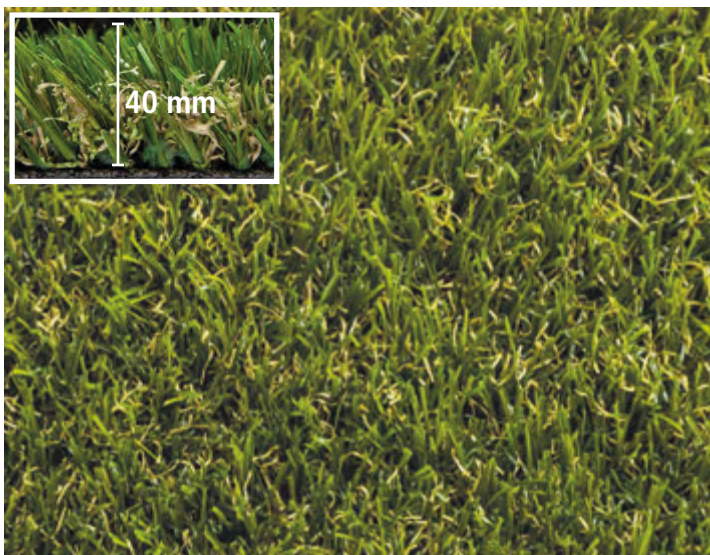

40 mm

ERBA SINTETICA mm 38/41 Chelsea

Art.	Misura	Tipo	Disp.	Q.tà	Prezzo
2290	100H x 2500L Cm	Bobina Intera	Mag.	1	€ 36,90 Mq
2291	200H x 2500L Cm	Bobina Intera	Mag.	1	€ 36,90 Mq

**ERBA SINTETICA Garden 20/24mm**

Art.	Misura	Tipo	Disp.	Q.tà	Prezzo
2015	Cm 100H x 5 Mt.	Bobina	Mag.	1	€ 71,90 cad.



8 mm

PRATO SINTETICO GREEN 2020 mm 8

Art.	Misura	Tipo	Disp.	Q.tà	Prezzo
2222	100H x 2500L Cm	Bobina Intera	Mag.	1	€ 11,90 Mq
2223	200H x 2500L Cm	Bobina Intera	Mag.	1	€ 11,90 Mq



PICCHETTI ACCIAIO ZINCATO PER PRATI SINTETICI

Art.	Misura	Tipo	Disp.	Q.tà	Prezzo
1615	cm 17x3 (filo mm.3)	Busta pz.20	Mag.	1	€ 7,90 cad.

BANDA GIUNZIONE BIADESIVA PER PRATI SINTETICI

Art.	Misura	Tipo	Disp.	Q.tà	Prezzo
2289	cm 15 x 100 mt.	Bobina	Mag.	1	€ 45,90 cad.

BANDA GIUNZIONE (GARZA) PER PRATI SINTETICI

Art.	Misura	Tipo	Disp.	Q.tà	Prezzo
1841	cm 30 x 25 mt.	Bobina	Mag.	1	€ 28,90 cad.



ADESIVO BICOMPONENTE PER PRATI SINTETICI

Art.	Misura	Tipo	Disp.	Q.tà	Prezzo
2355	Kg. 5	Secchiello	Mag.	1	€ 69,90 cad.

ADESIVO MONOCOMPONENTE PER PRATI SINTETICI

Art.	Misura	Tipo	Disp.	Q.tà	Prezzo
2354	Kg. 1 (Presa Rapida)	Flacone	Mag.	1	€ 63,90 cad.

DETERGENTE PROFESSIONALE PER PRATI SINTETICI

Art.	Misura	Tipo	Disp.	Q.tà	Prezzo
2356	ml. 750	Flacone	Mag.	1	€ 23,90 cad.

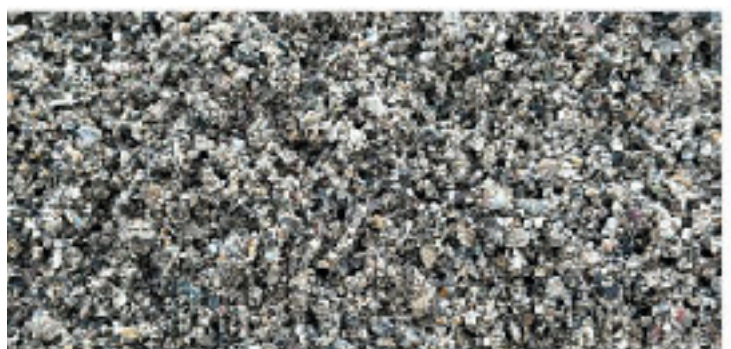

GRANULATO SINTETICO Kg. 25

Art.	Misura	Tipo	Disp.	Q.tà	Prezzo
1384	Kg. 25	1-3 mm. grigio	Mag.	1	€ 15,90 cad.

SABBIA SILICEA in sacco Kg. 25

Art.	Misura	Tipo	Disp.	Q.tà	Prezzo
SBGRS25	Kg. 25	0-4 mm. grigio	Mag.	1	€ 6,90 cad.
SBBIS25	Kg. 25	0-4 mm. bianco	Mag.	1	€ 12,90 cad.

I PREZZI RIPORTATI SONO ESCLUSI DI IVA



034 - 1202



2544



2091-2052-2093

PICCHETTI IN ACCIAIO O PVC FERMA TELO A TERRA

Art.	Misura	Tipo	Disp.	Q.tà	Prezzo
2544	27 x 6 x filo 0,5 Cm	Ad "U" PZ 25	Mag.	1	€ 10,90
2091	23 x 4 x filo 0,35 Cm	Ad "U" PZ 200	Mag.	1	€ 0,50 Cad.
2093	19 x 5 x filo 0,5 Cm	Ad "U" PZ 15	Mag.	1	€ 8,90
034	12 x 3 PVC Pesante	Lisca Pz 10	Mag.	1	€ 3,90
1202	12 x 5 PVC Pesante	Lisca Pz 200	Mag.	1	€ 0,70 Cad.
1615	17 x 17 FILO 3MM FERRO Pesante	Sacchetto Pz 20	Mag.	1	€ 7,90

1977



1935 - 1937 - 2050



185 - 1022AN
244 + 1574



100 - 1294 - 1512

1679 - 1648 - 1734

RAFIA NAT. MAJUNGA / RAFIA SINT. ROCCHETTO

Art.	Misura	Tipo	Disp.	Q.tà	Prezzo
100	Gr 50 Naturale	Gomitolo	Mag.	12	€ 2,90
1294	Gr 150 Naturale	Gomitolo	Mag.	12	€ 6,90
1512	Gr 1000 Naturale	Matassa	Mag.	100	€ 26,90
1679	Gr 100 Sintetica	Rocc. Verde/Bianco	Mag.	30	€ 1,90
1648	Gr 200 Sintetica	Rocc. Verde	Mag.	20	€ 2,90
1734	Gr 500 Sintetica	Rocc. Verde	Mag.	10	€ 8

TUBICINO GOMITOLO TUBICINO MATASSA

Art.	Misura	Tipo	Disp.	Q.tà	Prezzo
185-1022AN	Dia. 2,5 mm Gr 200/250 C.A.	Gomit. Blister	Mag.	30	€ 3,90
244	Dia. 3mm Gr 500 C.A.	Gomit. Blister	Mag.	20	€ 5,90
1575	Dia. 3mm Gr 1000 C.A.	Gomit. Blister	Mag.	12	€ 8,90
1680	Dia. 5mm Gr 1000 C.A.	Gomit. Blister	Mag.	12	€ 8,90
2048	Dia. 7mm Gr 1000 C.A.	Gomitolo	8gg	20	€ 8,90
1935	Dia. 3mm Gr 2000 C.A.	Matassa	Mag.	20	€ 19,90
1937	Dia. 5mm Gr 2000 C.A.	Matassa	Mag.	20	€ 19,90
2050	Dia. 7mm Gr 2000 C.A.	Matassa	8gg	20	€ 19,90
1977	Dia. 3mm Mt 100 C.A.	Gomit. BIO 100%	Mag.	18	€ 24,90



4564



1578



1577



1445

433/9-111-1988



cm. 25 1447



cm. 20 1581



cm. 30 1580

MAZZETTI PIATTINA ANIMATA / BLISTER / BOBINA

Art.	Misura	Tipo	Disp.	Q.tà	Prezzo
4564	Piattina Blister Cm 12 Pz 100		Mag.	1	€ 2,90
1445	Piattina Mazzo Cm 20 Pz 1000		Mag.	1	€ 7,90
1577	Piattina Mazzo Cm 25 Pz 1000		Mag.	1	€ 9,90
1578	Piattina Mazzo Cm 30 Pz 1000		Mag.	1	€ 11,90
433/9	Bobina Piatt. Mt 50 Blister		Mag.	1	€ 4,90
111	Bobina Piatt. Mt 50 Blister		Mag.	1	€ 4,90
1988	Bobina Piatt. Mt 25 Blister		Mag.	1	€ 3,90

FILO PIATTINA ANIMATA CARTA

Art.	Misura	Tipo	Disp.	Q.tà	Prezzo
1447	Piattina Mazzo Cm 20 Pz 1000	Carta	Mag.	1	€ 6,90
1581	Piattina Mazzo Cm 25 Pz 1000	Carta	Mag.	1	€ 7,90
1580	Piattina Mazzo Cm 30 Pz 1000	Carta	Mag.	1	€ 9,90



BOBINE E MATASSE IN FILO DI FERRO ZINC. E/O PLAST. VERDE

Art.	Misura	Tipo	Disp.	Q.tà	Prezzo
434	Dia. Mm 1,8 x 20 Mt	Matassa Plasti.	Mag.	12	€ 2,90
435	Dia. Mm 1,4 x 20 Mt	Matassa Zincata	Mag.	12	€ 2,90
1482	Dia. Mm 2,7x 100 Mt	Matassa Plasti.	8 gg	5	€ 25,90
1487	Dia. Mm 2,2 x 100 Mt	Matassa Zincata	8 gg	5	€ 25,90

BOBINE E MATASSE IN FILO DI FERRO ZINC. E/O PLAST. VERDE

Art.	Misura	Tipo	Disp.	Q.tà	Prezzo
433	Dia. Mm 0,7 x 50 Mt	Bobina Zincata	Mag.	12	€ 3,90
433/1	Dia. Mm 1 x 50 Mt	Bobina Zincata	Mag.	12	€ 3,90
433/2	Dia. Mm 1,15 x 50 Mt	Bobina Plasti.	Mag.	12	€ 3,90
4492	Dia. Mm 5	Ferro Gommato	Mag.	6	€ 6,90
4393	Dia. Mm 8	Ferro Gommato	Mag.	6	€ 9,90



CLIP PVC FERMA RETE

Art.	Misura	Tipo	Disp.	Q.tà	Prezzo
112	4 x 4 Busta Pz 10	Clip	Mag.	1	€ 4,90



1583 - 1584 - 2187

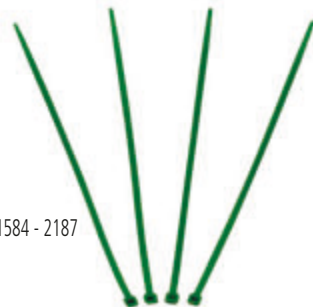

055939

SPAGO JUTA-SPAGO AGAVE-SPAGO CANAPA PRODOTTI ECOLOGICI

Art.	Misura	Tipo	Disp.	Q.tà	Prezzo
4471	Mt 50 CA Naturale	Busta Blister	Mag.	12	€ 6,50
4470	Mt 60 CA Verde	Busta Blister	Mag.	24	€ 7,90
4480	Gr 90 CA 3/4 Naturale	Gomitolo Grosso	Mag.	10	€ 3,90

FASCETTE CABLAGGIO E DENTELLATE PVC

Art.	Misura	Tipo	Disp.	Q.tà	Prezzo
1583	14 x 3,6 Cm Verde	Busta Pz 100	Mag.	1	€ 4,90
1584	20 x 4,8 Cm Verde	Busta Pz 100	Mag.	1	€ 8,90
2187	29 x 4,8 Cm Verde	Busta Pz 100	Mag.	1	€ 14,90
1458	29 x 4,8 Cm Nero	Busta Pz 100	Mag.	1	€ 11,90
1459	36 x 4,8 Cm Nero	Busta Pz 100	Mag.	1	€ 13,90
1460	43 x 4,8 Cm Nero	Busta Pz 100	Mag.	1	€ 21,90

FASCETTE CABLAGGIO E DENTELLATE PVC

Art.	Misura	Tipo	Disp.	Q.tà	Prezzo
4412	18 x 3 Cm Dentellata	Busta Pz 25	Mag.	1	€ 4,90
034644	10 x 3 Cm Dentellata	Busta Pz 100	Mag.	1	€ 3,90
055939	10 x 3 Cm Colorato	Busta Pz 100	Mag.	1	€ 1,90



ETICHETTE PER VASI IN PLASTICA GIALLO

Art.	Misura	Tipo	Disp.	Q.tà	Prezzo
1762	15 H x 6 x 4 Cm	Blister Pz 10	Mag.	12	€ 5,90
1763	20 H x 6,5 x 4,5 Cm	Blister Pz 10	Mag.	12	€ 6,90
2041	33 H x 10 x 6 Cm	Busta Pz 50	Mag.	1	€ 1,60 Cad.
2042	53 H x 15 x 10 Cm	Busta Pz 25	Mag.	2	€ 3,20 Cad.



VASETTI DI TORBA PER SEMINA

Art.	Misura	Tipo	Disp.	Q.tà	Prezzo
2318	16L x 12P x 5H Cm	12 Buchi Pz 6	Mag.	1	€ 7,90
2320	5L x 5P x 6H Cm	1 Buco Pz 10	Mag.	1	€ 4,90
2319	Dia. 6 x 6H Cm	1 Buco Pz 12	Mag.	1	€ 4,90

“...la perfezione non esiste puoi solo fare del tuo meglio e crescere...”



Fiaccola Cotto Citronella

art.0117	cm. 17 (pz.20)	€ 3,90
art.0118	cm. 15 (pz.30)	€ 3,20



Budino Citronella

art.0119	Cotto cm. 9 (pz.24)	€ 1,90
art.0121	Alluminio cm. 8 (pz.36)	€ 1,60



Profumatore Citronella

art. 2050/7 | pz.10 | € 2,90



Torcia da tavolo

art. 2062 | cm. 35 | € 3,90

Fiaccola Stagnola Citronella

art.0122	cm. 16 (pz.20)	€ 3,30
art.0125	cm. 14 (pz.25)	€ 3,00



Olio per torce

art. 1111	Lt.1 (12 pz.) cad.1	€ 8,90
art. 1111/1	Lt.5 (4 pz.) cad. 1	€ 39,90



Torce Bambù

art.2062/2	cm. 90	€ 2,90
art.2062/3	cm. 120	€ 3,90
art.2062/4	cm. 150	€ 6,90
art.2062/5	cm. 180	€ 8,90



Profumatore

art. 238738 | pz.10 piccolo | € 2,10

Stoppini per torce in cotone

art.250	cm. 12 pz.10	€ 3,00
art.250/1	cm. 22 pz.10	€ 3,90





DA ESTERNO SCOPA IN BAMBOO, SCOPA SAGGINA, SCOPA FIBRA PLASTICA

Art.	Misura	Tipo	Dispo.	Q.tà	Prezzo
835 Scopa	Bambboo 15 Rami		Mag.	10	€ 9,90
804 Scopa	Saggina 4 Cuciture Manico legno		Mag.	10	€ 13,90
1607 Scopa	Saggina GIANNINA LUX		Mag.	10	€ 16,90
1510 Scopa	Fibra Plastica C/Manico Legno		Mag.	10	€ 16,90
811 Manico	In Legno a Vite Per Scopa 1510		Mag.	10	€ 4,90



DA INTERNO ED ESTERNO SCOPA IN FIBRA

Art.	Misura	Tipo	Dispo.	Q.tà	Prezzo
2003 Scopa	Scopa pax esterno fibra verde rigida		Mag.	6	€ 5,90
803 Scopa	Country Angolare C/Manico		Mag.	6	€ 7,90
1767 Scopone	Base in Legno C/Manico (Cm 80)		Mag.	3	€ 15,90
809 Manico	Manico doppia plastica a vite (Cm 130)		Mag.	3	€ 2,90
811 Manico	In Legno a vite per scopa		Mag.	10	€ 4,90
2099 Manico	Per Scopone 1767		Mag.		€ 4,90



ALZA IMMONDIZIA ZINCATO, COLORATO, ED IN PVC

Art.	Misura	Tipo	Dispo.	Q.tà	Prezzo
211/2	Alzaimmondizia Zincato		Mag.	6	€ 8,90
211/4	Paletta Metallo Zincato		Mag.	12	€ 5,90
211/30	Alzaimmondizia Colorato		Mag.	12	€ 9,90
211/32	Paletta Metallo Colorata		Mag.	12	€ 6,90



ACCESSORI GIARDINO

Art.	Misura	Tipo	Dispo.	Q.tà	Prezzo
5000	Grembiule poliesteri c/tasca Lavabile		Mag.	12	€ 19,90
5005	Fodero Marsupio Porta Attrezzi		Mag.	12	€ 14,90
5007	Borsa Porta Attrezzi da Giardino		Mag.	6	€ 26,90
5008	Fodero Per Forbici C/Cintura,		Mag.	12	€ 9,90
5009	Fodero Per Attrezzi C/Cintura,		Mag.	12	€ 14,90
3006	Tappetino Salva Ginocchia		Mag.	12	€ 5,90

GUANTI IN TESSUTO ANTISCIVOLO DA GIARDINO HOBBY

Art.	Misura	Tipo	Dispo.	Q.tà	Prezzo
4983 Tg S	Guanto Floreale Poliesteri		Mag.	12	€ 4,90
4984 Tg M	Guanto Floreale Poliesteri		Mag.	12	€ 4,90
4981 Tg S	Guanto Floreale Ecopelle		Mag.	12	€ 13,90
4982 Tg M	Guanto Floreale Ecopelle		Mag.	12	€ 13,90



ALZAIMMONDIZIA E SCOPA

Art.	Misura	Tipo	Dispo.	Q.tà	Prezzo
10005	cm. 30X20h	Indor	Mag.	1	€ 7,90
10019	cm. 28,5x28x82h	Ass. ROSSA	Mag.	1	€ 4,90
10013	cm. 23,5x20x76h	Ass. VERDE	Mag.	1	€ 2,90



GUANTI IN TESSUTO ANTISCIVOLO DA GIARDINO HOBBY

Art.	Misura	Tipo	Dispo.	Q.tà	Prezzo
4936	Guanto Stoffa Giallo BIMBO		Mag.	12	€ 5,90
4912	Guanto Birnbo/Biamba Pelle-Stoffa		Mag.	12	€ 10,90
4902	Guanto Stoffa C/Fiori Donna		Mag.	12	€ 4,90



1960957

GUANTI IN TESSUTO ANTISCIVOLO DA GIARDINO HOBBY

Art.	Misura	Tipo	Dispo.	Q.tà	Prezzo
1960793	Guanto Uomo Poliuretano Elast TG. 9		Mag.	12	€ 2,90
1960793	Guanto Uomo Poliuretano Elast TG. 10		Mag.	12	€ 2,90
1960957	Tg 7 Pz 6	Lavoro	Mag.	6	€ 2,50
1960958	Tg 8 Pz 6	Lavoro	Mag.	6	€ 2,50



GUANTO IN CROSTA VITELLO PER ROSE E/O PER PIANTE GRASSE

Art.	Misura	Tipo	Dispo.	Q.tà	Prezzo
4890	S C/Manichette	Per Rose	Mag.	1	€ 27,90
4891	M C/Manichette	Per Rose	Mag.	1	€ 27,90
4892	L C/Manichette	Per Rose	Mag.	1	€ 27,90

Artiglio

Flexy



Jaguar

GUANTO DA LAVORO IN LATTICE ANTISCIVOLO

Art.	Misura	Tipo	Dispo.	Q.tà	Prezzo
JAGUAR	Tg 8 Pz 12	Mimetico Lattice	Mag.	12	€ 4,30
JAGUAR	Tg 9 Pz 12	Mimetico Lattice	Mag.	12	€ 4,30
JAGUAR	Tg 10 Pz 12	Mimetico Lattice	Mag.	12	€ 4,30
FLEX 2/3	Tg 7 Pz 12	Nero Lattice	Mag.	12	€ 2,50
FLEX 2/3	Tg 8 Pz 12	Nero Lattice	Mag.	12	€ 2,50
FLEX 2/3	Tg 9 Pz 12	Nero Lattice	Mag.	12	€ 2,50
FLEX 2/3	Tg 10 Pz 12	Nero Lattice	Mag.	12	€ 2,50
ARTIGLIO	Tg U Pz 3	Verde/Nero Lattice	Mag.	12	€ 9,90



Guanto Para Nero/Rosso - Polso Maglia

Art.	Dispo.	Q.tà	Prezzo
GS200PLUS	Taglie 8 - 9 - 10	Mag.	12 € 5,50



Flexy Touch Giallo - Dita Touch

Art.	Dispo.	Q.tà	Prezzo
FLEXYTOUCH1	Taglie 8 - 9 - 10	Mag.	12 € 4,50



GUANTO ANTITAGLIO HDPE/POLIURETANO

Art.	Dispo.	Q.tà	Prezzo
DIN5D	Taglie 9 - 10 - 11 - 12	Mag.	12 € 8,90



GUANTO POLIESTERE BIANCO ANTISCIVOLO - POLSO MAGLIA

Art.	Dispo.	Q.tà	Prezzo
FLEXY/B3	Taglie 8 - 9 - 10 - 11	Mag.	12 € 2,10



GUANTO IN PELLE FIOR MAIALINO TREND PER LAVORO PESANTE

Art.	Misura	Tipo	Dispo.	Q.tà	Prezzo
109TREND	Tg 7 Pz 12	Lavoro	Mag.	12	€ 8,20
109TREND	Tg 8 Pz 12	Lavoro	Mag.	12	€ 8,20
109TREND	Tg 9 Pz 12	Lavoro	Mag.	12	€ 8,20
109TREND	Tg 10 Pz 12	Lavoro	Mag.	12	€ 8,20
109TREND	Tg 11 Pz 12	Lavoro	Mag.	12	€ 8,20



GUANTO PROTEZIONE MOTOSEGA ANTITAGLIO

Art.	Misura	Tipo	Dispo.	Q.tà	Prezzo
PROT.500	Tg L - XL	Lavoro	Mag.	1	€ 85,00



GUANTO IN PELLE FIOR DI VITELLO PER LAVORO PESANTE

Art.	Misura	Tipo	Dispo.	Q.tà	Prezzo
114ET	Tg 7 Pz 10	Lavoro	Mag.	10	€ 6,90
114ET	Tg 8 Pz 10	Lavoro	Mag.	10	€ 6,90
114ET	Tg 9 Pz 10	Lavoro	Mag.	10	€ 6,90
114ET	Tg 10 Pz 10	Lavoro	Mag.	10	€ 6,90
114ET	Tg 11 Pz 10	Lavoro	Mag.	10	€ 6,90



GUANTO IN LATTICE USA E GETTA

Art.	Misura	Tipo	Dispo.	Q.tà	Prezzo
LATEX-20	Tg S Pz. 20	Busta Blister	Mag.	6	€ 5,50
LATEX-20	Tg M Pz. 20	Busta Blister	Mag.	6	€ 5,50
LATEX-20	Tg L Pz. 20	Busta Blister	Mag.	6	€ 5,50
LATEX-20	Tg XL Pz. 20	Busta Blister	Mag.	6	€ 5,50
121/10	Tg S Pz. 100	Scatola	Mag.	6	€ 25,50
121/10	Tg M Pz. 100	Scatola	Mag.	6	€ 25,50
121/10	Tg L Pz. 100	Scatola	Mag.	6	€ 25,50
121/10	Tg XL Pz. 100	Scatola	Mag.	6	€ 25,50



152



ATTREZZI HOBBY PER GIARDINAGGIO

Art.	Misura	Tipo	Dispo.	Q.tà	Prezzo
145	Scopetta 9 Denti		Mag.	10	€ 7,90
146	Rastrellino 5 Denti		Mag.	10	€ 8,90
147	Zappetta Tridente		Mag.	10	€ 8,90
149	Paletta Trapiantatore Stretta		Mag.	10	€ 7,90
150	Paletta Trapiantatore Largha		Mag.	10	€ 7,90
1344	Trapiantatore Pistola		Mag.	10	€ 7,90
1932	Paletta Verde		Mag.	10	€ 5,90

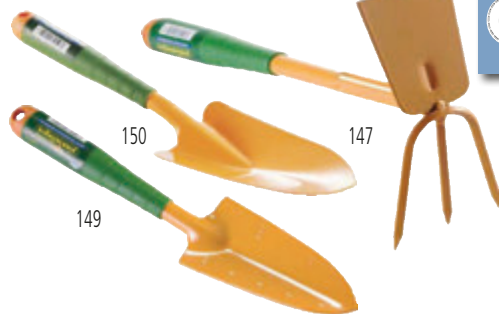

1997 / 1999

1653



3911



ATTREZZATURA PER GIARDINAGGIO

Art.	Misura	Tipo	Dispo.	Q.tà	Prezzo
2950	Scarpa Chiodata Aerazione Prato		Mag.	1	€ 24,90
3949	Estirpatore Erbacce Infestanti		Mag.	1	€ 37,90
3911	Pinza Raccogliatrice		Mag.	1	€ 29,50
152	Pianta Bulbi Zinco		Mag.	10	€ 12,90

“... non dire mai alle persone come fare le cose, digli cosa fare e tisorprenderanno con i loro risultati ...”



321021

1756

1192



3210011



260001

ZAPPA TOSCANA, ZAPPA LARGA, BIDENTE, PICCONE, MANICO LEGNO

Art.	Misura	Tipo	Dispo.	Q.tà	Prezzo
3210011	Zappa Occhio Ovale C/Manico		Mag.	4	€ 23,90
321021	Zappa Occhio Ovale C/Manico		Mag.	4	€ 20,90
260001	Occhio Ovale C45 C/Manico		Mag.	4	€ 28,90

RASTRELLO, SCOPE PER FOGLIE E GIARDINO, FORCA, MANICO IN LEGNO

Art.	Misura	Tipo	Dispo.	Q.tà	Prezzo
1997	12 Denti C/Manico in Faggio cm. 150		Mag.	4	€ 18,90
1999	16 Denti C/Manico in Faggio cm. 150		Mag.	4	€ 20,90
1653	Fissa in Metallo Foglie (NO MANICO)		Mag.	4	€ 6,90
1192	Fissa PVC Foglie C/Manico		Mag.	4	€ 14,90
1756	Fissa PVC Giardino C/Manico FORCA		Mag.	4	€ 37,90
1498	Manico in Faggio cm. 150		Mag.	4	€ 5,90

I PREZZI RIPORTATI SONO ESCLUSI DI IVA



240008

BADILE IN ACCIAIO PESANTE, VANGA IN ACCIAIO PESANTE, MANICO IN LEGNO

Art.	Misura	Tipo	Dispo.	Q.tà	Prezzo	
1525	Badile C/ Punta Acuta e Manico LEGNO	MADE IN ITALY	Mag.	4	€ 34,50	
1526	Badile C/ Punta Tonda e Manico LEGNO	MADE IN ITALY	Mag.	4	€ 25,50	
1724	Vanghetto C/Staffa e Manico LEGNO	MADE IN ITALY	Mag.	4	€ 44,50	
1725	Vanga Siena C/Staffa e Manico LEGNO	MADE IN ITALY	Mag.	4	€ 54,50	
1740	Vanga Vivaista C/Staffa e Manico LEGNO	MADE IN ITALY	Mag.	4	€ 61,50	
1489	Badile	Manico in Faggio Dia. 4 x 140 Cm	MADE IN ITALY	Mag.	5	€ 7,50
1488	Vanga	Manico in Faggio Dia. 4 x 140 Cm	MADE IN ITALY	Mag.	5	€ 7,50
1491	Vivaista	Manico in Faggio Dia. 45 x 140 Cm	MADE IN ITALY	Mag.	5	€ 9,50
240001	Vanghetto C/Staffa e Manico	IMPORT	Mag.	4	€ 22,50	
1631	Staffa per Vanga	IMPORT	Mag.	4	€ 12,50	

BADILE IN ACCIAIO PESANTE, MANICO IN LEGNO

Art.	Misura	Tipo	Dispo.	Q.tà	Prezzo
2055/27	Badile forgiato batagino NO manico		Mag.	12	€ 16,50
2055/28	Badile forgiato vivaista NO manico		Mag.	12	€ 20,50
2055/24	Badile verniciato NO manico		Mag.	12	€ 14,50
2055/26	Badile forgiato a punta NO manico		Mag.	12	€ 14,50
383/14	Manico in Faggio Piccone 95 cm		Mag.	12	€ 7,50
383/0	Manico in Faggio Zappa Tondo Dia. 3,5 x 130 cm	MADE IN ITALY	Mag.	12	€ 8,50
383/13	Manico in Faggio Zappino Dia. 3,2 x 130 cm	MADE IN ITALY	Mag.	12	€ 6,50
383/12	Manico in Faggio Badile dritto 140 cm	MADE IN ITALY	Mag.	12	€ 7,50
383/11	Manico in Faggio Badile curvo 140 cm	MADE IN ITALY	Mag.	12	€ 7,50
383/15	Manico in Faggio Rastrello 150 cm	MADE IN ITALY	Mag.	12	€ 5,50

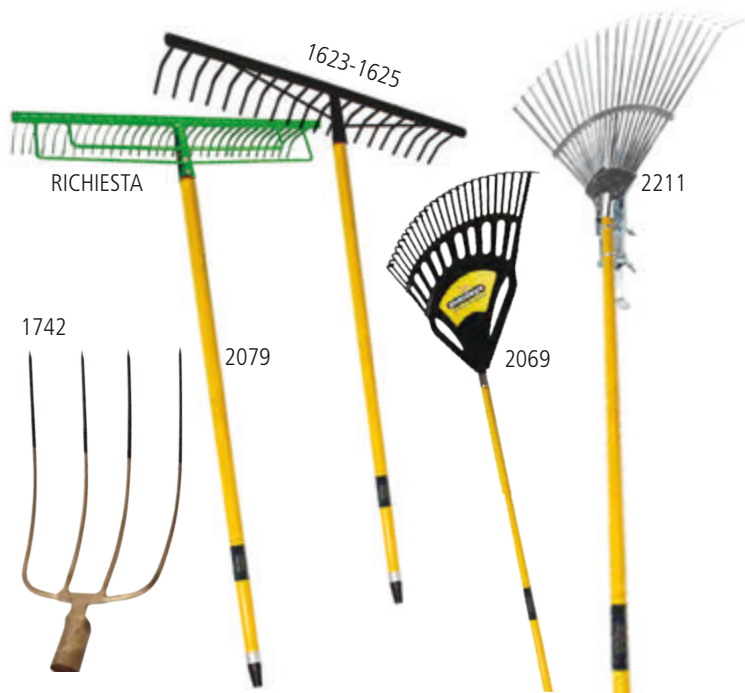

RASTRELLO, SCOPE PER FOGLIE E GIARDINO, FORCA, MANICO IN LEGNO

Art.	Misura	Tipo	Dispo.	Q.tà	Prezzo
1623	Rastrello	12 Denti Senza Manico	Mag.	4	€ 8,50
1625	Rastrello	16 Denti Senza Manico	Mag.	4	€ 10,50
2069	Scopa	Fissa Foglie con Manico in Fibra di Vetro	Mag.	4	€ 39,50
2211	Scopa	Regolabile Metallo Foglie Senza Manico	Mag.	4	€ 11,50
1498	Manico Legno per Rastrelli		Mag.	6	€ 5,50
1742	Forcone Classico c/ Manico		Mag.	4	€ 51,50

ZAPPA TOSCANA, ZAPPA LARGA, BIDENTE, PICCONE, MANICO LEGNO

Art.	Misura	Tipo	Dispo.	Q.tà	Prezzo	
1469	Toscana	Zappa Occhio Ovale C/Manico	MADE IN ITALY	Mag.	4	€ 37,50
331	Larga	Zappa Occhio Ovale C/Manico	MADE IN ITALY	Mag.	4	€ 38,50
1472	Bidente	Bidente Occhio Ovale C/Manico	MADE IN ITALY	Mag.	4	€ 51,50
1497	Manico	Legno Faggio Ovale 4/5 x 140 Cm	MADE IN ITALY	Mag.	5	€ 9,50
1745	Piccone	Occhio Ovale C45 C/Manico Legno	MADE IN ITALY	Mag.	4	€ 30,50
1635	Manico Piccone Legno	MADE IN ITALY	Mag.	4	€ 7,50	



ATTREZZI DA GIARDINO HOBBY ACCIO VERNICIATI IMPUGNATURA ANTISCIVOLO

Art.	Misura	Tipo	Dispo.	Q.tà	Prezzo
2055/18	Lunghezza cm. 32		IMPORT	Mag. 10	€ 4,90
2055/16	Lunghezza cm. 35		IMPORT	Mag. 10	€ 4,90
2055/17	Lunghezza cm. 32		IMPORT	Mag. 10	€ 5,90

FORBICI IN ALLUMINIO CON IMPUGNATURA PVC/GOMMATA

Art.	Misura	Tipo	Dispo.	Q.tà	Prezzo
2055/1	Lunghezza cm. 22 (POTATURA SOFT)		IMPORT	Mag. 10	€ 10,90
2055/2	Lunghezza cm. 20 (POTATURA HARD)		IMPORT	Mag. 10	€ 10,90
2055/3	Lunghezza cm. 19 (COGLIFRUTTA)		IMPORT	Mag. 10	€ 7,90



SEGACCI HOBBY

Art.	Misura	Tipo	Dispo.	Q.tà	Prezzo
2055/7	Lunghezza cm. 23/41 (PIEGHEVOLE)		IMPORT	Mag. 10	€ 11,90
2055/8	Lunghezza cm. 44 (CON FODERO)		IMPORT	Mag. 10	€ 15,90
2055/15	Lunghezza cm. 53 (ARCHETTO)		IMPORT	Mag. 10	€ 12,90

TRONCARAMI IN METALLO HOBBY

Art.	Misura	Tipo	Dispo.	Q.tà	Prezzo
2055/4	Lunghezza cm. 70 (FISSO)		IMPORT	Mag. 10	€ 19,90
2055/5	Lunghezza cm. 62/80 (TELESCOPICO)		IMPORT	Mag. 10	€ 26,90
2055/6	Lunghezza cm. 62/92 (TELESCOPICO)		IMPORT	Mag. 10	€ 28,90



ACCETTE

Art.	Misura	Tipo	Dispo.	Q.tà	Prezzo
2066	Accetta c/ Manico Fibra Vetro		Mag. 4		€ 66,50
2065	Accetta c/ Manico Fibra Vetro		Mag. 4		€ 57,50
2067	Picozzino c/ Manico Fibra Vetro		Mag. 4		€ 27,50

ACCETTE

Art.	Misura	Tipo	Dispo.	Q.tà	Prezzo
1514	Picozzino c/ Manico Legno		Mag. 4		€ 19,50
1515	Accetta Classica c/ Manico Legno		Mag. 4		€ 42,50

SEGACCIO

Art.	Misura	Tipo	Dispo.	Q.tà	Prezzo
160024	Segaccio Serramanico		Mag. 4		€ 25,50
160016	Segaccio c/ Lama 30		Mag. 4		€ 24,50



RASTRELO DOPPIA FINZIONE A 12 DENTI

Art.	Misura	Tipo	Dispo.	Q.tà	Prezzo
410008		NYLON E FIBRA DI VETRO - MANICO ALLUMINIO	Mag.	6	€ 33,50



RASTRELO DOPPIA FINZIONE A 16 DENTI

Art.	Misura	Tipo	Dispo.	Q.tà	Prezzo
410010		NYLON E FIBRA DI VETRO - MANICO ALLUMINIO	Mag.	6	€ 38,50



BADILETTO PIEGHEVOLE DA CAMPO

Art.	Misura	Tipo	Dispo.	Q.tà	Prezzo
200011		ACCIAIO - PIEGHEVOLE - CON FODERO	Mag.	6	€ 49,90



SET 3 ATTREZZI GIARDINO

Art.	Misura	Tipo	Dispo.	Q.tà	Prezzo
600020		CON IMPUGNATURA MORBIDA ANTISCIVOLO	Mag.	6	€ 16,50



MULTOOL SPECIAL DA GIARDINO

Art.	Misura	Tipo	Dispo.	Q.tà	Prezzo
650023		10 FUNZIONI CON FODERO	Mag.	6	€ 33,50



ACCETTA POTAURE E CAMPEGGIO

Art.	Misura	Tipo	Dispo.	Q.tà	Prezzo
550017		LAMA INOX 420 - TRATTATO PVD	Mag.	6	€ 44,50



MACETE PREMIUM PROFESSIONALE

Art.	Misura	Tipo	Dispo.	Q.tà	Prezzo
550052		LAMA INOX 420 TRATTATO PVD	Mag.	6	€ 44,50



TRONCARAMI

Art.	Misura	Tipo	Dispo.	Q.tà	Prezzo
130113		TAGLIO 35	Mag.	6	€ 54,50



FORBICE DA POTA PROFESSIONALE TITANIUM

Art.	Misura	Tipo	Dispo.	Q.tà	Prezzo
100090			Mag.	6	€ 20,50



FORBICI HOBBY IN BOX DA 10 e/o 20 PEZZI

Art.	Misura	Tipo	Dispo.	Q.tà	Prezzo
1939 Box	Raccolta Cm 18,50	Gr 90	Mag.	10	€ 11,90



FORBICI HOBBY IN BOX DA 10 e/o 20 PEZZI

Art.	Misura	Tipo	Dispo.	Q.tà	Prezzo
1826	Forbice Pota		Mag.	10	€ 11,90



KIT HOBBY GIARDINAGGIO DONNA

Art.	Misura	Tipo	Dispo.	Q.tà	Prezzo
3079	Forbice Floreale		Mag.	Box a 12	€ 18,90

"...il migliore fra gli uomini è colui che arrossisce quando lo lodi e rimane in silenzio quando lo diffami..."



Art. 690203 **BOX COMPLETO** € **104,90**



ARTICOLI HOBBY DA TAGLIO MULTI USO

Art.	Misura	Tipo	Dispo.	Q.tà	Prezzo
1787	Trincetto Cm 18	2Lame Blister	Mag.	12	€ 3,90
190000	Forbice MultiUso Piccola		Mag.	6	€ 4,90
190001	Forbice MultiUso Media		Mag.	6	€ 6,90
190002	Forbice MultiUso Grande		Mag.	6	€ 8,90



FORBICI DA GIARDINAGGIO HOBBY

Art.	Misura	Tipo	Dispo.	Q.tà	Prezzo
art. 139	Forbice Cricchetto	Blister	Mag.	6	€ 15,90
art. 282	Forbice Pota	Blister	Mag.	6	€ 12,90
art. 892	Forbice Giardino	Blister	Mag.	6	€ 12,90
art. 891	Forbice Raccolta	Blister	Mag.	6	€ 12,90



FORBICI DA GIARDINAGGIO HOBBY

Art.	Misura	Tipo	Dispo.	Q.tà	Prezzo
154	Segaccio Cm 18	Pieghevo.	Blister	Mag.	4 € 21,90
158	Erba Cm 135	Gr 350	Blister	Mag.	6 € 14,90
art. 189	Fodero	Busta	Mag.	6	€ 19,90



MAZZE E MAZZUOLI

Art.	Misura	Tipo	Dispo.	Q.tà	Prezzo
1744		MAZZA	Mag.	4	€ 51,90
2062		MAZZUOLO	Mag.	4	€ 15,90
2064		MARTELLLO	Mag.	4	€ 15,90



FODERO PENNATO

1540



1545

1541

1542



1542

“...la nostra gloria più grande non sta’ nel non cadere mai ma nel risollevarsi sempre...”

ATTREZZI PROFESSIONALI BOSCO E GIARDINO

Art.	Misura	Tipo	Dispo.	Q.tà	Prezzo
1535		Pennato con Fodero	Mag.	4	€ 51,90
1540		Roncola lama cm. 30	Mag.	4	€ 41,90
1541		Roncola con canna Tipo Scansano	Mag.	4	€ 41,90
1545		Falce Toscana DESTRA	Mag.	4	€ 36,90
1542		gancio	Mag.	6	€ 8,90



taglio Ø 23mm

taglio Ø 16mm

a Incudine

By-Pass

Battente

Battente due tagli

da Pota

da Pota

2219



2009



FODERA

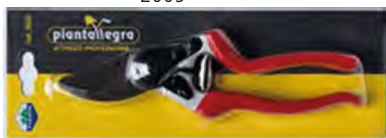

ATTREZZI PROFESSIONALI BOSCO E GIARDINO

Art.	Misura	tipo	Dispo.	Q.tà	Prezzo
art. 100054	Taglio Ø 16 mm.	Forbice a Incudine Professionale Doppia Apertura	Mag.	0	€ 22,90
art. 100053	Taglio Ø 23 mm.	Forbice by-pass Professionale Doppia Apertura	Mag.	0	€ 22,90
art. 100052	Taglio Ø 15 mm.	Forbice Professionale a Incudine	Mag.	0	€ 20,90
art. 100051	Taglio Ø 16 mm.	Forbice Professionale by-pass	Mag.	0	€ 20,90
art. 100026	Taglio Ø 15 mm.	Forbice da Pota Professionale a Incudine	Mag.	0	€ 33,90
art. 100030	Taglio Ø 16 mm.	Forbice 2 Tagli Professionale	Mag.	0	€ 36,90
art. 100022	Taglio Ø 25 mm.	Forbice da Pota	Mag.	0	€ 16,90
art. 100021	Taglio Ø 20 mm.	Forbice da Pota	Mag.	0	€ 14,90
2009	cm. 21,5	Forbice da Potatura Professionale Evo	Mag.	0	€ 21,90
2219	cm. 20	Forbice da Giardino Lux	Mag.	0	€ 19,90
160300/189	cm. 20	Fodero	Mag.	0	€ 19,90



1621

1743

1619

1550

FODERO MACETE

ATTREZZI PROFESSIONALI BOSCO E GIARDINO

Art.	Misura	Tipo	Dispo.	Q.tà	Prezzo
1621	cm. 18	Roncola	Mag.	6	€ 18,90
1619	cm. 6,5	Innesto	Mag.	6	€ 26,90
1743	cm. 6,5	Innesto Curvo	Mag.	6	€ 25,90
1550	cm. 35 lama	Macete Con Fodero	Mag.	2	€ 60,90

CAMPANA
DISERBO**POMPA A SPALLA A BATTERIA**

Art.	Tipo	Dispo.	Qtà	Prezzo
PS16A4	LT 16 . 2 Batterie 4.0-Ah	Mag.	1	€ 151,90 NS

POMPA A SPALLA

CODICE con batteria 4Ah	PS16A4	
CAPACITÀ SERBATOIO	16 LITRI	
PESO SENZA BATTERIA	KG 3,65	
DIMENSIONI	51X19X32 CM	51X22X32 CM
PRESSIONE DI ESERCIZIO MAX/MIN	5 BAR 1600 - 4 BAR 1200 ML/MIN	
DISTANZA MASSIMA DI SPRUZZO	7,5 MT	
LUNGHEZZA LANCIA PLASTICA	58 CM	
LUNGHEZZA LANCIA TElesc. IN ACCIAIO	60-100 CM	
LUNGHEZZA TUBO	1,2 MT	
POMPA	A MEMBRANA	
GUARNIZIONE	FPM adatta per prodotti aggressivi	
REGOLAZIONE PRESSIONE	INTERRUTTORE	
IMBALLO	SCATOLA CARTONE	

BATTERIE 21 V

	BATTERIA 4. 0Ah
AUTONOMIA 4 BAR	4 ORE
AUTONOMIA 5 BAR	200 MIN.
TEMPO DI RICARICA	4 ORE
LITRI EROGABILI PER OGNI CARICA	300 LT
PESO	600 GR

ACCESSORI PER POMPA A SPALLA

CODICE	
811	CAMPANA DISERBO

SOFFIATORE

CODICE	SF01
BATTERIA INCLUSA	Pz 1 - 4.0Ah
PESO CON BATTERIA	2,260 KG
MOTORE	BRUSHLESS
POTENZA NOMINALE	460W
POTENZA MASSIMA	600W
VELOCITÀ A VUOTO	5000-16500/MIN
VELOCITÀ A VUOTO (TURBO)	21500/MIN
ARIA VELOCITÀ	36-126 KM/H
ARIA VELOCITÀ CON IL TURBO	162 KM/H
FLUSSO D'ARIA	114-390 M³/H
FLUSSO D'ARIA CON TURBO	504 M³/H
VELOCITÀ	REGOLABILE
IMBALLO	SCATOLA CARTONE

BATTERIE 21 V

	BATTERIA 2. 0Ah	BATTERIA 4. 0Ah
AUTONOMIA	12 MIN.	25 MIN.
TEMPO DI RICARICA	2 ORE	4 ORE
PESO	360 GR	600 GR

I PREZZI RIPORTATI SONO ESCLUSI DI IVA

**SOFFIATORE A BATTERIA**

Art.	Tipo	Dispo.	Qtà	Prezzo
SF01	Batteria 4.0-Ah	Mag.	1	€ 151,90 NS

FORBICE

DIAMETRO DI TAGLIO	Ø 25 MM
PESO CON BATTERIA	900 GR
MOTORE	BRUSHLESS
CARICA BATTERIA	CON 2 JACK
POTENZA NOMINALE	150W
POTENZA MASSIMA	300W
APERTURA LAMA	50%
LAMA INTERCAMBIABILE	SÌ
TAGLIO	NO PROGRESSIVO
OLIATORE	ESTERNO
BATTERIA	ESTRAIBILE
IMBALLO	VALIGETTA IN PVC

**BATTERIA**

N° 2 BATTERIE IONI DI LITIO	16.8 V - 2.0Ah
AUTONOMIA MEDIA PER SINGOLA BATTERIA	3/4 ORE
TEMPO DI RICARICA COMPLETA PER SINGOLA BATTERIA	1,5 ORE

FORBICE A BATTERIA TAGLIO MAX 25mm

Art.	Tipo	Dispo.	Q.tà	Prezzo
FE04-25	Taglio progressivo. 2 Batterie 2.0-Ah	Mag.	1	€ 135,90 NS

FORBICE

CODICE	FE08-32
ACCESSORI COMPATIBILI	ASTE AT1521 - AT1521X
BATTERIA INCLUSA	Pz 2 - 2.0Ah
DIAMETRO DI TAGLIO	Ø 32 MM
PESO CON BATTERIA	1,000 KG
MOTORE	BRUSHLESS
POTENZA NOMINALE	380 W
POTENZA MASSIMA	840W
APERTURA LAMA	50%
TAGLIO	PROGRESSIVO
IMBALLO	VALIGETTA IN PVC

**BATTERIE 16.8 V**

	BATTERIA 2. 0Ah	BATTERIA 4. 0Ah
AUTONOMIA	2/3 ORE	4/5 ORE
TEMPO DI RICARICA	2/2,5 ORE	4/5 ORE
PESO	260 GR.	350 GR.

FORBICE A BATTERIA TAGLIO MAX 32mm

Art.	Tipo	Dispo.	Q.tà	Prezzo
FE08-32	Taglio progressivo. 2 Batterie 4.0-Ah	Mag.	1	€ 275,90 NS

FORBICE POTATURA

CODICE	FE07-40A
ACCESSORIO COMPATIBILE	ASTA AT1925
BATTERIA INCLUSA	Pz 2 - 2.0Ah
DIAMETRO DI TAGLIO	Ø 40 MM
PESO CON BATTERIA	1,360 KG
MOTORE	BRUSHLESS
POTENZA NOMINALE	450W
POTENZA MASSIMA	600W
APERTURA LAMA	50%
TAGLIO	PROGRESSIVO
IMBALLO	VALIGETTA IN PVC

**BATTERIE 21 V**

	BATTERIA 2. 0Ah	BATTERIA 4. 0Ah
AUTONOMIA	2/3 ORE	3/4 ORE
TEMPO DI RICARICA	2 ORE	4 ORE
PESO	360 GR	600 GR

FORBICE A BATTERIA TAGLIO MAX 40mm

Art.	Tipo	Dispo.	Q.tà	Prezzo
FE07-40	Taglio progressivo. 2 Batterie 4.0-Ah	Mag.	1	€ 315,90 NS



POTATORE A CATENA TAGLIO MAX 120mm

Art.	Tipo	Dispo.	Q.tà	Prezzo
PE02	Catena. 2 Batterie 2.0-Ah / 4.0-Ah	Mag.	1	€ 265,90 NS

POTATORE

CODICE	PE02
ACCESSORI COMPATIBILI	ASTE AT1521 - AT1521X
BATTERIA INCLUSA	Pz 1 - 2.0Ah Pz 1 - 4.0Ah
DIAMETRO DI TAGLIO	Ø 120 MM
PESO CON BATTERIA 2A h	1,200 KG
PESO CON BATTERIA 4A h	1,290 KG
MOTORE	BRUSHLESS
POTENZA NOMINALE	350W
POTENZA MASSIMA	425W
MISURE CATENA	1/4" - 32 MAGLIE
VELOCITÀ CATENA	0 -11 m/s
LUNGHEZZA BARRA	12,5 CM
REGOLAZIONE TENSIONE CATENA	MANUALE A VITE
LUBRIFICAZIONE CATENA	MANUALE
IMBALLO	VALIGETTA IN PVC

BATTERIE 16.8 V

	BATTERIA 2. 0Ah	BATTERIA 4. 0Ah
AUTONOMIA	24 MIN.	52 MIN.
TEMPO DI RICARICA	2/2,5 ORE	4/5 ORE
PESO	260 GR	350 GR



POTATORE A CATENA TAGLIO MAX 160mm

Art.	Tipo	Dispo.	Q.tà	Prezzo
PE01	Catena. 2 Batterie 4.0-Ah	Mag.	1	€ 351,90 NS

POTATORE

CODICE	PE01X
ACCESSORIO COMPATIBILE	ASTA AT1925
BATTERIA INCLUSA	Pz 2 - 4.0Ah
DIAMETRO DI TAGLIO	Ø 160 MM
PESO CON BATTERIA	2,100 KG
MOTORE	BRUSHLESS
POTENZA NOMINALE	350W
POTENZA MASSIMA	800W
MISURE CATENA	1/4" - 47 MAGLIE
VELOCITÀ CATENA	0-18 m/s
LUNGHEZZA BARRA	20 CM
REGOLAZIONE TENSIONE CATENA	MANUALE A VITE
LUBRIFICAZIONE CATENA	AUTOMATICA
DISPLAY LCD	Visualizzazione carica batteria e ore di lavoro
IMBALLO	VALIGETTA IN PVC

BATTERIE 21 V

	BATTERIA 2. 0Ah	BATTERIA 4. 0Ah
AUTONOMIA	1 ORA	2 ORE
TEMPO DI RICARICA	2 ORE	4 ORE
PESO	360 GR	600 GR

ASTA TELESCOPICA

CODICE	AT1925
ATTREZZI COMPATIBILI	PE01X - FE07-40A
TESTA	ORIENTABILE
MATERIALE	ALLUMINIO
SEZIONI TUBO	N.3
LUNGHEZZA TOTALE	1.95 - 2.53 MT
PESO	1,485 KG
IMBALLO	SCATOLA CARTONE

ASTA TELESCOPICA

Art.	Tipo	Dispo.	Q.tà	Prezzo
AT1925	cm. 195/253 - Testa Orientabile	Mag.	1	€ 103,90 NS



FODERI IN PELLE

Art.	Tipo	Dispo.	Q.tà	Prezzo
FE01F	Per Forbici	Mag.	1	€ 27,90 NS
PE02F	Per Potatore	Mag.	1	€ 22,90 NS

PS16



PE01X



SF01



FE07-40A



AT1925



PROMO

2026

€ 989,90 NS

FINO ESAURIMENTO SCORTA

6 BATTERIE 4.=Ah Fino ad un massimo di 24 ore consecutive di lavoro



SERRA 8 RIPIANI CON TELO PVC

Art.	Misura	Tipo	Dispo.	Q.tà	Prezzo
*647/5	cm. 143x73x195h		Mag.	1	€ 91,90



SERRA HOBBY STRUTTURA PESANTE VIOLETTA BUCANEVE

Art.	Misura	Tipo	Dispo.	Q.tà	Prezzo
*2570	200 x 200 x 220 Cm Violetta		8 GG	1	€ 515,90
*2571	Telo Ricambio Violetta		8 GG	1	€ 189,90

"...quando arriva la sconfitta accettata come un segnale che i tuoi progetti non erano validi ricostruisci quei progetti e issa di nuovo le tue vele verso il tuo desiderio..."



SERRA 4 PIANI PIEGHEVOLE E 3 PIANI A MURO

Art.	Misura	Tipo	Dispo.	Q.tà	Prezzo
*647/62	4 Piani Pieghevole		Mag.	1	€ 75,90
*647/59	3 Piani Rettangolare		Mag.	1	€ 71,90
*647/15	cm. 70x110h PopUp		Mag.	1	€ 33,90



SERRA HOBBY AZALEA 2-3-4 RIPIANI

Art.	Misura	Tipo	Dispo.	Q.tà	Prezzo
*2490/647	2 Ripiani 70 x 50 x 92 Cm		Mag.	1	€ 34,90
*2491	Telo Ricambio Azalea 2 Ripiani		Mag.	1	€ 11,90
*2492/647-1	3 Ripiani 70 x 50 x 125 Cm		Mag.	1	€ 40,90
*2493	Telo Ricambio Azalea 3 Ripiani		Mag.	1	€ 12,90
*2494/647-2	4 Ripiani 70 x 50 x 158 Cm		Mag.	1	€ 49,90
*2516	140x73x200 Cm		Mag.	1	€ 131,90
*2517	telo di Ricambio Ibiscus		Mag.	1	€ 49,90





CARRIOLA MULTIUSO KART PVC PESANTE

Art.	Misura	Dispo.	Q.tà	Prezzo
70201	Kart Mokka lt. 76	Mag.	1	€ 69,90
70202	Kart Muschio lt. 76	Mag.	1	€ 69,90
70204	Kart Antracite lt. 76	Mag.	1	€ 69,90



CARRIOLA MULTIUSO PRATYCA PVC PESANTE

Art.	Misura	Dispo.	Q.tà	Prezzo
2915	Carriola Tonda Multi Uso	Mag.	1	€ 69,90



2937

SPANDY PROFESSIONAL MULTIFUNZIONE MAXI

Art.	Misura	Dispo.	Q.tà	Prezzo
2937	SpandiConcime, Seme, Sale e Sabbia	8 GG	1	€ 266,90



2902

SPANDY PROFESSIONAL MULTIFUNZIONE MEDIUM

Art.	Misura	Dispo.	Q.tà	Prezzo
2902	SpandiConcime, Seme, Sale e Sabbia	Mag.	1	€ 136,90



2904

HOBBY MULTIFUNZIONE MINI

Art.	Misura	Dispo.	Q.tà	Prezzo
2904	SpandiConcime, Seme, Sale e Sabbia	Mag.	1	€ 76,90



2977

RULLO COMPATTATORE PROFESSIONALE

Art.	Misura	Dispo.	Q.tà	Prezzo
2977	A vuoto Kg. 10 - Con riempimento di Sabbia Kg. 70	Mag.	1	€ 159,90



81/4



81/2



*"... il successo ...
fare quello che amo
e divertirmi ..."*

CARRIOLA IN ACCIAIO ZINCATO TUBOLARE VERDE mm33

Art.	Misura	Dispo.	Q.tà	Prezzo
81/4	Carriola Lt 100 - Portata Max Kg. 100	Mag.	1	€ 118,90
81/12	Ruota pneumatica Ricambio	Mag.	1	€ 42,90

CARRIOLA IN ACCIAIO ZINCATO TUBOLARE mm28

Art.	Misura	Dispo.	Q.tà	Prezzo
81/2	Carriola Lt 75 - Portata Max Kg. 100	Mag.	1	€ 56,90
81/13	Ruota pneumatica Ricambio	Mag.	1	€ 19,90

81/1



CARRIOLA IN PVC TUBOLARE NERO mm33

Art.	Misura	Dispo.	Q.tà	Prezzo
81/1	Carriola Lt 100 - Portata Max Kg. 100	Mag.	1	€ 115,90
81/16	Ruota pneumatica Ricambio	Mag.	1	€ 42,90

CARRIOLA IN PVC TUBOLARE VERDE mm28

Art.	Misura	Dispo.	Q.tà	Prezzo
2961	Carriola Lt 90 - Portata Max Kg. 100	Mag.	1	€ 203,90
1739	Coppia Ruote Ricambio	Mag.	1	€ 69,90



CARRELLO CON SPONDE APRIBILI - RUOTE STERZANTI

Art.	Misura	Dispo.	Q.tà	Prezzo
80/5	Portata Max Kg. 150	Mag.	1	€ 179,90
81/19	Ruota pneumatica Ricambio	Mag.	1	€ 19,90

CARRELLO RIBALTABILE PVC PESANTE

Art.	Misura	Dispo.	Q.tà	Prezzo
80/4	Portata Max Kg. 250	Mag.	1	€ 179,90
81/18	Ruota pneumatica Ricambio	Mag.	1	€ 14,90

I PREZZI RIPORTATI SONO ESCLUSI DI IVA



POMPE A PRESSIONE IMPORT

Art.	Misura	Tipo	Dispo.	Q.tà	Prezzo
909	Spruzzatore Lt. 0,75		Mag.	1	€ 2,90
909/1	Mini Pompa Lenny Lt 2		Mag.	1	€ 6,90



POMPE A PRESSIONE IMPORT

Art.	Misura	Tipo	Dispo.	Q.tà	Prezzo
909/3	Pompa Pressione Jimmy Lt 12		Mag.	1	€ 45,90



POMPE A PRESSIONE IMPORT

Art.	Misura	Tipo	Dispo.	Q.tà	Prezzo
909/2	Pompa Pressione Lenny Lt 5		Mag.	1	€ 21,90



POMPE A PRESSIONE IMPORT

Art.	Misura	Tipo	Dispo.	Q.tà	Prezzo
909/4	Pompa Pressione Tommy Lt 16		Mag.	1	€ 52,90



POMPE A PRESSIONE IMPORT

Art.	Misura	Tipo	Dispo.	Q.tà	Prezzo
909/7	Pompa Pressione Jenny Lt 8		Mag.	1	€ 27,90



**Capacità 16 LT
Batteria a
Lithio**

POMPA A PRESSIONE DENNY 16 A BATTERIA - IMPORT

Art.	Misura	Tipo	Disp.	Q.tà	Prezzo
909/6	16 LT Lancia Alluminio	Batteria	Mag.	1	€ 129,90



“...l'unico modo per andare avanti è andare avanti dire: lo posso fare anche quando sai che non puoi...”



SPRUZZATORI LINEA HOBBY EUROPA

Art.	Misura	Tipo	Dispo.	Q.tà	Prezzo
*1661	Spruzza. MI 500		Mag.	24	€ 2,50
*1662	Spruzza. Lt 1		Mag.	18	€ 3,50

POMPA A PRESSIONE LINEA HOBBY EUROPA

Art.	Misura	Tipo	Dispo.	Q.tà	Prezzo
*1663	Pompa Pressione Lt 2		Mag.	12	€ 9,40



POMPA PRESSIONE LINEA HOBBY EUROPA

Art.	Misura	Tipo	Dispo.	Q.tà	Prezzo
*1769	Pompa Pressione Lt 8		Mag.	4	€ 35,90

POMPA PRESSIONE LINEA HOBBY EUROPA

Art.	Misura	Tipo	Dispo.	Q.tà	Prezzo
*1665	Pompa Pressione Lt 12		Mag.	4	€ 52,90



INNAFFIATOIO PLASTICA MADE IN ITALY

Art.	Misura	Tipo	Dispo.	Q.tà	Prezzo
15	Innaffiatoio Lt 6		Mag.	12	€ 6,90
16	Innaffiatoio Lt 9		Mag.	10	€ 8,90
17	Innaffiatoio Lt 12		Mag.	10	€ 9,90

POMPA PRESSIONE LINEA HOBBY EUROPA

Art.	Misura	Tipo	Dispo.	Q.tà	Prezzo
*1770	Pompa Pressione Lt 18		Mag.	2	€ 69,90



SPRUZZATORE EXTRA TRASPARENTE CON DOSATORE

Art.	Misura	Dispo.	Q.tà	Prezzo
12856	Spruzzatore Lt. 1,35	Mag.	1	€ 4,90



INNAFFIA/SPRUZZA CANDY 2 MADE IN ITALY

Art.	Misura	Dispo.	Q.tà	Prezzo
24460	Lt.2 ARANCIO	Mag.	52	€ 8,90
24329	Lt.2 LIME	Mag.	52	€ 8,90



INNAFFIATOIO NAU 4 MADE IN ITA

Art.	Misura	Dispo.	Q.tà	Prezzo
11477	Lt.4 VERDE OLIVA	Mag.	36	€ 7,20
11480	Lt.4 ROSSO LAVA	Mag.	36	€ 7,20



INNAFFIATOIO ALBATROS 12 MADE IN ITALY

Art.	Misura	Dispo.	Q.tà	Prezzo
10970	Lt.12 VERDE OLIVA	Mag.	8	€ 13,90
10980	Lt.12 ROSSO LAVA	Mag.	8	€ 13,90

INNAFFIATOIO ALBATROS 9 MADE IN ITALY

Art.	Misura	Dispo.	Q.tà	Prezzo
10948	Lt.9 VERDE OLIVA	Mag.	10	€ 10,90
10953	Lt.9 ROSSO LAVA	Mag.	10	€ 10,90

INNAFFIATOIO ALBATROS 6 MADE IN ITALY

Art.	Misura	Dispo.	Q.tà	Prezzo
10877	Lt.6 VERDE OLIVA	Mag.	12	€ 7,90
10900	Lt.6 ROSSO LAVA	Mag.	12	€ 7,90



NEBULIZZATORE JOLIE CLEAR 09

Art.	Misura	Dispo.	Q.tà	Prezzo
13218	MI. 572 ARANCIO	Mag.	52	€ 2,60
13218	MI. 572 LIME	Mag.	52	€ 2,60



NEBULIZZATORE JOLIE CLEAR 09

Art.	Misura	Dispo.	Q.tà	Prezzo
13324	MI. 1018 ARANCIO	Mag.	52	€ 2,90
13324	MI. 1018 LIME	Mag.	52	€ 2,90



INNAFFIATOIO NAU 2 MADE IN ITALY

Art.	Misura	Dispo.	Q.tà	Prezzo
11455	Lt.2 VERDE OLIVA	Mag.	52	€ 5,20
11459	Lt.2 ROSSO LAVA	Mag.	52	€ 5,20



OCEANIA 100

Art.	Misura	Tipo	Dispo.	Q.tà	Prezzo
14421	Spruzzino nebulizzatore Lt. 1		Mag.	6	€ 3,80



OCEANIA 1

Art.	Misura	Tipo	Dispo.	Q.tà	Prezzo
19044	Pompa pressione Lt. 1,3		Mag.	6	€ 12,80



OCEANIA 2

Art.	Misura	Tipo	Dispo.	Q.tà	Prezzo
20054	Pompa pressione Lt. 2		Mag.	6	€ 13,80



POMPE A PRESSIONE 5

Art.	Misura	Tipo	Dispo.	Q.tà	Prezzo
20831	Pompa pressione Lt. 5		Mag.	4	€ 47,80



POMPE A PRESSIONE 7

Art.	Misura	Tipo	Dispo.	Q.tà	Prezzo
20922	Pompa pressione Lt. 7		Mag.	4	€ 52,80



POMPE A PRESSIONE 10

Art.	Misura	Tipo	Dispo.	Q.tà	Prezzo
21033	Pompa pressione Lt. 10		Mag.	2	€ 59,80



POMPE A PRESSIONE 16

Art.	Misura	Tipo	Dispo.	Q.tà	Prezzo
21804	Pompa pressione Lt. 16		Mag.	1	€ 86,80



POMPE A PRESSIONE 20

Art.	Misura	Tipo	Dispo.	Q.tà	Prezzo
21785	Pompa pressione Lt. 20		Mag.	1	€ 90,80

I PREZZI RIPORTATI SONO ESCLUSI DI IVA



Livello batteria luminoso



Lancia allungabile



Bretelle regolabili

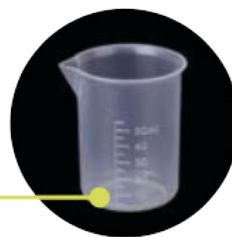

Dosatore



Tappo di scarico



Ugello in acciaio regolabile



8 Lt.

Pompa a Batteria E-Habitat 8L

Art.	Misura	Dispo.	Q.tà	Prezzo
25041	cm. 35x20x49 Kg. 3,6	Mag.	1	€ 221,00



12 Lt.

Pompa a Batteria E-Habitat 12L

Art.	Misura	Dispo.	Q.tà	Prezzo
25042	cm. 37x23x52 Kg. 4,3	Mag.	1	€ 241,00



A



B



C



D

Accessori Pompe E-Habitat

Art.	Misura	Dispo.	Q.tà	Prezzo
A - 25090	Impugnatura per lancia in acciaio	8 gg.	1	€ 16,50
B - 25091	Lancia curva allungabile in acciaio	8 gg.	1	€ 17,50
C - 25092	Batteria 12V	8 gg.	1	€ 70,50
D - 25093	Caricatore per batteria	8 gg.	1	€ 44,50

“... amare non è guardarsi l'un l'altro ma guardare insieme nella stessa direzione ...”

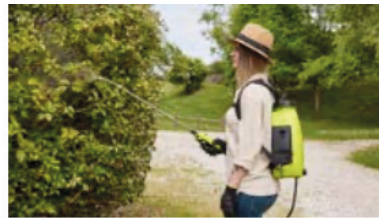
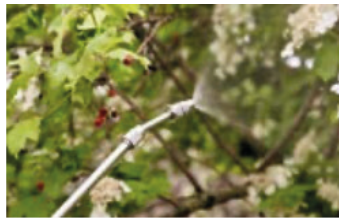

Lance Curve

Art.	Misura	Dispo.	Q.tà	Prezzo
A - 05388	Lancia curva in plastica NBR cm. 64	8 gg.	1	€ 21,50
B - 05391	Lancia curva in alluminio NBR cm. 64	8 gg.	1	€ 21,50
C - 05392	Lancia curva in alluminio con ugello in ottone NDR cm. 64	8 gg.	1	€ 31,50



Estensioni Curve

Art.	Misura	Dispo.	Q.tà	Prezzo
A - 05190	Estensione curva in plastica cm. 40,5	8 gg.	1	€ 6,50
B - 05105	Estensione curva in plastica con ugello ceramica cm. 45,5	8 gg.	1	€ 14,50
C - 05119	Estensione curva in alluminio/plastica cm. 45,5	8 gg.	1	€ 7,50
D - 05141	Estensione curva in alluminio con ugello in ottone cm. 45,5	8 gg.	1	€ 14,50



Lance Diritte

Art.	Misura	Dispo.	Q.tà	Prezzo
A - 05386	Lancia diritta in plastica NDR cm. 64	8 gg.	1	€ 20,50
B - 24513	Lancia telescopica diritta in alluminio con impugnatura cm. 64	8 gg.	1	€ 31,50
C - 05284	Lancia diritta in alluminio/plastica NBR cm. 64	8 gg.	1	€ 17,50
D - 05297	Lancia diritta in alluminio/plastica NBR ugello ottone cm. 64	8 gg.	1	€ 22,50



Estensioni Curve

Art.	Misura	Dispo.	Q.tà	Prezzo
A - 05089	Estensione diritta in plastica cm. 45,5	8 gg.	1	€ 6,50
B - 24512	Estensione telescopica diritta in alluminio	8 gg.	1	€ 14,50
C - 05226	Estensione diritta con ugello a cono vuoto	8 gg.	1	€ 14,50
D - 05227	Estensione diritta con ugello a ventaglio	8 gg.	1	€ 14,50
E - 05228	Estensione diritta con ugello a specchio	8 gg.	1	€ 14,50
F - 05224	Estensione diritta in plastica con lancetta regolabile	8 gg.	1	€ 7,50
G - 05269	Estensione diritta con ugelli speciali	8 gg.	1	€ 18,50
H - 05111	Estensione diritta in plastica/alluminio con ugello	8 gg.	1	€ 6,50
I - 05125	Estensione diritta in alluminio ugello ottone cm. 45,5	8 gg.	1	€ 7,50



Accessorio Pompe a pressione

Art.	Misura	Dispo.	Q.tà	Prezzo
A - 04027	Ugello in plastica	8 gg.	1	€ 0,90
B - 03568	Ugello formaschiuma per pompe con ugello in plastica	8 gg.	1	€ 1,20
C - 21820	Ugello in ottone	8 gg.	1	€ 5,50
D - 21842	Ugello in ottone a ventaglio angolo 110°	8 gg.	1	€ 4,50
E - 21850	Ugello in ottone a due vie	8 gg.	1	€ 25,50
F - 21860	Ugello in ottone a tre vie	8 gg.	1	€ 26,50



Accessorio Pompe a pressione

Art.	Misura	Dispo.	Q.tà	Prezzo
A - X115550	Agitatore per pompe	8 gg.	1	€ 6,50
B - 02570	Campana diserbo adatto a lance in ottone	8 gg.	1	€ 26,50
C - 03388	Cono diserbo per lance in plastica	8 gg.	1	€ 4,50
D - CZ1000	Cintura di sostegno per pompe a spalla	8 gg.	1	€ 5,50

I PREZZI RIPORTATI SONO ESCLUSI DI IVA



AQUABALCONY

Art.	Misura	Tipo	Dispo.	Q.tà	Prezzo
GF80265852	Tubo mt. 10 con portatubo, raccordi e pistola (ottanio)		Mag.	1	€ 49,90
GF80275852	Tubo mt. 10 con portatubo, raccordi e pistola (fuxia)		Mag.	1	€ 49,90
GF80285852	Tubo mt. 10 con portatubo, raccordi e pistola (verde acido)		Mag.	1	€ 49,90
GF80285852	Tubo mt. 10 con portatubo, raccordi e pistola (tortora)		Mag.	1	€ 49,90



AQUALIGHT

Art.	Misura	Tipo	Dispo.	Q.tà	Prezzo
GF80007151	Tubo ultraleggero mt. 15 5/8 con raccordi e pistola (grigio)		Mag.	1	€ 55,90
GF80007153	Tubo ultraleggero mt. 15 3/4 con raccordi e pistola (grigio)		Mag.	1	€ 83,90
GF80007152	Tubo ultraleggero mt. 30 5/8 con raccordi e pistola (grigio)		Mag.	1	€ 83,90
GF80007154	Tubo ultraleggero mt. 30 3/4 con raccordi e pistola (grigio)		Mag.	1	€ 149,90



TUBO ESTENSIBILE AQUAPOP GRAY EASY

Art.	Misura	Tipo	Dispo.	Q.tà	Prezzo
GF80297672	Tubo max mt. 10 con raccordi e lancia (grigio)		Mag.	1	€ 43,90
GF80297673	Tubo max mt. 15 con raccordi e lancia (grigio)		Mag.	1	€ 53,90
GF80297674	Tubo max mt. 20 con raccordi e lancia (grigio)		Mag.	1	€ 63,90
GF80297675	Tubo max mt. 25 con raccordi e lancia (grigio)		Mag.	1	€ 73,90
GF80297676	Tubo max mt. 30 con raccordi e lancia (grigio)		Mag.	1	€ 79,90



TUBO ESTENSIBILE IN BAG AQUAPOP GRAY

Art.	Misura	Tipo	Dispo.	Q.tà	Prezzo
GF80297686	Tubo max mt. 25 con borsa, raccordi e lancia (grigio)		Mag.	1	€ 89,90



TUBO ESTENSIBILE IN BAG AQUAPOP

Art.	Misura	Tipo	Dispo.	Q.tà	Prezzo
GF80297600	Tubo max mt. 15 con borsa, raccordi e lancia (tortora)		Mag.	1	€ 73,90
GF80287600	Tubo max mt. 15 con borsa, raccordi e lancia (verde acido)		Mag.	1	€ 73,90

TUBO ESTENSIBILE IN BAG AQUAPOP

Art.	Misura	Tipo	Dispo.	Q.tà	Prezzo
GF80277600	Tubo max mt. 15 con borsa, raccordi e lancia (fuxia)		Mag.	1	€ 73,90
GF80267600	Tubo max mt. 15 con borsa, raccordi e lancia (ottanio)		Mag.	1	€ 73,90



*“... innamorati
prima di te
poi
della vita ...”*



DOCCIA SOLARE SUNNY

Art.	Misura	Tipo	Dispo.	Q.tà	Prezzo
GF80286908		Doccia Sunny Niagara (verde acido)	Mag.	1	€ 315,90
GF80266908		Doccia Sunny Niagara (ottanio)	Mag.	1	€ 315,90
GF80276908		Doccia Sunny Niagara (fuxia)	Mag.	1	€ 315,90
GF80296908		Doccia Sunny Niagara (grigio)	Mag.	1	€ 315,90



AQUAFLORA HOLIDAY - MIX COLOR

Art.	Misura	Tipo	Dispo.	Q.tà	Prezzo
GF80256343		Irrigatore piante per bottiglia pz. singolo (colori assortiti)	Mag.	1	€ 9,90
GF80256344		Irrigatore piante per bottiglia pz. tre (colori assortiti)	Mag.	1	€ 29,90



I PREZZI RIPORTATI SONO ESCLUSI DI IVA



TUBO IRRIGAZIONE RETINATI 6 STRATI - TRICOGREEN

Art.	Misura	Tipo	Dispo.	Q.tà	Prezzo
1879	Tubo Trico Green mt 15 1/2"		Mag.	1	€ 36,90
2296	Tubo Trico Green mt 25 1/2"		Mag.	1	€ 59,60
1880	Tubo Trico Green mt 15 5/8"		Mag.	1	€ 45,20
1441	Tubo Trico Green mt 25 5/8"		Mag.	1	€ 73,50
2296	Tubo Trico Green mt 50 5/8"		Mag.	1	€ 145,90
1440	Tubo Trico Green mt 25 3/4"		Mag.	1	€ 96,90

**Attenzione
utilizzo massimo
2-3 bar**



INNAFFIATOIO PER VASI A BECCO LUNGO TUBI DA IRRIGAZIONE RETINATI

Art.	Misura	Tipo	Dispo.	Q.tà	Prezzo
1105656	Tubo rosso mt 15 1/2"	con kit raccordi e lancia	Mag.	1	€ 33,90
1105685	Tubo rosso mt 20 5/8"	con kit raccordi e lancia	Mag.	1	€ 47,90
1105736	Tubi irrigazione estensibile mt 15 max cin	kit raccordi e pistola	Mag.	1	€ 34,90



040



869



033



047



061



870



035



873



039



067



065



038



068

RACCORDI PER IRRIGAZIONE

Art.	Misura	Tipo	Dispo.	Q.tà	Prezzo
065	Raccordo rubinetto		Mag.	1	€ 2,60
038	Raccordo rubinetto due vie		Mag.	1	€ 12,50
061	Raccordo rubinetto connettore		Mag.	1	€ 2,50
067	Raccordo rubinetto riparatore		Mag.	1	€ 2,50
039	Raccordo rubinetto duplice rapido		Mag.	1	€ 2,50
040	Raccordo rubinetto riparatore universale		Mag.	1	€ 3,90
869	Raccordo rubinetto connettore lux		Mag.	1	€ 4,90
870	Raccordo rubinetto connettore acquastop		Mag.	1	€ 5,90

SISTEMA D'IRRIGAZIONE

Art.	Misura	Tipo	Dispo.	Q.tà	Prezzo
033	Irrigatore 360°		Mag.	1	€ 12,90
047	Idro pistola PVC		Mag.	1	€ 11,90
035	Idro pistola PVC Multifunzione		Mag.	1	€ 14,90
873	Idro pistola PVC Multifunzione Lux		Mag.	1	€ 24,90
068	Lancia Irrigazione Multifunzione		Mag.	1	€ 20,90



MASTELLI PVC FLESSIBILI - BORSE PVC FLESSIBILI

Art.	Misura	Tipo	Disp.	Q.tà	Prezzo
049693	Dia. 66 x 50 H Cm	Mastello Lt 70	Mag.	4	€ 26,80
049686	Dia. 49 x 43 H Cm	Mastello Lt 50	Mag.	4	€ 13,60
E 230	Dia. 45 x 40 H Cm	Mastello Lt 40	Mag.	4	€ 19,00
E 220 Piccola	24 L x 17 H Cm	Borsa Giardino	Mag.	4	€ 6,90
E 220 Grande	44 L x 31 H Cm	Borsa Giardino	Mag.	4	€ 14,90



POP-UP BAG-SACCO MAX BAG-BORSA ECO BAG

Art.	Misura	Tipo	Disp.	Q.tà	Prezzo
903/2	Dia. 56 x 70 H Cm	Cilindro	Mag.	4	€ 18,50
6816	48L x 48P x 60H Cm	Maxi Sacco	Mag.	10	€ 20,50



SECCHI PER LIQUIDI IN ZINCO RINFORZATI

Art.	Misura	Tipo	Disp.	Q.tà	Prezzo
211/14	Dia. 23 H 19 Cm	Zinco Lt 5	Mag.	12	€ 7,90
211/0	Dia. 26 H 25 Cm	Zinco Lt 8	Mag.	10	€ 10,90
211/5	Dia. 30 H 29 Cm	Zinco Lt 10	Mag.	8	€ 12,90
211/9	Dia. 31 H 31 Cm	Zinco Lt 12	Mag.	6	€ 14,90



BIDONI ZINCO RINFORZATI CON COPERCHIO

Art.	Misura	Tipo	Disp.	Q.tà	Prezzo
211/15	Dia. 29 H 32	Zinco 18 Lt	8 gg	6	€ 18,90
211/18	Dia. 36 H 37	Zinco 35 Lt	Mag.	6	€ 29,90
211/7	Dia. 42 H 46	Zinco 62 Lt	Mag.	6	€ 41,90
211/16	Dia. 48 H 50	Zinco 80 Lt	8 gg	4	€ 54,90

"... trasforma le tue ferite in saggezza ..."



SECCHIO MULTIUSO IN PLASTICA COLORATO CON COPERCHIO

Art.	Misura	Tipo	Disp.	Q.tà	Prezzo
073735	Lt 50	Colorato	Mag.	1	€ 19,90
073728	Lt 28	Colorato	Mag.	1	€ 11,90



INNAFFIATOIO JUNIOR METALLO VERNICIATO

Art.	Tipo	Disp.	Q.tà	Prezzo
5959	VERDE 1 Lt (Totem 6)	Mag.	6	€ 17,50
5959	GIALLO 1 Lt (Totem 6)	Mag.	6	€ 17,50
5959	AZURRO 1 Lt (Totem 6)	Mag.	6	€ 17,50



TOTEM JUNIOR IL GIARDINO DEI BAMBINI

Art.	Misura	Tipo	Dispo.	Q.tà	Prezzo
1871	Totem completo 156 pezzi		Mag.	1	€ 999,00



ORTOBIMBO CRESCITA

Art.		Dispo.	Q.tà	Prezzo
3095	Comprende: 1 guanto - 1 paletta - 3 vasi torba - 3 bustine semi	Mag.	1	€ 19,90



GUANTO JUNIOR

Art.	Misura	Tipo	Dispo.	Q.tà	Prezzo
4912	Guanto tessuto mix pelle (Totem pz.12)		Mag.	12	€ 8,50
4936	Guanto tessuto (Totem pz.12)		Mag.	12	€ 5,9



MINI ATTREZZI JUNIOR

Art.	Misura	Tipo	Dispo.	Q.tà	Prezzo
3069	Forca manico corto (Totem pz.10)		Mag.	10	€ 4,60
3066	Paletta manico corto (Totem pz.10)		Mag.	10	€ 4,60
3068	Rastrello manico corto (Totem pz.10)		Mag.	10	€ 4,60
3067	Paletta quadra manico corto (Totem pz.10)		Mag.	10	€ 4,60
3071	Tris Mini attrezzi Junior (Totem pz.10)		Mag.	10	€ 16,60



MAXI ATTREZZI JUNIOR

Art.	Misura	Tipo	Dispo.	Q.tà	Prezzo
4054	Scopa saggina (Totem pz.10)		Mag.	10	€ 10,50
4055	Scopetta foglie (Totem pz.6)		Mag.	6	€ 11,50
4050	Badiletto (Totem pz.6)		Mag.	6	€ 11,50
4052	Rastrello (Totem pz.6)		Mag.	6	€ 11,50
4053	Zappetta (Totem pz.6)		Mag.	6	€ 11,50



Robot rasaerba Sileno

Prezzi e preventivi personalizzati



INTUITIVO



SEMPLICE



INTELLIGENTE



PRECISO



PERSONALIZZABILE



AUTONOMO

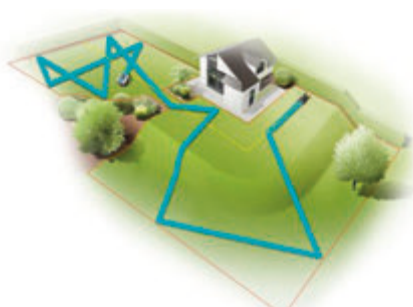

SENSORCUT SYSTEM

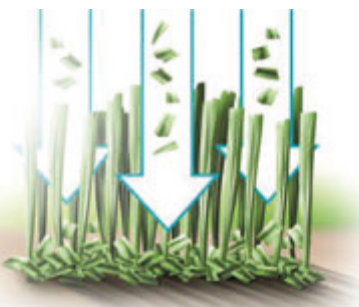

SOSTENIBILE



FLESSIBILE



art. 12222.20 | Cesoie a batteria AssiCut - Taglio 25 mm

€ 139,90



12241.20



12252.20



12215.20



8906.20



8798.20



8702.20



12230.20

12230.30 IN BOX EXPO



8857.20



8734.20

8733.20



12215.20



8705.20



8704.20

Gardena Forbici

art. 12241.20	Forbice Taglio	€ 29,90
art. 12251.20	Forbice Taglio	€ 29,90
art. 12252.20	Forbice Taglio	€ 37,90
art. 8906.20	Forbice Taglio	€ 49,90
art. 8798.20	Forbice Taglio	€ 71,90
art. 8702.20	Forbice Taglio	€ 71,90
art. 12230.20	Cesoia Taglio	€ 13,90
art. 12230.30	Cesoia Taglio IN BOX	€ 13,90
art. 8857.20	Cesoia Taglio	€ 21,90

Gardena Forbici

art. 8734.20	Forbice Erba	€ 36,00
art. 8733.20	Forbice Erba	€ 29,90

Gardena Forbici

art. 12215.20	Forbice Multiuso	€ 23,90
art. 8705.20	Forbice Multiuso	€ 17,90
art. 8704.20	Forbice Multiuso	€ 15,90



12304-20

391.20

Gardena Tagliasiepi

art. 394.20 (12304.20)	Tagliasiepi cm.23	€ 79,90
art. 391.20 (12300.20)	Tagliasiepi cm.23	€ 44,90



Gardena Troncarami

art. 12000.20	Troncarami Telescopico 160	€ 122,90
art. 12001.20	Troncarami Telescopico 230-410	€ 158,90

Gardena Troncarami

art. 12004.20	Troncarami	€ 49,90
art. 12008.20	Troncarami	€ 86,90
art. 8773.20	Troncarami Cricchetto	€ 122,90



Gardena Troncarami

art. 12020.20	Troncarami Telescopico 160	€ 41,90
art. 12021.20	Troncarami Telescopico 230-410	€ 41,90



297.20

160

12000.20

230-410

12001.20

3711.20

3721.20

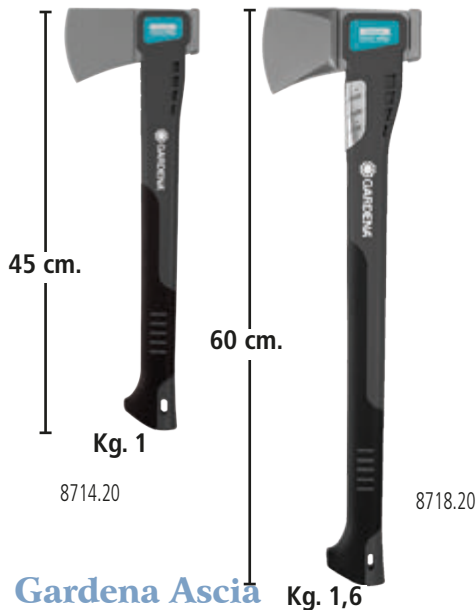

Gardena Ascia

Kg. 1,6

art. 8714.48	Ascia cm. 45	€ 78,90
art. 8718.48	Ascia cm.65	€ 96,90



Gardena Segaccio

art. 8738.20	Segaccio	€ 48,90
art. 8739.20	Segaccio	€ 55,90
art. 8742.20	Segaccio Pieghevole	€ 42,90
art. 8743.20	Segaccio Pieghevole	€ 49,90
art. 8745.20	Segaccio	€ 49,90

Gardena Svettatoi

art. 297.20	Svettatoio	€ 87,90
art. 3720.20	Manico 140 - 290	€ 69,90
art. 3721.20	Manico 210 - 390	€ 75,90

I PREZZI RIPORTATI SONO ESCLUSI DI IVA

Heart Beat Gardena

Un'unica batteria per diversi attrezzi



9334.20



14770.20

14732.20



14890.20

14732.20



14730.20



14701.20



5041.20



14632.20



9827.20

art. 9334.20	Aspiratore Soffiatore	€ 170,90
art. 5042.20	Rasaerba	€ 410,90

art. 14770.20	Potatore Telescopico	€ 291,90
art. 14732.20	Tagliasiepi Telescopico	€ 285,90
art. 14890.20	Soffiatore	€ 229,90
art. 14731.20	Tagliasiepi 60	€ 271,90
art. 14730.20	Tagliasiepi 50	€ 234,90
art. 14632.20	Rasaerba	€ 410,90
art. 14701.20	Trimmer	€ 236,90
art. 9827.20	Trimmer	€ 123,90



Combisystem Gardena

Un unico manico per diversi attrezzi

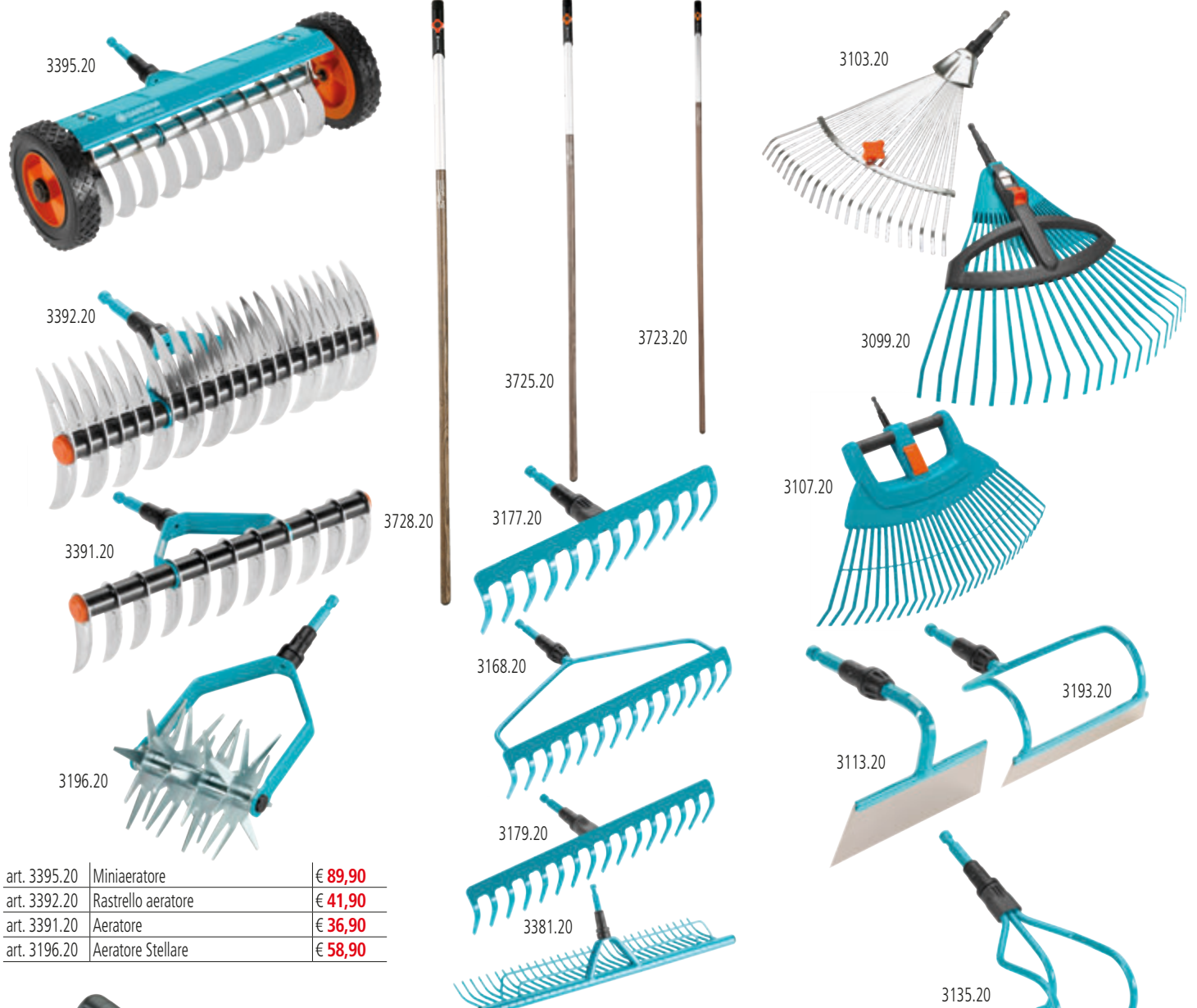

art. 3395.20	Miniaeratore	€ 89,90
art. 3392.20	Rastrello aeratore	€ 41,90
art. 3391.20	Aeratore	€ 36,90
art. 3196.20	Aeratore Stellare	€ 58,90

art. 8950.20	Paletta Trapiantatore Maxi	€ 7,90
--------------	----------------------------	--------

art. 3728.20	Manico Legno cm.180	€ 26,90
art. 3725.20	Manico Legno cm.150	€ 23,90
art. 3723.20	Manico Legno cm.130	€ 19,90
art. 3177.20	Rastrello	€ 20,90
art. 3168.20	Rastrello Arco	€ 45,90
art. 3179.20	Rastrello	€ 23,90
art. 3381.20	Rastrello erba	€ 33,90

art. 3103.20	Scopa per erba	€ 31,90
art. 3099.20	Scopa per erba	€ 28,90
art. 3107.20	Scopa per erba XXL	€ 39,90
art. 3193.20	Sarchiatore	€ 23,90
art. 3113.20	Zappa	€ 21,90
art. 3135.20	Coltivatore	€ 23,90

I PREZZI RIPORTATI SONO ESCLUSI DI IVA



1874.20



1890.20

art. 1874.20	Computer irrigazione Multicontrol Duo	€ 155,90
art. 1890.20	Computer irrigazione Flex	€ 65,90



18620.20
18625.20

art. 18620.20	Avvolgitubo a parete Roll-up 25HT	€ 263,90
art. 18625.20	Avvolgitubo a parete Roll-up 30HT	€ 295,90
art. 18600.20	Roll Up mt. 15	€ 182,90
art. 18604.20	Roll Up mt. 15	€ 211,99



18600.20



18604.20



18522.26



18543.26



18502.50

art. 18522.26	Set Acquarol L easy	€ 195,90
---------------	---------------------	-----------------

art. 18543.26	Set Acquarol Metal	€ 154,90
---------------	--------------------	-----------------

art. 18502.50	Set Acquarol S	€ 85,90
---------------	----------------	----------------



8007.20

art. 8007.20	Avvolgitubo 50	€ 61,90
--------------	----------------	----------------



art. 4648.26	Tubo spirale 15mt	€ 79,90
art. 18041.26	Tubo Comfort Flex	€ 35,90



4647.20



18541.20



18510.20



18500.20

art. 18541.20	Acquarol Metal	€ 122,90
---------------	----------------	-----------------

art. 18510.20	Acquarol M	€ 91,90
---------------	------------	----------------

art. 18500.20	Acquarol S	€ 68,90
---------------	------------	----------------



art. 18220.20	Presa Rubinetto 1/2	€ 3,90
art. 18221.20	Presa Rubinetto 3/4	€ 3,90
art. 18222.20	Presa Rubinetto	€ 4,90
art. 2931.20	Giunto	€ 4,90
art. 2917.20	Raccordo Filettato	€ 7,90
art. 18232.20	Raccordo Riparazione	€ 6,90
art. 18233.20	Raccordo Riparazione	€ 7,90

art. 18215.20	Raccordo Rapido	€ 6,90
art. 18216.20	Raccordo Rapido	€ 9,90
art. 18213.20	Racc. "acqua-stop"	€ 9,90
art. 18214.20	Racc. "acqua-stop"	€ 10,90



art. 938.20	Rubinetto 2 vi3	€ 16,90
art. 8193.20	Distributore 2 vie	€ 29,90
art. 8194.20	Distributore 4 vie	€ 48,90



art. 8136.20	Irrigatore impulso Premium	€ 59,90
art. 8141.20	Irrigatore impulso Comfort	€ 35,90
art. 8135.20	Irrigatore impulso a settori	€ 61,90
art. 2062.20	Irrigatore circolare Mambo	€ 35,90
art. 2073.20	Irrigatore girevole 6 testine	€ 25,90



art. 18300.20	Lancia classic	€ 10,90	art. 18317.20	Lancia doccia multi	€ 46,90
art. 18310.20	Lancia doccia	€ 15,90	art. 18304.20	Lancia Comfort	€ 29,90
art. 18313.20	Lancia doccia multi.	€ 28,90	art. 18301.20	Lancia Impulsi	€ 22,90



art. 18031.20	Tubo Irrigazione dia. 13 mm. - mt.15	€ 33,90
art. 18036.20	Tubo Irrigazione dia. 13 mm. - mt.30	€ 55,90
art. 18045.26	Tubo Irrigazione dia. 15 mm. - mt.25	€ 52,90
art. 18049.26	Tubo Irrigazione dia. 15 mm. - mt.50	€ 95,90
art. 18053.20	Tubo Irrigazione dia. 19 mm. - mt.25	€ 77,70
art. 18055.20	Tubo Irrigazione dia. 19 mm. - mt.50	€ 135,70



art. 18970.29	Tubo Irrigatore dia. 13mm - mt. 20	€ 35,90
---------------	------------------------------------	---------

Assortimento completo di Bulbi Autunnali

SEMI



Bulbi in blister, scatole e dispenser.
Assortimento e calibro
ai migliori prezzi di mercato

Assortimento completo di Bulbi Primaveraerili



Espositore fiori
28 ganci busta grande
Espositore Omaggio

Assortimento Cose Curiose Standard 13x20

BUSTA (12) € 3,90



SEMI



22L

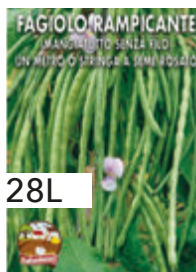

28L



24L



25L



35L



3L



6L



20L



1L



26L



27L



13L



44L



19L

Assortimento Fagioli

SCATOLA gr.200 (12)

€ 5,50



5P



13P



2P



12P



11P



7P



15P

Assortimento Piselli

SCATOLA gr.200 (12)

€ 5,50



6F



1F



3F



38L



39L



40L



41L

Assortimento Fave

SCATOLA gr.200 (12)

€ 5,50

Ceci € 5,50

Arachidi e Mais

SCATOLA gr.200 (12)

€ 7,50



10

10S ✓



8

8S ✓



142

142S ✓



143

143S ✓



165

165S ✓



162

162S ✓



163

163S ✓



176

176S ✓



120

120S ✓



160

160S ✓



20

20S ✓



21

21S ✓

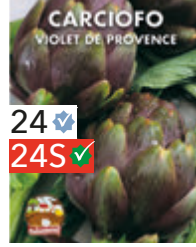

24

24S ✓



23

23S ✓

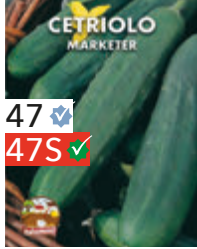

47

47S ✓



46

46S ✓

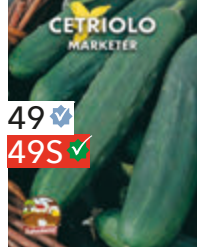

49

49S ✓

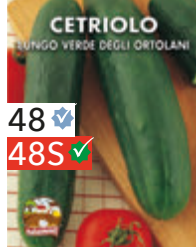

48

48S ✓



80

80S ✓

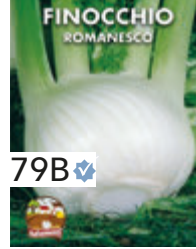

79B



82

82S ✓

Standard 11x16

BUSTA PICCOLA (12)

€ 1,40

Supermaxi 13x20

BUSTA GRANDE (12)

€ A RICHIESTA

POMODORO S. MARZANO 2 (RAMPICANTE) 130 130S	POMODORO SUPER ROMA VF 131 131S	POMODORO PRINCIPE BORGHESE 132 132S	POMODORO S. PIERRE 134 134S	POMODORO MARMANDE 135 135S	POMODORO ACE 55 VF 136 136S	POMODORO CUOR DI BUE 137 137S
POMODORO COSTOLUTO FIORENTINO 138 138S	POMODORO S. MARZANO NANO 139 139S	POMODORO S. MARZANO NANO 140 140S	POMODORO LA INDUSTRIA TIPO PIÙ GRANDI TOSCANA 141 141S	POMODORO D'ITALIA 113 113S	MELANZANA VIOLETTA DI FIRENZE 112 112S	MELANZANA VIOLETTA LUNGA 3 112 112S
CAVOLFIORE GIGANTE BELNEHOLDS FARBO 30 30S	CAVOLFIORE PALLA DI NEVE 31 31S	CAVOLO BROCCOLO RAMOSO CALABRESE 32 32S	CAVOLO DI BRUXELLES MEZZO NANO 33 33S	CAVOLO CAPPUCCIO COPENHAGEN MARKET 2 37 37S	CAVOLO VERZA DI PIACENZA INVERNALE 39 39S	CAVOLO VERZA D'ASTI PASQUALINO 40
CAVOLO VERZA RE D'INVERNO 2 41 41S	CAVOLO CAPPUCCIO ROEM VAN ENKHUIZEN 2 42	CAVOLO LACINIATO NERO DI TOSCANA 43 43S	BROCCOLETTO O CIMA DI RAPA QUARANTINE 15 15S	BROCCOLETTO O CIMA DI RAPA SESSANTINA 16 16S	BROCCOLETTO O CIMA DI RAPA NOVENTINA 17 17S	BROCCOLETTO O CIMA DI RAPA CINQUENTINA 18 18S
CICORIA A GRUMOLO VERDE 53 53S	CICORIA A GRUMOLO BIONDA INVERNALE 54 54S	CICORIA A GRUMOLO E ONDA (ESTIVA) 55 55S	CICORIA PANI DI ZUCCHERO 56 56S	CICORIA BIANCA DI MILANO 57 57S	CICORIA SPADONI O DA TEGOLIO A FOGLIE STRETTE 58 58S	CICORIA DI TAGLIO BIONDA A FOGLIE LARGHE 59 59S
CICORIA ROSSA DI VERONA A PALLE 60 60S	CICORIA SELVATICA DA CAMPO 61 61S	CICORIA SALADONE A FOGLIE PASTIGLIERE 62 62S	CICORIA ROSSA DI TREVISO 2 63 63S	CICORIA DI BRUXELLES 64	CICORIA VARIEGATA DI CHIOGGIA 65 65S	CICORIA BIONDISSIMA DI TRIESTE 68 68S
CICORIA SILVATICA FANTASIA GELSONA 69 69S	CICORIE MISCUGLIO O RADICCHI DA CAMPO 70 70S	RAVANELLO CHERRY BELLE 151 151S	RAVANELLO SAXA 2 154 154S	RAVANELLO FLAMBOYANT 3 155 155S	RAVANELLO ROSSO TONDO O TONDO A PUNTA FINCA 156 156S	RAVANELLO SCARLET GLOBE 157 157S
PEPERONE QUADRATO D'ASTI GIALLO 123 123S	PEPERONE QUADRATO D'ASTI ROSSO 124 124S	PEPERONE QUADRATO YOLO WONDER 125 125S	PEPERONE PILCANTE DI CATENNA 126 126S	PEPERONE SILVATICA DI BERGAMO PER SOTTILE 127	PEPERONE CILEGIA PICCANTE 129 129S	PORRO GIGANTE DI INVERNO 2 145 145S

Standard 11x16

BUSTA (12) € 1,40

Supermaxi 13x20

BUSTA (12)

€ A RICHIESTA



SEMI

LATTUGA
LA CAPPUCCIO REGINA D'ESTATE

88 ✓
88S ✓

LATTUGA
REGINA DEI GHIACCII

91 ✓
91S ✓

LATTUGA
LA CAPPUCCIO REGINA DI MAGGIO

92 ✓
92S ✓

LATTUGA
LA CAPPUCCIO S. ANNA

93 ✓
93S ✓

LATTUGA
LA CAPPUCCIO TROCADERO

94 ✓
94S ✓

LATTUGA
LA CAPPUCCIO VERDE D'INVERNO

96 ✓
96S ✓

LATTUGA
L'UNICO CAPPUCCIO DA GIUGNO A DICEMBRE

98 ✓
98S ✓

LATTUGA
CANASTA

100 ✓
100S ✓

LATTUGA
CATALOGNA

101 ✓

LATTUGA
GREAT LAKES 118

102 ✓
102S ✓

LATTUGA
ROMANA VERDE DEGLI ORTOLANI

103 ✓
103S ✓

LATTUGA
ROMANA VERDE D'INVERNO

105 ✓
105S ✓

LATTUGA
ROMANA BORDATA 113 E 114

106 ✓
106S ✓

LATTUGA
DA TAGLIO A FOGLIA LISCIA

107 ✓
107S ✓

LATTUGA
BIONDA A FOGLIA ESILE DA TAGLIO

108 ✓
108S ✓

LATTUGA
VERDE RICCIOLINA DA TAGLIO

109 ✓
109S ✓

ASPARAGO
ARGENTEUIL

5 ✓
5S ✓

BIETOLA DA ORTO
PALLA ROSSA 2

6 ✓
6S ✓

CARDO
BIANCO AVORIO

25 ✓

CARDO
PIENO NERME

26 ✓

CARDO
GIGANTE DI ROMAGNA

27 ✓
27S ✓

INDIVIA RICCIA
PANCALIERI A COSTA BIANCA

84 ✓
84S ✓

INDIVIA RICCIA
CUOR D'OKO

85 ✓
85S ✓

INDIVIA SCAROLA
VERDE A CUORE PIENO

171 ✓
171S ✓

INDIVIA SCAROLA
GIGANTE DEGLI ORTOLANI

173 ✓
173S ✓

BIETOLA DA COSTE
VERDE A COSTA LARGA ARGENTATA 1

12 ✓
12S ✓

BIETOLA DA COSTE
BIONDA A COSTA ARGENTATA 2

13 ✓
13S ✓

BIETOLA DA COSTE
LISCIA VERDE DA TAGLIO

14 ✓
14S ✓

CIPOLLA
ROSSA LUNGA DI TRENZI

72 ✓
72S ✓

CIPOLLA
BIANCA DI LUCCA

73 ✓

CIPOLLA
ROSSA DI TRENZI DA TRENZI

74 ✓
74S ✓

CIPOLLA
ROSSA SAVONESE

75 ✓

CIPOLLA
TROPICA ROSSA LUNGA

75A ✓

CIPOLLA
TROPICA ROSSA TONDA

75B ✓
75BS ✓

CIPOLLA
TRECOSMIA DI POMI PER SOTTACCI

76 ✓
76S ✓

ZUCCHINO
STRIPPO D'ITALIA

177 ✓
177S ✓

ZUCCHINO
GENOVESE

178 ✓
178S ✓

ZUCCHINO
ALBERELLO DI SARZANA

179 ✓
179S ✓

ZUCCHINO
BIANCA DI TRIESTE

180 ✓
180S ✓

ZUCCHINO
TONDO CHIARO DI NIZZA

182 ✓
182S ✓

ZUCCHINO
NANO VERDE DI MILANO

183 ✓
183S ✓

ZUCCA
LUNGA DI NAPOLI

184 ✓

ZUCCA
QUINTALE SEME GIALLO

185 ✓

ZUCCA
TROMBETTA D'ALBENGA

186 ✓

ZUCCHINO
BORGIO FIORENTINO

188 ✓
188S ✓

ZUCCHINO
GENOVESE (DA FIORE)

189 ✓

SPINACIO
MONSTREUX DE VIROFLAY

168 ✓
168S ✓

SPINACIO
MATADOR

169 ✓
169S ✓

SPINACIO
GIGANTE D'INVERNO

170 ✓
170S ✓

RAPA
DI MILANO A COLLETTA ROSA

147 ✓
147S ✓

RAPA
DELLE VIRTU' O MARTELLO

148 ✓
148S ✓

RAPA
PISTOIESE O TOSCANA

149 ✓
149S ✓

RAPA
SENZA FINE O BROCCOLINI ALTO

150 ✓
150S ✓

ANGURIA
KLONDIKE RS 57

3 ✓
3S ✓

MELONE
RETATO DEGLI ORTOLANI

114 ✓
114S ✓

MELONE
CANTALUPO DI CHARENTAIS

115 ✓
115S ✓

Standard 11x16

BUSTA (12) € 1,40

Supermaxi 13x20

BUSTA (12) € A RICHIESTA

I PREZZI RIPORTATI SONO ESCLUSI DI IVA 150

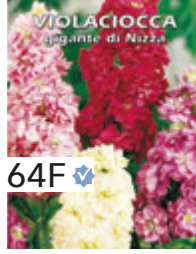
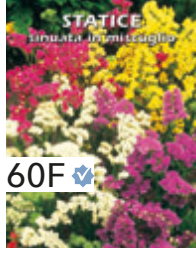
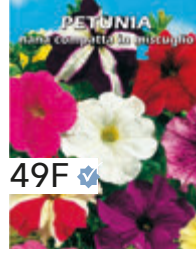
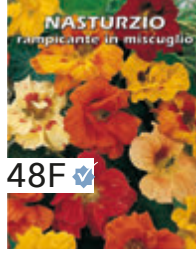
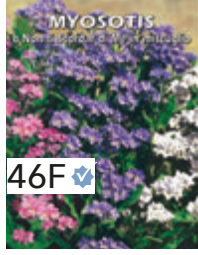
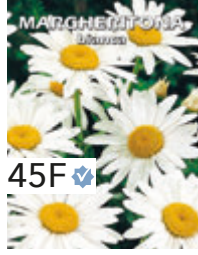
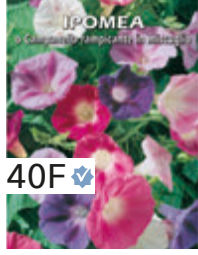
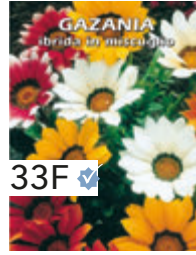
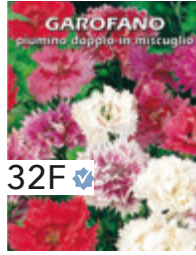
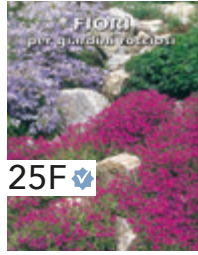
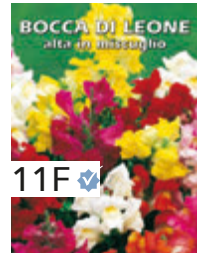
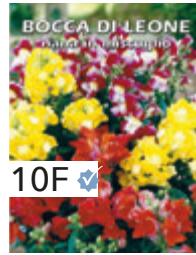
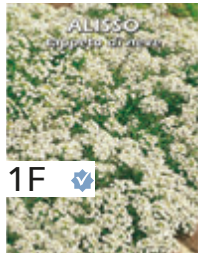
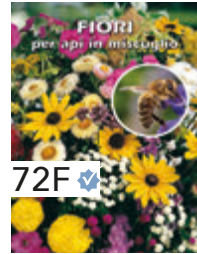
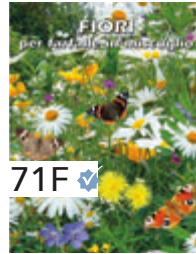
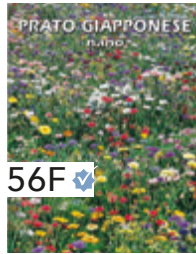
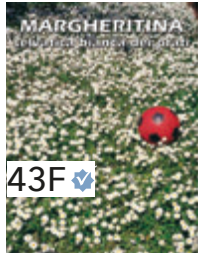
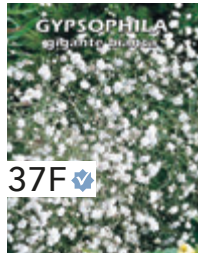
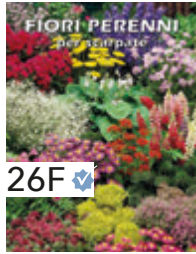
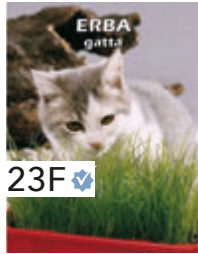
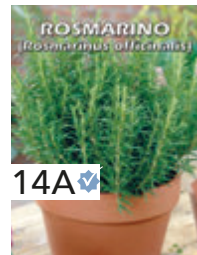
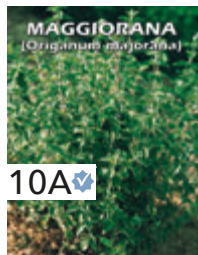
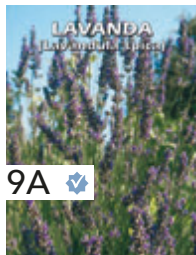
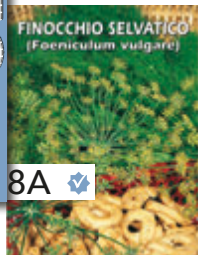
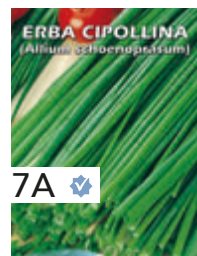
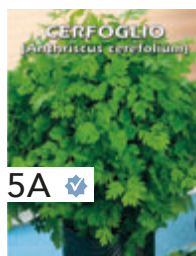
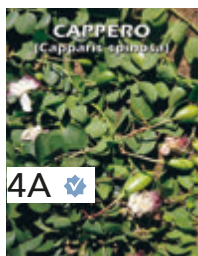
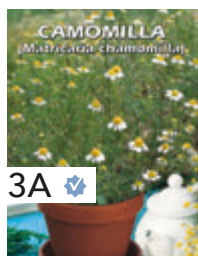
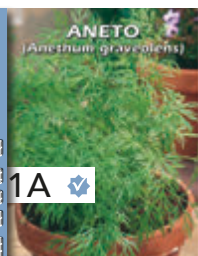

Standard 13x20 Fiori, Aromatiche e Erba Gatta

BUSTA (12)

€ 2,10



SEMI



Cod. MIX003

Miscuglio di graminacee che sono molto resistenti al calpestio e continue rasature. Il tappeto è molto compatto.

HEAVY FOOT TRAFFIC LAWN
This blend of grasses provides a compact turf lawn that is highly resistant to foot traffic and frequent mowing.



Cod. MIX008

Miscuglio di graminacee adatte alla formazione del tappeto verde all'ombra, molto compatto e di crescita lenta.

SHADY LAWN This blend of grasses forms a green, very compact and slow-growing turf in shady areas.



Seme qualità Dotto

Rustico (12)	Kg.1	€ 13,50
	gr. 500 (in scatola)	€ 8,50

Seme qualità Dotto

Rigenera (12)	Kg.1	€ 13,50
	gr. 500 (in scatola)	€ 8,50



Cod. MIX012

Miscuglio di graminacee a portamento nano adatte a formare un tappeto compatto di colore verde brillante. È resistente al calpestio, cresce rapidamente e si adatta a tutti i tipi di terreno.

EASY LAWN This blend of dwarf grass forms a compact and bright green turf that is resistant to foot traffic, grows quickly and adapts easily to any kind of soil.



Cod. MIX016

Miscuglio di graminacee adatte ad esposizione al sole per ottenere un tappeto erboso molto omogeneo, verde e molto resistente.

SUNNY LAWN This blend of grasses is ideal for lawns exposed to direct sunlight and provides a very even, green and highly resistant turf.



Seme qualità Dotto

Ombreggiato (12)	Kg.1	€ 13,50
	gr. 500 (in scatola)	€ 8,50

Seme qualità Dotto

Soleggiato (12)	Kg.1	€ 13,50
	gr. 500 (in scatola)	€ 8,50



Sementi in barattolo

Gramigna Lb. 1	€ 25,90
----------------	---------

Dichondra Lb. 1	€ 25,90
-----------------	---------

sfusi a richiesta

Trifoglio nano Lb. 1	€ 20,50
----------------------	---------

Trifoglio nanissimo Lb. 1	€ 21,50
---------------------------	---------

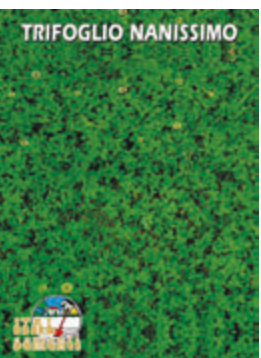
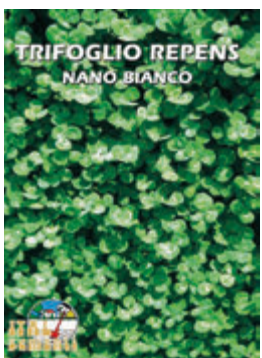
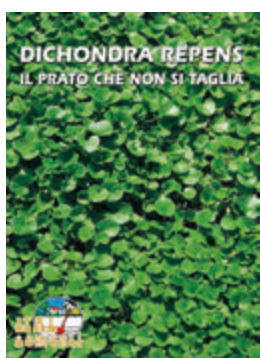

Miscuglio Prato Rustico

Prato Margherite gr. 100	€ 7,50	Dichondra gr. 100	€ 6,50	Trifoglio nano gr. 100	€ 5,50	Trifoglio Nanissimo gr. 100	€ 6,50	gr. 100	€ 5,50
								Kg. 1	€ nd.

I PREZZI RIPORTATI SONO ESCLUSI DI IVA

CONCIME

BarFertile Starter NPK 7 - 13 - 9 + Micorrize

- Tecnologia: metileneurea e sostanza organica vegetale
- Alto titolo in fosforo (P)
- 15% di azoto a lento rilascio da MU
- 40% di sostanza organica vegetale
- Durata 2-3 mesi
- SGN 200
- Con micorrize



N Totale	7%	Fosforo Totale P ₂ O ₅	13%	Potassio Totale K ₂ O	9%	Altro
N Organico	1,8%	Fosforo solubile P ₂ O ₅	9%	Potassio solubile	9%	Micorrize
N Ammoniacale	2,2%					
N Ureico	2,0%					
N Metileneurea	1,0%					Sostanza organica vegetale 40%

Modo d'impiego

- Dose: 35-40 g/mq
- Epoca: dalla primavera all'autunno
- Migliora l'insediamento del prato ed il primo sviluppo radicale

UTILIZZO: Ideale per la posa di nuovi tappeti erbosi e/o per la semina di nuovi prati, risemina e rinfoltimento di prati esistenti. Prima concimazione nella piantumazione di Alberi, Siepi, Rose, Frutti, Aromatiche legnose.

TEMPO CONCIMAZIONE: Da Marzo a Novembre.

DURATA CONCIMAZIONE: Media 2/3 Mesi.

SACCO 5 Kg Listino Barenbrug : Euro **26,00** - **CHIEDI EVENTUALI OFFERTE**

SACCO 20 Kg Listino Barenbrug : Euro **71,00** - **CHIEDI EVENTUALI OFFERTE**

BarFertile Eco NPK 14 - 5 - 8 + Ca, Mg e S - CONCIME

- Tecnologia: sostanza organica vegetale
- Rapporto equilibrato
- Durata 30-40 giorni
- Per tutte le colture del giardino
- Calcio e Magnesio per rinforzare la pianta
- SGN 240



N Totale	14%	Fosforo Totale P ₂ O ₅	5%	Potassio Totale K ₂ O	8%	Meso e microelementi
N Organico	1%	Fosforo solubile in acqua	4,5%	Potassio solubile	8%	Magnesio MgO 3,5%
N Ammoniacale	9%					Calcio CaO 4%
N Ureico	4%					Zolfo SO ₃ 17%
						Sostanza organica vegetale 20%

Modo d'impiego

- Dose: 40 g/mq
- Epoca: tutto l'anno, dopo il taglio
- Il Calcio aumenta la resistenza del prato alle malattie

UTILIZZO: Concime ideale post primi tagli dei tappeti erbosi e potature di siepi alberi arbusti. Consente forza ed irrobustimento alle piante ed i tappeti erbosi su tutto l'apparato radicale.

TEMPO CONCIMAZIONE: Da Febbraio/Aprile Settembre/Novembre.

DURATA CONCIMAZIONE: Durata concimazione max 30 giorni.

SACCO 20 Kg Listino Barenbrug : Euro **61,00** - **CHIEDI EVENTUALI OFFERTE**

BarFertile Eco-K NK 10 - 20 + Mg, S

- Tecnologia: sostanza organica vegetale
- Rapporto equilibrato
- Durata 30-40 giorni
- Per tutte le colture del giardino
- Calcio e Magnesio per rinforzare la pianta
- SGN 240



N Totale	14%	Fosforo Totale P ₂ O ₅	5%	Potassio Totale K ₂ O	8%	Meso e microelementi
N Organico	1%	Fosforo solubile in acqua	4,5%	Potassio solubile	8%	Magnesio MgO 3,5%
N Ammoniacale	9%					Calcio CaO 4%
N Ureico	4%					Zolfo SO ₃ 17%
						Sostanza organica vegetale 20%

Modo d'impiego

- Dose: 40 g/mq
- Epoca: tutto l'anno, dopo il taglio
- Il Calcio aumenta la resistenza del prato alle malattie

UTILIZZO: Concime ideale post primi tagli dei tappeti erbosi e potature di siepi alberi arbusti. Consente forza ed irrobustimento alle piante ed i tappeti erbosi su tutto l'apparato radicale.

TEMPO CONCIMAZIONE: Da Febbraio/Aprile Settembre/Novembre.

DURATA CONCIMAZIONE: Durata concimazione max 30 giorni.

SACCO 20 Kg Listino Barenbrug : Euro **61,00** - **CHIEDI EVENTUALI OFFERTE**

CARATTERISTICHE: BarFertile STARTER e' un innovativo concime PROFESSIONALE Organo Minerale, dalla Granulometria fine. Stimola la radicazione favorendo l'insediamento nel terreno, Migliora l'attivita' biologica del terreno stesso. Arricchito da "MICORRIZE" ovvero, uno sviluppo di funghi all'unisono con il terreno e le radici della pianta. Micorrize antagonista positivo nel combattere patologie quali: Funghi, acari, afidi.

CARATTERISTICHE: BarFertile ECO e' un innovativo concime PROFESSIONALE Organo Minerale, dalla Granulometria Media. Specifico per le concimazioni di fine inverno inizio autunno. L'importante contenuto di azoto, favorisce la ricrescita post primi tagli dei tappeti erbosi con un sensibile rinfoltimento delle la superfici erbose. Negli alberi, siepi ed arbusti, protegge la pianta dalle potature sostenendo la ripresa vegetativa, favorendo la cicatrizzazione. Calcio, Magnesio e Zolfo mantengono e rafforzano la colorazione della pianta irrobustendo la struttura del prato e delle piante.

CARATTERISTICHE: BarFertile ECO e' un innovativo concime PROFESSIONALE Organo Minerale, dalla Granulometria Media. Specifico per le concimazioni di fine inverno inizio autunno. L'importante contenuto di azoto, favorisce la ricrescita post primi tagli dei tappeti erbosi con un sensibile rinfoltimento delle la superfici erbose. Negli alberi, siepi ed arbusti, protegge la pianta dalle potature sostenendo la ripresa vegetativa, favorendo la cicatrizzazione. Calcio, Magnesio e Zolfo mantengono e rafforzano la colorazione della pianta irrobustendo la struttura del prato e delle piante.



CONCIME

BarFertile Summer/Winter NPK 8 - 5 - 16 + Mg, Fe e S

- Tecnologia: metilenurea e sostanza organica vegetale
- Rapporto equilibrato N:K = 1:2
- 20% di azoto a lento rilascio da MU
- 30% di sostanza organica vegetale
- Durata 2-3 mesi
- SGN 200
- Con magnesio, ferro e zolfo



N Totale	8%	Fosforo Totale P ₂ O ₅	5%	Potassio Totale K ₂ O	16%	Meso e microelementi
N Organico	1,7%	Fosforo solubile P ₂ O ₅	4,3%	Potassio solubile	16%	Magnesio MgO 2%
N Ammoniacale	3,3%					Zolfo SO ₃ 5%
N Ureico	1,5%					Ferro Fe 1%
N Metilenurea	1,5%					Sostanza organica vegetale 30%

Modo d'impiego

- Dose: 35-40 g/mq
- Epoca: estate e tardo autunno
- Migliora la risposta del prato in estate e inverno

UTILIZZO: Ideale per il mantenimento e la protezione dai forti stress climatici delle piante ed dei tappeti erbosi. Consente forza ed irrobustimento alle piante ed i tappeti erbosi su tutto l'apparato radicale.

TEMPO CONCIMAZIONE: Da Giugno a Dicembre.

DURATA CONCIMAZIONE: Media 2/3 Mesi.

SACCO 5 Kg Listino Barenbrug : Euro **26,00** - **CHIEDI EVENTUALI OFFERTE**

SACCO 20 Kg Listino Barenbrug : Euro **71,00** - **CHIEDI EVENTUALI OFFERTE**

BarFertile Spring/Autumn NPK 16 - 5 - 8 + Mg, Fe e S

- Tecnologia: metilenurea e sostanza organica vegetale
- Rapporto equilibrato N:P:K
- 25% di azoto a lento rilascio da MU
- 25% di sostanza organica vegetale
- Durata 2 - 3 mesi
- SGN 200
- Con magnesio, ferro e zolfo



Modo d'impiego

- Dose: 35 - 40 g/mq
- Epoca: primavera e tarda estate
- Sostiene la crescita primaverile e autunnale

N Totale	16%	Fosforo Totale P ₂ O ₅	5%	Potassio Totale K ₂ O	8%	Meso e microelementi
N Organico	1,3%	Fosforo solubile P ₂ O ₅	4,3%	Potassio solubile	8%	Magnesio MgO 2%
N Ammoniacale	5,7%					Zolfo SO ₃ 13%
N Ureico	5,0%					Ferro Fe 1%
N Metilenurea	4,0%					Sostanza organica vegetale 25%

Confezione: 20 kg

UTILIZZO: Concime ideale per il mantenimento in tutte le stagioni dei tappeti erbosi, siepi, alberi e arbusti. L'equilibrio vegetativo già in essere viene mantenuto con vigore e forza accentuando il rinverdimento e la crescita, consolidando l'apparato radicale di tutti i tipi di tappeti erbosi, alberi e arbusti. Rilascio controllato dei microelementi.

TEMPO CONCIMAZIONE: Tarda primavera, autunno.

DURATA CONCIMAZIONE: Risultati visibili e costanti nel tempo. Media 30/40 Giorni, ripetibile.

SACCO 5 Kg Listino Barenbrug : Euro **26,00** - **CHIEDI EVENTUALI OFFERTE**

SACCO 20 Kg Listino Barenbrug : Euro **79,00** - **CHIEDI EVENTUALI OFFERTE**

BarFertile K Plus NK 13 - 0 - 26 + Mg e S - CONCIME

- Tecnologia: cessione controllata con pellicola MCT biodegradabile
- Alto titolo in potassio, rapporto N:K = 1:2
- 30% di cessione controllata
- Durata 3-4 mesi
- Alta solubilità
- SGN 240
- Con magnesio e zolfo



N Totale	13%	Potassio Totale K ₂ O	26%	Meso e microelementi
N Ammoniacale	4%	Potassio solubile	26%	Magnesio MgO 2%
N Ureico	9%			Zolfo SO ₃ 34%
ricoperto al 50%				

Modo d'impiego

- Dose: 25-30 g/mq
- Epoca: tarda primavera e tardo autunno
- Aumenta la resistenza agli stress termici e parassitari

UTILIZZO: Concime ideale dove si richieda un moderato apporto di azoto nei tappeti erbosi, siepi, alberi e arbusti. Al momento stesso un importante apporto di potassio al consolidamento della struttura e della radicazione dei tappeti erbosi, siepi, alberi e arbusti. Rilascio controllato dei microelementi.

TEMPO CONCIMAZIONE: Fine Inverno, Primavera, tarda Estate, prima parte di Autunno.

DURATA CONCIMAZIONE: Risultati visibili e costanti nel tempo. Media 3/4 Mesi.

SACCO 20 Kg Listino Barenbrug : Euro **79,00** - **CHIEDI EVENTUALI OFFERTE**

CARATTERISTICHE: BarFertile SUMMER & WINTER e' un innovativo concime PROFESSIONALE Organo Minerale, dalla Granulometria Medio fine. Specifico per le concimazioni Estive ed Invernali. L'importante contenuto di potassio, incrementa la resistenza all'usura derivante dal calpestio, contiene gli stress climatici derivanti dalla siccita' e dal freddo. Magnesio, Ferro e Zolfo mantengono e migliorano la colorazione del prato, evitando il formarsi in superficie il muschio. Su tutte le piante legnose, arbusti e siepi, consolida e migliora tutto l'apparato radicale, concedendo e mantenendo una visibile colorazione originale della pianta, un'ottima qualita' di eventuali frutti.

CARATTERISTICHE: BarFertile SPRING/AUTUMN e' un innovativo concime PROFESSIONALE Organo Minerale, dalla Granulometria media. Specifico per la concimazione in tutto l'anno. Il già equilibrato stato di benessere dei tappeti erbosi, siepi, alberi e arbusti permettono al concime un ottimo mantenimento, apportando la giusta dose di azoto, potassio, con l'aggiunta di zolfo. Favorendo così la crescita e il rinfoltimento e consolidamento dei tappeti erbosi, siepi, alberi e arbusti. Acidificando il terreno, favorendo l'assorbimento dei microelementi come il ferro.

CARATTERISTICHE: BarFertile K-PLUS e' un innovativo concime PROFESSIONALE Organo Minerale, dalla Granulometria media. Specifico per le concimazioni in cui necessita un'elevato apporto di potassio con un contenuto apporto di azoto. La cessione controllata di Azoto garantisce una crescita equilibrata del tappeto erboso e delle piante. L'elevato contenuto di potassio, favorisce il potenziamento e consolidamento dell'apparato radicale dei tappeti erbosi, e delle piante. Consente una maggiore resistenza a gli stress da calpestio sul tappeto erboso, con un forte irrobustimento vegetativo delle piante. Il significativo concentrazione di zolfo acidifica il terreno favorendo l'assorbimento dei microelementi quali il magnesio.

CONCIME

BarFertile Fairway NPK 22 - 5 - 8 + Mg, Fe e S

- Tecnologia: cessione controllata con pellicola MCT biodegradabile
- Alto contenuto di azoto
- 20% di cessione controllata
- Durata 3-4 mesi
- Elevata solubilità
- SGN 240
- Con magnesio, ferro e zolfo



N Totale	22%	Fosforo Totale P ₂ O ₅	5%	Potassio Totale K ₂ O	8%	Meso e microelementi
N Ammoniacale	13%	Fosforo solubile P ₂ O ₅	4,5%	Potassio solubile	8%	Magnesio MgO 2%
N Ureico	9%					Zolfo SO ₃ 22%
ricoperto al 50%						Ferro Fe 0,5%

Modo d'impiego

- Dose: 25-30 g/mq
- Epoca: primavera e tarda estate
- Stimola la ripresa vegetativa all'uscita dall'inverno e dall'estate

UTILIZZO: Concime ideale ove si richieda un forte apporto di azoto dei tappeti erbosi, siepi, alberi e arbusti. Vigore e forza con accentuato rinverdimento alle piante ed i tappeti erbosi su tutto l'apparato fogliare. RILASCIO CONTROLLATO DEI MICRO ELEMENTI.

TEMPO CONCIMAZIONE: FINE INVERNO PRIMAVERA, TARDA ESTATE, PRIMA PARTE AUTUNNO.

DURATA CONCIMAZIONE: Risultati visibili e, costanti nel tempo. Durata concimazione max 3/4 mesi.

SACCO 20 Kg Listino Barenbrug : Euro **71,00** - **CHIEDI EVENTUALI OFFERTE**

BarFertile Maintenance/Universal NPK 17-5-12 +S - CONCIME

- Tecnologia: pronto effetto
- Equilibrato rapporto N:K
- Azione pronta
- Durata 30-40 giorni
- Alta solubilità
- SGN 240
- Alto contenuto in zolfo



N Totale	17%	Fosforo Totale P ₂ O ₅	5%	Potassio Totale K ₂ O	12%	Meso e microelementi
N Ammoniacale	14,5%	Fosforo solubile P ₂ O ₅	4,5%	Potassio solubile	12%	Zolfo SO ₃ 40%
N Ureico	2,5%					

Modo d'impiego

- Dose: 25-30 g/mq
- Epoca: tarda primavera e tardo autunno
- Rinverdimento rapido in uscita dalle stagioni critiche

UTILIZZO: Concime ideale per il mantenimento in tutte le stagioni dei tappeti erbosi, siepi, alberi e arbusti. L'equilibrio vegetativo già in essere viene mantenuto con vigore e forza accentuando il rinverdimento e la crescita, consolidando l'apparato radicale di tutti i tipi di tappeti erbosi, alberi e arbusti. Rilascio controllato dei microelementi.

TEMPO CONCIMAZIONE: Tutte e 4 le stagioni.

DURATA CONCIMAZIONE: Risultati visibili e costanti nel tempo. Media 30/40 Giorni, ripetibile.

SACCO 5 Kg Listino Barenbrug : Euro **23,00** - **CHIEDI EVENTUALI OFFERTE**

SACCO 20 Kg Listino Barenbrug : Euro **61,00** - **CHIEDI EVENTUALI OFFERTE**

BarFertile Active NPK 15 - 5 - 15 + Mg e S

- Tecnologia: cessione controllata con pellicola MCT biodegradabile
- Titolo bilanciato N:K = 1:1
- 34% di N a cessione controllata
- Durata 3 - 4 mesi
- Alta solubilità
- SGN 240
- Con magnesio e zolfo



Modo d'impiego

- Dose: 25 - 30 g/mq
- Epoca: tutto l'anno
- Garantisce la nutrizione equilibrata in tutte le stagioni

N Totale	15%	Fosforo Totale P ₂ O ₅	5%	Potassio Totale K ₂ O	15%	Meso e microelementi
N Nitrico	2%	Fosforo solubile P ₂ O ₅	4,5%	Potassio solubile	15%	Magnesio MgO 3,5%
N Ammoniacale	8%					Zolfo SO ₃ 25,0%
N Ureico	5%					

Confezione: 5 kg, 20 kg

UTILIZZO: Concime ideale per il mantenimento in tutte le stagioni dei tappeti erbosi, siepi, alberi e arbusti. L'equilibrio vegetativo già in essere viene mantenuto con vigore e forza accentuando il rinverdimento e la crescita, consolidando l'apparato radicale di tutti i tipi di tappeti erbosi, alberi e arbusti. Rilascio controllato dei microelementi.

TEMPO CONCIMAZIONE: Tutte e 4 le stagioni.

DURATA CONCIMAZIONE: Risultati visibili e costanti nel tempo. Media 30/40 Giorni, ripetibile.

SACCO 5 Kg Listino Barenbrug : Euro **26,00** - **CHIEDI EVENTUALI OFFERTE**

SACCO 20 Kg Listino Barenbrug : Euro **71,00** - **CHIEDI EVENTUALI OFFERTE**

CARATTERISTICHE: BarFertile K-PLUS e' un innovativo concime PROFESSIONALE Organo Minerale, dalla Granulometria Media. Specifico per le concimazioni IN CUI NECESSITA UN ELEVATO APPORTO DI POTASSIO con un contenuto apporto di Azoto. La cessione controllata di Azoto garantisce una crescita equilibrata del tappeto erboso e, delle piante. L'elevato contenuto di potassio, favorisce il rafforzamento e consolidamento dell'apparato radicale dei tappeti erbosi, e delle piante. Consente un maggiore resistenza agli stress da calpestio al tappeto erboso. Un forte stato vegetativo delle piante. Elevato concentrazione di Zolfo acidifica il terreno favorendo l'assorbimento dei micro elementi Magnesio.

CARATTERISTICHE: BarFertile MAINTENANCE e' un innovativo concime PROFESSIONALE Organo Minerale, dalla Granulometria media. Specifico per la concimazione in tutto l'anno. Il già equilibrato stato di benessere dei tappeti erbosi, siepi, alberi e arbusti permettono al concime un ottimo mantenimento, apportando la giusta dose di azoto, potassio, con l'aggiunta di zolfo. Favorendo così la crescita e il rinfoltimento e consolidamento dei tappeti erbosi, siepi, alberi e arbusti. Acidificando il terreno, favorendo l'assorbimento dei microelementi come il ferro.

CARATTERISTICHE: BarFertile ACTIVE e' un innovativo concime PROFESSIONALE Organo Minerale, dalla Granulometria media. Specifico per la concimazione in tutto l'anno. Il già equilibrato stato di benessere dei tappeti erbosi, siepi, alberi e arbusti permettono al concime un ottimo mantenimento, apportando la giusta dose di azoto, potassio, con l'aggiunta di zolfo. Favorendo così la crescita e il rinfoltimento e consolidamento dei tappeti erbosi, siepi, alberi e arbusti. Acidificando il terreno, favorendo l'assorbimento dei microelementi come il ferro.



Water Saver - SEME

Per prati a basso consumo idrico

- Radicazione molto profonda
- Elevata resistenza alla siccità
- Minore richiesta d'acqua
- Contribuisce alla stabilità del terreno
- Prato rustico e resistente



Specifiche

- Velocità di insediamento alta
- Velocità di crescita media
- Altezza di taglio 30 - 40 mm
- Esigenze nutritive media
- Dose di semina 40 g/m²
- Confezione 1 kg, 5 kg, 15 kg

Composizione

- Lolium perenne 10 %
- Poa pratensis 10 %
- Festuca arundinacea 80 %

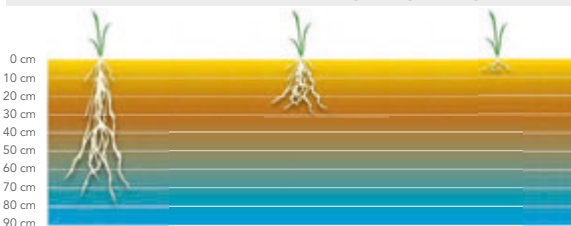

UTILIZZO: Parchi e giardini, pubblici e privati, ad uso ricreativo e/o ornamentale

TEMPO SEMINA: Tutte le stagioni.

SACCO 5 Kg Listino Barenbrug : €uro **83,50**

SCATOLA 1 Kg Listino Barenbrug : €uro **18,90**

CHIEDI EVENTUALI OFFERTE

CARATTERISTICHE: La siccità prolungata può danneggiare gravemente il prato; Water Saver previene questo problema: le varietà ottenute dalla ricerca Barenbrug, presenti in Water Saver, hanno infatti un'eccellente tolleranza alle alte temperature ed alla siccità. La combinazione di varietà Water Saver di Poa pratensis, Festuca arundinacea e Lolium perenne produce un tappeto erboso di qualità elevata che sopporta bene la siccità e l'alta temperatura in estate, garantisce la qualità invernale e assicura un rinverdimento precoce in primavera. Con una radicazione fino a 70 cm.

RPR - SEME

Auto-rigenerante, per aree intensamente calpestate

- Elevata resistenza al calpestamento
- Novità assoluta: Lolium perenne stolonifero
- Robustezza eccezionale e insediamento molto rapido
- Forte attitudine rigenerante
- Buona resistenza al caldo e alla siccità



Specifiche

- Velocità di insediamento molto alta
- Velocità di crescita medio - alta
- Altezza di taglio 15 - 30 mm
- Esigenze nutritive elevate
- Dose di semina 30 - 40 g/m²
- Confezione 5 kg, 15 kg

Composizione

- RPR 50 %
- Lolium perenne 50 %

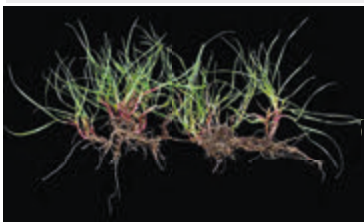

UTILIZZO: Parchi e giardini, pubblici e privati, ad uso ricreativo e/o ornamentale

TEMPO SEMINA: Tutte le stagioni.

SACCO 5 Kg Listino Barenbrug : €uro **83,50**

CHIEDI EVENTUALI OFFERTE

CARATTERISTICHE: Forte come ferro. Gli stoloni in RPR creano una rete naturale orizzontale, in sostanza una forma di "netting" nella zolla, ottenendo in questo modo la massima resistenza al calpestio. Al contrario del Lolium perenne tradizionale che produce singole piante, le piante di RPR creano un legame tra loro nel suolo. Sotto lo stress da calpestio intenso, gli stoloni di RPR mantengono la loro forma nel sottosuolo. Si ottiene così una zolla densa e forte che permette anche la pratica di sport a livello intenso.

Rapide RPR - SOS Lawn Quick Repair - SEME

Auto-rigenerante, per prati sportivi intensamente calpestat

- Tecnologia RPR autorigenerante
- Elevata velocità di insediamento
- Altissima resistenza al calpestio
- Rinverdimento rapido dopo l'inverno
- Colorazione media



Specifiche

- Velocità di insediamento alta
- Velocità di crescita media
- Altezza di taglio 20 - 40 mm
- Esigenze nutritive medio - alte
- Dose di semina 30 g/m²
- Confezione 15 kg

Composizione

- RPR 50 %
- Lolium perenne 25 %
- Poa pratensis 25 %



UTILIZZO: Parchi e giardini, pubblici e privati, ad uso ricreativo e/o ornamentale

TEMPO SEMINA: Primavera, Estate e Autunno.

SACCO 5 Kg Listino Barenbrug : €uro **83,50**

SCATOLA 1 Kg Listino Barenbrug : €uro **18,90**

CHIEDI EVENTUALI OFFERTE

CARATTERISTICHE: Il meglio di due mondi. RPR racchiude forza e velocità germinativa in un'unica specie, unendo caratteristiche diverse e finora inconciliabili: i semi germinano rapidamente e formano un prato denso in tempi estremamente rapidi. Tradizionalmente, specie robuste come Poa pratensis germinano più lentamente rispetto al Lolium perenne. Per compensare questo handicap, in molti miscugli la Poa pratensis viene miscelata ad un Lolium perenne, che germina e si insedia più rapidamente perdendo però capacità di resistenza al calpestio e forza rigenerativa. RPR risolve questo problema unendo la velocità di germinazione con la robustezza del manto erboso. In altre parole: il meglio dei due mondi.

Festuca ovina - shadow - SEME

Per prati a bassissime esigenze

- Estrema tolleranza all'ombra
- Basse esigenze idriche
- Basse esigenze nutrizionali
- Crescita ridotta
- Colore verde scuro



Specifiche

- Velocità di insediamento medio - bassa
- Velocità di crescita bassa
- Altezza di taglio 30 - 70 mm
- Esigenze nutritive basse
- Dose di semina 30 - 40 g/m²

Composizione

Festuca ovina (trachyfilla) 100%

Confezione: 25 kg

UTILIZZO: Parchi e giardini, pubblici e privati, ad uso ricreativo e/o ornamentale

- GOLF Tee Fairway Green Rough
VERDE SPORTIVO Nuove semine Trasemine
VERDE URBANO Ornamentale Ricreativo

TEMPO SEMINA: Tutte le stagioni. **Ideale per climi caldi e siccitosi, a bassissime esigenze di mantenimento**

SACCO 15 Kg. Listino Barenbrug : €uro **223,00** CHIEDI EVENTUALI OFFERTE

Sunny

Per prati rustici

- Buona resistenza alla siccità
- Rapidità di insediamento
- Tolleranza al calpestio
- Elevata densità fogliare
- Contribuisce alla stabilità del terreno



Specifiche

- Velocità di insediamento alta
- Velocità di crescita media
- Altezza di taglio 30 - 50 mm
- Esigenze nutritive media
- Dose di semina 40 g/m²

Composizione

Lolium perenne 25 %
Poa pratensis 5 %
Festuca arundinacea 70 %

Confezione: 15 kg

UTILIZZO: Parchi e giardini, pubblici e privati, ad uso ricreativo e/o ornamentale

- GOLF Tee Fairway Green Rough
VERDE SPORTIVO Nuove semine Trasemine
VERDE URBANO Ornamentale Ricreativo

TEMPO SEMINA: Tutte le stagioni. **Ideale per climi caldi e siccitosi**

SACCO 15 Kg. Listino Barenbrug : €uro **193,00** CHIEDI EVENTUALI OFFERTE

Speedy Green - colore verde scuro

Per prati a rapido insediamento

- Elevata velocità di insediamento
- Buona resistenza al freddo
- Ideale per le trasemine di fairways e prati sportivi
- Colorazione medio - scura
- Buona resistenza al calpestio

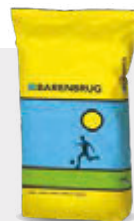

Specifiche

- Velocità di insediamento molto elevata
- Velocità di crescita elevata
- Altezza di taglio 15 - 30 mm
- Esigenze nutritive elevate
- Dose di semina 30 - 40 g/m²

Composizione

Lolium perenne 100 %

Confezione: 15 kg

UTILIZZO: Parchi e giardini, pubblici e privati, ad uso ricreativo e/o ornamentale

- GOLF Tee Fairway Green Rough
VERDE SPORTIVO Nuove semine Trasemine
VERDE URBANO Ornamentale Ricreativo

TEMPO SEMINA: Tutte le stagioni. **Ideale per climi caldi e siccitosi**

SACCO 15 Kg. Listino Barenbrug : €uro **193,00** CHIEDI EVENTUALI OFFERTE

CARATTERISTICHE: A base di Festuca ovina (100%) Wonderlawn Festuca ovina è un miscuglio che dà origine a un tappeto erboso ad elevata rusticità (tessitura fogliare media-fine) e alta resistenza all'usura (calpestio), adatto al clima caldo e secco. Prato tollerante sia alle alte che alle basse temperature.

CARATTERISTICHE: A base di Festuca arundinacea (70%) e Lolium perenne (30%), Wonderlawn Basic è un miscuglio che dà origine a un tappeto erboso ad elevata rusticità (tessitura fogliare media-fine) e alta resistenza all'usura (calpestio), adatto al clima caldo e secco. Prato tollerante sia alle alte che alle basse temperature.

CARATTERISTICHE: A base di Lolium perenne (100%), Wonderlawn Speedy Green è un miscuglio che dà origine a un tappeto erboso ad elevata rapidità d'insediamento (tessitura fogliare media-fine) e alta resistenza all'usura (calpestio), adatto al clima caldo e secco. Prato tollerante sia alle alte che alle basse temperature.



Bar Power RPR - PLAY e SPORT - SEME

Auto-rigenerante, per prati ricreativi a calpestio intenso

- Tecnologia RPR autorigenerante
- Ideale per prati al sole e all'ombra
- Elevata resistenza alle malattie
- Robusto e rapido nell'insediamento
- Ampio utilizzo



Specifiche

- Velocità di insediamento alta
- Velocità di crescita media
- Altezza di taglio 30 mm
- Esigenze nutritive medie
- Dose di semina 25 - 35 g/m²
- Confezione 1 kg, 5 kg, 15 kg

Composizione

RPR	60 %
Poa pratensis	10 %
Festuca rubra commutata	20 %
Festuca rubra rubra	10 %

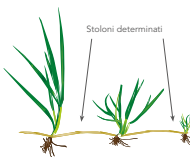

UTILIZZO: Parchi e giardini, pubblici e privati, ad uso ricreativo e/o ornamentale

TEMPO SEMINA: Tutte le stagioni.

SACCO 15 Kg Listino Barenbrug : €uro 223,00

SACCO 5 Kg Listino Barenbrug : €uro 83,50

SCATOLA 1 Kg Listino Barenbrug : €uro 18,90

CARATTERISTICHE: Forte come ferro. Gli stoloni in RPR creano una rete naturale orizzontale, in sostanza una forma di "netting" nella zolla, ottenendo in questo modo la massima resistenza al calpestio. Al contrario del Lolium perenne tradizionale che produce singole piante, le piante di RPR creano un legame tra loro nel suolo. Sotto lo stress da calpestio intenso, gli stoloni di RPR mantengono la loro forma nel sottosuolo. Si ottiene così una zolla densa e forte che permette anche la pratica di sport a livello intenso.

CHIEDI EVENTUALI OFFERTE

Shadow - SEME

Per prati all'ombra

- Prato molto fitto
- Elevata finezza fogliare
- Elevata adattabilità all'ombra
- Bassa manutenzione
- Colorazione verde scuro



Specifiche

- Velocità di insediamento media
- Velocità di crescita medio - bassa
- Altezza di taglio 15 - 40 mm
- Esigenze nutritive medie
- Dose di semina 30 g/m²
- Confezione 1 kg, 5 kg, 15 kg

Composizione

Lolium perenne	10 %
Poa pratensis	10 %
Festuca ovina	15 %
Festuca rubra rubra	40 %
Festuca rubra commutata	25 %



UTILIZZO: Parchi e giardini, pubblici e privati, ad uso ricreativo e/o ornamentale

TEMPO SEMINA: Primavera, Estae, Autunno.

SACCO 5 Kg Listino Barenbrug : €uro 83,50

SCATOLA 1 Kg Listino Barenbrug : €uro 18,90

CHIEDI EVENTUALI OFFERTE

CARATTERISTICHE: Il miscuglio per prati all'ombra di Barenbrug consente, per la sua ampia varietà, di superare le difficoltà ombreggianti date da alberi o strutture che impediscono parzialmente il filtrare dei raggi solari. Tre tipi di Festuca, Lolium e Poa agiscono simultaneamente nella crescita e nel rinfoltimento, sostenendosi in un ricambio primaverile ed estivo. Limitandosi nel tardo autunno ed tutto l'inverno. Potrebbe ogni nuova primavera richiedere una nuova trasemina di shadow.

Bermuda Pan Am

Varietà selezionate di Cynodon dactylon

- Tecnologia Yellow Jacket Biostimulator
- Tessitura medio - fine
- Colore scuro
- Adatta all'uso sportivo
- Eccellente recupero dei divot



Specifiche

- Velocità di insediamento media
- Velocità di crescita media
- Altezza di taglio 15 - 30 mm
- Esigenze nutritive medio - alte
- Dose di semina 10 - 15 g/m²

Composizione

Bermudagrass 3 varietà 100 % confettata

Confezione: 0,5 kg, 10 kg



UTILIZZO: Parchi e giardini, pubblici e privati, ad uso ricreativo e/o ornamentale

TEMPO SEMINA: Tutte le stagioni. **Ideale per climi caldi e siccitosi**

GOLF
VERDE SPORTIVO
VERDE URBANO

- Tee
- Nuove semine
- Ornamentale

- Fairway
- Trasemine
- Ricreativo

Green Rough

CARATTERISTICHE

PanAm Bermudagrass genera un tappeto erboso caratterizzato da una tessitura fogliare medio-fine e un colore verde intenso, dotato di un'alta tolleranza al caldo e alla siccità e una buona tolleranza al freddo invernale. Trattasi infatti di un blend di tre varietà di Cynodon dactylon, specie macroterma largamente impiegata per la realizzazione di parchi e giardini (pubblici e privati) soleggiati e per l'insediamento di aree a verde non dotate di impianto di irrigazione automatico. La confettatura costituisce il 50% del peso del seme.

SCATOLA 500 gr. Listino Barenbrug : €uro 23,90 CHIEDI EVENTUALI OFFERTE

BarFertile Algaturf

- Tecnologia: estratto algale e aminoacidi vegetali liberi
- 50% di sostanza organica
- Migliora la resistenza agli stress (siccità, salinità, temperature estreme)
- Attiva la capacità di ripresa vegetativa conseguente a stress
- Riduce i problemi di crescita del prato dovuti all'applicazione di agrofarmaci
- Contiene glicinbetaine e mannitolo per migliorare la capacità idrica del prato



CONCIME ORGANICO AZOTATO

ESTRATTO FLUIDO DI LIEVITO CONTENENTE ALGHE BRUNE

6% Azoto (N) organico

25,2% Carbonio organico di origine biologica

pH del prodotto tal quale 7 ± 0,5

Modo d'impiego

- Dose: 2-2,5 lt/ha in 1.000 lt di acqua
- Epoca: tutto l'anno
- Migliora la ripresa dopo periodi di stress del prato

UTILIZZO: Parchi e giardini, pubblici e privati, ad uso ricreativo e/o ornamentale

TEMPO DI UTILIZZO: Fine Inverno, Primavera, Inizio Estate, fine Estate, inizio Autunno.

FLACONE LT. 1 Listino Barenbrug : €uro **39,50** - **CHIEDI EVENTUALI OFFERTE**

BarFertile BioNatural

- Tecnologia: consorzio di microrganismi (Trichoderma, Bacillus, Pseudomonas e PGPR)
- Aumenta le resistenze endogene delle piante
- Aiuta nel controllo delle patologie fungine del prato
- Favorisce lo sviluppo di microrganismi utili nel terreno
- Contiene micorrize
- Utilizzabile nei programmi di controllo delle malattie del prato
- Miscelabile con Algaturf



Materie prime: inoculo di funghi micorrizici

Ammendante vegetale semplice non compostato

Contenuto in micorrize (Glomus spp.) 1%

Contenuto in batteri della rizosfera

(Bacillus spp., Streptomyces spp. e Pseudomonas spp.) 10⁷ ufc/g

Contenuto in Trichoderma (Trichoderma spp.) 5 × 10⁷ ufc/g

Modo d'impiego

- Dose: 2,5-3,5 kg/ha in 1.000 l di acqua
- Epoca: da primavera ad autunno
- Aiuta a controllare lo sviluppo delle malattie fungine
- Shelf life: 2 anni in luogo fresco

UTILIZZO: Parchi e giardini, pubblici e privati, ad uso ricreativo e/o ornamentale

TEMPO DI UTILIZZO: Fine Inverno, Primavera, Inizio Estate, fine Estate, inizio Autunno.

FLACONE LT. 1 Listino Barenbrug : €uro **49,50**

CHIEDI EVENTUALI OFFERTE

Dichondra repens

Prato compatto, soffice e molto decorativo. Sopporta il caldo e la siccità

- Tecnologia Yellow Jacket Biostimulator
- Portamento di crescita strisciante
- Specie dicotiledone macroterma
- Resistente al caldo e alla siccità
- Basse esigenze di manutenzione

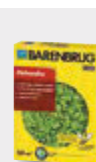

Specifiche

- | | |
|----------------------------------|--------------------------|
| • Velocità di insediamento | medio - bassa |
| • Velocità di crescita verticale | molto bassa |
| • Esigenze nutritive | medio - basse |
| • Dose di semina | 10 - 15 g/m ² |

Composizione

Dichondra repens 100 %
confettata

Confezione: 0,5 kg, 5 kg

UTILIZZO: Parchi e giardini, pubblici e privati, ad uso ricreativo e/o ornamentale

TEMPO SEMINA: Tutte le stagioni. **Ideale per climi caldi e siccitosi**

SCATOLA 500 gr. Listino Barenbrug : €uro **31,90** **CHIEDI EVENTUALI OFFERTE**

I PREZZI RIPORTATI SONO ESCLUSI DI IVA

GOLF
VERDE SPORTIVO
VERDE URBANO

- | | | | |
|---|-------------------------------------|--------------------------------|--------------------------------|
| <input type="checkbox"/> Tee | <input type="checkbox"/> Fairway | <input type="checkbox"/> Green | <input type="checkbox"/> Rough |
| <input type="checkbox"/> Nuove semine | <input type="checkbox"/> Trasemine | | |
| <input checked="" type="checkbox"/> Ornamentale | <input type="checkbox"/> Ricreativo | | |

CARATTERISTICHE: A base di Dichondra repens è una specie erbosa perenne, a portamento strisciante, che raramente supera i 3-5 cm di altezza. I fusti sono prostrati e le foglioline, piccole e rotonde, formano un tappeto erboso soffice e compatto dal colore verde brillante. Dotata di un'alta tolleranza al caldo e alla siccità, la dichondra viene prevalentemente impiegata per la realizzazione di prati ornamentali (decorativi). Tende a formare (su ogni tipo di suolo) un fitto "cuscino" erboso a bassa manutenzione.



Le specie da prato BARENBRUG



Lolium perenne



Lolium multiflorum westerwoldicum



Poa pratensis



Poa annua



Festuca arundinacea



Festuca ovina



Festuca rubra rubra



Festuca rubra commutata



Festuca rubra litoralis



Agrostis stolonifera



Agrostis capillaris



Deschampsia cespitosa



Lolium perenne stoloniferum



Terriccio completo pronto all'uso, ideale per semine e trapianti in piena terra e contenitori. Possiede tutte le sostanze nutritive per garantire la crescita delle piante sia a breve che a lungo termine. **Bioterra** presenta una ottima bagnabilità anche a distanza di tempo, soprattutto in condizioni estive in virtù della buona ritenzione idrica. **PRODOTTO BIOLOGICO**

Universale

LT. 10	€	LT. 45	€
LT. 20	€	LT. 70	€



Terrabril Gaia Universale, substrato completo ed ideale per semine etrapianti a terra e in vaso. La sua struttura è composta da torba bruna e bionda, con fibra di cocco, concimazione fino a 3 mesi. Possiede tutte le sostanze nutritive che favoriscono una buona tenuta idrica.

Universale

LT. 10	€
LT. 20	€
LT. 45	€
LT. 70	€



Terrabril Gaia Tappeti Erbosi, terriccio specifico la manutenzione e creazione di tappeti erbosi. E' ricco di sabbia silicea utile a migliorare la struttura del terreno e favorire una rapida germinazione con una fitta radicazione delle specie erbose.

Tappeti erbosi

LT. 70	€
--------	---



Substrato professionale, leggero, con torba bionda frazionata da mattonella. Consente un buon arieggiamento e stabilità strutturale all'interno del vaso. Pomice di taglia piccola con contenuto nutritivo per le radici. Ottimo per rinvasi di: Azzalee, Ortensie, Camelie, Rododendri, Doplendenza, ecc...

Acidofile

LT. 20	€	LT. 45	€
		LT. 70	€



Terri Tappeti erbosi, substrato specifico per la creazione e manutenzione del tappeto erboso ricreativo e sportivo. **Terri Tappeti erbosi** è ricco di sabbia silicea che serve per migliorare la struttura del terreno e favorire una rapida germinazione delle radici. Ideale per la stesura di tappeti erbosi in rotoli.

Tappeti

LT. 45	€
--------	---



Terrabril Fioriere, substrato specifico per il riempimento di fioriere di medie e grandi dimensioni. Contiene: inerti, vulcanici e fibra di cocco, che conferiscono al substrato una lunga stabilità strutturale con una ottima riserva d'acqua. La speciale concimazione a lenta cessione soddisfa il fabbisogno nutritivo nei primi 2/3 mesi.

Fioriere

LT. 45	€
--------	---



Terrabril Agrumi è il terriccio ottimale per la coltivazione in vaso di tutti i tipi di agrumi da frutto. Equilibrato in ogni sua parte con un ottimo potere drenante, con elementi nutritivi a lento rilascio. Consente una vegetazione a lungo periodo.

Limoni

LT. 20	€	LT. 60 10/25 media	€
LT. 45	€	LT. 60 25/40 grossa	€



Terrabril, selezionata corteccia di conifere europee, evaporata e priva di qualsiasi tipo di parassiti. **Terrabril Corteccia** è la soluzione ideale per la pacciamatura di aiuole e vialletti. Impedisce lo sviluppo delle erbe infestanti, rallenta l'evaporazione dell'acqua, mantenendo più a lungo l'umidità delle piante. Il suo caratteristico colore rossostrato garantisce un risultato estetico di sicuro effetto.

Corteccia

LT. 60 10/25 media	€
LT. 60 25/40 grossa	€



Terrabril Lapillo, prodotto di estrazione lavica, frantumato in granulometria 10/15 mm. Particolarmente adatto alla pacciamatura per un elevato valore estetico e funzionale. La sua naturale composizione chimica lo rende inalterabile nel tempo, in grado di costituire una pacciamatura molto durevole.

Lapillo

LT. 45	€
--------	---



Brill Orchidee e Grasse

pz. 260 a pancale - minipallet pz.130

LT. 5	€
-------	---



Universale da riempimento	Lt. 10	€
Universale da riempimento	Lt. 20	€
Universale da riempimento	Lt. 50	€
Universale da riempimento	Lt. 80	€

Terriccio completo pronto all'uso, ideale per trapianti in piena terra e contenitori. Inoltre ideale per miscelare terreni particolarmente argillosi. Possiede tutte le sostanze nutritive per garantire la crescita delle piante sia a breve che a lungo termine. **PRODOTTO BIOLOGICO**



Terriccio di base pronto all'uso, ideale come rinvaso e nei trapianti a terra. Si presenta di un colore bruno e grazie alle torbe di prima scelta ha una consistenza morbida e soffice. La sua migliore espressione la si trova nella miscelazione con terreni particolarmente argillosi, i quali richiedono "una ingrassatura". Il prodotto presenta un alto contenuto di torba bionda.

Terriccio Universale Vecchia maniera Extra

Lt. 10	€	Lt. 45	€
Lt. 30	€	Lt. 70	€

"... il peggior nemico della creatività è la mancanza di fiducia in se stessi ..."



La Bella Corteccia Extra

Lt. 70	€
--------	---



Buon Stallatico in polvere

Lt. 20	€
Lt. 45	€



Stallatico Pellettato

Kg. 20	€
--------	---



Pollina Pellettata

Kg. 20	€
--------	---



Argilla Agrileca

Lt. 50	€
--------	---



Stalfert Top N2

Substrato di coltivazione misto di alta qualità, ottenuto per maturazione e umificazione di sostanze organiche di origine animale e vegetale, contenente elevato titolo di sostanze umiche, ricco di macro e micro elementi, in grado di migliorare la fertilità del terreno e di stimolare l'attività radicale. Sono degne di nota: il basso livello di umidità dichiarato e garantito e l'alto titolo di Carbonio organico. Particolarmente indicato nella fase d'impianto di vigneti e di frutteti, nonché in orticoltura e nelle colture protette prima del trapianto. In considerazione delle proprietà ammendanti è comunque opportuno evitare che il prodotto venga a contatto diretto con le radici delle piante, soprattutto in fase di trapianto.

Kg. 25

€ 13,90



NPK 18-7-5 FertiField

Concime Organo Minerale NPK pensato per le concimazioni di fondo ed in presemina dei cereali e delle Colture primaverili. Il titolo consente di affrontare a costi contenuti la nutrizione delle colture autunnali e l'elevata qualità delle matrici organiche permette una riduzione dei dosaggi ettaro ed una maggiore salvaguardia dell'ambiente. Trova impiego nella concimazione dei cereali vernini, leguminose, girasole, soia e sorgo.

Kg. 25

€ 39,90



Dermafert NPK 10-10-15 NBPT

Concime organo minerale NPK di coltivazione misto di alta qualità, ottenuto da materie prime pregiate controllate e certificate in tutte le fasi di lavorazione che garantiscono l'apporto di sostanze utili di elevato valore agronomico, anche grazie ai numerosi controlli effettuati dai nostri fornitori. Proprio per questo motivo le sostanze organiche di origine vegetale impiegate per la formulazione del prodotto, contengono elevati tenori di sostanze umiche in grado di migliorare la fertilità del terreno per offrire un ottimo supporto all'attività radicale. Sono degne di nota: il basso livello di umidità dichiarato e garantito e l'alto titolo di Carbonio organico. Particolarmente indicato nella fase d'impianto di vigneti e di frutteti, nonché in orticoltura e nelle colture protette prima del trapianto. In considerazione delle proprietà ammendanti è comunque opportuno evitare che il prodotto venga a contatto diretto con le radici delle piante, soprattutto in fase di trapianto.

Kg. 25

€ 48,90



NP 8-6+B Verdeolivo / FertiField

Nuovo inserimento in gamma di una miscela di Concimi Organici NP 6-6 e Boro, che si propone come un prodotto ottimale per la concimazione di uliveti ma anche frutteti e vigneti nelle realtà pedologiche più diverse. E' adatto per le concimazioni di fondo autunnali e primaverili, in copertura con o senza inerbimento. La presenza di N Organico a lenta cessione naturale ed il fosforo di origine organica garantiscono un rilascio graduale e costante con una elevata efficienza delle unità fertilizzanti. L'utilizzo in Agricoltura Biologica è consentito e la qualità della formulazione garantisce sempre una umidità inferiore al 10%.

Kg. 25

€ 29,90



FertiField NPK 6-9-18

Concime organo-minerale in pellet, ottenuto per reazione delle materie prime per esaltare e migliorare l'efficienza agronomica dell'alto titolo in N organico e l'assimilabilità dei fosfati. I pregi di questo concime si possono così riassumere:

- fornisce N organico che mineralizza durante la stagione vegetativa nell'arco dei 30-45 giorni dalla somministrazione e l'interramento;
- aumenta la biomassa microbica del terreno che migliora l'assimilabilità dei microelementi e del ferro in particolare;
- migliora l'assorbimento dei fosfati;
- favorisce lo sviluppo dei frutti e ne migliora la serbevolezza grazie al potassio;
- incrementa le attività enzimatiche del terreno che stimolano la crescita delle radici;
- contrasta le perdite per dilavamento dei nitrati;
- favorisce la crescita equilibrata della pianta;
- aumenta la resistenza alle fitopatologie;
- aumenta la tolleranza agli stress ambientali (idrici e termici);

FERTI FIELD NPK 4-8-16C è ottimo per le concimazioni di fondo, sia in autunno che in primavera, e in vigneti anche inerbiti. Nei fruttiferi in produzione la concimazione dovrà tenere conto della vigoria e del carico produttivo.

Kg. 25 € 39,90



FertiField NPK 10-5-15

E' un concime organo-minerale NPK ottenuto per reazione delle componenti minerali e organiche proteiche utilizzando una tecnica di co-estrusione per ottimizzare la reazione tra le matrici organiche e quelle minerali.

NBPT che consente di ritardare l'idrolisi della parte ureica con forte riduzione delle perdite di N.

FERTI FIELD NPK 16-5-5 è un concime completo, che oltre all'N Organico a lenta cessione naturale, contiene N ureico inibito con NBPT che, assieme, consentono alle colture di disporre di un flusso nutritivo progressivo e costante durante tutto il ciclo vegeto-produttivo. Contiene inoltre P2O5 e K2O da Solfato ed entrambi gli elementi sono totalmente disponibili per le piante e protetti dalla matrice organica proteica da processi di insolubilizzazione. L'impiego di FERTI FIELD NPK 16-5-5 è ideale in tutti i terreni e particolarmente indicato nei suoli caratterizzati da un elevato pH e un basso contenuto di sostanza organica. Il concime è consigliato per le concimazioni di fondo autunnali, primaverili e di mantenimento di frutteti, vigneti e colture orticole. Si presta inoltre all'utilizzo anche in impianti inerbiti o dove non sia possibile l'interramento. Nei frutteti in produzione la concimazione dovrà tenere conto della vigoria e del carico produttivo. La presenza del K da Solfato ne consiglia l'impiego su tutte le colture di pregio che soffrono la presenza di cloruri.

Kg. 25 € 36,90



Dermaverde Bio N6

Questa nuova formulazione di Miscela di concimi Organici Azotati coniuga un alto titolo di N Organico ad un tenore significativo di C Carbonio Organico 30%. La particolare scelta delle matrici organiche proteiche e la tecnica di coformulazione industriale, consentono di ottenere un formulato, consentito in Agricoltura Biologica, in grado di cedere progressivamente l' N organico contenuto alle piante permettendo una alta efficienza agronomica. E' adatto per le concimazioni autunnali e primaverili anche senza interramento grazie all'N non dilavabile. Si presta all'impiego sui cereali alla semina e copertura, nelle concimazioni dei fruttiferi e negli impieghi orto floro vivaistici.

Kg. 25 € 23,90



Dermazoto N11

Cuoio e Pelli idrolizzati ad elevato titolo in N organico (N11) a lento rilascio naturale, ottenuto per idrolisi delle scleroproteine dei collagene ad alta pressione. Contiene Fe e Mg chelati alla matrice organica, attiva la biomassa vivente e migliora il bilancio umico. La mineralizzazione dell'N organico, pur condizionata dal tipo del terreno (tessitura, struttura, umidità, ossigeno, temperatura), sono mediamente compresi fra i 2 - 4 mesi. In risaia i tempi aumentano in relazione ai periodi di sommersione. Prodotto ottimo per concimazioni di fondo, autunnali e primaverili, in risaia, in copertura nei frutteti e nei vigneti con o senza inerbimento, per prevenire e curare clorosi ferriche e carenze di magnesio.

ECCELLENTE NEL VIVAISMO. Le dosi pur variando da coltura a coltura, sono di norma comprese fra 4 e 12 q/ha.

Kg. 25 € 33,90



Concime BIOLOGICO Natural Booster

Solabiol orti e giardini è un concime granulare 100% di origine naturale, con l'esclusiva tecnologia Natural Booster, che promuove un maggior sviluppo dell'apparato radicale della pianta, favorendo la crescita di piante sane, forti e rigogliose.

Con il concime Solabiol orti e giardini saranno anche più resistenti all'attacco di insetti e parassiti.

86601255 | Kg. 5 (sacco) (100) | € 19,90



Concime Protect Garden 3 in 1

Il concime Protect Garden 3in1 è un concime granulare a basso titolo di cloro che nutre in modo ottimale fino a 3 mesi. È ideale per rispondere ai bisogni nutrizionali delle piante da giardino, siepi e arbusti, frutteto, orto e tappeti erbosi.

Il concime Protect Garden 3in1 grazie alla presenza dell'inibitore dell'ureasi NBPT prolunga l'efficacia della concimazione azotata aumentando la resa e l'efficienza della fertilizzazione nel tempo.

Il particolare supporto completamente biodegradabile a base di calcioprill non rilascia residui sulle colture e non imbratta prati e zone verdi, inoltre apporta anche, oligoelementi come zolfo e calcio, bilanciando il ph del suolo.

86601535 | Kg. 4 (sacco) (100) | € 6,90
86601536 | Kg. 20 (sacco) (70) | € 66,90



Agromaster Mini

Agromaster è un concime a cessione controllata, molto più efficiente dei concimi a pronto effetto perché migliora la disponibilità e l'assorbimento dell'azoto. Ne riduce le perdite per dilavamento ed evaporazione.

Agromaster garantisce alle colture una nutrizione costante e prolungata, che si adegua alle reali esigenze nutritive. Col rilascio più efficiente dell'azoto le dosi sono minori, a vantaggio anche dell'ambiente.

12-8-16+3,4CaO
3,2MgO+26,8SO₃
213 Smart
CONCIME CE NPK (Ca, Mg, S)

36% N-avvolto



- 12,0% AZOTO totale (N)
di cui 8% ammoniacale, 4% ureico
a rilascio controllato
- 8,0% ANIDRIDE FOSFORICA (P₂O₅)
solubile in citrato ammonico neutro e
in acqua di cui 7,2% solubile in acqua
- 16,0% OSSIDO DI POTASSIO (K₂O)
- 3,4% OSSIDO DI CALCIO (CaO)
- 3,2% OSSIDO DI MAGNESIO (MgO)
- 26,8% TRIOSSIDO DI ZOLFO (SO₃)

Granulometria: 2,5-4

Agromaster 213 Smart è un concime granulare standard contenente azoto a cessione controllata, calcio, magnesio e zolfo.

La composizione bilanciata e completa di macro e meso elementi lo rendono un concime universale applicabile su tutte le colture articoles, arboree ed industriali.

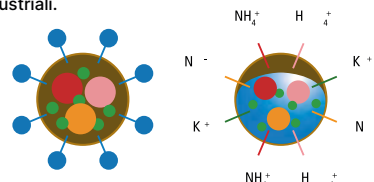

Kg. 25 (sacco) (60) | € 79,90



Fungicida

Zolfo Green

GB0169 | Kg. 1 | € 9,60

ZOLFO GREEN è uno zolfo per uso agricolo destinato a terreni alcalini e sodici. È indicato per correggere gli eccessi di alcalinità del suolo, responsabili della crescita stentata delle colture sensibili e della riduzione dell'assimilazione degli elementi fondamentali della nutrizione. ZOLFO GREEN è uno zolfo elementare finemente macinato di pronto effetto e consente una rapida ossidazione in acido solforico, responsabile del riequilibrio del pH.

Concime liquido in sospensione impiegato per correggere rapidamente le carenze di Rame e Zolfo. Le caratteristiche ne consentono l'utilizzo a dosi ridotte e ne potenziano l'attività. MIZDOR apporta Zolfo, elemento fondamentale per la sintesi proteica e la qualità organolettica di colture orticole, frutticole e industriali. Il Rame è un microelemento indispensabile per la sintesi della clorofilla, degli ormoni vegetali e per la riduzione dei nitrati. La sinergia dei due microelementi migliora l'attività produttiva delle piante.



Concime (rame e zolfo)

Mizzdor

GB0166 | gr. 7550 | € 22,50



Insetticida Fungicida Acaricida

Best Energy

GH0300 | Kg. 1 | € 14,90

Concime universale idrosolubile ad azione energizzante. Perfettamente idrosolubile a base di Macroelementi (N, P, K) bilanciati, destinato a nutrire tutte le tipologie di piante in maniera equilibrata e completa. Può essere utilizzato per applicazione al suolo o sulla vegetazione. Corregge rapidamente mancanze di Azoto (N), Fosforo (P) e Potassio (K), stimolando allo stesso tempo lo sviluppo e la crescita delle piante, per una crescita rigogliosa e colori più brillanti.

Concime idrosolubile ricco in potassio ad azione energizzante. NPK ricco in Potassio, consigliabile su tutte le colture nelle fasi intermedie e finali del ciclo vegetativo. Migliora la colorazione, il contenuto in zuccheri e le caratteristiche organolettiche dei frutti. Su colture floricole e ornamentali conferisce vigore e stimola fioriture abbondanti e prolungate.



Insetticida Fungicida

Best Energy K

GH0348 | Kg. 1 | € 14,50



Concime (potassio)

Siliplant

GH0363 | ml. 250 | € 13,50

Potenziatore delle resistenze delle piante. Concime ad elevato contenuto di potassio completamente idrosolubile. Forma una pellicola inorganica persistente sulla superficie delle specie vegetali, disturbando l'attività dei parassiti. La frazione di silicato assorbita dai tessuti vegetali è in grado di attivare i meccanismi di resistenza sistemica acquisita verso agenti biotici dannosi e rinforzare l'epidermide di piante con eccessi di azoto e soggette e cracking dei frutti.

Promotore naturale di crescita derivante da alghe per uso radicale. Prodotto liquido di elevata efficacia, a base di estratto selezionato di alghe marine brun, con l'aggiunta di microelementi come Zinco (Zn), Molibdeno (Mo) e Fosforo (P). Appositamente studiato per applicazioni al suolo, determina un miglioramento della struttura del suolo, rigenerandone la vitalità, incentiva l'emissione di nuovo capillizio radicale e stimola l'allungamento di quello già esistente.



Stimolante radicale

Root Most

GH0299 | ml. 250 | € 7,50



Insetticida Fungicida

Olio di Neem

GH0431 | ml. 250 | € 14,90

----- (Pronto Uso) | ml. 500 | € 9,90

100% olio di Neem concentrato.

Prodotto di origine naturale, di colore giallo-bruno, ottenuto per estrazione dai semi di Neem, storicamente utilizzato in agricoltura per i suoi molteplici usi e proprietà. Adatto a tutti i tipi di colture, è un rimedio naturale a diverse problematiche, aiutando lo sviluppo delle naturali difese delle piante.

Concime fosfo-potassico liquido esente da cloruri, indicato per applicazioni fogliari e radicali su ogni tipo di coltura. L'impiego regolare sulle colture stimola l'accrescimento del sistema radicale, l'efficienza di assorbimento degli elementi nutritivi presenti nel terreno, l'efficacia dei fertilizzanti associati in miscela e aumenta l'induzione a fiore e la qualità dei frutti. Applicato durante la maturazione dei frutti aumenta l'accumulo degli zuccheri e la formazione di sostanze colorate nell'epiderma.

Concime

Fosfisal

GH0431 | ml. 250 | € 19,90



Stimolante

Best Olivo

GH0361 | Kg. 1 | € 15,50

Favorisce l'allegagione.

Concime specifico contro le boro carenze che si manifestano nelle prime fasi vegetative.

Il concime favorisce l'impollinazione ed incrementa l'allegagione dell'Olivo, della Vite e di tutte le piante frutticole ad esclusione degli agrumi.

Concime al rame.

KARIOS® è un concime in sospensione ad alta concentrazione di rame, efficace a bassi dosaggi che nutre e rinforza le colture trattate.



Insetticida Fungicida Acaricida

Karios

GH0370 | Kg. 1 | € 21,90



Concime (rame)
Karios WP
GB0191 | Kg. 1 | € 15,90

Concime al Rame in polvere solubile (ossicloruro).
Concime a base di Rame e Boro perfettamente disperdibile in acqua e pratico da utilizzare. L'alta concentrazione dei due microelementi essenziali permette di risolvere rapidamente eventuali carenze garantendo la sanità e produttività della pianta. In particolare il Rame risulta fondamentale nei processi di fotosintesi e assimilazione dell'azoto, mentre il L'utilizzo di KARIOS® WP aumenta lo sviluppo, la produzione di frutti, l'intensità del verde del fogliame e la resistenza generale della pianta.



Concime
Zolfo Ventilato
XXXXX | Kg. 1 | € 9,50

CONCIME CE - zolfo elementare.
ZOLFO VENTILATO è un concime a base di zolfo per trattamenti polverulenti a secco. Risolve le carenze di zolfo tipiche di piante vigorose e di suoli lisciviati, migliora l'assorbimento dell'azoto ammoniacale.
Grazie alla purezza e finezza della formulazione, migliora le difese endogene della pianta.



Microelemento Chelati
Rinverdente
GB0096 | gr. 10 x 25buste | € 3,90

Rinverdente a base di microelementi chelati.
RINVERDENTE è una miscela di microelementi chelati singolarmente di elevata qualità in grado di prevenire e curare le carenze nutrizionali che possono causare ingiallimenti delle foglie, malformazioni e scarso sviluppo delle piante. Il prodotto è particolarmente efficace contro microcarenze combinate e difficili da diagnosticare. Impiegato assieme a CONCIME PER ORTAGGI consente la ripresa dello sviluppo vegetativo di piante stressate e danneggiate.



Riparatore fogliare e radicale
Prato Sano
GP0195 | Kg. 1 | € 15,90

Concime fosfo-potassico liquido esente da cloruri per applicazioni fogliari e radicali. Le molecole che lo compongono si caratterizzano per un'elevata assimilabilità e mobilità all'interno della pianta (i risultati delle applicazioni sono visibili nell'arco di 24-48 ore in base alle condizioni di salute del prato ed alla fase fenologica). FOSFISAL ha un'ottima azione bioinduttrice stimolando la pianta a produrre fitoalessine e provocando quindi una protezione verso numerose fisiopatie nutrizionali e crittogame. Possiede inoltre una spiccata azione veicolante nel confronto dei principali nutrienti del tappeto erboso.

Inoculo di funghi micorrizici ad azione sul suolo.
È un concime in polvere bagnabile composto da un consorzio di funghi endomicorrizici e batteri della rizosfera che porta una serie di vantaggi, quali:
Maggiore sviluppo dell'apparato radicale con effetti sulla capacità di tolleranza a tagli frequenti e calpestio intenso;
Miglioramento dell'assorbimento dei fertilizzanti anche in condizioni di stress, che porta ad una migliore qualità estetica del prato ed una rapida ripresa dello sviluppo dopo i tagli.



Funghi Micorrizici
Ekoprop Prati
GE001IT PRATI | g.25 | € 9,90

CONCIME CE - idrossido di rame.
Concime a base di idrossido di rame. Il rame è un microelemento indispensabile per la sintesi della clorofilla e degli ormoni di crescita, contribuendo alla stimolazione delle difese naturali delle piante. Le carenze di rame si manifestano con ingiallimenti e formazione di macchie sui lembi fogliari evidenziate dalle caratteristiche atrofie dei giovani getti.



Concime (idrossido di rame)
Norikura Cu50
GB0171 | gr. 200 | € 10,90

Per risolvere i problemi di carenza applicare 2-3 trattamenti per ciclo culturale.

Rinverdente antimuschio.
Prodotto ideale per correggere gli ingiallimenti fogliari dovuti alla carenza di ferro nel terreno (clorosi ferrica).
Può essere impiegato su tutte le piante da giardino, è particolarmente indicato per piante acidofile, risulta inoltre efficace nella lotta contro il muschio sui tappeti erbosi. Il prodotto contiene anche zolfo, elemento importante, che acidificando il terreno permette un miglior assorbimento degli elementi nutritivi.
Non distribuire in presenza di marmo, piastrelle e cemento.



Sale di Ferro
Solfato di Ferro
GB0068 | Kg.1 | € 10,90

Concime organo minerale la cui frazione organica, di origine completamente vegetale (idrolizzato proteico di erba medica) è particolarmente ricca in aminoacidi: la loro origine vegetale garantisce un bassissimo peso molecolare che facilita la penetrazione nei tessuti vegetali, l'assorbimento e la traslocazione sistemica all'interno della pianta. Gli aminoacidi, una volta penetrati all'interno della pianta, costituiscono la base per la successiva sintesi di proteine consentendo alla pianta un considerevole risparmio energetico in quanto questa può partire da una fase più avanzata di sintesi.



Concime fogliare bioinduttore
Prato Verde
GP0194 | Kg. 1 | € 15,90



Dissuasore Rettili
Scary Reptile
GD0038 | ml.500 | € 11,90



Via Via
Cani e Gatti
Scary Per
GD0031 | ml.500 | € 10,90



Dissuasore Rettili
Scary Snake
GD0028 | gr. 550 | € 15,50



Compresse
Antizanzara
GH0387 | g.100 | € 32,50



Lupini Macinati

GB0069 | Kg. 1 | € 6,50
GB0208 | Kg. 4 | € 21,90

LUPINI MACINATI è un ammendante organico naturale ideale per la concimazione di tutti gli agrumi e di tutte le piante acidofile. Inoltre LUPINI MACINATI, grazie alla sua composizione di origine vegetale, è in grado di migliorare le caratteristiche chimico-fisiche e biologiche del terreno. Ideale per la concimazione invernale e primaverile dei tappeti erbosi e delle piante ornamentali grazie all'azoto a lento rilascio.

Concime fogliare a base di Rame e Boro. Bordogreen polvere - GreenCOP è un concime fogliare a base di Rame e Boro in grado di prevenire e curare i sintomi causati dalla carenza di questi microelementi.



Bordogreen Polvere

GB0158 | Kg. 1 | € 13,90



Zolfo Liquido

GB0126 | Kg. 1 | € 9,90

ZOLFO LIQUIDO è un'innovativa formulazione in sospensione concentrata a base di zolfo, appositamente studiata per trattamenti fogliari al fine di migliorare la qualità e la produzione delle colture orticole, frutticole e industriali. La carenza di zolfo è un grave fattore limitante delle rese quantitative e qualitative, in quanto è elemento fondamentale per la sintesi proteica, per apporto di vitamine e sostanze aromatiche.

È un concime a base di Rame e Boro perfettamente disperdibile in acqua e pratico da utilizzare. L'alta concentrazione dei due microelementi essenziali permette di risolvere rapidamente eventuali carenze garantendo la sanità e produttività della pianta. In particolare il Rame risulta fondamentale nei processi di fotosintesi e assimilazione dell'azoto, mentre il Boro è coinvolto nella divisione cellulare e allegazione dei fiori, soprattutto in specie particolarmente esigenti come Olivo, Agrumi e Pomodoro.



Karios WP

GB0191 | Kg. 1 | € 15,90



Tripla Azione Naturale

GH0435 | ml. 500 | € 9,90

Miscela di sostanze di base ad azione tripla come insetticida, acaricida e fungicida. Prodotto a base di ortica (*Urtica spp.*) ed equisetto (*Equisetum arvense.*), sostanze di base presenti in natura, note per le loro proprietà insetticide, acaricide e fungicide. Applicabile su alberi da frutto, ortaggi e vite, agisce contro insetti quali afidi, ragno rosso, lepidotteri e contro funghi, quali bolla, oidio, peronospora.

BEST® UNIVERSALE risulta essere uno dei migliori fertilizzanti liquidi perché ha un alto contenuto di sostanze umettanti e veicolanti che garantiscono un perfetto e prolungato assorbimento, anche del fosforo (elemento poco assimilabile per via fogliare). La composizione ha più alto titolo di azoto e fosforo con rapporto bilanciato tra gli elementi lo rende impiegabile su tutte le piante nelle fasi di più rapida crescita vegetativa e di formazione di frutti e fiori.



Best Universale

GH0360 | Kg. 1 | € 15,90



Dissetapiante

GH0463 | ml. 300 | € 4,90

Dissetapiante: un'acqua complessata costituita da acqua demineralizzata e cellulosa, una fibra naturale destinata ad uso piante e fiori. Riserva d'acqua adatta per tutte le piante che riduce la frequenza delle innaffiature e assicura un'umidità costante. Tiene l'umidità della terra fino a 30 giorni. Ottima per i periodi di assenza da casa, Utilizzabile tutto l'anno. Innaffia abbondantemente. Rimuovi il tappo per aprire il barattolo e inseriscilo capovolto nel vaso ad una profondità di 2-3 cm.

Applicazioni di EKOPROP® FRUTTI sull'apparato fogliare e sui frutti di colture arboree e orticole determinano uno sviluppo armonico delle piante con incremento della produzione di clorofilla (foglie di colore verde più scuro) e rendono le piante più tolleranti agli agenti biotici dannosi. Inoltre l'attività metabolica dei microrganismi stimola lo sviluppo vegetativo e l'equilibrio ormonale delle piante causando in tal modo una fioritura più omogenea e intensa.



Funghi Micorrizici Ekoprop Frutti

GE0001T Scatola gr25x16 bustine | 1 | € 9,90



Stimolante Rame Zolfo

GB0173 | ml. 750 | € 14,90

È un nuovo concime liquido in sospensione impiegato per correggere rapidamente le carenze di Rame, Manganese e Zolfo. RAME ZOLFO apporta Zolfo, elemento fondamentale per la sintesi proteica e la qualità organolettica di colture orticole, frutticole e industriali. Il Rame e il Manganese sono microelementi indispensabili per la sintesi della clorofilla, degli ormoni vegetali e per la riduzione dei nitrati. La sinergia dei due microelementi migliora lo stato fisiologico e sanitario delle colture, l'attività fotosintetica e la produttività delle piante.

È un'escarodenticida pronta all'uso a base di una sostanza attiva anticoagulante, nota come Brodifacoum, efficace contro Topolino domestico (*Mus musculus*) e Ratto grigio (*Rattus norvegicus*), anche dopo una singola ingestione. La formulazione consiste in una pasta fresca appetibile per le specie di roditori indicate. BRODIFACOUm PASTA può essere usato all'interno ed intorno degli edifici quali, ad esempio, abitazioni, cantine, garage, ripostigli e giardini di proprietà.



Brodifacoum

GH0412 | gr. 150 | € 2,50



Optimus Concime

Universale Biologico	LT.1	€ 8,90	Agrumi	LT.1	€ 8,90	Piante Verdi	LT.1	€ 8,90	Acidofile	LT.1	€ 8,90
Sangue Bue	LT.1	€ 9,80	Gerani e Piante Fiorite	LT.1	€ 8,90	Rinverdente solfato	LT.1	€ 8,90	Magic	LT.1	€ 12,90
			Universale	LT.1	€ 8,90						



Optimus Concime

Agrumi	Kg.1	€ 8,90	Compost	Kg.1	€ 6,90	Solfato di Ferro	Kg.1	€ 8,90	Piante Grasse	ml.250	€ 4,90
									Orchidee	ml.250	€ 4,90

Optimus Concime



Optimus Concime

Orto Giardino	KG.1	€ 8,90	Piante Fiorite	KG.1	€ 8,90	Acidofile	KG.1	€ 8,90	Rose	KG.1	€ 8,90	SuperBLU	KG.1	€ 8,90
---------------	------	--------	----------------	------	--------	-----------	------	--------	------	------	--------	----------	------	--------



Aqua Flu Gel

Acqua gelificata | 300 ml. (18)

€ 4,30



Drink&Food

Aqua Gel Concimante | 400 ml. (18) | € 4,30

Un prodotto che garantisca loro una crescita sana ed equilibrata. TerraBril Concime Multiuso è un concime complesso indicato per questi casi: la sua particolare composizione permette all'azoto di venire rilasciato in maniera progressiva per un periodo lungo fino a tre mesi. La sua formula innovativa favorisce ottimi risultati già a bassi dosaggi, e la friabilità granulare permette alle sostanze fertilizzanti di venire rilasciate istantaneamente. Un concime per una terra ricca e nutrita, frutta e verdura di qualità, piante e fiori rigogliosi e in ottima forma!



Concime Bril

Kg. 5

€ 16,90



CONCIMI



Lapillo Vulcanico
DRLV01 | Lt.1 | 6 | € 5,90



Argilla Espansa
DRAE01 | Lt.1 | 6 | € 5,90



Perlite
DRPE01 | Lt.1 | 6 | € 3,90



Vermiculite
DRVE01 | Lt.1 | 6 | € 4,90



Piante Carnivore
DRCR01 | Lt.1 | 6 | € 4,90



Sabbia al Quarzo
DRPSQ01 | Lt.1 | 6 | € 5,90



Optimus Lupini macinati
Lupini macinati | Kg. 1 | € 5,90
Lupini macinati | Kg. 4,5 | € 18,90



Optimus Pollina
Pollina | Kg.4,5 | € 9,90
Pollina | Kg.20 | € 12,90



Optimus Argilla
Argilla Espansa | Lt.10 | € 8,90
Argilla Espansa | Lt.5 | € 6,90



Corteccia di Pino Decor.
DRPB05 | Lt.5 | 6 | € 8,90



Concime Violet
12-12-17 | KG.5 | € 21,90



Concime Blu
12-17-17 | KG.5 | € 14,90



Concime Prato
SuperGreen | KG.5 | € 16,90



Concime 7-7-7
Super 7-7-7 | Kg.1 | € 14,90



Optimus Concime
Sulfato Ammonico | KG.5 | € 13,90



Solfato di ferro | KG.5 | € 12,90



Nitrato di calcio | KG.5 | € 16,90



Urea | KG.5 | € 15,90



Calcio Cianamide | KG.5 | € 27,90



Optimus Concime
Solfato di Potassio | KG.5 | € 19,90

I PREZZI RIPORTATI SONO ESCLUSI DI IVA



Caolino	ml.550	€ 10,90	Gel Silice	ml.550	€ 10,90	Aceto	ml.550	€ 11,90
Sapone Molle	ml.550	€ 10,90	Propoli	ml.550	€ 10,90	Olio di Neem	ml.550	€ 10,90



Optimus			Diserbante			Insetticida Fungicida		
Estratto d'Ortica	ml.500	€ 9,50	Aceto	LT.1	€ 12,90	Tripla Azione	LT.1	€ 12,90
Pusca via Cani e Gatti	ml.500	€ 10,90				Fungicida	Zolfo e Rame	LT.1
								€ 12,90

“... vola sola
chi osa farlo ...”



BioVente					
Olio di Lino	ml.100	€ 10,90			
Liotamnio	gr.350	€ 9,10			



Barriera Lumachicida	gr. 200	€ 8,90
Barriera Lumachicida	Kg.1	€ 11,90



Ramato					
Solfato di Rame + Calce Idrata	gr.500	€ 13,60			
Rame + Zolfo Mix	Kg.1	€ 16,70			



Ratti Pasta Rossa		
10200	gr. 150	€ 2,90

Esca rodenticida in pasta fresca pronta all'uso, efficace contro topi e ratti con una sola ingestione. Formulazione ad alta appetibilità ideale per il controllo mirato delle infestazioni in ambienti civili, aree commerciali e industriali. Contiene anticoagulante attivo (bromadiolone) con componente amaricante per ridurre l'ingestione accidentale. Utilizzare sempre in contenitori di sicurezza dedicati.



Ratti Pasta Blu		
10200	gr. 150	€ 2,90

Esca rodenticida in pasta pronta all'uso, altamente appetibile e efficace contro topi e ratti anche con una sola ingestione. Ideale per derattizzazione mirata in ambienti civili e commerciali; da utilizzare sempre in contenitori di sicurezza dedicati per massima efficacia e protezione



Disabituante

VV240102 | gr. 850 | € 16,90

Krisaneem è un prodotto a base di microgranuli vegetali e pannelli di Neem, arricchito con altri estratti vegetali. Il suo potere lo rende un efficace disabituante grazie all'azione repellente sugli insetti terricoli e striscianti. L'odore caratteristico del Neem e del macerato di crisantemo, in sinergia con gli altri estratti vegetali, risulta fortemente sgradito agli insetti del suolo, inducendone l'allontanamento dall'area trattata. Il prodotto si presenta in forma di microgranuli e polvere. Per il trattamento distribuire uniformemente sul terreno una dose di 50 g per metro quadrato, irrigando dopo l'applicazione. Ripetere il trattamento ogni 10 giorni per un totale di 4 applicazioni.



Formula Insetticida

VV240101 | ml. 150 | € 17,90

Macerato di crisantemi in soluzione oleosa, riconosciuto per la sua elevata efficacia come insetticida, con duplice azione disabituante e curativa. Il prodotto va diluito nella misura di 2 ml per 1 litro d'acqua. Applicare per via fogliare, ripetendo il trattamento 4 volte a intervalli di 10 giorni.



Concime

Poltiglia Bordolese | gr. 250 | € 11,90
Poltiglia Bordolese | Kg.1 | € 16,90

Bordolese SDD - Fungicida a base di solfato di rame e calce, ad azione preventiva contro peronospora, oidio, bolla e altre malattie fungine di vite, ortaggi e fruttiferi. Diluizione e uso: 50-100 g per litro d'acqua; applicazione fogliare uniforme, ripetere i trattamenti ogni 7-10 giorni in funzione del rischio di infezione. Compatibile con agricoltura biologica se usato secondo le istruzioni.



Fungicida

VV250102 | ml. 500 | € 29,90

Prodotto ad azione fungicida per applicazione fogliare, con effetto preventivo e curativo, efficace contro un ampio spettro di malattie fungine quali bolla del pesco, peronospora, oidio e ticchiolatura. Diluire il prodotto in concentrazione di 7 ml per litro d'acqua. Sono ammessi trattamenti dal risveglio vegetativo fino in prossimità della raccolta dei frutti.



Formula Insetticida

1023000015 | ml. 200 | € 24,90

Vesparex® è un liquido attrattivo concentrato specificamente formulato per la cattura di vespe, calabroni, mosche e moscerini della frutta in abbinamento all'apposita trappola. È basato su fruttosio e acido acetico, ingredienti naturali che mantengono l'attrattività e resistono all'evaporazione e alla decomposizione, restando attivi per settimane. Dosi e uso: Contro vespe e calabroni: diluire circa 100 mL di prodotto in 300 mL d'acqua e versare la soluzione all'interno della trappola; adattare le proporzioni in base alla capacità della trappola. Contro moscerini della frutta: versare circa 50 mL di prodotto puro nella trappola. Posizionare o sospendere la trappola nelle aree frequentate dagli insetti e controllare/regenerare l'esca almeno settimanalmente o quando si riduce l'efficacia.



Trappola

1086000012 | pz. 1 | € 11,90

Newpharm Vesparex Trappola è una trappola specifica per vespe, calabroni, mosche e moscerini della frutta, progettata per l'uso in giardini, balconi, gazebo, frutteti e aree esterne. Il design e il colore attraggono gli insetti verso l'interno, dove rimangono intrappolati e non possono più uscire. Caratteristiche tecniche principali: Forma e colore studiati per massimizzare l'attrazione e impedire l'uscita degli insetti. Dimensioni 130 x 130 x 120 mm, compatta e facile da posizionare. Uso con attrattivo liquido (come Vesparex): versare la soluzione attrattiva preparata all'interno e appendere la trappola in area esterna, preferibilmente in penombra. Consigli d'impiego: mantenere la trappola all'ombra nei giorni caldi e rabboccare con acqua se necessario; non è indicata per uso interno né per la cattura di zanzare.



Vesparex schiuma

1021000055 | ml. 750 | € 12,90

Insetticida aerosol a schiuma attiva, efficace contro insetti volanti e striscianti. Azione rapida e duratura: mosche, zanzare, vespe, formiche, scarafaggi, pulci e acari. Formulazione schiumogena: aderisce alle superfici per un'azione prolungata. Ideale per applicazioni mirate: crepe, fessure e angoli difficili da raggiungere. Principi attivi: tetrametrina, cipermetrina e piperonilbutossido.



Vesparex non schiuma

1010000105 | ml. 750 | € 11,90

Insetticida aerosol ad ampio spettro, non schiumogeno, efficace contro insetti volanti e striscianti. Azione rapida e persistente: mosche, zanzare, vespe, formiche, scarafaggi, pulci e acari. Uso versatile: abitazioni, uffici, locali commerciali e spazi comuni. Facile da applicare: spruzzo uniforme senza schiuma. Principi attivi: tetrametrina, cipermetrina e piperonilbutossido.

Terricci



Compo Sana terriccio

Universale di qualità	Lt. 20	€
Universale di qualità	Lt. 50	€
Universale di qualità	Lt. 80	€
Bonsai (box 60)	Lt. 5	€
Cactacee (box 60)	Lt. 5	€
Orchidee (box 60)	Lt. 5	€

Compo Sana terriccio

Universale (box 60)	Lt. 2,5	€
Cactacee (box 60)	Lt. 2,5	€
Orchidee (box 60)	Lt. 2,5	€

Pall Box

Diviso in tre parti, costituito da:
 - Compo Bio Terriccio Universale Lt. 2,5 (pz. 30)
 - Compo Sana Lt. 2,5 (pz. 30)
 - Compo Cactacee Lt. 2,5 (pz. 30)

Pall Box Completo	Lt. 2,5 - (pz. 90)	€
-------------------	--------------------	---



Compo Sana Compact

Universale	Lt. 25	€
Compo Facile	Lt. 25	€

Bio Leggero	Lt. 25	€
Bio Leggero	Lt. 12,5	€

Supreme	Lt. 25	€
---------	--------	---

GRANUL PLANT

Pomica	Lt. 20 (10)	€
--------	-------------	---



Compo terriccio Terrasan

Universale da riempimento	Lt. 10	€
Universale da riempimento	Lt. 20	€
Universale da riempimento	Lt. 50	€
Universale da riempimento	Lt. 80	€



Solfato Ferroso

Secchiello | Kg. 5 (Box 30) | € 22,90



Compo Concime

Concime giard. (75) | Kg. 4 | € 24,90



Compo Concime

Concime NPK Blu (72) | Kg. 4 | € 18,90



Compo Concime

Concime NPK Oro (75) | Kg. 4 | € 20,90



Compo Concime

Sangue Bue (pz.15)	Lt. 1	€ 15,90
Rose (pz.15)	Lt. 1	€ 13,90
Sulfonie Petunie (pz.15)	Lt. 1	€ 13,90
P. Fiorite con Guano (pz.15)	Lt. 1	€ 13,90
Azalee e Rododendri (pz.15)	Lt. 1	€ 13,90



Compo Concime

Supreme (pz.15)	Lt. 1	€ 15,90
Agrumi e Piant. Medit.	Lt. 1	€ 14,90
Gerani (pz.15)	Lt. 1	€ 13,90
Universale (pz.15)	Lt. 1	€ 13,90
Piant. Verdi (pz.15)	Lt. 1	€ 13,90



Compo Concime

Universale (pz.24)	ml. 500	€ 10,90
Piant. Verdi (pz.24)	ml. 500	€ 10,90
P. Fiorite con Guano (pz.24)	ml. 500	€ 10,90
Azalee e Rododendri (pz.24)	ml. 500	€ 10,90
Gerani (pz.24)	ml. 500	€ 10,90



Compo Concime

Bulbose (pz.12)	ml. 250	€ 8,90
Bonsai (pz.12)	ml. 250	€ 8,90
Cactacee (pz.12)	ml. 250	€ 8,90
Orchidee (pz.12)	ml. 250	€ 8,90



Compo turbo Rinverdente

Nutrizione | gr 20x 30 bustine | € 5,90



Compo turbo Vitalità

Nutrizione | gr 20 x 30 bustine | € 5,90



Turbo Radici

Nutrizione | gr 700 (8) | € 14,50
 Nutrizione | gr 50 x 30 bustine | € 5,90



Oidio e Ticchiolatura

Fungicida | gr. 250 (24) | € 9,50



Compo Guano
Guano (8) | Kg. 1 | € 15,90



Compo Concime Blu
Nitrophoska Blu (16) | Kg. 1 | € 7,90



Compo Concime
Supreme (8) | gr. 850 | € 14,90



Compo Concime
Agrumi (8) | gr. 850 | € 12,90



Compo Concime
Balcone (8) | gr. 850 | € 12,90



Compo Concime
Rose (8) | gr. 850 | € 12,90



Compo Concime
Acidofile (8) | gr. 850 | € 12,90



Compo Concime
Siepi e Arbusti (8) | gr. 850 | € 12,90



Compo Concime
Azzurrante (8) | gr. 800 | € 16,90



Compo Concime
Cycas e Palme (8) | gr. 850 | € 12,90



Compo Concime
Agrumi (20) | gr. 500 | € 15,90



Compo Concime
Cornunghia | Kg. 2,5 | € 18,90



Orchidea goccia
Orchidee | 5x30 ml. | € 9,90



Bastoncini
Orchidea | pz.40 blis-20 | € 6,90



Bastoncini
Piante Fiori | pz.40 blis-30 | € 8,90



Bastoncini
Piante Univ. | pz.40 blis-30 | € 8,90



Concime Linea Bio

Universale (pz.4) | Kg. 2 | € 13,90



Concime Linea Bio

Composter (pz.6) | Kg. 1,8 | € 15,90



Concime Linea Bio

Lupind'or Plus (pz.6) | gr. 800 | € 11,90



Concime Linea Bio

Acidofile (pz.6) | gr. 750 | € 11,90



Concime Linea Bio

Rose (pz.6) | gr. 750 | € 11,90



Concime Linea Bio

Pomodori (pz.6) | gr. 750 | € 11,90



Concime Linea Bio

Piccoli Frutti (pz.6) | gr. 750 | € 11,90



Concime Linea Bio

Insalate (pz.6) | gr. 750 | € 11,90



Compo Linea Bio

Bio Fortigo (pz.15) | Lt. 1 | € 17,90
Bio Agrumi (pz.15) | Lt. 1 | € 15,90



Compo Linea Bio

Bio Orto Frutta (pz.15) | Lt. 1 | € 15,90
Bio Pomodori (pz.15) | Lt. 1 | € 15,90



Compo Linea Bio

Bio Fortigo (pz.24) | ml. 500 | € 13,90
Bio Arom. e Peperonc. (pz.24) | ml. 500 | € 11,90



Compo Organic & Recycled

Concime | kg. 2 (6) | € 17,50
Concime | Lt. 1 (15) | € 14,50



Bastoncini Bio

Concime Universale | (20) | € 8,90



Bastoncini Bio

Concime Aromatiche | (20) | € 8,90



Antilumaca Po

Antilumaca | gr. 200 (24) | € 9,90

“... l'unico vero errore è quello da cui non riusciamo ad imparare nulla ...”



NOVITA'

Sapone Mole Insetticipa Univ.	ml. 750 (12)	€ 13,90	Tripla Azione Inset. Acar. Fung.	ml. 750 (12)	€ 16,90
Lecitina di Soia Fungicida Univ.	ml. 750 (12)	€ 16,90	Aceto Diserbante	ml. 750 (12)	€ 13,90

Piretro Pronto all'uso NOVITA'

Colza Power Anticocciniglia	ml. 750 (12)	€ 18,90
Piretro Insetticipa sistemico	ml. 750 (12)	€ 18,90



Olio di Neem

Insetticipa	ml 750 (12) Pronto Uso	€ 13,90
Insetticipa	ml 250 (24) Concentrato	€ 17,90

Herbistop Diserbo

art.	ml.500 (12) Concentrato	€ 23,90
art.	Lt. 1 (12) Pronto Uso	€ 19,90

Bio Zeolite

Insetticipa	Kg. 1 (10)	€ 17,90
-------------	------------	---------

Bio Soia Concentrato

Insetticipa	ml 500 (20)	€ 17,90
-------------	-------------	---------



Antiformica Granuli

art.	gr. 200 (12)	€ 8,90
art.	gr. 500 (12)	€ 16,90

“...guarda le piccole cose,
un giorno ti volterai e
capirai che erano
grandi...”



Spray

VESPE	ml.750 (12)	€ 18,90
CIMICI	ml. 300 (12)	€ 10,90

Spray Antizzanzare

art.	Lt.1 (12)	€ 15,90
------	-----------	---------



Floranid (12) FINO ESAURIMENTO SCORTE

Starter Semina	Kg 1,25	€ 16,90	Rinverdente	Kg 1,5	€ 22,90
Estate Autunno	Kg 2,5	€ 26,90	Prato 4 Stagioni	Kg 1,5	€ 16,90

Concimi Liquidi



Linfa Concime

art.3030	Universale ml. 500	(16)	€ 7,50	art.3060	Gerani ml. 500	(16)	€ 7,50	art.3067	Rose Lt. 1	(12)	€ 10,90	art.3045	Grasse ml. 500	(16)	€ 7,50
art.3032	Universale Lt. 1	(12)	€ 10,90	art.3062	Gerani Lt. 1	(12)	€ 10,90	art.3000	Azosang Lt. 1	(12)	€ 12,90	art.3046	Orchidee ml. 500	(16)	€ 7,50
art.3037	Piante Verdi Lt.1	(12)	€ 10,90	art.3042	Azalee Lt. 1	(12)	€ 10,90	art.3052	Limoni Lt. 1	(12)	€ 10,90	art.3055	Bulbose ml. 500	(16)	€ 7,50
												art.3070	Bonsai ml. 500	(16)	€ 7,50

Linfa Concime

Concimi Granulari



Linfa Concime

art.3201	Azovel kg.1	(12)	€ 9,90	art.3106	Agrumi kg.1	(12)	€ 13,90	art.8004	Azuro! gr.750	(12)	€ 8,90	art.3103	Bovisang gr.500	(12)	€ 8,90
art.3107	Rose kg.1	(12)	€ 13,90	art.3222	Agrumi kg.2,5	(6)	€ 28,90	art.3114	Biomax kg.1	(12)	€ 12,90	art.3102	Bovisang kg.2	(6)	€ 22,90
art.3226	Conif. Arbu. Verdi kg.2,5	(6)	€ 21,90	art.3203	Ortaggi kg.1	(12)	€ 9,90	art.3204	Keeper T. Erb kg.1	(12)	€ 11,90	art.3122	Antimuschio kg.1,5	(8)	€ 11,90
				art.3105	Ortensie kg.1	(12)	€ 13,90	art.3227	Keeper T. Erb kg.2,5	(6)	€ 21,90	art.3117	Cycas gr.500	(20)	€ 9,90

Granulari in sacco



Linfa Concime

art.3768	Ortaggi Kg.5	(80)	€ 18,90	art.3770	Acidofile kg.5	(60)	€ 17,90
art.3765	Universale kg.5	(80)	€ 18,90	art.3769	Antimuschio kg.5	(95)	€ 16,90
				art.3771	Rose kg.5	(60)	€ 17,90

Suolovivo

art.8739	Kg.4	(65)	€ 12,90
----------	------	------	---------



Solubis busta

art.3115	gr.30	€ 2,20
----------	-------	--------

Ferrochelato

art.8010	gr. 50	(80)	€ 3,90
art.8017	gr. 500	(12)	€ 21,90

Idroionica

art.8016	ml 50	(96)	€ 5,90
----------	-------	------	--------

Nutristik

art.8008	pz.24	(60)	€ 6,90
art.8009	BIO pz.24	(60)	€ 6,90

Suolovivo

art.8038	ml 1200	(65)	€ 16,90
----------	---------	------	---------

Conifere

art.3226	Kg.2,5	(6)	€ 22,90
----------	--------	-----	---------

I PREZZI RIPORTATI SONO ESCLUSI DI IVA

Insetticidi PPO di libera vendita



Bado Spray

art.6231	Forte ml.150	(70)	€ 6,90	art.6224	Vespe ml.600	(20)	€ 11,90
art.6225	Mosche Zanz. ml.400	(18)	€ 6,90	art.6101	Ragni ml.400	(20)	€ 7,90
				art.6230	Pastiche Larve Zanz	(12)	€ 9,90

Bado Concentrato

art.6232	ml.100	(20)	€ 12,90	art.6242	lt. 1	(6)	€ 65,90
art.6237	ml.500	(12)	€ 36,90	art.6234	lt. 3	(6)	€ 183,90



Bado Pulci Zecche

art.6228	Pulci Zecche gr. 250	(24)	€ 6,90
art.6229	Pulci Zecche Kg. 1	(12)	€ 12,90
art.6248	Esca in grani	(12)	€ 12,90

Mastil

art.8014	gr. 300	(40)	€ 9,90
art.8015	Kg. 1,5	(12)	€ 22,90



Gel Formiche - Scarafaggi

art.6245	Formichei gr. 10	€ 9,90
art.6246	Scarafaggi gr. 10	€ 7,90

Bado

art.6227	CIMICI ml.500(24)	€ 10,90
art.6235	Formiche Scarafaggi ml. 500 (24)	€ 10,90



Stalpa

art.6220	ml. 1000	(12)	€ 19,90
art.6219	ml. 250		€ 9,90



Necorat Topi

art.6165	Grani MP gr. 150	(21)	€ 4,90
art.6170	Pasta MP gr. 150	(21)	€ 4,90
art.6172	Wax MP gr. 300	(21)	€ 6,90

Necorat Topi

art.6217	Colla ml.135 (42)	€ 3,90
art.6210	Tavolette incollate (2)	€ 7,90



Necorat Topi

art.6206	Tunnel	(24)	€ 6,90
art.6211	Dispenser	(10)	€ 9,90



Necorat Topi

art.6171	Pasta gr. 150	€ 2,90
----------	---------------	--------



Roris

art.7165	ml. 500 PRONTO USO	€ 8,90
art.7164	ml. 250	€ 9,90
art.7166	ml. 1000	€ 19,90



Olover Pronto Uso

art.7144	5x4 FIALE	€ 9,90	art.7147	ml. 250	€ 8,90
art.7146	ml. 100	€ 6,90	art.7148	ml. 1000	€ 15,90



Rame

art.8032	ml. 250 (20)	€ 7,90
art.8034	ml. 1000 (12)	€ 14,90

Biotiol

art.8040	Kg. 1 (12)	€ 11,90
art.8039	gr. 300 (20)	€ 6,90

Akamor

art.7142	ml. 1000 (12)	€ 19,90
art.7143	ml. 250 (20)	€ 8,90

Linfa Plus

art.8023	Plus ml. 100	pz.24	€ 8,90
art.8018	PRONTO USO ml. 500	pz. 16	€ 8,90
art.8042	ml. 500	pz.20	€ 23,90



Zolfo ramato

art.8045	gr. 100 (20)	€ 6,90
art.8041	PRONTO ml. 500 (16)	€ 8,90
art.8050	gr. 500 (16)	€ 12,90

Viren Rinverdente Curativo

art.8026	ml. 250 (20)	€ 8,90
----------	--------------	--------

Scudo Verde

art.8029	ml. 250 (20)	€ 10,90
----------	--------------	---------



Dora Olio di Neem

art.7490	ml. 100 (28)	€ 11,90
art.7500	ml. 250 (20)	€ 23,90
art.XXXX	ml. 5x4 fiale (20) Pronto Uso	€ 9,90

Cutis

art.7167	ml. 250 (20)	€ 8,90
----------	--------------	--------

Recis

art.8019	gr. 100	€ 6,90
----------	---------	--------



Linfa Spray Lucidanti

art.8013	Foglie ml.400 (18)	€ 6,90
art.8027	Foglie ml.600 (20)	€ 9,90
art.8028	Fiori ml.400 (18)	€ 6,90

Crema mani

art.8100	ml. 100 (48)	€ 6,90
----------	--------------	--------

Festa mani

art.8103	ml. 750 (12)	€ 8,90
----------	--------------	--------

Linfa Spray

art.6239	Pussavia Cani Gatti ml. 400 (18)	€ 8,90
----------	----------------------------------	--------

Solar

art.8024	ml. 100 (20)	€ 7,90
----------	--------------	--------

BadoGarden

art.6221	ml. 500	€ 22,90
----------	---------	---------



TANNINO 36%

art. CS5005 | ml. 750 | € 24,90

Aleavi

art. P0002 | ml. 200 (12) | € 16,90
art. P0003 | ml. 400 (12) | € 28,90

Aleavi è un erbicida totale non selettivo a base di acido Pelargonico. È attivo contro le infestanti mono e dicotiledoni, contro muschi e alghe siano esse annuali o perenni. Aleavi agisce esclusivamente per contatto. La sua azione si manifesta rapidamente (2-3 ore) portando all'essiccazione delle infestanti. Aleavi è completamente biodegradabile, non ha attività sistemica e residuale, di conseguenza non danneggia le radici delle piante trattate (alberi, arbusti).



Corno Torrefatto

art. 6870 | Kg. 1 | € 16,90

Tannino 36% stimola le difese naturali delle piante attivando meccanismi di resistenza nei confronti di numerosi patogeni, batteri, virus, ecc.

Viene impiegato con successo in numerosi ambiti agricoli quali orticoltura, frutticoltura, orticoltura, ornamentali, ecc.

Campi d'impiego: Orticole, frutticole ed ornamentali.

Si può applicare in tutte le fasi fenologiche tranne il periodo di fioritura.

Dose fogliare: ml 35-80 diluiti in 10 litri d'acqua.

In caso di marciumi radicali o del colletto è possibile applicare il prodotto alla base della pianta mantenendo la stessa diluizione.



HydroFood

Concime idrosolubile bilanciato, da materie prime purissime, esente da sodio, cloruri e carbonati.

La sua formulazione consente una rapida assimilazione degli elementi nutritivi. Idoneo per le colture con fabbisogni di NPK bilanciati.

Trova quindi applicazione in particolare nelle fasi iniziali e centrali dei cicli produttivi. La confezione contiene un misurino dosatore.

art. CM014 | Kg. 1 | € 22,90
art. HFA1 | gr. 400 | € 15,90



Osmocote Agrumi

Osmocote® Agrumi cede i propri nutrienti in modo costante ed equilibrato per l'intera stagione di crescita, è studiato per conferire agli agrumi maggior sapidità, favorire la fruttificazione e prevenire le carenze di ferro. Osmocote® Agrumi può andare a contatto con le radici senza nessun pericolo di ustioni. NUTRE PER 6 MESI ALTO IN FERRO FAVORISCE LA FRUTTIFICAZIONE

art. SEOSCIT | gr. 750 (12) | € 22,90



Osmocote Acidotile

Le elevate esigenze nutrizionali richieste dalle piante acidofile vengono soddisfatte pienamente da Osmocote® Ortensie che è in grado di cedere i nutrienti in modo costante ed equilibrato per l'intera stagione di crescita favorendo l'intensità e il prolungamento della fioritura. Può andare a contatto diretto con le radici della pianta senza pericolo di ustioni. NUTRE PER 6 MESI RAVVIVA I COLORI LUNGHE FIORITURE

art. SEOSHOR | gr. 750 (12) | € 22,90

Osmocote Universale

La tecnologia Osmocote® apporta elementi nutritivi assecondando i ritmi di crescita della pianta. Anche quando posto a contatto con le radici, evita pericolo di ustioni da sovradosaggio. Formulazione adatta per tutte le piante in vaso sia da interno sia da esterno. NUTRE PER 6 MESI NUTRIZIONE EQUILIBRATA STIMOLA LA CRESCITA

art. SEUSUNI | gr. 750 (12) | € 22,90



Max Liquido

Aci - Agru / Max liquido è la soluzione ideale per soddisfare le più importanti esigenze e sofferenze delle piante nel loro acro vegetativo, dalla caduta fogliare il disseccamento e precoci sfioriture.

Aci - Agru / Max liquido propone per ogni singola necessità il giusto apporto nutrizionale, garantendo fioriture abbondanti e uno sviluppo vegetativo equilibrato e duraturo.

art. | AgruMax | 18 | 500 ml | € 15,90
art. | AciMax | 18 | 500 ml | € 15,90





Solabiol Bio Liquido

Solabiol® con tecnologia Natural Booster è il concime ideale da applicare a piante in vaso e a terra. Grazie al mix di elementi nutritivi equilibrato e completo e al carbonio organico e composti biologicamente attivi estratti dalle alghe brune, Solabiol® con tecnologia Natural Booster favorisce una crescita equilibrata, un maggior sviluppo dell'apparato radicale e un maggior livello di fioritura e fruttificazione.

art. 86601453	Solabiol Bio Acidofile	12	1 lt	€ 11,90
art. 86601092	Solabiol Bio Agrumi	12	1 lt	€ 11,90
art. 86601095	Solabiol Bio Trapianti e Rinvasi	12	1 lt	€ 11,90
art. 86601091	Solabiol Bio Pianta Fiorite	12	1 lt	€ 11,90
art. 86601093	Solabiol Bio Aromatiche e Frutti	12	1 lt	€ 11,90
art. 86601094	Solabiol Bio Orticole	12	1 lt	€ 11,90



Solabiol Bio Granulare

Solabiol® con la speciale tecnologia Natural Booster promuove un maggior sviluppo dell'apparato radicale della pianta fino a farlo raddoppiare. Grazie ad un apparato radicale più sviluppato la pianta può arrivare a produrre fino al 50% di raccolto in più. Una pianta con radici più forti sarà anche più resistente all'attacco di insetti e parassiti. Fino al 50% di raccolto in più, 100% origine naturale, nutre 4 mesi, autorizzato in agricoltura biologica, maggiore assorbimento degli elementi nutritivi.

art. 86600000	Acidofile	12	1 lt	€ 14,90
art. 86600000	Agrumi	12	1 lt	€ 14,90
art. 86600000	Trapianti e Rinvasi	12	1 lt	€ 14,90
art. 86600000	Pianta Fiorite	12	1 lt	€ 14,90
art. 86600000	Aromatiche e Frutti	12	1 lt	€ 14,90
art. 86600000	Orticole	12	1 lt	€ 14,90



Nutri ONE

Nutri1ONE permette un migliore utilizzo della luce aiutando le piante ad adattarsi alle sue variazioni. I benefici sono molti: foglie più abbondanti e molto verdi e una fioritura straordinaria e prolungata. Agisce sulla fisiologia della pianta per favorire una crescita equilibrata delle parti aeree, foglie e fiori. Risultato: piante lussureggianti, più grandi, più belle, più forti!

Migliora lo sviluppo e la crescita delle radici permettendo alla pianta di assorbire meglio gli elementi nutritivi per una crescita sana. Radici forti e ben sviluppate garantiscono piante rigogliose.

art.	NutriONE Liquido	15	1 lt	€ 15,90
art.	NutriONE Liquido	24	500 ml	€ 12,90
art.	NutriONE Granulare	12	750 gr.	€ 15,90
art.	NutriONE Granulare	4	4 Kg.	€ 27,90



FINO ESAURIMENTO SCORTE

Cattura Insetti

La trappola adesiva Cattura Insetti è l'innovativa soluzione naturale per la cattura ed il monitoraggio della fillominatrice del pomodoro (Tuta absoluta) e della mosca bianca (Trialeurodes vaporarum). La trappola, oltre a richiamare naturalmente gli insetti grazie al suo colore giallo, contiene anche i 2 feromoni di attrazione specifici per gli insetti bersaglio che vengono quindi attirati e catturati nel foglio adesivo. La trappola è resistente alla pioggia e agli altri agenti atmosferici, garantendo fino a un mese di efficacia.



Cattura Insetti Trappola Olivo	12	€ 14,90
Cattura Insetti Trappola Bosso e Fiori	12	€ 14,90
Cattura Insetti Trappola Orticole	12	€ 14,90

Cattura Insetti Trappola Frutti	12	€ 14,90
Cattura Insetti Trappola Vite / Uva	12	€ 14,90
Cattura Insetti Trappola Agrumi	12	€ 14,90

Estratto di Ortica

Azione insetticida, particolarmente indicato contro larve di lepidottero e acari. Promuove la riduzione dell'infestazione e rafforza le pareti cellulari delle piante grazie agli acidi naturalmente presenti nella formulazione.

Pronto Uso (12)	ml. 750	€ 14,90
Concentrato (12)	Lt. 1	€ 16,90



Sapone Nero Lava Melata

Azione insetticida, particolarmente indicato contro afidi, cocciniglia, aleuroidi e e psille. Ideale per tutte le superfici fogliari ed in grado lavare melata e fumaggini.

Pronto Uso (12)	ml. 750	€ 14,90
Concentrato (12)	Lt. 1	€ 16,90



Lecitina e Olio di Soia

Prodotto 100% di origine naturale che potenzia le difese naturali delle piante rendendo la parete cellulare delle foglie più resistente agli attacchi fungini come oidio, ticchiolatura e ruggine. Si raccomandano applicazioni preventive.

SU FUNGHI: riduce la proliferazione delle spore fungine impedendo lo sviluppo di umidità sulle foglie

Lecitina di Soia Diluizione (12)	Lt. 1	€ 17,90
Lecitina di Soia Pronto (12)	Lt. 1	€ 14,90
Olio di Soia Diluizione (12)	Lt. 1	€ 17,90
Olio di Soia Pronto (12)	Lt. 1	€ 14,90



Insetticida Piretro

Solabiol Insetticida Abbattente è un insetticida pronto all'uso a base di Piretro naturale per la difesa di piante floreali e ornamentali. L'efficacia del principio attivo Piretro è esaltata dalla formulazione liquida a base di oli vegetali che ne migliorano la distribuzione e l'attività insetticida. Solabiol Insetticida Abbattente ha un ampio spettro d'azione ed è caratterizzato da una rapida efficacia nei confronti di numerosi parassiti, quali: afidi, acari, tripidi, mosche bianche, cocciniglie, larve di lepidotteri, coleotteri e cicaline.



Abbattente (12)	lt. 1	€ 21,90
Abbattente (12)	ml. 500	€ 16,90
Anticocciniglia (12)	lt. 1	€ 17,90

Olio di Neem

L'olio di neem potenzia la resistenza delle piante. Viene ottenuto dalla spremitura meccanica dei frutti dell'omonima pianta. Essendo ricco di acidi grassi aromatici essenziali, è adatto per trattamenti preventivi e rivitalizzanti in presenza di numerosi parassiti. L'olio di neem viene assorbito rapidamente dalla pianta, migliorandone lo stato salutare, svolgendo un'azione repellente verso insetti ad apparso boccale pungente succhiante e crittogame quali oidio, ticchiolatura, ruggine, ecc. Spruzzato sulle foglie le rinvigorisce e le protegge, mentre spruzzato nel terreno riequilibra la microflora, aumentando anche la presenza di lombrichi.



Olio di Neem (12)	lt. 1	€ 14,90
-------------------	-------	---------



Orto e Frutta (12)	gr. 250	€ 12,90
Orto e Frutta (12)	kg. 1	€ 18,90

Zeolite Cubana

Corroborante 100% naturale a base di roccia lavica per trattamenti consentiti in agricoltura biologica. La zeolite cubana ha azione preventiva e curativa su insetti e funghi che attaccano le colture dell'orto e del frutteto. La sua efficacia sta nel creare un ambiente ostile allo sviluppo dei patogeni grazie alla formazione di una vera e propria barriera meccanica.



Fungicida (12)	gr. 350	€ 12,90
----------------	---------	---------

Sodio Idrogeno Bicarbonato

Il bicarbonato di sodio è un derivato dell'acido carbonico, nota sostanza alcalinizzante. Applicato sulle piante aiuta a migliorare e potenziare le loro difese naturali, in quanto permette di tamponare e eliminare l'acidità degli essudati dei parassiti svolgendo un'ottima azione di aiuto per contrastare numerose malattie funginee come i marciumi radicali o del colletto e la ticchiolatura.

Herbiclean Erbicida PPO

Solabiol Herbiclean è un'erbicida pronto all'uso, totale e non residuale a base di acidi grassi comunemente presenti in natura. Herbiclean ha una rapida azione fogliare: nel giro di poche ore tutte le foglie bagnate dal prodotto ingialliscono e muoiono. Agisce sulle parti verdi delle piante e non su quelle lignificate, quindi risulta ideale per il diserbo sottochioma di alberi e arbusti. Inoltre è indicato per tenere puliti vialetti e bordure e per pulire dal muschio pavimentazioni e arredi del giardino in pietra o cemento, nonché tronchi esposti a nord.

Pronto Uso (12)	lt. 1	€ 20,90
Pronto Uso (4)	lt. 3	€ 42,90
Belouka Conc. (12)	ml. 150	€ 18,90

VespeX aerosol

Vespa aerosol (12)	ml. 750	€ 14,90
--------------------	---------	---------

Insetticida pronto all'uso studiato per il controllo di vespe e insetti volanti in ambito domestico. Agisce rapidamente ed è ideale per l'utilizzo in aree esterne come balconi, terrazzi e giardini, garantendo un'azione efficace e mirata per una protezione immediata della casa.

Vespa Stop schiuma

Vespa schiuma (12)	ml. 750	€ 14,90
--------------------	---------	---------

Insetticida schiumogeno pronto all'uso, specifico per l'eliminazione di vespe e nidi. La schiuma ad alta adesività permette di raggiungere e coprire efficacemente il nido, garantendo un'azione rapida e mirata anche in punti difficili, per una protezione sicura degli ambienti domestici.

"... se puoi sognarlo puoi farlo ..."



Rame & Zolfo (12)	lt. 1	€ 14,90
-------------------	-------	---------

Rame Zolfo

È un nuovo concime liquido in sospensione impiegato per correggere rapidamente le carenze di Rame, Manganese e Zolfo. RAME ZOLFO apporta Zolfo, elemento fondamentale per la sintesi proteica e la qualità organolettica di colture orticole, frutticole e industriali. Il Rame e il Manganese sono microelementi indispensabili per la sintesi della clorofilla, degli ormoni vegetali e per la riduzione dei nitrati. La sinergia dei due microelementi migliora lo stato fisiologico e sanitario delle colture, l'attività fotosintetica e la produttività delle piante.



Lumachida

Lumachida granulare pronto all'uso, specifico per il controllo efficace di lumache e limacce in orti, giardini e aree verdi. La sua formulazione a base di sostanze di origine naturale consente di proteggere le colture in modo efficace nel rispetto dell'ambiente. I granuli sono resistenti all'umidità e facilmente distribuibili, garantendo un'azione prolungata e risultati visibili in breve tempo. Indicato per l'uso su piante ornamentali e colture orticole.



Lumachida (24)	gr. 200	€ 8,90
----------------	---------	--------



Cyperbase Concentrato

Insetticida	ml. 250 (12)	€ 22,90
Insetticida	lt. 1 (12)	€ 52,90



Offly In&Out per esterno

Insetticida	ml. 750 (12)	€ 13,90
-------------	--------------	---------



Fast Kill Mosche e Zanzare

Insetticida	ml. 400 (12)	€ 7,90
-------------	--------------	--------



Forminix

Forminix Esca Formiche si impiega per la lotta contro le formiche ed in particolare contro le formiche dei giardini che infestano gli ambienti domestici, i terrazzi, i balconi e tutte le superfici circostanti alle abitazioni. L'esca è costituita da Imidacloprid (principio attivo insetticida) e da un attrattivo alimentare a base di zucchero che induce le formiche operaie a portare il prodotto nel formicaio e a utilizzarlo come alimento per l'intero nido. Con l'ingestione si ha ben presto la totale distruzione del formicaio. Forminix Esca Formiche è disponibile in confezioni provviste di tappo salva bimbo e misurino dosatore.

Formiche Esca (20)	gr. 200	€ 12,90
Formiche Esca (12)	gr. 500	€ 20,90



Formiche Polvere (12)	gr. 375	€ 14,90
-----------------------	---------	---------

Bixan

BIXAN 0.25 MG è un prodotto in micro-granuli bagnabili d'uso professionale per il controllo a lungo termine di scarafaggi (Blattella Germanica, B. Americana, e B. Orientalis), formiche (Formica nera, formica argentina, formica faraone), pulci e zecche. BIXAN 0.25 MG agisce pochi minuti dopo l'applicazione, è inodore.



Formiche e Striscianti (12)	gr.500	€ 16,90
-----------------------------	--------	---------



Fastion Formiche e Scarafaggi

Insetticida	ml. 400 (12)	Beccuccio	€ 11,90
-------------	--------------	-----------	---------



Fastion AL Formiche e Scarafaggi

Insetticida	lt. 1 (12)	€ 15,90
-------------	------------	---------



Formiche Tubetto (12)	box 2	€ 13,90
-----------------------	-------	---------

Forminix Esca

Insetticida in gel liquido pronto all'uso. Rapidamente efficace contro le principali specie di formiche infestanti, è altamente attrattivo ed agisce anche all'interno del formicaio. Facile da usare: è sufficiente posizionare una goccia lungo i percorsi delle formiche e le operaie attratte dal gel se ne nutrono e lo trasportano al nido, dove Forminix gel formiche porta all'eliminazione dell'intera colonia.

Forminix Esca

Insetticida in gel liquido confezionato in trappolina (Box) in PE blu trasparente. Forminix® gel formiche è altamente attrattivo verso tutte le principali specie di formiche che infestano gli ambienti domestici. Il formulato in gel liquido mantiene a lungo la sua azione attrattiva e una volta attivato viene trasportato nel formicaio che sarà eliminato nel giro di qualche settimana. Per attivarlo è sufficiente premere al centro della trappolina: non occorre creare le aperture per il passaggio delle formiche. Un trattamento dura fino a 90 giorni



Trappole Interno (12)	box 2	€ 10,90
Trappole Esterno (12)	box 2	€ 10,90



Fastion Gel Scarafaggi

Insetticida	g. 5 (12)	€ 12,90
Esca 2 trappole	2 pz. x 4 gr. (12)	€ 10,90



Etomatic Autosvuotante

Insetticida	ml. 150 (12)	€ 13,90
-------------	--------------	---------



"...vale più una parola al momento giusto che cento al momento sbagliato"

Fito goccia goccia

Universale (24)	€ 10,90
Piante Verdi (12)	€ 10,90
Acidofile (12)	€ 10,90
Bonsai (12)	€ 10,90
Orchidee (24)	€ 10,90
Piante Grasse (12)	€ 10,90





Sanium PFnPO

SANIUM AL PFnPO è l'innovativo insetticida sistemico concentrato per il controllo efficace di insetti ad apparato boccale pungente succhiante come afidi, cocciniglie e mosca bianca sulle piante floreali ed ornamentali. Sintetizzato a partire dalla pianta *Stemona Japonica*, il principio attivo FLUPYRADIFURONE blocca il sistema nervoso degli insetti provocandone l'arresto. La nuova famiglia di appartenenza del principio attivo (BUTENOLIDI) lo rende efficace anche laddove si siano sviluppati fenomeni di resistenza da parte dei tradizionali principi attivi sistemici (IRAC 4D). Il principio attivo di nuova generazione si muove dalla parte inferiore a quella superiore della pianta (mobilità acropeta) e passando da una parte all'altra delle foglie (mobilità translaminare). L'azione sistemica permette quindi al principio attivo di raggiungere anche le parti più difficili della pianta proteggendo anche la vegetazione che si sviluppa dopo il trattamento. Una sola applicazione del prodotto protegge quindi la pianta per tutta la stagione. Il principio attivo viene assorbito rapidamente dalla pianta resistendo quindi al dilavamento.

Insetticida ml. 800	12	€ 18,90	Giardino ml. 5	12	€ 12,90
Insetticida ml. 500	12	€ 14,90	Anticocciniglia ml. 5	12	€ 12,90
Anticocciniglia ml. 800	12	€ 18,90	Pin Pasticche pz. 10	12	€ 11,90
			Pin Pasticche pz. 20	12	€ 16,90

Rasikal Green Erbicida

Erbicida pronto all'uso studiato per il controllo efficace delle infestanti annuali e perenni in ambito domestico. Indicato per l'impiego su vialetti, cortili, bordure, marciapiedi e superfici non coltivate, agisce per contatto sulle parti verdi della pianta, provocandone il disseccamento. La formulazione a base di sostanze di origine naturale consente un utilizzo mirato nel rispetto dell'ambiente. Non è selettivo e non presenta attività residuale nel terreno, permettendo il riutilizzo delle superfici trattate dopo l'azione erbicida. Pronto all'uso, non richiede diluizione ed è facile da applicare grazie allo spruzzatore manuale. I risultati sono visibili in tempi rapidi, in funzione delle condizioni ambientali e dello stadio di sviluppo delle infestanti.



"...essere se stessi in un mondo che cerca sempre di cambiarti, è la più grande delle conquiste"

Erbicida Pronto Uso Lt. 1	12	€ 19,90
Erbicida Pronto Uso Lt. 2,5	4	€ 39,90
Erbicida Concentrato ml. 360	12	€ 19,90

Bayfolan Liquido

Bayfolan liquido ormai storico e consolidato concime di qualità, grazie al suo alto titolo in elementi nutritivi, alla qualità delle materie prime utilizzate e al contenuto in microelementi, è in grado di fornire risultati sorprendenti. Bayfolan liquido propone per ogni singola necessità il giusto apporto nutrizionale, garantendo fioriture abbondanti e uno sviluppo vegetativo equilibrato.

FINO ESAURIMENTO SCORTE

art. 86601452	Bayfolan Gerani e Piante Fiorite	12	1 lt	€ 9,90
art. 86601450	Bayfolan Piante Verdi	12	1 lt	€ 9,90
art. 86601449	Bayfolan Universale	12	1 lt	€ 9,90
art. 86601451	Bayfolan Agrumi	12	1 lt	€ 9,90



Giardino pensile estensivo



Vantaggi giardino pensile estensivo

- Stratigrafie con spessori ridotti.
- Impiego di piante o erbe a basso fusto, autopropaganti e autorigeneranti.
- Non necessita di particolare manutenzione.
- Realizzazione di un impianto di irrigazione non necessario.
- Minore peso sulla copertura.
- Minori costi di realizzazione e manutenzione.
- Impiego su piani ed inclinati fino a 30°.
- Capannoni industriali ed artigianali.
- Centri commerciali.
- Garage sotterranei.
- Box condominiali.

Giardino pensile (o verde pensile) estensivo è una tipologia di copertura verde per superfici medio-grandi, con capacità di carico ridotta, che non necessita di particolari costi di realizzazione e manutenzione dato il substrato di spessore limitato e la tipologia di vegetazione appartenente a specie molto resistenti e con radici poco profonde (graminacee, sedum, erbacee perenni).

Può essere applicato su coperture piane o inclinate (fino a 30°), ed è particolarmente indicato per i tetti di edifici industriali, commerciali, centri direzionali e coperture di garage.

Dal punto di vista economico rappresenta una valida soluzione anche per la copertura di complessi residenziali e abitazioni monofamiliari.

Generalmente non è una copertura di tipo fruibile, ma svolge un ruolo soprattutto di mitigazione e compensazione ambientale in contesti fortemente urbanizzati.

La certezza di una minor dispersione del calore durante la stagione invernale ma soprattutto un elevato e naturale raffrescamento nei periodi estivi, fa del giardino pensile estensivo con Iglu® Green Roof la soluzione ideale anche per coperture poco fruibili da rinverdire.

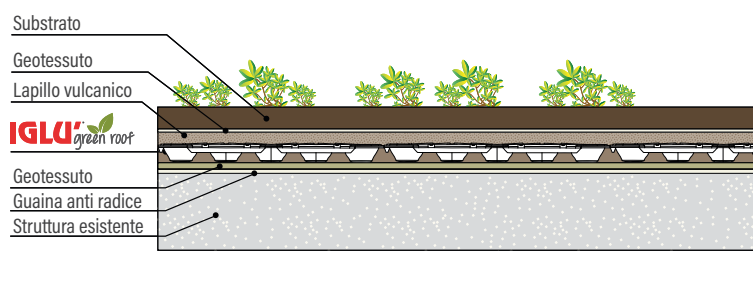



Sistemi per giardini pensili



“... un vincitore è un sognatore che non si è mai arreso ...”

Giardino Pensile

art. IGLU' 05 | Pannello Iglù cm. 58x58x5h (conf. minime mq. 50) cad. pannello

€ 47,50

I PREZZI RIPORTATI SONO ESCLUSI DI IVA



PROFILI PROFESSIONALI AIUOLE CON PICCHETTI

ART.	MIS. ELEM. cm.	CO.	PREZZO
3487	mt.5x cm12,5H (in PE con picchetti)	4	€ 59,90





La linea Bordure Verdecor offre una gamma di bordi ornamentali flessibili, ideali per contenere prodotti da pacciamatura e/o terricci oltre a delimitare le diverse aiuole, aggiungendo un tocco di eleganza e personalità al tuo giardino. Disponibili in metallo leggero ideale per le diverse esigenze funzionali del lavoro.

Dimensioni barra: 5m x h 15cm

Colore barra: tipo carten

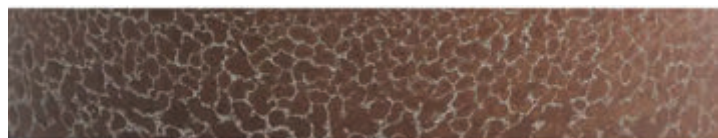

PROFILI PROFESSIONALI AIUOLE

ART.	MIS. ELEM.	CO.	PREZZO
3513	mt.5x cm15H (metallo)	4	€ 69,90

La linea Bordure Verdecor offre una gamma di bordi ornamentali flessibili, ideali per contenere prodotti da pacciamatura e/o terricci oltre a delimitare le diverse aiuole, aggiungendo un tocco di eleganza e personalità al tuo giardino. Disponibili in diversi materiali come PE e PP, questi bordi sono progettati per soddisfare diverse esigenze estetiche e funzionali.

Realizzati con materiali di alta qualità e riciclabili come PP e PE, non solo abbelliscono il tuo spazio esterno, ma contribuiscono anche alla sostenibilità ambientale. Perfetti per definire e decorare i tuoi spazi verdi, questi bordi ornamentali combinano estetica e praticità, rendendo ancora più semplice trasformare il tuo giardino in un angolo di bellezza e ordine.



PROFILI PROFESSIONALI AIUOLE

ART.	MIS. ELEM.	CO.	PREZZO
3506	mt.5x cm12H (in PE)	1	€ 59,90
3507	mt.10x cm12H (in PE)	1	€ 115,90
000705	mt.25x cm14H (spessore 7mm) (in PE)	1	€ 169,90
3509	Picchetto di sostegno (busta 5pz) (in PE)	5	€ 21,90

I PREZZI RIPORTATI SONO ESCLUSI DI IVA

Ciottolo



Bianco Carrara	
Granulometria 12/16 Sacchetto KG 25	€ 10,90



Bianco Carrara	
Granulometria 7/15 Sacchetto KG 10	€ 6,10
Granulometria 7/15 Sacchetto KG 25	€ 10,90



Bianco Carrara	
Granulometria 15/25 Sacchetto KG 10	€ 6,10
Granulometria 15/25 Sacchetto KG 25	€ 10,90



Bianco Carrara	
Granulometria 25/40 Sacchetto KG 25	€ 10,90



Bianco Carrara	
Granulometria 40/60 Sacchetto KG 25	€ 10,90

Ciottolo



Rosso Verona	
Granulometria 12/16 Sacchetto KG 25	€ 14,50



Rosso Verona	
Granulometria 7/15 Sacchetto KG 10	€
Granulometria 7/15 Sacchetto KG 25	€ 14,50



Rosso Verona	
Granulometria 15/25 Sacchetto KG 10	€
Granulometria 15/25 Sacchetto KG 25	€ 14,50



Rosso Verona	
Granulometria 25/40 Sacchetto KG 25	€ 14,50



Rosso Verona	
Granulometria 40/60 Sacchetto KG 25	€ 14,50

Ciottolo



Nero Ebano	
Granulometria 12/16 Sacchetto KG 25	€ 14,50



Nero Ebano	
Granulometria 7/15 Sacchetto KG 10	€
Granulometria 7/15 Sacchetto KG 25	€ 14,50

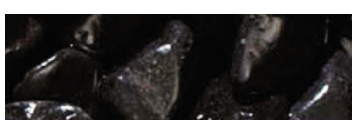

Nero Ebano	
Granulometria 15/25 Sacchetto KG 10	€
Granulometria 15/25 Sacchetto KG 25	€ 14,50

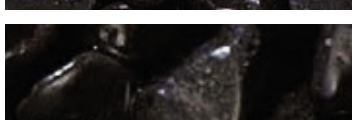

Nero Ebano	
Granulometria 25/40 Sacchetto KG 25	€ 14,50

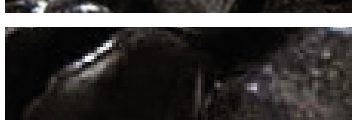

Nero Ebano	
Granulometria 40/60 Sacchetto KG 25	€ 14,50

Ciottolo



Giallo Siena	
Granulometria 12/16 Sacchetto KG 25	€ 14,50



Giallo Siena	
Granulometria 7/15 Sacchetto KG 10	€
Granulometria 7/15 Sacchetto KG 25	€ 14,50



Giallo Siena	
Granulometria 15/25 Sacchetto KG 10	€
Granulometria 15/25 Sacchetto KG 25	€ 14,50



Giallo Siena	
Granulometria 25/40 Sacchetto KG 25	€ 14,50



Giallo Siena	
Granulometria 40/60 Sacchetto KG 25	€ 14,50

Ciottolo



Verde Alpi	
Granulometria 12/16 Sacchetto KG 25	€ 14,50



Verde Alpi	
Granulometria 7/15 Sacchetto KG 10	€
Granulometria 7/15 Sacchetto KG 25	€ 14,50



Verde Alpi	
Granulometria 15/25 Sacchetto KG 10	€
Granulometria 15/25 Sacchetto KG 25	€ 14,50



Verde Alpi	
Granulometria 25/40 Sacchetto KG 25	€ 14,50



Verde Alpi	
Granulometria 40/60 Sacchetto KG 25	€ 14,50

Ciottolo



Rosa Corallo	
Granulometria 12/16 Sacchetto KG 25	€ 14,50



Rosa Corallo	
Granulometria 7/15 Sacchetto KG 10	€
Granulometria 7/15 Sacchetto KG 25	€ 14,50



Rosa Corallo	
Granulometria 15/25 Sacchetto KG 10	€
Granulometria 15/25 Sacchetto KG 25	€ 14,50



Rosa Corallo	
Granulometria 25/40 Sacchetto KG 25	€ 14,50



Rosa Corallo	
Granulometria 40/60 Sacchetto KG 25	€ 14,50



ROCCIA CALCAREA SPUGNOSA "TRANI"

ART.	MIS. cm.	CO.	PREZZO
RCCALCARE	COME INDICATO	100	€ 0,80 al Kg.

Esemplari di rocce calcaree tipo travertino dalla forma irregolare. Pezzature possibili, 80/120mm, 120/180mm, 180/250mm, 250/500mm.
Perso bancale indicativo 1800 Kg.
Ogni bancale contiene una singola misura.

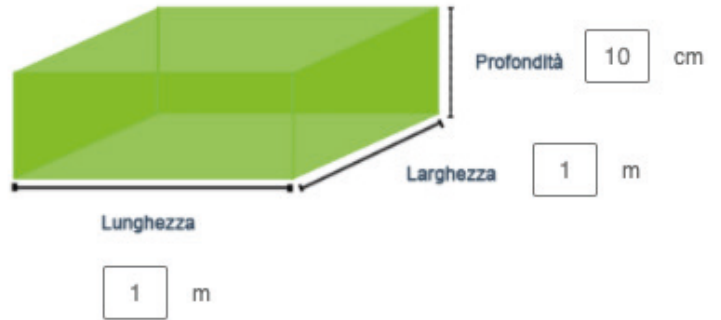
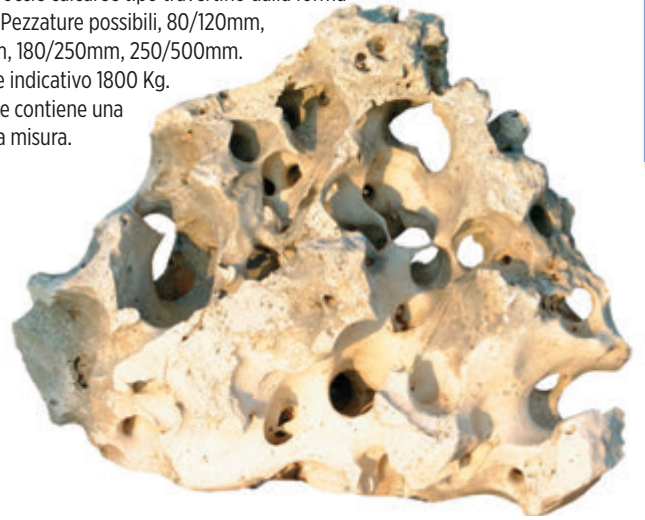

Bozze di Tufo

Cod.	cm. 37x11x11	€ 2,50
Cod.	cm. 37x20x11	€ 2,80
Cod.	cm. 37x27x11	€ 3,50

Per realizzare 1 mt. per 1 mt. con spessore 10 cm. servono 6 sacchetti di ciottolo da 25Kg.



Pezzatura indicativa 60/100



Pezzatura indicativa 100/150

"...l'unico modo per iniziare a fare qualcosa è smettere di parlare e iniziare a fare..."



Pezzatura indicativa 150/250



Pezzatura oltre i 250 viene definito roccia o monolite. Su richiesta.

COITTOLO IN MONOLITE

ART.	MIS. cm.	CO.	PREZZO
RCCALCARE	COME INDICATO	100	€ 0,80 al Kg.

Cesta in ciottolo a bordo tondo costituita da una sola pezzatura. Per ogni mq necessita ca 70/80 kg.
Ogni cesta ca. 20 mq.
Perso bancale indicativo 1500 Kg.



LE FOTO RAPPRESENTANO ALCUNE POSSIBILI REALIZZAZIONI I MONOLITI, APPARTENGONO AD UNA ESTRAZIONE SU TERRITORIO NAZIONALE OPPURE PROVENIENTI DA PAESI DI TUTTO IL MONDO.





BARBISELF GEOTESSILE NONTESSUTO POLIPROPILENE PER PACCIAMATURA gr.100 mq

Art.	Misura	Tipo	Disp.	Q.tà	Prezzo
BARBISELF100	mt 10L x cm 100H	Bobina	Mag.	1	€ 39,90
BARBISELF200	mt 10L x cm 200H	Bobina	Mag.	1	€ 73,90

BARBIDREN GEOTESSILE POLIESTERE PER GIARDINI PENSILI, FIORIERE gr.200 mq

Art.	Misura	Tipo	Disp.	Q.tà	Prezzo
BARBIDRENAGVC100	mt 50L x cm 100H	Bobina	Mag.	1	€ 115,90
BARBIDRENAGVC200	mt 50L x cm 200H	Bobina	Mag.	1	€ 229,90

HOASI TELO TECNICO PER PACCIAMATURA PROFESSIONALE MUSCHIO

Art.	Misura	Tipo	Disp.	Q.tà	Prezzo
HOASIMUSCHIO100	mt 50L x cm 100H	Bobina	Mag.	1	€ 299,90
HOASIMUSCHIO200	mt 100L x cm 200H	Bobina	Mag.	1	€ 585,90

HOASI TELO TECNICO PER PACCIAMATURA PROFESSIONALE ECOCANAPA

Art.	Misura	Tipo	Disp.	Q.tà	Prezzo
HOASIECOCANAPA100	mt 50L x cm 100H	Bobina	Mag.	1	€ 241,90
HOASIECOCANAPA200	mt 100L x cm 200H	Bobina	Mag.	1	€ 475,90

HOASI TELO TECNICO PER PACCIAMATURA PROFESSIONALE BASIC

Art.	Misura	Tipo	Disp.	Q.tà	Prezzo
HOASIBASIC100	mt 50L x cm 100H	Bobina	Mag.	1	€ 165,90
HOASIBASIC200	mt 100L x cm 200H	Bobina	Mag.	1	€ 325,90

BARBICUT FORBICE PROFESSIONALE PER TAGLIARE TESSUTI PACCIAMANTI E TAPPETI ERBOSI

Art.	Misura	Tipo	Disp.	Q.tà	Prezzo
BARBICUT			Mag.	1	€ 46,90

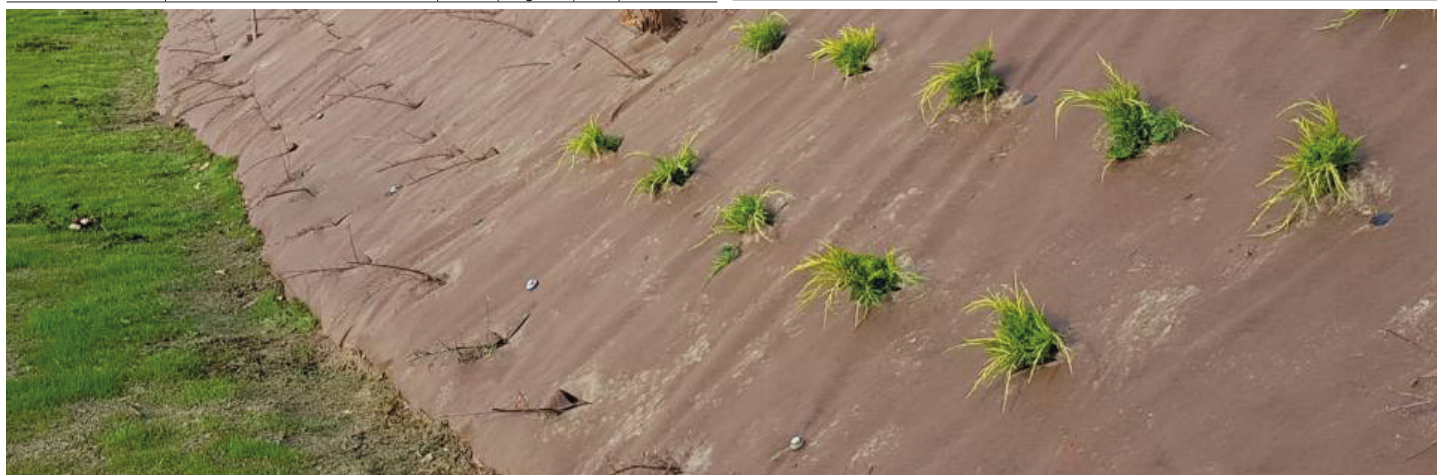



Condizioni generali di fornitura:

- 1) Il presente listino indica i prezzi iva esclusa.
- 2) Il presente listino annulla e sostituisce ogni precedente.
- 3) I dati riportati in questo listino prezzi sono da considerarsi indicativi e dimostrativi, soggetti a possibili variazioni senza preavviso, secondo le indicazioni delle aziende produttrici.
- 4) Gli ordini vengono assunti con riserva di approvazione di Bartolini Angelo sas. I prezzi e le condizioni in vigore alla data del ricevimento dell'ordine verranno confermati da Bartolini Angelo sas.
- 5) Bartolini Angelo sas azienda al commercio ingrosso/dettaglio si riserva la facoltà di modificare i prezzi di questo listino in caso di sensibili aumenti delle materie prime, dell'energia e dei trasporti, secondo le indicazioni delle aziende produttrici.
- 6) I termini di consegna degli ordinativi si intendono indicativi e non hanno valore tassativo. Bartolini Angelo sas si riserva pertanto di comunicare eventuali modifiche alla data di consegna.
- 7) Bartolini Angelo sas si riserva il diritto di annullare o consegnare parzialmente gli ordini assunti, sia per disponibilità di magazzino/produzione, sia per motivi inerenti al cliente.
- 8) Per ogni competenza sarà competente esclusivo il foro di Firenze.



Behristmas





DAL 17 OTTOBRE 2026
GRANDE ESPOSIZIONE NATALIZIA



