

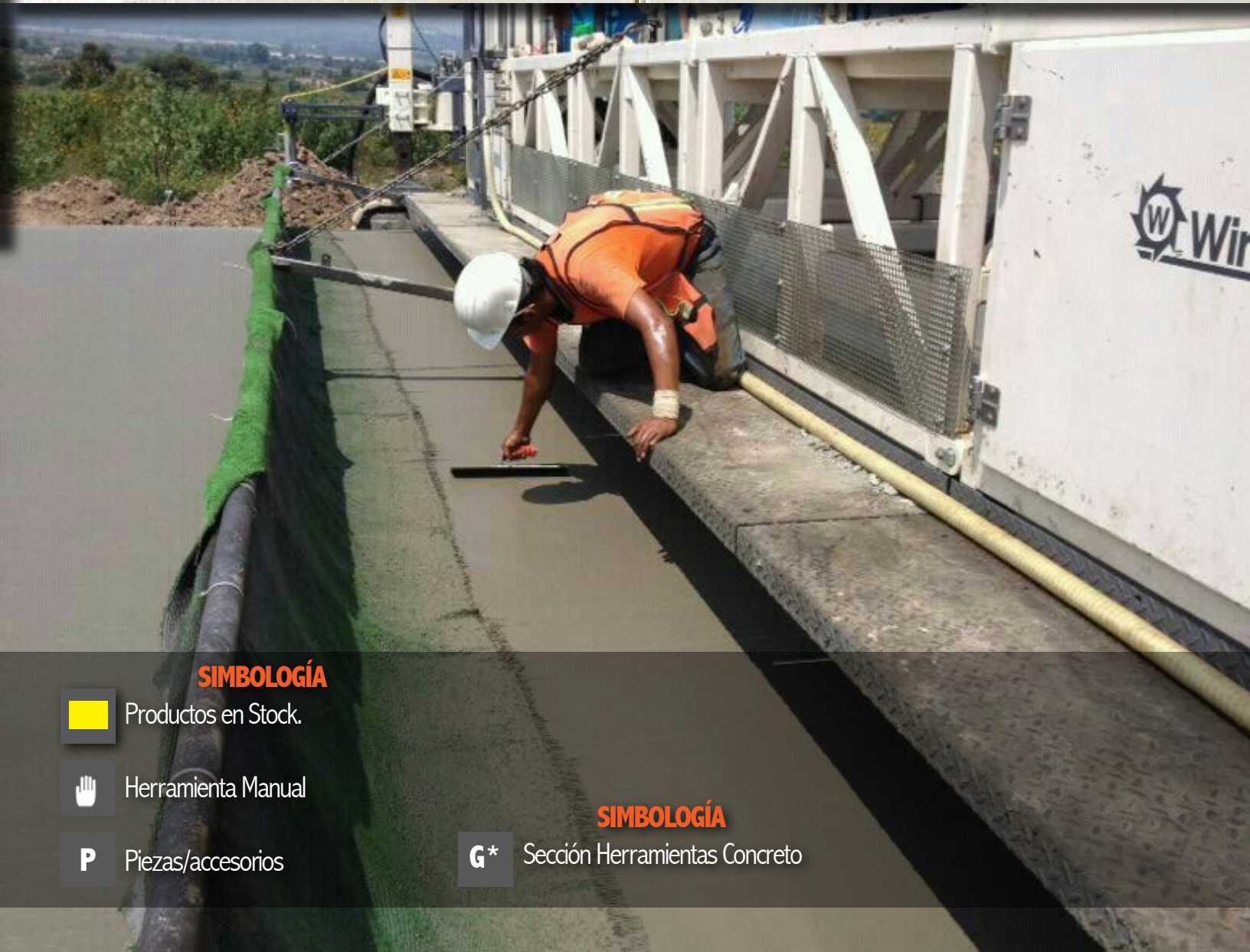



HERRAMIENTAS

PARA CONCRETO/ASFALTO/RECUBRIMIENTOS



SIMBOLOGÍA

 Productos en Stock.

 Herramienta Manual

P Piezas/accesorios

SIMBOLOGÍA

G* Sección Herramientas Concreto

ÍNDICE SECCIÓN G*

SECCIÓN HERRAMIENTAS PARA CONCRETO

CONCRETO - VIBRADOR FLOTA MAGVIBE	5
CONCRETO - FLOTA BULL / FLOTA CANAL	6-7
CONCRETO - LLANA / RANURADOR / ESQUINERO	8
CONCRETO - LLANA MANUAL	9
CONCRETO - FLOTA MANUAL	10
CONCRETO - RANURADOR / ORILLADOR MANUAL	11
CONCRETO - BUMP CUTTER / AUSSI / VIGETA	12
CONCRETO - TEXTURIZADOR / CEPILLO	13
CONCRETO - JALADOR / RODILLO / APASIONADOR	14
CONCRETO - ADAPTADORES	15
CONCRETO - EXTENSIONES / HANDLES / ADAPTADOR	16
CONCRETO - ADAPTADORES	17
CONCRETO - LLANA ACABADO / COMBINACIÓN	18
CONCRETO - DISCO DE FLOTADO	19
ASFALTO - JALADOR / ESPATULA / RASTRILLO	20
RECUBRIMIENTOS - NAP ROLLER / FRAME / ENDS	21
RECUBRIMIENTOS - SQUEEGEE TROWEL / ALUMINIUM	22
RECUBRIMIENTOS - RODILLO PICOS / NIVELADOR	23
RECUBRIMIENTOS - SANDALIAS / DESLIZADORES / RODILLERAS	24



HERRAMIENTAS PARA CONCRETO



MAG VIBE Adaptador Vibrador para flotas

Chassis specifications

Material Laser cut aluminum

Thickness 8 ga (1/8" thick)

Motor

Motor type 18 Volt Variable Speed

Maximum Speed 5,000 RPM

Control Type Variable Speed
Potentiometer

Battery Performance

Battery 18 Volt Lithium

Capacity 5,800 mAh

Overall Dimensions

Weight 10 Pounds

Length 21"

Width 6 7/8"

Height 4"

Mag Vibe Package #Parte MV-100
(includes 1-mounting plate, 1-18 volt battery charger)
Mounting plate #Parte MV-101
18 Volt Rechargeable battery #Parte MV-18B
18 Volt battery charger #Parte MV-18C
18 Volt Lithium battery #Parte MV-18L
Lithium Battery charger #Parte MV-LC
250 Watt Inverter car charger #Parte MV-250V
450 Watt Inverter car charger #Parte MV-450V
Remote Control #Parte MV-R
Rubber vibration Mounts (set of four) #Parte MV-RM

¡Deja que la vibración haga todo el trabajo!

MagVibe

Incrementa tu productividad, convirtiendo cualquier flota en un vibrador, ajusta la velocidad de vibración, cuadro de aluminio resistente a la corrosión adaptable a tus flotas sin necesidad de instalación.

¡Checa el video!

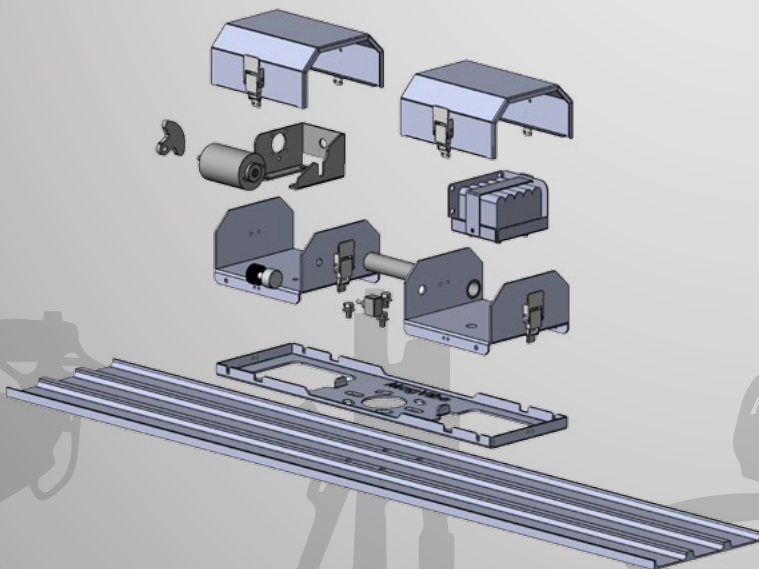

HERRAMIENTAS PARA CONCRETO

FLOTA BULL Puntas Cuadradas

B)



*El cabezal se vende por separado.

COMPATIBLE

MagVibe

- A) De Magnesio 48"x8" #Parte **KTCC802-01**
B) Ranurada 48"x7-1/4" Separador 1/2" #Parte **KTCC787**

A)



FLOTA BULL Puntas Redondas

#Parte **KTCC941**

ADAPTADOR



- De Magnesio 48"x8" #Parte **KTCC803-01**
De Magnesio 60"x8" #Parte **KTCC804-01**
De Magnesio 72"x8" #Parte **KTCC808-01**



FLOTA BULL De Madera Laminada

COMPATIBLE

MagVibe

- Madera 48"x7-1/4" #Parte **KTCC782-01**



*El cabezal se vende por separado.

COMPATIBLE

MagVibe

HERRAMIENTAS PARA CONCRETO

FLOTA BULL Big "D" flotador de acero azul

COMPATIBLE

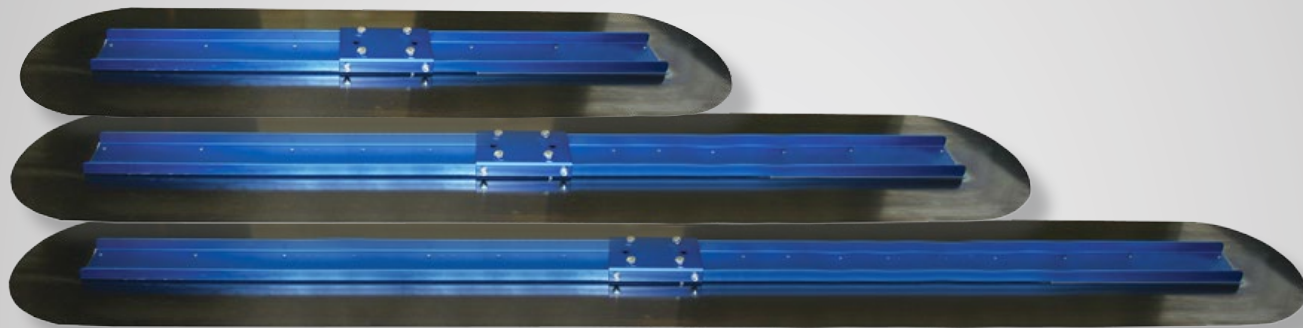
MagVibe

P

48"x12" #Parte KTCC750

60"x12" #Parte KTCC749

72"x12" #Parte KTCC751

FLOTA CANAL Puntas Redondas

COMPATIBLE

MagVibe

P

De Magnesio 48"x6" #Parte KTCC044

De Magnesio 60"x6" #Parte KTCC045

De Magnesio 72"x6" #Parte KTCC046

120"x6" Adaptador, ext. botón/soportes #Parte KTCC050

HERRAMIENTAS PARA CONCRETO

LLANA FRESNO Acero al carbón

			P
24"x5"	#Parte	KTCC830-01	
36"x5"	#Parte	KTCC832-01	
48"x5"	#Parte	KTCC834-01	



*El cabezal se vende por separado.

ADAPTADOR

#Parte KTCC626



RANURADOR Multi-Trac Fresno

			P
36"x5", 3/4" ranuras, 1/4" grosor, 1/4" profun.	#Parte	KTCC878	
48"x5", 3/4" ranuras, 1/4" grosor, 1/4" profun.	#Parte	KTCC889	

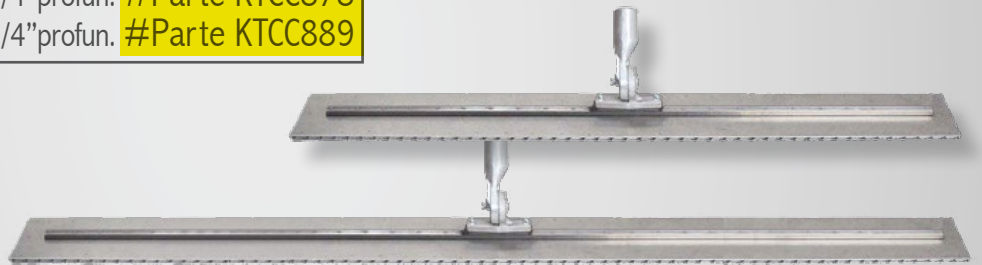

*El cabezal se vende por separado.

RANURADOR De pie Acero inox.

			P
8"x8" de 3/4", 1" Width 1/2" Radius	#Parte	KTCC021-01	
8"x5" de 1", 3/4" Width 3/8" Radius	#Parte	KTCC357	

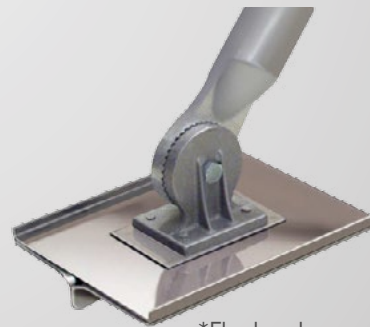

*El cabezal se vende por separado.

ESQUINERO De pie

			P
Multiangulo 8"x6", 3/4 Radius 7/8" Orilla	#Parte	KTCC104	
De bronce 6"x4", 1/4 Radius 5/8" Orilla	#Parte	KTCC313	



*El mango se vende por separado.

HERRAMIENTAS PARA CONCRETO



LLANA ACERO Rectangular, mango PRO



P

10"x3" #Parte KTCF201PF
 14"x4" #Parte KTCF217PF
 16"x4" #Parte KTCF222PF
 18"x4 1/2" #Parte KTCF228PF



LLANA ACERO Puntas Redondas, mango PRO



P

Al carbono 14"x4" #Parte KTCF446PF
 Al carbono 16"x4" #Parte KTCF447PF
 Al carbono 18"x4" #Parte KTCF448PF
 Al carbono 14"x4" #Parte KTCF437PF
 Al carbono 16"x4" #Parte KTCF438PF

ADAPTADOR

#Parte KTCC658



LLANA ACERO AZUL Redonda



P

24"x5" #Parte KTCF297PF

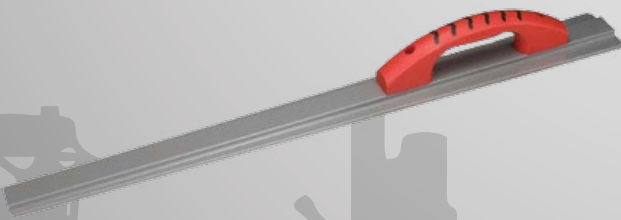

LLANA DE MAGNESIO Acabado Cónico



P

30", 3 1/8" Wide 1 7/8" Toe #Parte KTCF030

HERRAMIENTAS PARA CONCRETO

FLOTA MAGNESIO Puntas Cuadradas, mango PRO

			P
14"x3 1/4"	#Parte KTCF014PF		
16"x3 1/4"	#Parte KTCF016PF		



FLOTA MAGNESIO Puntas Redondas, Mango PRO

			P
16"x3 1/4"	#Parte KTCC076PF		



FLOTA RESINA LAMINA Puntas Cuadradas

			P
16"x3 1/2"	Mango PRO #Parte KTCC505PF		

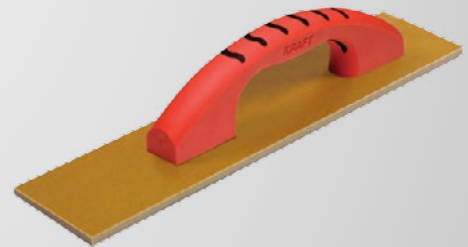

FLOTA MADERA TRATADA Puntas Cuadradas

			P
16"x3"	Mango PRO #Parte KTCC643PF		



HERRAMIENTAS PARA CONCRETO



RANURADOR BRONCE 7 1/2"x4 1/2" Mango PRO



P

1 1/2" profundidad, 1/2" grosor, 1/4" radio #Parte KTCF317PF



ORILLADOR ACERO INOXIDABLE Mango PRO



P

6"x3", 1/8" radio, 1/4" profundidad #Parte KTCF170PF

6"x3", 3/8" radio, 1/2" profundidad #Parte KTCF092PF

6"x6", 1/4" radio, 3/8" profundidad #Parte KTCF137PF

6"x6", 3/8" radio, 1/2" profundidad #Parte KTCF138PF

8"x4", 1/4" radio, 3/8" profundidad #Parte KTCF168PF

8"x4", 3/8" radio, 1/2" profundidad #Parte KTCF167PF

8"x6", 1/4" radio, 3/8" profundidad #Parte KTCF101PF

8"x6", 3/8" radio, 1/2" profundidad #Parte KTCF102PF



ORILLADOR ACERO FLEXIBLE AZUL Mango PRO



P

6"x3" radio 3/8 #Parte KTCF569PF

6"x4" radio 3/4 #Parte KTCF571PF

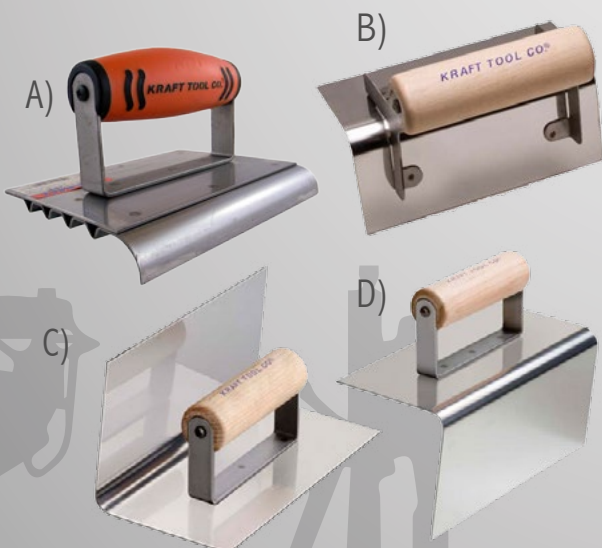

HERRAMIENTA P/ESCALÓN Orillador



P

A) p/escalón seguridad 6"x4 1/2" #Parte KTCF112PF

B) Ext. p/e/seguridad 6"x2 1/2"x1/2" Radio #Parte KTCF123PF

C) 8"x4"x1/2" orilla de 4" int. #Parte KTCF177PF

D) 8"x4"x1/2" orilla de 4" ext. #Parte KTCF178PF

HERRAMIENTAS PARA CONCRETO

BUMP CUTTER Regla super plana con orilla recta



		P
10'x2"x4" Inc. Adap., extensión y soporte	#Parte	KTCC714
12'x2"x4" Inc. Adap., extensión y soporte	#Parte	KTCC716
16'x2"x4" Inc. Adap., extensión y soporte	#Parte	KTCC720

AUSSI COMBO Para acabados perfectos

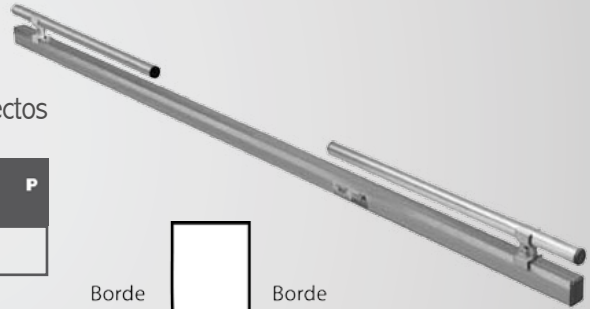

		P
10'x1 3/8"x2" 2 Mangos	#Parte	KTCC423

Borde Redondo



Borde Cuadrado

VIGUETA De Magnesio



		P
16'x 1"x 4" (2piezas)	#Parte	KTCC516

VIGUETA MANUAL Forma Cerradura

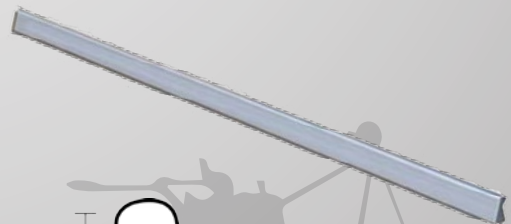

		P
P/Nivelado a mano 10'x4 1/2"x2 1/2"	#Parte	KTCC726

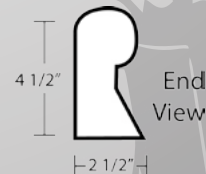

HERRAMIENTAS PARA CONCRETO

TEXTURIZADOR Cepillo de Alambre plano

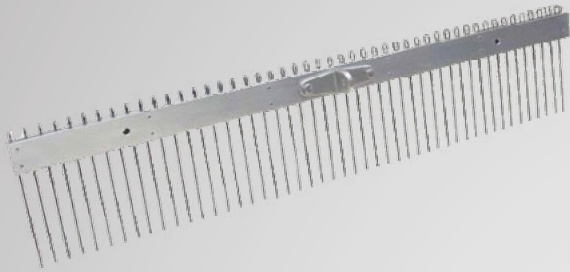

			P
36", 1/2" Separación	#Parte KTCC19612		
36", 3/4" Separación	#Parte KTCC19634		
48", 1/2" Separación	#Parte KTCC19812		
48", 3/4" Separación	#Parte KTCC19834		
60", 1/2" Separación	#Parte KTCC19912		
60", 3/4" Separación	#Parte KTCC19934		
Dientes de repuesto p/cepillo textura	#Parte KTCC200		



CEPILLO P/ACABADO ARMAZÓN ALUMINIO



			P
36" Cerdas polipropileno	#Parte KTCC177		
48" Cerdas polipropileno	#Parte KTCC178		
36" Pelo Natural de caballo y polipropileno	#Parte KTCC180		
48" Pelo Natural de caballo y polipropileno	#Parte KTCC176		

CEPILLO P/ACABADO ARMAZÓN MADERA



			P
36" Cerdas polipropileno,inc.mango mad.	#Parte KTCC166		
36"pelo caballo,acabado fino,inc.mango mad.	#Parte KTCC194		
36"grueso multi-uso,pelo caballo,inc.mango mad.	#Parte KTCC192		

HERRAMIENTAS PARA CONCRETO

JALADOR DE ALUMINIO Mango Pro

		P
19 1/2" x 4", A 60°	#Parte KTCC965	



RODILLO BAJA GRAVA

		P
36"	#Parte KTCC952B	
48"	#Parte KTCC958B	



APISIONADOR PARA CONCRETO

		P
36" X 8" Parrilla en forma de diamante	#Parte KTCC879	

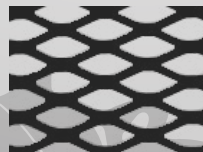
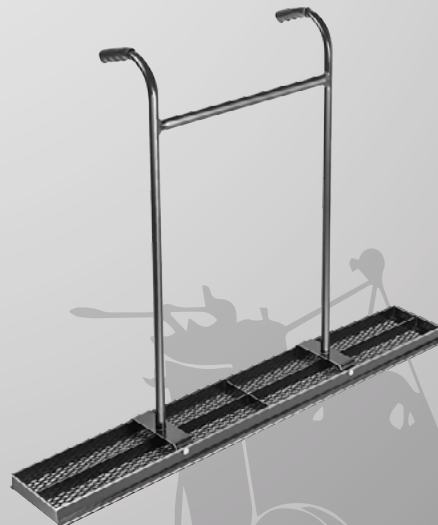

HERRAMIENTAS PARA CONCRETO



EZY-TILT® II Adaptador (1 3/4")



P

De cadena y botón #Parte KTCC294



KNUCKLEHEAD® II TILT Adaptador (1 3/4")



P

De engrane y botón #Parte KTCC296



ADAPTADOR ORBITER Tilt Bracket (1 3/4")



P

#Parte KTCC270



ADAPTADOR ROSCA HEMBRA Para Flotas (1 3/4")



P

Base 2 perfo. para posiciones #Parte KTCC676

HERRAMIENTAS PARA CONCRETO

EXTENSIÓN Fibra de Vidrio

 P
1.80m x 1 1/2" doble botón #Parte KTCC674 Adaptador de 1 1/2" a 1 3/4" #Parte KTCC675



EXTENSIÓN Aluminio

 P
1.80m x 1 3/4" doble botón #Parte KTCC289SO



INSERTO CLIP De botón doble

 P
Para 1 3/4" #Parte KTCC289-01



HANDLES

 P
A) Aluminio 5´ Snap Style #Parte KTCC263 B) Madera 6´ Mango Acero #KTCC266



ADAPTADOR Rosca a botón

 P
Rosca hembra #Parte KTCC285 Rosca macho #Parte KTCC286

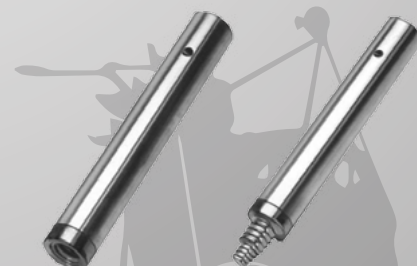

HERRAMIENTAS PARA CONCRETO

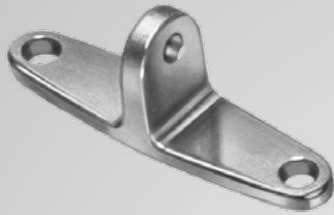

BASE "T" PARA CEPILLOS Y FLOTAS (1 3/4")



P

#Parte KTCC494

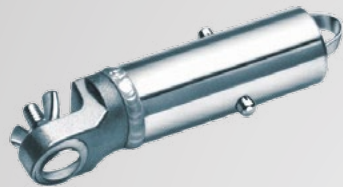
EZY-TILT[®] Adaptador de botón (1 3/4")

P

Para bases "T", fresnos o cepillos #Parte KTCC295



ADAPTADOR DE CLAVIJA (1 3/4")



P

1 3/3" #Parte KTCC284

ABRAZADERA DE LLANA Movimiento bidimensional

P

#Parte KTCC658

A)

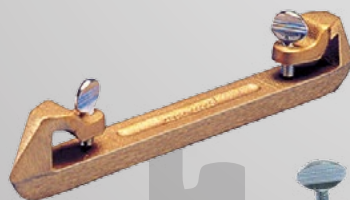

B)

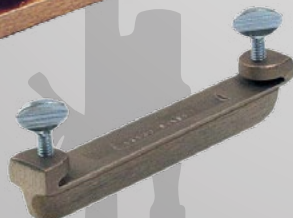
BROCA RANURADOR De Cobre

P

A) Para Flota 1", 1/4" Radius 1/2" Width #Parte KTCC941
B) Para Fresno 1", 1/4" Radius #Parte KTCC626

HERRAMIENTAS PARA CONCRETO

LLANA DE ACABADO



P

Para allanadoras 36" de 6"x14" #Parte KTSK100
Para allanadoras 46" de 6"x18" #Parte KTSK214

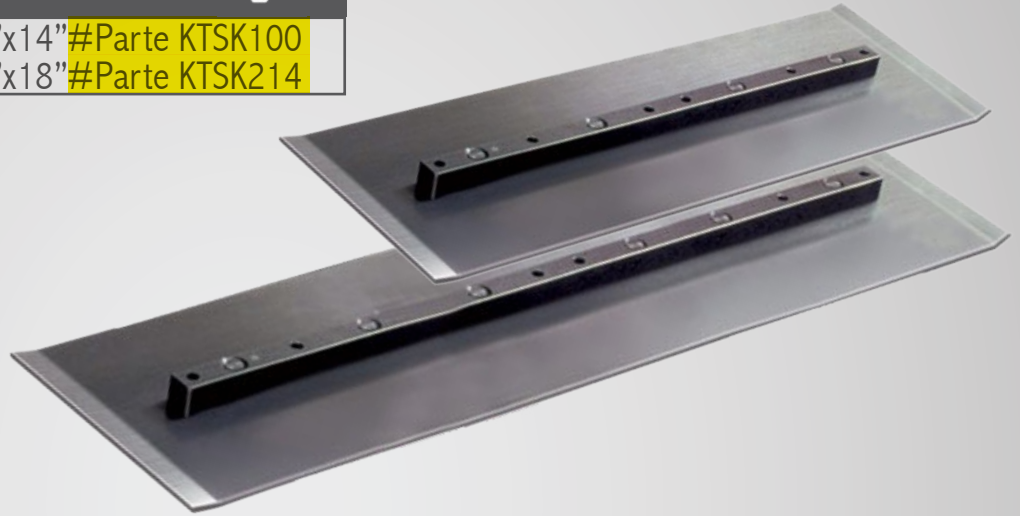

LLANA DE COMBINACIÓN



P

Para allanadoras 36" de 8"x14" #Parte KTSK101
Para allanadoras 46" de 8"x18" #Parte KTSK215



HERRAMIENTAS PARA CONCRETO



DISCO DE FLOTADO

			P
24" Orilla 90" Z-Clip	#Parte KTSK420		
30" Orilla 90" Z-Clip	#Parte KTCC421		

DISCO DE FLOTADO^P/Allanadoras de 36" 4 aspas

			P
ext. 38 1/4", int. 37 1/4"	#Parte KTSK402		

DISCO DE FLOTADO^P/Allanadoras de 46" 4 aspas

			P
ext. 47 3/4", int. 46 3/4"	#Parte KTSK404		

DISCO DE FLOTADO^P/Allanadoras de 46" 5 aspas

			P
ext. 47 3/4", int. 46 3/4"	#Parte KTSK409		

HERRAMIENTAS PARA ASFALTO

JALADOR FORMA "V" De Silicón, Reversible



P

Jalador V de 54" con mango #Parte KTGG814
Repuesto de silicón 54" #Parte KTGG81402

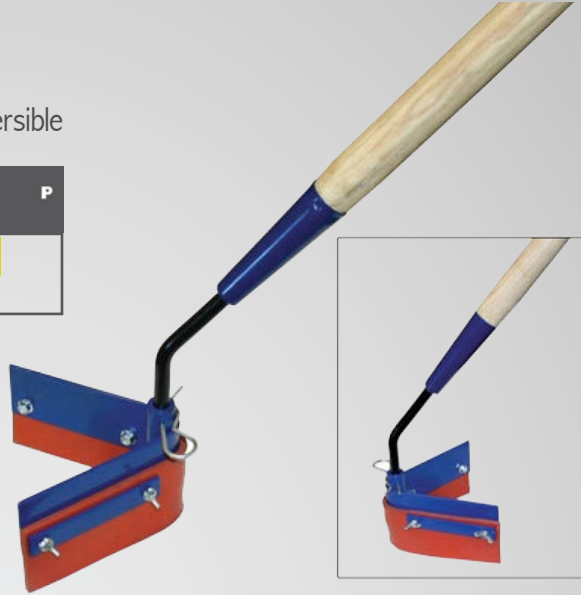

ESPATULA DE HULE



P

24" mango de 7' #Parte KTGG844
Repuesto de goma 24" #Parte KTGG84401
48" mango de 7' #Parte KTGG846
Repuesto de goma 48" #Parte KTGG84601



RASTRILLO PATRIOTA



P

24" con mango de 84" y soportes #Parte KTGG929

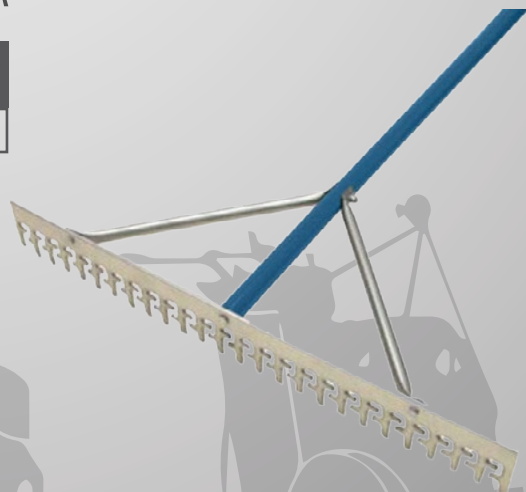

HERRAMIENTAS PARA RECUBRIMIENTOS



NAP ROLLER COVER



P

9" Width 1/4" #Parte DW171
 18" Width 1/4" #Parte DW174



ROLLER FRAME



P

9" w/threaded end f/extension hdl #Parte DW179
 18" w/threaded end f/extension hdl #Parte DW178



ROLLER END CAPS (PACKAGE OF 6)



P

Pack Roller end caps #Parte DW178-02

HERRAMIENTAS PARA RECUBRIMIENTOS

SQUEEGEE TROWEL



	🖐️	P
Squeegee 18" #Parte KTGG244		
Squeegee 26" #Parte KTGG247		

24" SQUEEGEE ALUMINUM

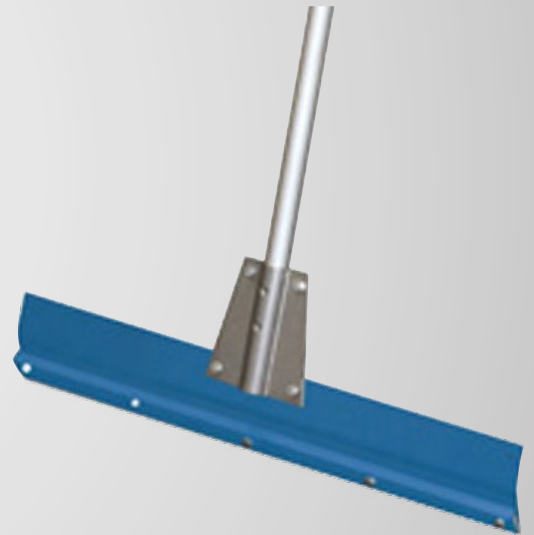

	🖐️	P
Squeegee Aluminum Frame #Parte GG235-01		
Straight (A) #Parte GG235-04		
1/8" V-notched (B) #Parte GG235-02		
1/4" V-notched (C) #Parte GG235-03		
Wide 1/4" "U" (D) #Parte GG235-05		

A)



B)

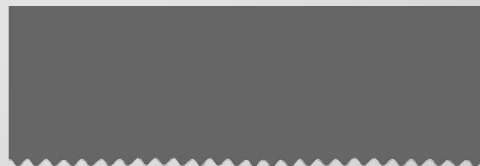

C)



D)



HERRAMIENTAS PARA RECUBRIMIENTOS

RODILLO DE PICOS ESTÁNDAR



P

9" con armazón #Parte KTGG609
18" con armazón #Parte KTGG618
Repuesto rodillo picos 9" #Parte KTGG610
Repuesto rodillo picos 18" #Parte KTGG619

NIVELADOR PARA RECUBRIMIENTOS



P

Nivelador 36" #Parte KTCC975
Nivelador 24" #Parte KTCC976

HERRAMIENTAS PARA RECUBRIMIENTOS

SANDALIAS DE PICOS FLEXIBLES (PARES)

 P
Par sandalias picos flexibles #Parte KTHC177



DESLIZADORES ACERO INOXIDABLE (PARES)

 P
Con rodilleras 28"x8" #Parte KTCC162



DESLIZADORES POLIESTIRENO (PARES)

 P
Con rodilleras 30"x10" #Parte KTCC153



RODILLERAS SUPER SUAVES DE NEUPRENO Y POLIURETANO

 P
Par de rodilleras #Parte KTWL139





BMAM[®]
BUILDER MARTS DE MEXICO, S.A DE C.V.

EQUIPO LIGERO
& HERRAMIENTAS
PARA CONSTRUCCIÓN



“Tus herramientas tu prestigio”

www.bmam.com.mx
atencionclientes@bmam.com.mx

Guadalajara, Jal.
Tels. (33) 3810 8044

CD. México, D.F.
Tels. (55) 5236 4058

Monterrey, N.L.
Tels. (81) 8141 0754

Hermosillo, Son.
Tels. (662) 306 9091

