



WE SHARE THE SAME PASSION SINCE 1967



COMBINED MACHINE

Turn thought into action

pastry technology

brittco[®]





trittico®

FOR PASTRY-MAKING

Simplicity, speed, regularity and safety are the elements that identify the technology of each Bravo machine. **Optimisation, organisation, efficiency and automation**, on the other hand, are the fundamental elements of modern craftsmanship. The synergy of these features leads to concrete advantages in terms of time, cost, product quality and ease of cleaning.

Created by Genesio Bravo, Trittico® is a groundbreaking technology with **over 50 years of history, research, patents, and advancements behind it**. Precise, versatile, and consistent, it brings together the craft of artisan gelato, fine patisserie, and chocolate-making—all in a compact design under one square meter.

Its **advanced software** automatically controls both standard and customizable programs for the two independent tanks, adapting the workflow to meet the specific needs of each recipe and ensuring **maximum production flexibility**.

Technology is a key ingredient in the craftsman's recipe for success



The original patent

1974: the beginning of a new era in the dessert industry

Trittico® is the first machine on the market to integrate pasteurizing, chilling, and batch freezing in one unit, utilizing two independent tanks connected by an internal passage to prevent external contamination. This revolutionary patent transformed the multi-machine process into a single, streamlined technology. Designed for artisan gelato production, Trittico® automates and standardizes processes, minimizes errors, optimizes costs and raw material usage, and significantly reduces production times—all while ensuring ease of use and effortless cleaning.

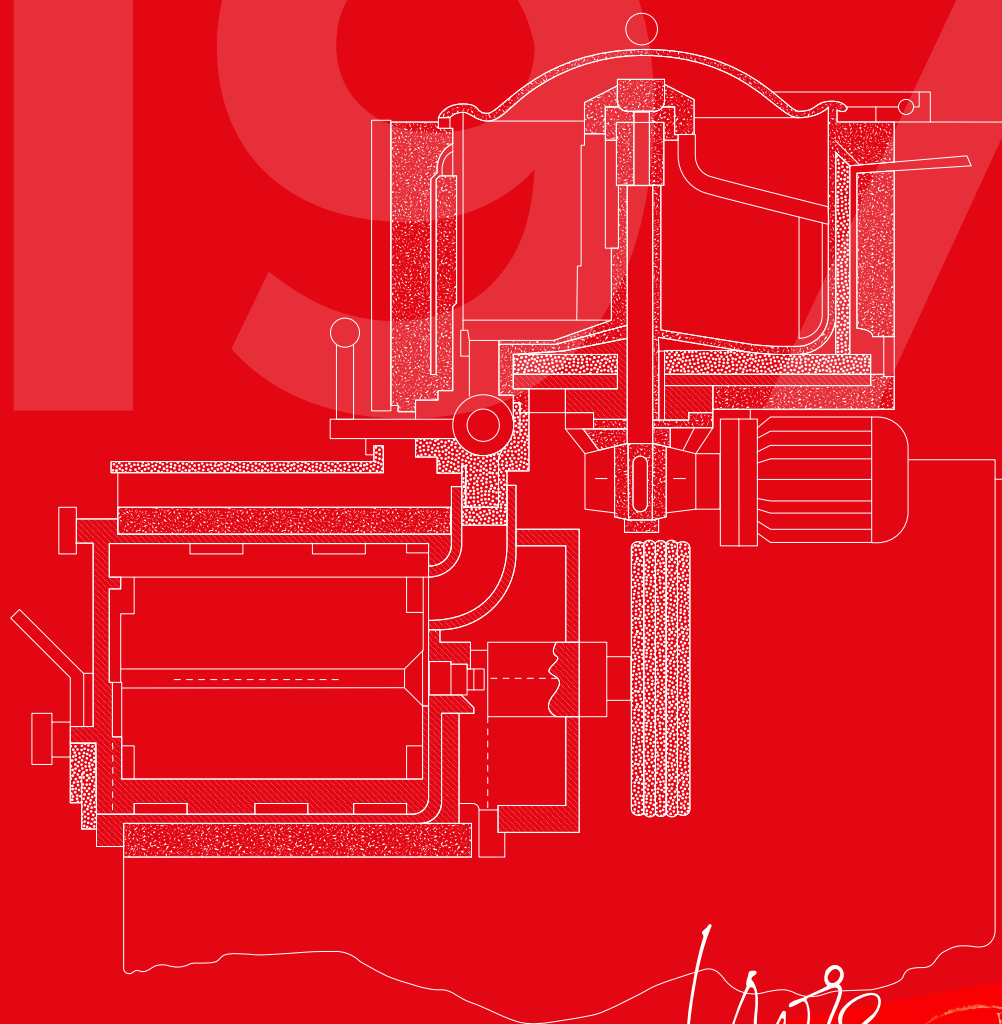

n. 85.643/A

1974



How it's made

AN ICONIC CONCEPT

Hot

Pasteurization is a heat treatment that **extends the shelf life of food and reduces microbial load through rapid heating followed by quick cooling**. In pastry-making, the heating phase is crucial for achieving a smooth, well-blended product that brings out the quality of premium ingredients. For artisan gelato, this process aids in **dissolving dry ingredients and activating stabilizers**.

Trittico® enables **precise, efficient heating** directly in the vertical upper tank, followed by rapid cooling in the lower cylinder, ensuring a **healthy and safe final product**.

Cold

Cooling is a crucial step in producing pastries, gelato, and chocolate. For optimal results, cooling must be **rapid, intense, and uniform** throughout the mixture, with precise timing and temperature control.

In **pastry**, rapid cooling ensures the **right texture and consistency**, allowing for immediate use.

In **chocolate** production, precise cooling supports the **ideal crystallization** of cocoa mass.

For **gelato**, batch freezing involves transforming the mixture from liquid to solid by rapidly chilling and stirring it, forming **fine ice crystals** that yield a **dry, creamy, spreadable** product that holds well in display.

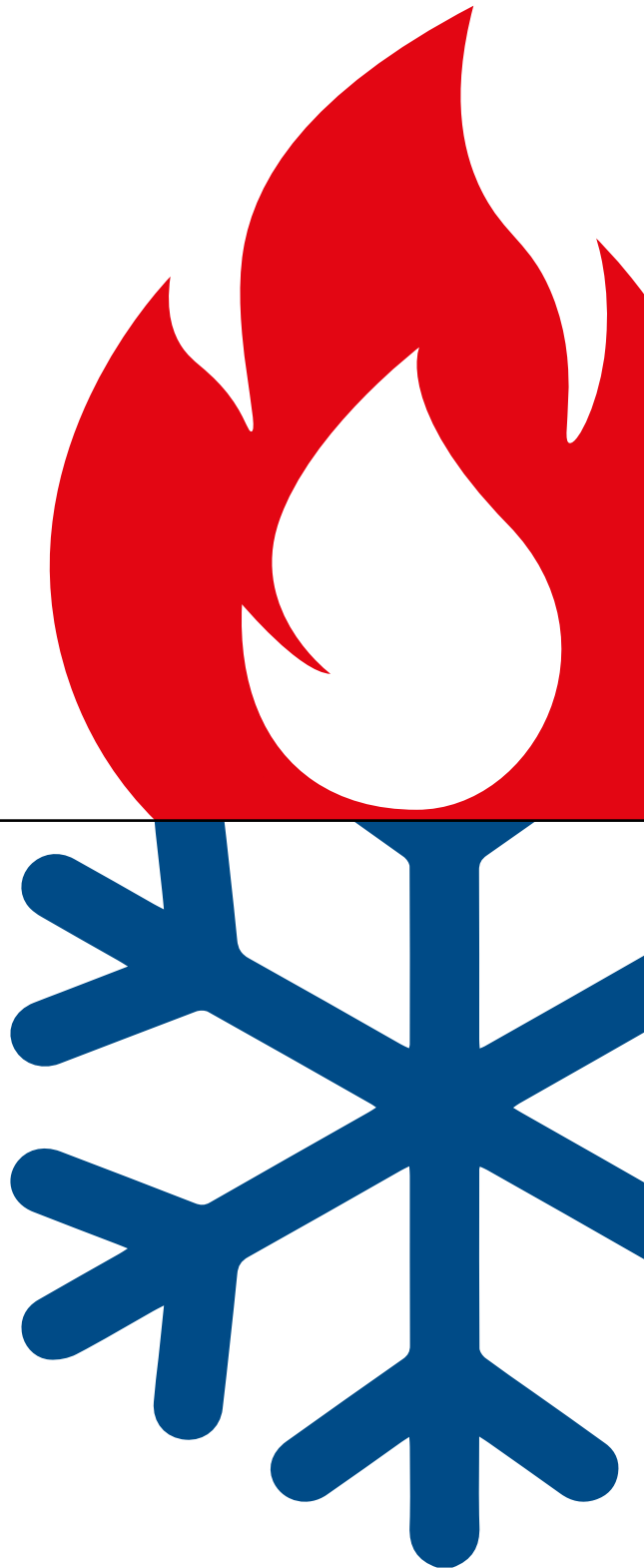

Upper part



TRANSPARENT TOP LID

Made of transparent moulded polycarbonate for **perfect adherence to the edge of the upper tank** and to **monitor cooking** inside. It is equipped with a **vent valve** (easily removable for cleaning) to **manage water evaporation** and product drying.

VERTICAL UPPER TANK

It allows you to add any type of ingredient at any stage of processing, including frozen fruit. The special foil heating elements adhere perfectly to the bottom and side surfaces of the tank, ensuring **rapid and precise heating up to 115°C** and **minimising thermal inertia and the risk of burning** the product.



pastry technology



Discover upper tank technology



STIRRER

It is custom-made to **adhere perfectly to the walls of the upper tank** and **prevent product build-up**. All components (stirrer, side blades, bottom skirts) can be disassembled in seconds without the need for any tools, for **maximum convenience and ease of cleaning**.

+ Did you know?



Trittico is available in **several heights** to better suit the different needs of each professional.

Hot

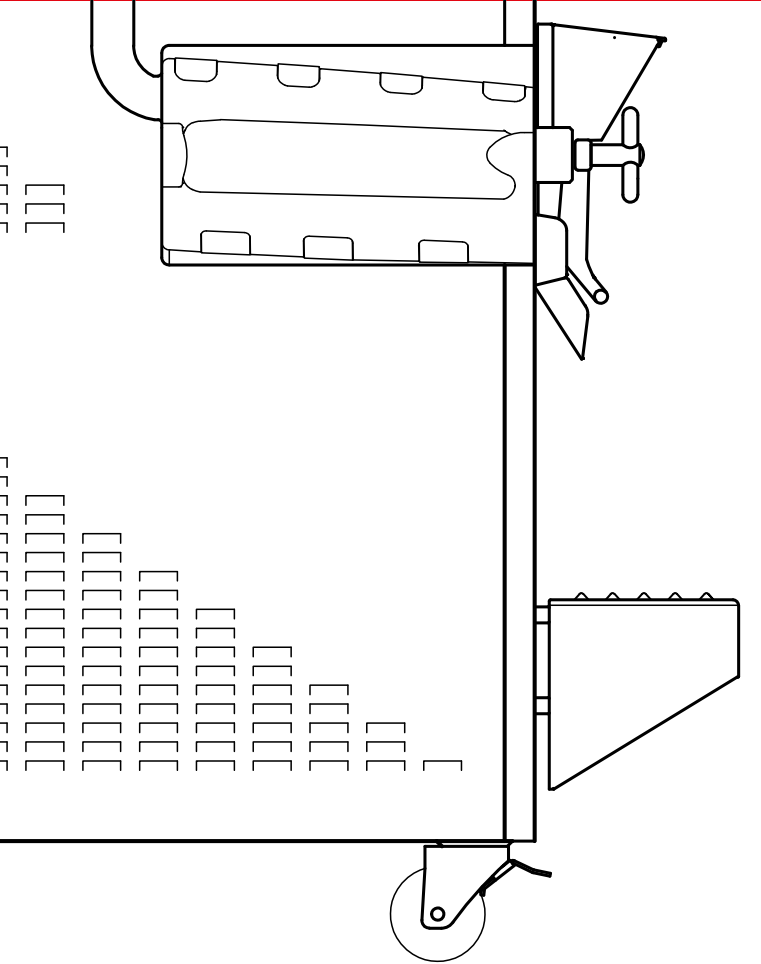
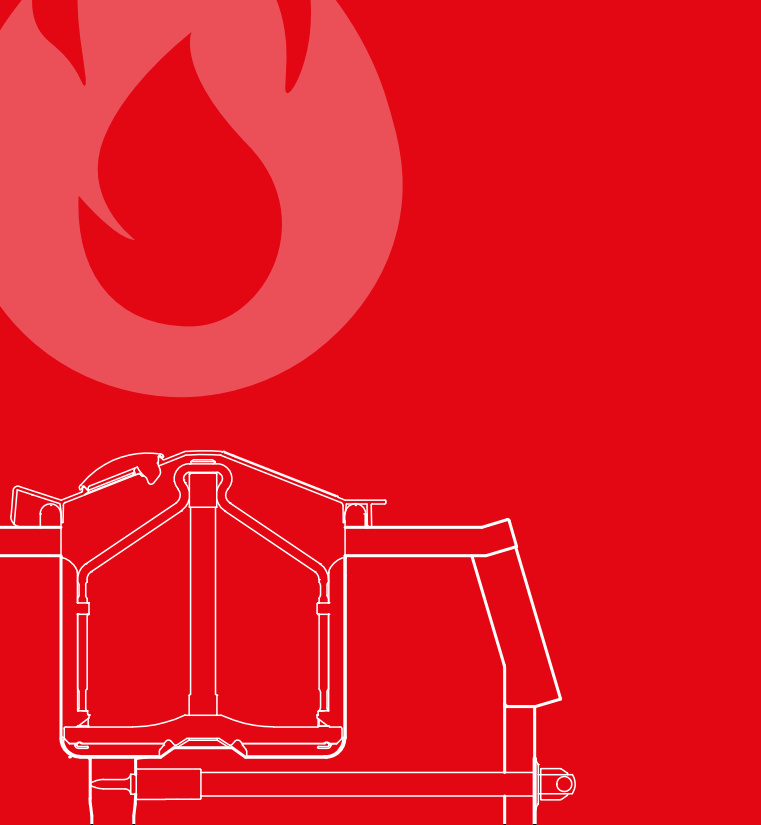

TEMPERATURE PROBES

Temperature measurement is accurate to a tenth of a degree (0.1°C) thanks to the presence of a **core probe**, which ensures that the set pasteurisation temperature is perfectly achieved.



FLAVOUR BASKET

The **hot infusion process** intensifies the flavour of spices, herbs and citrus fruits in recipes. It is easy to insert, remove and clean at any stage of pasteurisation.



PATENTED INTERNAL CONDUIT

Based on an **original Bravo patent**, it allows the hot mixture to descend into the batch freezing cylinder **without external contamination or tampering**, undergoing a **thermal shock** that ensures **maximum bacterial reduction**.

BUTTERFLY VALVE

It opens and closes easily, allowing the mixture to pass through quickly and safely. **It can be disassembled, cleaned and reassembled in just a few steps.**

Lower part



FRONT DOOR

Lightweight, durable, and practical, it features a latch system for easy opening and closing, along with a convenient cover flap that **allows ingredients to be added during the churning process**. Made from **Tritan™, a specialized heat-insulating material, it prevents cold loss, ice buildup, and condensation**. It is also easy to disassemble, clean, and reassemble, with no burn risk to the operator.

HORIZONTAL LOWER CYLINDER

Bravo's **innovative refrigeration system** is **entirely designed and built in-house**. Crafted from a single, seamless section of stainless steel using advanced deep-drawing techniques, the inner surface offers exceptional **durability and resilience against thermal stress**.

Multi-point and multi-ring technology

Featuring **multi-point gas injection** on one side and direct expansion multi-ring distribution on the other, this system ensures **optimal heat exchange, delivering fast, efficient, even, and gentle cooling** throughout the mixture. It minimizes thermal inertia, even in high-volume cycles, for precise and consistent cooling control.



pastry technology

+ Did you know?



Bravo's batch freezing cylinder has a **smaller diameter and greater depth to increase its cooling surface area**. This surface is 15% greater for the same volume, while the inert surface area is 20% less than a conventional cylinder.

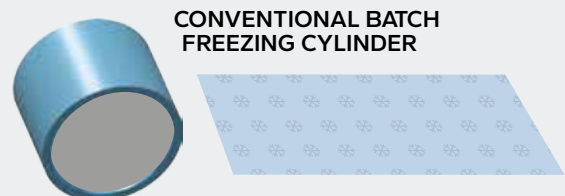

CONVENTIONAL BATCH FREEZING CYLINDER



BRAVO BATCH FREEZING CYLINDER

-20%
INERT
SURFACE

+15%
COOLING
SURFACE



Discover multi-point and multi-ring technology



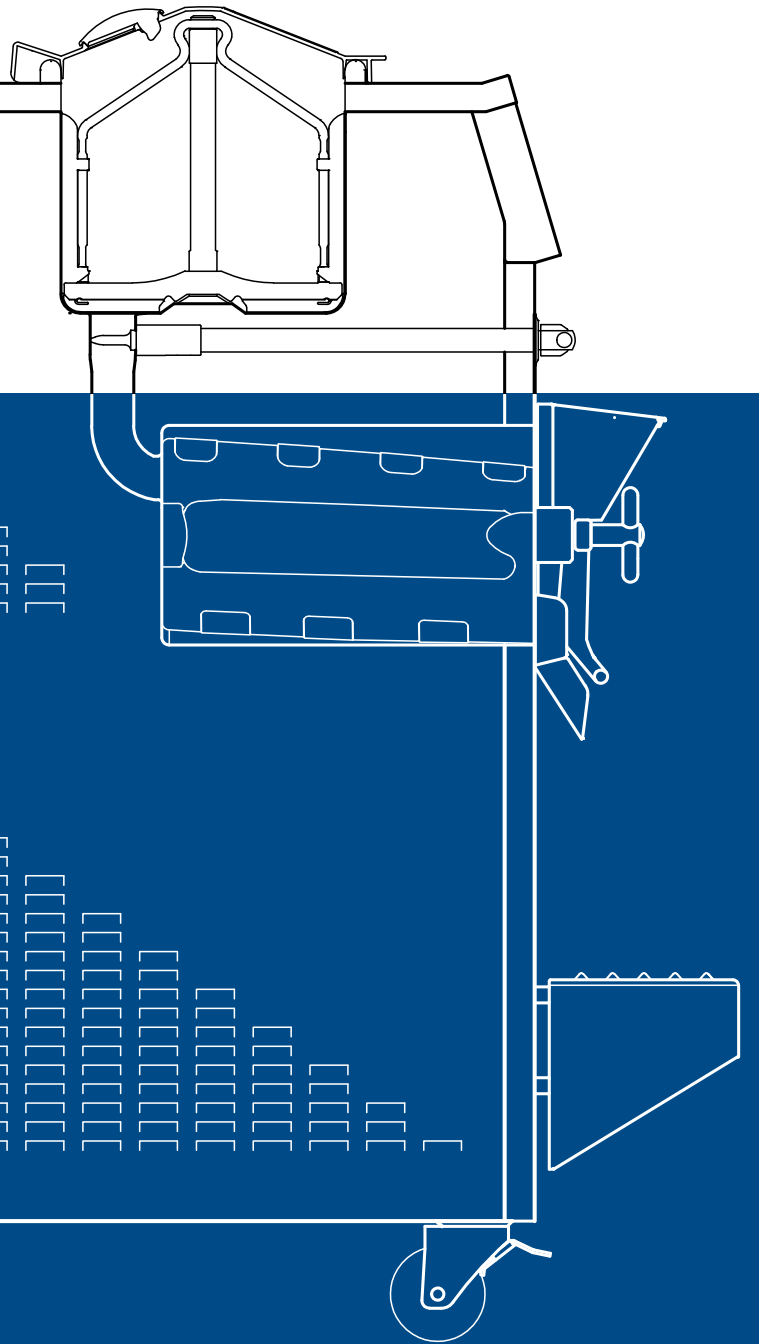

HELICAL MIXER

Made of stainless steel for better cold transmission, it is equipped with a rear and front **connection for greater stability and durability**. It is equipped with **powerful, self-adjusting scraping teeth** that adhere perfectly to the cylinder walls, **preventing ice formation** and contributing to optimal gelato extraction.

TEMPERATURE PROBES

Temperature measurement is accurate to a tenth of a degree (0.1°C) thanks to the presence of two probes at the core of the product, which ensure that the set cooling temperature is perfectly achieved.



DIFFERENT PRESET STIRRING SPEEDS

The mixer is equipped with a software-controlled variable speed drive (inverter). It has **8 mixing and product extraction speeds**, which can be changed at will during processing, ensuring **optimal structure and adequate air incorporation**. Highly technical products such as custard, Bavarian cream or buttercream are made to perfection. For the **gelato shop**, the mixer has a specially designed batch freezing speed to obtain a **regular micro ice crystal**.



SIRHA+
COUPE DU MONDE
DE LA PÂTISSERIE

Trittico has been on stage at the World Pastry Cup since 2009

Haute patisserie is an expression of artisanship that combines skill, creativity and attention to detail. It is a continuous pursuit of excellence, where every element, from the choice of ingredients to the presentation, is meticulously crafted to offer a new and surprising experience, every single time.

Sharing these values has led Bravo to be a proud **technical partner of the most prestigious competition in the world of confectionery since 2009, the Coupe du Monde de la Pâtisserie, held every two years at the Sirha show in Lyon, France.**

The Coupe du Monde de la Pâtisserie is a key opportunity to rub shoulders with the world's best chefs and stay up-to-date on the latest trends in the industry, in order to raise our standards of excellence even higher.





Only Trittico: the details that make the difference



Thanks to its intuitive technology, Trittico guides you step by step through each recipe, making the process simple and user-friendly.



Intuitive use



The work of the two independent tanks (one always hot and the other always cold) allows gelato making to be carried out in just a few minutes.



Production synchronisation



Precise core temperature control, combined with advanced heating and cooling technology, ensures consistent and easily reproducible processing.



Regularity of production



Any ingredient can be used, even hard-to-dissolve ones such as mascarpone, cocoa powder, confectionery, frozen fruit.



Maximum customisation



Thanks to the thermal shock, the fats do not separate from the water, they do not have time to surface and the gelato remains opaque without the need for the mixture to rest.



Gelato always fresh and ready for sale



It accommodates the needs of each professional, allowing them to express their imagination and creativity with customised productions.



Enhancement of craftsmanship





In just a few minutes, the hot mixture descends by gravity into the lower cylinder without obstructions, obstacles, contamination or external tampering, undergoing a thermal shock until reaching the temperature of use.



Health and safety



The mix can be loaded from the front door in the case of cold production and ingredients can be added during both the heating and cooling phases.



Maximum versatility



The mix made in the upper tank does not need to be compensated as in a large pasteurizer. Thus ensuring emulsification and increase flavor.



Perfectly balanced and tasty gelato



All components can be disassembled without tools and are easy to wash. In the upper tank, the water can reach high temperatures, sanitising both tanks and the internal conduit.



Maximum ease of cleaning

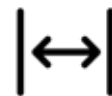

A pasteuriser, a batch freezer and a cream cooker in one machine in less than one square metre



Reduced footprint, investment and consumption

Trittico

executive

pastry technology

Trittico



+ Did you know?



The Automatic Ionic System® recognises the type of gelato you are batch freezing and brings it to the set drying value. This **smart technology** simplifies your work, ensuring maximum production consistency.

e e EVO



Ionic System®

Developed by Bravo, it is the **control system that scientifically evaluates the correct consistency of gelato in real time and optimises overrun.**

The software receives information from special probes positioned in the cylinder, **analyses the amount of crystallised water in the mixture and signals when the set consistency value is reached.** In addition, the variable speed drive automatically increases stirring in the batch freezing phase when more air needs to be incorporated into the mixture, and decreases it in the final phase to maintain it; for a dry, creamy gelato with a smooth texture on the palate and stable in the display window.

The mixer's **variable speed drive** (inverter), designed to work **seamlessly with the Ionic System®**, offers **eight different speeds for ice cream extraction**, making tub decoration easy and precise. Additionally, the inverter allows for **slush ice production by slowing down the blade speed.** This lower speed enables **faster freezing** against the cylinder, forming the fine, even ice crystals typical of Sicilian granita.

15





Trittico® Executive

An ally in pastry and gelato making in 1 sqm

With an electronic system backed by over 50 years of experience in the dessert industry, Trittico® Executive is the first combined machine that enables the automated production of a wide range of pastry items, artisanal gelato, sorbets, and granitas with speed, safety, and uncompromising quality.

Features

- The processes to perform the main jobs are saved inside the machine so that the **execution of the recipe is easy and repeatable**. Cooking, stirring, cooling parameters can be easily changed and saved to suit the needs of every confectioner and gelato maker.
- The **variable speed drive** in the lower cylinder (inverter) allows 8 different mixing speeds, to faithfully replicate the pastry chef's movements. You can choose to incorporate the maximum amount of air on products such as buttercream, mousseline, pate a bombe or gelato, and to reduce it to a minimum on products such as custard, ganache or Bavarian cream.
- **Free program** to perform all processing operations using the various settings in manual mode.
- **MdM program** ("meno della metà" or "less than half") to work with less than half the maximum load (useful for testing or producing special flavours, for small occasional production).
- When the acoustic signal indicates that the product is ready, if it cannot be transferred into the lower cylinder or taken out immediately, the consistency value or set temperature is automatically held.

pastry technology

Gelato programs

- Option to operate by setting gelato **consistency** with the Ionic System.
- Option to work by setting the precise **extraction temperature** of the gelato.
- Ability to choose from 9 consistency levels using **amperometric motor strain** measurement, detecting current absorption during the batch freezing phase.
- **Cold-Stroke Mode**: manually activated during extraction to engage the compressor in short intervals, ensuring optimal consistency throughout the gelato in the cylinder.

+ Did you know?



The touch display allows you to access the My Recipes program library, to customise each recipe in a multitude of combinations by setting different values for your favourite parameters (mixing speed, temperature, cooking time...), and then saving the customisable programs directly within Trittico Executive.



Watch the video



How to clean Trittico



Pastry programs



BAVAROISE



BUTTER CREAM



ALMOND CREAM



CUSTARD CREAM



PARISIAN FLAN



TRADITIONAL
GANACHE



FRUIT JELLY



MARSHMALLOW



BECHAMEL



MOUSSELINE



MERINGUE



MOUSSE



GELATO



SORBET



SLUSH



ENGLISH CREAM



PÂTE À BOMBE



CHOCOLATE
PÂTE À BOMBE



LEMON CURD



PROGRAMMABLE

With Pâte à choux option



PÂTE À CHOUX



CONSISTENT DOUGHS



The programs are constantly evolving, discover them all



With Evomix option



GLAÇAGE



ENGLISH CREAM MIXED



SOUP



SALTY SAUCE



Trittico® Evo

An ally in pastry, chocolate and gelato making in 1 sqm

Trittico® Evo is the first combined machine that allows you to automatically produce many pastry and chocolate products, gelato, sorbet and slush with speed, safety and absolute quality. The ultimate for your laboratory.

Features

- The processes to perform the main jobs are saved inside the machine so that the **execution of the recipe is easy and repeatable**. Cooking, stirring, cooling parameters can be easily changed and saved to suit the needs of every confectioner and gelato maker.
- The **variable speed drive** in the lower cylinder (inverter) allows 8 different mixing speeds, to faithfully replicate the pastry chef's movements. You can choose to incorporate the maximum amount of air on products such as buttercream, mousseline, pate a bombe or gelato, and to reduce it to a minimum on products such as custard, ganache or Bavarian cream.
- **Free program** to perform all processing operations using the various settings in manual mode.
- **The MdM** ("meno della metà" or "less than half") program enables operation with **less than half of the usual workload**, making it ideal for testing or creating specialty flavors.
- When the acoustic signal indicates that the product is ready, if it cannot be transferred into the lower cylinder or taken out immediately, the consistency value or set temperature is automatically held.

Gelato programs

- Option to operate by setting gelato **consistency** with the Ionic System.
- Option to work by setting the precise **extraction temperature** of the gelato.
- Ability to choose from 9 consistency levels using **amperometric motor strain** measurement, detecting current absorption during the batch freezing phase.
- **Cold-Stroke Mode**: manually activated during extraction to engage the compressor in short intervals, ensuring optimal consistency throughout the gelato in the cylinder.

Chocolate programs

- **3 preset programs for tempering** milk, white and dark chocolate directly in the vertical upper tank.
- After melting the chocolate, Trittico performs **soft cooling** to **precisely reach the crystallisation temperature of the cocoa butter**, and then heats it to the desired temperature.
- Each of the three temperatures can be easily modified to be able to work with any type of chocolate.

pastry technology



Watch the video



How to clean Trittico

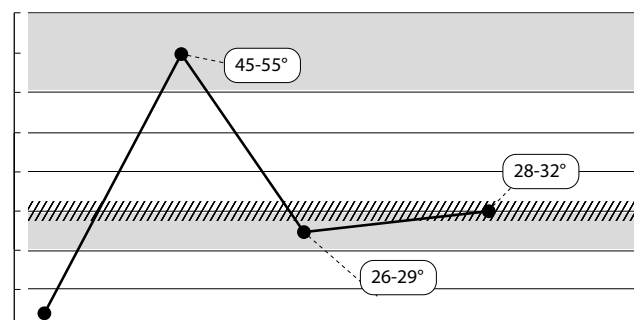

Pastry programs



19

With Pâte à choux option



With Evomix option



Main options

+ Evo Mix

Evo Mix is the **patented**, practical and efficient immersion mixer **installed directly in the upper tank** of Trittico®. The combined use of Evo Mix and Trittico® **allows simultaneous heating, mixing and emulsifying** in an automatic program. By effectively emulsifying the proteins during heating, they incorporate more air, improving the texture of the gelato.

Features

- + 12000 rpm, 550 W power
- + Cutter with 3 interchangeable blades
- + Quick connector for easy connection to and removal from Trittico®
- + Motor with forced air circulation to prevent steam suction
- + Mixing time settable from front panel

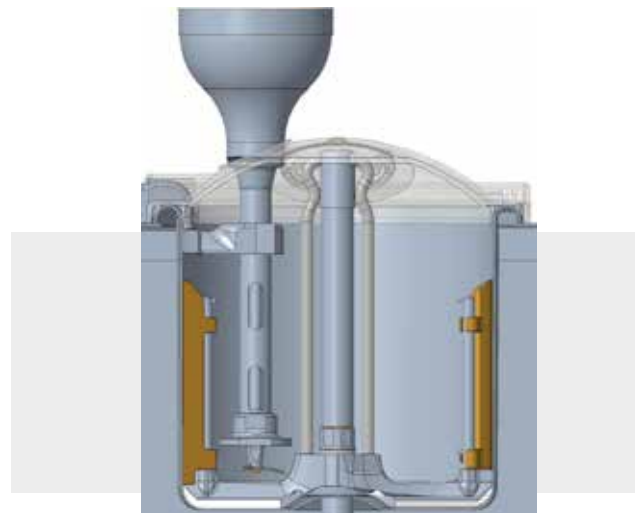

Advantages

- + Ability to emulsify the mixture while hot for a better texture of gelato and sorbets
- + Ability to mix solid and liquid ingredients directly in the machine
- + Ease of disassembly and cleaning
- + Ability to warm and emulsify butter or cocoa butter, enhancing the structure of ganache and crèmeux.



Watch the videos



Gelato



Ganache



Cremeux

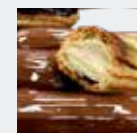



Download
the complete
optional sheet



+ Whisk

With the optional whisk, it is possible to obtain **perfectly emulsified products** that retain their volume over time. Inserted directly into the lower tank of Trittico® it artfully whisks creams, mousses and other preparations in line with the latest pastry trends, light and pleasing to the palate.

Features

- + Geometry designed to ensure optimal product release
- + Equipped with interchangeable polyoxymethylene (POM) scraper blades
- + 230 mm diameter with 12 wires for perfect emulsification
- + Speed automatically managed by the software



Butter cream



Pâte à bombe



Cream mousseline



Marshmallow



Watch
the videos

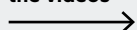

Main options

+ Pâte à choux

The pâte à choux flange is a patented option that **allows flour and eggs to be added at the specific stage of processing** in the machine, enabling the pate a choux dough to be made easily, evenly and cleanly.

Features

- Lightweight and easy to assemble
- Equipped with a funnel for inserting flour and eggs
- It aids the mixing and cooking of ingredients
- Large outlet for easy and fast extraction

Advantages

- + Automatic management of mixing time, temperature and speed
- + Constant monitoring of product temperature thanks to special probes



pastry technology



Download
the complete
optional sheet



Watch
the video



Pâte à choux



+ Insight

Insight is the innovative 24/7 **automatic monitoring system** via dedicated server. Thanks to the Wi-Fi* connection, antenna attached to the machine and router, it sends messages via e-mail to **ensure the correct and constant functionality of the machine.**

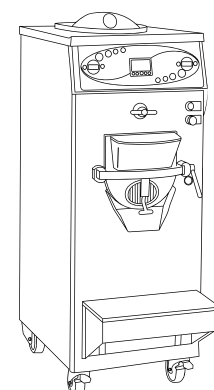

Features

- Maintaining of machine efficiency and performance
- Troubleshooting ordinary faults by avoiding the need for a technician to come out
- Correction of user errors by the operator
- Direct communication with skilled and qualified Bravo technicians
- Fast and accurate diagnostics to prevent malfunctions
- Advance knowledge of any components to be replaced

Functionality



INSTALLATION

Verification of correct installation parameters by a technician (on request).



SUPPORT

Monitoring and verification of correct operating parameters by a technician who, if necessary, diagnoses the problems detected and recommends the most suitable solution (on request).



ALERT

Real-time e-mail communication from 24/7 server of automatic notification messages.



CONNECTIVITY

Connection to the innovative Equilibrio Smart Scale&Management work system.



RECORDING

Program for recording and storing recipe execution times and temperatures on a pen drive. Automatic batch number generation.

+ Mixed air/water condensation

Under optimal outside temperature conditions, **hybrid condensation** allows mainly air operation. When it is too high, it automatically starts the second water-cooled condenser. It guarantees **considerable water savings** as water is only **used during the most demanding moments of the mixture processing**. Indispensable in geographical areas with water scarcity.

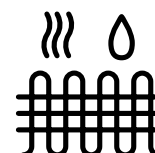

*Wi-Fi option required.

Made in Italy

Main options



Download
the complete
optional sheet



+ Touch Display

The high-resolution 7" colour touch-screen display offers the possibility of clearly **displaying additional machine and process information**.

Features

- It allows you to monitor, moment by moment, the progress of the work cycle and interact with the machine intelligently by simply touching on the area of interest.
- It allows you to keep all the parameters of Trittico® under control at all times, such as the number of processes carried out, the operating times of the accessories and many other useful data.
- Access to the program list is simple and intuitive thanks to the library, which presents program and alarm descriptions, multilingual support and the possibility of 'screen lock' for cleaning.
- Gives exclusive access to the 'My Recipes' program library.

pastry technology

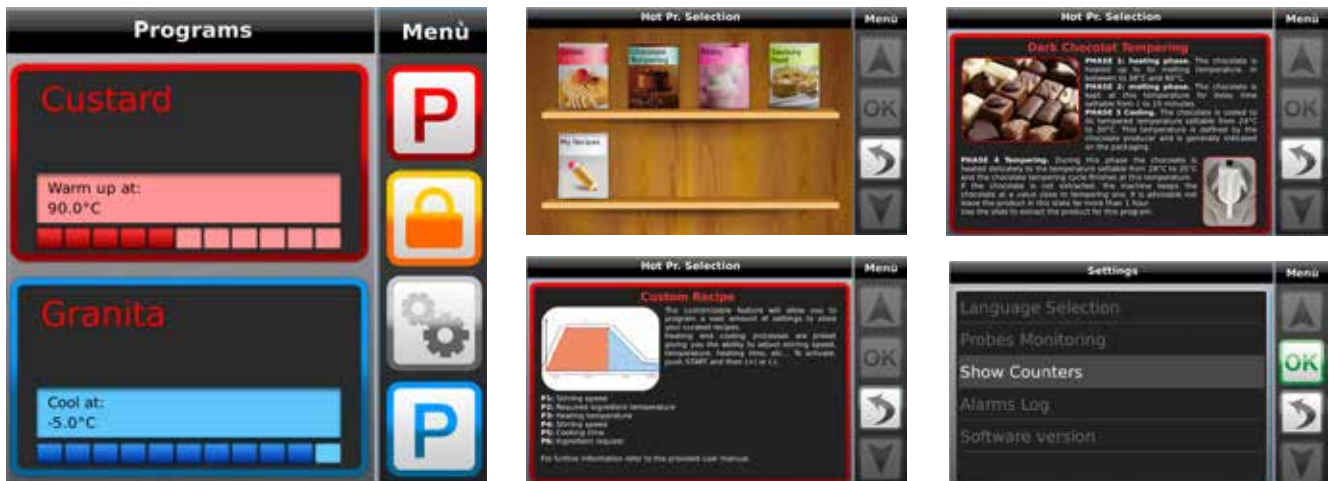

+ Extraction chute

Enables product extraction **directly from the upper tank** without dirtying the cooling cylinder.

Features

- Convenient for extracting jams, marmalades, toppings, fruit jellies, ganaches, tempered chocolate, etc.
- The chute is made with material compatible with food that does not affect the extracted product temperature. Moreover, it prevents products (such as tempered chocolate) from starting to cool down when descending and from depositing on the chute.
- The chute is equipped with:
 1. a crescent-shaped blade
 2. a chute sealing ring on the spare cylinder hub



Products & capacity metric

Model	183*		305		457		610		1020	
Upper tank capacity	7.5 liters		13 liters		13 liters		19 liters		34 liters	
Kg	MIN	MAX	MIN	MAX	MIN	MAX	MIN	MAX	MIN	MAX
Custard cream, Cremeux, Free program	3	4.5	5	8	5	10	6	12	12	25
	2 - 3 lt milk		2.5 - 5 lt milk		3.5 - 7 lt milk		4 - 8 lt milk		8 - 16 lt milk	
Bavaroise, English cream	2.5	3.5	3.5	7.5	5	9	6	12.4	12	25
	2 - 3 lt milk		2.5 - 5 lt milk		3 - 6 lt milk		4 - 8 lt milk		8 - 16 lt milk	
Ganache	2	3.5	3.5	5.5	4	8	6	11.5	12	23
	1-3 lt cream		2 - 4 lt cream		2.5 - 5 lt cream		3.5 - 8 lt cream		8 - 12 lt cream	
Lemon curd	0.75	1.5	1.5	3	3	6	4	6.5	6	12
	0.3 - 0.7 lt lemon juice		0.75 - 1 lt lemon juice		1 - 2 lt lemon juice		2 - 4 lt lemon juice		4 - 6 lt lemon juice	
Fruit jelly	1.5	2.5	2.5	5	2	5	5	9.5	9	19
	0.5 - 1 kg fruit puree		1 - 2 kg fruit puree		1.5 - 2 kg fruit puree		2 - 4 kg fruit puree		4 - 8 kg fruit puree	
Mousseline cream	1	2.2	2	4.5	4	6	5.5	9	12	17
	0.5 - 1 lt milk		1 - 2 lt milk		1.8 - 2.8 lt milk		2.5 - 4 lt milk		4 - 8 lt milk	
Bechamel	2	4	4	6.5	4	8	7	10	10	20
	1.5 - 3 lt milk		2.5 - 5 lt milk		3 - 6 lt milk		4 - 8 lt milk		8 - 16 lt milk	
Butter cream	2	3	3	4.5	3	6	5	8.5	10	17
	0.6 - 1.1 kg butter		1.1 - 2.5 kg butter		2 - 3.5 kg butter		2.5 - 5 kg butter		5 - 10 kg butter	
Pâte à bombe, Chocolate pâte à bombe	/	0.8	0.8	1.6	1	2	1.5	3	3	6.5
	320 gr egg yolk		320 - 640 gr egg yolk		445 - 890 gr egg yolk		640 - 1280 gr egg yolk		1280 - 2500 gr egg yolk	
Pâte à choux	/	/	/	6	6	8.5	6	12	12	24
			2 lt liquid		2 - 3 lt liquid		2 - 4 lt liquid		4 - 8 lt liquid	
Mousse	2	3	2.5	5	4	7	6	10	12	20
Marshmallow	/	2	2	4	4	8	4	8	8	16
Italian, Swisse meringue, meringue for macarons	1	1.5	1	3	2	4	3	6	8	12
Almond cream	1	2	2	4	3	5.5	4	8	8	12
Parisian flan	3	4.5	4	7.5	5	10	6	12	12	24
White, Dark, Milk chocolate tempering	/	3	4	7	5	9	6	10	12	24
Slush	1.5	3	2	5	3	7	4	10	8	20

Products & USCS U.s. Customary System capacity

Model	183*		305		457		610		1020	
Upper tank capacity	1.98 Gal		3.43 Gal		3.43 Gal		5.02 Gal		8.98 Gal	
lb	MIN	MAX	MIN	MAX	MIN	MAX	MIN	MAX	MIN	MAX
Custard cream, Cremeux, Free program	6.60	9.92	11.02	17.64	11.02	22.05	13.23	26.46	26.46	55.12
	67.63 - 84.54 fl. oz. milk		84.54 - 118.35 fl. oz. milk		135.26 - 271.03 fl. oz. milk		135.26 - 337.03 fl. oz. milk		271.03 - 541.03 fl. oz. milk	
Bavaroise, English cream	5.50	7.72	7.72	11.02	11.02	22.05	13.23	26.45	26.45	55.22
	67.63 - 84.54 fl. oz. milk		84.54 - 101.44 fl. oz. milk		135.26 - 270.50 fl. oz. milk		135.26 - 337.07 fl. oz. milk		270.50 - 541.02 fl. oz. milk	
Ganache	4.40	7.72	7.72	12.13	8.82	17.64	13.23	25.35	26.45	50.30
	33.80 - 101.44 fl. oz. cream		67.63 - 135.26 fl. oz. cream		84.54 - 169.07 fl. oz. cream		118.35 - 270.50 fl. oz. cream		270.50 - 405.70 fl. oz. cream	
Lemon curd	1.65	3.30	3.30	6.60	6.60	13.23	8.82	14.33	13.23	26.45
	101.4 - 23.67 fl. oz. lemon juice		25.36 - 33.80 fl. oz. lemon juice		33.80 - 67.63 fl. oz. lemon juice		67.63 - 135.26 fl. oz. lemon juice		135.26 - 202.88 fl. oz. lemon juice	
Fruit jelly	3.30	5.50	5.50	11.02	4.40	11.02	11.02	20.94	19.84	41.89
	17.64 - 35.27 oz. fruit puree		5.27 - 70.55 oz. fruit puree		52.91 - 70.55 oz. fruit puree		70.55 - 141.10 oz. fruit puree		141.09 - 282.19 oz. fruit puree	
Mousseline cream	2.20	4.85	4.40	9.92	8.82	13.23	12.13	19.84	26.46	37.48
	16.90 - 33.80 fl. oz. milk		33.80 - 67.63 fl. oz. milk		60.87 - 94.68 fl. oz. milk		84.54 - 135.26 fl. oz. milk		135.26 - 270.50 fl. oz. milk	
Bechamel	4.40	8.82	8.82	14.33	8.82	17.64	15.43	22.05	22.05	44.09
	50.72 - 101.44 fl. oz. milk		84.54 - 167.07 fl. oz. milk		101.44 - 202.89 fl. oz. milk		135.26 - 270.50 fl. oz. milk		270.50 - 540.63 fl. oz. milk	
Butter cream	4.40	6.60	6.60	9.92	6.60	13.23	11.02	18.74	22.05	37.48
	21.16 - 38.80 oz. butter		38.80 - 88.19 oz. butter		70.55 - 123.46 oz. butter		88.19 - 173.37 oz. butter		176.37 - 352.74 oz. butter	
Pâte à bombe, Chocolate pâte à bombe	/	28.22	28.22	56.44	35.27	70.55	53.00	105.80	105.80	229.28
	11.30 - 11.30 oz. egg yolk		11.30 - 22.58 oz. egg yolk		15.70 - 31.40 oz. egg yolk		22.58 - 45.17 oz. egg yolk		45.17 - 88.18 oz. egg yolk	
Pâte à choux	/	/	/	0.01	0.01	0.02	0.01	0.03	/	/
			67.63 - 67.63 fl. oz. liquid		67.63 - 101.44 fl. oz. liquid		67.64 - 135.26 fl. oz. liquid			
Mousse	4.40	6.60	5.50	11.02	8.82	15.43	68.63	22.05	26.46	44.09
Marshmallow	/	4.40	4.40	8.82	8.82	17.64	69.63	17.64	17.64	35.26
Italian, Swisse meringue, meringue for macarons	2.20	3.30	2.20	6.60	4.40	8.82	70.63	13.23	17.64	26.46
Almond cream	2.20	4.40	4.40	8.82	6.60	12.13	71.63	17.64	17.64	26.46
Parisian flan	6.60	9.92	8.82	16.53	11.02	22.05	72.63	26.46	26.46	52.91
White, Dark, Milk chocolate tempering	/	6.60	8.82	15.43	11.02	19.84	73.63	22.05	26.46	52.91
Granita/Slush	3.30	6.60	4.40	11.02	6.60	15.43	74.63	22.05	17.64	44.09

pastry technology

Technical data

Trittico Executive and Trittico Evo

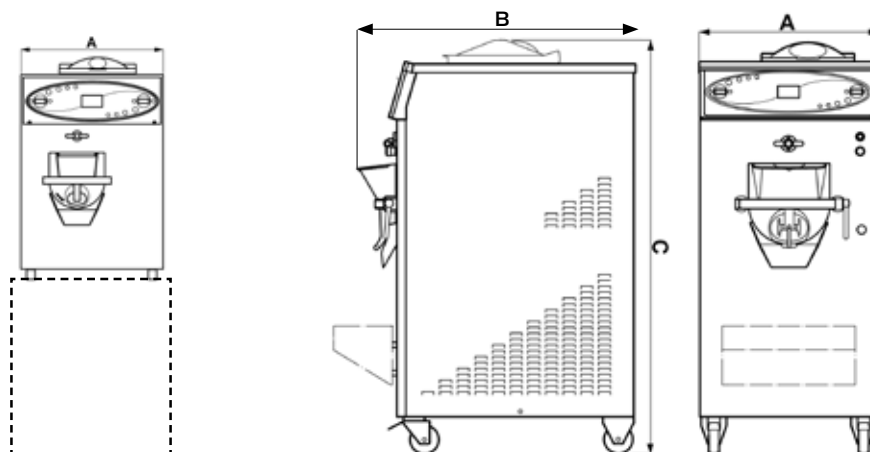

Models		183* water	305 water	457 water	610 water	1020 water
Min/Max production Gelato and Sorbet	lt/cycle gal/cycle	1.5 / 3 0.4 / 0.7	1.2 / 5 0.3 / 1.32	2 / 8.3 0.5 / 2.2	2.5 / 10 0.6 / 2.64	5 / 20 1.3 / 5.28
Power supply	V/Hz/Ph	230/60/3	230/60/3	230/60/3	230/60/3	230/60/3
Width (A)	inches	19.7	20	20	24	24
Depth (B)	inches	31.1	34.4	40.4	40.4	48.2
Height (C)	inches	30.7	55.1	55.1	55.5	56.7

*not available in the Executive model

The hourly production of the machines is subject to variations based on the type of mix used, the density of the finished product, and the conditions of the production environment.



**Complete
technical
data sheets**





**WE SHARE
THE SAME
PASSION
SINCE 1967**

BRAVO NORTH AMERICA INC
810 Tyvola Road, Suite 130, Charlotte, NC 28217
t. +1980 237 2474
e. info@bravonorthamerica.com

bravonorthamerica.com

