

TASCA

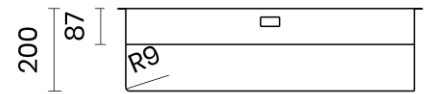

STEP 70

Materiale	AISI 304 18/10
Material	
Spessore	1 mm regolare
Thickness	1 mm regular
Finitura	Satinplus
Finish	
Base	80 cm
Cabinet	
Dim. esterne	740X440 mm
Ext. dim.	
Dim. vasca	700X400 mm
Bowl dim.	
Raggio	0 / 9 mm
Radius	
Altezza	200 mm
Height	
Troppopieno	Integrato
Overflow	Integrated
Piletta	Ø 114 mm Inox satinata
Waste	Ø 114 mm satin s.steel
Sifone	incluso
Siphon	Included
Installazione	Tripla (sopra - filo - sotto)
Installation	Triple (top - flush - undermount)
Dim. imballo	80x50x25 cm
Packaging dim.	
Peso	9,8 kg
Weight	
Codice	ST70F
Code	

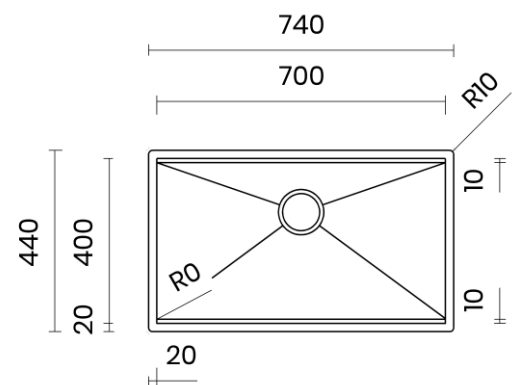



SCHEMI DI INCASSO / CUT-OUT SIZES

SOTTOTOP
Undermount

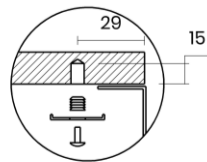
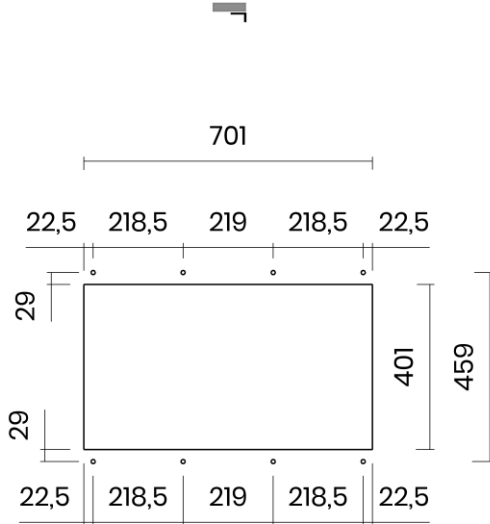

SOPRATOP
Topmount

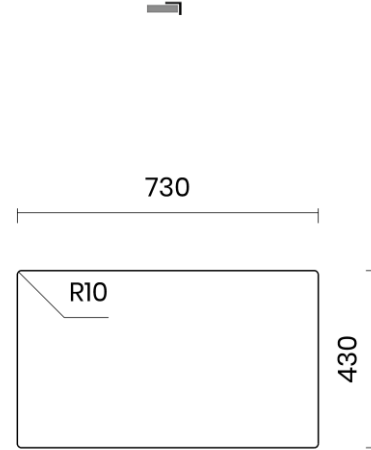

valido per installazione FILOTOP e SOPRATOP /
valid for FLUSHMOUNT and TOPMOUNT installation

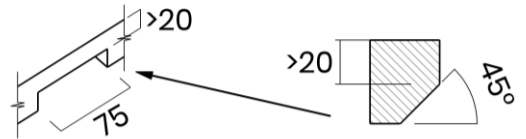

intaglio per troppopieno solo per top >20 mm
recess for housing the overflow only for top >20 mm

FILOTOP
Flushmount

