

TASCA

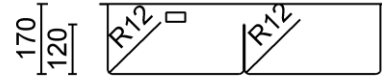

ICON 70

Materiale	AISI 304 18/10
Material	
Spessore	1 mm regolare
Thickness	1 mm regular
Finitura	Satinplus
Finish	
Base	75 cm
Cabinet	
Dim. esterne	702x440 mm
Ext. dim.	
Dim. vasca	2x 330x400 mm
Bowl dim.	
Raggio	12 mm
Radius	
Altezza	170 mm
Height	
Troppopieno	Integrato
Overflow	Integrated
Piletta	Ø 114 mm Inox satinata
Waste	Ø 114 mm satin s.steel
Sifone	incluso
Siphon	Included
Installazione	Tripla (sopra - filo - sottotop)
Installation	Triple (top - flush - undermount)
Dim. imballo	76x50x25 cm
Packaging dim.	
Peso	10,3 kg
Weight	
Codice	IC70F
Code	

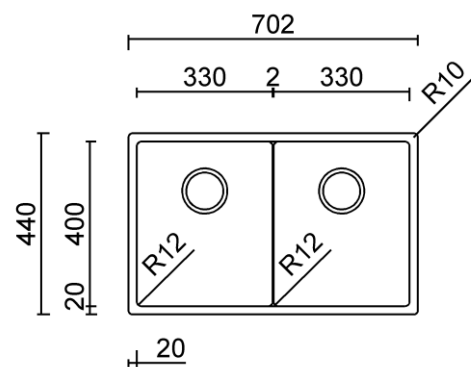



SCHEMI DI INCASSO / CUT-OUT SIZES

SOTTOTOP
Undermount

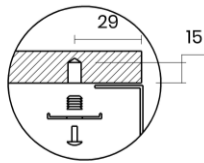
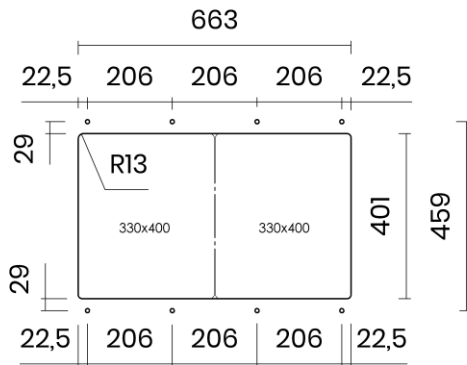

FILOTOP
Flushmount

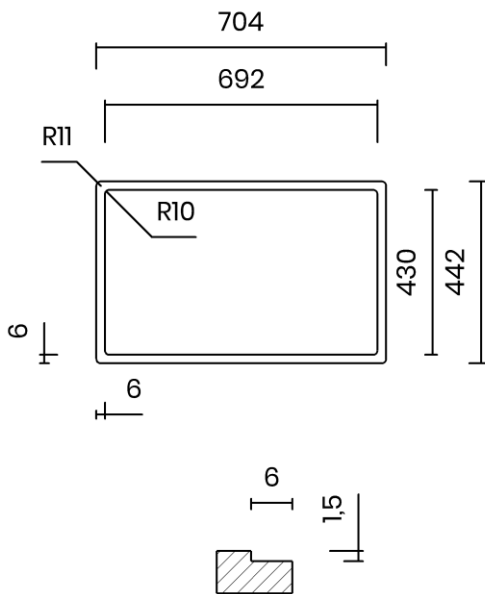

SOPRATOP
Topmount

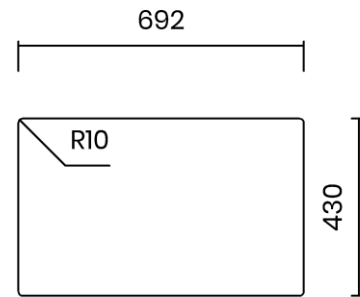

valido per installazione FILOTOP e SOPRATOP /
valid for FLUSHMOUNT and TOPMOUNT installation

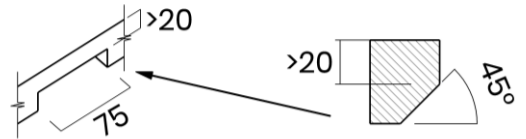

intaglio per troppopieno solo per top >20 mm
recess for housing the overflow only for top >20 mm