

DURABLE BY DESIGN

The robust, functional appearance of the meclean® Trailerpack models says everything about our approach to technology. Our philosophy is straightforward: technology must work. Day in, day out. That is why meclean® consistently chooses proven, mechanical technology - and leaves out everything that does not contribute to performance, reliability or serviceability. No unnecessary electronics. **No gimmicks. Just the best components, built to last.**

TAILORED TO YOUR NEEDS

Every meclean® Trailerpack can be fully configured to your requirements. With multiple models, an extensive options list and the expertise of our technical team, we always deliver the machine that fits your operation - exactly.

ENGINEERED IN-HOUSE, BUILT TO PERFORM

From the first sketch on the drawing board to final assembly - every meclean® Trailerpack is developed and built entirely in-house. This gives us full control over quality, and gives you a machine you can rely on.

100% FOSSIL-FREE / MULTI-FUEL READY

All meclean® diesel-powered models are fully compatible with fossil-free and alternative fuel types, including HVO100/XTL, NESTE, biodiesel (B100), Aspen Diesel, GTL, HVO20 and HVO50 - while remaining perfectly suited for conventional diesel fuel.

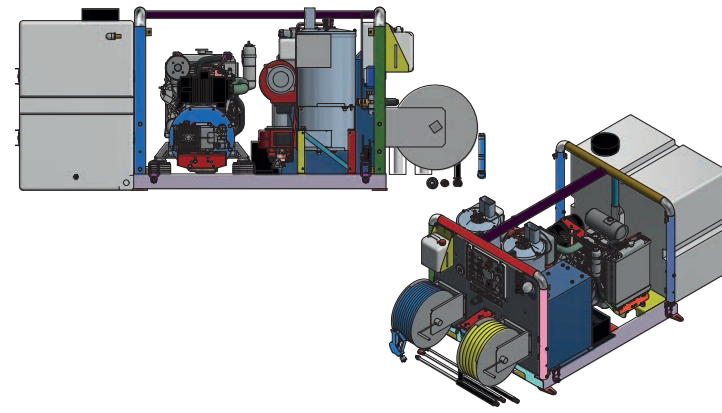

A Trailerpack always fits

The modular setup with different water tanks and hose reels at your choice make it possible to fit a Trailerpack in/on any commercial vehicle, trailer or pick-up truck.

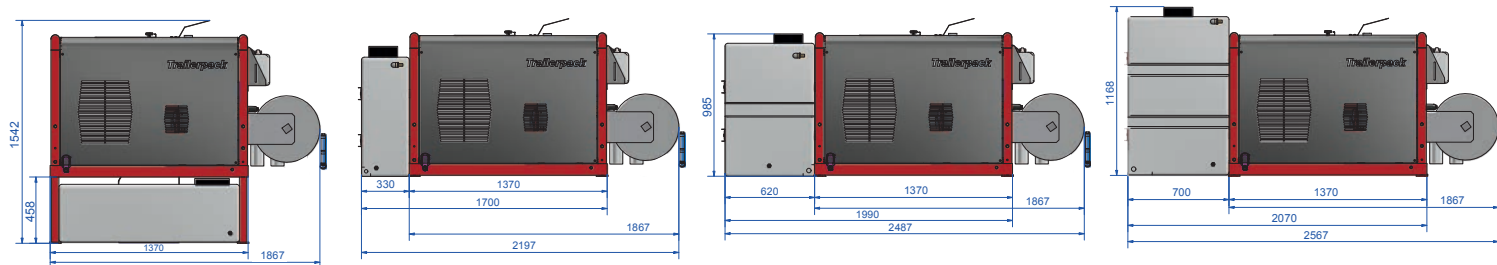

DIFFERENT CLEANING TECHNIQUES COMPARED:

traditional (hot)water high-pressure cleaning, AquaPLUS® and SteamPLUS®

TECHNICAL COMPARISON	WATER (<100 °C)	AquaPLUS®	SteamPLUS®
Water	100% water	90% water	10% water
Steam	-	10% steam	90% steam
Temperature (max)	102 °C	110 °C	150 °C
Working pressure	0 - 500 bar*	0 - 500 bar*	0 - 250 bar

*depending on model



MULTI-FUEL

emission advantages compared to diesel

	HVO100
Fossil-free	100%
CO	-24%
CO ₂	-90%
NO _x	-9%
Soot / particulate matter emission	-33%



	TP 200/15	TP 200/21	TP 200/30
Working pressure	200 bar	200 bar	200 bar
Water flow rate	15 L/min.	21 L/min.	30 L/min.
Max. engine / motor power	6,6 kW	10,2 kW	16,4 kW
High-pressure pump(s)	1	1	1
Heat exchanger(s)	1	1	2
100% Multi-fuel heat exchanger(s)	✓	✓	✓
100% Multi-fuel engine	Yanmar (air cooled)*	Yanmar*	Yanmar*
Max. water temperature	102 °C	102 °C	102 °C
Capacity fuel tank	70 L	70 L	70 L
Water tank 250 / 460 / 500 / 800L	option	option	option
SS hose reel 25 m (LP) + 45 m (HP)	option	option	option
SteamPLUS®	-	option***	-
AquaPLUS®	-	option	-
WeedPLUS®	option**	option**	option**
Weight unit without options	± 380 kg	± 410 kg	± 490 kg
Dimensions unit without options	----- (L)1370 x (W)1300 x (H)993 mm -----		

	TP 300/15	TP 350/18	TP 500/15	TPE 200/21 	TPE 250/15 
Working pressure	300 bar	350 bar	500 bar	200 bar	250 bar
Water flow rate	15 L/min.	18 L/min.	15 L/min.	21 L/min.	15 L/min.
Max. engine / motor power	10,2 kW	16,4 kW	16,4 kW	15 kW	15 kW
High-pressure pump(s)	1	1	1	1	1
100% Multi-fuel heat exchanger(s)	1	1	1	1	1
100% Multi-fuel engine	✓	✓	✓	electric motor	electric motor
Engine / motor type	Yanmar*	Yanmar*	Yanmar*	PMS-IPM motor	PMS-IPM motor
Battery type and capacities	-	-	-	Lithium LiFePO4 • 240 / 320 / 400 Ah	
Max. water temperature	102 °C	102 °C	102 °C	102 °C	102 °C
Capacity fuel tank	70 L	70 L	70 L	70 L	70 L
Water tank 250 / 460 / 500 / 800L	option	option	option	option	option
SS hose reel 25 m (LP) + 45 m (HP)	option	option	option	option	option
SteamPLUS®	option	option	option	option	option
AquaPLUS®	option	option	option	option	option
WeedPLUS®	option**	option**	option**	option**	option**
Weight unit without options	± 410 kg	± 440 kg	± 450 kg	± 530 - 580 kg	± 530 - 580 kg
Dimensions unit without options	----- (L)1370 x (W)1300 x (H)993 mm -----				

* compliant with Stage 5 ** DUO version available *** Model TP 200/21 gives up to 200 bar working pressure in SteamPLUS® mode

Warranty

- 2 years (in combination with service agreement)
- 10 years on high-pressure pump head

Quick and professional service...

With different service locations throughout Europe and availability of technicians worldwide we are able to guarantee a response time of max. 24 hours everywhere in the world. In most cases the service needs can be resolved within a couple of hours and often on location.

Demonstration?

Contact your dealer or meclean® to schedule a demonstration on location.

meclean® • functional cleaning power | t: +31 (0)115 43 25 30 | e: info@meclean.eu | www.meclean.eu

Sales & service:



URBAN CLEANING LINE

meclean®
functional cleaning power

Trailerpack
built-in/on modular unit

100%
HVO100
FOSSIL-FREE FUEL READY
up to 90% less emission

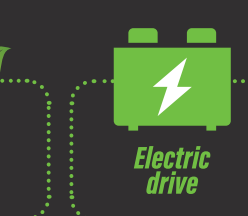

Engineered to perform Trailerpack

built to last • functional technology - no unnecessary electronics



Also available as electric drive

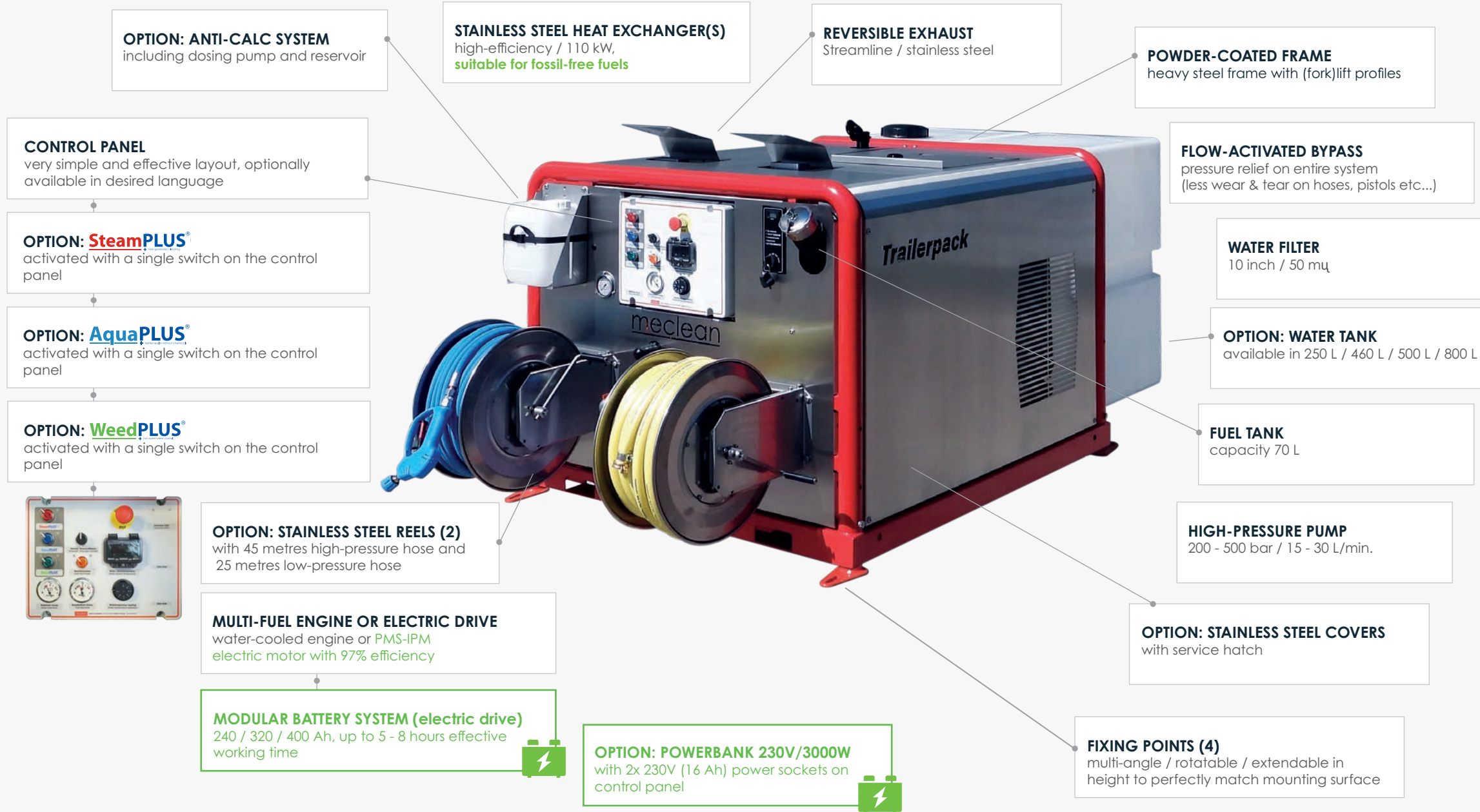

ELECTRIC DRIVE - SAME PERFORMANCE, MAXIMUM SUSTAINABILITY

The meclean® Trailerpack TPE electric models are built on the same no-nonsense philosophy as our diesel-powered versions. Functional technology, the best components and performance that lasts a full working day without recharging.

ENERGY-EFFICIENT DRIVE AND LITHIUM LiFePO4 BATTERY

The high-pressure pump is driven by a next-generation PMS-IPM electric motor with 97% efficiency - at least 10% more efficient than conventional electric motors. Combined with high-quality LiFePO4 lithium batteries, the result is a machine that is explosion-proof, lightweight and built for up to 4,000 charging cycles. No full charge required before use.

SteamPLUS®



SteamPLUS® is a patented cleaning function, activated with a switch on the control panel.

- ✓ temperature ±150 °C
- ✓ balanced mix of 90% steam and 10% water
- ✓ working pressure up to 250 bar
- ✓ steam volume ±17.000 L/min.
- ✓ water volume ±1 L/min.

With an additional steam/heat exchanger, 17,000 litres of steam are produced. This enormous amount of steam creates a "thermoshock" which causes pollution to come off without damaging the surface. The steam pressure (**adjustable up to 250 bar**) delivers the working speed needed for large objects and buildings.

SteamPLUS® is used and recommended by companies specialised in facade cleaning of monumental buildings.

Where and when SteamPLUS® ?

- ✓ When chemicals cannot be used and the surface is susceptible to damage
- ✓ SteamPLUS® is suitable - unlike AquaPLUS® - for damage-sensitive surfaces such as facades with weaker joints, monumental buildings, sandstone objects, wooden objects, etc.
- ✓ SteamPLUS® removes graffiti, paint layers, chewing gum, atmospheric pollution, algae and moss, fungi, oil and resin, adhesive layers, road markings, etc. - without chemicals
- ✓ Effective disinfection and odour control due to the high steam content

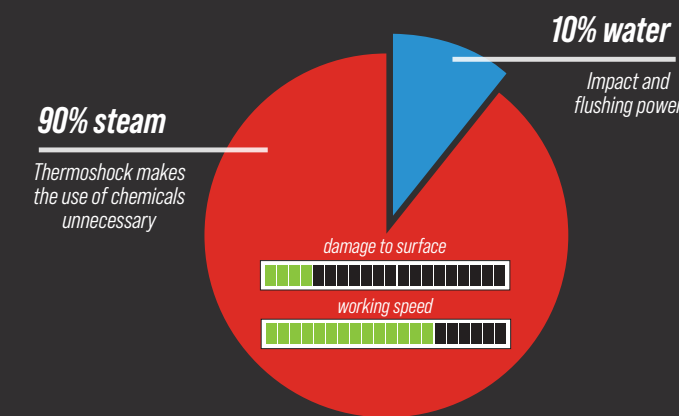

Facade cleaning: without chemicals and damage



Chewing gum removal: in less than 2 seconds (2.000 - 3.000 pieces per hour)

AquaPLUS®

AquaPLUS® bridges the gap between traditional hot water high-pressure cleaning and SteamPLUS®. Activated with a switch on the control panel.

- ✓ temperature ±110 °C
- ✓ balanced mix of 10% steam and 90% water
- ✓ working pressure up to 500 bar
- ✓ steam volume ±1.600 L/min
- ✓ water volume: 14 - 20 L/min. (model dependent)

*AquaPLUS® is only possible in combination with SteamPLUS®

AquaPLUS® is a cleaning function between traditional (hot) water high-pressure cleaning and SteamPLUS®. The balanced mix of superheated water and steam combines the benefits of both. Water provides impact and flushing power, while the moderate steam content still creates a thermoshock effect. So no chemicals are needed for perfect cleaning results.

Where and when AquaPLUS® ?

- ✓ When chemicals cannot be used and the surface is not susceptible to damage
- ✓ AquaPLUS® in some cases cleans at a higher speed than SteamPLUS®, because the percentage of water is higher. However, the higher water percentage also causes more surface impact compared to SteamPLUS®.
- ✓ AquaPLUS® is suitable for industrial cleaning and removes graffiti, paint layers, atmospheric pollution, resin, adhesive layers, road markings, etc. - without chemicals.

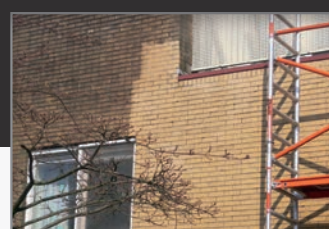
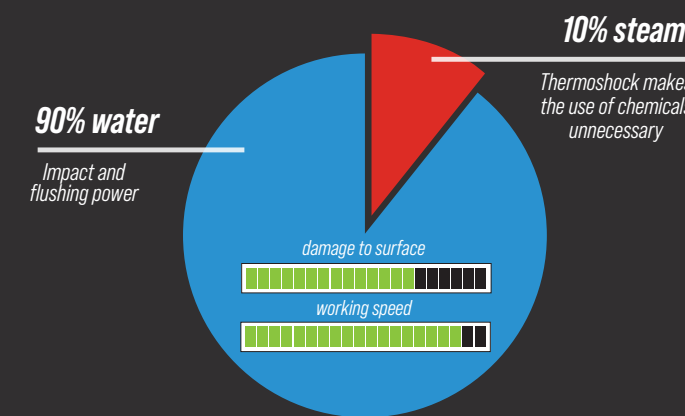

Facade cleaning



Graffiti removal: without chemicals

WeedPLUS®

WeedPLUS® is a hot water weed control function, activated with a switch on the control panel.

- ✓ stabilized water temperature 99 °C
- ✓ working pressure 1 - 5 bar
- ✓ water volume ±12 L/min. (up to 25 L/min.)

Fighting weeds with WeedPLUS® is possible everywhere. With the shower nozzle and spray bar on wheels, it is possible to work extremely selectively without collateral damage.

Because working speed is up to 30% higher than other weed control methods, and up to 60% fewer treatments are required, WeedPLUS® is also the most economical choice. With WeedPLUS®, a maximum of 2,000 m² per hour can be treated.

Proven to be most effective

- ✓ only 4 treatments per year (compared to 8 treatments with hot air / burning)
- ✓ substantially lower weed percentage throughout the year (compared to all other methods)

Hot water weed control has been researched by the University of Copenhagen (Prof. P. Kristoffersen) and is clearly the most effective alternative weed control method. (see diagram below):

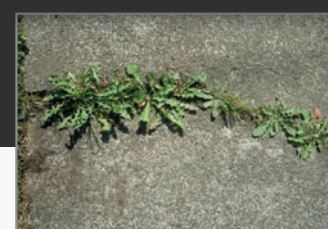
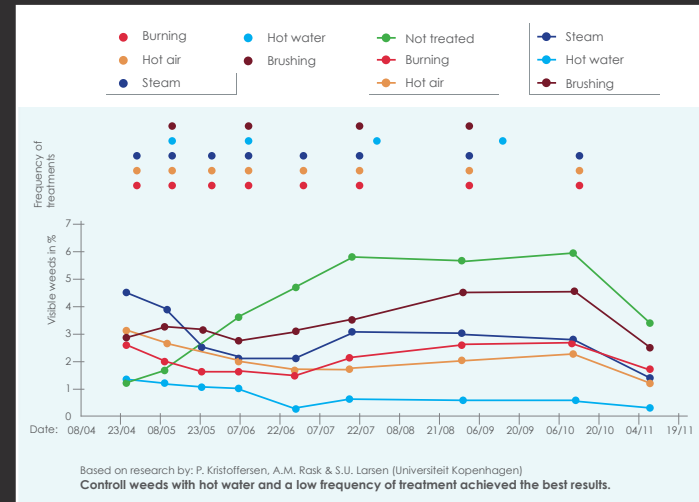

Weeds on pavement



Weeds on pavement 2 - 5 days after treatment



meclean® is a SIR (Stichting Industriële Reiniging) member. If desired a Trailerpack can be delivered with SIR certification.



SteamPLUS® and AquaPLUS® comply with all applicable laws and regulations such as CE and PED (Pressure Equipment Directive) and are safe for users according to the rules included in the Working Conditions Act