

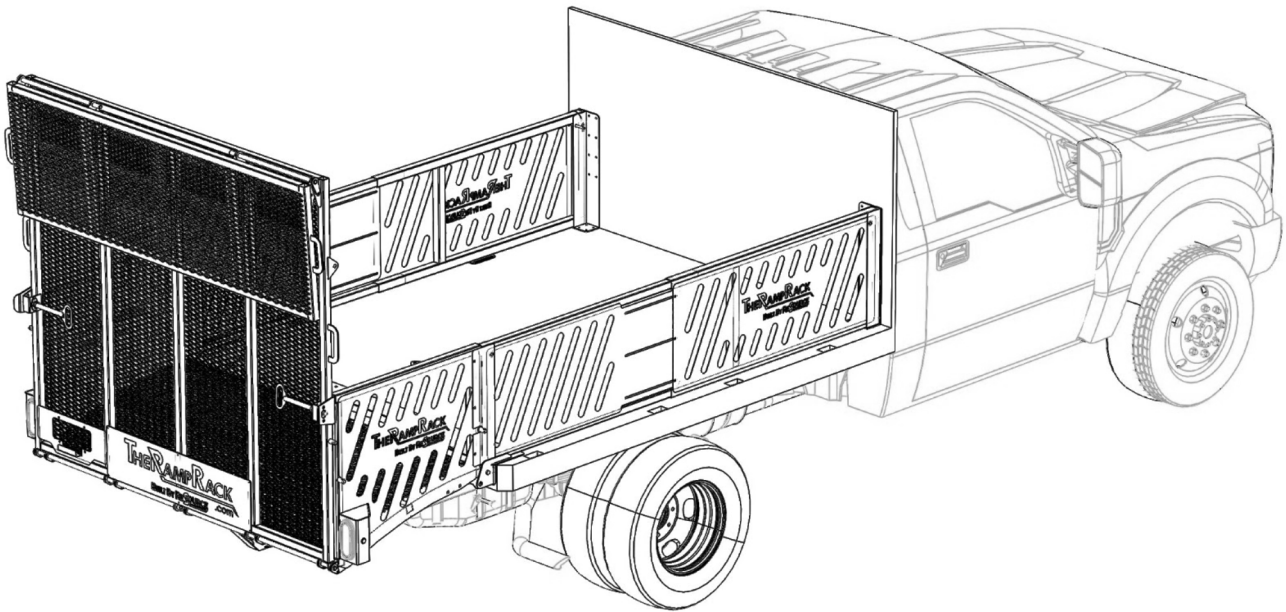

ST - Series Assembly Instructions

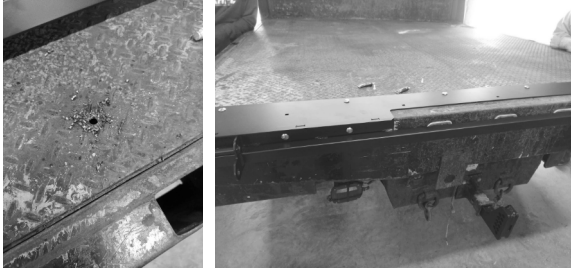

**** Unit Pictured Includes Optional Sides****

Step Number	Description	Images
1	Remove license plate.	
2	Install rear “L” flatbed bracket onto back of bed by drilling (12) $\frac{3}{8}$ ” holes (6-top & 6-rear) and installing with (12) $\frac{3}{8}$ ” x 1 $\frac{1}{2}$ ” carriage bolts and (12) $\frac{3}{8}$ ” flange nuts . Use the provided threadlocker .	
3	Install adjustable “A” frame onto dovetail with (6) $\frac{3}{8}$ ” x $\frac{3}{4}$ ” carriage bolts and (6) $\frac{3}{8}$ ” flange nuts . Use threadlocker to secure bolts. This should be installed in the detailed position for your vehicle.	
4	Install gate latch pin on each side of the ramp . Secure each with (2) $\frac{1}{4}$ ” x 1 $\frac{1}{4}$ ” bolts and (2) $\frac{1}{4}$ ” lock nuts .	
5	If you purchased a QD-200 please install that now. See your QD-200 install instructions, then proceed to the next step.	

6

Install **adjustable hitch** into 2" receiver. Do not install a hitch pin yet. Some trucks may require a sleeve.

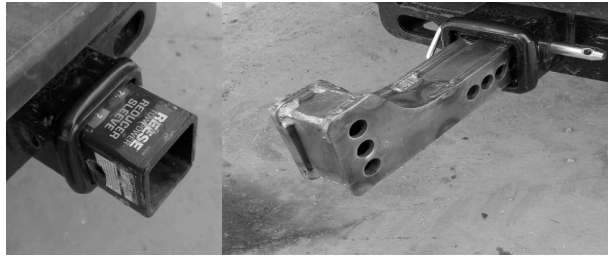







7

Lift **dovetail** and hook over rear **flatbed "L" bracket** that was previously installed on rear of bed. Insert **(2) 6" pins with handle** and secure with **(2) 7/16" lynch pins**.

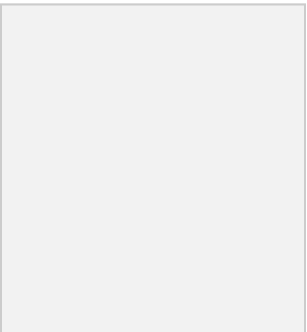

****Three people are recommended for this step****

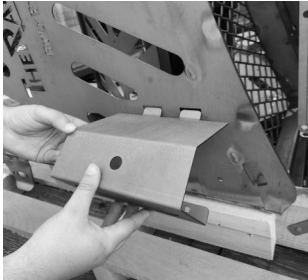

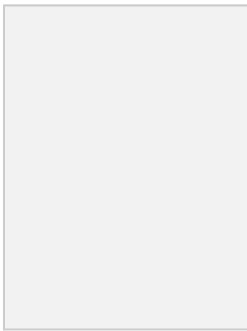

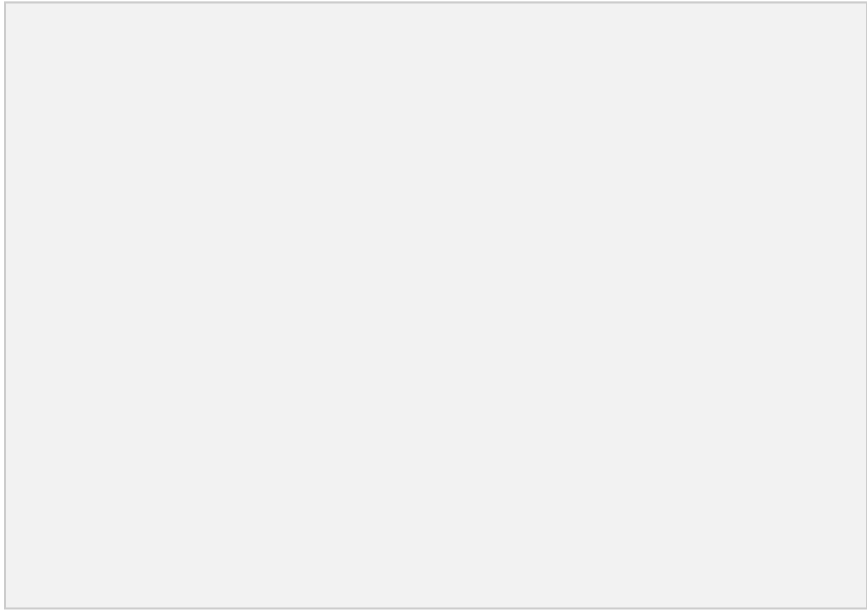

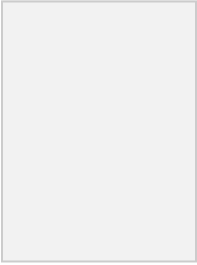



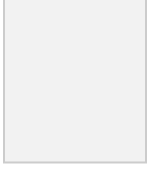

<p>8</p>	<p>Lift dovetail to desired height (should be level with bedside) and install a $\frac{5}{8}$" hitch pin in the adjustable "A" frame first, then another $\frac{5}{8}$" hitch pin into the adjustable hitch.</p> <p>**Three people are recommended for this step**</p>	
<p>9</p>	<p>Attach 6' ramp to dovetail with (2) 40" ramp pins (ensure the teardrop is down). Install a $\frac{3}{8}$" x $\frac{3}{4}$" flange bolt and $\frac{3}{8}$" flange nut in each. Use provided threadlocker.</p> <p>**Three people are recommended for this step**</p>	 
<p>10</p>	<p>Attach 2' ramp extension to bottom of 6' ramp using (2) 22" ramp pins (ensure teardrop is down). Install a $\frac{3}{8}$ x $\frac{3}{4}$" flange bolt and $\frac{3}{8}$" flange nut in each. Use the provided threadlocker.</p>	

<p>11</p>	<p>Lift the gate into an upright position and attach (2) lift assist gate springs and (2) lengths of chain with (6) quicklinks, use threadlocker to secure the quicklinks. It is IMPORTANT to install safety cable and safety cable clamps in case of spring failure.</p>	
<p>12</p>	<p>Install light box housing into slots on each side of the dovetail with (2) 1/4" x 1/2" carriage bolt and (2) 1/4" flange nut per side.</p>	
<p>13</p>	<p>Place (4) extruded U-nuts over pre-drilled holes in the license plate bracket. Secure tag with (4) 1/4" stainless steel screws.</p>	
<p>14</p>	<p>The wiring harness should be run through the pre-cut slots in the bottom of the dovetail. Remove the rubber grommet from the light and secure it in place first, then press light into the housing. Repeat the same steps with side marker lights and tag light. Connect the wiring harness to a 4 flat trailer plug or use a 7 pin adapter.</p>	
<p>15</p>	<p>Ensure all bolts are tightened down as needed.</p>	



ST-100 Parts List		
Part Name	Image	Pieces
Dovetail		1
6' Ramp		1
"L" Bracket		1

Adjustable "A" Frame		1
Adjustable Hitch		1
2' Ramp Extension		1
Lightbox Housing		1 Set
6" Pin with Handle		2
Gate Latch Pin		2
Ramp Pin 40"		2
Ramp Pin 22"		2
Lift Assist Spring		2

Length of Chain		2
Threadlocker *Please use on all bolts for added security*		1
Wiring Harness		1
5/8" Hitch Pins		2
7/16" Lynch Pins		2
3/8" x 1 1/2" Carriage Bolt		12
3/8" x 3/4" Carriage Bolt		6
3/8" Flange Nuts		22
3/8" x 3/4" Flange Bolt		4
1/4" x 1 1/4" Bolt		4

<p>1/4" Lock Nut</p>		<p>4</p>
<p>1/4" x 1/2" Carriage Bolt</p>		<p>4</p>
<p>1/4" Flange Nut</p>		<p>4</p>
<p>Quicklinks</p>		<p>6</p>
<p>Extruded "U" Nut</p>		<p>4</p>
<p>Stainless Steel Screw</p>		<p>4</p>
<p>Safety Cable 7'</p>		<p>2</p>
<p>Safety Cable Clamps</p>		<p>4</p>
<p>Black Zip Ties</p>		<p>6</p>