

# *Hi-Well* *200 Amp Bushing Well*

**Central Moloney, Inc.**  
**Components Operation**  
An ISO 9001 Certified Company

## Product Data Sheet

File No.	PDS1037	Issued:	January 14, 2010
Availability:	Immediate	Supercedes:	November 1, 2008

## Convert that pole type transformer to a 'deadtop' elbow connected unit!



*Hi-Well Bushing Application*



*Hi-Well Bushing Assemblies*

## The CMI 'Hi-Well' Solution

**Introduction** Central Moloney Components developed the 'Hi-Well' 200 amp bushing well over 30 years ago to fill the need for a bushing well that could easily replace the primary porcelain bushing on a pole type transformer. This bushing design continues to be an economically attractive option to utilities that have need to convert stock, live top, pole type transformers to transformers fed by shielded underground cable connected with ANSI 200 amp separable cable accessories.

Without modification to the tank cover, the CMI Hi-Well directly replaces common aerial bushings used on distribution transformers. The universal (3) bolt internal clamp provides easy mounting, regardless of

the original bushing clamp style. Two shank lengths are available to duplicate the original primary shank length. Two straight bushing styles are available to fit the common mounting hole sizes and the A-30 style is available where a 60-degree tilt of the bushing well is advantageous.

An optional feature (available only on the straight models) is a field replaceable internal bushing well stud. This option provides quick repair of bushing wells if the stud is broken due to excessive torque upon insert installation. This option can save the time and labor of returning the unit to a repair shop and avoids the cost of a replacement bushing well.

## Hi-Well – *Very Convenient, Reduced Transformer Cost*

**Application** Distribution pole type transformers up to 25KV class can be modified using the CMI Hi-Well. These modified transformers are typically used in dry vaults, building vaults, or fenced substations where live top primary voltage is deemed hazardous. Shielded primary connections utilizing the Hi-Well can also provide a solution to applications where line spacing or wildlife outage problems exist.



### Electrical Ratings

Voltage Class	25 KV
Maximum Line to Ground	17.0 KV
Impulse (BIL)	125 KV
AC (1 Minute)	40 KV
DC (15 Minutes)	78 KV
Corona Voltage Level (minimum)	19 KV
Continuous Current	200 Amps
Short Time Current – 3 seconds	3500 Amps
Short Time Current - .17 seconds	10,000 Amps

**Testing** The CMI HI-Well meets or exceeds the design requirements of ANSI/IEEE Standard 386 as applicable to bushing wells.

# Outline Dimensions

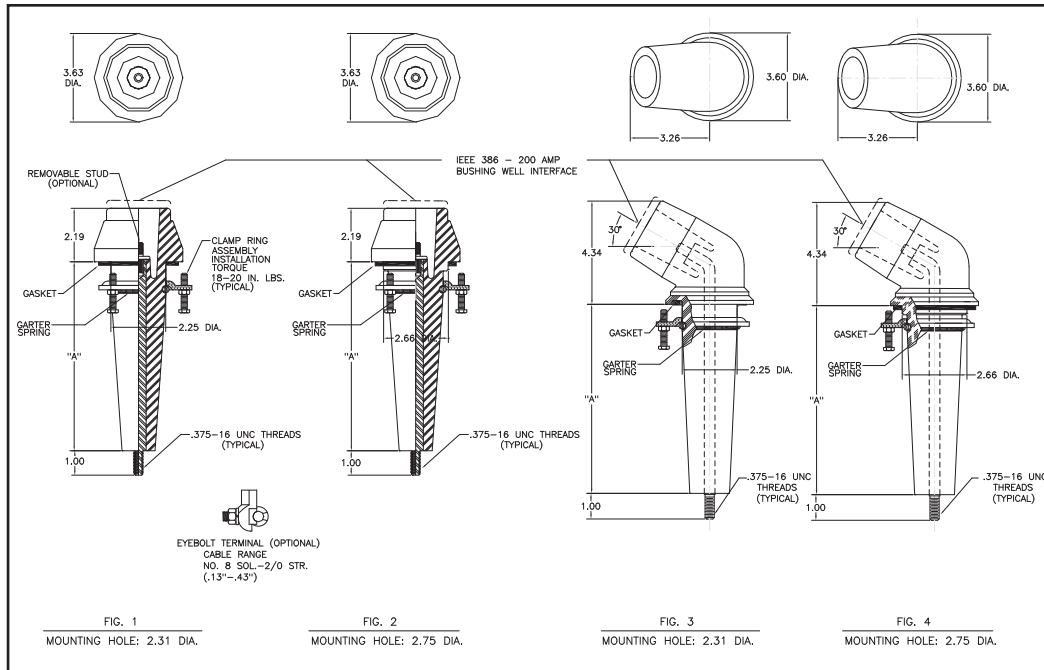

## Hi-Well Ordering Information

Mtg Hole (inches)	Part No.	Fig	Head Style	'A' Dim. (inches)	Stud Type	Hardware Packing	Clamp Ass'y	Terminal
2.31	70212152	1	Straight	7.75	Fixed	Bulk	Yes	Stud
2.31	70212153	1	Straight	7.75	Fixed	Individual	Yes	Stud
2.31	70212163	1	Straight	7.75	Fixed	Bulk	No	Eyebolt
2.31	70212164	1	Straight	7.75	Fixed	Bulk	Yes	Eyebolt
2.31	70212182	1	Straight	7.75	Rem	Bulk	Yes	Stud
2.31	70212185	1	Straight	7.75	Rem	Bulk	Yes	Stud
2.31	70212195	1	Straight	7.75	Fixed	Bulk	No	Stud
2.31	70213152	1	Straight	10	Fixed	Bulk	Yes	Stud
2.31	70213153	1	Straight	10	Fixed	Individual	Yes	Stud
2.31	70213155	1	Straight	10	Fixed	Individual	Yes	Stud
2.31	70213163	1	Straight	10	Fixed	Bulk	No	Eyebolt
2.31	70213164	1	Straight	10	Fixed	Bulk	Yes	Eyebolt
2.31	70213181	1	Straight	10	Rem	Bulk	No	Stud
2.31	70213182	1	Straight	10	Rem	Bulk	Yes	Stud
2.31	70213185	1	Straight	10	Rem	Individual	Yes	Stud
2.31	70213192	1	Straight	10	Rem	Bulk	Yes	Eyebolt
2.31	70212274	3	Angled	7.75	Fixed	Kitted	Yes	Stud
2.31	70212272	3	Angled	7.75	Fixed	Bulk	Yes	Stud
2.31	70213275	3	Angled	10	Fixed	Individual	Yes	Stud
2.31	70213272	3	Angled	10	Fixed	Bulk	Yes	Stud
2.75	70212702	2	Straight	7.75	Fixed	Bulk	Yes	Stud
2.75	70212703	2	Straight	7.75	Fixed	Individual	Yes	Stud
2.75	70212704	2	Straight	7.75	Fixed	Bulk	Yes	Eyebolt
2.75	70212705	2	Straight	7.75	Fixed	Individual	Yes	Eyebolt
2.75	70212752	2	Straight	7.75	Rem	Bulk	Yes	Stud
2.75	70212753	2	Straight	7.75	Rem	Individual	Yes	Stud
2.75	70212754	2	Straight	7.75	Rem	Bulk	Yes	Eyebolt
2.75	70212755	2	Straight	7.75	Rem	Individual	Yes	Eyebolt
2.75	70213702	2	Straight	10	Fixed	Bulk	Yes	Stud
2.75	70213703	2	Straight	10	Fixed	Individual	Yes	Stud
2.75	70213704	2	Straight	10	Fixed	Bulk	Yes	Eyebolt
2.75	70213705	2	Straight	10	Fixed	Individual	Yes	Eyebolt
2.75	70213752	2	Straight	10	Rem	Bulk	Yes	Stud
2.75	70213753	2	Straight	10	Rem	Individual	Yes	Stud
2.75	70213754	2	Straight	10	Rem	Bulk	Yes	Eyebolt
2.75	70213755	2	Straight	10	Rem	Individual	Yes	Eyebolt
2.75	70212802	4	Angled	7.75	Fixed	Bulk	Yes	Stud
2.75	70212803	4	Angled	7.75	Fixed	Individual	Yes	Stud
2.75	70213802	4	Angled	10	Fixed	Bulk	Yes	Stud
2.75	70213803	4	Angled	10	Fixed	Individual	Yes	Stud

Bulk packed hardware consists of mounting components bagged in the same quantity as the box count. Individual hardware packing consists of mounting components packed one bag per bushing.



200 Amp Bushing Wells



600 Amp Bushings



Air Insulated Bushings

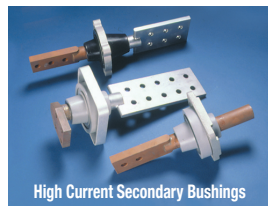

High Current Secondary Bushings



Secondary Bushings

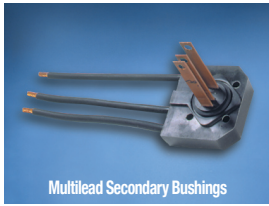

Multilead Secondary Bushings



Drip Shields

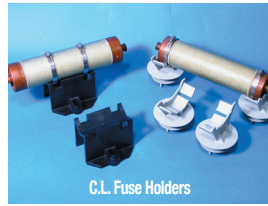

C.L. Fuse Holders



Network Bushings



Test Bushings

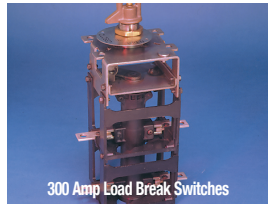

300 Amp Load Break Switches

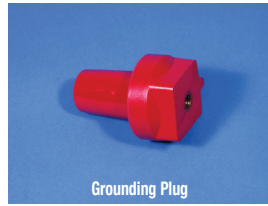

Grounding Plug

## Check Out Our Other Products



Loop Feed Bushings

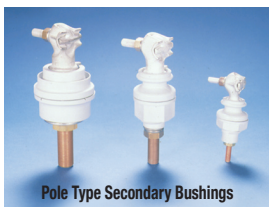

Pole Type Secondary Bushings



Shedmount TI

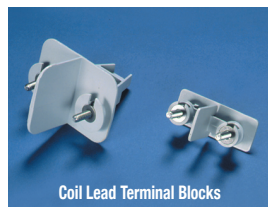

Coil Lead Terminal Blocks



Wildlife Guards

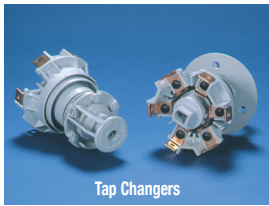

Tap Changers

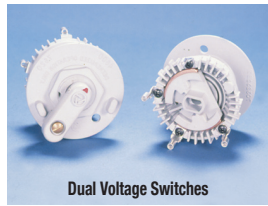

Dual Voltage Switches



Weld Flange Secondary Bushings

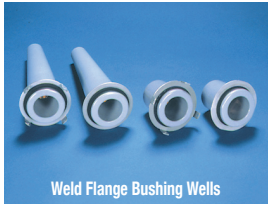

Weld Flange Bushing Wells

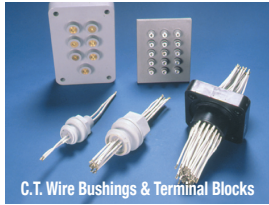

C.T. Wire Bushings & Terminal Blocks



Mega Guard



Line Apparatus Animal Guards

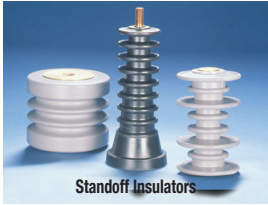

Standoff Insulators

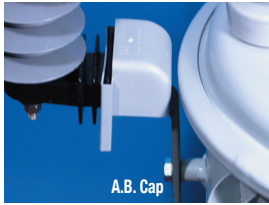

A.B. Cap

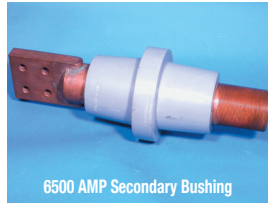

6500 AMP Secondary Bushing

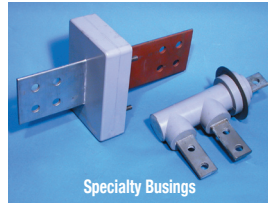

Specialty Bushings



Central Moloney Components has a rich tradition of serving the OEM, distributor, and utility electrical markets with innovative, state-of-the-art polymer products for more than 40 years. Extensive inventory of common items allows rapid shipments on your emergency needs. To discuss how we can partner in meeting your current and future needs, please contact us at the factory or call your local agent .

## Central Moloney, Inc. Components Operation

An ISO 9001 Certified Company

5500 Jefferson Parkway Pine Bluff, AR 71602 Tel. 870-247-5320 Fax 870-247-5369  
Email: info@cmicom.com Website: www.centramoloneyinc.com