

Garla Shower Tray

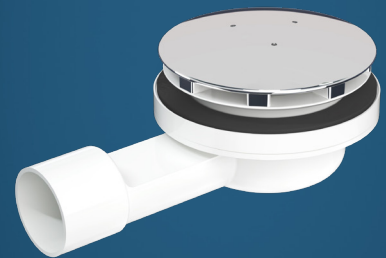

Featuring the
unique **LO-SEAL** trap



PRODUCT
SPECIFICATION
GUIDE

CCL
SHOWER
TRAYS

MARKET LEADING SHOWER TRAY SOLUTIONS

At CCL Shower Trays we lead the way in the development of advanced drainage and waterproofing solutions to meet the demands of today's modern construction methods. We're proud to present our range of exciting and innovative shower tray solutions including:

- The unique **LO-SEAL** shower tray trap
- A range of low profile slimline shower trays
- A comprehensive range of sizes
- Solutions for all floor types
- Design & specification service

GUARANTEE

Not all guarantees are the same - at CCL Shower Trays we understand the challenges faced by all stakeholders, from the initial design and specification, right through to the installation and beyond.



LIFETIME PRODUCT GUARANTEE

We offer a Lifetime Guarantee across our entire range of products, including the trap:

- Complete guarantee – Shower tray and trap
- Incorporating our unique and proven Lo-Seal Trap technology
- Shower tray waterproofing

CONTENTS

INTRODUCTION

PRODUCT INFORMATION

LIFETIME GUARANTEE

5 | SHOWER TRAYS

5.1 **GARLA SHOWERTRAY**

SHOWER TRAY - FEATURING THE UNIQUE
LO-SEAL TRAP

INTRO

5.1



Garla Shower Tray with **LO-SEAL** Trap

By combining the innovative design of our well established **LO-SEAL** trap with a sleek low profile shower tray, we are able to offer a shower tray solution suitable for any floor construction, without the need for a large step.

The tray can be recessed into the substrate or installed directly onto the floor, simplifying the installation even within the shallowest of floor build-ups, making it ideal for both refurbishment and new build projects.

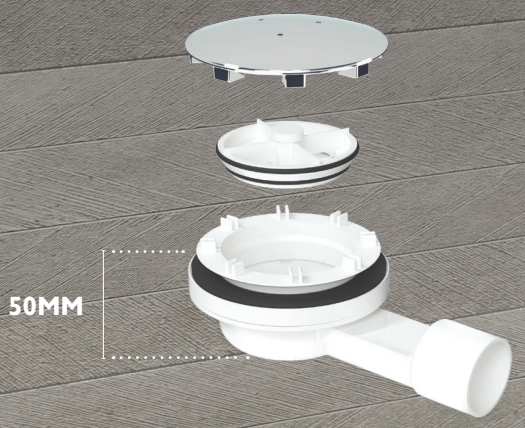





GARLA SHOWER TRAY

INTRODUCTION



GARLA SHOWER TRAY



LO-SEAL TRAP



LOW PROFILE



STONE RESIN



NO ODOURS



EASY CLEAN



NBS Source PARTNER

KEY FEATURES

The Garla shower tray is a stylish low profile stone resin tray available in a wide range of sizes.

When combined with our unique **LO-SEAL** trap it allows a shower tray to be installed with a minimal build-up, making it ideal for use on concrete or screeded floors

or similar applications where the depth of a traditional waterseal trap may present a problem.

Another benefit of the **LO-SEAL** trap is that it remains sealed when not in use, therefore preventing odours from entering the bathroom, even when not in use for long periods.

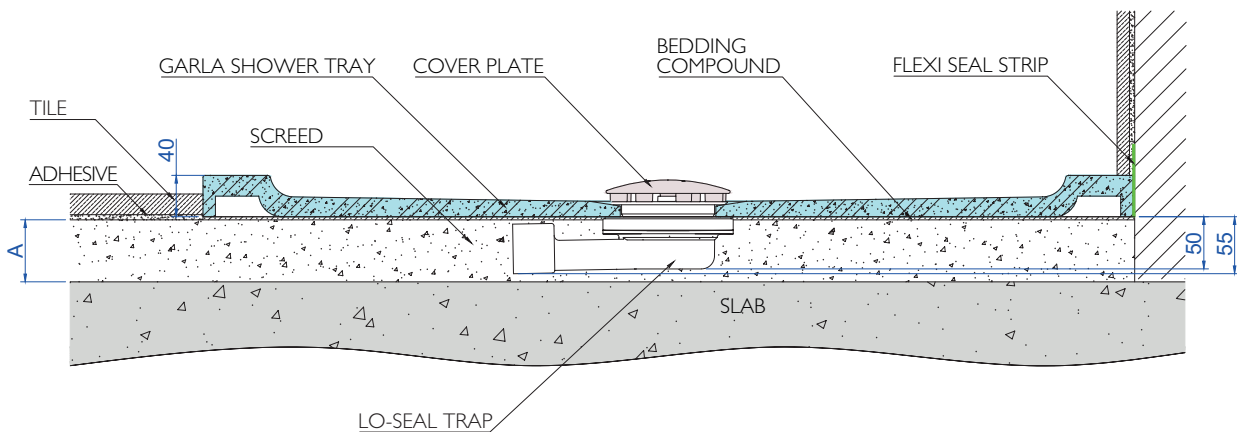

DIMENSION A: MIN - 50mm (Assumes outlet is directly next to SVP) DRAWN AS: 60mm

KEY FEATURES

- Low profile shower tray - only 40mm deep
- Stone resin
- High performance scratch resistant coating
- Available in a large range of sizes
- Suitable for most types of shower enclosure
- **IO-SEAL** Waterless Trap - only 50mm deep
- Trap remains closed when not in use
- No odours can enter the room
- Flow rate up to 29 L/min ^{‡1}
- Lifetime Guarantee

5.1



GARLA SHOWER TRAY

^{‡1} Flow rates indicated are a guide only, based upon 42mm waste pipe and swept bends.

HOW TO SPECIFY

- Start by selecting the required size of shower tray - choose from square, rectangular or quadrant options.
- Then select the type of trap - choose from the shallow **LO-SEAL** waterless trap or the standard waterseal options.
- Finally add any accessories.

1 SELECT TRAY SIZE

Choose from either a rectangular, square or quadrant design.
See pages 7-9 for available sizes



5.1



2 SELECT WASTE

Choose from either the shallow **LO-SEAL** waterless trap, or a standard waterseal trap.
See pages 10-11 for details



LO-SEAL TRAP



STANDARD WATERSEAL TRAPS

3 SELECT ACCESSORIES

Choose from a range of accessories.

- Shower Tray Waterproofing Kit
- Flexi-Seal Kit

See page 13 for details



GARLA SHOWER TRAY

The Garla shower tray is a 40mm deep low profile tray, manufactured from stone resin with a high performance scratch resistant acrylic cap, making it extremely durable and easy to keep clean. Available in a large range of sizes, the flat top design makes it suitable for most types of shower enclosure.

Its sturdy construction makes it quick and easy to install, whether it's recessed into the substrate or installed directly onto the floor. A flexible upstand kit is also available, along with a waterproofing kit for the walls ensuring the installation remains watertight at all times.

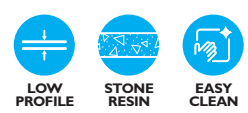
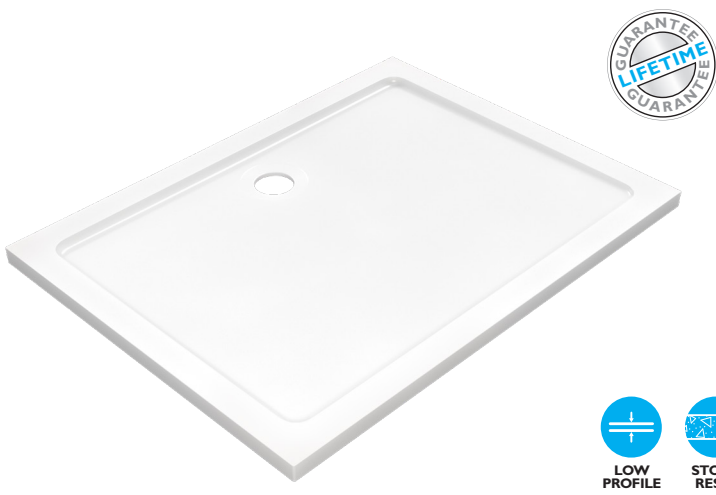

KEY FEATURES

- Low profile shower tray - only 40mm deep
- Mineral stone resin core
- High performance scratch resistant coating
- Available in a large range of sizes
- Suitable for most types of shower enclosure
- Quick & easy to install
- 90mm Waste aperture
- Complies with BS EN 14527
- Lifetime Guarantee

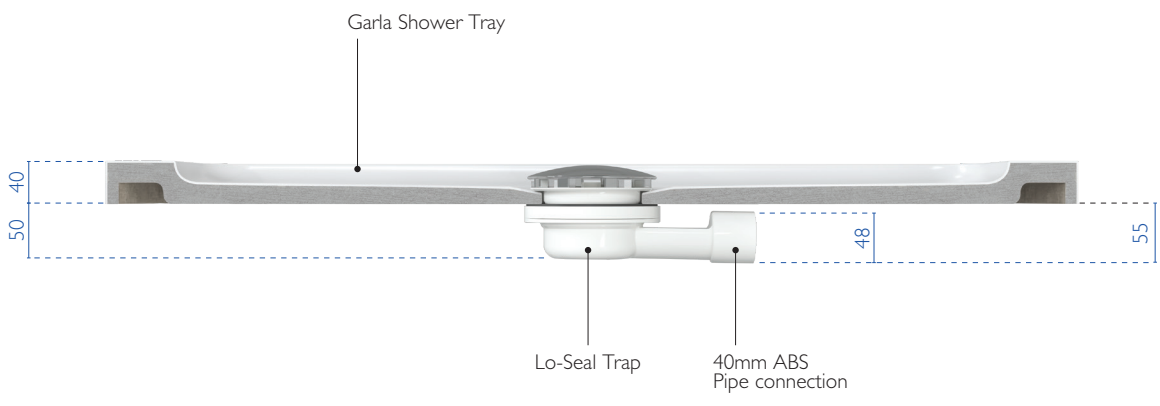
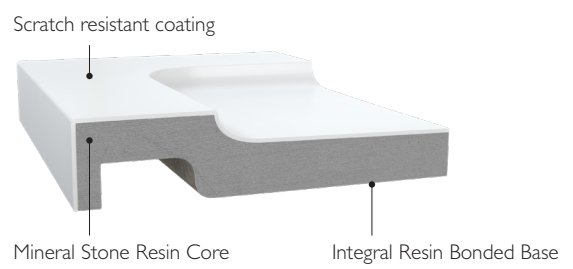

5.1



GARLA SHOWER TRAY

GARLA TRAY SIZES

The Garla shower tray is available in a large range of sizes, from a small square tray right up to a full size bath replacement.

Other sizes available, please contact our technical department for further information.

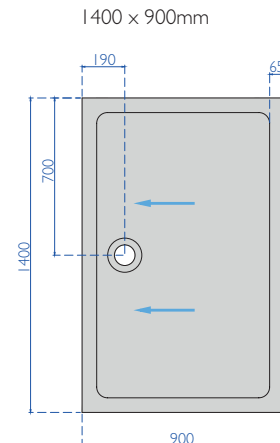
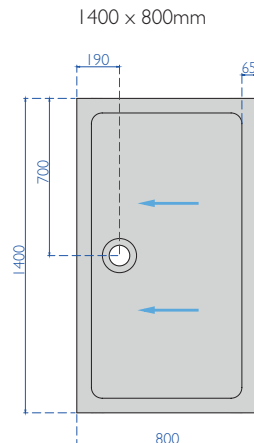
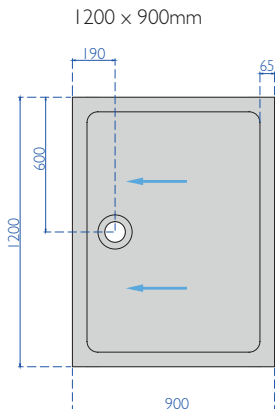
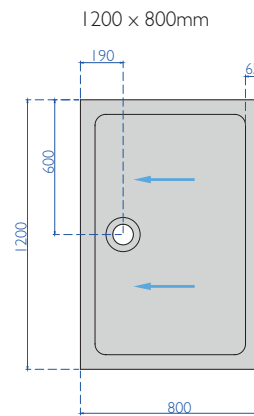
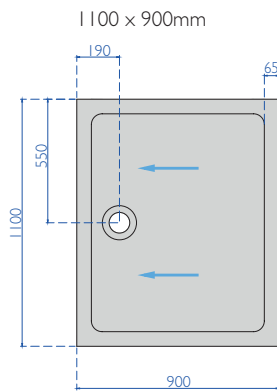
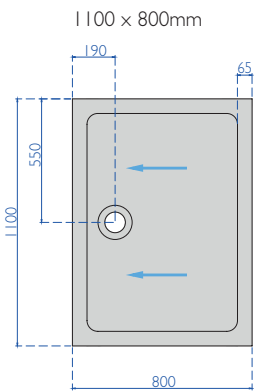
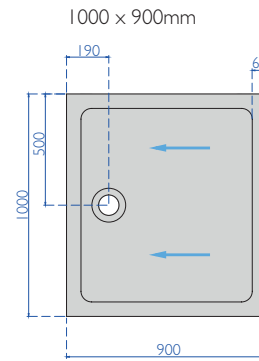
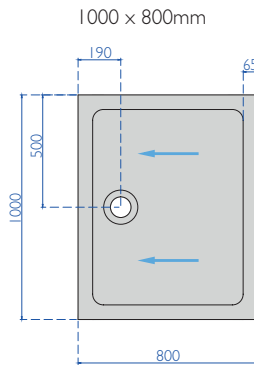
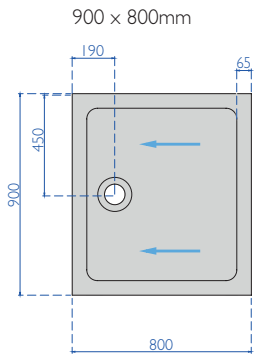
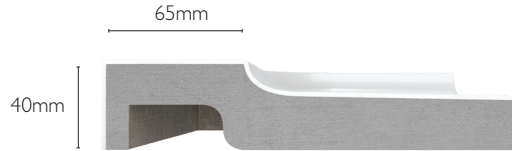

5.1



GARLA SHOWER TRAY

GARLA TRAY SIZES

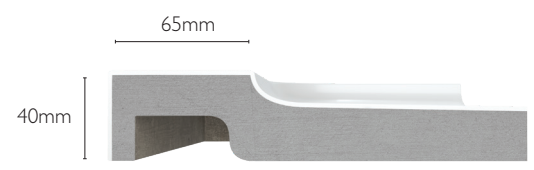

1500 x 800mm

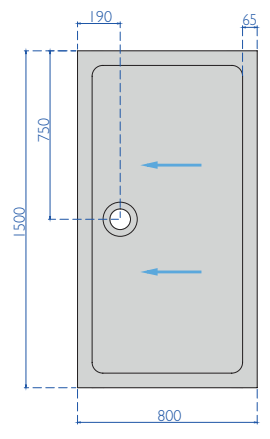

1500 x 900mm

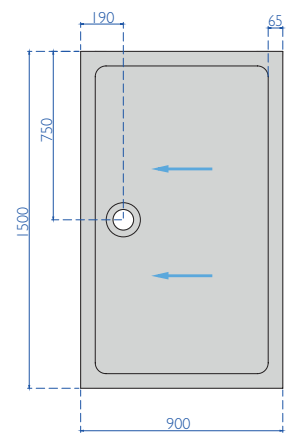

1700 x 800mm

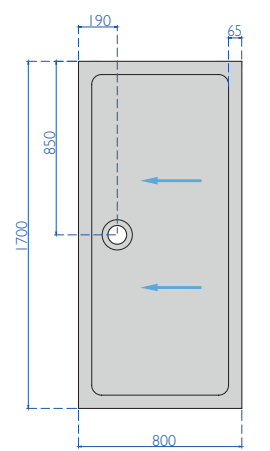

1700 x 900mm

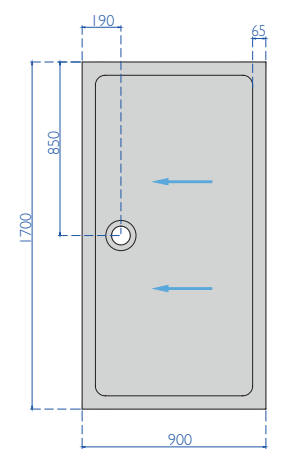

1800 x 800mm

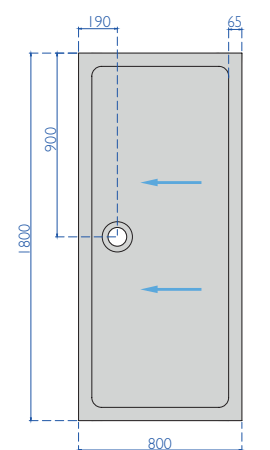

1800 x 900mm

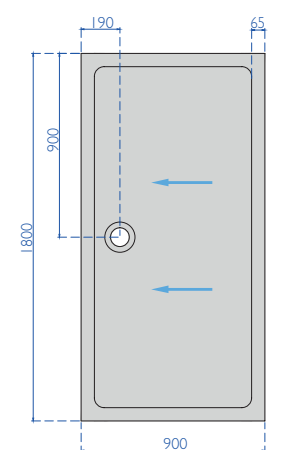

See p14/15 for product codes

WE'RE HERE TO HELP
0844 327 6002

5.1



GARLA SHOWER TRAY

GARLA TRAY SIZES

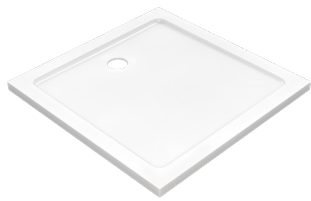

900 x 900mm

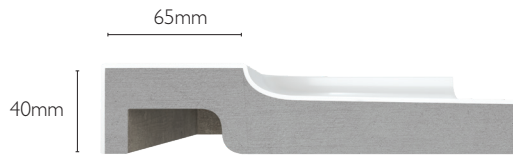
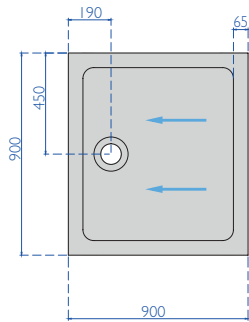

1000 x 1000mm

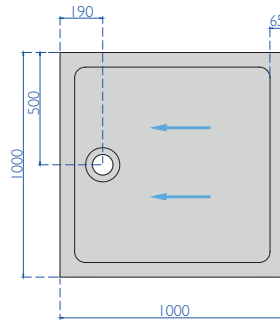

800 x 800mm

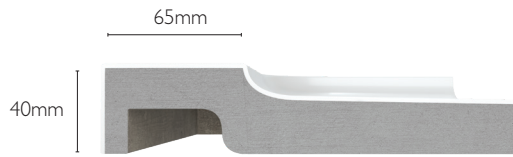
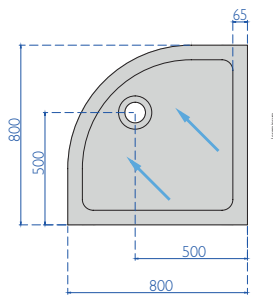

900 x 900mm

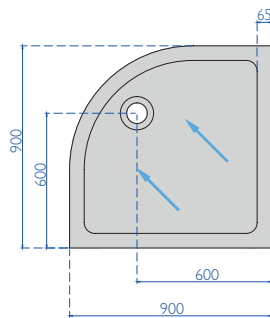

See p14/15 for product codes

5.1



LO-SEAL TRAP

The unique **LO-SEAL** waterless trap has been specially designed with a spring-loaded valve which keeps the trap sealed when not in use. This ensures that even when left unused for prolonged periods the trap remains airtight, making it ideal for situations where the shower is not in everyday use.

At only 50mm deep the trap allows the shower tray to be installed with a minimal build-up, making it ideal for use on concrete or screeded floors or similar applications where the depth of a traditional waterseal trap may present a problem. The innovative design of the trap allows it to be rotated through 360° enabling installation in most scenarios with ease.

5.1

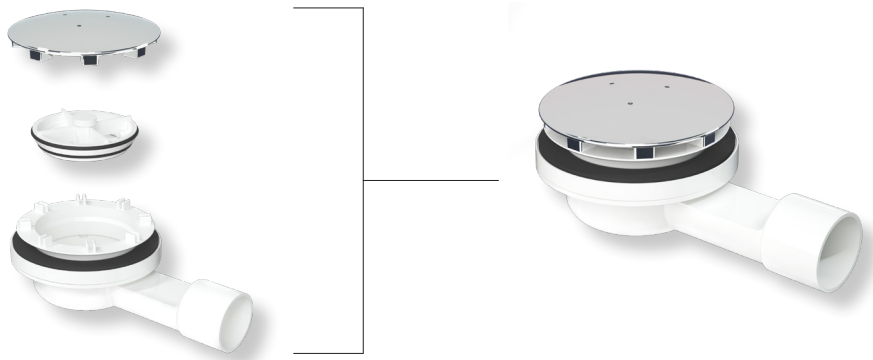

- LOW PROFILE
- NO ODOURS
- QUICK & EASY
- EASY CLEAN

KEY FEATURES

- Shallow trap - only 50mm deep
- Trap remains closed when not in use
- No odours can enter the room
- Easy to clean and replace trap
- Flow rate up to 29 L/min[‡]
- Lifetime Guarantee

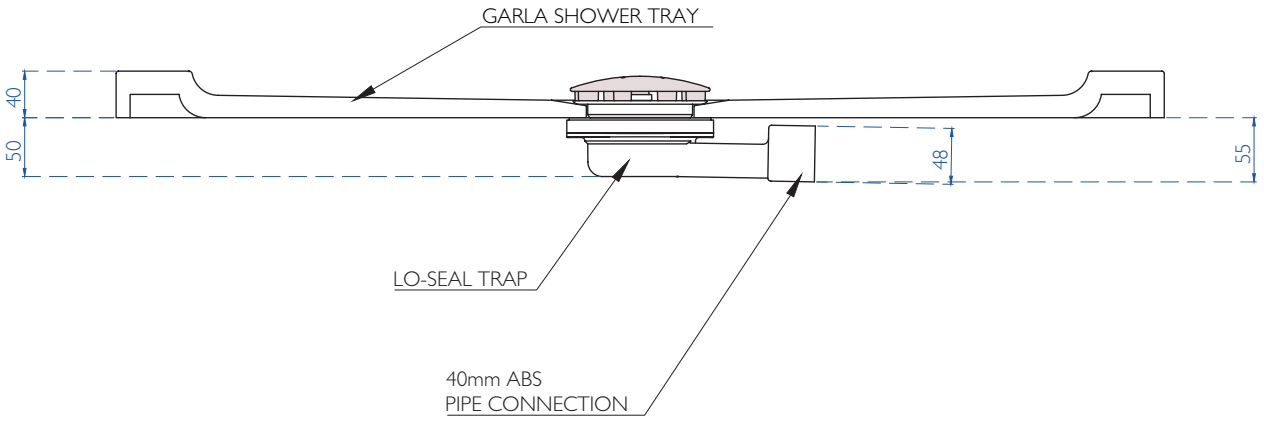
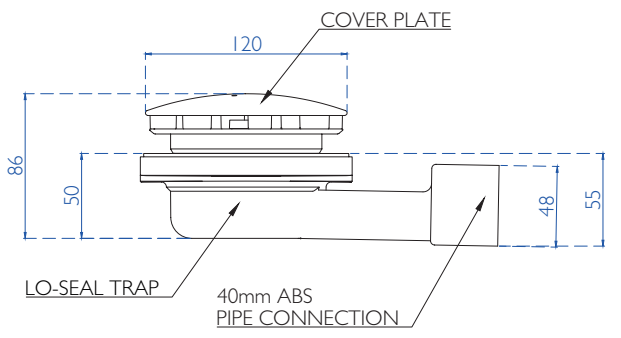

[‡] Flow rates indicated are a guide only, based upon 42mm waste pipe and swept bends. See p14/15 for product codes

LO-SEAL TRAP

NO ODOURS

The innovative design of the trap allows the valve to open when in use, then gradually closes again as the volume of water decreases.

When the shower is not in use the valve remains sealed, ensuring no odours can enter the room. This makes it particularly suitable in instances where the shower is not in regular use, avoiding the need to regularly top up the waterseal trap.

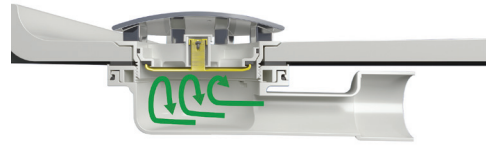

FLOW RATE

The trap has a maximum flow rate is 29 litres per minute, this is based upon an installation using 42mm waste pipe with swept bends.

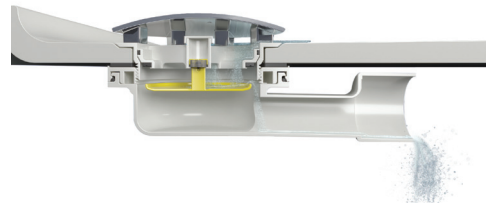

5.1



WATERSEAL TRAP

HORIZONTAL

The horizontal trap incorporates an adjustable ball joint, allowing for ease of installation.

- 50mm Waterseal
- 40mm Universal pipe connection
- Flow rate up to 25 L/min †¹

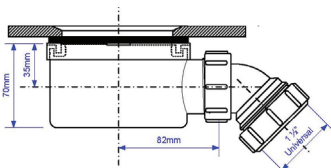

VERTICAL

The vertical trap allows the outlet to be positioned through the floor and connected to a waste pipe below.

- 50mm Waterseal
- 50mm Universal pipe connection
- Flow rate up to 25 L/min †¹

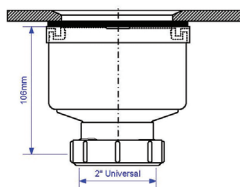

†¹ Flow rates indicated are a guide only, based upon 42mm waste pipe and swept bends. See p14/15 for product codes



GARLA SHOWER TRAY



ACCESSORIES

FLEXI-SEAL STRIP

A self-adhesive flexible strip for use on one, two or three sides of the tray to create a watertight upstand between the shower tray and the wall.

Available in 2.8m & 3.8m lengths.

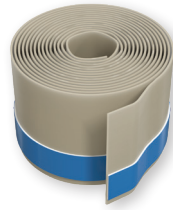

SHOWER TRAY WATERPROOFING KIT

The Shower Tray Waterproofing Kit is designed for waterproofing wall surfaces, niches and similar critical details prior to the application of natural stone, porcelain and ceramic tiles.

Developed specifically for use with shower trays, it is quick and easy to apply, providing a consistent waterproof layer, which is guaranteed not to leak.

The kit contains a primer, a single coat acrylic paste and waterproofing tape.

Available in two sizes

5kg Kit - For smaller tray sizes

8kg Kit - For larger tray sizes

See p14/15 for product codes.





- Shower Tray
- Flexi-Seal Strip
- Waterproofing Tape
- Shower Tray Waterproofing Membrane



PRODUCT CODES

GARLA SHOWER TRAY - SUPPLIED WITH TRAP

SHOWER TRAY SIZE		LO-SEAL WATERLESS TRAP	HORIZONTAL WATERSEAL TRAP	VERTICAL WATERSEAL TRAP
		 29 L / min †	 25 L / min †	 25 L / min †
A	B			
900mm	800mm	STGA-09X08/LICR	STGA-09X08/HICR	STGA-09X08/VICR
1000mm	800mm	STGA-10X08/LICR	STGA-10X08/HICR	STGA-10X08/VICR
1000mm	900mm	STGA-10X09/LICR	STGA-10X09/HICR	STGA-10X09/VICR
1100mm	800mm	STGA-11X08/LICR	STGA-11X08/HICR	STGA-11X08/VICR
1100mm	900mm	STGA-11X09/LICR	STGA-11X09/HICR	STGA-11X09/VICR
1200mm	800mm	STGA-12X08/LICR	STGA-12X08/HICR	STGA-12X08/VICR
1200mm	900mm	STGA-12X09/LICR	STGA-12X09/HICR	STGA-12X09/VICR
1400mm	800mm	STGA-14X08/LICR	STGA-14X08/HICR	STGA-14X08/VICR
1400mm	900mm	STGA-14X09/LICR	STGA-14X09/HICR	STGA-14X09/VICR

		 29 L / min †	 25 L / min †	 25 L / min †
A	B			
1500mm	800mm	STGA-15X08/LICR	STGA-15X08/HICR	STGA-15X08/VICR
1500mm	900mm	STGA-15X09/LICR	STGA-15X09/HICR	STGA-15X09/VICR
1700mm	800mm	STGA-17X08/LICR	STGA-17X08/HICR	STGA-17X08/VICR
1700mm	900mm	STGA-17X09/LICR	STGA-17X09/HICR	STGA-17X09/VICR
1800mm	800mm	STGA-18X08/LICR	STGA-18X08/HICR	STGA-18X08/VICR
1800mm	900mm	STGA-18X09/LICR	STGA-18X09/HICR	STGA-18X09/VICR

† Flow rates indicated are a guide only, based upon 42mm waste pipe and swept bends.

5.1



GARLA SHOWER TRAY



PRODUCT CODES

GARLA SHOWER TRAY - SUPPLIED WITH TRAP

SHOWER TRAY SIZE		LO-SEAL WATERLESS TRAP	HORIZONTAL WATERSEAL TRAP	VERTICAL WATERSEAL TRAP
		 29 L / min ^{‡1}	 25 L / min ^{‡1}	 25 L / min ^{‡1}
900mm	900mm	STGA-09X09/LICR	STGA-09X09/HICR	STGA-09X09/VICR
1000mm	1000mm	STGA-10X10/LICR	STGA-10X10/HICR	STGA-10X10/VICR
		 29 L / min ^{‡1}	 25 L / min ^{‡1}	 25 L / min ^{‡1}
800mm	800mm	STGA-Q08X08/LICR	STGA-Q08X08/HICR	STGA-Q08X08/LICR
900mm	900mm	STGA-Q09X09/LICR	STGA-Q09X09/HICR	STGA-Q09X09/LHCR

^{‡1} Flow rates indicated are a guide only, based upon 42mm waste pipe and swept bends.

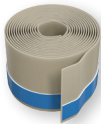
ACCESSORIES

FLEXI-SEAL STRIP	DESCRIPTION	CODE
	2.8m Roll Flexi-Seal Strip	STFS-2
	3.8m Roll Flexi-Seal Strip	STFS-3
WATERPROOFING KIT - WALLS	DESCRIPTION	CODE
	5kg Wall Waterproofing Kit - contains 5kg Liquid Membrane, 10m Waterproofing Tape, 500ml Primer	STWP-K5
	8kg Wall Waterproofing Kit - contains 8kg Liquid Membrane, 10m Waterproofing Tape, 1 Litre Primer	STWP-K8
	Additional Waterproofing Tape 10m	STWP-FT10
	Additional Primer 1 Litre	STWP-PR10



TYPICAL FLOOR BUILD-UPS

GARLA SHOWER TRAY ON SCREED FLOOR

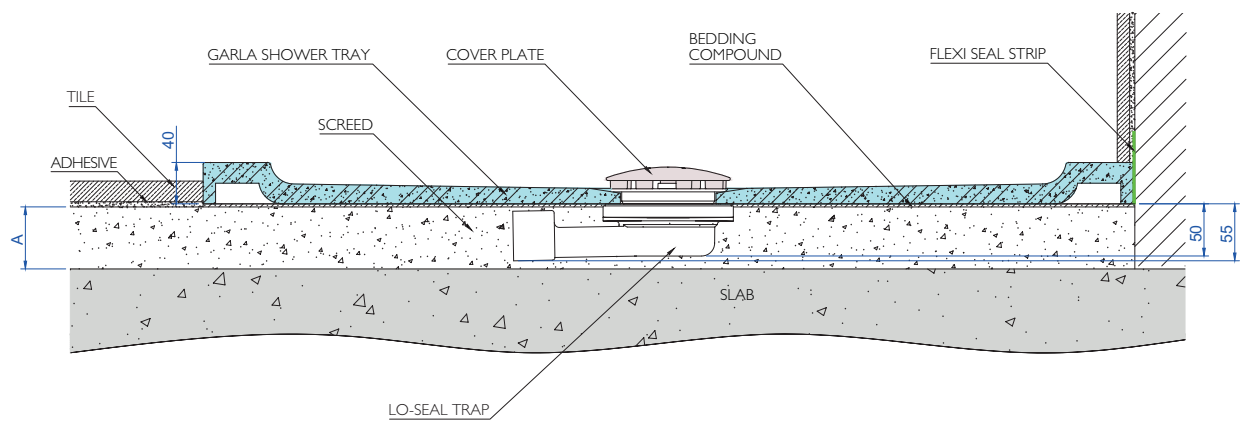

DIMENSION A: MIN - 50mm (Assumes outlet is directly next to SVP) DRAWN AS: 60mm

GARLA SHOWER TRAY SUNKEN ON SCREED FLOOR

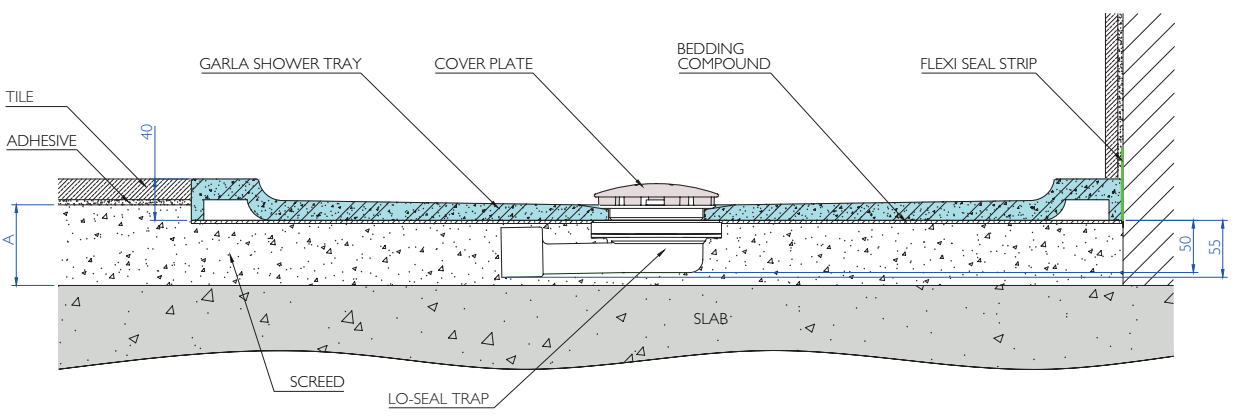

DIMENSION A: MIN - 50mm (Assumes outlet is directly next to SVP) DRAWN AS: 60mm

GARLA SHOWER TRAY ON PLINTH

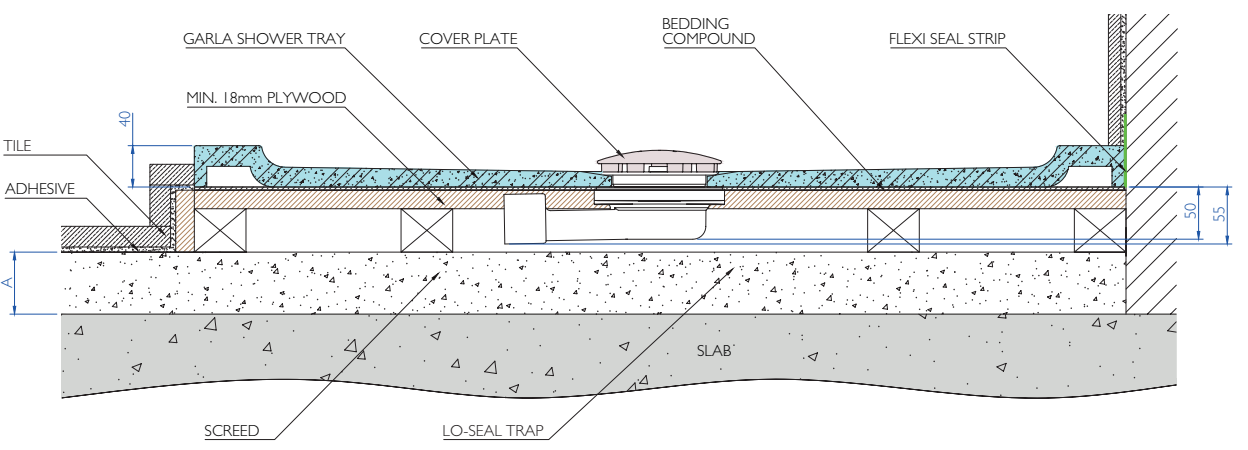

DIMENSION A: MIN - 50mm (Assumes outlet is directly next to SVP) DRAWN AS: 60mm

5.1



GARLA SHOWER TRAY

TYPICAL FLOOR BUILD-UPS

GARLA SHOWER TRAY ON TIMBER FLOOR

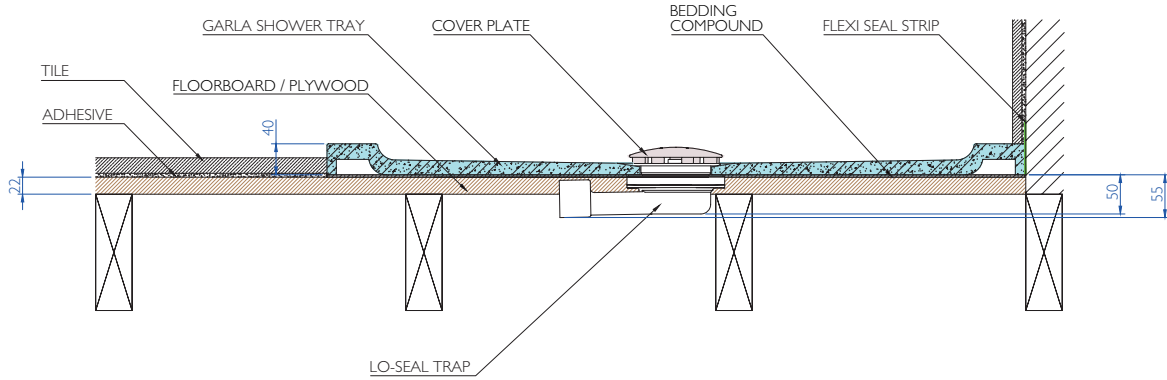

GARLA SHOWER TRAY SUNKEN ON TIMBER FLOOR

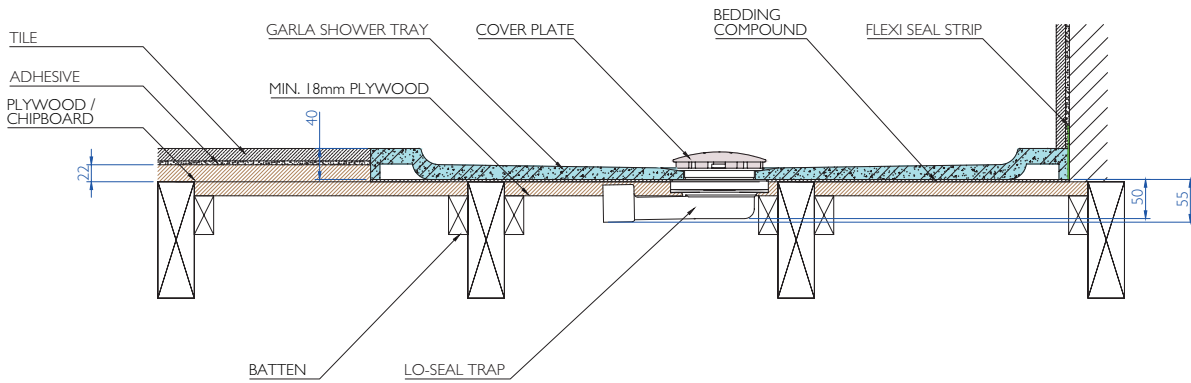

GARLA SHOWER TRAY ON ENGINEERED JOISTS

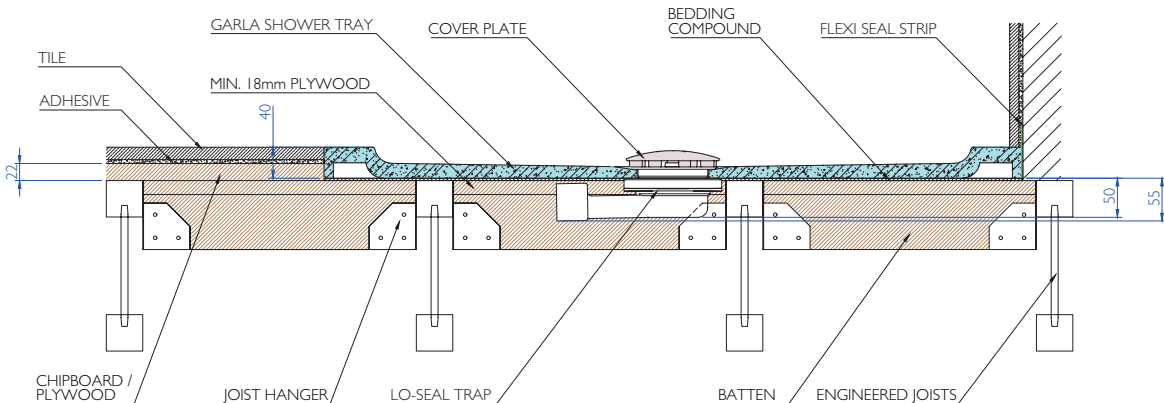

TECHNICAL ENQUIRIES

TEL: 0844 327 6002

technical@ccl-showertrays.co.uk
www.ccl-showertrays.co.uk



TECHNICAL SUPPORT

For technical assistance please contact our experienced technical department who will be happy to assist in the following:

- Project design
- Product specification
- CAD drawings
- Method statements

TECHNICAL SEMINARS

We are able to provide CPD based seminars designed to provide guidance on key shower tray and wetroom design considerations such as:

- Design and layout
- Drainage
- Waterproofing
- Flow rates

For further information please contact our technical department.

TECHNICAL ADVICE

Our team of technical advisors are able to visit you to provide a professional advisory service and assist with project design and specification.

We are also able to attend site to provide technical support and assistance.

For luxury wetrooms
please see our separate literature:

technical@ccl-wetrooms.co.uk
www.ccl-wetrooms.co.uk



CCL Building Products Ltd

Lodge Farm
Hook Road
North Wamborough
Hook
RG29 1HA



PL-CST-GLA01