

GloTek, Inc. www.globtek.com 186 Veterans Drive, Northvale, NJ 07647 Tel. (201) 784-1000 Fax (201) 784-0111	Drawing Title: GTM96181-36PD GTM96181-36PD USB Adaptive Power Source ICT/ITE/Medical Power supply Efficiency Level: USA DOE Level VI / Eco-design Directive 2009/125/EC, (EU) 2019/1782, Case Color/Style: GlobTek Black, Wall Plug-in USB Adaptive Power Supply AC Adaptor, Input Rating: 100-240V~, 50-60 Hz Interchangeable Blades https://www.globtek.com/interchangeable-blades.php Output Rating: 36.00W, 5.0V, 5.8V, 9.0V, 12.0V, 15.0V, 15.1V, 20.0VV@3.0A, 3.0A, 3.0A, 2.4A, 2.38A, 1.8AA Pin Out: +V: A4, A9, B4, B9, COM: A1, A12, B1, B12, CC1: A5, D+:A6, D-:A7 Approvals: : UKCA; WEEE; China RoHS; Ukraine; PSE; RoHS; cETLus 60601-1 3rd (pending); VCCI; CB 62368; CB 60950 (pending); 230V CoC Tier 2; EAC; FCC; CCC; Double Insulation; LPS 62368; CB 60601-1 (pending); Level VI; RCM; CAN ICES-3; Morocco; Korea; NOM; UAE (pending); Taiwan BSMI pending; Singapore;	
	Model No. GTM96181-36PD	
	Part No./Ordering No. WR9QZ1800USBCIM(R6B)	Rev B4

In Addition to GlobTek Inc.'s renewed ISO9001:2015 - Quality Management System Certification, GlobTek Inc. is now certified to:

ISO13485:2016 - Medical Devices Quality Management System Certification
ISO14001:2015 - Environmental Management System Certification

ISO Certificates are available online at <https://www.globtek.com/iso-certificates/>

The acceptance of this specification and use of the product described in this document indicates the acceptance and binding of the customer to Globtek TERMS AND CONDITIONS (attached to the end of this document), which supersede all other agreements, terms, and conditions (<https://www.globtek.com/terms-and-conditions/>).

The purchaser of this product (Customer) agrees that it is their sole responsibility to determine suitability/fitness of the product described in this specification for their application and to take precautions for protection against any hazards attendant to the handling and use of the product.

Footnote:

GlobTek Inc. will not be liable for the safety and performance of these power supplies/battery packs if unauthorized access and repair occurs. End user should consult applicable UL, CSA or EN standards for proper installation instruction.

Limitation of Use:

GlobTek products are intended for use with commercial, medical, and/or industrial equipment only. GlobTek product are not authorized for use as mission critical components in life support hazardous environment, nuclear or aircraft applications without prior written approval from the CEO of GlobTek Inc.

Contents of this document are subject to change without prior notice.

Customer Approval of Specification:

Please approve, sign and send back to GlobTek so we can complete order processing.
A delay in receipt of this form will delay delivery schedule.

Company Name: _____	Customer P/N: _____
Quote Number: _____	Date: _____
Authorized Representative Name: _____	Authorized Representative Signature: _____

GloTek, Inc. www.globtek.com 186 Veterans Drive, Northvale, NJ 07647 Tel. (201) 784-1000 Fax (201) 784-0111	Drawing Title: GTM96181-36PD GTM96181-36PD USB Adaptive Power Source ICT/ITE/Medical Power supply Efficiency Level: USA DOE Level VI / Eco-design Directive 2009/125/EC, (EU) 2019/1782, Case Color/Style: GlobTek Black, Wall Plug-in USB Adaptive Power Supply AC Adaptor, Input Rating: 100-240V~, 50-60 Hz Interchangeable Blades https://www.globtek.com/interchangeable-blades.php Output Rating: 36.00W, 5.0V, 5.8V, 9.0V, 12.0V, 15.0V, 15.1V, 20.0VV@3.0A, 3.0A, 3.0A, 3.0A, 2.4A, 2.38A, 1.8AA Pin Out: +V: A4, A9, B4, B9, COM: A1, A12, B1, B12, CC1: A5, D+:A6, D-:A7 Approvals: : UKCA; WEEE; China RoHS; Ukraine; PSE; RoHS; cETLus 60601-1 3rd (pending); VCCI; CB 62368; CB 60950 (pending); 230V CoC Tier 2; EAC; FCC; CCC; Double Insulation; LPS 62368; CB 60601-1 (pending); Level VI; RCM; CAN ICES-3; Morocco; Korea; NOM; UAE (pending); Taiwan BSMI pending; Singapore;	
	Model No. GTM96181-36PD	
	Part No./Ordering No. WR9QZ1800USBCIM(R6B)	Rev B4

REVISION HISTORY

REV	DESCRIPTION	SUB	DATE	APPROVED
B4	remove "pending" from 62368 CB, add link to agency online documents	dhock	06/19/2023	QA
B3	Update Firmware from GTF-7440-1 to GTF-7483-1	QA	04/05/2023	QA
B2	outdate cable drawing to show actual USB-C overmold (USB00016)	dhock	03/27/2023	QA
B1	Add Firmware GTF-7440-1 to Power supply Information	QA	01/04/2022	QA
B	Update the output current and voltage for 1 decimal place	QA	03/16/2020	QA
A	Initial Release	svlas	02/13/2020	QA

POWER SUPPLY INFORMATION

TYPE	Wall Plug-in
TECHNOLOGY	USB Adaptive Power Supply AC Adaptor
FIRMWARE VER	GTF-7483-1
CASE COLOR	GlobTek Black
NAMEPLATE RATED INPUT	100-240V~, 50-60 Hz, 1.2A
INPUT CONFIG	Interchangeable Blades
WATTS	36.00
VOLTS OUT	5.0V, 5.8V, 9.0V, 12.0V, 15.0V, 15.1V, 20.0V
CURRENT OUT (Amps)	3.0A, 3.0A, 3.0A, 3.0A, 2.4A, 2.38A, 1.8A
BLADE/CORD INCLUDED	None (Order Separately)
BLADE/CORD INSTALLED	None (Order Separately)
INGRESS PROTECTION	IP42
GROUNDING CONFIGURATION	(F1) Floating output, Class II / double insulated
EFFICIENCY LEVEL	USA DOE Level VI / Eco-design Directive 2009/125/EC, (EU) 2019/1782 - Europe Code of Conduct on Energy Efficiency of External Power Supplies - Version 5
OUTPUT CONFIGURATION	1500 mm, 2C 20 + 3C 28/5C + Shield Cond, N/A, USB Type-C Connector compliant with Directive (EU) 2022/2380 and 2014/53/EU Radio Equipment Directive (RED), Ferrite: None, GlobTek Black, GT Cord # C71820
OVERMOLDED	Yes
OUTPUT CONNECTOR GENDER	Male
CONNECTOR PIN OUT	+V: A4, A9, B4, B9, COM: A1, A12, B1, B12, CC1: A5, D+:A6, D-:A7
LABEL SPECS	ISO 15223 medical device compliant label,L-1470
SPECIAL BARCODE LABEL MATERIAL	No
PACK SPEC	Standard WPI, Cellular packaging
USER MANUAL	

PROPRIETARY INFORMATION

PROPRIETARY OF GLOBTEK, INC. ANY REPRODUCTION, DISCLOSURE OR USE OF THIS DRAWING, IN WHOLE OR IN PART, IS HEREBY PROHIBITED EXCEPT AS SPECIFIED IN WRITING BY GLOBTEK, INC. © GlobTek, Inc. 2020 - 2026

GloTek, Inc. www.globtek.com 186 Veterans Drive, Northvale, NJ 07647 Tel. (201) 784-1000 Fax (201) 784-0111	Drawing Title: GTM96181-36PD GTM96181-36PD USB Adaptive Power Source ICT/ITE/Medical Power supply Efficiency Level: USA DOE Level VI / Eco-design Directive 2009/125/EC, (EU) 2019/1782, Case Color/Style: GlobTek Black, Wall Plug-in USB Adaptive Power Supply AC Adaptor, Input Rating: 100-240V~, 50-60 Hz Interchangeable Blades https://www.globtek.com/interchangeable-blades.php Output Rating: 36.00W, 5.0V, 5.8V, 9.0V, 12.0V, 15.0V, 15.1V, 20.0VV@3.0A, 3.0A, 3.0A, 2.4A, 2.38A, 1.8AA Pin Out: +V: A4, A9, B4, B9, COM: A1, A12, B1, B12, CC1: A5, D+:A6, D-:A7 Approvals: : UKCA; WEEE; China RoHS; Ukraine; PSE; RoHS; cETLus 60601-1 3rd (pending); VCCI; CB 62368; CB 60950 (pending); 230V CoC Tier 2; EAC; FCC; CCC; Double Insulation; LPS 62368; CB 60601-1 (pending); Level VI; RCM; CAN ICES-3; Morocco; Korea; NOM; UAE (pending); Taiwan BSMI pending; Singapore;	
	Model No. GTM96181-36PD	
	Part No./Ordering No. WR9QZ1800USBCIM(R6B)	Rev B4

Notes/Modifications/Customizations (notes in this section supersede the values shown in the standard spec)
DIMENSIONS ARE IN MM UNLESS SPECIFIED OTHERWISE

GlobTek, Inc. www.globtek.com 186 Veterans Drive, Northvale, NJ 07647 Tel. (201) 784-1000 Fax (201) 784-0111	Drawing Title: GTM96181-36PD GTM96181-36PD USB Adaptive Power Source ICT/ITE/Medical Power supply Efficiency Level: USA DOE Level VI / Eco-design Directive 2009/125/EC, (EU) 2019/1782, Case Color/Style: GlobTek Black, Wall Plug-in USB Adaptive Power Supply AC Adaptor, Input Rating: 100-240V~, 50-60 Hz Interchangeable Blades https://www.globtek.com/interchangeable-blades.php Output Rating: 36.00W, 5.0V, 5.8V, 9.0V, 12.0V, 15.0V, 15.1V, 20.0VV@3.0A, 3.0A, 3.0A, 3.0A, 2.4A, 2.38A, 1.8AA Pin Out: +V: A4, A9, B4, B9, COM: A1, A12, B1, B12, CC1: A5, D+:A6, D-:A7 Approvals: : UKCA; WEEE; China RoHS; Ukraine; PSE; RoHS; cETLus 60601-1 3rd (pending); VCCI; CB 62368; CB 60950 (pending); 230V CoC Tier 2; EAC; FCC; CCC; Double Insulation; LPS 62368; CB 60601-1 (pending); Level VI; RCM; CAN ICES-3; Morocco; Korea; NOM; UAE (pending); Taiwan BSMI pending; Singapore;	
	Model No. GTM96181-36PD	
	Part No./Ordering No. WR9QZ1800USBCIM(R6B)	Rev B4

ELECTRICAL SPECIFICATIONS

USB Power Delivery Capabilities

Protocol supported:	USB Power Delivery (PD) 2.0/3.0 + PPS
Advertised Power Data Objects (PDOs/APDOs):	Standard option: 5V, 5.8V, 9V, 12V, 15V, 15.1V, 20V PPS option (18W): 5V, 9V, 12V, 15V, 15.1V, 20V, PPS (5-21V) PPS option (36W): 5V, 9V, 15V, 20V, PPS (5-11V), PPS (5-16V), PPS (5-21V)
Note 1:	Custom fixed PDOs available upon request. PDO1 must be 5V. PDO2 through PDO7 may be set to any custom voltage from 5V to 20V, with a step size of 100mV.
Note 2:	In critical applications, the use of a non-authorized USB PD power supply may pose a substantial risk. Power supply authorization may be implemented using USB PD Vendor Defined Messages (VDMs) to prevent system operation with non-authorized power sources. Please see our article Product Security and Risk Mitigation for USB Power Delivery (PD) Based Systems for additional information.

Input

Input Voltage:	Specified: 90-264VAC, Nameplate: 100-240VAC 100% rated load current for 90-264VAC 85% rated load current for 85-264VAC 100% rated load current for 110-370VDC
Input Frequency:	Specified: 47-63Hz, Nameplate: 50-60Hz
No Load Input Power:	< 75mW @ 230VAC (EU CoC Tier 2 compliant)
Inrush Current:	< 30A @ 115VAC, < 60A @ 230VAC (cold start)
Efficiency:	DoE Efficiency Level VI and CoC Tier 2 compliant (tested according to DoE 10 CFR Part 430, Subpart B, Appendix Z)

Output

Turn-on Delay:	< 1 second @ 115VAC and full load
Output Regulation	± 4% max. (measured at the end of a 1m long output cord)
Line Regulation:	± 0.5% typ. (measured at the end of a 1m long output cord)
Ripple:	100mV max. (using a 47µF low-ESR electrolytic cap + 0.1µF ceramic cap, measured @ 20MHz BW, at the output connector)
Transient Response:	5% max. deviation, 1ms max. recovery time (with 25% load step),
Hold-up Time:	8ms min. (100VAC and full load)
Power Indicator:	Green LED

Protections

Input Protection:	MOV transient suppressor, input line fusing
-------------------	---

PROPRIETARY INFORMATION

PROPRIETARY OF GLOBTEK, INC. ANY REPRODUCTION, DISCLOSURE OR USE OF THIS DRAWING, IN WHOLE OR IN PART, IS HEREBY PROHIBITED EXCEPT AS SPECIFIED IN WRITING BY GLOBTEK, INC. © GlobTek, Inc. 2020 - 2026

GloTek, Inc. www.globtek.com 186 Veterans Drive, Northvale, NJ 07647 Tel. (201) 784-1000 Fax (201) 784-0111	Drawing Title: GTM96181-36PD GTM96181-36PD USB Adaptive Power Source ICT/ITE/Medical Power supply Efficiency Level: USA DOE Level VI / Eco-design Directive 2009/125/EC, (EU) 2019/1782, Case Color/Style: GlobTek Black, Wall Plug-in USB Adaptive Power Supply AC Adaptor, Input Rating: 100-240V~, 50-60 Hz Interchangeable Blades https://www.globtek.com/interchangeable-blades.php Output Rating: 36.00W, 5.0V, 5.8V, 9.0V, 12.0V, 15.0V, 15.1V, 20.0VV@3.0A, 3.0A, 3.0A, 3.0A, 2.4A, 2.38A, 1.8AA Pin Out: +V: A4, A9, B4, B9, COM: A1, A12, B1, B12, CC1: A5, D+:A6, D-:A7 Approvals: : UKCA; WEEE; China RoHS; Ukraine; PSE; RoHS; cETLus 60601-1 3rd (pending); VCCI; CB 62368; CB 60950 (pending); 230V CoC Tier 2; EAC; FCC; CCC; Double Insulation; LPS 62368; CB 60601-1 (pending); Level VI; RCM; CAN ICES-3; Morocco; Korea; NOM; UAE (pending); Taiwan BSMI pending; Singapore;	
	Model No. GTM96181-36PD	
	Part No./Ordering No. WR9QZ1800USBCIM(R6B)	Rev B4

Over-Voltage Protection:	Level 1: 110-130%, Auto-recovery, adaptive to selected PDO Level 2: 24-28V, Latched off, cycle AC to reset
Over-Current Protection:	110-130%, Auto-recovery, adaptive to selected PDO
Short-Circuit Protection:	Auto-recovery
Over-Temperature Protection:	Auto-recovery

Environmental

MTBF:	1,500,000 hours @ 25°C ambient, full load (Telcordia SR-332, Issue 3)
Operating Temperature:	-10°C to 40°C (full load)
Storage Temperature:	-40°C to 80°C
Humidity:	0% to 95% relative humidity, non-condensing
Altitude	5000m
Cooling:	Convection
RoHS:	Complies with EU 2011/65/EU and China SJ/T 11363-2006

Safety

Dielectric Withstand Voltage:	4000VAC or 5656VDC from input to output 10mA, 1 minute
Touch Current:	NC: 80µA max. SFC: 400µA max.
Earth Leakage Current	300µA max. NC/SFC (N/A for 2-conductor input models)
Means of Protection:	2 x MOPP
Output Isolation Options:	-Q suffix: Class II 2-conductor (interchangeable blades) -T2 suffix: Class II 2-conductor -T3 suffix: Class II, with functional earth (FE) Class I, earth wire connected directly to output negative
Note 3:	Review output isolation options with our article: PSU Isolation and Identify

EMC

Applicable Standards:	Medical: EN 60601-1-2 (4e) Emissions: EN55032, EN61000-6-3, EN61000-6-4 Immunity: EN55024, EN61000-6-1 (4e), EN61000-6-2 (4e)
Conducted Emissions:	Class B, FCC Part 15, Class B (with resistive load)
Radiated Emissions:	Class B, FCC Part 15, Class B (with resistive load)
Harmonic Current Voltage Distortion:	EN61000-3-2, Class A
Voltage Fluctuations/Flicker:	EN61000-3-3
Electrostatic Discharge (ESD) Immunity:	EN61000-4-2, 10KV contact discharge, 18KV air discharge, Criterion A
Radiated RF Immunity:	EN61000-4-3, 10V/m @ 80-1000MHz, 3V/m @ 1-2.7GHz, 80% 1KHz AM, Criterion A
EFT/Burst Immunity:	EN61000-4-4, 4KV/100KHz., Criterion A

PROPRIETARY INFORMATION

PROPRIETARY OF GLOBTEK, INC. ANY REPRODUCTION, DISCLOSURE OR USE OF THIS DRAWING, IN WHOLE OR IN PART, IS HEREBY PROHIBITED EXCEPT AS SPECIFIED IN WRITING BY GLOBTEK, INC. © GlobTek, Inc. 2020 - 2026

GloTek, Inc. www.globtek.com 186 Veterans Drive, Northvale, NJ 07647 Tel. (201) 784-1000 Fax (201) 784-0111	Drawing Title: GTM96181-36PD GTM96181-36PD USB Adaptive Power Source ICT/ITE/Medical Power supply Efficiency Level: USA DOE Level VI / Eco-design Directive 2009/125/EC, (EU) 2019/1782, Case Color/Style: GlobTek Black, Wall Plug-in USB Adaptive Power Supply AC Adaptor, Input Rating: 100-240V~, 50-60 Hz Interchangeable Blades https://www.globtek.com/interchangeable-blades.php Output Rating: 36.00W, 5.0V, 5.8V, 9.0V, 12.0V, 15.0V, 15.1V, 20.0VV@3.0A, 3.0A, 3.0A, 3.0A, 2.4A, 2.38A, 1.8AA Pin Out: +V: A4, A9, B4, B9, COM: A1, A12, B1, B12, CC1: A5, D+:A6, D-:A7 Approvals: : UKCA; WEEE; China RoHS; Ukraine; PSE; RoHS; cETLus 60601-1 3rd (pending); VCCI; CB 62368; CB 60950 (pending); 230V CoC Tier 2; EAC; FCC; CCC; Double Insulation; LPS 62368; CB 60601-1 (pending); Level VI; RCM; CAN ICES-3; Morocco; Korea; NOM; UAE (pending); Taiwan BSMI pending; Singapore;	
	Model No. GTM96181-36PD	
	Part No./Ordering No. WR9QZ1800USBCIM(R6B)	Rev B4

Line Surge Immunity:	EN61000-4-5, 2KV differential, 4KV common-mode, Criterion A
Conducted RF Immunity:	EN61000-4-6, 10VRMS, 80% 1KHz AM, Criterion A
Voltage Dip Immunity:	EN61000-4-11, Criterion B/C
Note 4:	When a Class II power supply is connected to an earth-referenced system, conducted/radiated EMI levels tend to increase since the distant earth connection creates a long return path for common-mode EMI currents. This model includes an output common-mode choke to help alleviate system-level EMI issues. This choke can be removed for cost-sensitive applications.

Enclosure

Housing:	High impact plastic, 94V0 polycarbonate, non-vented
Markings:	Adhesive backed label or laser engraving

Security

USB Power Delivery:	Two non-standard voltage profiles are included: 5.8V and 15.1V. System designers may use these non-standard profiles to reduce the likelihood of system operation with non-GlobTek power supplies. 12.0V is also not standard, but is often included in other power supplies.
	The power supply will respond to a USB PD "Discover Identity" VDM with 0x4754 in the "ProductID" field. USB PD host systems may check this value before initiating/allowing power negotiation.
Note 5:	These measures do not guarantee a secure implementation, and are only suggested as a method of risk mitigation.
Note 6:	Please see our article Product Security and Risk Mitigation for USB Power Delivery (PD) Based Systems for additional information.

Special Options

Non-standard - Contact GlobTek

1. Custom housing and output cord colors
2. Custom fixed output cord length, for applicable models (1m, 2m, 3m lengths)
3. Custom markings and marking methods
4. Custom USB PD PDOs: Output voltages selectable between 5V and 20V, in 100mV increments

TO ADDRESS SYSTEM-LEVEL EMI CONCERNS, FERRITE CHOKES/BEADS MAY BE ADDED/REVISED UPON REQUEST. A SAMPLE KIT OF GLOBTEK'S STANDARD FERRITES IS AVAILABLE UNDER GLOBTEK P/N: EMI-MITIGATION-KIT1

FOR ADDITIONAL INFORMATION, PLEASE READ OUR WHITE PAPER AT: <https://r.globtek.info/3QeaqtD>

INGRESS PROTECTION: IP42

<p>GlobTek, Inc. www.globtek.com 186 Veterans Drive, Northvale, NJ 07647 Tel. (201) 784-1000 Fax (201) 784-0111</p>	<p>Drawing Title: GTM96181-36PD GTM96181-36PD USB Adaptive Power Source ICT/ITE/Medical Power supply Efficiency Level: USA DOE Level VI / Eco-design Directive 2009/125/EC, (EU) 2019/1782, Case Color/Style: GlobTek Black, Wall Plug-in USB Adaptive Power Supply AC Adaptor, Input Rating: 100-240V~, 50-60 Hz Interchangeable Blades https://www.globtek.com/interchangeable-blades.php Output Rating: 36.00W, 5.0V, 5.8V, 9.0V, 12.0V, 15.0V, 15.1V, 20.0VV@3.0A, 3.0A, 3.0A, 2.4A, 2.38A, 1.8AA Pin Out: +V: A4, A9, B4, B9, COM: A1, A12, B1, B12, CC1: A5, D+:A6, D-:A7 Approvals: : UKCA; WEEE; China RoHS; Ukraine; PSE; RoHS; cETLus 60601-1 3rd (pending); VCCI; CB 62368; CB 60950 (pending); 230V CoC Tier 2; EAC; FCC; CCC; Double Insulation; LPS 62368; CB 60601-1 (pending); Level VI; RCM; CAN ICES-3; Morocco; Korea; NOM; UAE (pending); Taiwan BSMI pending; Singapore;</p>	<p>Model No. GTM96181-36PD Part No./Ordering No. WR9QZ1800USBCIM(R6B) Rev B4</p>
--	--	--

3D File Download <https://www.globtek.com/file/dl/GTM96181-WWPD-Q.stp>

Mechanical drawing

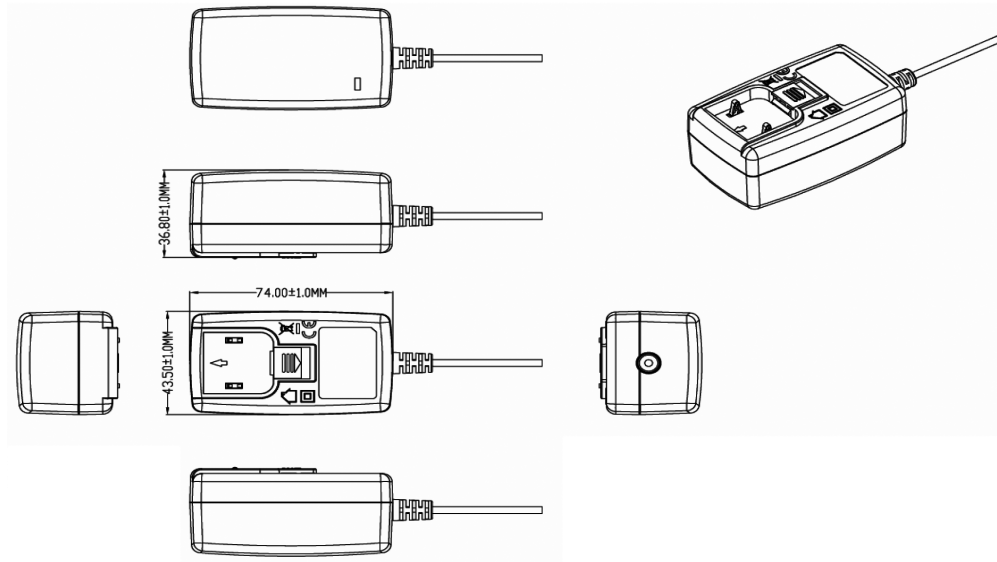

LED INDICATOR: Green Power ON indicator LED standard. May be ordered without LED as an option, for cost reduction.

Web Overview

[https://www.globtek.com/_0/WR9QZ1800USBCIM\(R6B\)/o](https://www.globtek.com/_0/WR9QZ1800USBCIM(R6B)/o)

<p>GlobTek, Inc. www.globtek.com 186 Veterans Drive, Northvale, NJ 07647 Tel. (201) 784-1000 Fax (201) 784-0111</p>	<p>Drawing Title: GTM96181-36PD GTM96181-36PD USB Adaptive Power Source ICT/ITE/Medical Power supply Efficiency Level: USA DOE Level VI / Eco-design Directive 2009/125/EC, (EU) 2019/1782, Case Color/Style: GlobTek Black, Wall Plug-in USB Adaptive Power Supply AC Adaptor, Input Rating: 100-240V~, 50-60 Hz Interchangeable Blades https://www.globtek.com/interchangeable-blades.php Output Rating: 36.00W, 5.0V, 5.8V, 9.0V, 12.0V, 15.0V, 15.1V, 20.0V@3.0A, 3.0A, 3.0A, 2.4A, 2.38A, 1.8AA Pin Out: +V: A4, A9, B4, B9, COM: A1, A12, B1, B12, CC1: A5, D+:A6, D-:A7 Approvals: : UKCA; WEEE; China RoHS; Ukraine; PSE; RoHS; cETLus 60601-1 3rd (pending); VCCI; CB 62368; CB 60950 (pending); 230V CoC Tier 2; EAC; FCC; CCC; Double Insulation; LPS 62368; CB 60601-1 (pending); Level VI; RCM; CAN ICES-3; Morocco; Korea; NOM; UAE (pending); Taiwan BSMI pending; Singapore;</p>	<p>Model No. GTM96181-36PD Part No./Ordering No. WR9QZ1800USBCIM(R6B) Rev B4</p>
--	---	--

DERATING CURVE

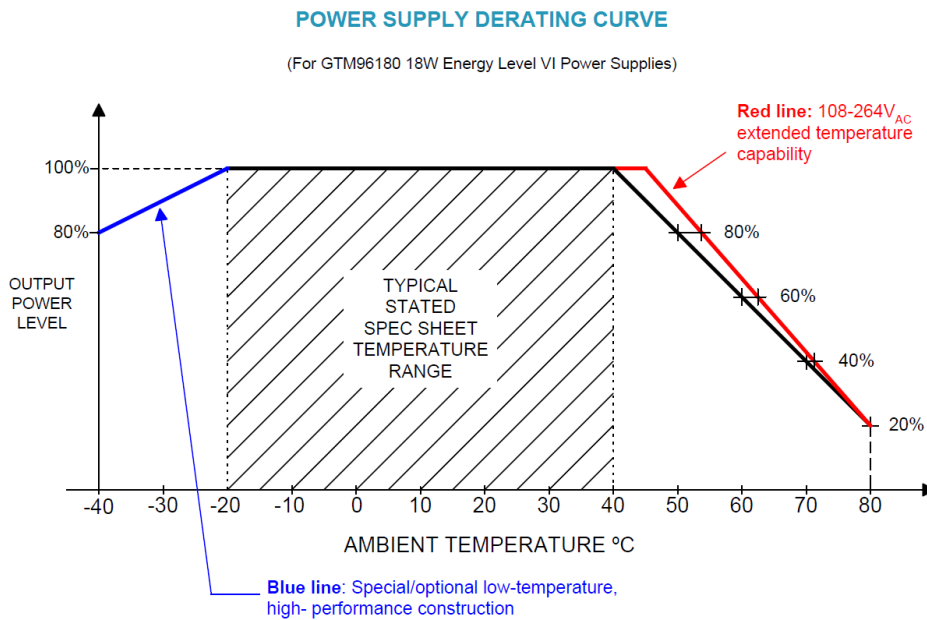

<p>GlobTek, Inc. www.globtek.com 186 Veterans Drive, Northvale, NJ 07647 Tel. (201) 784-1000 Fax (201) 784-0111</p>	<p>Drawing Title: GTM96181-36PD GTM96181-36PD USB Adaptive Power Source ICT/ITE/Medical Power supply Efficiency Level: USA DOE Level VI / Eco-design Directive 2009/125/EC, (EU) 2019/1782, Case Color/Style: GlobTek Black, Wall Plug-in USB Adaptive Power Supply AC Adaptor, Input Rating: 100-240V~, 50-60 Hz Interchangeable Blades https://www.globtek.com/interchangeable-blades.php Output Rating: 36.00W, 5.0V, 5.8V, 9.0V, 12.0V, 15.0V, 15.1V, 20.0VV@3.0A, 3.0A, 3.0A, 2.4A, 2.38A, 1.8AA Pin Out: +V: A4, A9, B4, B9, COM: A1, A12, B1, B12, CC1: A5, D+:A6, D-:A7 Approvals: : UKCA; WEEE; China RoHS; Ukraine; PSE; RoHS; cETLus 60601-1 3rd (pending); VCCI; CB 62368; CB 60950 (pending); 230V CoC Tier 2; EAC; FCC; CCC; Double Insulation; LPS 62368; CB 60601-1 (pending); Level VI; RCM; CAN ICES-3; Morocco; Korea; NOM; UAE (pending); Taiwan BSMI pending; Singapore;</p> <p>Model No. GTM96181-36PD</p> <p>Part No./Ordering No. WR9QZ1800USBCIM(R6B)</p>	<p>Rev B4</p>
--	--	---------------

INPUT CONFIGURATION

(F1) Floating output, Class II / double insulated

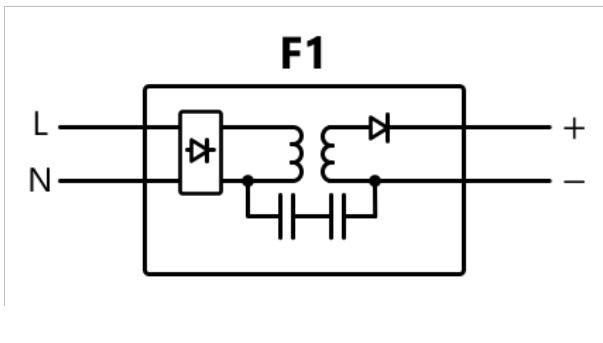

[Alternate grounding configurations](#) available upon request.

Blades/Cord Included:None(Order Separately)
Blades/Cord Installed:None(Order Separately)

Q Blades (Interchangeable)
Blade Options for Q Series Wall Plug-in Power Supplies

Data Sheet: <http://en.globtek.com/interchangeable-blades.php>

Insertion Instructions: <http://www.globtek.com/pdf/Instructions-Interchangeable-Blades.pdf>

Video: [Q-Blade Style Instruction Video](#)

GlobTek, Inc. www.globtek.com 186 Veterans Drive, Northvale, NJ 07647 Tel. (201) 784-1000 Fax (201) 784-0111	Drawing Title: GTM96181-36PD GTM96181-36PD USB Adaptive Power Source ICT/ITE/Medical Power supply Efficiency Level: USA DOE Level VI / Eco-design Directive 2009/125/EC, (EU) 2019/1782, Case Color/Style: GlobTek Black, Wall Plug-in USB Adaptive Power Supply AC Adaptor, Input Rating: 100-240V~, 50-60 Hz Interchangeable Blades https://www.globtek.com/interchangeable-blades.php Output Rating: 36.00W, 5.0V, 5.8V, 9.0V, 12.0V, 15.0V, 15.1V, 20.0VV@3.0A, 3.0A, 3.0A, 2.4A, 2.38A, 1.8AA Pin Out: +V: A4, A9, B4, B9, COM: A1, A12, B1, B12, CC1: A5, D+:A6, D-:A7 Approvals: : UKCA; WEEE; China RoHS; Ukraine; PSE; RoHS; cETLus 60601-1 3rd (pending); VCCI; CB 62368; CB 60950 (pending); 230V CoC Tier 2; EAC; FCC; CCC; Double Insulation; LPS 62368; CB 60601-1 (pending); Level VI; RCM; CAN ICES-3; Morocco; Korea; NOM; UAE (pending); Taiwan BSMI pending; Singapore;	
	Model No. GTM96181-36PD	
	Part No./Ordering No. WR9QZ1800USBCIM(R6B)	Rev B4



INPUT CONNECTOR: Q-Socket (below are available blades configurations which are "not included" (unless stated above); can be purchased separately, package with power supply or as a separate "Q-KIT" if specified

- 01. United States / Canada / Japan NEMA 1-15P/ IEC PLUG Type A [WORKS IN PLUG B] configuration: NA 2 blades, Class II; US/CA/JP P/N: Q-NA(R)
- 02. Australian AS 3112 configuration: SAA 2 blade/ IEC TYPE I, Class II; AU P/N: Q-SAA(R)
- 03. UK BS 1363 configuration: UK 3 blade with dummy Ground/ IEC TYPE G, Class II; GB P/N: Q-UK(R)
- 04. European CEE 7/16 configuration: Europlug 2 pins/ IEC TYPE C [WORKS IN TYPE E&F], Class II; EU P/N: Q-EU(R)
- 05. Korean KS C8305 configuration: 2 pins/SIMILAR TO IEC TYPE C, Class II; KR P/N: Q-KR(R)
- 06. Argentina IRAM 2073 configuration: 2 blades/SIMILAR TO IEC TYPE I; AR P/N: Class II Q-AR(R)
- 07. China GB 2099 configuration: 2 blades/SIMILAR TO TYPE A, Class II; CN P/N:Q-CN(R)
- 08. India IS 1293 6A/BS546 configuration: 5A, 3 pins with Dummy Ground, Class II/IEC TYPE D; IN P/N: Q-IN(R)
- 09. IEC60320/C18 Inlet, Class II; P/N: Q-C18(R)
- 10. Brazilian NBR6147 configuration: 2 pins, Class II;SIMILAR TO IEC TYPE C BR P/N: Q-BR(R)
- 11. South Africa SABS164-1 and India IS 1293, IS694, 16A type plug, 3 round prongs, Class II + dummy ground, IEC TYPE M P/N: Q-SANS164-1-16A(R)
- 12. South Africa SABS164-4, 3 round prongs with a notched prong @ 0°, Class II + dummy ground, IEC TYPE M Red, P/N: Q-SANS164-4C-16A(R)
- 13. South Africa SABS164-4, 3 round prongs with a notched prong @ -53°, Class II + dummy ground, Blue, IEC TYPE M,

<p>GlobTek, Inc. www.globtek.com 186 Veterans Drive, Northvale, NJ 07647 Tel. (201) 784-1000 Fax (201) 784-0111</p>	<p>Drawing Title: GTM96181-36PD GTM96181-36PD USB Adaptive Power Source ICT/ITE/Medical Power supply Efficiency Level: USA DOE Level VI / Eco-design Directive 2009/125/EC, (EU) 2019/1782, Case Color/Style: GlobTek Black, Wall Plug-in USB Adaptive Power Supply AC Adaptor, Input Rating: 100-240V~, 50-60 Hz Interchangeable Blades https://www.globtek.com/interchangeable-blades.php Output Rating: 36.00W, 5.0V, 5.8V, 9.0V, 12.0V, 15.0V, 15.1V, 20.0VV@3.0A, 3.0A, 3.0A, 2.4A, 2.38A, 1.8AA Pin Out: +V: A4, A9, B4, B9, COM: A1, A12, B1, B12, CC1: A5, D+:A6, D-:A7 Approvals: : UKCA; WEEE; China RoHS; Ukraine; PSE; RoHS; cETLus 60601-1 3rd (pending); VCCI; CB 62368; CB 60950 (pending); 230V CoC Tier 2; EAC; FCC; CCC; Double Insulation; LPS 62368; CB 60601-1 (pending); Level VI; RCM; CAN ICES-3; Morocco; Korea; NOM; UAE (pending); Taiwan BSMI pending; Singapore;</p>
	<p>Model No. GTM96181-36PD</p>
	<p>Part No./Ordering No. WR9QZ1800USBCIM(R6B)</p>
	<p>Rev B4</p>

P/N:
Q-SANS164-4L-16A(R)
14. South Africa SABS164-4, 3 round prongs with a notched prong @ +53°, Class II + dummy ground, Black,IEC TYPE M
P/N:
Q-SANS164-4R-16A(R)

Kits

01. Q-KIT: 1,2,3,4 above
02. Q-KIT-INTL: 2,3,4 above
03. Q-KIT-6: 1,2,3,4,5,6 above
04. Q-KIT-7: 1,2,3,4,5,6,7 above
05. Q-KIT-8: 1,2,3,4,5,6,7,8 above

GlobTek, Inc. www.globtek.com 186 Veterans Drive, Northvale, NJ 07647 Tel. (201) 784-1000 Fax (201) 784-0111	Drawing Title: GTM96181-36PD GTM96181-36PD USB Adaptive Power Source ICT/ITE/Medical Power supply Efficiency Level: USA DOE Level VI / Eco-design Directive 2009/125/EC, (EU) 2019/1782, Case Color/Style: GlobTek Black, Wall Plug-in USB Adaptive Power Supply AC Adaptor, Input Rating: 100-240V~, 50-60 Hz Interchangeable Blades https://www.globtek.com/interchangeable-blades.php Output Rating: 36.00W, 5.0V, 5.8V, 9.0V, 12.0V, 15.0V, 15.1V, 20.0VV@3.0A, 3.0A, 3.0A, 3.0A, 2.4A, 2.38A, 1.8AA Pin Out: +V: A4, A9, B4, B9, COM: A1, A12, B1, B12, CC1: A5, D+:A6, D-:A7 Approvals: : UKCA; WEEE; China RoHS; Ukraine; PSE; RoHS; cETLus 60601-1 3rd (pending); VCCI; CB 62368; CB 60950 (pending); 230V CoC Tier 2; EAC; FCC; CCC; Double Insulation; LPS 62368; CB 60601-1 (pending); Level VI; RCM; CAN ICES-3; Morocco; Korea; NOM; UAE (pending); Taiwan BSMI pending; Singapore;	
	Model No. GTM96181-36PD	
	Part No./Ordering No. WR9QZ1800USBCIM(R6B)	Rev B4

OUTPUT CORD AND CONNECTOR: USBC31/C71820

ACTUAL CONNECTORS, OVERMOLDS, FERRITES MAY VARY SLIGHTLY FROM THE PICTURE BELOW

CABLE TYPE	N/A
CABLE LENGTH (mm)	1500
CABLE TOLERANCE (mm)	±50
WIRE GAUGE (AWG)	2C 20 + 3C 28
CONDUCTORS	5C + Shield
HANK DIMENSION (mm)	80+/-10
CABLE / CONNECTOR OVERMOLD COLOR	GlobTek Black
FERRITE TYPE AND DIMENSION	None
FERRITE NUMBER OF TURNS	N/A
(Definition)	
FERRITE DIMENSION FROM STRAIN RELIEF	N/A
FERRITE DIMENSION FROM PLUG	N/A
PLUG TYPE	USB Type-C Connector compliant with Directive (EU) 2022/2380 and 2014/53/EU Radio Equipment Directive (RED)
OUTPUT CONNECTOR GENDER	Male
OVERMOLDED	Yes
OVER MOLD ORIENTATION	Straight
CONNECTOR PIN OUT	+V: A4, A9, B4, B9, COM: A1, A12, B1, B12, CC1: A5, D+:A6, D-:A7

ADDITIONAL REQUIREMENTS

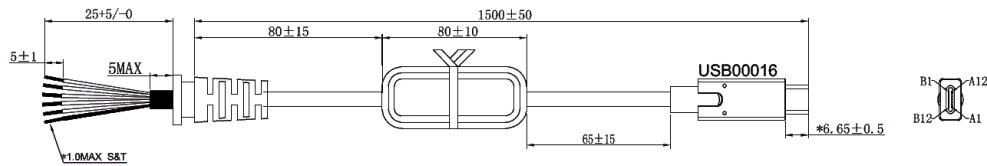

Cable Pinout			
Color	Gauge	Function	Pin Hookup
Green	20AWG	+V	A4 B9 B4 A9
Black	20AWG	GND	A1 B12 B1 A12
Brown	28AWG	CC1	A5
Red	28AWG	D+	A6
Yellow	28AWG	D-	A7
Shield	20AWG	Shell	Shell

PROPRIETARY INFORMATION

<p>GlobTek, Inc. www.globtek.com 186 Veterans Drive, Northvale, NJ 07647 Tel. (201) 784-1000 Fax (201) 784-0111</p>	<p>Drawing Title: GTM96181-36PD GTM96181-36PD USB Adaptive Power Source ICT/ITE/Medical Power supply Efficiency Level: USA DOE Level VI / Eco-design Directive 2009/125/EC, (EU) 2019/1782, Case Color/Style: GlobTek Black, Wall Plug-in USB Adaptive Power Supply AC Adaptor, Input Rating: 100-240V~, 50-60 Hz Interchangeable Blades https://www.globtek.com/interchangeable-blades.php Output Rating: 36.00W, 5.0V, 5.8V, 9.0V, 12.0V, 15.0V, 15.1V, 20.0VV@3.0A, 3.0A, 3.0A, 2.4A, 2.38A, 1.8AA Pin Out: +V: A4, A9, B4, B9, COM: A1, A12, B1, B12, CC1: A5, D+:A6, D-:A7 Approvals: : UKCA; WEEE; China RoHS; Ukraine; PSE; RoHS; cETLus 60601-1 3rd (pending); VCCI; CB 62368; CB 60950 (pending); 230V CoC Tier 2; EAC; FCC; CCC; Double Insulation; LPS 62368; CB 60601-1 (pending); Level VI; RCM; CAN ICES-3; Morocco; Korea; NOM; UAE (pending); Taiwan BSMI pending; Singapore;</p>
	<p>Model No. GTM96181-36PD</p>
	<p>Part No./Ordering No. WR9QZ1800USBCIM(R6B) Rev B4</p>

ADDITIONAL OUTPUT PLUG OPTIONS ARE AVAILABLE AT <https://www.globtek.com/en/connectors>
STANDARD PLUGS AND CONNECTORS CAN BE SEEN ONLINE AT <https://www.globtek.com/en/connectors>
CALCULATE VOLTAGE REGULATION/DROP WITH OUR ONLINE CALCULATOR: <https://www.globtek.com/r2/PtgjL>

<p>GlobTek, Inc. www.globtek.com 186 Veterans Drive, Northvale, NJ 07647 Tel. (201) 784-1000 Fax (201) 784-0111</p>	<p>Drawing Title: GTM96181-36PD GTM96181-36PD USB Adaptive Power Source ICT/ITE/Medical Power supply Efficiency Level: USA DOE Level VI / Eco-design Directive 2009/125/EC, (EU) 2019/1782, Case Color/Style: GlobTek Black, Wall Plug-in USB Adaptive Power Supply AC Adaptor, Input Rating: 100-240V~, 50-60 Hz Interchangeable Blades https://www.globtek.com/interchangeable-blades.php Output Rating: 36.00W, 5.0V, 5.8V, 9.0V, 12.0V, 15.0V, 15.1V, 20.0VV@3.0A, 3.0A, 3.0A, 2.4A, 2.38A, 1.8AA Pin Out: +V: A4, A9, B4, B9, COM: A1, A12, B1, B12, CC1: A5, D+:A6, D-:A7 Approvals: : UKCA; WEEE; China RoHS; Ukraine; PSE; RoHS; cETLus 60601-1 3rd (pending); VCCI; CB 62368; CB 60950 (pending); 230V CoC Tier 2; EAC; FCC; CCC; Double Insulation; LPS 62368; CB 60601-1 (pending); Level VI; RCM; CAN ICES-3; Morocco; Korea; NOM; UAE (pending); Taiwan BSMI pending; Singapore;</p>
	<p>Model No. GTM96181-36PD</p>
	<p>Part No./Ordering No. WR9QZ1800USBCIM(R6B) Rev B4</p>

OUTPUT CONNECTOR HOOK UP

TO ADDRESS SYSTEM-LEVEL EMI CONCERNS, FERRITE CHOKES/BEADS MAY BE ADDED/REVISED UPON REQUEST. A SAMPLE KIT OF GLOBTEK'S STANDARD FERRITES IS AVAILABLE UNDER GLOBTEK P/N: EMI-MITIGATION-KIT1

FOR ADDITIONAL INFORMATION, PLEASE READ OUR WHITE PAPER AT:

<https://www.globtek.com/en/technical-articles/ferrite-kit-radiated-emi-suppression-kit-for-globtek-power-supplies-cable-assemblies>

GloTek, Inc. www.globtek.com 186 Veterans Drive, Northvale, NJ 07647 Tel. (201) 784-1000 Fax (201) 784-0111	Drawing Title: GTM96181-36PD GTM96181-36PD USB Adaptive Power Source ICT/ITE/Medical Power supply Efficiency Level: USA DOE Level VI / Eco-design Directive 2009/125/EC, (EU) 2019/1782, Case Color/Style: GlobTek Black, Wall Plug-in USB Adaptive Power Supply AC Adaptor, Input Rating: 100-240V~, 50-60 Hz Interchangeable Blades https://www.globtek.com/interchangeable-blades.php Output Rating: 36.00W, 5.0V, 5.8V, 9.0V, 12.0V, 15.0V, 15.1V, 20.0VV@3.0A, 3.0A, 3.0A, 3.0A, 2.4A, 2.38A, 1.8AA Pin Out: +V: A4, A9, B4, B9, COM: A1, A12, B1, B12, CC1: A5, D+:A6, D-:A7 Approvals: : UKCA; WEEE; China RoHS; Ukraine; PSE; RoHS; cETLus 60601-1 3rd (pending); VCCI; CB 62368; CB 60950 (pending); 230V CoC Tier 2; EAC; FCC; CCC; Double Insulation; LPS 62368; CB 60601-1 (pending); Level VI; RCM; CAN ICES-3; Morocco; Korea; NOM; UAE (pending); Taiwan BSMI pending; Singapore;	
	Model No. GTM96181-36PD	
	Part No./Ordering No. WR9QZ1800USBCIM(R6B)	Rev B4

LABEL:L-1470

LABEL P/N	ISO 15223 medical device compliant label
MATERIAL	Flat Thermal Transfer, Imprintable, Polyester Label and/or Pad Printed and/or Molded, and/or Laser Engraved in the case
BACKGROUND COLOR	Black if housing is Black, White or Silver if housing is White or Gray.
TEXT COLOR	White or Silver if label is Black Background for Black housing. Black if label is White or Silver background and Housing is White or Gray.
LABEL WIDTH (mm)	29.8
LABEL HEIGHT (mm)	20.8
SPECIAL BARCODE LABEL MATERIAL	No





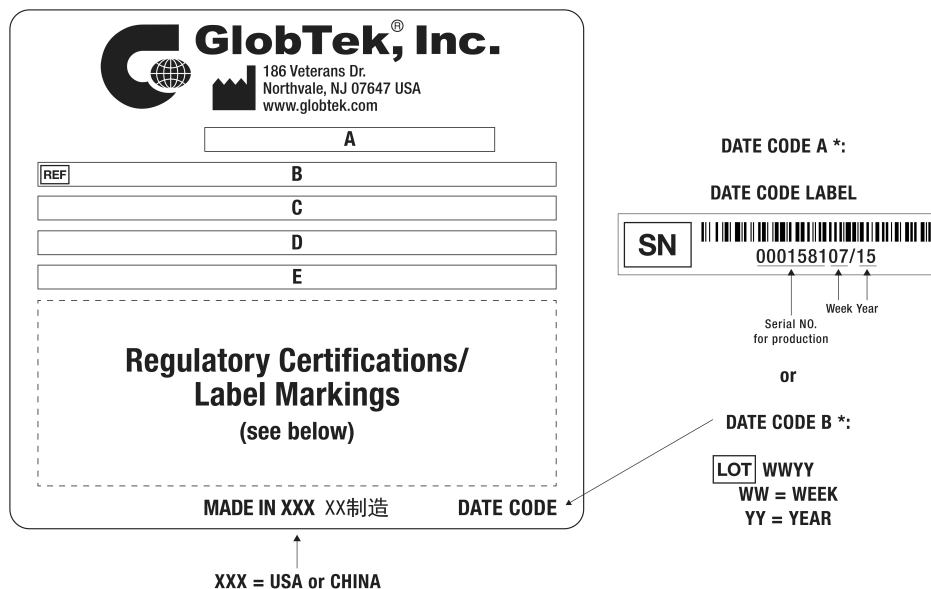

Below is the minimum information which will appear on the label. NOTE: in the logo area additional/actual positioning of symbols and text is subjected to change as per agency updates/requirements or additional model approvals become available.

Agency logos may be in Regulatory Certifications/Label Markings area on the label or molded into the case housing outside the label area. Information will be shown via Label and/or Pad Printed and/or Molded in the case.



A=USB Adaptive Power Source ICT/ITE/Medical Power supply
B=Model (型号): GTM96181-36PD
C=P/N (料号): WR9QZ1800USBCIM(R6B)
D=Input (输入)100-240V~, 50-60 Hz 1.2A

GlobTek, Inc. www.globtek.com 186 Veterans Drive, Northvale, NJ 07647 Tel. (201) 784-1000 Fax (201) 784-0111	Drawing Title: GTM96181-36PD GTM96181-36PD USB Adaptive Power Source ICT/ITE/Medical Power supply Efficiency Level: USA DOE Level VI / Eco-design Directive 2009/125/EC, (EU) 2019/1782, Case Color/Style: GlobTek Black, Wall Plug-in USB Adaptive Power Supply AC Adaptor, Input Rating: 100-240V~, 50-60 Hz Interchangeable Blades https://www.globtek.com/interchangeable-blades.php Output Rating: 36.00W, 5.0V, 5.8V, 9.0V, 12.0V, 15.0V, 15.1V, 20.0VV@3.0A, 3.0A, 3.0A, 3.0A, 2.4A, 2.38A, 1.8AA Pin Out: +V: A4, A9, B4, B9, COM: A1, A12, B1, B12, CC1: A5, D+:A6, D-:A7 Approvals: : UKCA; WEEE; China RoHS; Ukraine; PSE; RoHS; cETLus 60601-1 3rd (pending); VCCI; CB 62368; CB 60950 (pending); 230V CoC Tier 2; EAC; FCC; CCC; Double Insulation; LPS 62368; CB 60601-1 (pending); Level VI; RCM; CAN ICES-3; Morocco; Korea; NOM; UAE (pending); Taiwan BSMI pending; Singapore;	
	Model No. GTM96181-36PD	
	Part No./Ordering No. WR9QZ1800USBCIM(R6B)	Rev B4

E=Output (输出) 5.0VV  3.0AA 5.8VV  3.0AA 9.0VV  3.0AA 12.0VV  3.0AA 15.0VV  2.4AA 15.1VV  2.38AA 20.0VV  1.8AA 36.00 W F=GTF-7483-1
--

GloTek, Inc. www.globtek.com 186 Veterans Drive, Northvale, NJ 07647 Tel. (201) 784-1000 Fax (201) 784-0111	Drawing Title: GTM96181-36PD GTM96181-36PD USB Adaptive Power Source ICT/ITE/Medical Power supply Efficiency Level: USA DOE Level VI / Eco-design Directive 2009/125/EC, (EU) 2019/1782, Case Color/Style: GlobTek Black, Wall Plug-in USB Adaptive Power Supply AC Adaptor, Input Rating: 100-240V~, 50-60 Hz Interchangeable Blades https://www.globtek.com/interchangeable-blades.php Output Rating: 36.00W, 5.0V, 5.8V, 9.0V, 12.0V, 15.0V, 15.1V, 20.0VV@3.0A, 3.0A, 3.0A, 2.4A, 2.38A, 1.8AA Pin Out: +V: A4, A9, B4, B9, COM: A1, A12, B1, B12, CC1: A5, D+:A6, D-:A7 Approvals: : UKCA; WEEE; China RoHS; Ukraine; PSE; RoHS; cETLus 60601-1 3rd (pending); VCCI; CB 62368; CB 60950 (pending); 230V CoC Tier 2; EAC; FCC; CCC; Double Insulation; LPS 62368; CB 60601-1 (pending); Level VI; RCM; CAN ICES-3; Morocco; Korea; NOM; UAE (pending); Taiwan BSMI pending; Singapore;	
	Model No. GTM96181-36PD	
	Part No./Ordering No. WR9QZ1800USBCIM(R6B)	Rev B4

AGENCY ONLINE DOCUMENTS	http://www.globtek.info/certs/GTM96181-PD/
CE EC-Declaration for Medical	Contact GlobTek for more information
CE EC-Declaration for Industrial/Commercial/ITE	https://cs.globtek.info/ec_declaration_product?id=01t3a000004eobl&i=2
CE EC-Declaration for Household	Contact GlobTek for more information
UKCA-Declaration for Medical	Contact GlobTek for more information
UKCA-Declaration for Industrial/Commercial/ITE	https://cs.globtek.info/ukca_declaration_product?id=01t3a000004eobl&i=2
UKCA-Declaration for Household	Contact GlobTek for more information
Morocco SDoC Declaration	https://cs.globtek.info/Morocco_SDoC_Declaration?id=a003a00000M3ytqEAB
RoHS/RoHS3 Declaration	https://www.globtek.com/dcs/SPJ8VNR/aKdrDGtcwOdbZDkaAXtBFA
REACH Declaration	https://www.globtek.com/_0/aKdrDGtcwOdbZDkaAXtBFA/reach-letter
Conflict Minerals Declaration	https://www.globtek.com/r2/vZY8R5
Prop 65 Statement	https://www.globtek.com/r2/PH7CNf
Additional Compliance Documents	https://www.globtek.com/dcs/TKN7SG1/aKdrDGtcwOd...

IPXY rating is based on 3rd party testing and customers should check suitability and test system level IPXY rating before ordering.

Regulatory Certifications/Label Markings

Below follows a link to the latest regulatory certifications and marks for this specific product. National standards as well as certification schemes are constantly changing and so is the set of certification marks and symbols applicable to this product. Various standards, marks and symbols, and certificates are subject to change at any time without notice.

Additional standards or unique country certifications are available upon request. Please contact Globtek to request a quotation.

LATEST PRODUCT/MODEL CERTIFICATIONS: https://www.globtek.com/ds/lofvZsxM_nX/ZI_6011yK7w.html#datasheet

AGENCY ONLINE DOCUMENTS <http://www.globtek.info/certs/GTM96181-PD/>

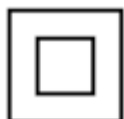

(F1) Floating output, Class II / double insulated

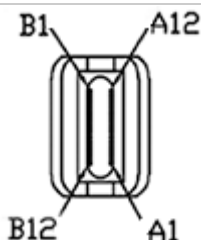

+V: A4, A9, B4, B9,
COM: A1, A12, B1, B12,
CC1: A5,
D+:A6,
D-:A7

GloTek, Inc. www.globtek.com 186 Veterans Drive, Northvale, NJ 07647 Tel. (201) 784-1000 Fax (201) 784-0111	Drawing Title: GTM96181-36PD GTM96181-36PD USB Adaptive Power Source ICT/ITE/Medical Power supply Efficiency Level: USA DOE Level VI / Eco-design Directive 2009/125/EC, (EU) 2019/1782, Case Color/Style: GlobTek Black, Wall Plug-in USB Adaptive Power Supply AC Adaptor, Input Rating: 100-240V~, 50-60 Hz Interchangeable Blades https://www.globtek.com/interchangeable-blades.php Output Rating: 36.00W, 5.0V, 5.8V, 9.0V, 12.0V, 15.0V, 15.1V, 20.0VV@3.0A, 3.0A, 3.0A, 3.0A, 2.4A, 2.38A, 1.8AA Pin Out: +V: A4, A9, B4, B9, COM: A1, A12, B1, B12, CC1: A5, D+:A6, D-:A7 Approvals: : UKCA; WEEE; China RoHS; Ukraine; PSE; RoHS; cETLus 60601-1 3rd (pending); VCCI; CB 62368; CB 60950 (pending); 230V CoC Tier 2; EAC; FCC; CCC; Double Insulation; LPS 62368; CB 60601-1 (pending); Level VI; RCM; CAN ICES-3; Morocco; Korea; NOM; UAE (pending); Taiwan BSMI pending; Singapore;	
	Model No. GTM96181-36PD	
	Part No./Ordering No. WR9QZ1800USBCIM(R6B)	Rev B4

PACKAGING

Packing Spec P/N	Standard WPI, Cellular packaging
Packing Quantity/Multiple/MPQ	60
Gift Box Size (mm)	Egg Crate
Gift Box Color	None
Master Carton Size (mm)	480 x 450 x 205
Master Carton Cubic Volume (m ³)	0.04
Master GW (Kg)	15.2 kg
BLADES INCLUDED	None: (Order Separately)
BLADE/CORD INSTALLED	None: (Order Separately)
USER MANUAL*	
USER MANUAL WEB LINK	

* This specification sheet is considered the user manual for all applications. It is expected that the buyer of this product will use it to formulate their own user manual for their end product and a user manual specifically for the power adapter is not usually required. If a user manual is not specifically listed above then none will be provided with this unit.

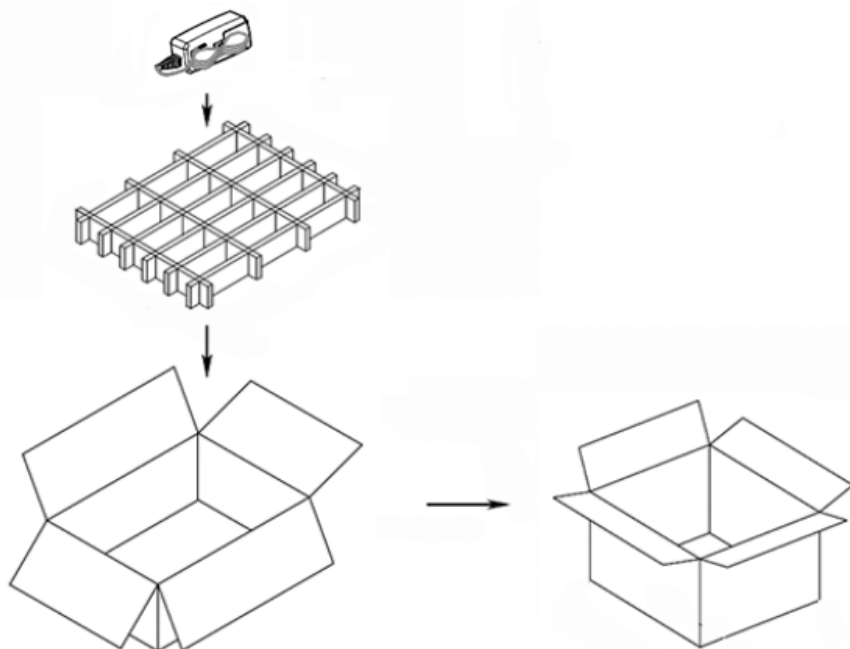

PROPRIETARY INFORMATION

<p>GlobTek, Inc. www.globtek.com 186 Veterans Drive, Northvale, NJ 07647 Tel. (201) 784-1000 Fax (201) 784-0111</p>	<p>Drawing Title: GTM96181-36PD GTM96181-36PD USB Adaptive Power Source ICT/ITE/Medical Power supply Efficiency Level: USA DOE Level VI / Eco-design Directive 2009/125/EC, (EU) 2019/1782, Case Color/Style: GlobTek Black, Wall Plug-in USB Adaptive Power Supply AC Adaptor, Input Rating: 100-240V~, 50-60 Hz Interchangeable Blades https://www.globtek.com/interchangeable-blades.php Output Rating: 36.00W, 5.0V, 5.8V, 9.0V, 12.0V, 15.0V, 15.1V, 20.0VV@3.0A, 3.0A, 3.0A, 2.4A, 2.38A, 1.8AA Pin Out: +V: A4, A9, B4, B9, COM: A1, A12, B1, B12, CC1: A5, D+:A6, D-:A7 Approvals: : UKCA; WEEE; China RoHS; Ukraine; PSE; RoHS; cETLus 60601-1 3rd (pending); VCCI; CB 62368; CB 60950 (pending); 230V CoC Tier 2; EAC; FCC; CCC; Double Insulation; LPS 62368; CB 60601-1 (pending); Level VI; RCM; CAN ICES-3; Morocco; Korea; NOM; UAE (pending); Taiwan BSMI pending; Singapore;</p>
	<p>Model No. GTM96181-36PD</p>
	<p>Part No./Ordering No. WR9QZ1800USBCIM(R6B) Rev B4</p>

INSTRUCTIONS TO THE OEM SYSTEMS ENGINEER

It is the responsibility of the OEM systems engineer to provide the end system user instructions and warnings for the use of this product in the end system.

If an input cord is required for this product, AC Mains voltage should be provided to the power supply by a power supply cord approved to the national standards of the country in which it will be used.

This product is not designed to be repaired. No serviceable parts inside. A blown internal fuse is an indication of catastrophic failure of circuit component(s). If a Failure Analysis is required for a failed power supply/battery charger, please return the damaged unit to GlobTek for an accurate determination of the root cause of the failure.

EMC Compliance of the complete OEM product, including the GlobTek power supply/battery charger needs to be verified by the OEM systems engineer.

GlobTek, Inc. www.globtek.com 186 Veterans Drive, Northvale, NJ 07647 Tel. (201) 784-1000 Fax (201) 784-0111	Drawing Title: GTM96181-36PD GTM96181-36PD USB Adaptive Power Source ICT/ITE/Medical Power supply Efficiency Level: USA DOE Level VI / Eco-design Directive 2009/125/EC, (EU) 2019/1782, Case Color/Style: GlobTek Black, Wall Plug-in USB Adaptive Power Supply AC Adaptor, Input Rating: 100-240V~, 50-60 Hz Interchangeable Blades https://www.globtek.com/interchangeable-blades.php Output Rating: 36.00W, 5.0V, 5.8V, 9.0V, 12.0V, 15.0V, 15.1V, 20.0VV@3.0A, 3.0A, 3.0A, 2.4A, 2.38A, 1.8AA Pin Out: +V: A4, A9, B4, B9, COM: A1, A12, B1, B12, CC1: A5, D+:A6, D-:A7 Approvals: : UKCA; WEEE; China RoHS; Ukraine; PSE; RoHS; cETLus 60601-1 3rd (pending); VCCI; CB 62368; CB 60950 (pending); 230V CoC Tier 2; EAC; FCC; CCC; Double Insulation; LPS 62368; CB 60601-1 (pending); Level VI; RCM; CAN ICES-3; Morocco; Korea; NOM; UAE (pending); Taiwan BSMI pending; Singapore;	
	Model No. GTM96181-36PD	
	Part No./Ordering No. WR9QZ1800USBCIM(R6B)	Rev B4

INSTRUCTION SHEET

Q Blades Instruction Sheet (not required to be packaged with product)

Insertion Instructions: <http://www.globtek.com/pdf/Instructions-Interchangeable-Blades.pdf>

This manual is Provided to customer within the product specification - it is the responsibility of the OEM/customer to provide the end system user instructions + warnings for the use of this product in the end system. By accepting this specification the customer/OEM Agrees to these terms.

USER MANUAL FOR Q-BLADE SERIES SWITCHING POWER SUPPLIES

Manual del Usuario. Fuentes de Alimentación Series Q-Blade

WARNING! RISK OF FIRE! SHOCK HAZARD!: To prevent electric shock, do not remove the cover. No user-serviceable parts inside. This unit contains hazardous voltages and should only be opened by a trained and qualified technician. Do not use if bent, cracked, modified or compromised. To avoid the possibility of electric shock, disconnect electric power to the product before connecting or disconnecting.

Advertencia! Riesgo de Fuego! Peligro de Choque eléctrico! No contiene dentro componentes servibles para el usuario. Desconecte el cable de alimentación antes de quitar la cubierta.

INDOOR USE ONLY!

Únicamente para uso en el interior.

POWER SUPPLY BLADE/CORD: AC Mains voltage should be provided to the power supply by a power supply cords approved to the national standards in which it will be used. Please use the below table as a guideline for Suitable Power cords.

CABLE DE ALIMENTACIÓN: El voltaje de la CA debe proporcionarse a la fuente de alimentación mediante los cables de alimentación aprobados conforme a las normas nacionales según las cuales será utilizada. Utilice por favor la tabla mencionada aquí abajo como guía para los cables eléctricos adecuados.

1. Class II model NEMA 1-15P AC power plug with 2 prongs, Q-NA(R)
2. Australian AS 3112 configuration: SAA 2 pins Class II, Q-SAA(R)
3. UK BS 1363 configuration: UK 2 pins Class II, Q-UK(R)
4. European CEE 7/16 configuration: Europlug 2 PINS, Class II, Q-EU(R)
5. Korean KS C8305 configuration: Q-KR(R)
6. Argentina IRAM 2073 configuration: 2 pins, Class II Q-AR(R)
7. China GR 2099 configuration: 2 pins, Class II Q-CN(R)
8. India configuration: 2 pins, Class II, Q-IN(R)
9. IEC320/C18 Inlet

PROPRIETARY INFORMATION

PROPRIETARY OF GLOBTEK, INC. ANY REPRODUCTION, DISCLOSURE OR USE OF THIS DRAWING, IN WHOLE OR IN PART, IS HEREBY PROHIBITED EXCEPT AS SPECIFIED IN Page 20 of 27

WRITING BY GLOBTEK, INC. © GlobTek, Inc. 2020 - 2026

quest / 06/18/2026 2:16:49 PM GMT

<p>GlobTek, Inc. www.globtek.com 186 Veterans Drive, Northvale, NJ 07647 Tel. (201) 784-1000 Fax (201) 784-0111</p>	<p>Drawing Title: GTM96181-36PD GTM96181-36PD USB Adaptive Power Source ICT/ITE/Medical Power supply Efficiency Level: USA DOE Level VI / Eco-design Directive 2009/125/EC, (EU) 2019/1782, Case Color/Style: GlobTek Black, Wall Plug-in USB Adaptive Power Supply AC Adaptor, Input Rating: 100-240V~, 50-60 Hz Interchangeable Blades https://www.globtek.com/interchangeable-blades.php Output Rating: 36.00W, 5.0V, 5.8V, 9.0V, 12.0V, 15.0V, 15.1V, 20.0VV@3.0A, 3.0A, 3.0A, 2.4A, 2.38A, 1.8AA Pin Out: +V: A4, A9, B4, B9, COM: A1, A12, B1, B12, CC1: A5, D+:A6, D-:A7 Approvals: : UKCA; WEEE; China RoHS; Ukraine; PSE; RoHS; cETLus 60601-1 3rd (pending); VCCI; CB 62368; CB 60950 (pending); 230V CoC Tier 2; EAC; FCC; CCC; Double Insulation; LPS 62368; CB 60601-1 (pending); Level VI; RCM; CAN ICES-3; Morocco; Korea; NOM; UAE (pending); Taiwan BSMI pending; Singapore;</p> <p>Model No. GTM96181-36PD</p> <p>Part No./Ordering No. WR9QZ1800USBCIM(R6B)</p>	<p>Rev B4</p>
--	---	---------------

FUSING: Internal fuse for Line is provided in the power supply. A blown internal fuse is an indication of catastrophic failure of circuit component(s). Repair must be performed by GlobTek, Inc. authorized personnel. Fuses must be replaced with same type and ratings per GlobTek internal documentation.

FUSIBLES: La fuente de alimentación provee un fusible interno para la línea. Un fusible interno quemado es un indicador de una falla catastrófica de los componentes del circuito. La reparación debe ser hecha por personal autorizado de GlobTek, Inc. Los fusibles se deben reemplazar por los mismos tipos y rangos que la documentación interna de GlobTek mencione.

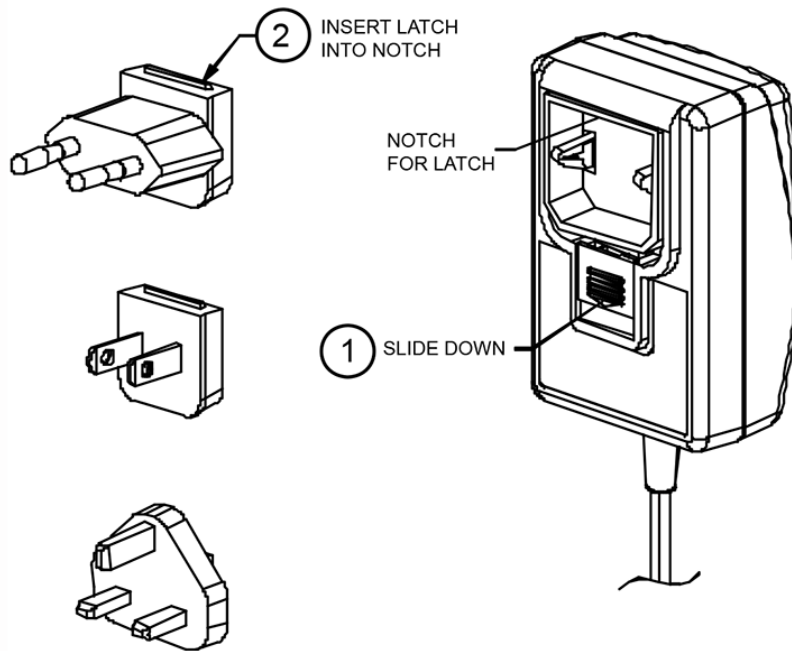

This symbol on an instrument indicates that the user should refer to the operating instructions located in the manual.

Please note:

The blades shown above are for representation of the installation process and do not indicate which AC blades are included with this power supply. Please reference the specifications "Power Supply Information" (page 2) and "Input Configuration (page 6) for information regarding the actual blade included with this power supply, if any.

GloTek, Inc. www.globtek.com 186 Veterans Drive, Northvale, NJ 07647 Tel. (201) 784-1000 Fax (201) 784-0111	Drawing Title: GTM96181-36PD GTM96181-36PD USB Adaptive Power Source ICT/ITE/Medical Power supply Efficiency Level: USA DOE Level VI / Eco-design Directive 2009/125/EC, (EU) 2019/1782, Case Color/Style: GlobTek Black, Wall Plug-in USB Adaptive Power Supply AC Adaptor, Input Rating: 100-240V~, 50-60 Hz Interchangeable Blades https://www.globtek.com/interchangeable-blades.php Output Rating: 36.00W, 5.0V, 5.8V, 9.0V, 12.0V, 15.0V, 15.1V, 20.0VV@3.0A, 3.0A, 3.0A, 2.4A, 2.38A, 1.8AA Pin Out: +V: A4, A9, B4, B9, COM: A1, A12, B1, B12, CC1: A5, D+:A6, D-:A7 Approvals: : UKCA; WEEE; China RoHS; Ukraine; PSE; RoHS; cETLus 60601-1 3rd (pending); VCCI; CB 62368; CB 60950 (pending); 230V CoC Tier 2; EAC; FCC; CCC; Double Insulation; LPS 62368; CB 60601-1 (pending); Level VI; RCM; CAN ICES-3; Morocco; Korea; NOM; UAE (pending); Taiwan BSMI pending; Singapore;	
	Model No. GTM96181-36PD	
	Part No./Ordering No. WR9QZ1800USBCIM(R6B)	Rev B4

TERMS AND CONDITIONS

THESE TERMS AND CONDITIONS GOVERN THE SALE OF ALL PRODUCTS AND SERVICES ("PRODUCTS") BY GlobTek, Inc. ("GlobTek") AND APPLY NOTWITHSTANDING ANY CONFLICTING, CONTRARY OR ADDITIONAL TERMS AND CONDITIONS IN ANY PURCHASE ORDER OR OTHER DOCUMENT OR COMMUNICATION ("PURCHASE ORDER") FROM BUYER. THESE TERMS AND CONDITIONS MAY ONLY BE WAIVED OR MODIFIED IN A WRITTEN AGREEMENT SIGNED BY AN AUTHORIZED REPRESENTATIVE OF THE SELLER. NEITHER SELLER'S ACKNOWLEDGEMENT OF A PURCHASE ORDER NOR SELLER'S FAILURE TO OBJECT TO CONFLICTING, CONTRARY OR ADDITIONAL TERMS AND CONDITIONS IN A PURCHASE ORDER SHALL BE DEEMED AN ACCEPTANCE OF SUCH TERMS AND CONDITIONS OR A WAIVER OF THE PROVISIONS HEREOF.

ORDERS:

1. Buyer must issue a Purchase Order or otherwise place an order by means acceptable to GlobTek. Orders shall identify the Products, unit quantities, part numbers, descriptions, applicable prices, ship to address and requested delivery dates. All orders are subject to acceptance by GlobTek. No order may be cancelled or rescheduled without GlobTek's consent. Consent may be given by GlobTek in its sole discretion. GlobTek reserves the right to add a Rescheduling Fee should Seller deem applicable. Seller reserves the right to allocate sales of Products among its customers in its sole discretion.

RESTOCKING TERMS:

1. Returning of stock items only: All claims must be made within ten (10) days of receipt of goods. GlobTek must authorize all returns. No return of product will be accepted without GlobTek's Return Merchandise Authorization (RMA) number. All authorized returns will be subject to a minimum of 25% restocking charge* and buyer must pay return freight to GlobTek. Parts must be in original condition and packaging.
2. *Custom items and/or dedicated production lots are not returnable.

RETURNED MERCHANDISE:

1. Replacement or credit will not be allowed for products returned without prior consent. No return of product will be accepted without a GlobTek RMA number. RMA requests for all goods that are found to be not in compliance with Seller's specifications shall be made according to Seller's RMA procedure within thirty (30) days of invoice/shipment date and may be replaced, repaired, or credited at GlobTek's option. All RMA claims reported more than thirty (30) days after the invoice/shipment date are not eligible for return, replacement or credit at subject to GlobTek's Terms and Conditions. GlobTek will not issue credit if the Product has been altered, repaired, or opened by persons other than those authorized by GlobTek, become defective due to acts of God or negligence, become defective due to being subjected to abnormal conditions during installation, application or maintenance or if warranty has expired. Acceptance of Buyer's debit will not be made until material has been received and evaluated by the GlobTek. To determine the "Root Cause of Failure", the product may be destroyed during evaluation. If this occurs all of the above Terms and Conditions will remain in effect. All freight costs for returns, both from customer back to GlobTek and GlobTek back to customer will not be borne by GlobTek. GlobTek requires all goods to be returned freight, duty, and taxes prepaid to the location provided in the RMA authorization notification and repaired or replaced goods will be provided

GloTek, Inc. www.globtek.com 186 Veterans Drive, Northvale, NJ 07647 Tel. (201) 784-1000 Fax (201) 784-0111	Drawing Title: GTM96181-36PD GTM96181-36PD USB Adaptive Power Source ICT/ITE/Medical Power supply Efficiency Level: USA DOE Level VI / Eco-design Directive 2009/125/EC, (EU) 2019/1782, Case Color/Style: GlobTek Black, Wall Plug-in USB Adaptive Power Supply AC Adaptor, Input Rating: 100-240V~, 50-60 Hz Interchangeable Blades https://www.globtek.com/interchangeable-blades.php Output Rating: 36.00W, 5.0V, 5.8V, 9.0V, 12.0V, 15.0V, 15.1V, 20.0VV@3.0A, 3.0A, 3.0A, 3.0A, 2.4A, 2.38A, 1.8AA Pin Out: +V: A4, A9, B4, B9, COM: A1, A12, B1, B12, CC1: A5, D+:A6, D-:A7 Approvals: : UKCA; WEEE; China RoHS; Ukraine; PSE; RoHS; cETLus 60601-1 3rd (pending); VCCI; CB 62368; CB 60950 (pending); 230V CoC Tier 2; EAC; FCC; CCC; Double Insulation; LPS 62368; CB 60601-1 (pending); Level VI; RCM; CAN ICES-3; Morocco; Korea; NOM; UAE (pending); Taiwan BSMI pending; Singapore;	
	Model No. GTM96181-36PD	
	Part No./Ordering No. WR9QZ1800USBCIM(R6B)	Rev B4

on an EX WORKS return location. GlobTek shall not be responsible, under any circumstances, for any rework or modification fee's or costs not previously authorized in writing by GlobTek. If returned goods do not match the quantity or descriptions provided in the RMA application, any non conforming goods will not be qualified for repair, return, or replacement. Goods with illegible date code/serial # information may not be eligible for repair, return, replacement

PRICES/TAXES/TARIFFS:

- Prices shall be as specified by Seller and shall be applicable for the period specified in GlobTek's quote. If no period is specified, prices shall be applicable for thirty (30) days. Notwithstanding the foregoing, prices shall be subject to increase in the event of an increase in GlobTek's costs or other circumstances beyond GlobTek's reasonable control. Prices are exclusive of taxes, impositions, tariffs, fees, and other charges, including, without limitation, sales, use, excise, value added, and ad valorem taxes, as well as tariffs of all types (including any tariffs imposed pursuant to any Section 301 Action by the United States Trade Representative) and similar taxes, fees, imposts, or charges of whatsoever kind, imposed now or in the future by any foreign or domestic governmental authority, international shipping charges, forwarding agent's and broker's fees, consular fees, document fees and import duties. If GlobTek shall be liable to collect and/or pay, or if the GlobTek shall pay, any of the foregoing, Buyer shall pay same to GlobTek in addition to the price of the Products.

TERMS OF PAYMENT:

- Payment shall be net thirty (30) days from date of invoice or as otherwise specified by GlobTek. Buyer agrees to pay the entire net amount of each invoice from Seller pursuant to the terms of each such invoice without offset or deduction. Orders are subject to credit approval by GlobTek, which may in its sole discretion at any time change the terms of Buyer's credit, require payment in cash, bank wire transfer, or by official bank check and/or require payment of any or all amounts due or to become due for Buyer's order before shipment of any or any of the Products. If GlobTek believes in good faith that Buyer's ability to make payments may be impaired or if Buyer shall fail to pay any invoice when due, GlobTek may suspend delivery of any order or any remaining balance thereof until such payment is made or cancel any order or any remaining balance thereof, and Buyer shall remain liable to pay for any Products already shipped and all Products ordered by Buyer. Buyer agrees to submit such financial information from time to time as may be reasonably requested by GlobTek for the establishment and/or continuation of credit terms. Checks are accepted subject to collection and the date of collection shall be deemed the date of payment. Any check received from Buyer may be applied by GlobTek against any obligation owing from Buyer to GlobTek, regardless of any statement appearing on or referring to such check, without discharging Buyer's liability for any additional amounts owing from Buyer to GlobTek, and the acceptance by GlobTek of such check shall not constitute a waiver of GlobTek's right to pursue the collection of any remaining balance. Buyer shall pay interest on any invoice not paid when due according to the due date at the rate of eighteen (18%) percent annually or the highest rate allowable by law. If Buyer fails to make payment when due, GlobTek may pursue any legal or equitable remedies, in which event GlobTek shall be entitled to reimbursement for costs of collection and reasonable attorneys fees.

REFUSED OR DAMAGED SHIPMENTS:

- All products returned to GlobTek due to refusal of acceptance by buyer, without GlobTek authorization, will be subject to minimum of 25% restocking charge* and buyer must pay return freight to GlobTek. Parts must be in original condition and packaging. Seller takes extra precautions to insure that shipments are made under the Highest Quality Standards. In the event a

GloTek, Inc. www.globtek.com 186 Veterans Drive, Northvale, NJ 07647 Tel. (201) 784-1000 Fax (201) 784-0111	Drawing Title: GTM96181-36PD GTM96181-36PD USB Adaptive Power Source ICT/ITE/Medical Power supply Efficiency Level: USA DOE Level VI / Eco-design Directive 2009/125/EC, (EU) 2019/1782, Case Color/Style: GlobTek Black, Wall Plug-in USB Adaptive Power Supply AC Adaptor, Input Rating: 100-240V~, 50-60 Hz Interchangeable Blades https://www.globtek.com/interchangeable-blades.php Output Rating: 36.00W, 5.0V, 5.8V, 9.0V, 12.0V, 15.0V, 15.1V, 20.0VV@3.0A, 3.0A, 3.0A, 3.0A, 2.4A, 2.38A, 1.8AA Pin Out: +V: A4, A9, B4, B9, COM: A1, A12, B1, B12, CC1: A5, D+:A6, D-:A7 Approvals: : UKCA; WEEE; China RoHS; Ukraine; PSE; RoHS; cETLus 60601-1 3rd (pending); VCCI; CB 62368; CB 60950 (pending); 230V CoC Tier 2; EAC; FCC; CCC; Double Insulation; LPS 62368; CB 60601-1 (pending); Level VI; RCM; CAN ICES-3; Morocco; Korea; NOM; UAE (pending); Taiwan BSMI pending; Singapore;	
	Model No. GTM96181-36PD	
	Part No./Ordering No. WR9QZ1800USBCIM(R6B)	Rev B4

shipment is received in damaged condition, Buyer shall contact the carrier to submit claim, keep Products in original boxes pending carrier's inspection and place a replacement order with the Seller.

2. *Custom items and/or dedicated production lots are not returnable.

TECHNICAL ADVICE AND DATA:

1. Any technical advice offered or given in connection with the use of any goods is an accommodation to Buyer without charge and GlobTek shall have no responsibility or liability whatsoever for the content or use of such advice. Without GlobTek's prior written consent, Buyer shall not use, duplicate or disclose any technical data delivered or disclosed by GlobTek to Buyer for any purposes other than for installation, operation or maintenance of goods purchased by Buyer. Any use made of GlobTek classifications, whether it be ECCNs or any variation of Harmonized Tariff codes, is without recourse to GlobTek and at the user's risk. Export classifications are subject to change. If you export or re-export, your company, as the exporter of record, is responsible for determining the correct classification of any item at the time of export. Any export classification by GlobTek is for GlobTek's internal use only and shall not be construed as a representation or warranty regarding the proper export classification nor relied upon to make licensing determinations.

Tariff Surcharge – Section 301 and Related Import Duties

GlobTek, Inc. hereby notifies all customers that a tariff surcharge fee is applied to cover import duties and tariffs, including but not limited to those imposed under Section 301 of the U.S. Trade Act of 1974, affecting Chinese-origin goods imported into the United States between 2018 and 2025.

Customers receiving delivery from U.S.-based shipping points were and are informed of the tariff surcharge:

- At the time of quotation;
- During order entry; and
- Through routine updates issued during the order process.

Due to the volatility of tariff rates and ongoing changes in U.S. trade policy, GlobTek reserves the right to adjust the tariff surcharge fee:

- To match the current applicable tariff rates, or
- To reflect the maximum applicable tariff rate assessed on the product(s) in question, depending on the date of importation into the U.S.

By placing an order with GlobTek for goods that are produced in china built to order and imported from China, the customer expressly acknowledges and agrees to pay the applicable tariff surcharge fee. This surcharge is non-negotiable and is considered a part of the total purchase price for applicable transactions.

GloTek, Inc. www.globtek.com 186 Veterans Drive, Northvale, NJ 07647 Tel. (201) 784-1000 Fax (201) 784-0111	Drawing Title: GTM96181-36PD GTM96181-36PD USB Adaptive Power Source ICT/ITE/Medical Power supply Efficiency Level: USA DOE Level VI / Eco-design Directive 2009/125/EC, (EU) 2019/1782, Case Color/Style: GlobTek Black, Wall Plug-in USB Adaptive Power Supply AC Adaptor, Input Rating: 100-240V~, 50-60 Hz Interchangeable Blades https://www.globtek.com/interchangeable-blades.php Output Rating: 36.00W, 5.0V, 5.8V, 9.0V, 12.0V, 15.0V, 15.1V, 20.0VV@3.0A, 3.0A, 3.0A, 3.0A, 2.4A, 2.38A, 1.8AA Pin Out: +V: A4, A9, B4, B9, COM: A1, A12, B1, B12, CC1: A5, D+:A6, D-:A7 Approvals: : UKCA; WEEE; China RoHS; Ukraine; PSE; RoHS; cETLus 60601-1 3rd (pending); VCCI; CB 62368; CB 60950 (pending); 230V CoC Tier 2; EAC; FCC; CCC; Double Insulation; LPS 62368; CB 60601-1 (pending); Level VI; RCM; CAN ICES-3; Morocco; Korea; NOM; UAE (pending); Taiwan BSMI pending; Singapore;	
	Model No. GTM96181-36PD	
	Part No./Ordering No. WR9QZ1800USBCIM(R6B)	Rev B4

FORCE MAJEURE:

1. GlobTek shall not be liable for failure to fulfill the obligations herein or for delays in delivery due to causes beyond its reasonable control, including, but not limited to, acts of God, natural disasters, acts or omissions of other parties acts or omissions of civil or military authority, Government priorities, changes in law, material shortages, fire, strikes, floods, epidemics, quarantine restrictions, riots, war, acts of terrorism, delays in transportation or inability to obtain labor or materials through its regular sources. GlobTek's time for performance of any such obligation shall be extended for the time period of such delay or GlobTek may, at its option cancel any order or remaining part thereof without liability, advising in writing notice of such cancellation to Buyer.

LIMITATION OF LIABILITIES:

1. BUYER SHALL NOT IN ANY EVENT BE ENTITLED TO, AND SELLER SHALL NOT BE LIABLE FOR INDIRECT, SPECIAL, INCIDENTAL OR CONSEQUENTIAL DAMAGES OF ANY NATURE INCLUDING, WITHOUT LIMITATION BUSINESS INTERRUPTION COSTS, REMOVAL AND/OR REINSTALLATION COSTS, REPROCUREMENT COSTS, LOSS OF PROFIT OR REVENUE, LOSS OF DATA, PROMOTIONAL OR MANUFACTURING EXPENSES, OVERHEAD, INJURY TO REPUTATION OR LOSS OF CUSTOMERS, EVEN IF GLOBTEK HAS BEEN ADVISED OF THE POSSIBILITY OF SUCH DAMAGES. BUYER'S RECOVERY FROM SELLER FOR ANY CLAIM SHALL NOT EXCEED BUYER'S PURCHASE PRICE FOR THE PRODUCT GIVING RISE SUCH CLAIM IRRESPECTIVE OF THE NATURE OF THE CLAIM, WHETHER IN CONTRACT, TORT, WARRANTY OR OTHERWISE. GLOBTEK SHALL NOT BE LIABLE FOR AND BUYER SHALL INDEMNIFY, DEFEND AND HOLD GLOBTEK HARMLESS FROM ANY CLAIMS BASED ON GLOBTEK'S COMPLIANCE WITH BUYER'S DESIGNS, SPECIFICATIONS OR INSTRUCTIONS, OR MODIFICATION OF ANY PRODUCTS BY PARTIES OTHER THAN SELLER, OR USE IN COMBINATION WITH OTHER PRODUCTS. GLOBTEK INC. WILL NOT BE LIABLE FOR THE SAFETY AND PERFORMANCE OF THESE PRODUCTS IF UNAUTHORIZED USE, ACCESS AND/OR REPAIR. END USER SHOULD CONSULT APPLICABLE UL, CSA OR EN STANDARDS FOR PROPER INSTALLATION INSTRUCTIONS. GLOBTEK PRODUCTS ARE NOT AUTHORIZED FOR USE AS MISSION CRITICAL COMPONENTS IN LIFE SUPPORT, HAZARDOUS ENVIRONMENT, NUCLEAR OR AIRCRAFT APPLICATIONS WITHOUT PRIOR WRITTEN APPROVAL FROM THE CEO OF GLOBTEK INC. CONTENTS OF GLOBTEK SPECIFICATIONS ARE SUBJECT TO CHANGE WITHOUT PRIOR NOTICE.

GENERAL:

1. As used herein, terms appearing in the singular shall include the plural and terms appearing in the plural shall include singular. No rights, duties, agreements or obligations hereunder may be assigned or transferred by either party, by operation of law, merger or otherwise, without the prior written consent of the other. Any attempted or purported assignment shall be void. Notwithstanding the foregoing, GlobTek's obligations under these Terms and Conditions may be performed by divisions, subsidiaries or affiliates of GlobTek. The obligations, rights, terms and conditions hereof shall be binding on the parties hereto and their respective successors and assigns. The waiver of any provision hereof or of any breach or default hereunder shall not be deemed a waiver of any other provision hereof or breach or default hereunder. Any provision hereof which is prohibited or

GloTek, Inc. www.globtek.com 186 Veterans Drive, Northvale, NJ 07647 Tel. (201) 784-1000 Fax (201) 784-0111	Drawing Title: GTM96181-36PD GTM96181-36PD USB Adaptive Power Source ICT/ITE/Medical Power supply Efficiency Level: USA DOE Level VI / Eco-design Directive 2009/125/EC, (EU) 2019/1782, Case Color/Style: GlobTek Black, Wall Plug-in USB Adaptive Power Supply AC Adaptor, Input Rating: 100-240V~, 50-60 Hz Interchangeable Blades https://www.globtek.com/interchangeable-blades.php Output Rating: 36.00W, 5.0V, 5.8V, 9.0V, 12.0V, 15.0V, 15.1V, 20.0VV@3.0A, 3.0A, 3.0A, 3.0A, 2.4A, 2.38A, 1.8AA Pin Out: +V: A4, A9, B4, B9, COM: A1, A12, B1, B12, CC1: A5, D+:A6, D-:A7 Approvals: : UKCA; WEEE; China RoHS; Ukraine; PSE; RoHS; cETLus 60601-1 3rd (pending); VCCI; CB 62368; CB 60950 (pending); 230V CoC Tier 2; EAC; FCC; CCC; Double Insulation; LPS 62368; CB 60601-1 (pending); Level VI; RCM; CAN ICES-3; Morocco; Korea; NOM; UAE (pending); Taiwan BSMI pending; Singapore;	
	Model No. GTM96181-36PD	
	Part No./Ordering No. WR9QZ1800USBCIM(R6B)	Rev B4

unenforceable in any jurisdiction shall, as to such jurisdiction, be ineffective to the extent of such prohibition or unenforceability without invalidating the remaining provisions hereof in that jurisdiction or affecting the validity or enforceability of such provision in any other jurisdiction. These Terms and Conditions shall be governed by and construed in accordance with the laws of the State of New Jersey, United States, excluding any law or principle, which would apply the law of any other jurisdiction. The United Nations Convention on contracts for the International Sale of Goods shall not apply to these Terms.

LIMITED WARRANTIES:

- GLOBTEK'S POWER SUPPLIES ARE BUILT WITH PRIDE BY PROFESSIONALS DEDICATED TO UNCOMPROMISING QUALITY AND RELIABILITY. YOUR COMPLETE SATISFACTION WITH OUR PRODUCTS IS OUR PARAMOUNT OBJECTIVE. IF GLOBTEK IS GIVEN NOTICE OF A DEFECT IN MATERIALS OR WORKMANSHIP OCCURRING WITHIN FIVE (5) YEARS FROM THE DATE OF SHIPMENT BY GLOBTEK, THEN GLOBTEK SHALL, AT ITS SOLE OPTION: 1) REPAIR OR REPLACE THE DEFECTIVE PART(S) OR PRODUCT(S) OR 2) REFUND THE ORIGINAL PURCHASE PRICE, BOTH SUBJECT TO THE FOLLOWING PROVISIONS OF THIS PARAGRAPH. THIS WARRANTY ONLY EXTENDS TO POWER SUPPLIES, ELECTRICAL ASSEMBLIES AND POWER CABLES MADE BY GLOBTEK. THIS WARRANTY DOES NOT EXTEND TO ANY AND ALL BATTERY CELLS, OR TO BRANDED CONNECTOR ITEMS, CUSTOMER SPECIFIED ITEMS FROM OTHER MANUFACTURERS, CUSTOMER SUPPLIED MATERIALS, OR DEFECTS RESULTING FROM CUSTOMER SUPPLIED MATERIALS. DEFECTS RESULTING FROM CUSTOMER SUPPLIED MATERIALS WILL NULLIFY THIS WARRANTY. THIS WARRANTY ALSO DOES NOT EXTEND TO PRODUCTS WHICH HAVE BEEN OPENED, ALTERED OR REPAIRED BY PERSONS OTHER THAN PERSONS AUTHORIZED BY THE MANUFACTURER OR TO PRODUCTS WHICH BECOME DEFECTIVE DUE TO ACTS OF GOD AND OTHER ACTS CONSTITUTING FORCE MAJEURE AS DEFINED IN SECTION 8 ABOVE, NEGLIGENCE OR THE FAILURE OF THE USER TO FULLY FOLLOW INSTRUCTIONS WITH RESPECT TO INSTALLATION, APPLICATION OR MAINTENANCE. THIS WARRANTY DOES NOT EXTEND TO PRODUCTS WHICH HAVE BEEN SUBJECT TO ABNORMAL USE, ABNORMAL CONDITIONS, IMPROPER STORAGE, SPILLAGE OF LIQUIDS, MISUSE, NEGLIGENCE, EXPOSURE TO CLEANING AGENTS NOT RECOMMENDED BY THE MANUFACTURER, OR OTHER ACTS WHICH ARE NOT THE FAULT OF GLOBTEK. THIS WARRANTY DOES NOT COVER ORDINARY WEAR AND TEAR, DEFECTS IN APPEARANCE, COSMETIC, DECORATIVE OR STRUCTURAL ITEMS OR NON-OPERATIVE PARTS. WITH REGARD TO BATTERY CELLS, OR TO BRANDED CONNECTOR ITEMS, CUSTOMER SPECIFIED ITEMS FROM OTHER MANUFACTURERS, AND CUSTOMER SUPPLIED MATERIALS, THE BUYER IS REFERRED TO THE MANUFACTURER'S WARRANTY, IF ANY. FOR RECHARGEABLE BATTERY PACK PRODUCTS, ANY CLAIM FOR WARRANTY MUST BE SUPPORTED BY AUDITABLE EVIDENCE OF PROPER USE, HANDLING, AND MAINTENANCE ACCORDING TO GLOBTEK AND CELL MANUFACTURER SPECIFICATIONS. THIS WARRANTY IS NOT A WARRANTY OF FUTURE PERFORMANCE. IN ORDER TO EXERCISE THE BUYER'S REMEDY FOR BREACH OF THIS LIMITED WARRANTY, GLOBTEK MUST BE GIVEN WRITTEN NOTICE OF A DEFECT IN MATERIALS OR WORKMANSHIP WITHIN FIVE (5) YEARS OF THE DATE OF SHIPMENT. FURTHER, GLOBTEK'S INSPECTION ESTABLISHES THE EXISTENCE OF A DEFECT. PACKAGING, FREIGHT, INSURANCE AND OTHER CHARGES INCURRED IN RETURNING THE DEFECTIVE PRODUCTS TO WILL BE PAID BY THE BUYER. IF THE BUYER FAILS TO FULLY COMPLY WITH THE FOREGOING, BUYER SHALL NOT BE ENTITLED TO ANY ALLOWANCE OR CLAIM WITH RESPECT TO SUCH PRODUCT. THE BUYER AGREES THAT NO OTHER REMEDY (INCLUDING, BUT NOT LIMITED TO, INCIDENTAL OR CONSEQUENTIAL DAMAGES FOR LOST PROFITS, LOST SALES, INJURY TO PERSON OR PROPERTY OR ANY OTHER INCIDENTAL OR CONSEQUENTIAL LOSSES) SHALL BE AVAILABLE TO THE BUYER.

<p>GlobTek, Inc. www.globtek.com 186 Veterans Drive, Northvale, NJ 07647 Tel. (201) 784-1000 Fax (201) 784-0111</p>	<p>Drawing Title: GTM96181-36PD GTM96181-36PD USB Adaptive Power Source ICT/ITE/Medical Power supply Efficiency Level: USA DOE Level VI / Eco-design Directive 2009/125/EC, (EU) 2019/1782, Case Color/Style: GlobTek Black, Wall Plug-in USB Adaptive Power Supply AC Adaptor, Input Rating: 100-240V~, 50-60 Hz Interchangeable Blades https://www.globtek.com/interchangeable-blades.php Output Rating: 36.00W, 5.0V, 5.8V, 9.0V, 12.0V, 15.0V, 15.1V, 20.0VV@3.0A, 3.0A, 3.0A, 2.4A, 2.38A, 1.8AA Pin Out: +V: A4, A9, B4, B9, COM: A1, A12, B1, B12, CC1: A5, D+:A6, D-:A7 Approvals: : UKCA; WEEE; China RoHS; Ukraine; PSE; RoHS; cETLus 60601-1 3rd (pending); VCCI; CB 62368; CB 60950 (pending); 230V CoC Tier 2; EAC; FCC; CCC; Double Insulation; LPS 62368; CB 60601-1 (pending); Level VI; RCM; CAN ICES-3; Morocco; Korea; NOM; UAE (pending); Taiwan BSMI pending; Singapore;</p>
	<p>Model No. GTM96181-36PD</p>
	<p>Part No./Ordering No. WR9QZ1800USBCIM(R6B) Rev B4</p>

2. EXCEPT FOR THE FOREGOING EXPRESS LIMITED WARRANTY, GLOBTEK MAKES NO WARRANTY, EXPRESS OR IMPLIED, INCLUDING, BUT NOT LIMITED TO, THE WARRANTIES OF MERCHANTABILITY AND FITNESS FOR A PARTICULAR PURPOSE, ALL OF WHICH IMPLIED WARRANTIES ARE HEREBY SPECIFICALLY DISCLAIMED.