

# ***EMMO IKONG PRO***

**OWNER'S MANUAL**



# Preface

## An Important Message From EMMO

Thank you for choosing EMMO. Congratulations on your purchase of a new IKONG PRO.

This document is intended as a short introduction to your new e-bike. It contains essential safety, performance and service information. Please read and understand this manual fully before assembling and riding your bike. Be sure to watch the official Emmo IKONG PRO assembly video available at <https://emmo.ca/pages/e-bike-assembly-guide>.

Additional information about your bike can be found on our website at [www.emmo.ca](http://www.emmo.ca).

Be sure to check all hardware for correct torque during assembly.

## Illustrations

Illustrations shown in this document may differ in detail from the exact configuration on your particular e-bike model. The illustrations are a general reference for instruction and description purposes only.

## Service & Support

If you have questions after reading this manual and watching the assembly video, please feel free to contact us.

**E-mail:** [service@emmo.ca](mailto:service@emmo.ca)

**Toll Free:** 1-888-217-1217

**Find Emmo dealers near you:** <https://emmo.ca/pages/locations>

# Content

<b>About This Manual .....</b>	<b>6</b>
<b>About EMMO .....</b>	<b>7</b>
<b>Rules and Regulations .....</b>	<b>8</b>
<b>Safety Disclaimer .....</b>	<b>12</b>
<b>Description .....</b>	<b>16</b>
Schematic Diagram .....	16
Geometry .....	16
Specifications .....	17
Side View .....	18
Handlebar Attachments .....	19
Lights Signal & Horn Switch .....	20
Control Function .....	21
<b>Operation Guide .....</b>	<b>22</b>
Speedometer & Control .....	22
Display .....	22
Navigation .....	24

Function Summary.....	25
Bluetooth APP.....	54
Error Code.....	55
Restore.....	57
OTA.....	58
<b>Adjusting the Seat Height.....</b>	<b>59</b>
<b>Adjusting the Saddle Position.....</b>	<b>60</b>
<b>Battery.....</b>	<b>61</b>
Charge Indicator.....	62
Battery Charging Port.....	63
Discharge port.....	64
Battery Lock.....	65
Battery Safety Precautions.....	68
Disposal.....	69
Storage & Maintenance.....	70
<b>Charger.....</b>	<b>71</b>
Charging Indicator.....	72
Charger Specification Label.....	73

Power Cord Socket.....	74
Power Cord.....	74
Charger Plug.....	75
Charging Precautions.....	76
<b>Gear Shifters.....</b>	<b>78</b>
Throttle.....	79
Adjusting the Suspension Fork.....	80
Adjusting the Quick-Release Stem.....	81
Torque Sensor.....	83
Cleaning / Lubricating the Chain.....	84
Tire Pressure.....	86
Serial Number.....	87
<b>Troubleshooting.....</b>	<b>89</b>
<b>Riding Guide.....</b>	<b>94</b>
<b>Warranty Policy.....</b>	<b>95</b>
<b>Leave us a Review.....</b>	<b>98</b>
<b>Contact Us.....</b>	<b>99</b>

## About This Manual

This document is intended as a short introduction to your new e-bike. It contains important safety, performance and service information. Read and understand it along with the information provided during the on-delivery instructions before using the product. Pay special attention to the safety messages as shown here, and keep the manual handy for future reference.



**WARNING:** Warning about a situation that can cause death, serious physical injury and or heavy material damage if one does not obey the safety instructions.



**DANGER:** Danger statement indicates a hazardous situation that, if not avoided, has a very high risk of death, serious injury, or property damage.



**CAUTION:** Caution statement indicates a hazardous situation that, if not avoided, could result in minor or moderate injury or property damage.



**NOTICE:** Warning about a situation that can cause death, serious physical injury and or heavy material damage if one does not obey the safety instructions.

## About EMMO

Emmo is a leading Canadian manufacturer of electric bikes based in Toronto, Ontario. Since 2009, we have equipped over 500,000 people across North America with eco-friendly transportation, emphasizing a zero-emission future. Our diverse range of products caters to commuting and leisure, enhancing every ride with effortless and enjoyable cycling experiences.

At Emmo, we are committed to fostering a greener lifestyle through innovative design and advanced technology. Our e-bikes are developed in North America and rigorously tested in state-of-the-art facilities to ensure supreme quality. We offer a wide dealer network with over 100 retailers, ensuring easy accessibility for our customers.

Every Emmo e-bike incorporates programmable sine-wave BLDC controllers for higher performance and reliability in all conditions. Backed by a comprehensive warranty, our commitment to innovation has made us a steadfast leader in the e-bike industry for over 15 years, continuously striving to make e-bikes more accessible and communities greener.

# Rules and Regulations

According to **Canada's Motor Vehicle Safety Regulations ( MVSRR )**. A qualified e-bike (defined as Power Assist Bicycle) must meet the following requirements:

- The e-bike must have operational pedals
- Upper wattage limit for the motor is 500W
- Maximum speed of an e-bike is 32km/h.

Other requirements include a compliance label affirming the vehicle meets power-assisted bicycle statutory requirements at manufacture. Currently, operating a qualified e-bike requires no license, insurance, or registration under federal law. E-bike riders have the same rights and responsibilities as other road users.

However, provinces and municipalities can restrict e-bike use. Most provinces mandate helmets. Some specify age limits, helmet types, wheel number, and size. In Ontario, e-bikes are generally treated like bicycles. The Ministry of Transportation of Ontario (MTO) specifies riders must be 16 or older; the bike's maximum weight is 120 kilograms (265 pounds); it must brake within 9 meters; and modifications to increase speed over 32km/h are prohibited.

Rules vary across provinces and municipalities. Check local bylaws for specific regulations.

# Rules and Regulations

## Useful links:

E-Bike Regulations in Ontario:  
<https://www.ontario.ca/page/riding-e-bike>

E-Bike Regulations in British Columbia:  
<https://www2.gov.bc.ca/gov/content/transportation/driving-and-cycling/cycling/e-bike-rules-of-the-road>

E-Bike Regulations in Alberta:  
<http://www.transportation.alberta.ca/content/doctype45/production/mopedpowerbikes.pdf>

E-Bike Regulations in Manitoba:  
[https://www.gov.mb.ca/sd/parks/\\_resources/en/pdf/power-assisted-bicycles.pdf](https://www.gov.mb.ca/sd/parks/_resources/en/pdf/power-assisted-bicycles.pdf)

E-Bike Regulations in Saskatchewan:  
[https://www.sgi.sk.ca/motorcycle/-/knowledge\\_base/motorcycle-handbook/power-assisted-bicycles1](https://www.sgi.sk.ca/motorcycle/-/knowledge_base/motorcycle-handbook/power-assisted-bicycles1)

E-Bike Regulations in Quebec:  
<https://saaq.gouv.qc.ca/en/road-safety/modes-transportation/electric-bike>

E-Bike Regulations in New Brunswick:  
[https://www2.gnb.ca/content/gnb/en/services/services\\_renderer.200814.Motor\\_Vehicle\\_Registration.html](https://www2.gnb.ca/content/gnb/en/services/services_renderer.200814.Motor_Vehicle_Registration.html)

E-Bike Regulations in Nova Scotia:

<https://novascotia.ca/just/regulations/regs/mv18786.htm>

E-Bike Regulations in Prince Edward Island:

<https://www.princeedwardisland.ca/en/information/transportation-and-infrastructure/power-assisted-bicycles>

### **Know and obey all relevant local laws**

It is your responsibility to research and understand relevant laws where you ride your bike. Such laws may cover required helmets and safety gear, required lights and reflectors, required hand signals, where you can legally ride a bike (bikes and ebikes may have different restrictions), how fast you can go, what (if any) cargo or passengers you can carry, rider age, and more. Before using public transportation—buses, trains, etc.—to transport your e-bike, check with the relevant transportation authority for any rules governing weight limits, tire widths, lithium-ion batteries, or any other rules that might pertain to e-bikes. When you ride on the road, assume you must, at minimum, follow all of the rules that cars must follow. For additional information regarding traffic and vehicle laws, contact the road traffic authority in your area.

The product(s) comply with federal regulations for this product category in Canada and with applicable provincial regulations in the region of sale at the time of purchase. In jurisdictions where the product(s) may NOT be compliant, the buyer acknowledges this possibility and accepts full responsibility for their use. The buyer is solely responsible for understanding and complying with all applicable laws, regulations, and bylaws related to the operation and use of the product(s) in their local area. If the product(s) are capable of going faster than the applicable legal speed limit, the

seller is NOT responsible for the speed at which the buyer operates the product(s). Any future changes to legislation or regulatory classification that affect where or how the product(s) may be used are outside the control of the seller and shall NOT constitute valid grounds for return, refund, or compensation. Such changes do NOT imply any defect or misrepresentation of the product(s) at the time of sale.

# Safety Disclaimer

This manual contains important safety, performance, and service information. Read and understand it along with the information provided during the on-delivery instructions before using the product, and keep it for reference. Ensure that you comprehend all instructions and safety NOTes/warnings.

**Definition:** In this manual, the term “Vehicle” refers collectively to any bike, ebike, etrike, or similar vehicle sold or authorized by EMMO.

## General Responsibility

- By choosing to ride a Vehicle, you assume full responsibility for all risks, including falls, collisions, equipment failure, and road or traffic hazards.
- Riders are responsible for following local laws and bylaws, practicing safe riding, and maintaining the Vehicle properly.
- Safe use depends on responsible riding, regular inspections, and timely replacement of worn components.



### **WARNING: Fit & Capability**

- Ensure the Vehicle fits you properly before riding; incorrect sizing may cause loss of control.
- Riders must have sufficient physical condition, reaction time, and mental capability to handle traffic and emergencies. If you have medical conditions (including impairments or seizure disorders), consult your physician before riding.

- Before the first ride, practice braking and throttle control in a safe environment.
- If riding at night, familiarize yourself with the lights and signals and ensure they function properly.



### **WARNING: Installation & Maintenance**

- Improper installation, compatibility issues, or poor maintenance can cause serious injury or death.
- Secure all hardware (handlebar, grips, seat, pedals, etc.) before each ride.
- Have the Vehicle inspected by an authorized technician at least once every 6 months.
- It is your full responsibility to ensure the Vehicle is in good working order at all times. Perform a pre-ride safety check before every ride (brakes, throttle, sensors, lights, and other key components).



### **WARNING: Battery & Charger Safety**

- The charger should only be used **indoors** in a cool, dry, ventilated area. Always position the charger on a **non-flammable surface** (e.g., concrete or brick), as it may generate heat during peak charging cycles.
- You must use a **dedicated 110V outlet** to charge your battery.
- Never cover the charger during charging or leave it unattended.
- Keep the battery and charger away from children, pets, water, and open flame.
- DO NOT submerge or allow the charger to be submerged in water or any liquid.

- **DO NOT** use the charger or battery if **any part of the cord, connector, or housing is frayed, cracked, exposed, or otherwise damaged**. Using damaged charging equipment or battery connectors can lead to malfunction, fire, or serious injury.
- Do NOT drop, strike, or expose them to shocks.
- Use only the charger supplied with the product or approved by EMMO.
- Disconnect promptly once fully charged. Do NOT charge for more than **12 hours**, whether the battery is full or not.
- If the battery is stored, check it at least **once a month**. If necessary, use the original charger to recharge the battery to about **75%**. Failure to perform regular checks or charging may result in malfunction or safety hazards.
- Disconnect immediately if there is a strange smell, smoke, or overheating.
- In the unlikely case of battery fire: **never use water**. Use sand to cover the fire and call emergency services.
- **Battery & Charger Rated Life Expectancy:** Lead-Acid Battery: 2 years (500 cycles); Lithium-Ion Battery: 4 years (1000 cycles); Charger: 4 years. All component lifespans assume normal use and proper maintenance. **Annual inspection & safety testing by an authorized technician are required to ensure safety.** Components that have exceeded their rated service life—or no longer provide expected performance—should be replaced to ensure safety and reliability. While proper care may extend usable life, this can NOT be guaranteed.



### **WARNING: Modifications & Non-Original Components**

- Do NOT use the Vehicle with trailers, stands, racks, or accessories that are not approved by EMMO. The use of non-original components or spare parts can jeopardize the safety of your Vehicle, void

your warranty, and, in some cases, cause your Vehicle to not conform with applicable laws.

- Any unauthorized modifications (to the electrical system, controller, battery, or structural components) may compromise safety. **Such modifications void the warranty and are performed at the rider's sole risk.**



### **WARNING: Extreme Riding**

- Vehicles and components are NOT designed for extreme use such as jumps, stunts, or riding beyond your ability.
- Extreme riding may cause component failure, severe injury, or death.

### **Final Note:**

- Always ride responsibly, maintain the Vehicle regularly, and replace components when necessary.
- The rider assumes all risks associated with operating this Vehicle.
- For questions or concerns, contact your authorized EMMO dealer or EMMO Customer Support.

# Description

## 1. Schematic Diagram

### a. Geometry

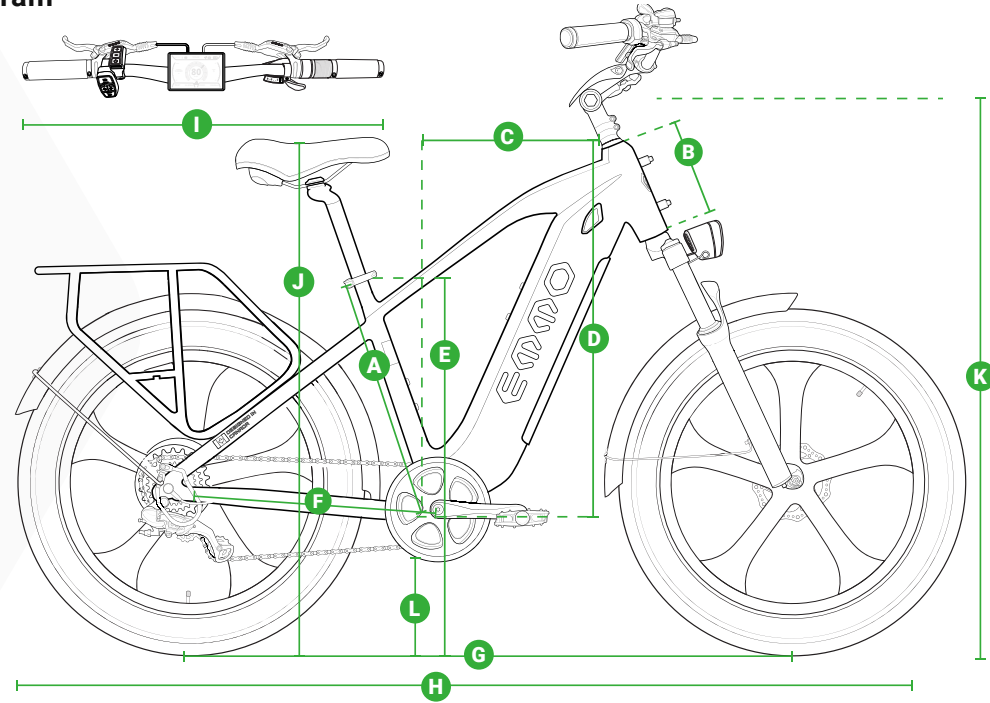

# Description

## 1. Schematic Diagram

### b. Specifications

## GEOMETRY

<b>A</b> Frame Size	18.5" /	47 cm
<b>B</b> Head Tube Length	5.7" /	15 cm
<b>C</b> Reach Distance	14" /	36 cm
<b>D</b> Stack	24" /	61 cm
<b>E</b> Stand Over	31" /	79 cm
<b>F</b> Chainstay Length	19.5" /	50 cm
<b>G</b> Wheelbase	46" /	118 cm
<b>H</b> Length	75" /	190 cm
<b>I</b> Width	29" /	73 cm
<b>J</b> Seat Height Range	33" - 42" /	83 - 102 cm
<b>K</b> Handlebar Height Range	43" /	110 cm
<b>L</b> Ground Clearance	11" /	29 cm

# Description

## 1. Schematic Diagram

### c. Side View

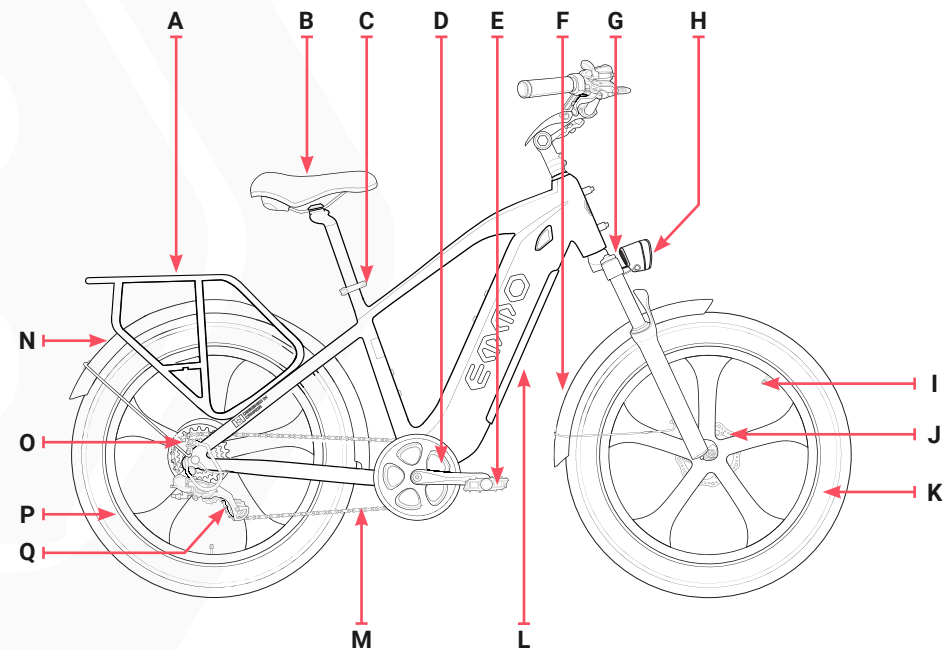

A	Rear Rack
B	Seat Cushion
C	Seat Clip
D	Pedal Crank
E	Pedal
F	Front Fender
G	Front Adjustable Shock
H	Headlight
I	Valve
J	Front Brake Disk
K	Front Rim
L	Battery
M	Chain
N	Rear Fender
O	Rear Brake Disk
P	Rear Rim With Motor
Q	Derailleur

# Description

## 1. Schematic Diagram

### d. Handlebar Attachments

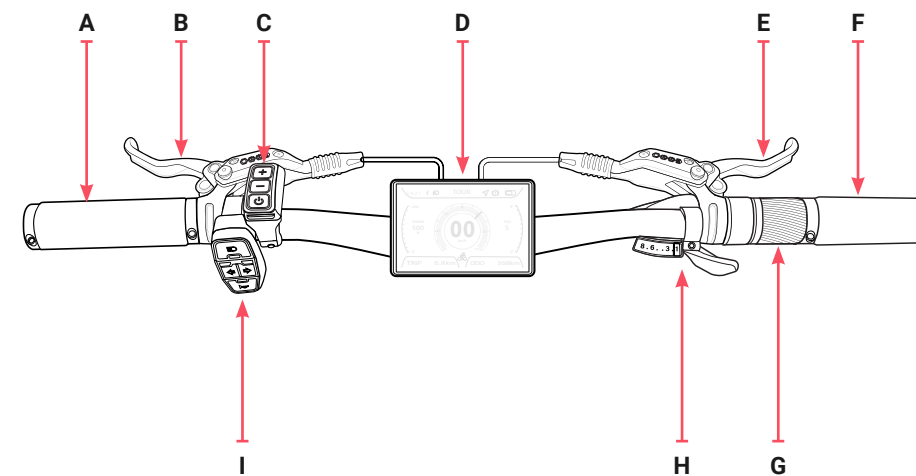

A	Left Hand Grip
B	Front Brake Lever
C	Control Button
D	Speedometer
E	Rear Brake Lever
F	Right Hand Grip
G	Throttle
H	Gear Shifter
I	Lights Signal & Horn Switch

# Description

## 1. Schematic Diagram

### e. Lights Signal & Horn Switch

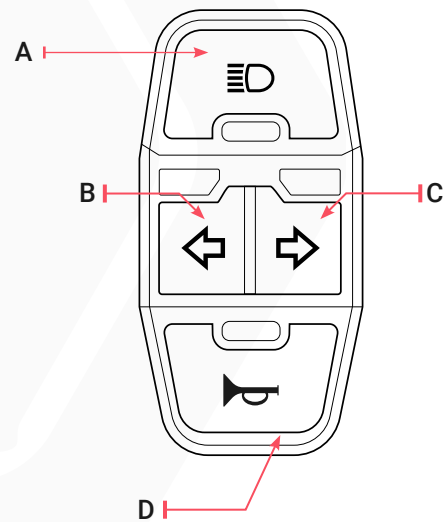

A		Headlight + Taillight	Press to turn on the headlight and tail light.
B		Left Turning Signal	Press to turn on the left side turning signal. Press again to cancel.
C		Right Turning Signal	Press to turn on the right side turning signal. Press again to cancel.
D		Horn	Press the button to sound the horn.

# Description

## 1. Schematic Diagram

### f. Control Function

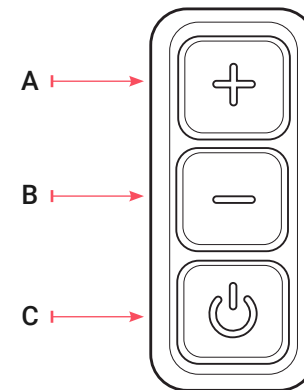

A	Plus (+) Button
B	Minus (-) Button
C	Power Button

### Power On/Off

Hold the **POWER** button for 1 second to turn on the display and controller. To turn off hold the **POWER** button for 1 second. The bike has an automatic shutdown function, which turns off the power if unused for an extended period. The auto shutdown time can be changed in settings.

# Operation Guide

## 1. Speedometer & Control

### a. Display



# Operation Guide

A		Headlight Indicator	Indicates if the status of the headlight is on/off. The icon lights up when the headlight is on.
B		Bluetooth Indicator	Indicates if the status of the bluetooth is on/off. The icon lights up when the bluetooth is on.
C		Time Display	Display the current time.
D		Fault Indicator	When there's a malfunction in the instrument or or vehicle motor controller, it promptly displays the corresponding fault code.
E		Power Indicator	Indicates the current power output of the bike.
F		Trip Distance	Displays the distance traveled for the current trip.
G		Mode Indicator	Display the current bike mode.
H		Navigation Indicator	The mobile app connects to the display via Bluetooth, and lights up when the mobile app starts to navigate.
I		Brake Indicator	When the brakes are applied, the instrument illuminates an indicator.
J		Battery Level Indicator	Indicates the current battery level of the bike.
K		Real-time Speed	Display the speed in real-time.
L		Pedal Assist Level	Display the pedal assist level.
M		Riding Mode	Indicates the current mode of the bike.
N		Total Distance Traveled	Display the total distance traveled.

# Operation Guide

## 1. Speedometer & Control

### b. Navigation

When the mobile phone connects to the instrument panel via Bluetooth and you enter the navigation interface to select a destination and start navigation, the main interface updates as follows:



<b>A</b>	Real-time Speed
<b>B</b>	Distance to Destination
<b>C</b>	Estimated Time of Arrival (ETA)
<b>D</b>	Next Turn Prompt and Distance

# Operation Guide

## 1. Speedometer & Control

### c. Function Summary

#### Enter the Password

You need to press the “+” button or “-” button to enter the password before entering the main interface, the **default password is 0000**.



# Operation Guide

## 1. Speedometer & Control

### c. Function Summary

#### Changing the Pedal Assist (PAS) Level

After entering the main interface, press the “+” button or “-” button to switch the PAS level. By default, there are 5 PAS level to choose from, which can also be changed in settings. No power output in level 0, level 1 is the lowest power and level 5 is the highest power. The default is 0 when the instrument is powered on.

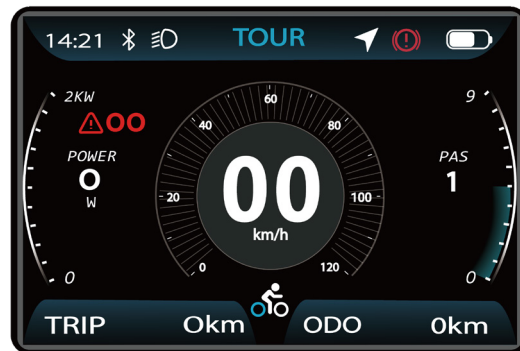

PAS 1

# Operation Guide

## 1. Speedometer & Control

### c. Function Summary

#### Turn ON/OFF Headlight and Taillight

**Turn on the light:** Hold the **Headlight** button shown on **page 16** when the light is turned off. The headlight indicator will light up, and the headlight/taillight will be turned on as well.

**Turn off the light:** Hold the **Headlight** button shown on **page 16**. The headlight indicator will no longer be lit, and the headlight/taillight will be turned off as well.

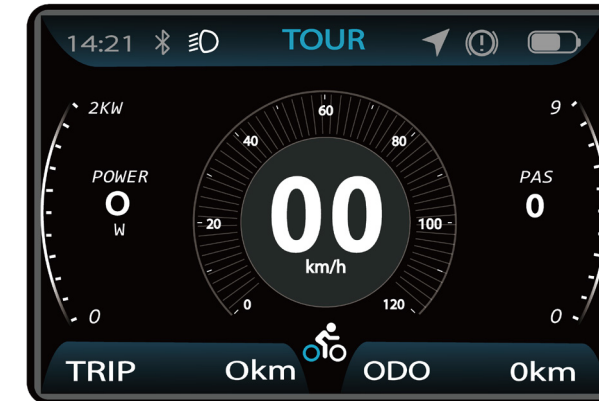

**! NOTICE:** Once the headlight indicator and headlight/taillight are on, the indicator will dim but not disappear. The indicator will turn off if the e-bike is turned off or if the headlight and taillight are turned off.

# Operation Guide

## 1. Speedometer & Control

### c. Function Summary

#### Walking Mode

When the vehicle is stationary, press and hold the “-” button to activate the walking mode. Keep the “-” button pressed to engage the boosting function. During walking mode, the walking logo  dynamically displays. To exit walking mode, release “-” button for up to 5 seconds. Upon release, the walking logo  will disappear, reverting to the riding logo .



WALKING MODE

# Operation Guide

## 1. Speedometer & Control

### c. Function Summary

Press the **Power** button to enter the list of settings, use the “+” button or the “-” button to switch between different setting, press **Power** to confirm selection between “Display Setting”, “Information”, “Language”, “Themes”, “Password”, “Bluetooth” and “Exit”.

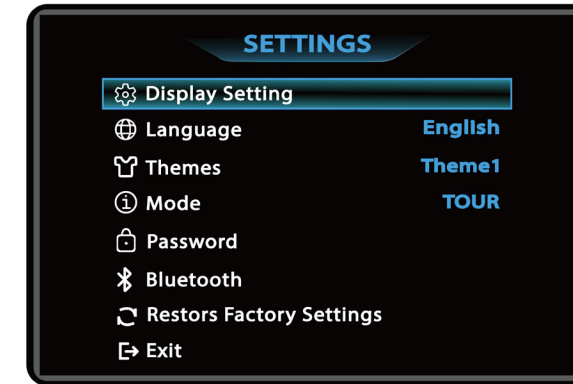

**! NOTICE:** Depending on the region, some features or settings may not be available.

# Operation Guide

## 1. Speedometer & Control

### c. Function Summary

#### Imperial and Metric Unit Conversions

Go to the “Display Setting” menu, select “Unit”, press **Power** to enter the settings. Use the “+” button or the “-” button to move the cursor up and down after entering the settings, and select “Metric” or “Imperial”, press **Power** to save and exit to “Unit”, Exit the menu via “Back” Exit to the main interface.

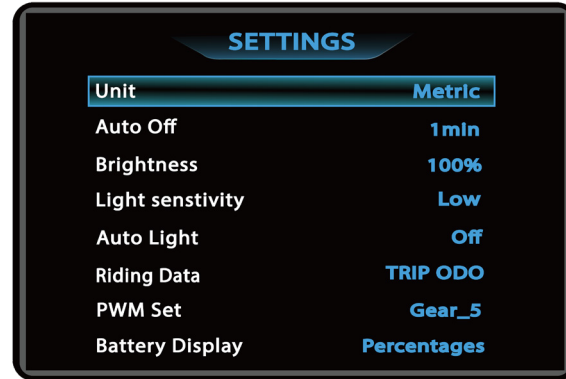

UNIT MILE

**! NOTICE:** The display is in imperial by default.

# Operation Guide

## 1. Speedometer & Control

### c. Function Summary

#### Automatic Shutdown

Go to the “Display Setting” menu, use the “+” button or the “-” button to move the cursor up or down, select “Auto Off”, press **Power** to access the settings. In the setting interface, pick a range between 0 to 60 minutes. The default auto-off time is 5 minutes, with 0 indicating no auto-off. Use the “+” or “-” keys to adjust the auto-off time to your preference. Press “Save” to exit to the “Display Setting” menu, then through “Back” and “Exit” to return to the main interface.

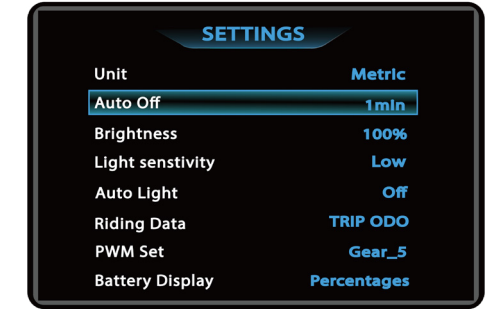

AUTO ON/OFF

**! NOTICE:** Any operation will reset the internal timer, the bike will only shut down automatically when the preset time is reached.

# Operation Guide

## 1. Speedometer & Control

### c. Function Summary

#### Backlight Brightness Settings

Go to the "Display Setting" menu, use the "+" or "-" button to move the cursor up or down. Select "Brightness", and press **Power** to enter the settings. Move the cursor to select the desired brightness level: "10%", "30%", "50%", "75%", or "100%". Press **Power** to save and exit to "Brightness", then exit to the main interface by selecting "Back" and then "Exit".

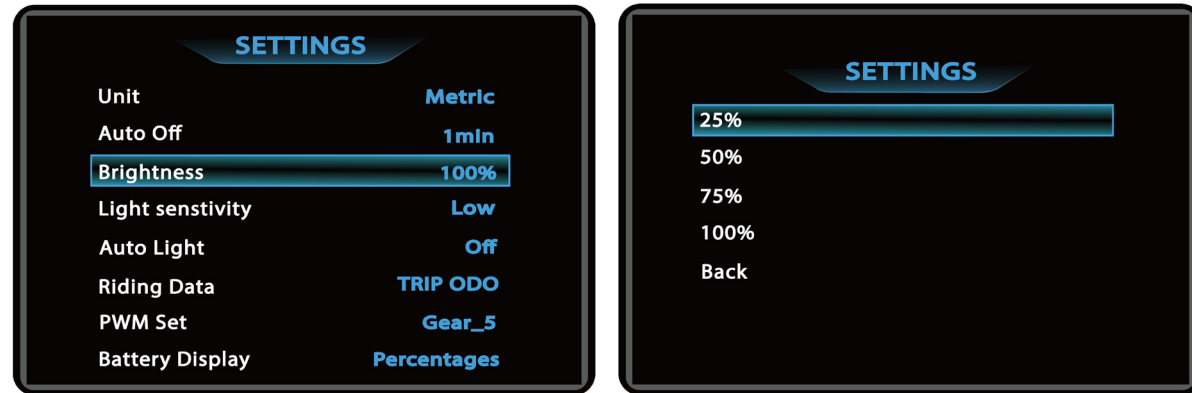

# Operation Guide

## 1. Speedometer & Control

### c. Function Summary

#### Light Sensitive - Light Sensitivity

Go to the "Display Setting" menu, use the "+" button or the "-" button to move the cursor up or down, select "Light Sensitivity", press **Power** to enter the settings, and move the cursor after entering the settings and select "Off"/"Low"/"Mid"/"High". Selecting "Off" will turn off the auto headlight feature. Press **Power** to save and exit to "Light Sensitivity", exit to the main interface via "Back" to "Exit".

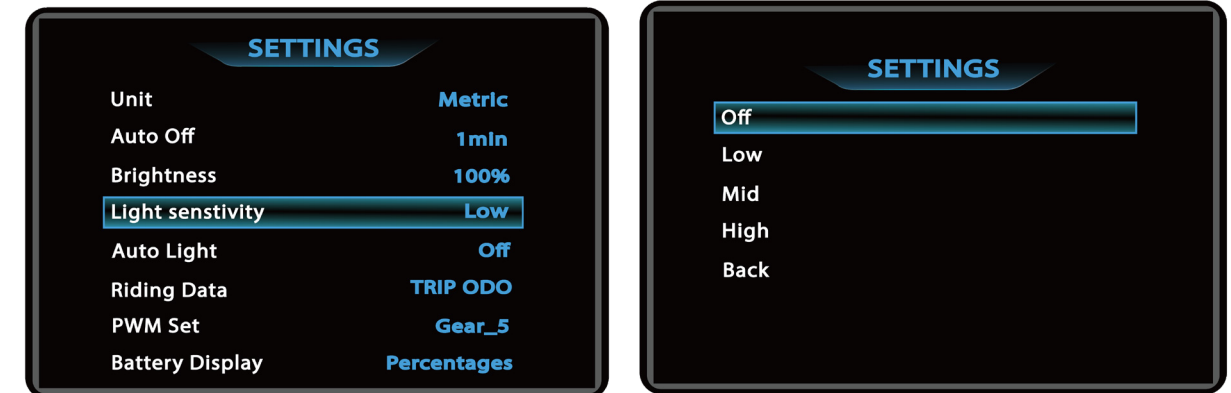

# Operation Guide

## 1. Speedometer & Control

### c. Function Summary

#### Auto - sensing headlight

Go to the “Display Setting” menu, use the “+” button or the “-” button to move the cursor up or down, select “Auto Light”, press **Power** to enter the settings, and move the cursor after entering the settings and select “Off”/“ON”. Selecting “Off” will turn off the auto headlight feature. Press **Power** to save and exit to “Auto - sensing headlight”, exit to the main interface via “Back” to “Exit”.

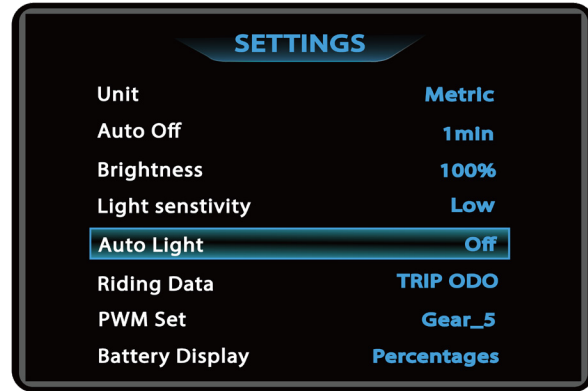

# Operation Guide

## 1. Speedometer & Control

### c. Function Summary

#### Riding Data Display

Go to the “Display Setting” menu, use the “+” button or the “-” button to move the cursor up or down, select “R”, press **Power** to enter the settings.

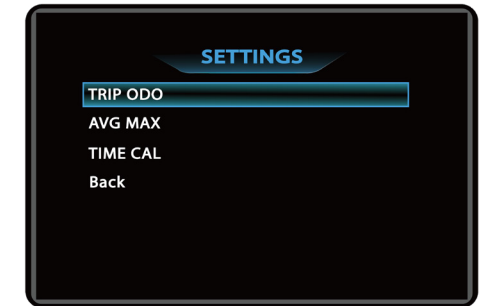
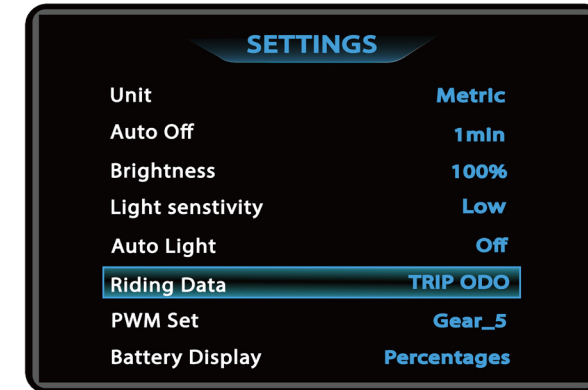

<b>TRIP ODO</b>	Current and total mileage
<b>AVG MAX</b>	Average and maximum speed
<b>TIME CAL</b>	Riding time and calories

# Operation Guide

## 1. Speedometer & Control

### c. Function Summary

#### Riding Data Display

Press **Power** to save and exit to "Riding Data Display", exit to the main interface via "Back" to "Exit".



# Operation Guide

## 1. Speedometer & Control

### c. Function Summary

#### Maximum gear setting (PMW value setting)

Go to the "Display Setting" menu, use the "+" button or the "-" button to move the cursor up or down, select "PWM Set", press **Power** to enter the settings.

The PWM value adjustment primarily facilitates the gear staging function, where a higher value corresponds to a higher maximum gear setting. By default, it's set to **Gear\_5**. Press **Power** to save changes and return to the previous menu.

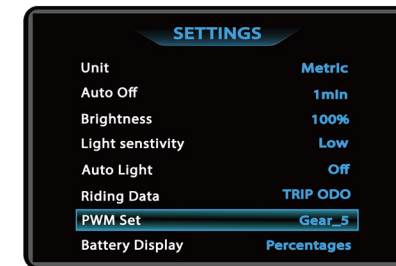

<b>Gear_3</b>	PMW setting for P gear and 1-3 gear mode
<b>Gear_5</b>	PMW setting for P gear and 1-5 gear mode
<b>Gear_9</b>	PMW setting for P gear and 1-9 gear mode

# Operation Guide

## 1. Speedometer & Control

### c. Function Summary

#### Battery Level

Go to the “Display Setting” menu, use the “+” button or the “-” button to move the cursor up or down, select “Battery Level”, press **Power** to enter the settings, and move the cursor after entering the settings and select “Percentage/voltage”. Press **Power** to save and exit to “Battery Level”, exit to the main interface via “Back” to “Exit”.

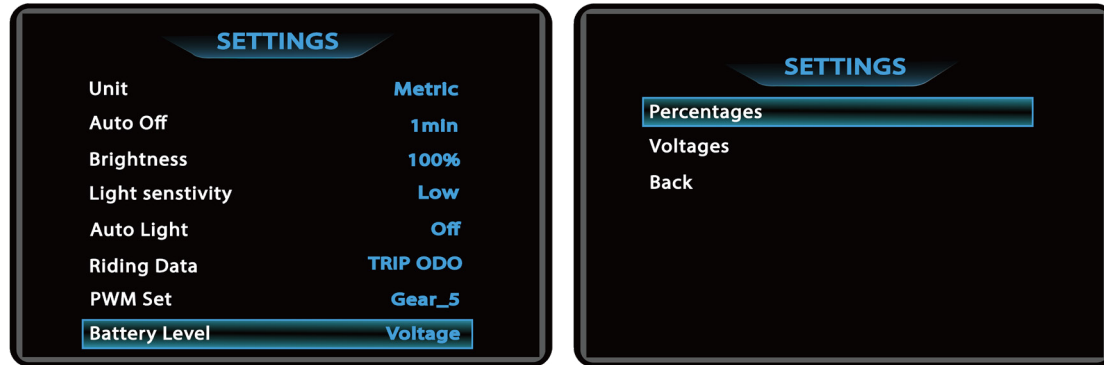

# Operation Guide

## 1. Speedometer & Control

### c. Function Summary

#### Version

Go to the “Display Setting” menu, use the “+” button or the “-” button to move the cursor up or down, select “PWM Set”, press **Power** to enter the settings.

Press **Power** to save and exit to “Riding Data Display”, exit to the main interface via “Back” to “Exit”.

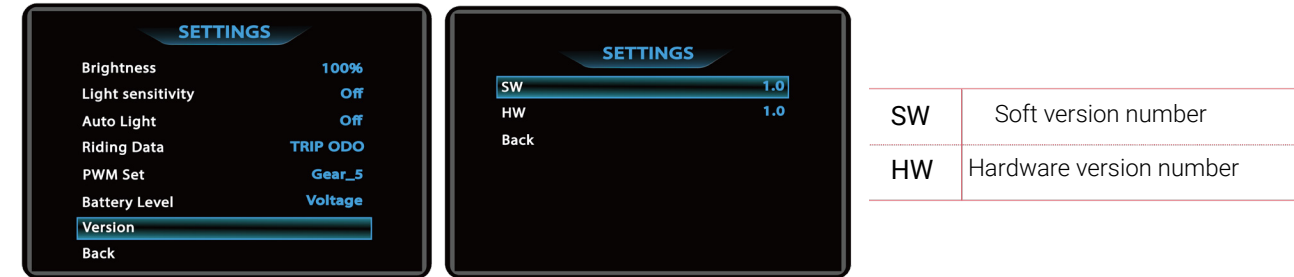

# Operation Guide

## 1. Speedometer & Control

### c. Function Summary

#### Demo Mode

Go to the “Display Setting” menu, use the “+” button or the “-” button to move the cursor up or down, select “Demo Mode”, press **Power** to enter the settings. Press **Power** to save and exit to “Demo Mode”, exit to the main interface via “Back” to “Exit”.

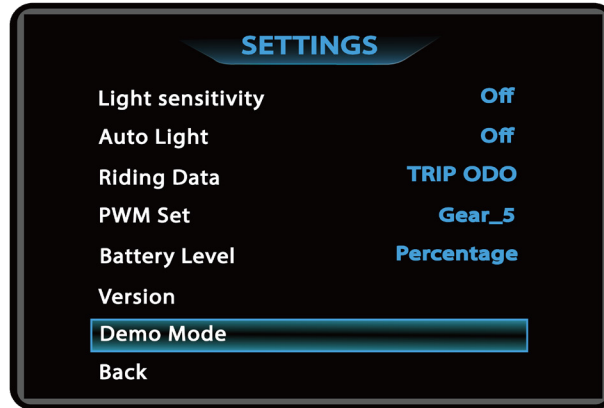

# Operation Guide

## 1. Speedometer & Control

### c. Function Summary

#### Language Selection

Go to the “Display Setting” menu, use the “+” button or the “-” button to move the cursor up or down, select “Language Selection”, press **Power** to enter the settings, and move the cursor after entering the settings and select “English/German/French/Spanish/Italian/Japanese/Chinese/Dutch”. Press **Power** to save and exit to “Language Selection”, exit to the main interface via “Back” to “Exit”.

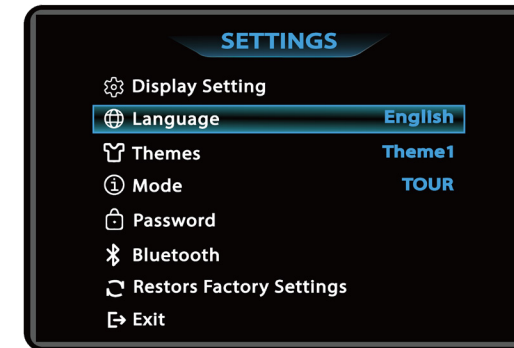

# Operation Guide

## 1. Speedometer & Control

### c. Function Summary

#### Theme Selection

Go to the “Display Setting” menu, use the “+” button or the “-” button to move the cursor up or down, select “Theme Selection”, press **Power** to enter the settings, and move the cursor after entering the settings and select “Theme1/Theme2”. Press **Power** to save and exit to “Theme Selection”, exit to the main interface via “Back” to “Exit”.

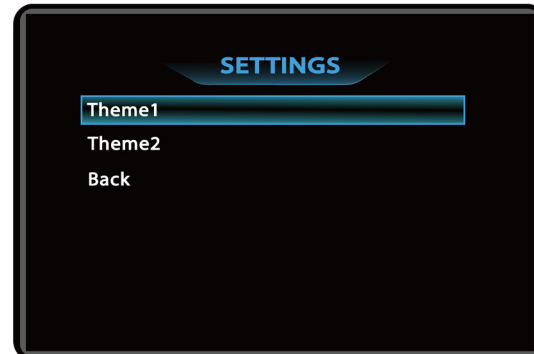
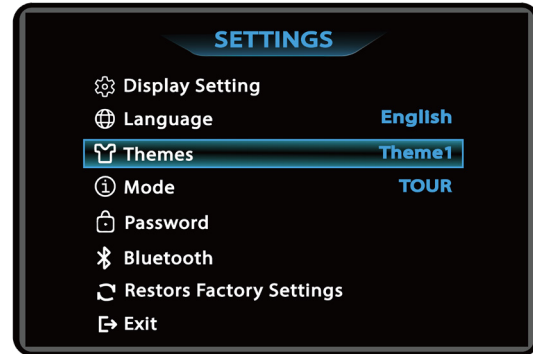

# Operation Guide

## 1. Speedometer & Control

### c. Function Summary

#### Mode Selection

Go to the “Display Setting” menu, use the “+” button or the “-” button to move the cursor up or down, select “Mode Selection”, press **Power** to enter the settings. Press **Power** to save changes and return to the previous menu.

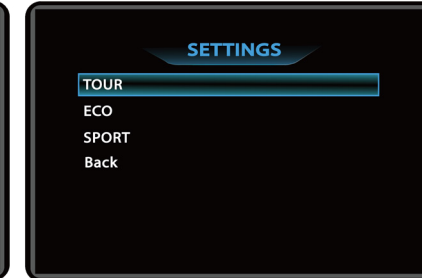
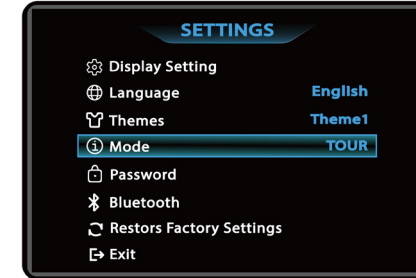

ECO	Energy - saving mode
SPORT	Sport mode
TOUR	Travel mode

# Operation Guide

## 1. Speedometer & Control

### c. Function Summary

#### Turn On the Password Function

Press the **Power** button to enter the setting information list, use the “+” button or the “-” button to move the cursor up and down, select the “Password” option and press “OK” to enter the Password options interface, select “Start Password” (Start Password status is off) and press **Power** to confirm, the interface prompts for the password, At this time, use the “+” button or the “-” button to toggle the number “0-9”. Press **Power** to confirm the number in the current cursor, and after entering it, the system prompts you to turn on the password function successfully.

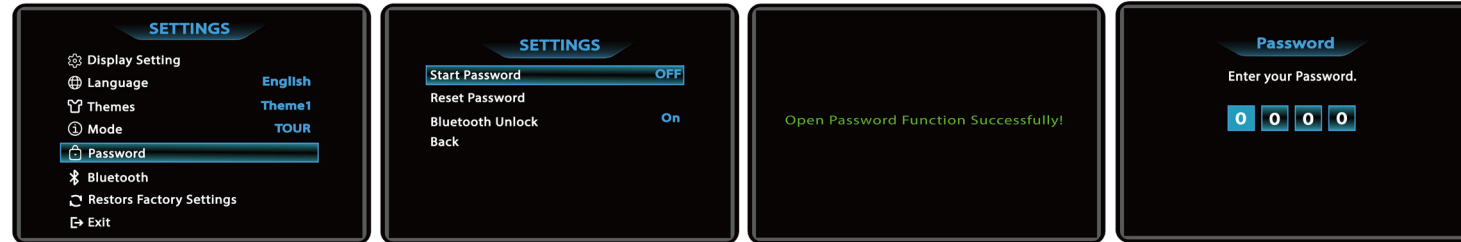

# Operation Guide

## 1. Speedometer & Control

### c. Function Summary

#### Turn Off the Password Function

Press the **Power** button to enter the setting information list, use the “+” button or the “-” button to move the cursor up and down, select the “Password” option and press “OK” to enter the Password options interface, select “Start Password” (Start Password status is on) and press **Power** to confirm, the interface prompts for the password, At this time, use the “+” button or the “-” button to toggle the number “0-9”. Press **Power** to confirm the number in the current cursor, and after entering it, the system prompts you to turn off the password function successfully.



# Operation Guide

## 1. Speedometer & Control

### c. Function Summary

#### Set and Modify Password (The initial password is 0000)

Press the **Power** button to enter the setting information list, use the “+” button or the “-” button to move the cursor up and down, check the “Password” option and press “OK” to enter the Password Options interface, move cursor to “Reset Password” and press **Power** to confirm.

- The interface prompts “Please enter your old password”, use the “+” button or the “-” button to toggle the number “0-9” and press **Power** to toggle digits.

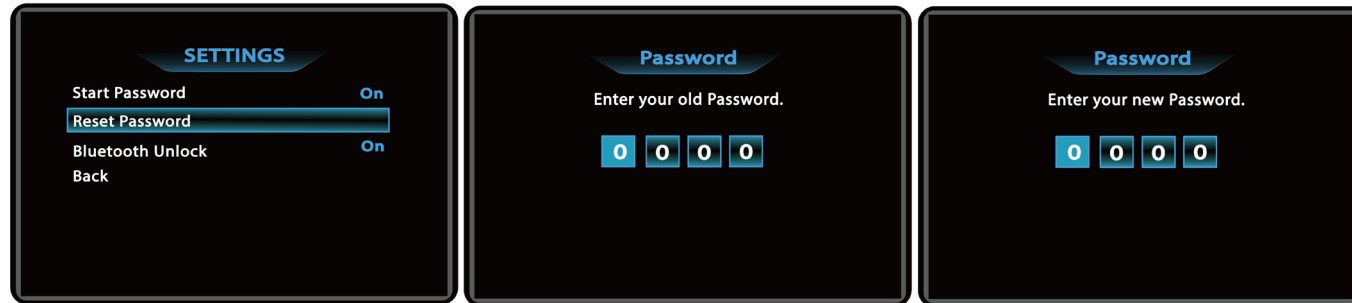

# Operation Guide

## 1. Speedometer & Control

### c. Function Summary

- After the old password is entered, the interface will prompt “Please enter your password”, use the “+” button, the “-” button or the **Power** button to enter a new password.
- After the interface prompts “Please confirm your password”. Enter your new password one more time using the 3 function buttons.

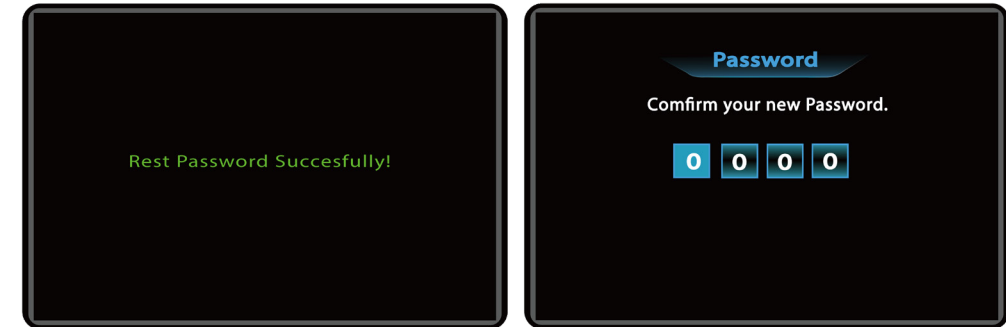

**! NOTICE:** After the initial password is modified, if you want to enable the instrument password function, you need to enter the new password to enable it.

# Operation Guide

## 1. Speedometer & Control

### c. Function Summary

#### Bluetooth Lock Settings (Bluetooth Unlock Is On by Default)

Press the **Power** button to enter the setting information list, use the “+” button or the “-” button to move the cursor up and down, and press “OK” after checking the “Password” option, enter the Password options interface, select “Bluetooth Unlock” press **Power** to enter the settings, press the “+” button or “-” button after entering the settings to select “On” or “Off” (“On” means to turn on the Bluetooth lock, “Off” means to turn off the Bluetooth lock), press “Save” to select and exit.



**! NOTICE:** To enable Bluetooth lock, activate the password function and set the Bluetooth lock to 'On'.

# Operation Guide

## 1. Speedometer & Control

### d. Bluetooth APP

#### Download the APP

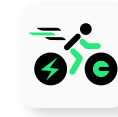

**HICYCLE**

#### IOS Devices

Search "HICYCLE" and install on your mobile device.



#### Android Devices

Scan the QR code below, download it on your mobile device.



To download the **HICYCLE** APP on your mobile device, access either the App Store or scan the QR Code above to download the package, depending on your device's operating system. In App Store, search for "HICYCLE," then click "Download" or "Get" and follow the prompts.

**! NOTICE:** Emmo not liable for in-app purchases.

# Operation Guide

## 1. Speedometer & Control

### d. Bluetooth APP

#### Bluetooth Connection

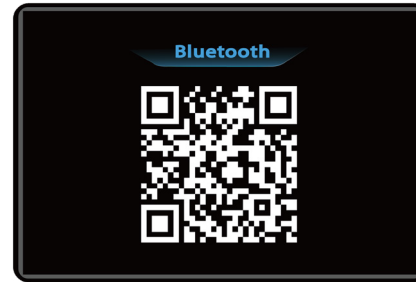
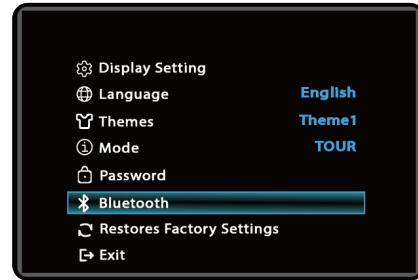

- Tab the **Power** key to enter the setting information list, use the **“+”** key or the **“-”** key to move the cursor up and down, select the “Bluetooth” option, and tab **“OK”** to enter the Bluetooth QR code interface.
- Open the **HICYCLE APP**, click on “Scan” to add your e-bike and scan the QR code on the speedometer of the ebike to connect to your E-Bike. Enter pair password **“880000”**.

# Operation Guide

## 1. Speedometer & Control

### d. Bluetooth APP

#### Bluetooth Connection

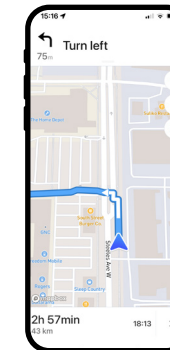
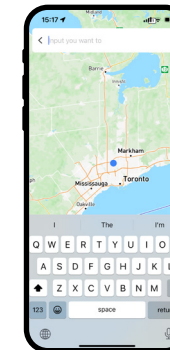
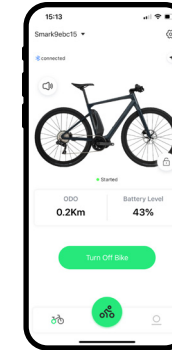
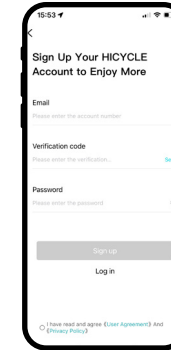

- To create an account, you will need to provide personal information including your name, and email address. Once you have created an account, you can log in and start using the app.
- After entering the main interface, start navigation by pressing **‘go,’** enter your destination, and you can start your journey.

# Operation Guide

## 1. Speedometer & Control

### d. Bluetooth APP

#### Unbind Bluetooth and Connect to New Device

- When the display is **ready** to pair, the **Bluetooth icon** will appear **grey**.
- If the Bluetooth icon is **lit**, the display is **already connected to another device**. To disconnect and pair with **a new device**, follow the steps on the next page.

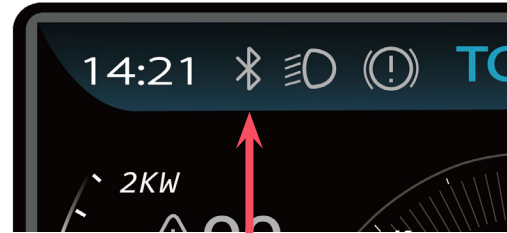

READY TO PAIR

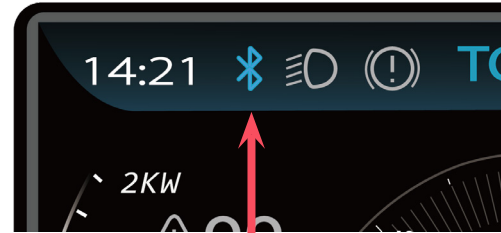

HAS CONNECTED TO ANOTHER DEVICE

# Operation Guide

## 1. Speedometer & Control

### d. Bluetooth APP

#### Unbind Bluetooth and Connect to New Device

To disconnect the current device and connect to a new device:

1. Open the **Hicycle** app on the **current phone**, tap settings icon, click **"Unbind"** button and confirm by clicking **"Done"**.

(Continued on next page)

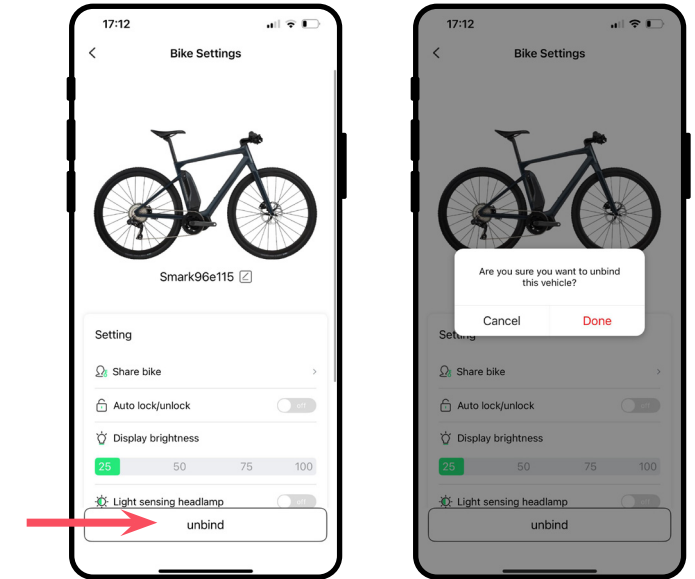

# Operation Guide

## 1. Speedometer & Control

### d. Bluetooth APP

#### Unbind Bluetooth and Connect to New Device

2. Go to the phone's Bluetooth settings and **forgot** the device named "Smark\_xxx."

3. The display is now ready to pair with a new device. For pairing instructions, refer to **pages 45–47** of this manual.

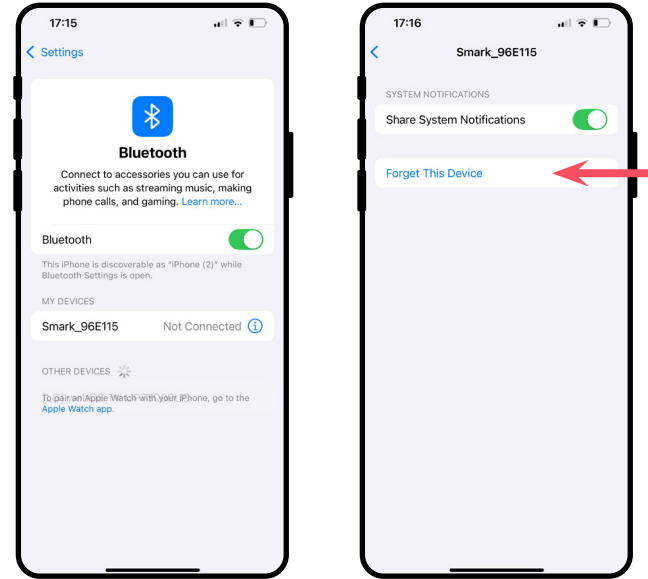

# Operation Guide

## 1. Speedometer & Control

### e. Error Code

When something goes wrong with the system, an error code will flash on the display. Check the details on the attached list. The motor will stop working in the event of an error. Only when the error is gone, will the motor work again.

Error Code	Error Description	Error Code	Error Description
03	Brakes applied	13	Temperature failure inside the battery
04	The throttle is not hosted	14	The temperature inside the controller is too high
05	Throttle failure	15	Controller internal temperature sensor failure
06	Low-voltage protection	21	Speed sensor failure
07	Over-voltage protection	22	BMS communication failure
08	Motor Hall signal line failure	23	Headlight failure
09	Motor phase line failure	24	Headlight sensor failure
10	The temperature inside the motor is too high	25	Torque sensor torque signal failure
11	Motor temperature sensor failure	26	Torque sensor speed signal failure
12	Current sensor failure	27	Overcurrent

# Operation Guide

## 1. Speedometer & Control

### e. Error Code

Error Code	Error Description	Error Code	Error Description
30	Communication failure	45	Battery temperature too high
33	Brake signal anomaly	46	Battery temperature too low
35	15V detection circuit anomaly	47	Battery state of charge (SOC) too high
36	Keyboard detection circuit anomaly	48	Battery state of charge (SOC) too low
37	Watchdog timer (WDT) circuit failure	61	Switch detection defect
38	Sensor WDT circuit failure	62	Electronic derailleur cannot be released
41	Battery total voltage too high	71	Electronic lock jammed
42	Battery total voltage too low	81	Bluetooth module error
43	Battery cell total power too high	A0	Controller fault
44	Single cell voltage too high	A1	Assist sensor fault

# Operation Guide

## 1. Speedometer & Control

### f. Restore

#### Reset Factory Settings

Go to the "Display Setting" menu, use the "+" button or the "-" button to move the cursor up or down, select "Reset Factory Settings", press **Power** to enter the settings, and move the cursor after entering the settings and select "Comfirm/Cancel". By selecting **Comfirm** - Restore to factory settings automatically. By selecting **Cancel** - Pause this process, maintaining the current factory settings, redirecting back to the "Settings" page

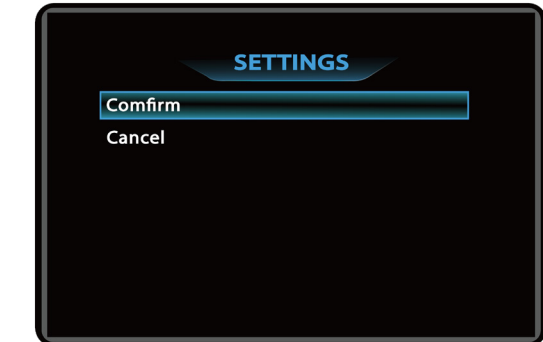
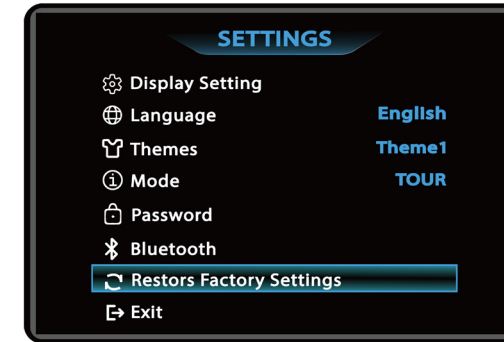

# Operation Guide

## 1. Speedometer & Control

### g. OTA

#### OTA Upgrade

Upon powering on the instrument and connecting to the mobile app, you'll receive an OTA upgrade notification. After confirming the upgrade, the instrument briefly goes dark before accessing the OTA upgrade interface. Upon successful completion of the upgrade, it seamlessly returns to the main interface. See the image below for the upgrade interface illustration.

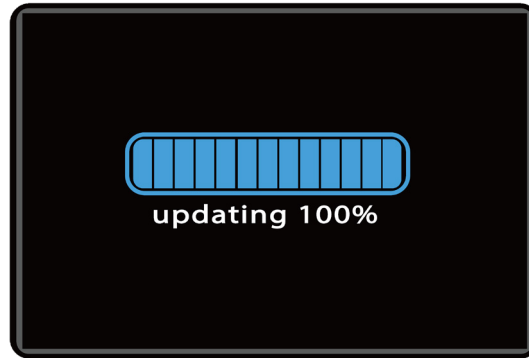

# Operation Guide

## 2. Adjusting the Seat Height

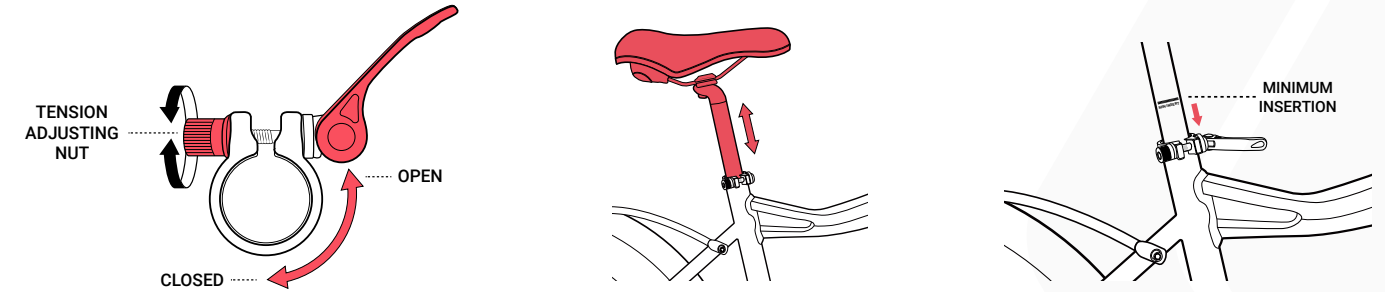

- Unlock the seat clamp, loosen the tension adjusting nut.
- Adjust the seat height to your preferred position and lock the clamp.
- Align the clamp opening with the notch in the seat tube and close the clamp lever fully.
- Closing the clamp should require enough pressure that it leaves an imprint in your hand.

**! WARNING:** There is a **MINIMUM INSERT** marker on the seat post. You must not raise the seat to a higher position than that. Raising the seat post higher will result in injury or damage to property/e-bike.

# Operation Guide

## 3. Adjusting the Saddle Position

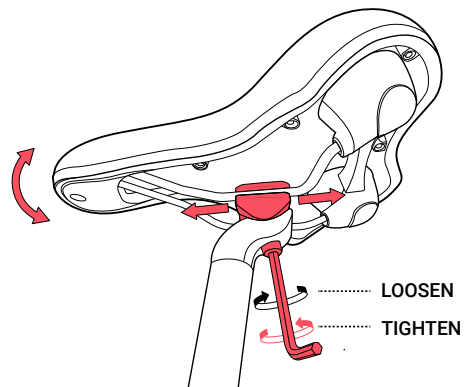

- Loosen the bolt at the bottom.
- Adjust the saddle tilt by pressing down on the front or rear of the saddle.
- Tighten the bolt to secure the saddle.

# Operation Guide

## 4. Battery

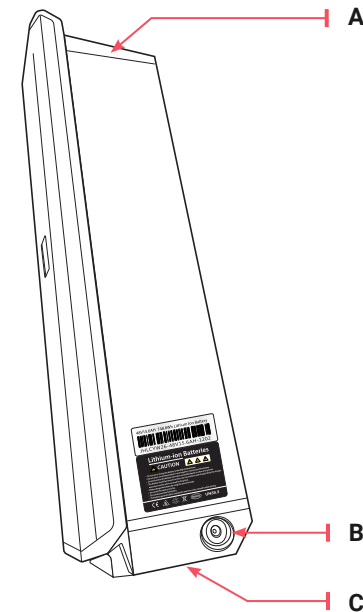

<b>A</b>	Battery Strength Indicator
<b>B</b>	Battery Charging Port
<b>C</b>	Discharging Port

# Operation Guide

## 4. Battery

### a. Charge Indicator

Hold the button to see the current battery level. The colors of the LED lights indicates the current battery level.

- **Green:** Battery full.
- **Yellow:** Battery normal.
- **Red:** Battery low or no battery.

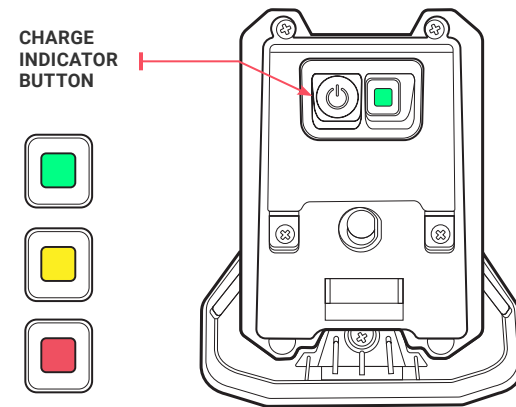

# Operation Guide

## 4. Battery

### b. Battery Charging Port

The charging port of the battery is located at the bottom, and you can find it by opening the rubber cover.

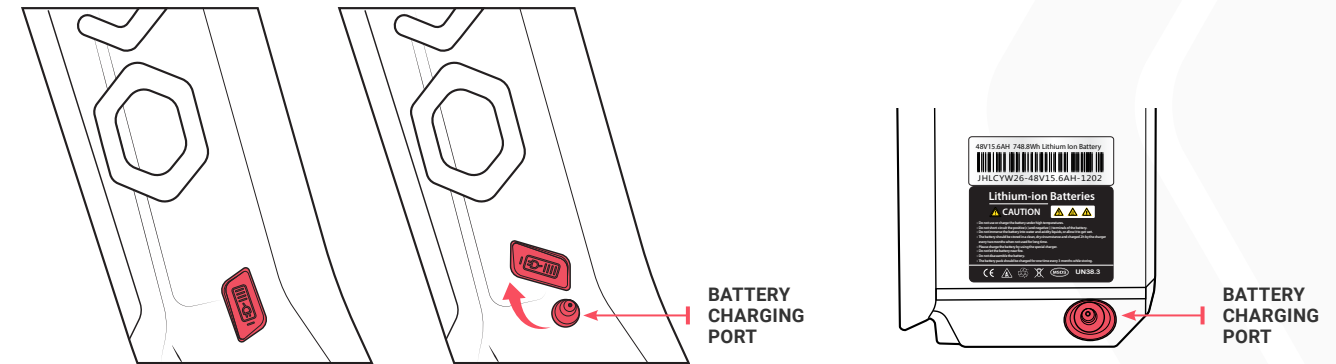

# Operation Guide

## 4. Battery

### c. Discharge port

The discharge port is connected to the bike.

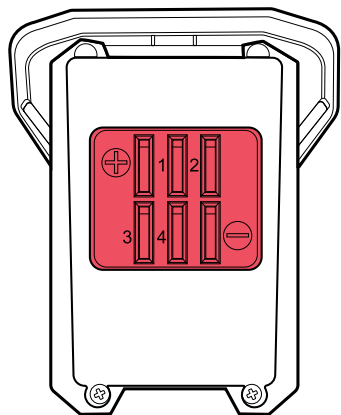

# Operation Guide

## 4. Battery

### d. Battery Lock

#### How to Remove the Battery

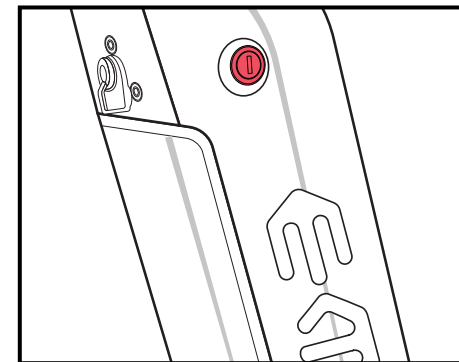

I. Insert the key into the battery lock. The lock is located on the left side of the bike frame.

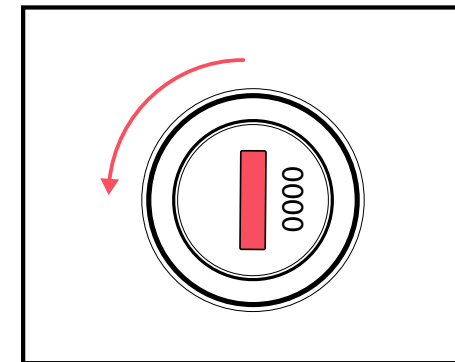

II. Turn the key anticlockwise.

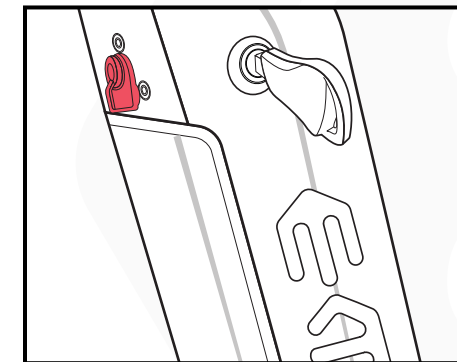

III. Located the battery release knob on the left side of the key lock.

# Operation Guide

## 4. Battery

### d. Battery Lock

#### How to Remove the Battery



**IV.** Turn the battery release knob to release the battery.

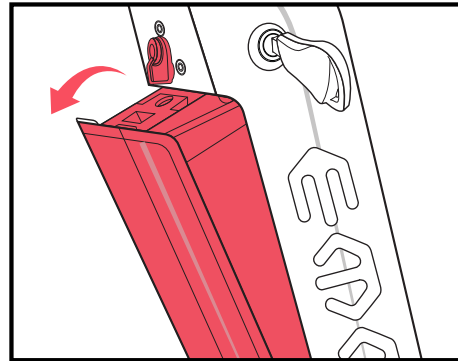

**V.** Pull the battery out to remove it.

# Operation Guide

## 4. Battery

### d. Battery Lock

#### How to Install the Battery

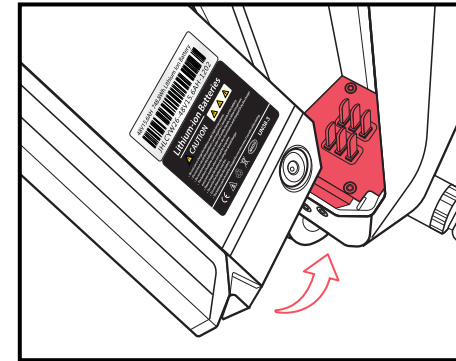

**I.** Insert the battery on the frame mount.

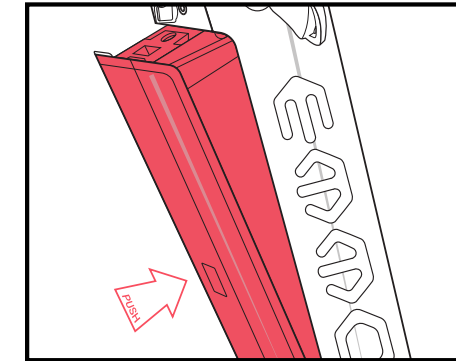

**II.** Push the battery into the battery lock until you hear a clicking sound.

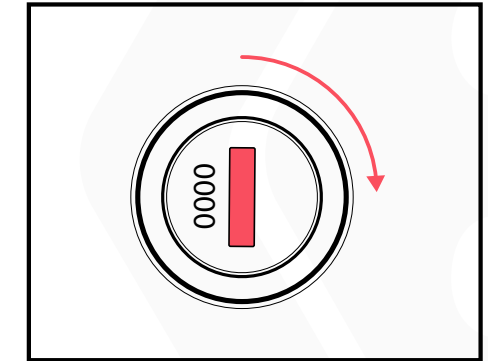

**III.** Turn the key clockwise to lock the battery lock.

# Operation Guide

## 4. Battery

### e. Battery Safety Precautions

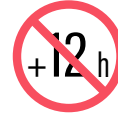

- Be sure to use the original/compatible battery (approved by EMMO). Using batteries from other brands may lead to severe accidents.
- Inspect the battery for any damage, leaking, overheating or smoking.
- Always charge between **0°C to 45°C**, charging outside of this range may cause permanent damage to battery.
- **DO NOT** lift the battery by its connectors or cables.
- **DO NOT** charge the battery for over 12 hours.
- **DO NOT** subject the battery to impact.
- **DO NOT** subject the battery to water.
- **DO NOT** subject the battery to heat or open fire.
- **DO NOT** open the battery pack by yourself. If you need any assistance, please contact your EMMO dealer.

[Refer to: Battery & Charger Safety for proper and safe use of battery & charger](#)

# Operation Guide

## 4. Battery

### f. Disposal



This product contains lithium batteries which must be disposed or recycled in an environmentally safe manner. Do not dispose of the batteries in your household trash. Do not dispose of the batteries in a fire, this could cause the batteries to leak or explode. The incineration, disposal in landfill and or placing lithium batteries with household trash is prohibited by law in most areas.

### ! NOTICE:

- Used batteries must be treated as hazardous waste.
- Batteries must be disposed of in accordance with the the regulations set forth by your local government/organizations.
- In case of uncertainty, please contact EMMO customer service department at [service@emmo.ca](mailto:service@emmo.ca)

# Operation Guide

## 4. Battery

### g. Storage & Maintenance

- For storage, please disconnect the battery from the bike and charge the battery on a regular basis (at least once a month).
- Battery packs and chargers need to be stored in a clean, dry, well ventilated place, avoid contact with corrosive material, and keep them away from heat and fire.
- Battery storage conditions:
  - Temperature: -20 to 35°C
  - Relative Humidity: ≤ 65%

# Operation Guide

## 5. Charger

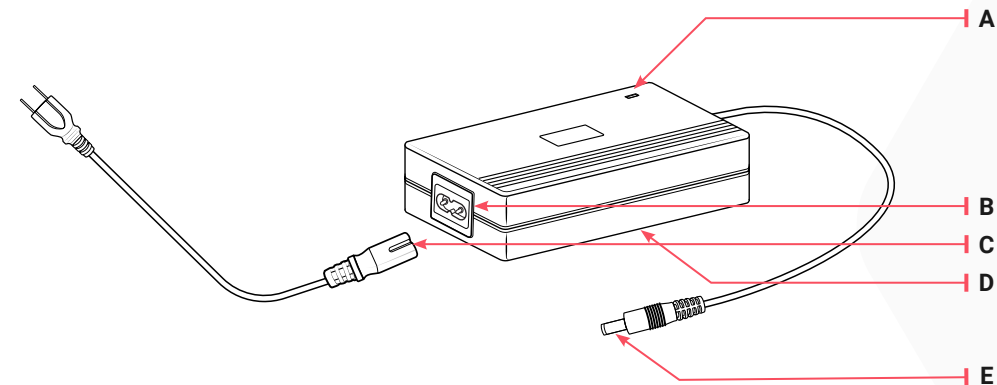

<b>A</b>	Charging Indicator
<b>B</b>	Power Cord Socket
<b>C</b>	Power Cord
<b>D</b>	Specification Label
<b>E</b>	Charging Plug

# Operation Guide

## 5. Charger

### a. Charging Indicator

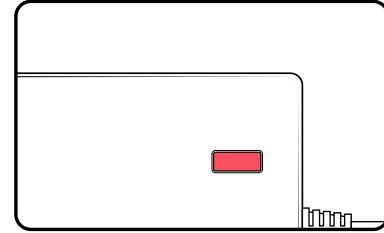
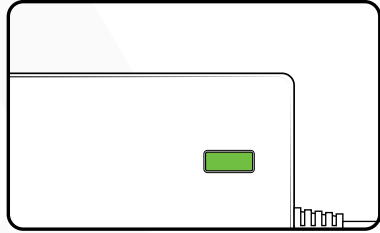

#### Charging Indicator Explanation:

- During charging, the indicator will turn red.
- The indicator will turn green when the battery is fully charged.

**! NOTICE:** If the charger gets warm during regular use, this is normal and is no cause for concern.

# Operation Guide

## 5. Charger

### b. Charger Specification Label

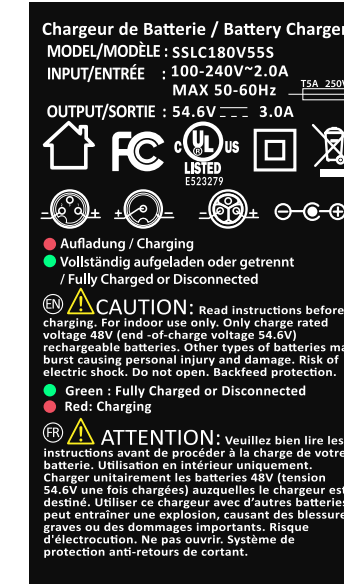

**! WARNING:** It is your responsibility to make sure that you are charging your e-bike with the correct charger. Contact your EMMO dealer if you have any questions or concerns.

# Operation Guide

## 5. Charger

c. Power Cord Socket

d. Power Cord

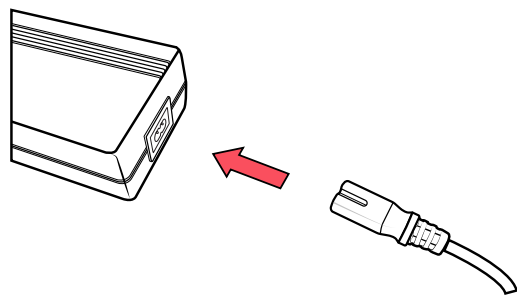

### Connecting the charger:

- Plug the power cord into the socket of the charger as shown.

**! WARNING: DO NOT** plug the power cord directly to the bike/battery. High voltage may damage the bike/battery and cause severe injury.

# Operation Guide

## 5. Charger

e. Charger Plug

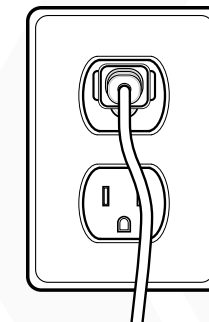
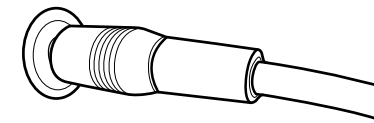

### How to charge:

- The charging port is located at the tail end of the battery. (Refer to ["Battery Charge Port "on Page 61."](#))
- Insert the charging plug into the charging port.
- Plug the charger into a regular 110V wall outlet.

# Operation Guide

## 5. Charger

### f. Charging Precautions



#### **WARNING: Battery & Charger Safety**

- The charger should only be used **indoors** in a cool, dry, ventilated area. Always position the charger on a **non-flammable surface** (e.g., concrete or brick), as it may generate heat during peak charging cycles.
- You must use a dedicated 110V outlet to charge your battery.
- Never cover the charger during charging or leave it unattended.
- Keep the battery and charger away from children, pets, water, and open flame.
- DO NOT submerge or allow the charger to be submerged in water or any liquid.
- **DO NOT** use the charger or battery if **any part of the cord, connector, or housing is frayed, cracked, exposed, or otherwise damaged**. Using damaged charging equipment or battery connectors can lead to malfunction, fire, or serious injury.
- Do NOT drop, strike, or expose them to shocks.
- Use only the charger supplied with the product or approved by EMMO.

- Disconnect promptly once fully charged. Do NOT charge for more than **12 hours**, whether the battery is full or not.
- If the battery is stored, check it at least **once a month**. If necessary, use the original charger to recharge the battery to about **75%**. Failure to perform regular checks or charging may result in malfunction or safety hazards.
- Disconnect immediately if there is a strange smell, smoke, or overheating.
- In the unlikely case of battery fire: **never use water**. Use sand to cover the fire and call emergency services.
- **Battery & Charger Rated Life Expectancy:** Lead-Acid Battery: 2 years (500 cycles); Lithium-Ion Battery: 4 years (1000 cycles); Charger: 4 years. All component lifespans assume normal use and proper maintenance. **Annual inspection & safety testing by an authorized technician are required to ensure safety**. Components that have exceeded their rated service life—or no longer provide expected performance—should be replaced to ensure safety and reliability. While proper care may extend usable life, this can NOT be guaranteed.

# Operation Guide

## 6. Gear Shifters

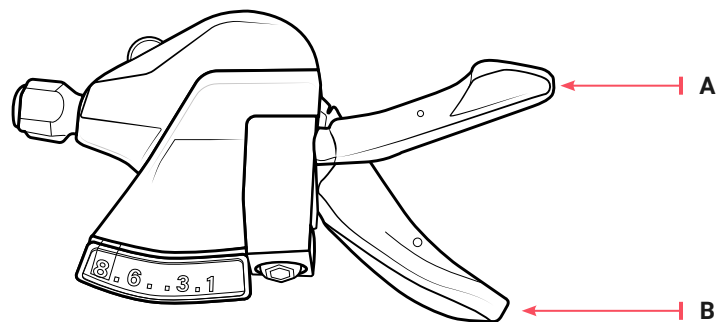

- |          |   |
|----------|---|
| <b>A</b> | Shift the upper lever to raise the higher gear. |
| <b>B</b> | Downshift the lower lever to lower the gear.    |

# Operation Guide

## 7. Throttle

Gently twist the throttle downwards to accelerate.

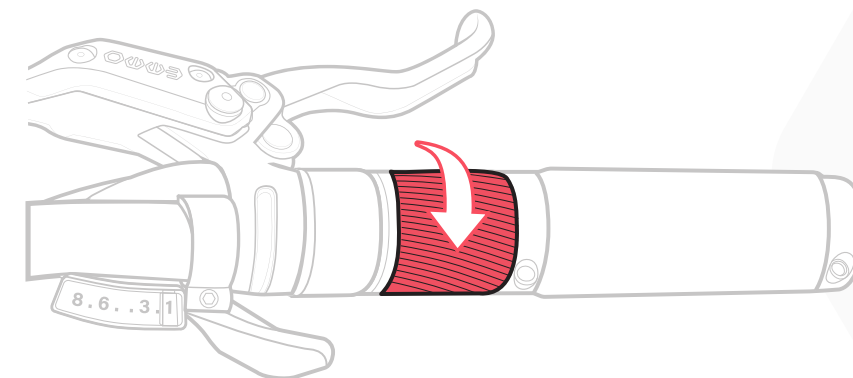

**! WARNING:** DO NOT twist the throttle if you are not ready to ride.

# Operation Guide

## 8. Adjusting the Suspension Fork

The suspension fork can move up and down to cushion bumps, which can make riding on a rough road or trail smoother and more comfortable.

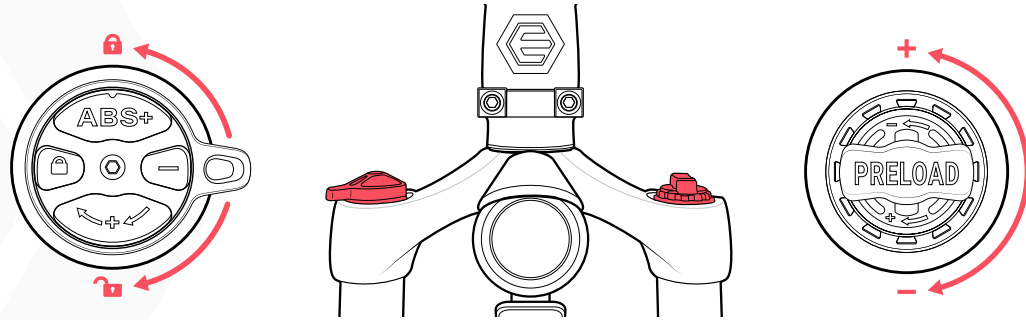

- **Locking the fork** creates a rigid fork, which can yield higher efficiency while pedaling and a more predictable ride depending on conditions such as terrain and cargo load.
- **Adjusting the preload** dial makes the fork softer, feel smoother, and more comfortable when riding on rough roads or on trails.

# Operation Guide

## 9. Adjusting the Quick-Release Stem

Quick-release adjustable stem allows riders to easily adjust the handlebar height and angle to suit their comfort and riding style without tools.

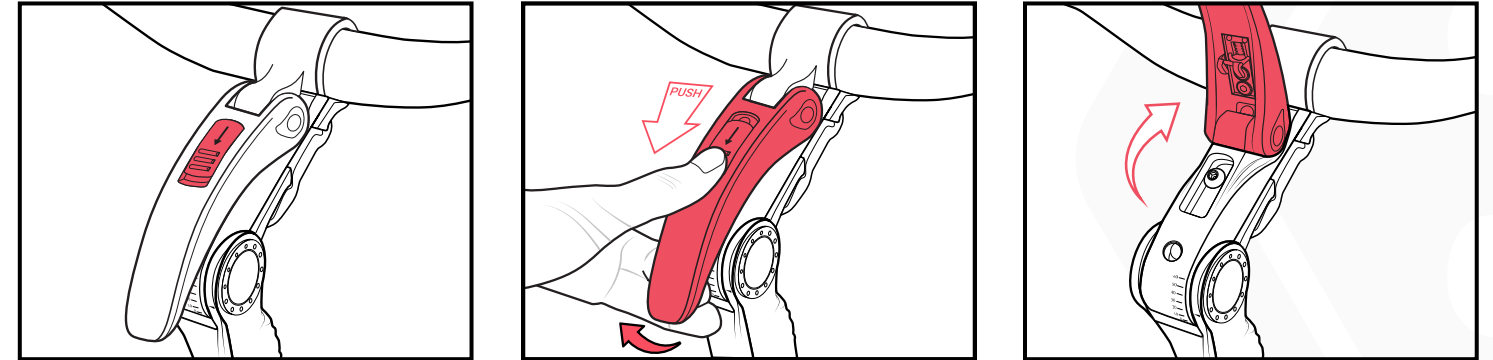

- I. Locate the quick-release lever at the stem's base near the steering tube.
- II. Press the safety button and flip the lever to unlock.
- III. When it sticks out perpendicular, it is unlocked.

# Operation Guide

## 9. Adjusting the Quick-Release Stem

Make sure the handlebars are aligned with your front wheel for safe steering.

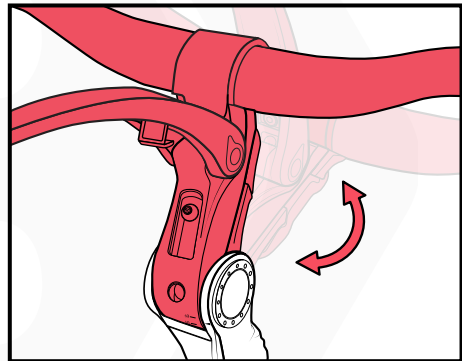

**IV.** Adjust the handlebar height within the stem's marked limits and tilt to a comfortable angle.

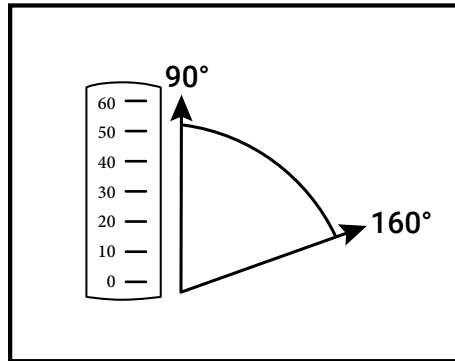

**V.** The adjustable angle range is 90°-160°.

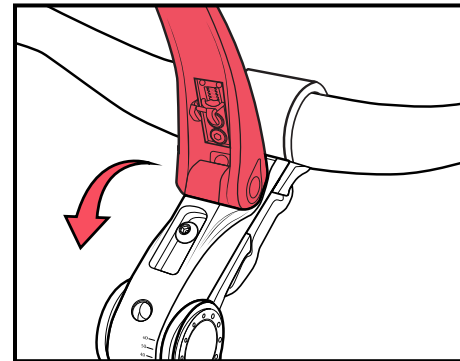

**VI.** Secure the adjustment by closing the lever until it locks flat.

# Operation Guide

## 10. Torque Sensor

The torque sensor enhances your riding experience by seamlessly matching motor output to your pedaling efforts, leading to a smoother and more intuitive ride.

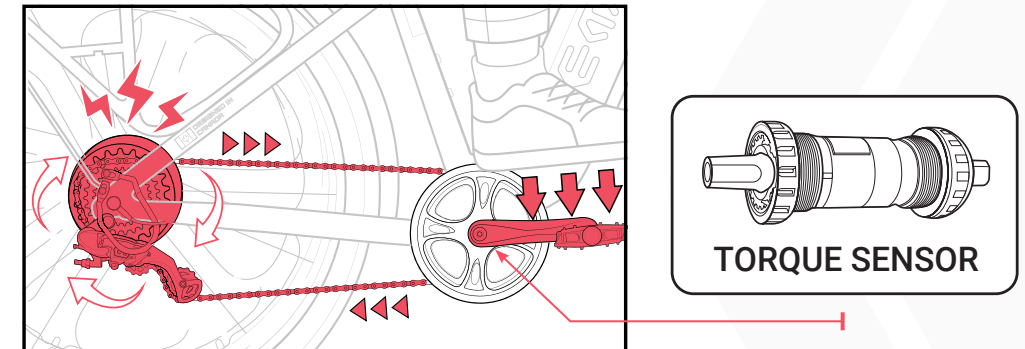

- **Efficient Battery Use** The bike only uses as much power as needed based on your pedaling force, extending the battery life per charge.
- **Improved Control** Provides better control over acceleration and helps maintain steadiness, making it ideal for climbing hills or navigating busy streets.

# Operation Guide

## 11. Cleaning / Lubricating the Chain

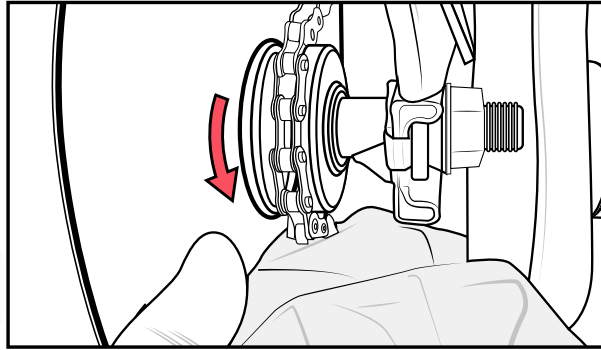

### How to Clean the Chain:

- Put the bike on a service stand or lean the bike on the kick/side stand. Make sure the rear wheel is off the ground.
- Locate the chain on the right side of the bike, near the rear wheel hub.
- Hold a clean cloth to the chain (as shown).
- Turn the pedal to clean the chain.
- Apply new bicycle chain oil to the sprocket and chain.

# Operation Guide

## 12. Tire Pressure

It is recommended to check the tire pressure on a regular basis to keep things at their best working conditions.

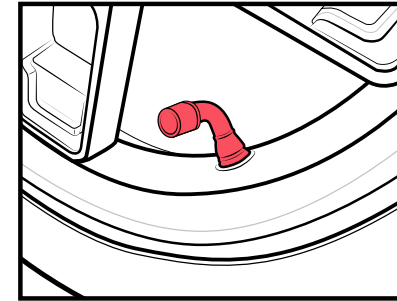

I. Locate the valve on the rim.

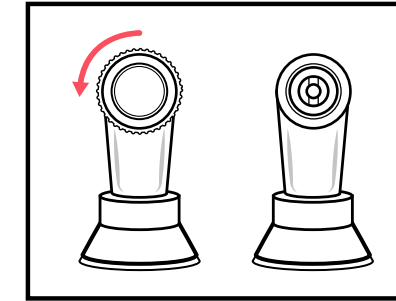

II. Remove the valve cap.

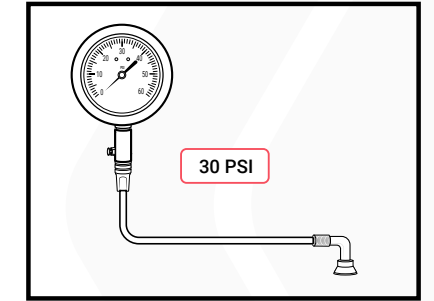

III. Use an air pump with gauge to adjust the tire pressure to 30 PSI.

### Tire pressure affects the following:

- Service life of the tires and other components of the bike.
- Ride safety.

# Operation Guide

## 12. Tire Pressure

- Ride comfort
- Travel distance



### WARNING:

- You **MUST** inflate the tire to the recommended tire pressure before the first ride. Failure to do so may damage your bike and void your warranty.
- **DO NOT** over-inflate, as this could damage the tire or wheel. (The recommended tire pressure range is marked on both tires by the manufacturers.)

# Operation Guide

## 13. Serial Number

### a. Frame Number

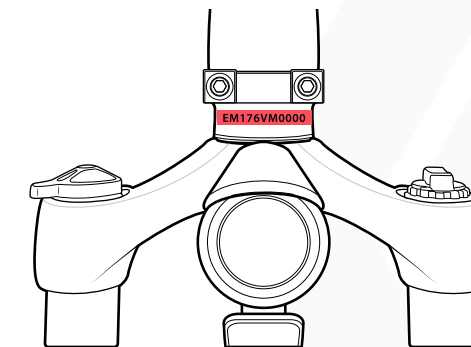
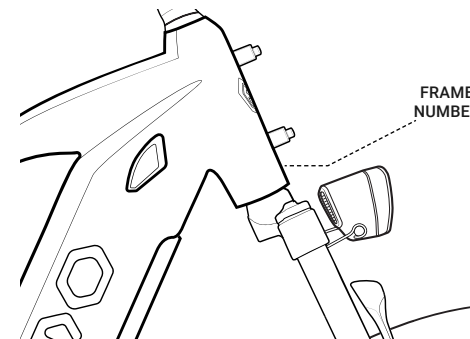

### Find the Frame Number:

- The frame number is engraved on the neck of the frame.

# Operation Guide

## 13. Serial Number

### b. Motor Number

Located on the motor.

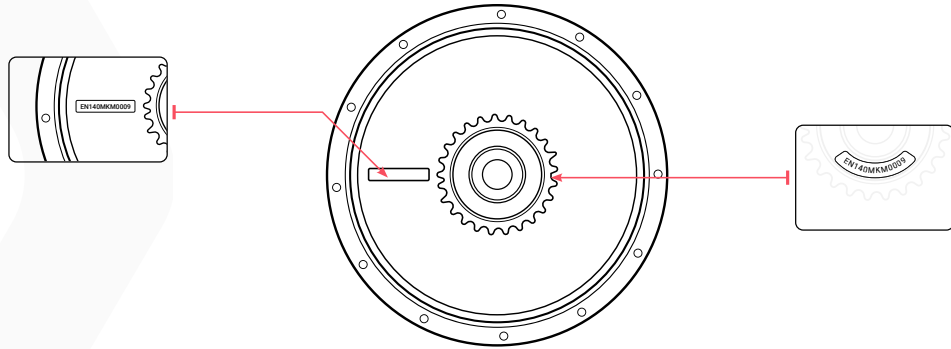

The motor number could be located at the following locations:

- **Location 1:** On the motor cover plate.
- **Location 2:** Behind the sprocket on the motor.

# Troubleshooting

Potential Issues/Errors	Most Common Way To Solve Issue
Battery not fully seated in tray	Install battery correctly
Insufficient battery power	Recharge/test the battery.
Faulty connections	Reinstall or test the battery/wiring.
Improper turn on sequence	Clean and reconnect connectors
Brakes are applied	Restart the ebike.
Electrical cable unplugged	Repair or replace
Walk mode stopped	Ensure nothing is keeping any button(s) other than the walk mode button pressed on the UI Remote (on some models)
Control button(s) held	Ensure nothing is keeping any button(s) pressed on the UI Control (on some models)
Battery non-functional	Replace battery
Damaged or disconnected pedal assist sensor	Replace or reconnect pedal assist sensor
Loose wiring	Repair and or reconnect
Loose or damaged throttle	Tighten or replace
Loose or damaged motor plug wire	Secure or replace motor plug wire
Damaged motor	Repair or replace

## Troubleshooting

Low or faulty battery	Check connection, charge or replace battery
Low tire pressure	Adjust tire pressure
Climbing too many hills, strong headwind, braking, and/or excessive load	Adjust your route or assist with pedals
Brakes rubbing	Adjust the brakes
Battery discharged for long period of time without regular charges, battery is aged, damaged, or unbalanced	If range decline persists; contact local dealer
Insufficient battery power	Charge or replace battery
Loose or damaged motor wiring	Reconnect or replace motor
Loose or damaged wheel spokes or rim	Tighten, repair, or replace
Battery damaged	Replace
Charger not well connected	Adjust the connections
Charger damaged	Replace
Wiring damaged	Repair or replace
Blown charger fuse	Replace charger fuse

**! NOTICE:** If you have any questions, please contact your local dealer.

## Recommended Torque Values

Area		Tool	Rec. torque
<b>Handlebar</b>	Stem clamp bolts	5 mm Allen	10 Nm
	Stem faceplate bolts	5 mm Allen	6 Nm
	Stem angle adjustment bolt (side)	5 mm Allen	12 Nm
	Stem angle adjustment bolt (bottom)	5 mm Allen	15 Nm
	Speedometer clamp bolts	3 mm Allen	3 Nm
	Remote clamp bolt	3 mm Allen	3 Nm
	Throttle clamp bolt	3 mm Allen	3 Nm
	Shifter clamp bolt	Phillips or flat head	6 Nm
	Brake lever clamp bolts	5 mm Allen	6 Nm
<b>Brake</b>	Caliper adapter to frame	5 mm Allen	6–8 Nm
	Caliper to adapter	5 mm Allen	6–8 Nm
	Brake pads to caliper	Cotter pin	n/a
	Brake rotor to hub	T25 Torx bit	7 Nm
<b>Seat</b>	Seat adjustment bolt	6 mm Allen	15 Nm

## Recommended Torque Values

<b>Frame Downtube</b>	Controller mounting bolts	6 mm Allen	3 Nm
	Frame cable cover bolts	2.5 mm Allen	tighten securely; do not overtighten
<b>Rear dropout</b>	Rear axle nuts	18 mm wrench	40 Nm
	Torque arm bolt	4 mm Allen	5 Nm
	Derailleur hanger mounting bolt	5 mm Allen	10 Nm
	Derailleur mounting bolt	5 mm Allen	10 Nm
	Derailleur cable clamp bolt	5 mm Allen	6-8 Nm
<b>Bottom bracket and crank</b>	Pedal into crank arm	15 mm pedal wrench	35 Nm
	Crank arm removal info	Crank puller for square taper bottom bracket	n/a
	Crank arm bolt into bottom bracket spindle	8 mm Allen	35 Nm
	Freewheel removal	Contact local dealer	n/a
	Chainring bolts	5 mm Allen	10 Nm
	Kickstand mounting bolts	5 mm Allen	8 Nm
	Bottom bracket and cups	BBT-22 Park Tool	60 Nm

## Tools and Torque Values

<b>Accessories</b>	Headlight/front fender mounting bolt	5 mm Allen and 10 mm wrench	6 Nm
	Fender mounting bolts (except at headlight)	4 mm Allen	6 Nm
	Replaceable rear rack mounting bolts	5 mm Allen	6 Nm

# Riding Guide

## 1. Checking List Before Riding

- Whether the handlebar is stable and turns smoothly when turning.
- Whether the right and left switches on the handlebar works properly or not.
- Whether the throttle works properly or not.
- Make sure the tires are inflated to the recommended tire pressure (30 PSI).
- Check tire surface, make sure there are no cracks, damages, and foreign matter punctures or stuck on.
- Check whether the tread depth is enough. For your safety, tires should be replaced when the tread depth is below the recommended value by the manufacturer.
- Whether any error warning lights are on the speedometer.
- Whether the battery capacity is enough for your trip.
- Whether all lights are working properly.
- Whether the horn is working properly.
- Whether the mirrors are clean and adjusted to the appropriate angle.
- Whether the brake lever and brake system is working properly.

# Warranty Policy

**By purchasing any Emmo Inc products or other brand items sold by Emmo Inc, the customer agrees to the policies and procedures outlined below.**

Terms and conditions apply for eligibility of warranty. Please refer to [Terms and Conditions](#).

Any warranty is extended to the original owner with the original purchase paperwork. This portion does not cover the purchase of parts or the purchase of products sold by Emmo Inc that is not an electric bike, electric scooter ebike, electric motorcycle style ebike, electric mobility scooter, kick-style electric scooter, or ride-on toy.

## Electric Bicycle

Emmo dealers may charge an assembly fee to assemble the ebike.

- **Comprehensive Warranty (up to 4000km)** There is a Two Year warranty (up to 4000km) for the frame, and motor. One year repair or part replacement is extended to the original owner on controller and other applicable components against manufacturer's defect in workmanship and materials on the e-bikes.
- **Manufacturer's comprehensive warranty does not cover such parts including, but not limited to:** seats, plastic housings and shrouds, pitting, scratches and chips, brake pads, tires, tubes, or damage due to lack of maintenance, accident, misuse or abuse. Damage incurred from water, road salt and other foreign debris or chemicals are not covered by the comprehensive warranty. The labour of any warranty repair will be covered by the original store that the bike was purchased from only when it is being repaired at said store. The parts will be covered by Emmo Inc. You are responsible for providing original purchase paperwork and shipping the item to and from the store.

- Twelve Month Warranty (up to 4000km) 12 Month warranty on original Batteries and Chargers provided that they have been maintained as instructed by your vehicle hand-book and not subjected to freezing temperatures. For Lithium models, the chargers must match the lithium batteries. Emmo is not responsible for any damage resulting from using another brand or voltage of charger. The customer is responsible for providing original purchase paperwork and shipping the item to and from the store.
- If you are not able to bring the ebike to the location you purchased from, you may be required to ship the item and a copy of your purchase paperwork to Emmo Inc before receiving a replacement item. You are responsible for shipping to Emmo Inc. Once the warranty claim is approved, Emmo Inc will arrange the shipping for the replacement parts and cover the return shipping to you unless expressed otherwise by Emmo Inc. Labour will not be covered by Emmo Inc.
- Certain conditions that may limit or completely void the warranty of your e-bike are: altering the ebike from its original design or its intended use, eg: pulling a trailer, as a delivery vehicle or any commercial use.

### Purchased Parts

Please consult your Emmo dealer for more details of the parts policies.

- **Shipping Damage:** Emmo Inc will not be held responsible for any lost, stolen, or damaged items due to any delivery services or courier actions. Report any damage to Emmo Inc within 7 days of receiving the part with pictures for any shipping damage and proof of purchase. Please note the damage on the shipper's proof of Delivery prior to signing off on the shipment. Shipping damage is not covered by Emmo Inc if you choose your own shipping method or freight forwarder. The cost of shipping will not be covered under warranty unless Emmo Inc agrees in writing to cover the shipping cost.
- **Repair and Store Purchases of Emmo Inc Products:** Any warranty is extended to the original owner with

- the original purchase paperwork. Any return or exchange within 7 days must be in new, unused, and original packaging. The customer is responsible for notifying Emmo Inc of the return or exchange and the cost of shipping will not be covered under warranty unless Emmo Inc agrees in writing to cover the shipping cost. On all return and exchange items, a restocking fee of 20% will be withheld from the refund amount unless Emmo Inc has agreed to another arrangement in writing. The cost of the item minus the restocking fee will be refunded once the product is returned and determined to be returnable. Restocking fees are 20% of MSRP not including Taxes, Freight/Shipping or PDI. Items out of original packaging will not be accepted.
- **Part Warranty Policy:** All items with warranty must have a valid warranty sticker. For Lithium models, the chargers must match the lithium batteries. Emmo is not responsible for any damage resulting in using another brand or voltage of charger or using an Emmo item with items that are not sold by Emmo Inc. Within 7 days, any items defective by manufacturer quality and are under warranty can be replaced. After 7 days, any items defective in manufacturer quality and are under warranty can be repaired. Warranty does not cover damage due to lack of maintenance, accident, misuse or abuse. Damage incurred from water, road salt and other foreign debris or chemicals. The labour of any warranty repair will be covered by the original store that the Emmo Inc part was purchased from only when it is being repaired at said store. For repairs that are done on items that are not from Emmo Inc, only a 7-day Parts Warranty will be included.
- If the part was paid by financing, you are responsible for any cancellation fees or penalties charged by the third party financing company unless Emmo Inc has agreed to cover the fees in writing. The financing loan agreement will only be cancelled after Emmo Inc has received and approved the returned item.
- For repairs that are done on items that are not from Emmo Inc, only a 7-day Parts Warranty will be included. Emmo Inc is not responsible for items modified from its intended use or purpose resulting in damage to the ebike or injury to the customer or third party.

 **NOTICE:** If you have any questions, please contact your local dealer.

## Leave Us a Review

By sharing your experience with EMMO, you can extend your warranty for an extra **3 months for FREE**.

Your review will help us to continue providing great products and services, and help others understand how EMMO can make their life greener.

Thank you for choosing EMMO.



**GET 3-MONTH  
EXTENDED WARRANTY  
FOR FREE**

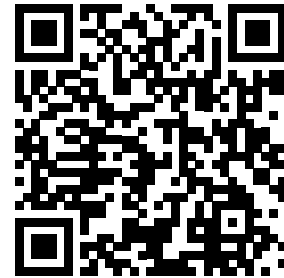

Scan the QR code to  
leave us a review.

## Contact Us

### LOCATION

#### **EMMO Mississauga**

1224 Dundas St E, Unit 6  
Mississauga, ON L4Y 2C5  
Canada

#### **EMMO Vaughan**

1750 Steeles Avenue West, Unit 15-17  
Concord, ON L4K 1S6  
Canada

### Contact

Toll Free: +1-888-217-1217

Email: [service@emmo.ca](mailto:service@emmo.ca)

#### **EMMO Toronto**

438 Spadina Ave, Unit 2  
Toronto, ON M5T 2G8  
Canada

#### **Toronto Service Center**

438 Spadina Ave, Unit 5-6  
Toronto, ON M5T 2G8  
Canada

### Website

[www.emmo.ca](http://www.emmo.ca)

[www.emmo.ca/pages/contactus](http://www.emmo.ca/pages/contactus)





[WWW.EMMO.CA](http://WWW.EMMO.CA)