

Inline - Skateboard - bmx

Manufactured from high-quality and highly resistant materials, no compromise is made, ensuring long-lasting, safe use.

Our skate surfaces are 10mm GRP (Glass Reinforced Plastic) boards available in grey as standard. GRP offers a double noise protection layer and vibration absorber.

Hot-dip galvanized steel tube construction. The equipment is designed and manufactured in a modular system allowing for easy modification and expansion.

Taking into consideration that not all surfaces are level, adjustable height supports enabling easier and stable installation are incorporated in the design.

Fibre glass side skirts are designed for safety and act as a barrier for waste. Available in different colours allowing for many design possibilities

Approaching plates are high-grade pre formed, stainless steel built to withstand and to allow a smooth transition onto the equipment, pipes, funboxes etc.

360° steel tube edge protection for riding surfaces means that all riding surfaces



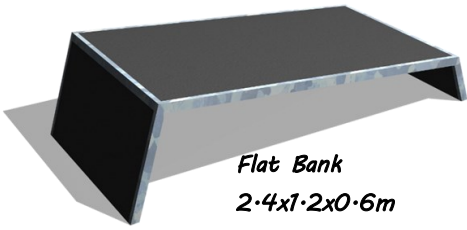

Flat Bank
2.4x1.2x0.6m

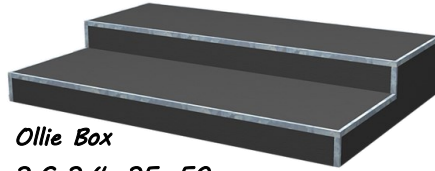

Ollie Box
3.6x2.4x.25x.50m

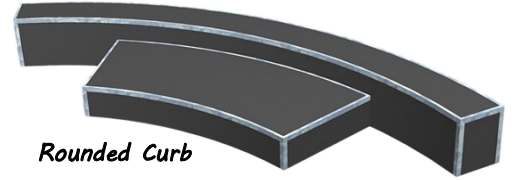

Rounded Curb
5.8x1.8.35x.60

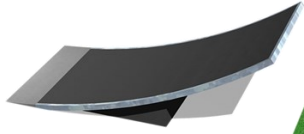

Kicker
2.4x1.2x.90

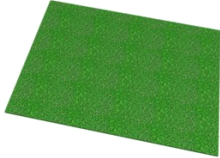

Rail A
4.8x0.3x0.5m

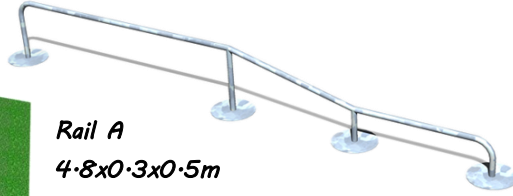

Rail S
4x0.8m

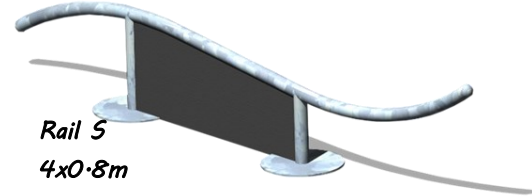

Picnic Table
2.4x1.8x0.6m

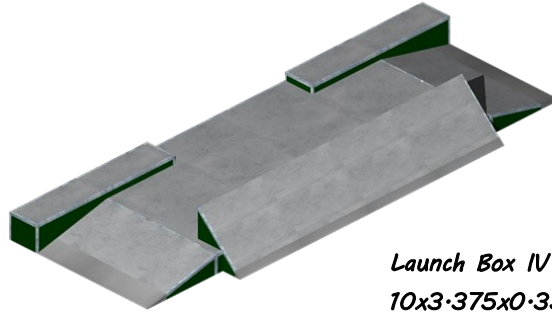

Launch Box IV
10x3.375x0.35m x 0.9



Bridge
7x2.4x0.8m



Manual Bad II
4.8x1.2x0.6m

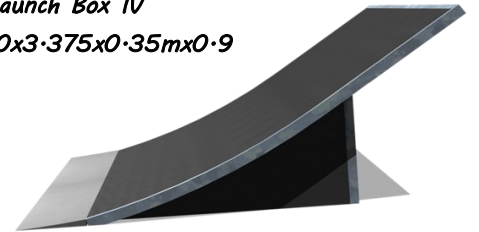

Bank MINI
2x2.4x0.9m

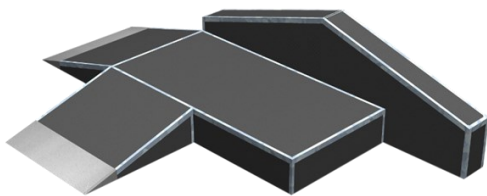

Fun Box
4.7x2.8x0.35x1m

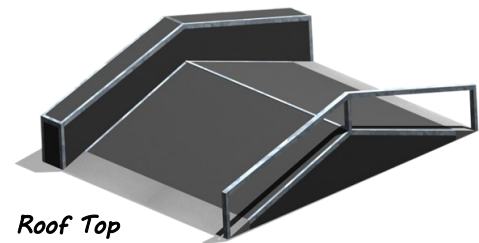

Roof Top
3.7x2.7x0.6m

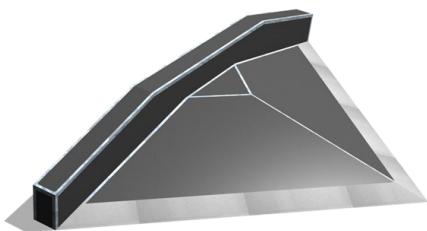

Roof Top II
5x3.3x0.6m

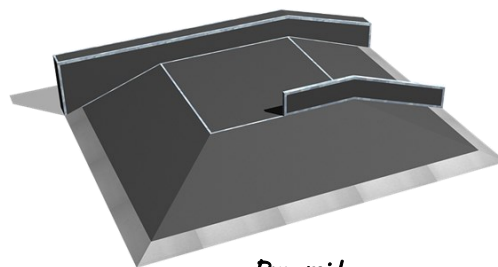

Pyramid
6x4.4x0.6m

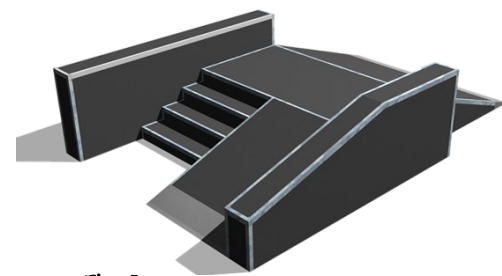

Fly Over
4.6x3x0.6m

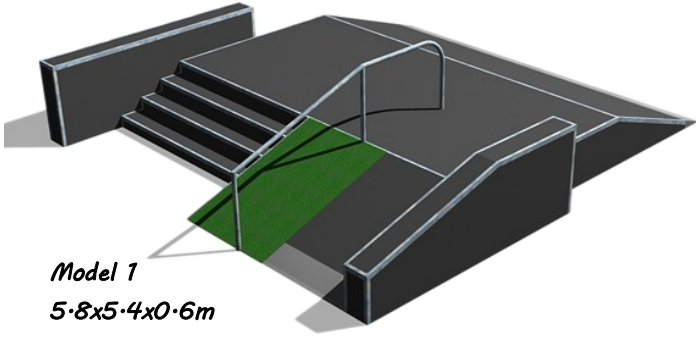

Model 1
5.8x5.4x0.6m

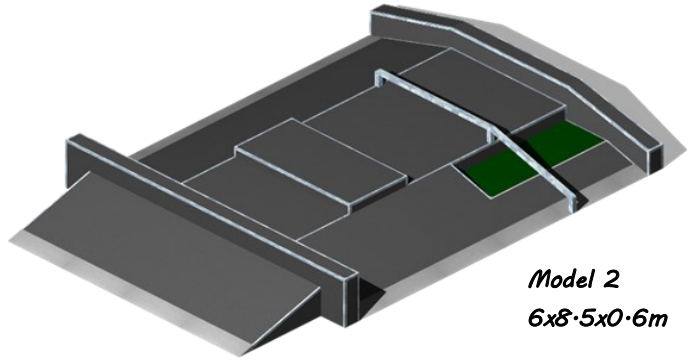

Model 2
6x8.5x0.6m

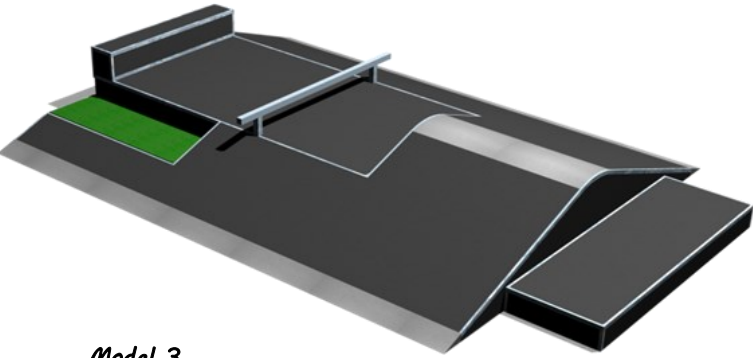

Model 3
8.4x5.8x0.6x0.95m

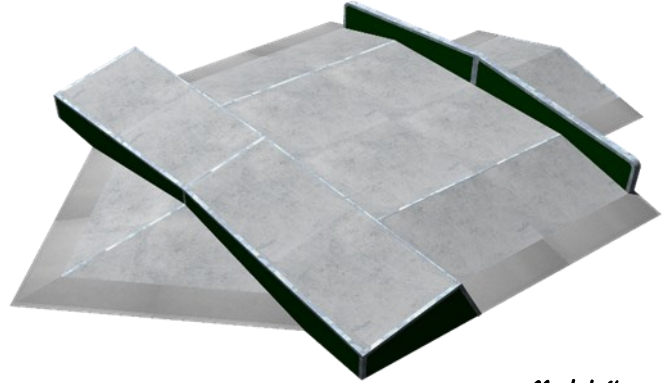

Model 4
5.8x6.7x0.6x1m

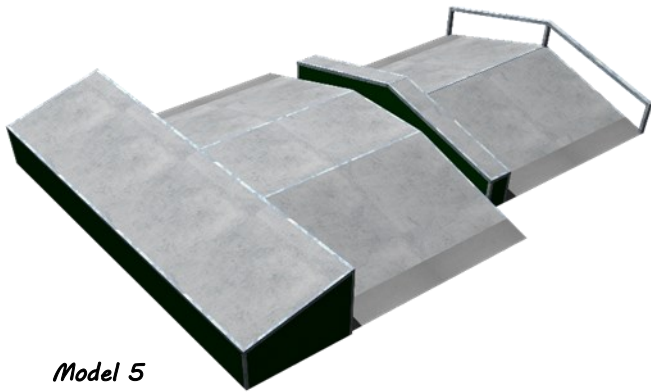

Model 5
4.6x6.3x0.6x1m

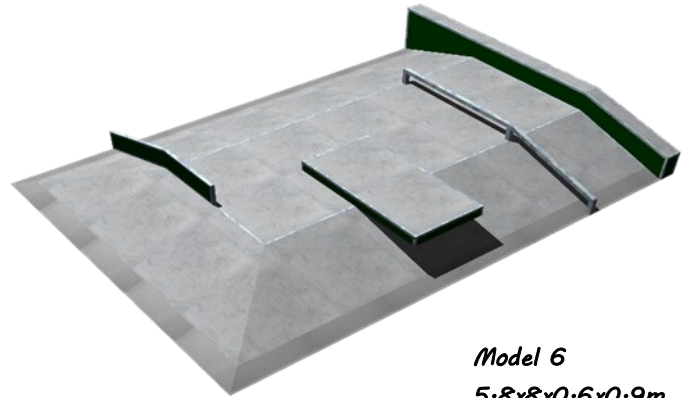

Model 6
5.8x8x0.6x0.9m

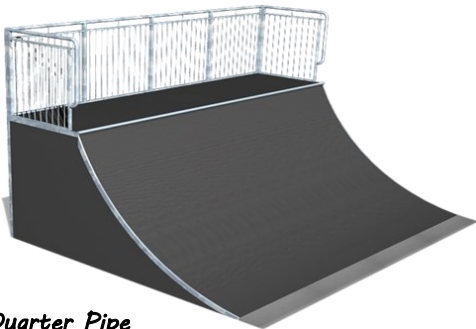

Quarter Pipe
3.6x2.4x1.25m
3.6x3.6x1.25m
4x3.6x1.8m
4x4.8x1.8m

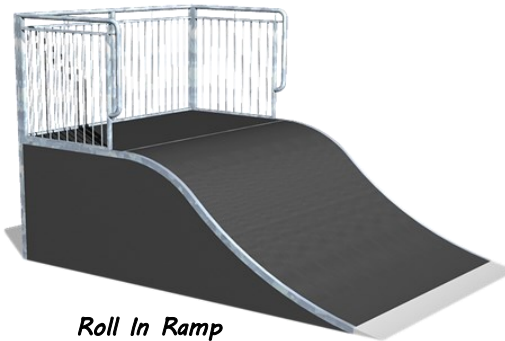

Roll In Ramp
4x2.4x1.25m
4x3.6x1.25m



Bank
4x2.4x1.25m
4x3.6x1.25m
5x3.6x1.8m
5x4.8x1.8m

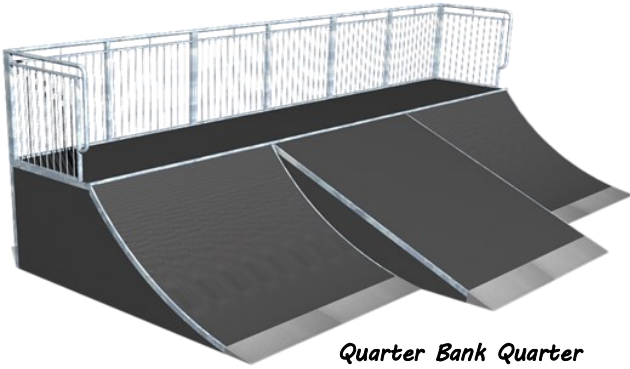

Quarter Bank Quarter
4x7.2x1.25

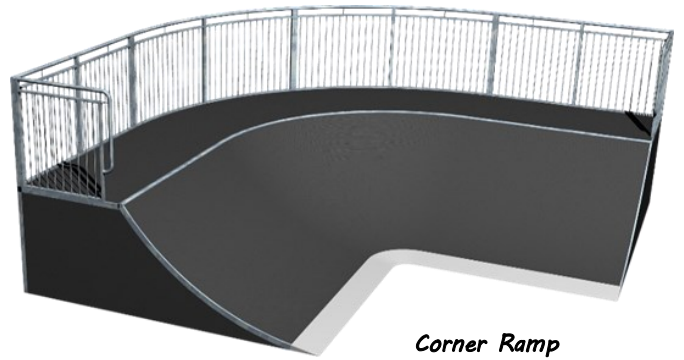

Corner Ramp
6.2x6.2x1.25

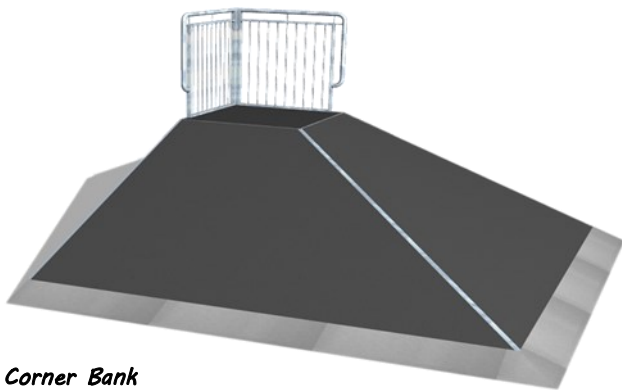

Corner Bank
3.5x3.5x0.9m
4x4x1.25m

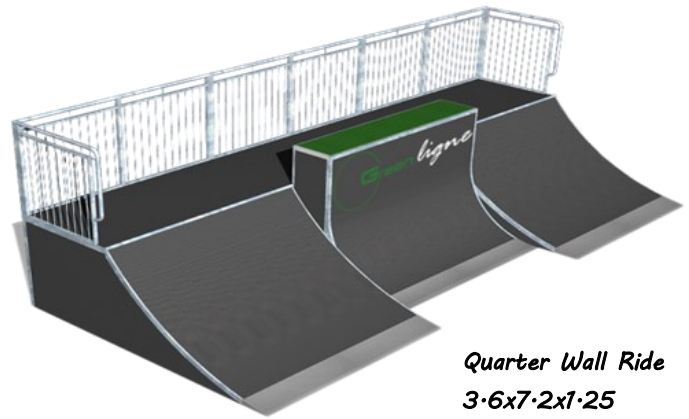

Quarter Wall Ride
3.6x7.2x1.25



Quarter Pipe with Hip
5x9x1.25m

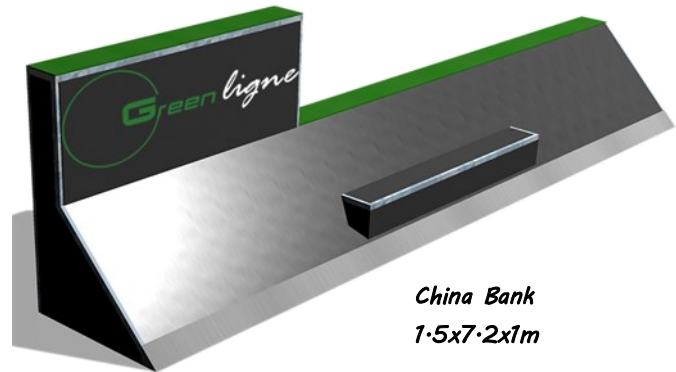

China Bank
1.5x7.2x1m



Bank with Kicker
4x3.6x1.25m

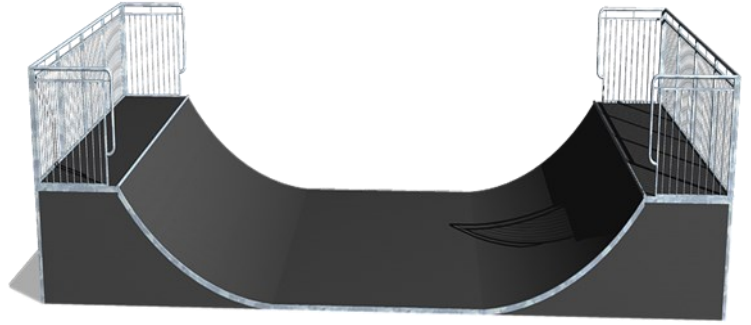

Mini Pipe
10x3.6x1.25m
10x4.8x1.25m

Midi Pipe
10.5x3.6x1.8m
10.5x4.8x1.8m

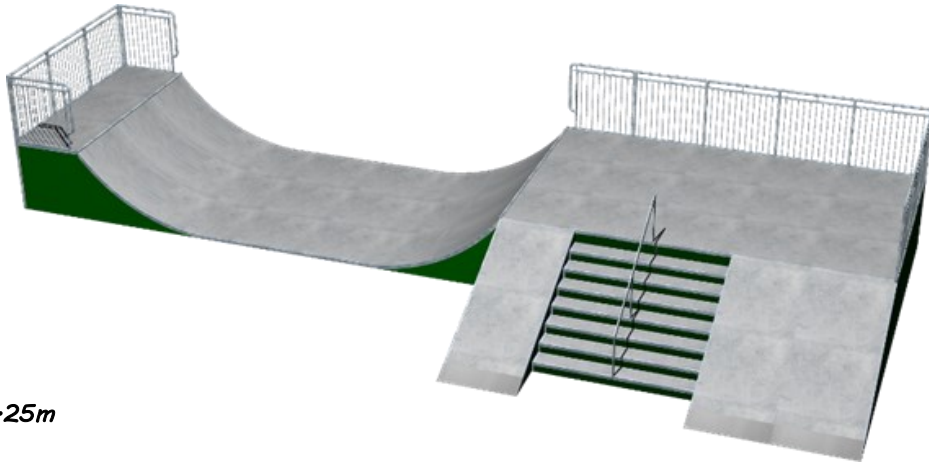

Kombi Pipe
14.5x6.4x1.25m

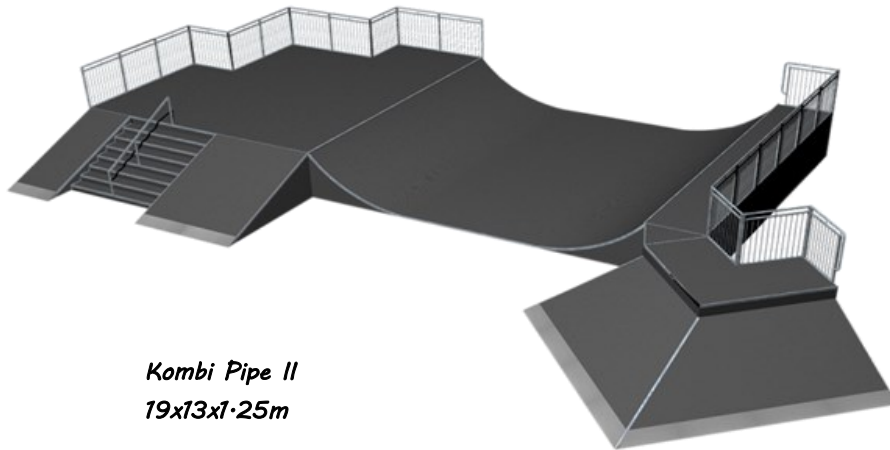

Kombi Pipe II
19x13x1.25m

Skate Park Technique & Details

Skate park equipment for Inline - Skateboard - BMX facilities in accordance to EN14974

CONSTRUCTION

Hot-dip galvanized steel pipe
construction with height adjusting foot supports for
level regulation
360° steel protection for skating surfaces

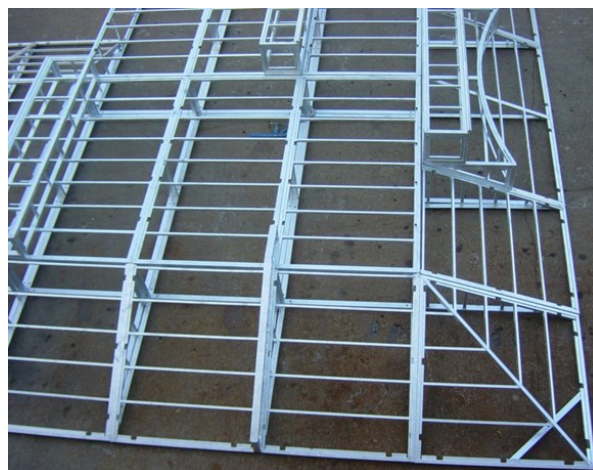

SKATING SURFACE

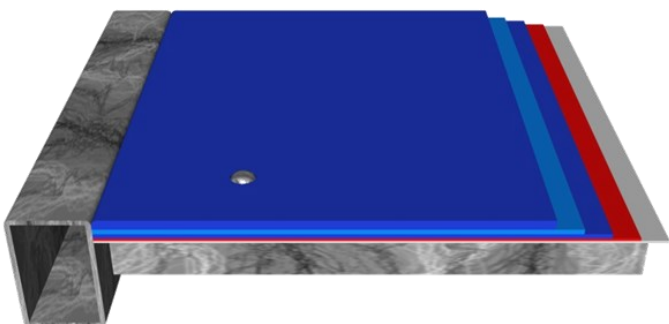

Fibre Glass

10mm reinforced fibreglass boards in all RAL colours,
standard colour—Grey

Concrete

10mm fibreglass reinforced concrete boards,
standard colour—Grey

Double noise protection layer with vibration absorber

APPROACHING PLATES



Stainless Steel

3mm pre-formed stainless steel plates for optimum ramp approach