



# WHOLESALE SOLUTIONS

**SAVE NOW**

PLACE YOUR ORDER AT  
[PRO.NAPAPROLINK.COM](http://PRO.NAPAPROLINK.COM)

Pricing Valid

4/1/2026 - 4/30/2026

Visibility | Chemicals & Commodities | Replacement Parts | Fleet Maintenance | Accessories | Shop Supplies | Paint & Body



**SPRING INTO  
BRAKES AND  
SUSPENSION  
SAVINGS**



## QUALITY AT EVERY LEVEL



### ADAPTIVE One® PASSENGER CAR

- Ceramic friction material
- 4-layer superior PTFE shim for noise-free braking
- PTFE rubber coated hardware (where applicable)
- CleanCoat Technology providing an improved break-in process



### ADAPTIVE One® R90 EURO

- Ceramic ECE R90 certified friction material
- 4-layer superior PTFE shim for noise-free braking
- PTFE rubber coated hardware (where applicable)
- CleanCoat Technology providing an improved break-in process



### ADAPTIVE One® PERFORMANCE

- Ceramic friction material formulated for aggressive stopping
- 4-layer superior PTFE shim for noise-free braking
- PTFE rubber coated hardware (where applicable)
- CleanCoat Technology providing an improved break-in process



### ADAPTIVE One® TRUCK & SUV

- > Ceramic friction material
- > 4-layer superior PTFE shim for noise-free braking
- > PTFE rubber coated hardware (where applicable)
- > CleanCoat Technology providing an improved break-in process

## COVERAGE FOR 99.5% OF ALL VEHICLES ON THE ROAD



### SILENTGUARD™ BRAKE PADS

- Ceramic and semi-metallic friction material
- Exclusive Silent Guard 4-layer fiber reinforced rubber shim
- PTFE rubber coated hardware (where applicable)
- CleanCoat Stripe Technology providing an improved break-in process



### PROFORMER™ BRAKE PADS

- Ceramic and semi-metallic friction material
- 3-layer rubberized shim
- Stainless steel hardware (where applicable)



### STOPRIT™ BRAKE PADS

- Ceramic and semi-metallic friction material
- 3-layer rubberized shim

## CLEAN WHEELS, NO SQUEALS

### PROBLEM:

BRAKE DUST  
AND NOISE?



### SOLUTION:

**AKERBOND**  
BRAKE EXPERTS

### SAFE, CLEAN, AND QUIET

AKERBOND  
**PROACT**  
ULTRA-PREMIUM BRAKE PADS

AKERBOND  
**EURO**  
ULTRA-PREMIUM BRAKE PADS

AKERBOND  
**SEVERE DUTY**  
ULTRA-PREMIUM FLEET BRAKE PADS

Scientifically engineered chamfers  
and slotted for enhanced NVH control  
(where applicable)

Multiple application-specific friction  
formulations to ensure the best  
performance for your vehicle



OE powder-coated  
paint process

OE positive  
mold design

Precision-cut  
pressure plate

NOT SHOWN:  
OE shim material for improved noise abatement  
Sensors (where applicable)

Premium stainless steel hardware  
(part number specific, where applicable)

## MADE IN USA

FACTORY INSTALLED  
**400+**  
MODELS  
OEM BRAND OF CHOICE

ORIGINAL EQUIPMENT  
ADVANCED  
**OEM**  
TECHNOLOGY  
MANUFACTURER

### NAPA Brake Boosters

Purchase \$500 in NAPA Brake Boosters and receive

**\$50** Prepaid  
Visa® Card\*



### SKF

### Bearings and Hub Assemblies

Spend \$500 on SKF Bearings and get a

**\$50** Prepaid  
Visa® Card\*

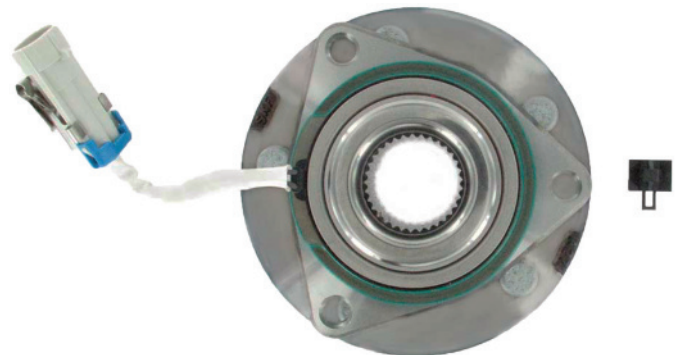

**Must be a NAPA Installer Rewards member or NAPA Auto Care for Prepaid Visa® Card offer**

\*This Card is issued by Sunrise Banks N.A., St. Paul, MN 55103, Member FDIC, pursuant to a license from Visa U.S.A. Inc. This card may be used everywhere Visa debit cards are accepted. Use of this card constitutes acceptance of the terms and conditions stated in the Cardholder Agreement. Card expires 12 months from issuance, per the "Valid Thru" date printed on the card. Prepaid Visa® Cards will be issued by IS Results and mailed within 10-12 weeks after the promotion has ended.

# HUB BEARINGS



## INTRODUCING NEW **E-COAT HUB BEARINGS**

### Why NAPA E-Coat Is “BETTER” Than Other Competitors



- OEM process electrodeposition coating (E Coat), which provides superior rust & corrosion protection passing 240 hr salt spray test
- Protocol Steel offers extended performance and superior fatigue life
- High Quality Chevron BP-2 grease for all precision components
- OEM Integrated ABS Connectors for long life and durability
- Triple-lip seal design
- Orbital formed design on applicable parts for easy installation & improved pre-load condition to avoid over-torque
- Meet or exceed OE fit, function and performance
- 472 skus, ~93% coverage on Passenger / Light Duty Trucks
- 3 years / 36,000 mile warranty



- Orbital formed design
- Premium triple-lip seal design
- Electrodeposition coated
- OEM lug studs

Precision Roller Components

Single and double row bearings - ball & taper roller matching OE design

OEM Integrated ABS Connectors for long life and durability

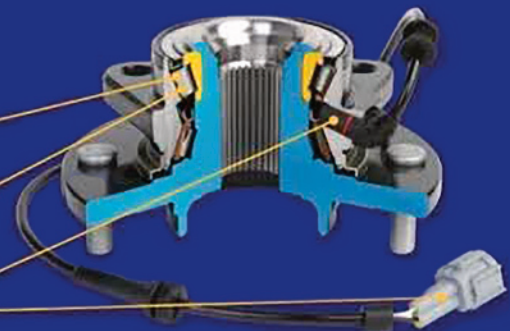

# THE ULTIMATE IN BRAKING PERFORMANCE

NOW AVAILABLE AT NAPA

Brembo's expansive inventory of premium braking solutions is now available at NAPA stores nationwide—making OE-level quality, unmatched control, and race-proven performance more accessible than ever.

Visit your local NAPA store today for the Brembo parts you need to elevate every drive.



## NEW MUST-SEE SOLUTIONS™

Our latest innovations  
that service professionals  
need to know about.

### LOWER INTERMEDIATE STEERING SHAFT

This steering shaft directly replaces the original equipment on specific vehicle applications. It is thoroughly tested to meet Federal Motor Vehicle Safety Standards, and precision-machined to ensure a tight, secure fit.



**NOE 425-207**

Ram 1500 2018-14, Ram 1500 Classic 2024-19, Ram Pickup 2014



### LOADED MAGNETIC STRUT ASSEMBLY



This Dorman® OE FIX® loaded magnetic strut assembly features an innovative upgraded top seal design that prevents a common and costly cause of strut failure. This active strut is a direct replacement for the OE component and retains true active adaptability unlike many competitors "passive" units which bypass the active suspension system. Our patent-pending top seal block assembly absorbs impact pressure better by more effectively and efficiently relieving and restoring cyclic fluid pressure on demand, virtually eliminating the relentless and damaging internal fluid pressurization inherent in the original equipment's design. In addition, this assembly features more durable mounting points to help ensure long service life under the toughest conditions. And because this is a pre-assembled loaded assembly, installation does not require the risk and hassle of using a spring compressor.

**NOE 949-730XD**

Cadillac 2020-15,  
Chevrolet 2020-15, GMC 2020-15



### LOADED KNUCKLES



This Dorman® OE FIX® loaded steering knuckle offers the labor-saving convenience of being pre-assembled and features a patent pending and proprietary coating that helps prevent corrosion between surfaces, providing a more permanent and reliable repair than the factory knuckle design. This kit includes all the needed components already assembled for a fast, simple, safe installation. It includes a new front knuckle, wheel bearing, hub and application-specific hardware.

**NOE 686-449 (Front Left) | NOE 686-448 (Front Right)**

Ram 1500 2018-12, Ram 1500 Classic 2022-19



## RIDE SMOOTH. DRIVE CONFIDENT.

### Upgrade to NAPA Air Suspension for Ultimate Comfort and Control.

Restore your vehicle's ride height, comfort, and control. Our precision engineered air suspension parts are built for durability and performance, delivering the smooth ride you expect. Trust the NAPA brand for quality you can depend on.



- Better than O.E. Design
- Full Import and Domestic Coverage
- Active and Passive options
- Includes Compressors, Valve Blocks, and Ride Height Sensors
- All New No Core
- Live Tech Support

Available at your  
local NAPA Auto Parts Store

# SUSPENSION



**AVAILABLE NOW**

**NEW EXPANDED COVERAGE:**  
49 New Repair Solutions For Hardworking Vehicles.

***BUILT FOR FLEETS.  
TRUSTED BY BUSINESSES.***

One truck or twenty — NAPA Fleet Chassis keeps your operation running strong.



## **DURABILITY THAT GOES THE DISTANCE**

Innovative engineering for extreme performance in demanding fleet and work-truck applications.

## **EVERYTHING YOU NEED, RIGHT IN THE BOX**

Essential hardware plus time-saving PREPACKAGED KITS available for quick, complete installs.

2025-2021 Ford F-150 | 2013-2009 Ram 2500 & 3500 | 2023-2005 Nissan Armada | 2023-2004 Nissan Titan | 2005-2019 Chevrolet Silverado 1500 | GMC Sierra 1500

## **The KYB Complete Assembly Lineup**

Made with the best components | Engineered to perform



World Class Shocks & Struts

General state pricing. Sale prices do not include applicable state/local taxes or recycling fees.



## NAPA PREMIUM CHASSIS



### NAPA PREMIUM CERTIFIED:

- Meeting standards and exceeding your customers' expectations

### NAPA TESTING:

- Material and dimensional validation
- Component testing
- Static and dynamic validation

### NAPA DESIGN:

- Premium greaseable, low-friction designs
- Exceeds technician's expectations
- Exacting fit

### NAPA QUALITY:

- Quality control ensures product consistently performs
- Class-leading material

**BETTER DESIGN. HIGHER QUALITY. EASIER INSTALLATION**

Leading Edge Technology Manufacturing controls and performance testing guidelines ensure the safety and longevity of the product  
Application Specific Designs Use OEM benchmarking and identify the appropriate specifications for each application to match the design  
Exacting Quality & Materials - Superior materials make a superior product and NAPA Chassis uses the highest quality materials throughout product manufacturing.

# SUSPENSION

## FRONT COIL-OVER SHOCK ABSORBER

Purchase \$1,000 in Arnott products and receive \$100 Prepaid Visa® Card\*

Line code: ARN

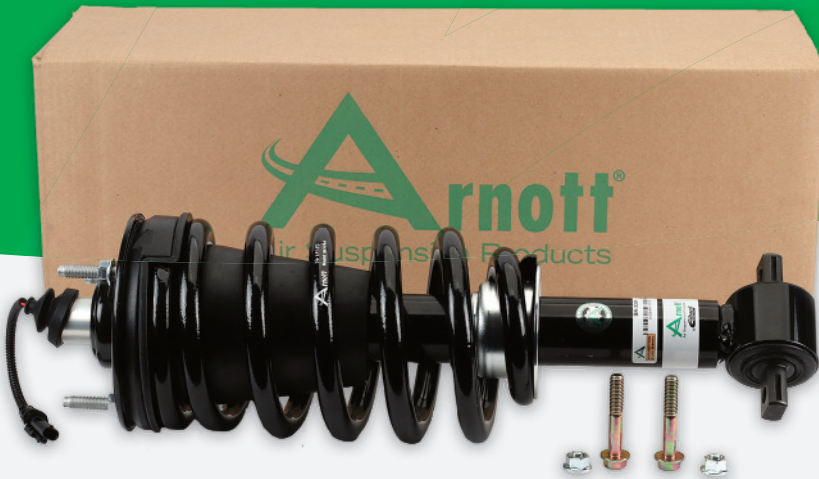

**Must be a NAPA Installer Rewards member or NAPA Auto Care for Prepaid Visa® Card offer**

\*This Card is issued by Sunrise Banks N.A., St. Paul, MN 55103, Member FDIC, pursuant to a license from Visa U.S.A. Inc. This card may be used everywhere Visa debit cards are accepted. Use of this card constitutes acceptance of the terms and conditions stated in the Cardholder Agreement. Card expires 12 months from issuance, per the "Valid Thru" date printed on the card. Prepaid Visa® Cards will be issued by IS Results and mailed within 10-12 weeks after the promotion has ended.



## Extended Travel C.V. Axles

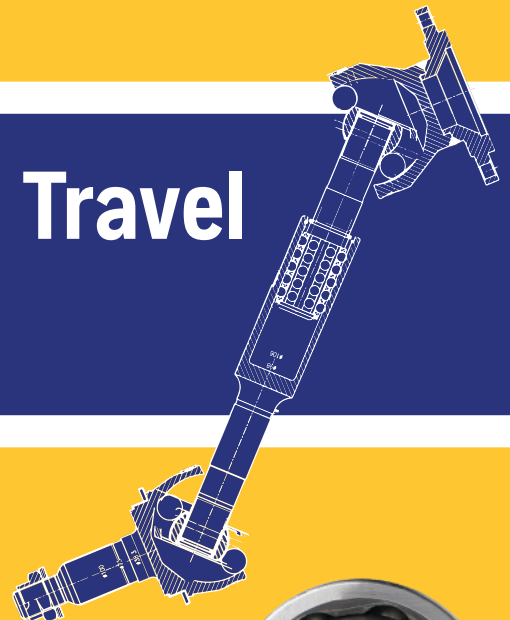

**DESIGNED SPECIFICALLY FOR LIFTED VEHICLES**

[NAPAcvaxles.com](http://NAPAcvaxles.com)

General state pricing. Sale prices do not include applicable state/local taxes or recycling fees.

# CHEMICALS & COMMODITIES

# WEITRON

SAVE UP TO 31%



STARTING AT \$849 /each

NFR W2458	R-1234yf Oil	8 oz.	\$8.49	NFR R1234YF10UV	Honeywell R-1234yf Uv Refrigerant Cylinder	10 lb.	\$424.99
NFR R1234YFCAN	Honeywell R-1234yf Refrigerant	8 oz.	\$20.99	NFR R1234YF25	Honeywell R-1234yf Refrigerant Cylinder	25 lb.	\$899.99
NFR R1234YFCANUV	Honeywell R-1234yf Refrigerant With UV Dye	8 oz.	\$23.49	NFR R1234YF25UV	Honeywell R-1234yf UV Refrigerant Cylinder	25 lb.	\$999.99
NFR W2459	R-1234yf Oil	1 qt.	\$29.99	NFR ZX3030	Weitron R-134a Refrigerant Cylinder	30 lb.	Call for Pricing
NFR R1234YF10	R1234yf Refrigerant	10 lb.	\$375.99	NFR ZX3012SS	Weitron R-134a Refrigerant Self-Sealing Can	12 oz.	Call for Pricing

# BLASTER

WORK IT LIKE A PRO

SAVE UP TO 19%



NCB BLA150	R-134a Stop Leak Auto A/C Refrigerant	3 oz.		NCB BLA606YF	R-1234yf Safe Seal	3 oz.	
NCB BLA405	R-134 Re-Charge Hose			NCB BLA611YF	R-1234yf Recharge Kit	10 oz.	
NCB BLA451YFA	R-1234yf Recharge Hose			NCB BLA235D	R-134a Recharge Kit	16 oz.	
NCB BLA155	Triple Seal For R-134a	3 oz.		NCB BLA602YFD	R-1234yf W/Digital Gauge	10 oz.	
NCB BLA310	R-134a W/Stop Leak	12 oz.		NCB BLA610YFA	AC Avalanche R-1234yf Refrigerant Kit	12 oz.	
NCB BLA151	R-1234yf Stop Leak	3 oz.		NCB BLA608YFC	AC Avalanche R-1234yf Refrigerant	14 oz.	
NCB BLA346A	R-134a Ac Refrigerant	16 oz.					

# CHEMICALS & COMMODITIES



SAVE UP TO 56%

\$4.79 /each

**Chevron® Techron® Complete Fuel System Cleaner**

12 oz.  
CHV 67740

\$10.59 /each

32 oz.  
CHV 37802



\$10.99 /each

**Chevron® Techron® Diesel Fuel System Cleaner**

20 oz.  
CHV TECHROND



SAVE UP TO 21%

STARTING AT \$12.29 /each



NCB 4780	Diesel DEF Treatment	8 oz.	\$12.29
NCB 4784	DEF Crystal Clean™ Diesel DEF & SCR Emissions System Cleaner	11.08 oz.	\$16.29
NCB 4744	DPF Clean Diesel Regen Medic+	16.9 oz.	\$21.99
NCB 4720	Cat Complete Fuel, Exhaust & Emissions System Cleaner	16.9 oz.	\$23.29



SAVE UP TO 41%

STARTING AT \$8.49 /each



RPO 11757	Max-Boost Octane Booster & Stabilizer	16 oz.	\$8.49
RPO 11755	Max-Tane® 6-in-1 Diesel Fuel Additive	20 oz.	\$10.99
RPO 11722	Max-Clean® Fuel System Cleaner & Stabilizer	20 oz.	\$12.49



**Reduces Emissions and Improves Overall Engine Performance.**

Safe for Gasoline, Diesel and Hybrid Vehicles. EPA Approved and Legal in All 50 States.

\$18.49 /each

**Fuel & Exhaust System Cleaner**

16 oz.  
NCB 120007



Use Cataclean 4X per Year for Maximum Efficiency

# CHEMICALS & COMMODITIES



SAVE UP TO 40%

STARTING AT \$8.99 each



SF DC14	Deep Creep Multi-Use Penetrating Lubricant	12 oz.	\$8.99	SF MP20	Marine Pro	20 oz.	\$10.99
SF SF20	Motor Treatment	12 oz.	\$10.79	SF SF128	Motor Treatment	1 Gal.	\$59.99
SF HM16	High Mileage Motor Treatment	16 oz.	\$10.99	SF MP128	Marine Pro	1 Gal.	\$64.99

# LUCAS OIL

STARTING AT \$7.29 each

SAVE UP TO 31%



LUC 10301	Grease - Multi-Purpose	14.5 oz.	\$7.29	LUC 10001	Heavy Duty Oil Stabilizer Motor Oil Additive	32 oz.	\$13.59
LUC 10005	Grease - Multi-Purpose Red & Tacky	14.5 oz.	\$7.79	LUC 10058	Oil Slick Mist Detailing Kit	24 fl. oz.	\$14.69
LUC 10514	Slick Mist® Fast & Easy Interior Detailer	24 oz.	\$11.59	LUC 10130	Pure Synthetic Oil Stabilizer	1 qt.	\$16.89
LUC 11025	Red "N" Tacky Grease	11 oz.	\$12.39	LUC 10002	Heavy Duty Oil Stabilizer Motor Oil Additive	1 gal.	\$31.09
LUC 10160	Slick Mist® Fast & Easy Speed Wax	24 oz.	\$12.49	LUC 10131	Pure Synthetic Oil Stabilizer	1 gal.	\$38.19

# CHEMICALS & COMMODITIES

## TRUFUEL®

STARTING AT  
**\$6.49**  
/each

SAVE  
UP TO  
**35%**



### TruFuel® Engineered Fuel

RPO 6525538	Pre-Mix Engineered Fuel & Oil 40:1	32 oz.	<b>\$6.49</b>	RPO 6525506	Pre-Mix Engineered Fuel & Oil 40:1	110 oz.	<b>\$20.99</b>
RPO 6525638	Pre-Mix Engineered Fuel & Oil 50:1	32 oz.	<b>\$6.49</b>	RPO 6525606	Pre-Mix Engineered Fuel & Oil 50:1	110 oz.	<b>\$20.99</b>
RPO 6527238	4-Cycle Engineered Fuel	32 oz.	<b>\$6.49</b>	RPO 6527206	4-Cycle Engineered Fuel	110 oz.	<b>\$20.99</b>

# THIS IS **NOT** THE CLASSIC WD-40® PRODUCT

## MEET OUR SPECIALIST LINE.

HEAVY-DUTY PRODUCTS FOR **HEAVY-DUTY WORK.**

**\$7.49**

Part# WD 300004  
**WD-40 SPECIALIST.  
PENETRANT**  
Frees up stuck, frozen, or seized equipment and parts.

**\$6.99**

Part# WD 300070  
**WD-40 SPECIALIST.  
MACHINE & ENGINE  
DEGREASER**  
Water-based aerosol formula provides deep, foaming, penetrating action and a powerful stream that sprays up to five feet to quickly & easily remove grease, oil, dirt, and grime.

**\$8.69**

Part# WD 300554  
**WD-40 SPECIALIST.  
CONTACT CLEANER**  
Ideal for sensitive electronics and electrical equipment.



WD-40® Brand products (WD-40 Specialist®, WD-40®, Multi-Use Product) do not contain ingredients at levels requiring California Prop 65 warnings, including benzene or toluene.

DEEP CLEAN

LOOSEN STUCK PARTS

**WD-40**  
SPECIALIST.  
PENETRANT  
FAST-ACTING

- Frees Corroded Nuts • Bolts
- Penetrates Rust
- Works On Contact

CLEANS SENSITIVE EQUIPMENT

**WD-40**  
SPECIALIST.  
MACHINE & ENGINE  
DEGREASER  
FOAMING SPRAY

- Quickly Removes Grease, Oil, Dirt & Grime
- Deep Penetrating Action
- Low Residue

LOW ODOR

**WD-40**  
SPECIALIST.  
CONTACT CLEANER  
QUICK-DRYING

- Cleans Sensitive Electrical Parts!
- Leaves No Residue

# CHEMICALS & COMMODITIES



STARTING AT  
**\$3.89**  
/each



SAVE  
UP TO  
**32%**

NCB M715	Non-Chlorinated Brake Parts Cleaner	14 oz.	<b>\$3.89</b>
NCB M710	Non-Chlorinated Brake Parts Cleaner	14 oz.	<b>\$3.89</b>
NCB M720	Chlorinated Brake Parts Cleaner	19 oz.	<b>\$4.49</b>
NCB FEB1	Engine Brite® Foamy Engine Cleaner	17 oz.	<b>\$4.49</b>
NCB 16BPTCAP	Battery Cleaner	11 oz.	<b>\$4.99</b>
NCB GR14CHTR	Extra Tacky Red Grease	14 oz.	<b>\$5.19</b>
NCB EB1	Original Engine Degreaser	15 oz.	<b>\$5.29</b>

NCB 16PBDS	Original Penetrant w/ Prostraw	11 oz.	<b>\$5.99</b>
NCB 16LG	White Lithium Grease	11 oz.	<b>\$5.49</b>
NCB 16SL	Silicone Lubricant	11 oz.	<b>\$5.49</b>
NCB EBT32	Surface Degreaser	32 oz.	<b>\$6.29</b>
NCB GD111	Valve Cleaner	11 oz.	<b>\$11.49</b>
NCB 5PWS	Parts Washer Solvent	5 gal.	<b>\$80.99</b>



STARTING AT  
**\$3.19**  
/each



MAC 8700	Carb, Choke & Throttle Body Cleaner	12 oz.	<b>\$3.19</b>
MAC 4800	Brake Parts Cleaner Non-Chlorinated	13 oz.	<b>\$3.49</b>
MAC 4810	Brake Parts Cleaner Ultra Low V.O.C.	13 oz.	<b>\$3.99</b>
MAC 1370	Chain & Cable Lube	12.75 oz.	<b>\$5.69</b>



STARTING AT  
**\$16.39**  
/each

SAVE  
UP TO  
**37%**



NCB OS1	Oil Seal Engine Oil Burning & Leak Repair	16.9 oz.	<b>\$16.39</b>
NCB O1111	Block Seal Head Gasket Fix	24 oz.	<b>\$28.29</b>
NCB HG1	Head Seal Head Gasket Repair	33.8 oz.	<b>\$38.29</b>

# CHEMICALS & COMMODITIES



SAVE  
UP TO  
**44%**



PTX 24114	Silicone Brake Lube	5 oz.	<b>\$4.19</b>
PTX 22058	Dielectric Tune Up Grease	3 oz.	<b>\$6.99</b>
PTX 81101	O-Ring Grease	1 oz.	<b>\$7.29</b>
PTX 82194	Ultra Grey Silicone	3 oz.	<b>\$8.49</b>
PTX 82180	Ultra Black Silicone	3 oz.	<b>\$8.59</b>
PTX 80078	Alum Anti-Seize Lubricant	8 oz.	<b>\$9.09</b>
PTX 25210	High Strength Removable Orange Threadlocker	0.34 oz.	<b>\$9.99</b>
PTX 24110	Ultra Disc Brake Caliper Lubricant	8 oz.	<b>\$13.99</b>
PTX 24112	Silicone Brake Parts Lubricant	8 oz.	<b>\$19.49</b>
PTX 24163	Surface Prep Activator for Anaerobic Speeds	4.5 oz.	<b>\$19.49</b>
PTX 24125	Ceramic Extreme Brake Parts Lubricant	8 oz.	<b>\$19.99</b>
PTX 24240	Blue Threadlocker	36 ml.	<b>\$24.99</b>
PTX 27140	Red Threadlocker	36 ml.	<b>\$24.99</b>
PTX 33694	Right Stuff Gasket Maker	10 oz.	<b>\$25.99</b>
PTX 85224	Right Stuff Gasket Maker	7.5 oz.	<b>\$25.99</b>

# CHEMICALS & COMMODITIES



## Brakleen® #1 BRAKE PARTS CLEANER



STARTING AT  
**\$367**  
/each

**Brakleen® Non-Chlorinated  
Brake Parts Cleaner**  
14 oz.

CRC 05050	50 State	<b>\$3.67</b>
CRC 05088	High Strength	<b>\$3.67</b>
CRC 05084	Low VOC	<b>\$3.68</b>

**\$390**  
/each

**Brakleen® Non-Chlorinated  
Brake Parts Cleaner Ultra  
Low VOC Complies w/  
SCAQMD Rule 1171**  
14 oz.

CRC 05151



**\$496**  
/each

**Brakleen®  
Non-Flammable  
Brake Parts  
Cleaner**  
19 oz.  
CRC 05089



**\$504**  
/each

**CRC® Power Lube®  
Multi-Purpose  
Lubricant**  
11 oz.  
CRC 05006



**\$661**  
/each

**Disc Brake Quiet**  
4 oz.  
CRC 05016



**\$752**  
/each

**Freeze-Off® Super  
Penetrant**  
11.5 wt. oz.  
CRC 05002



**\$781**  
/each

**Technician Grade  
Knock'er Loose®  
Lubricant**  
18 oz.  
CRC 401724

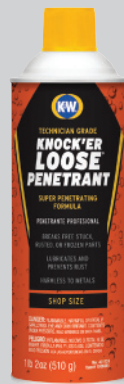

**\$832**  
/each

**Permanent Metallic™  
Block Seal Head  
Gasket Repair**  
16 wt. oz.  
CRC 401016



**\$859**  
/each

**Parts Cleaner & Degreaser  
Pro Series**  
18 oz.  
CRC 1751863

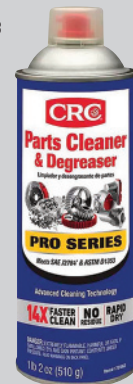

**\$864**  
/each

**Trans-X® Automatic  
Transmission Stop  
Leak & Tune-Up**  
15 fl. oz.  
CRC 402015



**\$1106**  
/each

**Instant Cooling  
System Stop Leak**  
15 fl. oz.  
CRC 401214



**\$1289**  
/each

**De-Squeak™ Conditioning  
Treatment For Brakes**  
11.25 wt. oz.  
CRC 05080



**\$1499**  
/each

**Silaramic® Brake  
System Grease**  
5 oz.  
CRC 05361



**\$2129**  
/each

**Permanent Head  
Gasket & Block Repair  
with Nanotechnology**  
32 fl. oz.  
CRC 401232



# CHEMICALS & COMMODITIES



SAVE UP TO **41%**

STARTING AT **\$4.79** /each



NCB 91164	Invisible Glass Premium Glass Cleaner	19 oz.	<b>\$4.79</b>
NCB 92164	Invisible Glass Premium Glass Cleaner	22 oz.	<b>\$4.79</b>
NCB 91154	Tarminator Tar & Sap Remover	10 oz.	<b>\$5.89</b>
NCB 91094	More Shine Tire Finish	12 oz.	<b>\$7.49</b>



SAVE UP TO **36%**

STARTING AT **\$6.99** /each  
Super Clean Heavy Duty Cleaner Degreaser



NCB 101780	32 oz. Trigger	<b>\$6.99</b>
NCB 101723	1 gal. Jug	<b>\$10.79</b>
NCB 101724	2.5 gal. Jug	<b>\$26.49</b>
NCB 100725	5 gal. Pail	<b>\$53.99</b>
NCB 100727	55 gal. Drum	<b>\$349.99</b>



SAVE UP TO **39%**

**\$4.89** /each

Spray Nine Multi Purpose Cleaner & Disinfectant

32 oz.  
NCB 26832

**\$12.99** /each

1 gal.  
NCB 26801



SAVE UP TO **41%**

STARTING AT **\$7.99** /each



NCB 25217	Fine Pumice Lotion Hand Cleaner	64 oz.	<b>\$7.99</b>
NCB 25219	Hand Cleaner	1 gal.	<b>\$12.49</b>
NCB 22340	Grease X Mechanic's Laundry Detergent	40 oz.	<b>\$13.99</b>
NCB 25618	Xtreme Hand Cleaner	1 gal.	<b>\$15.99</b>

# Crocodile<sup>®</sup> CLOTH

## 15-INCH X 10-INCH MEGA-SIZED WET CLEANING CLOTHS

Crocodile Cloth<sup>®</sup> is the toughest disposable cleaning cloth on the planet. Our unique formula and thick, mega-sized cloths devour grease, grime and gunk and absorb gloppy messes for fast, one-swipe cleaning. Safe for use on nearly all surfaces, including plastic, vinyl, metal, wood, bamboo, leather, carpets and fabrics. Gentle on hands, with aloe and vitamin E to condition skin.

**GO AHEAD. GET MESSY.<sup>®</sup>**

Now Available at



**MADE  
IN THE  
USA**



▲ Part #: NCB 6930100

**\$17<sup>99</sup>**  
/each

◀ Part #: NCB 6500080

**\$16<sup>99</sup>**  
/each

**SAVE  
UP TO  
31%**



STARTING AT  
**\$4<sup>49</sup>**  
/each



NCB 2354	Cherry Gel Pumice Hand Cleaner	10 oz.	<b>\$4.49</b>
NCB 7278	Supro Max Hand Cleaner	10 oz.	<b>\$5.29</b>

NCB 2356	Cherry Gel Pumice Hand Cleaner	1/2 Gal.	<b>\$15.29</b>
NCB 6396	Scrub Wipes	72 ct.	<b>\$16.99</b>
NCB 0972	Supro Max <sup>™</sup> Hand Cleaner	1/2 Gal.	<b>\$18.49</b>

# CHEMICALS & COMMODITIES

# Mac's

SAVE  
UP TO  
**38%**

STARTING AT  
**\$4.99**  
/each



MAC 1458	Aluminum Brightener Cleaner	32 oz.	<b>\$4.99</b>
MAC 1478	Aluminum Brightener Cleaner	1 gal.	<b>\$14.49</b>



SAVE  
UP TO  
**37%**

STARTING AT  
**\$4.39**  
/each



NCB 2117PS	Prime-Shine® Auto Glass & Multi-Surface Cleaner	32 oz.	<b>\$4.39</b>
NCB 60040PS	Extreme Power Cleaner Degreaser	40 oz.	<b>\$5.99</b>
NCB 60128P	Extreme Power Cleaner Degreaser	1 gal.	<b>\$10.99</b>
NCB 60022P	Extreme Power Cleaner Degreaser	2.5 gal.	<b>\$26.99</b>
NCB 60025P	Clean-Rite Extreme Power Cleaner Degreaser	5 gal.	<b>\$53.49</b>

## SERVICE CHEMICALS

### TAKE YOUR BUSINESS TO THE NEXT LEVEL

Generate over \$1,300 in profit with our VPS Chemicals



**Valvoline**

PROFESSIONAL SERIES



STARTING AT  
**\$34.49**  
/each

#### MAP Sensor Adapter

Use With VP055 Fuel Service Canister Tool

VAL 882574	<b>\$34.49</b>
VAL 882576	<b>\$38.99</b>
VAL 884327	<b>\$42.99</b>



**\$36.99**  
/each

#### Replacement Sprayer With Extension

Use With VP055 Complete Intake Aerosol Tool

VAL 883593



VAL VP004	Professional Series Water Pump Lubricant & Protector		<b>\$6.99</b>
VAL 886238	Professional Series CVT Protector Conditioner & Sealer	12 fl oz.	<b>\$10.99</b>
VAL 679741	Professional Series Complete Fuel System Treatment		<b>\$11.99</b>
VAL 806221	Professional Series Solvent Free Top Treat Oil System Cleaner		<b>\$11.99</b>
VAL 891564	Professional Series Complete Fuel System Treatment		<b>\$11.99</b>
VAL VP093	Professional Series Automatic Transmission Protector Conditioner & Sealer		<b>\$12.99</b>
VAL VP201	Professional Series Diesel Fuel Injector Treatment	12 fl oz.	<b>\$12.99</b>
VAL VP202	Professional Series Diesel Fuel Injector Treatment	1 qt.	<b>\$25.99</b>
VAL 507460	Professional Series All Season Heater and AC Two-Step Odor Elimination Kit		<b>\$30.99</b>
VAL 884531	Professional Series 'All Engine Clean' System for Gasoline Engines		<b>\$30.99</b>
VAL VP055	Professional Series V055 Complete Intake and Fuel Rail Cleaner Device		<b>\$218.99</b>
VAL 887106	Professional Series® Starter Kit		<b>\$999.99</b>

General state pricing. Sale prices do not include applicable state/local taxes or recycling fees.

# ANTIFREEZE

## NAPA® ANTIFREEZE + COOLANT



**CONVENTIONAL GREEN ANTIFREEZE CONCENTRATE**  
1 GAL (US)  
1GAL  
\$10.49



**EXTENDED LIFE ALL MAKES ALL MODELS CONCENTRATE**  
1 GAL (US)  
1EXT  
\$10.49



**STOCK UP, VOLUME BUY**  
**UP TO 39% OFF**

**NAPA® ANTIFREEZE COOLANT**  
55 GALLON DRUMS

**55GAL  
55EXT  
55DEX  
HD55GAL**

### HEAVY DUTY ANTIFREEZE & COOLANT RED



**ORANGE ANTIFREEZE CONCENTRATE**  
1 GAL (US)  
1DEX  
\$10.99



**SCA PRECHARGED HEAVY DUTY CONCENTRATE**  
1 GAL (US)  
HD1GAL  
\$11.89



**CONCENTRATE**  
1 GALLON  
HDRED  
\$10.49

## HEAVY-DUTY ANTIFREEZE + COOLANT

# FINAL CHARGE® PRO-SERIES

**HEAVY DUTY PERFORMANCE**

<b>1.5 MILLION MILES</b>	<b>36,000 HOURS</b>	<b>10 YEARS</b>
--------------------------	---------------------	-----------------

**FOR ALL HEAVY DUTY ENGINES**



**READY TO USE**  
1 GALLON  
FPRB53  
\$12.69



**CONCENTRATE**  
1 GALLON  
FPROB3  
\$20.29

# ANTIFREEZE

AS LOW AS  
**\$949**  
/each

**Zerex™ Cooling System  
Antifreeze/Coolant**  
1 gal.

ZRX ZXPCRU1	HD Green Ready to Use	<b>\$9.49</b>
ZRX 846437	Ready to Use	<b>\$11.99</b>
ZRX 895622	Ready to Use	<b>\$11.99</b>



**\$979**  
/each

**Zerex™ Cooling System  
Antifreeze Coolant Ready to Use**  
1 gal.  
ZRX 841943



AS LOW AS  
**\$1199**  
/each

**Zerex™ HD Extended  
Life Antifreeze/Coolant**  
1 gal.

ZRX ZXEDRU1	Ready to Use	<b>\$11.99</b>
ZRX ZXED1	Concentrate	<b>\$15.99</b>
ZRX 846439	Nitrite Free Concentrate	<b>\$16.99</b>



AS LOW AS  
**\$559.99**  
/each

**Zerex Cooling System  
Antifreeze Coolant**  
55 gal.

ZRX 846438	Ready to Use	<b>\$559.99</b>
ZRX ZXEDRU2	Ready to Use	<b>\$559.99</b>
ZRX ZXED2	Concentrate	<b>\$759.99</b>



**\$899**  
/each

**ShellZone Cooling  
System Antifreeze  
Ready To Use**  
1 gal.  
SHE 550062811



**\$1099**  
/each

**Shell ROTELLA®  
Cooling System  
Antifreeze  
Ready To Use**  
1 gal.  
SHE 9404206021

**\$1449**  
/each  
Concentrate  
SHE 9404106021



**\$1199**  
/each

**Shell ROTELLA®  
Cooling System  
Antifreeze  
Ready To Use**  
1 gal.  
SHE 550041810

**\$1549**  
/each  
Concentrate  
SHE 550041812



# GEAR OIL & GREASE

**\$5.49**  
/each

## Shell ROTELLA®

Tube/Cartridge  
14.1 oz.

SHE 550049923

MP Multi-Purpose Lithium Grease

SHE 550049924

ET Extreme Temperature Tacky Grease

SHE 550049925

HD Premium Heavy Duty Grease

SHE 550049926

SD Special Duty Moly Grease

**SAVE  
39%**

AS LOW AS  
**\$5.39**  
/each

## Premium Performance Gear Oil

NOL 75210	80W90	1 qt.	<b>\$5.39</b>
NOL 75211	85W140	1 qt.	<b>\$5.39</b>
NOL 891350	75W90	1 qt.	<b>\$9.99</b>
NOL 891382	75W140	1 qt.	<b>\$10.99</b>
NOL 75213	80W90	5 gal.	<b>\$89.99</b>
NOL 75215	85W140	5 gal.	<b>\$89.99</b>
NOL 914259	75W90	5 gal.	<b>\$129.99</b>

**SAVE  
UP TO  
49%**



SHE 550049923



SHE 550049924

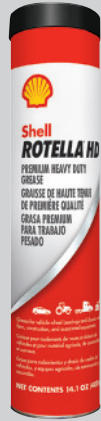

SHE 550049925



SHE 550049926

AS LOW AS

**\$4.39**  
/each

## Valvoline™ Grease



VAL 70124	Crimson #2 Multi-Purpose Grease	14 oz.	<b>\$4.39</b>
VAL 70133	Cerulean #2 Multi-Purpose Grease	14 oz.	<b>\$4.49</b>
VAL 70112	Palladium #2 with Moly Multi-Purpose Grease	14 oz.	<b>\$4.69</b>
VAL 872117	Cobalt #2 Grease	14 oz.	<b>\$5.39</b>
VAL 985	Synpower Synthetic Grease	14 oz.	<b>\$7.49</b>
VAL 70122	Crimson #2 Multi-Purpose Grease	35 lbs.	<b>\$129.99</b>
VAL 70120	Crimson #2 Multi-Purpose Grease	120 lbs.	<b>\$429.99</b>

STARTING AT

**\$4.49**  
/each

## Valvoline™ General Purpose EP Grease

VAL 609	14 oz.	<b>\$4.49</b>
VAL 606	35 lbs.	<b>\$139.99</b>
VAL 605	120 lbs.	<b>\$459.99</b>

STARTING AT

**\$4.69**  
/each

## Valvoline™ Multi-Purpose Grease

VAL 615	14 oz.	<b>\$4.69</b>
VAL 614	1 lb.	<b>\$5.19</b>
VAL 616	4 lbs.	<b>\$19.99</b>
VAL 612	35 lbs.	<b>\$144.49</b>
VAL 611	120 lbs.	<b>\$469.99</b>

**\$4.69**  
/each

## Valvoline™ Moly-Fortified Multi-Purpose Grease

14 oz.  
VAL 633



# OIL & FLUIDS

**\$439**  
/each

**NAPA® Full Synthetic Motor Oil**  
1 qt.

NOL 75516	0W16	NOL 75510	15W50
NOL 75540	0W20	NOL 75530	5W20
NOL 75500	10W30	NOL 75520	5W30

**\$2159**  
/each

5 qt.

NOL 75541	0W20	NOL 75521	5W30
NOL 75501	10W30	NOL 905304	0W16
NOL 75531	5W20		

**\$74999**  
/each

55 gal.

NOL 75545	0W20	NOL 75535	5W20
NOL 75505	10W30	NOL 75525	5W30



**\$469**  
/each

**NAPA® Full Synthetic High Mileage Motor Oil**  
1 qt.

NOL 883576	10W30
NOL 883574	5W20
NOL 883594	5W30

**\$2259**  
/each

5 qt.

NOL 883595	10W30
NOL 883586	5W20
NOL 883575	5W30



**\$1299**  
/each

**NAPA® Heavy Duty Diesel Engine Oil**  
1 gal.

15W40  
NOL 75122



**STARTING AT \$6299**  
/each

**NAPA® Motor Oil Conventional**

NOL 75126	5 gal.	30W	<b>\$62.99</b>
NOL 75118	5 gal.	40W	<b>\$66.99</b>



**\$6499**  
/each

**NAPA® Heavy Duty Diesel Engine Oil**  
5 gal.

15W40  
NOL 75121



**\$7899**  
/each

**NAPA® Heavy Duty Diesel Engine Oil Bay Box**  
15W40

NOL 869974



**\$8999**  
/each

**NAPA® Full Synthetic Motor Oil**  
6 gal. Bay Box

NOL 905302	0W16
NOL 869868	0W20
NOL 869957	5W20
NOL 869958	5W30



**\$68999**  
/each

**NAPA® Heavy Duty Diesel Engine Oil<sup>1</sup>**  
55 gal.

15W40  
NOL 75128



# OIL & FLUIDS

**\$5<sup>19</sup>**  
/each

**NAPA® Full Synthetic Motor Oil European Car Formula**

1 qt.  
5W40  
NOL 891346



**\$112<sup>99</sup>**  
/each

**NAPA® 1 European Car Formula Motor Oil Full Synthetic**

6 gal.  
5W40  
NOL 905179



**\$13<sup>99</sup>**  
/each

**NAPA® Heavy Duty Diesel Universal Fleet Plus Synthetic Blend Motor Oil**

1 gal.  
10W30  
NOL 891953



**\$19<sup>99</sup>**  
/each

**NAPA® Heavy Duty Diesel Universal Fleet Plus Full Synthetic Motor Oil**

1 gal.  
5W40  
NOL 891939



**\$32<sup>99</sup>**  
/each

**NAPA® Heavy Duty Universal Fleet Plus Engine Oil**

1 gal.  
15W40  
NOL 904819



**\$3<sup>49</sup>**  
/each

**NAPA Premium Performance Conventional Motor Oil**

1qt.  
SAE30  
NOL 75110

**\$3<sup>79</sup>**  
/each

1qt.  
SAE40  
NOL 75120

**\$3<sup>69</sup>**  
/each

**NAPA® Universal Fleet Plus Motor Oil**

1 qt.  
15W40  
NOL 75123



**\$117<sup>99</sup>**  
/each

**NAPA® Fleet Heavy Duty Diesel Motor Oil Full Synthetic**

6 gal.  
5W40  
NOL 892056

**\$1,084<sup>99</sup>**  
/each

**NAPA® Heavy Duty Motor Oil Heavy Duty Diesel**

55 gal.  
5W40  
NOL 895046



# OIL & FLUIDS

YOUR CHOICE

**\$6<sup>99</sup>**  
/each

**Valvoline™ Advanced Motor Oil Full Synthetic**

1 qt.

0W16

VAL 878400



**\$7<sup>19</sup>**  
/each

**Valvoline™ Full Synthetic High Mileage with MAXLIFE Motor Oil**

1 qt.

VAL 852400 0W20

VAL 180 10W30

VAL 849644 5W20

VAL 179 5W30

**\$7<sup>49</sup>**  
/each

**Valvoline™ Full Synthetic Hybrid Vehicle SAE Motor Oil**

1 qt.

0W20

VAL 888414

**\$3<sup>299</sup>**  
/each

5 qt.

VAL 881169 5W30

VAL 881170 10W30

VAL 881171 5W20



**\$7<sup>69</sup>**  
/each

**Valvoline™ European Full Synthetic Motor Oil**

1 qt.

VAL 787301 5W30

VAL 966 5W40

**\$7<sup>99</sup>**  
/each

1 qt.

VAL 888048 0W20

VAL 893931 0W30

VAL 852518 0W40

**\$3<sup>599</sup>**  
/each

5 qt.

5W40

VAL 881166

**\$1,3<sup>999</sup>**  
/each

55 gal.

5W40

VAL 929



**\$7<sup>49</sup>**  
/each

**Valvoline™ Extended Protection Full Synthetic Motor Oil**

1 qt.

VAL 891680 5W20

VAL 891682 0W20

VAL 891678 5W30

**\$3<sup>399</sup>**  
/each

5 qt.

VAL 891674 0W20

VAL 891672 5W20

VAL 891670 5W30



**\$3<sup>399</sup>**  
/each

**Valvoline™ Restore & Protect Full Synthetic Motor Oil**

5 qt.

VAL 904538 0W20

VAL 904562 5W20

VAL 904566 5W30



**\$3<sup>599</sup>**  
/each

**Valvoline™ Extended Protection High Mileage Full Synthetic Motor Oil**

5 qt.

VAL 899385 0W20

VAL 899387 5W20

VAL 899391 5W30



# OIL & FLUIDS

**\$6<sup>99</sup>** /each

**Valvoline™  
Advanced Full  
Synthetic Motor Oil**  
1 qt.

VAL 907226	0W8
VAL 916	0W20
VAL 927	5W20
VAL 935	10W30
VAL 945	20W50
VAL 955	5W30



**\$36<sup>99</sup>** /each

**Valvoline™ Full Synthetic  
European Motor Oil**  
5 qt.  
0W40  
VAL 881155



**\$127<sup>99</sup>** /each

**Valvoline™ Dexos D Full  
Synthetic Motor Oil**  
5 gal.  
0W20  
VAL 906164



**\$127<sup>99</sup>** /each

**Valvoline™ Full Synthetic  
MST Motor Oil**  
5 gal.

VAL 881055	5W30
VAL 881050	5W40



## VALVOLINE BAY BOX MOTOR OIL 5 gallons in each box

AS LOW AS  
**\$113<sup>99</sup>**

VAL 881629	Full Synthetic Motor Oil	5W30	5 gal.	<b>\$113.99</b>
VAL 881663	Full Synthetic Motor Oil	0W20	5 gal.	<b>\$113.99</b>
VAL 886758	Full Synthetic Motor Oil	0W16	5 gal. Bay Box	<b>\$113.99</b>
VAL 881058	Synpower XL-III Motor Oil	5W30	5 gal. Bay Box	<b>\$131.99</b>
VAL 886760	European Formula Full Synthetic Motor Oil	0W40	5 gal.	<b>\$131.99</b>
VAL 893933	European Formula Full Synthetic Motor Oil	0W30	5 gal.	<b>\$131.99</b>
VAL 904063	European Formula Full Synthetic Motor Oil	0W20	5 gal.	<b>\$131.99</b>





## \$6.29 /1 qt VALVOLINE™ MAXLIFE MULTI-VEHICLE AUTOMATIC TRANSMISSION FLUID

- #1 ATF BRAND
- SUITABLE FOR USE IN OVER 90% OF VEHICLES WITH TRADITIONAL AUTOMATIC TRANSMISSIONS



**Valvoline™**

TRUSTED FOR 150 YEARS

**\$5.39**  
/each

**Dex/Mercon**  
1 qt.  
VAL 798153



**\$5.59**  
/each

**Type Fa Trans**  
1 qt.  
VAL 822387



**\$6.29**  
/each

**Full Synthetic  
Dexron VI And  
Mercon LV ATF**  
1 qt.  
VAL 822405



**\$6.29**  
/each

**Max Life™  
Dexron III/Mercon  
Automatic  
Transmission  
Fluid**  
1 qt.  
VAL VV3246



**\$6.69**  
/each

**CVT Automatic  
Transmission  
Fluid ATF+4**  
VAL 822348



**\$6.99**  
/each

**Full Synthetic  
ULV ATF**  
1 qt.  
VAL 888460



**\$6.99**  
/each

**Full Synthetic  
Multi-Vehicle  
Transfer Case  
Fluid**  
1 qt.  
VAL 855459



**\$7.99**  
/each

**Synchromesh  
Manual  
Transmission  
Fluid**  
1 qt.  
VAL 811095



**\$8.19**  
/each

**CVT Automatic  
Transmission Fluid**  
1 qt.  
VAL 804751



**\$8.19**  
/each

**Full Synthetic  
DCT ATF**  
1 qt.  
VAL 888705



**\$19.79**  
/each

**Dex/Merc Automatic  
Transmission  
Fluid**  
1 gal.  
VAL 773636



# OIL & FLUIDS

**\$22<sup>99</sup>** /each

**MaxLife™ Full Synthetic Multi-Vehicle Automatic Transmission Fluid Cal**

1 gal.  
VAL 904891



**\$22<sup>99</sup>** /each

**MaxLife™ Dex/Merc Mercon LV Automatic Transmission Fluid**

1 qt.  
VAL 773775



**\$32<sup>99</sup>** /each

**Full Synthetic SynGard ES ATF**

1 gal.  
VAL 887972



**\$24<sup>99</sup>** /each

**Full Synthetic Dexron VI And Mercon LV ATF**

1 gal.  
VAL 883572



**\$25<sup>99</sup>** /each

**Full Synthetic Automatic Transmission Fluid + 4**

1 gal.  
VAL 883587



**\$31<sup>99</sup>** /each

**Full Synthetic CVT ATF**

1 gal.  
VAL 876133



**\$28<sup>99</sup>** /each

**Extended Protection ATF**

1 gal.  
VAL 899177



**\$28<sup>99</sup>** /each

**Extended Protection Full Synthetic ATF**

1 qt.  
VAL 904978



**STARTING AT \$94<sup>99</sup>** /each



VAL 349	Dex/Mercon	5 gal.	<b>\$94.99</b>
VAL 881051	MaxLife™ Dex/Mercon LV Automatic Transmission Fluid Bay Box	5 gal.	<b>\$104.99</b>
VAL 329	Trans Oil 50w	5 gal.	<b>\$119.99</b>
VAL 886642	ATF+4 Full Synthetic Automatic Transmission Fluid Box	5 gal.	<b>\$124.99</b>
VAL 881056	CVT Automatic Transmission Fluid	5 gal.	<b>\$149.99</b>
VAL 887980	SynGard ES Full Synthetic Automatic Transmission Fluid	5 gal.	<b>\$154.99</b>
VAL 706035M	Hd Syn Attsae 50	5 gal.	<b>\$209.99</b>

**STARTING AT \$1,149<sup>99</sup>** /each



VAL 904897	MaxLife™ Multi-Vehicle Automatic Transmission Fluid Cal	55 gal.	<b>\$1,149.99</b>
VAL 326	Maxlife Dex/Merc	55 gal.	<b>\$1,149.99</b>
VAL 888012	SynGard ES Full Synthetic Automatic Transmission Fluid	55 gal.	<b>\$1,499.00</b>

# OIL & FLUIDS

**\$749**  
/each

**Valvoline™ Full Synthetic Restore & Protect Motor Oil**  
1 qt.

VAL 904536	0W20
VAL 904540	5W20
VAL 904564	5W30



**\$1579**  
/each

**Valvoline™ All Terrain Heavy Duty Engine Oil**  
1 gal.  
SAE 15W40  
VAL 894015



STARTING AT  
**\$1599**  
/each

**Valvoline™ Premium Blue Heavy Duty Engine Oil**  
1 gal.  
15W40



VAL 773780	SAE Engine Oil	15W40	<b>\$15.99</b>
VAL 818289	Synthetic Blend	10W30	<b>\$16.99</b>
VAL 774038	Pr/Blue Xtr	5W40	<b>\$23.99</b>

**\$12199**  
/each

**Valvoline™ Restore & Protect Full Synthetic Motor Oil**  
5 gal.

VAL 906537	0W20
VAL 906571	5W20
VAL 906575	5W30



**\$799**  
/each

**Valvoline™ VR1 Racing Motor Oil Full Synthetic**  
1 qt.  
10W30  
VAL 679083

**\$829**  
/each

1 qt.  
20W50  
VAL 679082

**\$2799**  
/each

**Valvoline™ VR1 Racing Motor Oil Racing Oil**  
5 qt.  
20W50  
VAL 881172



**\$649**  
/each

**Valvoline™ Outboard 2-Cycle Oil**  
1 qt.  
VAL 822386

**\$2599**  
/each

1 gal.  
VAL 773735



**\$599**  
/each

**Valvoline™ VR1 Racing and Classic Cars Conventional Motor Oil**  
1 qt.  
10W30  
VAL 822388

**\$629**  
/each

1 qt.

VAL 822347	20W50
VAL 822350	50W
VAL 822390	40W
VAL 822401	30W



# OIL & FLUIDS

**\$629**  
/each

**Valvoline™ ATV 4 Stroke Motor Oil Conventional**

1 qt.  
10W40  
VAL 817263



**\$649**  
/each

**Valvoline™ Multi-Purpose 2-Stroke Oil**

1 qt.  
VAL 822384



**\$649**  
/each

**Valvoline™ Motorcycle 4 Stroke Motor Oil Conventional**

1 qt.  
10W40  
VAL 798151



**\$689**  
/each

**Valvoline™ Motorcycle 4 Stroke Motor Oil Conventional**

1 qt.  
20W50  
VAL 798152



**\$699**  
/each

**Valvoline™ Motorcycle Motor Oil Full Synthetic**

1 qt.  
10W40  
VAL 507679



**\$799**  
/each

**Valvoline™ Ultimate Powersport Full Synthetic Motor Oil**

1 qt.  
10W40  
VAL 899367



**\$799**  
/each

**Valvoline™ Motorcycle Motor Oil Full Synthetic**

1 qt.  
20W50  
VAL 743525



**\$849**  
/each

**Valvoline™ Marine 4 Stroke Engine Oil**

1 qt.  
10W30  
VAL 899557



**\$3199**  
/each

**Valvoline™ Marine 4 Stroke Engine Oil**

1 gal.  
10W30  
VAL 899591





## Mobil 1™ Emission System Protection motor oil

Recommended for high-performance European vehicles

- Maintains emission efficiency in diesel- and gas-powered European vehicles
- Cleaning agents help reduce deposits and sludge buildup for cleaner engines
- Keeps your engine running like new



Mobil 1 ESP 5W-30 1 QT	127568	<b>\$8.99</b>	Mobil 1 ESP 0W-30 5 QT	126609	<b>\$37.99</b>
Mobil 1 ESP 0W-20 1 QT	125386	<b>\$8.99</b>	Mobil 1 ESP 0W-20 5 QT	127706	<b>\$37.99</b>
Mobil 1 ESP 0W-30 1 QT	124547	<b>\$8.99</b>	Mobil 1 ESP 5W-30 5 QT	127513	<b>\$37.99</b>
Mobil 1 ESP 0W-40 1 QT	127918	<b>\$8.99</b>			

© 2026 ExxonMobil. Mobil, Mobil 1, and the 1 icon are trademarks or registered trademarks of Exxon Mobil Corporation or one of its subsidiaries. Other trademarks shown are property of their respective owners. All rights reserved.

**\$5.99**  
/each

### Full Synthetic Motor Oil 1 qt.

MOB 125197	0W20
MOB 125196	5W20
MOB 125195	5W30



**\$6.99**  
/each

### European Car Formula Advanced Full Synthetic Motor Oil 1 qt.

MOB 112628	0W40
MOB 126232	5W40



**\$7.49**  
/each

### 1 qt. 0W8 MOB 127876

**\$34.99**  
/each

5 qt.

MOB 120760	0W40
MOB 126231	5W40

**\$36.99**  
/each

### 5 qt. 0W8 MOB 127857



**\$6.99**  
/each

### Advanced Fuel Economy Full Synthetic Motor Oil 1 qt.

MOB 124321	0W16
MOB 124184	0W20
MOB 112746	0W30



**\$34.99**  
/each

5 qt.

MOB 124322	0W16
MOB 124185	0W20
MOB 120761	0W30

**\$6.99**  
/each

### Advanced Full Synthetic Motor Oil 1 qt.

MOB 103008	5W20
MOB 124315	5W30
MOB 122075	5W50
MOB 122319	10W30
MOB 122377	15W50



**\$34.99**  
/each

5 qt.

MOB 120763	5W20
MOB 124317	5W30
MOB 122326	10W30

**\$6.99**  
/each

### Turbo Diesel Truck Full Synthetic Motor Oil

1 qt.  
5W40  
MOB 122253



**\$28.99**  
/each

1 gal.  
5W40  
MOB 127097



## Rack up a FREE gift.\*

Get a branded oil rack when you buy 12 6-gal Boxxes of Mobil 1™ motor oil.



\$152.99 per Boxx	
127423	MOBIL 1 0W16 BOXX 6USG/22.71L
124119	MOBIL 1 0W20 BOXX 6USG/22.71L
124124	MOBIL 1 5W20 BOXX 6USG/22.71L
124128	MOBIL 1 5W30 BOXX 6USG/22.71L
124121	MOBIL 1 FS 0W40 BOXX 6USG/22.71L



Value of Rack \$530

Scan or visit  
[mobilpromotions.com/NAPAInstaller](https://mobilpromotions.com/NAPAInstaller)  
 to redeem.



Offer valid: 1/1/26–12/31/26. \*While supplies last. Terms and conditions apply. Purchase must be on one invoice. Cannot submit same invoice for multiple Mobil 1 offers. Imagery of prize is for illustration purposes only. Prize may vary.

© 2026 ExxonMobil. Mobil, Mobil 1, and the 1 icon are trademarks or registered trademarks of Exxon Mobil Corporation or one of its subsidiaries. Other trademarks shown are property of their respective owners. All rights reserved.

**\$699**  
/each

**Truck & SUV Full Synthetic Motor Oil**  
1 qt.

- MOB 124592 0W20
- MOB 124574 5W20
- MOB 124595 5W30

**\$3499**  
/each

- 5 qt.
- MOB 124593 0W20
  - MOB 124575 5W20
  - MOB 124596 5W30



**\$729**  
/each

**High Mileage Full Synthetic Motor Oil**  
1 qt.

- MOB 122535 0W20
- MOB 120455 5W20
- MOB 103767 5W30
- MOB 103535 10W30
- MOB 103536 10W40

**\$3599**  
/each

- 5 qt.
- MOB 122536 0W20
  - MOB 120768 5W20
  - MOB 120769 5W30
  - MOB 120770 10W30



**\$749**  
/each

**Extended Performance Full Synthetic Motor Oil**  
1 qt.

- MOB 120926 0W20
- MOB 102989 5W20
- MOB 112627 5W30
- MOB 102990 10W30

**\$3699**  
/each

- 5 qt.
- MOB 120903 0W20
  - MOB 120765 5W20
  - MOB 120766 5W30



**\$779**  
/each

**Extended Performance Full Synthetic High Mileage Motor Oil**  
1 qt.

- MOB 123836 0W20
- MOB 123839 5W20
- MOB 123842 5W30

**\$3799**  
/each

- 5 qt.
- MOB 123837 0W20
  - MOB 123840 5W20
  - MOB 123843 5W30



# OIL & FLUIDS

**\$8<sup>99</sup>**  
/each

**SUPERCAR**  
Full Synthetic  
Motor Oil  
1 qt.

MOB 126870 0W40  
MOB 127372 5W50



**\$9<sup>99</sup>**  
/each

**VTwin**  
20W50  
1 qt.  
MOB 112630



**\$9<sup>99</sup>**  
/each

**Racing 4T**  
10W40  
1 qt.  
MOB 124245



**\$17<sup>99</sup>**  
/each

**1300 Super Diesel**  
1 gal.

MOB 122485 10W30  
MOB 122492 15W40



**\$26<sup>99</sup>**  
/each

**1 ESP Motor Oil**  
Heavy Duty Diesel  
1 gal.  
5W40  
MOB 127863



**\$26<sup>99</sup>**  
/each

**Advanced Synthetic Diesel**  
Engine Oil  
1 gal.  
5W30  
MOB 126085



**\$34<sup>95</sup>**  
/each

**Synthetic Automatic**  
Transmission Fluid  
1 gal.  
MOB 122062



**\$79<sup>99</sup>**  
/each

**Tractor Hydraulic Fluid**  
5 gal.  
MOB 124788



**\$152<sup>99</sup>**  
/each

**Mobil 1<sup>™</sup> Advanced**  
Full Synthetic Motor Oil  
6 gal.

MOB 127423 0W16  
MOB 124119 0W20  
MOB 124121 0W40  
MOB 124124 5W20  
MOB 124128 5W30



# OIL & FLUIDS

STARTING AT  
**\$17<sup>29</sup>**  
/each

## Shell Rotella® T4 Triple Protection Motor Oil

SHE 550045144	10W30	1 gal.	<b>\$17.29</b>	SHE 550045128	15W40	5 gal.	<b>\$85.99</b>
SHE 550045126	15W40	1 gal.	<b>\$17.29</b>	SHE 550045137	10W30	55 gal.	<b>\$924.99</b>
SHE 550045127	15W40	2.5 gal.	<b>\$44.49</b>	SHE 550045148	15W40	55 gal.	<b>\$924.99</b>



STARTING AT  
**\$18<sup>49</sup>**  
/each

## Shell ROTELLA® T1 Straight Grade Conventional Motor Oil

SHE 550054449	SAE 30	1 gal.	<b>\$18.49</b>	SHE 550054448	SAE 30	5 gal.	<b>\$88.99</b>
SHE 550054466	SAE 40	1 gal.	<b>\$18.49</b>	SHE 550054465	SAE 40	5 gal.	<b>\$88.99</b>

STARTING AT  
**\$20<sup>99</sup>**  
/each

## Shell Rotella® T5 Synthetic Blend Motor Oil

SHE 550045130	10W30	1 gal.	<b>\$20.99</b>	SHE 550045131	10W30	55 gal.	<b>\$997.99</b>
SHE 550045348	15W40	1 gal.	<b>\$20.99</b>	SHE 550046214	15W40	55 gal.	<b>\$997.99</b>
SHE 550046254	10W30	1 gal.	<b>\$26.49</b>				



STARTING AT  
**\$24<sup>99</sup>**  
/each

## Shell ROTELLA® T6 Synthetic Motor Oil

SHE 550046251	5W30	1 gal.	<b>\$24.99</b>	SHE 550046215	5W40	2.5 gal.	<b>\$61.49</b>
SHE 550045347	5W40	1 gal.	<b>\$24.99</b>	SHE 550046217	5W40	5 gal.	<b>\$122.49</b>
SHE 550050467	15W40	1 gal.	<b>\$24.99</b>	SHE 550062921	15W40	5 gal.	<b>\$122.49</b>
SHE 550069698	10W30	1 gal.	<b>\$24.99</b>	SHE 550046219	5W40	55 gal.	<b>\$1,269.99</b>

**\$45<sup>99</sup>**  
/each

## Shell Spirax S6 Automatic Transmission Fluid ATF A668

1 gal.  
SHE 550062008

**\$211<sup>49</sup>** /each

5 gal.  
SHE 550062007

**\$2,224<sup>99</sup>** /each

55 gal.  
SHE 550062005



**\$77<sup>99</sup>**  
/each

## Shell ROTELLA® Heavy Duty Tractor Transmission Fluid

5 gal.  
SHE 550039811



# OIL & FLUIDS

**\$679**  
/each

**Platinum Full Synthetic Motor Oil**

1 qt.

PEN 550049266	0W16
PEN 550036541	0W20
PEN 550022686	5W20
PEN 550022689	5W30
PEN 550022687	10W30

**\$739**  
/each

**Platinum/Euro Full Synthetic Motor Oil**

1 qt.

PEN 550051126	5W30
PEN 550051120	5W40



**\$679**  
/each

**Platinum Full Synthetic High Mileage Motor Oil**

1 qt.

PEN 550046634	0W20
PEN 550042724	5W20
PEN 550042728	5W30
PEN 550043951	10W30

**\$2999**  
/each

**Platinum Full Synthetic Motor Oil**

5 qt.

PEN 550046127	0W20
PEN 550046122	5W20
PEN 550046126	5W30
PEN 550046205	10W30
PEN 550049263	0W16

**\$2999**  
/each

**Platinum High Mileage Full Synthetic Motor Oil**

5 qt.

PEN 550045196	5W20
PEN 550045195	5W30
PEN 550046636	0W20
PEN 550045274	10W30

**\$579**  
/each

**Pennzoil® Full Synthetic Motor Oil**

1 qt.

PEN 550058594	0W20
PEN 550058603	10W30
PEN 550058597	5W20
PEN 550058600	5W30



**\$579**  
/each

**Pennzoil® High Mileage Full Synthetic Motor Oil**

1 qt.

PEN 550069989	0W20
PEN 550069991	5W20
PEN 550069993	5W30



**\$599**  
/each

**Pennzoil® High Mileage Vehicle Motor Oil**

1 qt.

PEN 550022818	5W20
PEN 550022838	5W30
PEN 550022812	10W30
PEN 550022829	10W40



**\$2699**  
/each

5 qt.

PEN 550058596	0W20
PEN 550058604	10W30
PEN 550058599	5W20
PEN 550058602	5W30

**\$2699**  
/each

5 qt.

PEN 550069988	0W20
PEN 550069990	5W20
PEN 550069992	5W30

**\$2599**  
/each

5 qt.

PEN 550045203	5W20
PEN 550045205	10W30
PEN 550045218	5W30

**\$739**  
/each

**Pennzoil® Ultra Platinum Full Synthetic Motor Oil**

1 qt.

PEN 550039860	0W20
PEN 550040856	0W40
PEN 550040863	5W20
PEN 550040865	5W30



**\$3299**  
/each

5 qt.

PEN 550045202	5W20
PEN 550045201	5W30

**\$3299**  
/each

**Pennzoil® Euro L Motor Oil**

5 qt.  
5W30

PEN 550051123
---------------



# OIL & FLUIDS

**\$161<sup>42</sup>** /each

**Pennzoil Platinum Motor Oil Full Synthetic**

6 gal.

PEN 550048977 0W16

PEN 550051122 5W30



**\$171<sup>03</sup>** /each

**Pennzoil Platinum Motor Oil Full Synthetic**

6 gal.

PEN 550022685 5W20

PEN 550022688 5W30

PEN 550036473 0W20



**\$188<sup>38</sup>** /each

**Pennzoil Platinum Motor Oil Full Synthetic 22.7 L**

0W40

6 gal.

PEN 550051110



**\$218<sup>02</sup>** /each

**Pennzoil Platinum Motor Oil Full Synthetic**

5W30

6 gal.

PEN 550040843



**\$126<sup>54</sup>** /each

**Shell Rotella T4 Triple Protection Motor Oil Ecobox Conventional**

6 gal.

SHE 550045149 10W30

SHE 550045150 15W40



**\$182<sup>44</sup>** /each

**Shell Rotella T6 Motor Oil Ecobox Full Synthetic**

5W40

6 gal.

SHE 550046218



# OIL & FLUIDS

**\$4.59**  
/each

**Quaker State®**  
**Advanced Durability**  
1 qt.

OO 550034964	10W40
OO 550035082	5W20
OO 550035170	10W30
OO 550035180	5W30
OO 550035190	SAE 30



**STARTING AT**  
**\$15.99**  
/each



CHV GAL15W40SB	400 XLE SAE Synthetic Blend Motor Oil	15W40	1 gal.	<b>\$15.99</b>
CHV 257015388	400 XSP Full Synthetic Motor Oil	15W40	1 gal.	<b>\$22.99</b>
CHV GAL10W30	400 XLE Synblend Motor Oil	10W30	1 gal.	<b>\$25.99</b>

CHV GAL5W40	400 LE Motor Oil	5W40	1 gal.	<b>\$31.99</b>
CHV 3GAL15W4040SB	400 LE Motor Oil	15W40	3 gal.	<b>\$54.99</b>
CHV 5GAL15W40SB	400 XLE SAE Synthetic Blend Motor Oil	15W40	5 gal.	<b>\$105.00</b>

General state pricing. Sale prices do not include applicable state/local taxes or recycling fees.

# OIL & FLUIDS



## Buy 6 ePODS, Get a free dispenser

Excluding GTX Ultra Clean and GTX 10W-30 products.

Maximum Oil Usage Gravity-fed design ensures you use every last drop.

Efficient Inventory Management. Innovative dispensing system allows you to carry 4 viscosity grades in the same footprint of a drum; translucent bottle helps prevent out of stocks.

Premium look for Professionals. Fully integrated design with zero cross contamination.

\*ePODS dispensing kit includes one rack, one dispenser and four MAXFLOW pitchers. Contact your local NAPA Representative to order the no cost ePods Dispenser.

\*1 Dispenser Per Shop



## STARTING AT \$99<sup>99</sup>

CAS 15AFB3	GTX® High Mileage Synthetic Blend Epod Motor Oil	5W30	5 gal.	\$99.99
CAS 15AFB4	GTX® High Mileage Synthetic Blend Epod Motor Oil	5W20	5 gal.	\$99.99
CAS 15AFB5	GTX® High Mileage Synthetic Blend Epod Motor Oil	10W30	5 gal.	\$99.99
CAS 15E6DC	GTX® Full Synthetic Epod Motor Oil	5W30	5 gal.	\$110.99
CAS 15E726	GTX® Full Synthetic Epod Motor Oil	0W20	5 gal.	\$110.99
CAS 15E72F	GTX® Full Synthetic Epod Motor Oil	5W20	5 gal.	\$110.99
CAS 15BA87	EDGE® Euro Car A3/B4 Full Synthetic Epod Motor Oil	0W40	5 gal.	\$140.99
CAS 15D939	EDGE® Euro Car A3/B4 Full Synthetic Epod Motor Oil	5W40	5 gal.	\$140.99
CAS 15E895	EDGE® Euro Car K Spec Full Synthetic Epod Motor Oil	5W30	5 gal.	\$140.99
CAS 15AFB7	EDGE® Full Synthetic Epod Motor Oil	0W20	5 gal.	\$140.99
CAS 15AFB8	EDGE® Full Synthetic Epod Motor Oil	5W20	5 gal.	\$140.99
CAS 15AFB9	EDGE® Full Synthetic Epod Motor Oil	5W30	5 gal.	\$140.99
CAS 15C86A	EDGE® Full Synthetic Epod Motor Oil	0W16	5 gal.	\$140.99
CAS 1606CB	EDGE® Euro LL Epod Motor Oil	0W30	5 gal.	\$140.99
CAS 1606CC	EDGE® Euro A3/B4 Epod Motor Oil	0W30	5 gal.	\$140.99
CAS 15B25D	EDGE® High Mileage Full Synthetic Epod Motor Oil	5W30	5 gal.	\$143.99

Ask your local sales rep about Castrol drums

### Castrol® GTX® Oil

**\$399**  
/each

#### GTX® Motor Oil

1 qt.  
CAS 122 20W50

**\$449**  
/each

1 qt.  
CAS 107 5W20  
CAS 082 5W30  
CAS 092 10W30  
CAS 112 10W40

**\$2199**  
/each

5 qt.  
CAS 091 5W20  
CAS 096 5W30  
CAS 093 10W30  
CAS 094 10W40  
CAS 095 20W50



**\$459**  
/each

#### GTX® High Mileage Motor Oil

1 qt.  
CAS 148 5W20  
CAS 440 5W30  
CAS 450 10W30  
CAS 460 10W40  
CAS 470 20W50

**\$2249**  
/each

5 qt.  
CAS 100 5W20  
CAS 102 5W30  
CAS 110 10W30  
CAS 111 10W40



**\$3879**  
/each

#### Castrol® TranSynd 668 Synthetic Transmission Fluid

1 gal.  
CAS 15E2E1



### Castrol® EDGE® Oil

**\$579**  
/each

#### EDGE® High Mileage Full Synthetic Motor Oil

1 qt.  
CAS 15D47C 0W20  
CAS 06122 5W20  
CAS 06129 10W30  
CAS 06171 10W40  
CAS 06128 5W30

**\$2849**  
/each

5 qt.  
CAS 15B0D2 0W20  
CAS 15906D 5W20  
CAS 15906E 5W30  
CAS 15906F 10W30



**\$579**  
/each

#### EDGE® Full Synthetic Motor Oil

1 qt.  
CAS 011 0W20  
CAS 15D32F 0W16  
CAS 247 5W20  
CAS 248 5W30  
CAS 250 5W50  
CAS 245 10W30  
CAS 246 10W40

**\$2849**  
/each

5 qt.  
CAS 3081 10W30  
CAS 083 5W20  
CAS 084 5W30  
CAS 3124 0W20



**\$639**  
/each

#### EDGE® Euro Advanced Full Synthetic Motor Oil - 1 qt.

CAS 249 5W40 A3/B4  
CAS 518 0W40 A3/B4  
CAS 15DAA6 0W30  
CAS 15F215 0W20  
CAS 15E892 5W30

**\$3099**  
/each

5 qt.  
CAS 15E891 5W30  
CAS 1606CD 0W30 A3/B4  
CAS 3101 0W40  
CAS 3247 5W40 A3/B4  
CAS 16107D 0W20  
CAS 161B1B EDGE 0W8 1 qt. \$6.19  
CAS 161B1C EDGE 0W8 5 qt. \$30.49  
CAS 16108A EDGE EURO 0W30LL 5 qt. \$30.99  
CAS 1610CD EDGE EURO CAR 0W20 M 5 gal. \$140.99

**\$639**  
/each

#### EDGE® Euro Car Full Synthetic Motor Oil

0W20  
1 qt.  
CAS 16107F





## Spring Forward & Save

### with Castrol® GTX® Full Synthetic

- 6X better wear protection\*
- 1.3X better sludge protection\*\*
- 3X stronger vs. the leading full synthetic†

Full synthetic formula provides thermal and oxidation stability plus a superior level of protection against viscosity breakdown. GM dexos™ Gen 3†† approved for 0W-20 and 5W-30.

\* than industry standards, as measured in the latest Sequence IVA test  
 \*\* on critical engine parts than industry standards, as measured in Sequence VH sludge test vs. API SQ limits  
 † against viscosity breakdown, based on Kurt Orbahn test in 5W-30 grade  
 †† Per GM Service Bulletin, vehicles factory filled with dexos™ 5W-20 oil are approved to substitute dexos™ 0W-20 oil as optional top off and service fill

**\$23.49** per 5 qt | **\$4.79** per 1 qt  
 Part #s 15E725, 15E72E, 15E6DE | Part #s 15E6E2, 15E72D, 15E728

Valid 4/1/26-4/30/26

castrol.com/us



**\$17<sup>59</sup>** /each  
**CRB® Multi Synthetic Blend Motor Oil**  
 1 gal.  
 15W40  
 CAS 155



**\$17<sup>59</sup>** /each  
**GTX® Diesel CK-4 Motor Oil**  
 1 gal.  
 15W40  
 CAS 849



**\$21<sup>39</sup>** /each  
**Vecton Part Synthetic CK-4 Motor Oil**  
 1 gal.  
 15W40  
 CAS 156



**\$175<sup>99</sup>** /each  
**Castrol® TranSynd 668 Synthetic Transmission Fluid**  
 5 gal.  
 CAS 15E2E0



**\$1,876<sup>99</sup>** /each  
**Castrol® TranSynd 668 Synthetic Transmission Fluid**  
 55 gal.  
 CAS 15E2ZF



# OIL & FLUIDS

Q2 INSTALLER INCENTIVE

ACTUAL PRODUCT MAY VARY



**ROYAL PURPLE**  
SYNTHETIC OIL

**LOAD UP.  
ROLL OUT.**

**ROYAL PURPLE® INSTALLERS GET A FREE ROYAL PURPLE FOLDABLE HEAVY DUTY UTILITY CART**

PROMOTION DATES | APRIL 1 – JUNE 30, 2026

### HOW THE PROMOTION WORKS

Get a Royal Purple Foldable Heavy Duty Utility Cart when you purchase 15 cases or more, or an equivalent volume in alternative packages, of any Royal Purple lubricant or grease product(s) during the promotion period (excludes chemicals). See terms and conditions for additional details.

### HOW TO GET YOUR FOLDABLE UTILITY CART

- Filing a claim is easy. Just take a photo or scan of the invoice clearly documenting your qualifying 15 case purchase during the Promotion Period. 15 case purchase must be made on single invoice.
- Go to: [Installer.RoyalPurplePromos.com](http://Installer.RoyalPurplePromos.com). Fill in the required information on the online claim form. Upload a scan or photo of your invoice.
- Click Submit.
- Your claim will be validated and processed, and your Foldable Heavy Duty Utility Cart will be automatically shipped to the address provided in the online claim form within 4 weeks of submission.

Claim deadline: July 15, 2026

ALL PROGRAM DETAILS SUBJECT TO CHANGE

**\$899**  
/each

**High Performance Full Synthetic Motor Oil**  
1 qt.

RPO 01016	0W16
RPO 01020	0W20
RPO 11484	SAE 0W40
RPO 01520	5W20
RPO 01530	5W30
RPO 01540	5W40
RPO 01130	10W30

**\$3699**  
each

5 qt.

RPO 51016	0W16
RPO 51020	0W20
RPO 51520	5W20
RPO 51530	5W30
RPO 51130	10W30

**\$18000**  
each

6 gal.

RPO 60016	0W16
RPO 60020	0W20
RPO 60520	5W20
RPO 60530	5W30



**\$1466**  
/each

**Max ATF Automatic Transmission Fluid**  
1 qt.

RPO 01320

**\$25805**  
each

**Max ATF Bag in Box**

6 gal.

RPO 61320



**\$1549**  
/each

**Synchromax Manual Transmission Fluid**

1 qt.

RPO 01512



STARTING AT

**\$1599**  
/each

**Max-Gear Oil**

1 qt.

RPO 01300 75W90 **\$15.99**

RPO 01301 75W140 **\$17.99**



**\$2999**  
/each

**Duralec® Super™ Diesel Motor Oil**

1 gal.

RPO 83540 5W40

RPO 04154 15W40

**\$18900**  
/each

6 gal.

RPO 86540 5W40

RPO 60154 15W40



**\$3199**  
/each

**Duralec® Ultra Diesel Motor Oil**

1 gal

RPO 83456 10W30

RPO 83561 15W40



**\$19900**  
/each

**High Performance Euro Formula Synthetic Motor Oil**

6 gal.

RPO 60040 0W40

RPO 60540 5W40





## PROVEN ON THE RACETRACK.

### UNLEASHED ON THE STREETS.

**Top Tec 6600 SAE 0W-20**  
5 l, Part no. LM 22046

**Top Tec 6200 SAE 0W-20**  
5 l, Part no. LM 20238



**SAVE UP TO 56%**



AIC 30040093750	ATF Type TLS (T-IV) Auto Trans Fluid for Toyota/Lexus/Scion	1 qt.	\$5.47	AIC 30041113750	Automatic Transmission Fluid CVTF TYPE-SB2	1 qt.	\$9.88
AIC 30040099750	ATF Type HP Automatic Transmission Fluid for Subaru	1 qt.	\$5.66	AIC 30040093953	ATF Type TLS (T-IV) Auto Trans Fluid for Toyota/Lexus/Scion	5 qt.	\$28.05
AIC 30040097750	ATF Type HK (SP-III) Automatic Trans. Fluid for Hyundai/Kia	1 qt.	\$6.09	AIC 30040096953	ATF Type TLS-LV (WS) Auto.Trans.Fluid for Toyota/Lexus Scion	5 qt.	\$30.26
AIC 30040096750	ATF Type TLS-LV (WS) Auto.Trans.Fluid for Toyota, Lexus,Scion	1 qt.	\$6.40	AIC 30040099953	ATF Type HP Automatic Transmission Fluid for Subaru	5 qt.	\$34.04
AIC 30040090750	ATF Type H-Plus Automatic Transmission Fluid for Honda, Acura	1 qt.	\$6.71	AIC 30040090953	ATF Type H-Plus Automatic Transmission Fluid for Honda/Acura	5 qt.	\$36.40
AIC 30040092750	ATF Type M (M3/M5) Automatic Transmission Fluid for Ford/Mazda	1 qt.	\$7.19	AIC 30040101953	ATF Type S Automatic Transmission Fluid for Nissan Matic S/J/D	5 qt.	\$36.75
AIC 30040091750	CVT Type N (NS-2) Transmission Fluid for Nissan	1 qt.	\$7.23	AIC 30040091953	CVT Type N (NS-2) Transmission Fluid for Nissan	5 qt.	\$37.89
AIC 30040100750	ATF Type HK4 Automatic Transmission Fluid for Hyundai/Kia	1 qt.	\$7.49	AIC 30040097953	ATF Type HK (SP-III) Automatic Trans. Fluid for Hyundai/Kia	5 qt.	\$38.58
AIC 30040101750	ATF Type S Automatic Transmission Fluid for Nissan Matic S/J/D	1 qt.	\$8.24	AIC LM2332	Liqui Moly Special Tec LL 5W30 Motor Oil	5 qt.	\$38.86
AIC 30041114750	Automatic Transmission Fluid CVTF TYPE-H2	1 qt.	\$9.33	AIC LM2249	Liqui Moly Leichlauf High Tech 5W40 Motor Oil	5 qt.	\$40.81
AIC 30041102750	CVT Type N3 Transmission Fluid for Nissan	1 qt.	\$9.63	AIC 30041114953	Automatic Transmission Fluid CVTF TYPE-H2	5 qt.	\$44.32
AIC 30041103750	CVT Type TLS FE Transmission Fluid for Toyota CVTS	1 qt.	\$9.88	AIC 30041113953	Automatic Transmission Fluid CVTF TYPE-SB2	5 qt.	\$47.10

## NAPA® DIESEL EXHAUST FLUID (DEF) UP TO 36% OFF



DEF ISO 22241



**NAPA DEF 2.5 GALLON  
NAF NPF002  
\$12.99**



**NAPA DEF 55 GALLON  
NAF NPF001  
\$229.92**

### STOCK UP, VOLUME BUY



**NAPA DEF 330 GALLON  
NAF NPF330  
\$1,349.58**

**Mobil Delvac™** **100™**  
YEARS - SINCE 1925

## EXTREME PROTECTION FOR DIESEL ENGINES.

- » Superior performance in extreme conditions and extended ODI service
- » Greater engine efficiency, long engine life, and long oil life
- » Lower oil costs due to less makeup oil during operation

Mobil Delvac Extreme 10W-30	122454	<b>\$20.99</b>
Mobil Delvac Extreme 15W-40	122448	<b>\$20.99</b>



© 2026 ExxonMobil. All trademarks used herein are trademarks or registered trademarks of ExxonMobil Corporation or one of its subsidiaries unless indicated otherwise. Other trademarks shown are property of their respective owners. All rights reserved.



## RAIN-X® WIPER BLADES

SAVE UP TO 58%

### Rain-X® Latitude Water Repellency Wiper Blade

RNX 50792722	14 in.	\$15.49
RNX 50792742	16 in.	\$15.49
RNX 50792752	18 in.	\$15.49
RNX 50792762	19 in.	\$15.49
RNX 50792772	20 in.	\$15.49
RNX 50792782	21 in.	\$15.49
RNX 50792792	22 in.	\$15.49
RNX 50792802	24 in.	\$15.49
RNX 50792812	26 in.	\$15.49
RNX 50792822	28 in.	\$15.49
RNX 50792832	17 in.	\$15.49
RNX 50792732	15 in.	\$15.99

### Rain-X® Vision Blade

RNX 810016	16 in.	\$13.49
RNX 810017	17 in.	\$13.49
RNX 810018	18 in.	\$13.49
RNX 810019	19 in.	\$13.49
RNX 810020	20 in.	\$13.49
RNX 810021	21 in.	\$13.49
RNX 810022	22 in.	\$13.49
RNX 810024	24 in.	\$13.49
RNX 810026	26 in.	\$13.49
RNX 810028	28 in.	\$13.49

### Rain-X® Silicone AdvantEdge® Wiper Blade

RNX 830014	14 in.	\$25.49
RNX 830016	16 in.	\$25.49
RNX 830017	17 in.	\$25.49
RNX 830018	18 in.	\$25.49
RNX 830019	19 in.	\$25.49
RNX 830020	20 in.	\$25.49
RNX 830021	21 in.	\$25.49
RNX 830022	22 in.	\$25.49
RNX 830024	24 in.	\$25.49
RNX 830026	26 in.	\$25.49
RNX 830028	28 in.	\$25.49

### Rain-X® Truck & SUV Beam Style Wiper Blade

RNX 870116	16 in.	\$25.49
RNX 870118	18 in.	\$25.49
RNX 870119	19 in.	\$25.49
RNX 870120	20 in.	\$25.49
RNX 870126	26 in.	\$25.49
RNX 870121	21 in.	\$25.49
RNX 870122	22 in.	\$25.49
RNX 870124	24 in.	\$25.49





## LUG NUT PROGRAM



Meets and exceeds OEM and Aftermarket standards. Cold Forged provides increased strength. Triple nickel plating prevents rust and corrosion. Certified ISO and QS factories. Assortment Mix Covers 95% of current vehicles on the road.



**White Knight Lug Nuts -  
Quality, Performance, and Value You Can Count On.**

# TOW LIKE A PRO SAVE 10%

@FirestoneAiride

WITH  
**Firestone**  
AIRIDE





Firestone Airide™ Helper Springs are engineered to maximize the safe load-carrying capacity of most trucks, motor homes, SUVs, CUVs, and vans. When paired with Air Command™ single or dual-path wireless controls, Firestone Airide delivers a complete towing and hauling solution.

All trademarks are the property of their respective owners. © 2026 Firestone Airide, a division of Firestone Industrial Products Company, LLC

**NOT JUST PARTS.  
PART OF SOMETHING BIGGER.**



-  100+ years of service
-  50+ iconic brands
-  +1,200 parts available on ProLink



# THERMAL KNOW HOW

SAVE UP TO 10%



Thermo-Tec gives NAPA customers the edge with pro-grade heat control that keeps your ride running stronger, longer. From wraps to shields, Thermo-Tec products are proven, durable, and ready for anything your build throws at them.



EXHAUST WRAP KIT

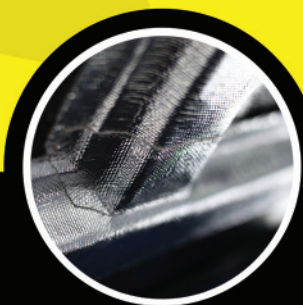

THERMO-SHIELD



THERMO-SLEEVE



HEAT BARRIER

GET THERMO-TEC PRODUCTS NOW AT [PRO.NAPAPROLINK.COM](http://PRO.NAPAPROLINK.COM)



# ACCESSORIES



SAVE UP TO **10%**

STARTING AT  
**\$8.56**  
/each



NCB <b>G16402</b>	Air Refresher-New Car	2 oz.	<b>\$8.56</b>
NCB <b>G181302</b>	Whole Car Air Refresher-Black Chrome	2 oz.	<b>\$8.56</b>

# TOOLS & EQUIPMENT



SAVE UP TO **24%**



BK <b>7631304</b>	Gr/Mnky Grl/Grp Glove	<b>\$13.99</b>	BK <b>7631349</b>	Latex Coated Reusable Gloves - 14 pairs Large	<b>\$19.79</b>
BK <b>7631345</b>	Gorilla Grip 6pk- L	<b>\$14.69</b>	BK <b>7631350</b>	Nitrile Coated Reusable Gloves - 14 pairs Larg	<b>\$20.29</b>
BK <b>7631346</b>	Gorilla Grip 6pk - XL	<b>\$14.69</b>			

# Homak® WHOLESALE DEALS



**\$1,149**

**35" RS Pro 7 Drawer Flip Top Service Cart**

- TSS BK06035247 Midnight Black
- TSS BL06035247 Rally Sport Blue
- TSS RD06035247 Fury Red
- TSS LG06035247 Monster Green
- TSS OG06035247 Competition Orange
- TSS BC06035247 Black Cherry
- TSS GR06035247 Battleship Gray
- TSS WH06035247 Polar White



**\$7,998**

**120" CTS 16 Drawer Solid Back Splash**

- TSS BKCTS12001 Midnight Black
- TSS BLCTS12001 Rally Sport Blue
- TSS RDCTS12001 Fury Red



**\$7,998**

**120" CTS 16 Drawer Toolboard Back Splash**

- TSS BKCTS12002 Midnight Black
- TSS BLCTS12002 Rally Sport Blue
- TSS RDCTS12002 Fury Red



**\$1,999**

**54" RS Pro 10 Drawer Roller Cabinet w/ Stainless Steel Top 24" Depth**

- TSS BK04054014 Midnight Black
- TSS BL04054014 Rally Sport Blue
- TSS RD04054014 Fury Red
- TSS LG04054014 Monster Green
- TSS OG04054014 Competition Orange



**\$2,699**

**72" RS Pro 16 Drawer Roller Cabinet w/ Stainless Steel Top 24" Depth**

- TSS BK04072164 Midnight Black
- TSS BL04072164 Rally Sport Blue
- TSS RD04072164 Fury Red
- TSS LG04072164 Monster Green
- TSS OG04072164 Competition Orange

# TOOLS & EQUIPMENT

**Forney**  
WELDING AND METALWORKING

SAVE  
UP TO  
**40%**



FNY 20051	8 Percent Cobalt Drill Bit	\$7.96
FNY 20059	8 Percent Cobalt Drill Bit	\$17.40
FNY 20858	Tap Magic Cutting Fluid - 16 oz.	\$24.52
FNY 20067	8 Percent Cobalt Drill Bit	\$29.89
FNY 42287	Er70s-6 MIG Wire	\$44.79
FNY 60153	Carbide Burr Set	\$74.99
FNY 60152	Carbide Burr Set	\$140.59

**\$29<sup>99</sup>**  
/each

**Light-N-Carry 120 Max  
Lumen LED Pen Light**  
SOR LNC312



**\$69<sup>99</sup>**  
/each

**Light-N-Carry 750 Max  
Lumen LED Torch Light**  
SOR LNC375



**\$79<sup>99</sup>**  
/each

**CHARGE IT!® 20/10/2 Amp  
12 Volt Battery Charger**  
SOR 4520



**\$185<sup>00</sup>**  
/each

**Jump-N-Carry 1700 Peak  
Amp 12 Volt Jump Starter**  
SOR JNC660



**\$195<sup>00</sup>**  
/each

**CHARGE IT! 40/20/5/200A 12  
Volt Wheeled Battery Charger**  
SOR 4735



**\$199<sup>00</sup>**  
/each

**Jump-N-Carry JNC325  
2000 Amp 12V Lithium  
Jump Starter**  
SOR JNC325



**\$245<sup>00</sup>**  
/each

**SOLAR 12 Volt  
Digital Battery &  
System Tester  
W/ Printer**  
SOR BA227

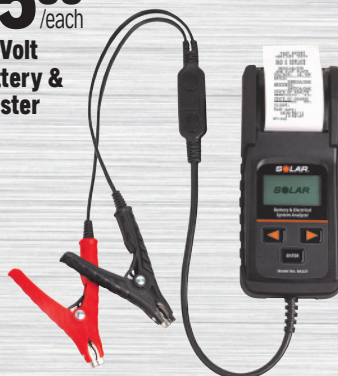

**\$275<sup>00</sup>**  
/each

**Jump-N-Carry  
JNC345 3000 Amp  
12V Lithium  
Jump Starter**  
SOR JNC345



### CHT CSWTP9

**\$69<sup>99</sup>**

#### CARLYLE 9 IN. WIRE TWISTING PLIERS

- Forged from heat-treated steel with durable S2 alloy
- Low-profile design with a 15° offset angle
- High-polish chrome finish
- Includes the most popular star sizes



### CHT CCBC1224V10A

**\$160<sup>00</sup>**

#### 12/24V CHARGER

- Advanced, microprocessor-controlled charging
- Compatible with a variety of battery types, including flooded, AGM, spiral wound, deep cycle, and marine.
- Power Supply Mode provides 0-60A output
- Fully automatic functionality
- Temperature compensation



### CHT CCWC12V40A

**\$435<sup>00</sup>**

#### 12V WHEELED CHARGER

- Advanced, microprocessor controlled charging 24V, 20/10A Charge
- Versatile battery compatibility
- Engine Start Assist mode for 12V systems
- Power Supply Mode offers 0-60A output (12V and 24V models available)
- Fully automatic charging
- Temperature compensation



# PAINT & BODY



## 3M Hookit™ Flexible Foam Abrasives

A highly flexible foam backed abrasive which conforms to irregular surfaces.

Now available at NAPA

**\$24<sup>05</sup>** **\$36<sup>08</sup>** **\$43<sup>29</sup>** **\$48<sup>10</sup>**

Grit	5.5 in x 6.8 in 10 Sheets/Carton	3" Discs 20 Discs/Carton	5" Discs 20 Discs/Carton	6" Discs 20 Discs/Carton
400	33531	33557	33555	33538
600	33532	33558	33556	33539
800	33533	33550	33545	33540
1000	33534	33551	33546	33541
1200	33535	33552	33547	33542
1500	33536	33553	33548	33543
2000	33537	33554	33549	33544

**\$35<sup>45</sup>** **\$79<sup>75</sup>** **\$62<sup>10</sup>** **\$40<sup>92</sup>**

Grit	8" Disc 25 Discs/Carton	6" Disc 100 Discs/Roll	5" Disc 100 Discs/Roll	3" Discs 100 Discs/Roll
80	36411	36420	36435	36449
120	36412	36421	36436	36450
150	36413	36422	36437	36451
180	36414	36423	36438	36452
220	36415	36424	36439	36453
240	36416	36425	36440	36454
320	36417	36426	36441	36455

## 3M™ Blue Net Abrasives

Deliver superior dust extraction and outstanding performance at an affordable price for the value focused pros.



## 3M™ Clean Sanding System

Designed with technicians and shop owners in mind.

Tailor your mobile workstation for a more efficient sanding experience with the 3M Clean Sanding System. A complete sanding solution from surface preparation to your finishing work.

- Designed to reduce dust in the air from sanding for a cleaner workspace.
- Helps shops boost productivity and efficiency by helping to reduce rework and cleanup time.
- Compact and mobile. Designed for easy, flexible use around the shop.
- Compatible with pneumatic and/or electric sanders.
- Tech-friendly design including auto on/off, antistatic hose, rubber wheels, brake locks, and LED indicator lights

\*all parts sold separately disclaimer here



**\$1,140<sup>99</sup>** /each

**3M™ 3MDust Extractor**  
**120V, 45 Liter**  
MMM 33774



**\$264<sup>99</sup>** /each

**3M™ Pneumatic Precision Random Orbital Sander, 6 in**

- MMM 33632 3/32" Orbit
- MMM 33633 3/32" Orbit
- MMM 33634 5/16" Orbit



**\$299<sup>99</sup>** /each

**3M™ Antistatic Pneumatic Hose, 8 m**  
MMM 33783



**\$504<sup>99</sup>** /each

**3M™ Electric Random Orbital Sander, 6in**  
MMM 33779



# PAINT & BODY

**\$4<sup>99</sup>**  
/each

**Bondo® Cream Hardener**  
2.75 oz.  
MMM 928



**STARTING AT**  
**\$1<sup>29</sup>**  
/each

**Scotch-Brite™ Hand Pads, 6in X 9in**  
20 / Carton

MMM 07447	\$1.29
MMM 07448	\$1.29
MMM 07445	\$1.49



**\$2<sup>99</sup>**

**Fastline Spreader Pack**  
MS FSA2



**\$23<sup>99</sup>**

**USC Special Lite Body Filler**  
1 gal.  
MS 15310601



**\$46<sup>99</sup>**

**3M™ Lightweight Body Filler**  
1 gal.  
MMM 05801



**\$92<sup>99</sup>**

**3M™ Platinum Plus Filler**  
1 gal.  
MMM 01131



**\$69<sup>99</sup>**  
/each

**Pro Strand SS Body Filler**  
1 gal.  
MS GAL1013



**\$93<sup>99</sup>**  
/each

**Pro Strand XL LS Body Filler**  
1 gal.  
MS GAL1014



**665-5301**

**NEW OEM Coverage**  
**Fast Choice**



**8 DRAWER | 399-1202**  
**BACKROOM**  
**MERCHANDISER**

Includes:

Eight pre-loaded drawers  
Two 4-Drawer metal slider cabinets | NW 770226  
One metal base | NW 770228



Save 10% on all NAPA Body Hardware Bagged Products

Scan the QR code for a full list of items offered at **10% off**



Scan with any smart phone camera

# ULTRA-PREMIUM BRAKE PADS

## For Your Prius Now Available at NAPA



**akebono**  
BRAKE EXPERTS

\*\*\* PROUDLY MADE IN THE USA \*\*\*

FACTORY INSTALLED  
**400+**  
MODELS  
OEM BRAND OF CHOICE



## Trusted by OEMs Worldwide, Akebono Braking Technology

Whether cruising on the open roadways or in congested traffic, vehicles across America rely on the braking performance of Akebono ProACT® Ultra-Premium Ceramic Brake Pads.

- Ultra clean, quiet and smooth
- Lasts up to 40% longer
- Trusted by professionals
- Rotor-friendly formulations
- Vehicle-optimized ceramic formulas
- Superior quality and longevity



AKE ACT1001



AKE ACT1053

# REPLACEMENT PARTS



## INSTALL WITH CONFIDENCE. PROTECT YOUR ENGINE.

Avoid the 6 Leading Causes of Premature Engine Failure  
Every engine we build undergoes rigorous quality-control testing and must meet exacting performance standards before it leaves our facility. Help ensure long life and avoid warranty issues by preventing the most common installation errors:

### 1. DRY START — #1 Immediate Failure Cause

Always pre-lubricate before starting a newly installed engine.

### 2. OVERHEATING

Use manufacturer-specified coolant. Inspect the entire cooling system: radiator, fan, thermostat, hoses, belts.

### 3. TRANSFERRING FAULTY PARTS

Do not reuse worn or damaged components. Your new engine depends on properly functioning subsystems.

### 4. EXCESSIVE VIBRATION

Replace engine and transmission mounts to prevent destructive vibration.

### 5. INCORRECT OPERATING PARAMETERS

Use a full engine scanner—not a code reader—to synchronize ignition and fuel systems after installation.

### 6. FOREIGN DEBRIS INGESTION

Provide clean air, fuel, and oil. Dirt or debris will cause long-term engine damage.



## INSTALLERS: Get the Guide & Break-In Procedures

Visit [www.mycarcare.com](http://www.mycarcare.com) for step-by-step installation tips and engine break-in instructions.

## UPGRADE YOUR COVERAGE WITH THE GSA1 WARRANTY

The NAPA® Ironclad Gold Seal Service Agreement is a premium supplement to the NAPA® Ironclad Standard and No-Fault warranties. Must be purchased at the same time as the engine unit. Contact your ASM for details.

## BOOST YOUR SALES WITH TURBO HOSES



NAPA Belts and Hose has solutions to keep your customers' light and heavy duty turbocharged engines operating at peak efficiency for years to come. Molded Turbocharger Hoses and Turbocharger Hose Kits are available for all popular applications and meet or exceed OE standards in fit, form, and function.

**Buy \$300 in NAPA Turbocharger Hose (NBH Group Code 41) and Receive a \$25 Prepaid Visa® Card\***  
**Promotional Dates: April 1 – 30th, 2026**

Only NAPA Installer Rewards members and Auto Care Centers are eligible. Contact your local NAPA AUTO PARTS store to enroll in the 2026 NAPA Installer Rewards program.

Purchases will be tracked by NAPA HQ and no submissions will be required. Prepaid Visa® Cards\* will be issued by IS Results and mailed within 10-12 weeks after the promotion has ended. There is no limit to the amount of Prepaid Visa® Cards that can be earned. For more details, speak to your NAPA Representative.

\*This Card is issued by Sunrise Banks N.A., St. Paul, MN 55103, Member FDIC, pursuant to a license from Visa U.S.A. Inc. This card may be used everywhere Visa debit cards are accepted. Use of this card constitutes acceptance of the terms and conditions stated in the Cardholder Agreement. Card expires 12 months from issuance, per the "Valid Thru" date printed on the card.



**Intake Plenum Gasket Set**  
 FPG MS97205

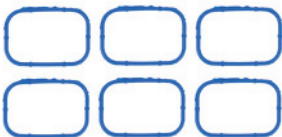

**Valve Cover Gasket Set**  
 FPG VS50504R1

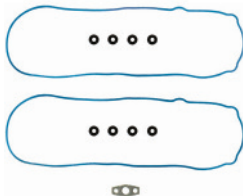

**Oil Pan Gasket Set**  
 FPG OS30693R



**PermaDryPlus Oil Pan Gasket**  
 FPG OS30953T

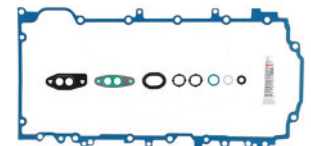

## ADVANCED ABS SENSORS FOR TODAY'S VEHICLES



**ECHLIN®**

## ABS Sensors surging in popularity

These SKUs are seeing strong sales growth

Part No.	Application	US VIO	Position
531158	GM Trucks, Vans & SUVs (2014-99)	1.8M	Front
532831	Ford / Lincoln Cars & SUVs (2019-12)	2.2M	Rear
532391	Dodge / Jeep SUVs (2018-07)	1.9M	Rear
531924	GM Trucks & SUVs (2014-07)	4M	Front
533663	Kia SUVs (2019-14)	573K	Rear
532701	Ford / Volvo Cars & SUVs (2023-02)	3.9M	Front
532830	Ford / Lincoln Cars, Vans & SUVs (2023-12)	661K	Rear
533448	GM Trucks & SUVs (2007-99)	2.1M	Front
533064	Ford Vans (2019-15)	638K	Front
533002	GM Trucks & SUVs (2020-14)	4.2M	Front

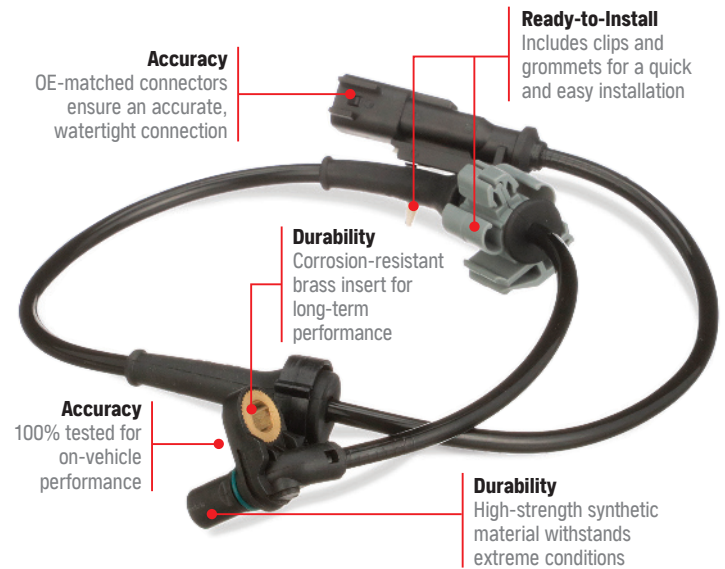

**533002**  
GM Trucks & SUVs (2020-14)

**LOOKS RIGHT. FITS RIGHT. PERFORMS RIGHT.**

[NAPAEchlin.com](http://NAPAEchlin.com)



Purchase \$250 or more of Echlin® ABS Sensors and/or Electronic Parking Brake Actuators on PROLINK and get a **\$25 Prepaid Visa® Card\***

April 1-30, 2026. Limit one redemption per installer.  
NAPA® Echlin® Group Codes: UP 16, ECH EPA Prefix-Part Numbers



\* Card is issued by Sunrise Banks N.A., St. Paul, MN 55103, Member FDIC, pursuant to a license from Visa U.S.A. Inc. This card may be used everywhere Visa debit cards are accepted. Use of this card constitutes acceptance of the terms and conditions stated in the Cardholder Agreement. Card expires 12 months from issuance, per the "Valid Thru" date printed on the card.