

1365 PLATTSVILLE

ONTARIO, CANADA

HERITAGE RESTORATIONS

SALES & PRICING

CONTACT - MATTHEW BRANDSTADT 254-230-6900 (MATTB@HERITAGEBARN.S.COM)

CONTACT - CALEB TITILEY 254-716-1013 (CALEB@HERITAGEBARN.S.COM)

CONSTRUCTION & DESIGN

CONTACT - ZAIN DUMONT 254-717-5952 (ZAIN@HERITAGEBARN.S.COM)

CONTACT - JOHN KLINGENSMITH 254-716-9547 (JOHNK@HERITAGEBARN.S.COM)

DRAWING INDEX:

- CS COVER SHEET
- B100 LEVEL 01 FLOOR PLAN
- B300 BENT A ELEVATION
- B301 BENT B ELEVATION
- B302 BENT C ELEVATION
- B303 BENT C ELEVATION
(OPPOSITE FROM INDEX FACE)
- B304 BENT D ELEVATION
- B305 SIDEWALL 01 ELEVATION
- B306 SIDEWALL 02 ELEVATION
- B500 TIMBER DETAILS
- B501 JOINERY DETAILS
- B502 JOINERY ISOMETRIC

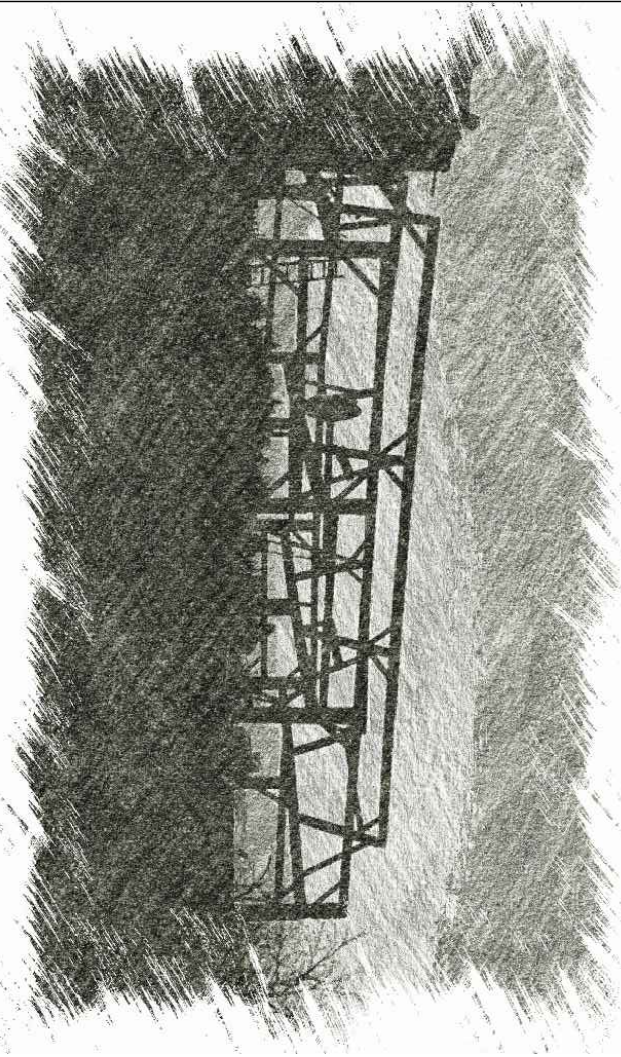

REV.	REVISION DESCRIPTION	DATE

REVISION
01

DATE
18/02/22

DETAILS
CS

DATE
18/02/22

DETAILS
CS

1365 PLATTSVILLE
ONTARIO, CANADA



LEVEL 01 FLOOR PLAN

SCALE: 7/64" = 1'

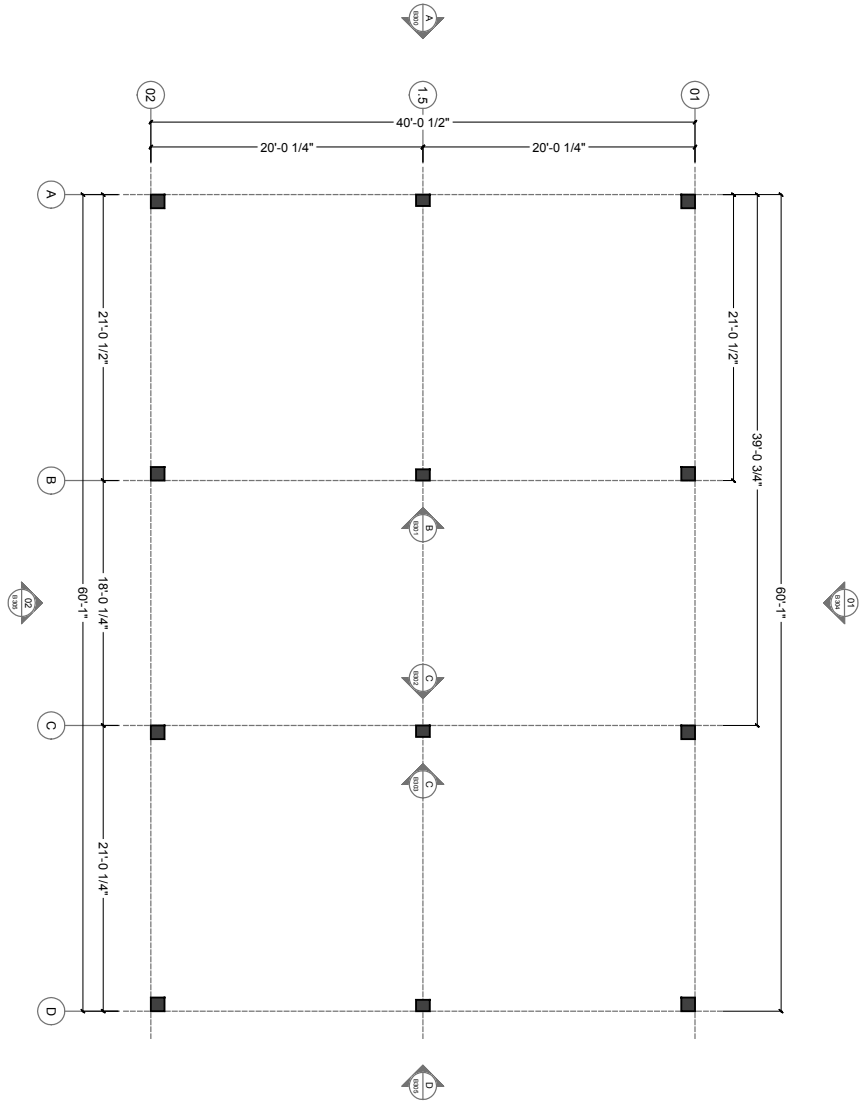

PLANS
B100
DATE: 18/02/04
DESIGNED BY: JMK
DRAWN BY: JMK

REVISION	01
----------	----

REV.	REVISION DESCRIPTION	DATE

1365 PLATTSVILLE
ONTARIO, CANADA

Heritage RESTORATIONS

317 FORT GRAHAM RD. OFF: 334-839-1170
WINDO, ON, N0G 1W0 FAX: 334-839-1184
www.HERITAGEBARNs.com

BENT A ELEVATION

SCALE: 3/16" = 1'

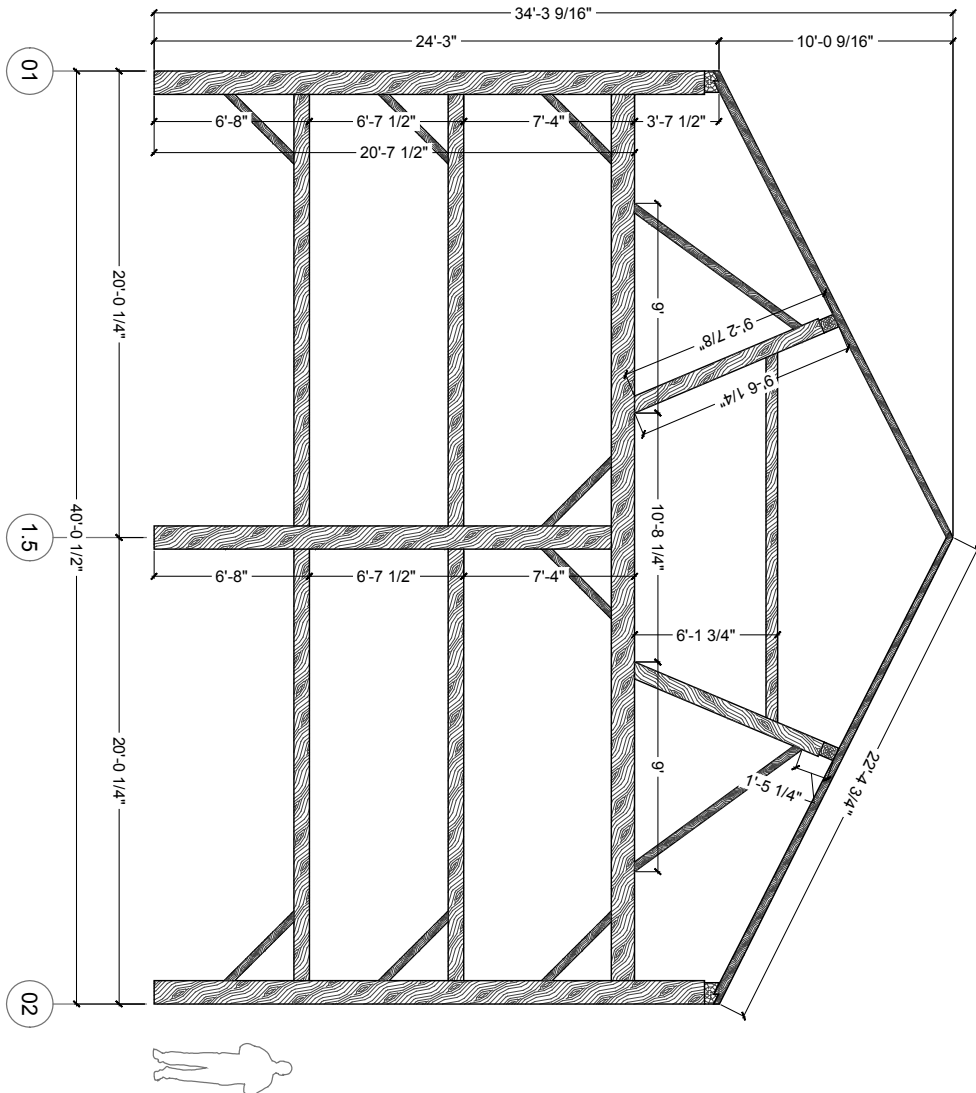

DATE	18/02/04
REVISION	01
ELEVATIONS	B200
DESIGNED BY	JMK
DRAWN BY	JMK

REV.	REVISION DESCRIPTION	DATE

1365 PLATTSVILLE
ONTARIO, CANADA

Heritage RESTORATIONS

317 FORT GRAHAM RD. OFF. 334 819-1170
WINDO, ON N0G 1W0 FAX: 334 819-1184
www.HERITAGEBARNs.com

BENT B ELEVATION

SCALE: 3/16" = 1'

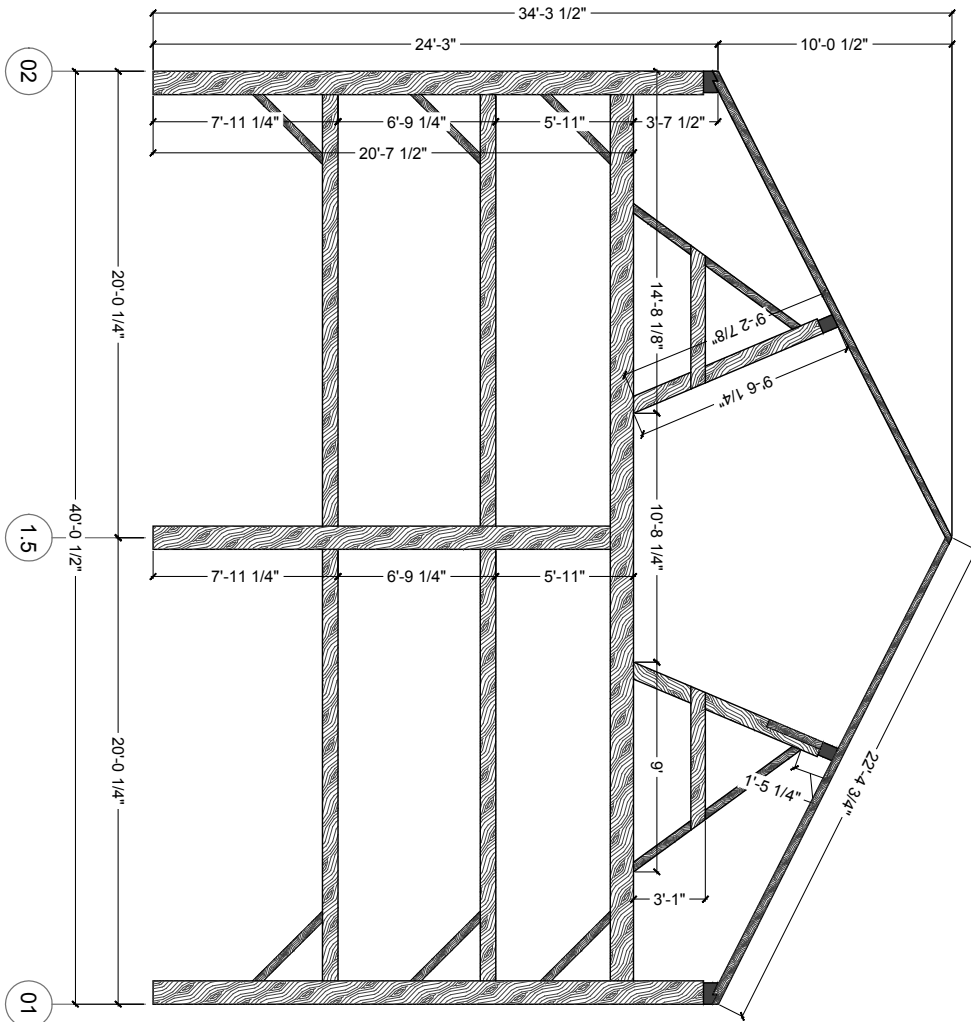

DATE	18/02/04
DRAWN BY	JMK
CHECKED BY	JMK
DESIGNED BY	JMK
B201	
SHEET TITLE	

REV	REVISION DESCRIPTION	DATE

01	ELEVATIONS
----	------------

1365 PLATTSVILLE
ONTARIO, CANADA

Heritage RESTORATIONS

317 FORT GRAHAM RD. OFF: 334-839-1170
WINDO, ON N0G 1W0 FAX: 334-839-1184
www.HERITAGEBARNs.com

BENT C ELEVATION

SCALE: 3/16" = 1'

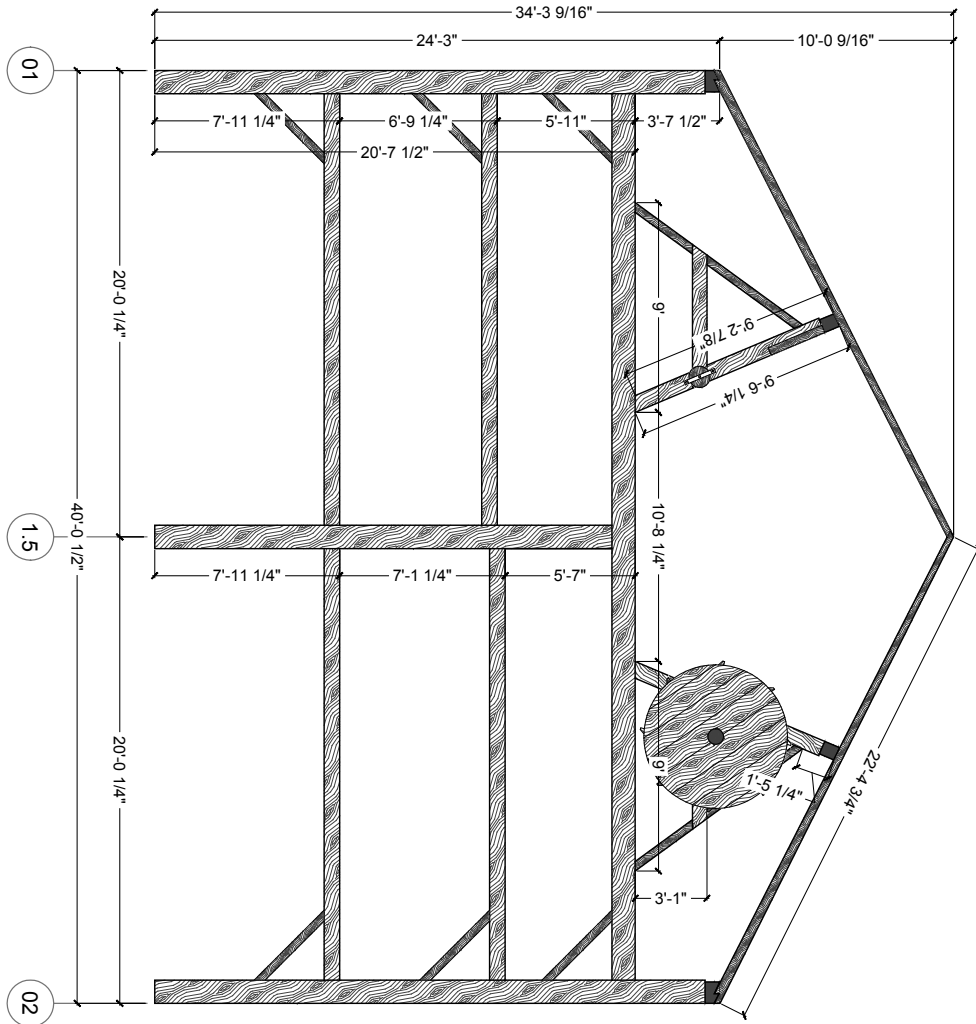

DATE	18/02/04
REVISION	01
ELEVATIONS	B202
DATE	18/02/04

REV.	REVISION DESCRIPTION	DATE

1365 PLATTSVILLE
ONTARIO, CANADA

Heritage RESTORATIONS

317 FORT GRAHAM RD. DR# 334 B3P-1170
WINDO, ON N0G1
416-234-8100-1184
www.HERITAGEBARNs.com

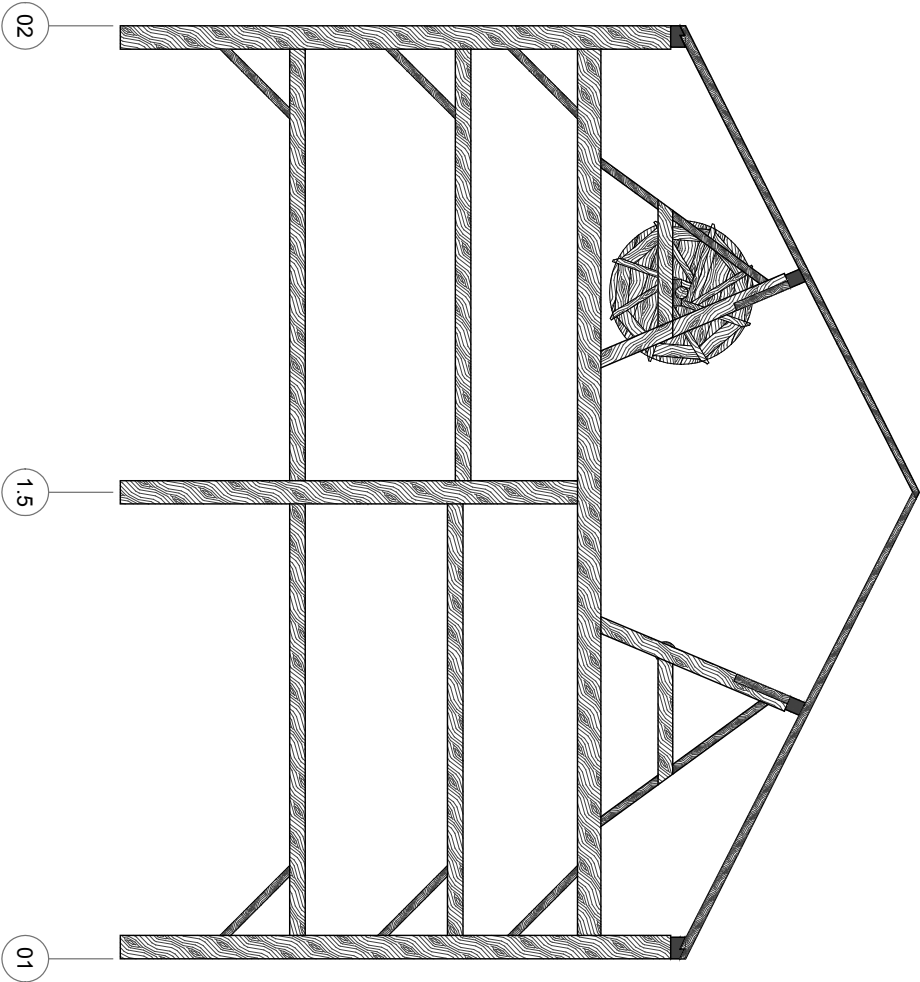

BENT C ELEVATION (OPPOSITE FROM INDEX FACE)

SCALE: 3/16" = 1'

DATE	18/02/04
REVISION	01
ELEVATIONS	B203
DATE	JAN
BY	JMK

REV.	REVISION DESCRIPTION	DATE

1365 PLATTSVILLE
ONTARIO, CANADA

Heritage RESTORATIONS

327 FORT GRAHAM RD. OFF: 334-839-1170
WINDO, ON L0R 1R0 FAX: 334-830-1244
www.HERITAGEBARNs.com

BENT D ELEVATION

SCALE: 3/16" = 1'

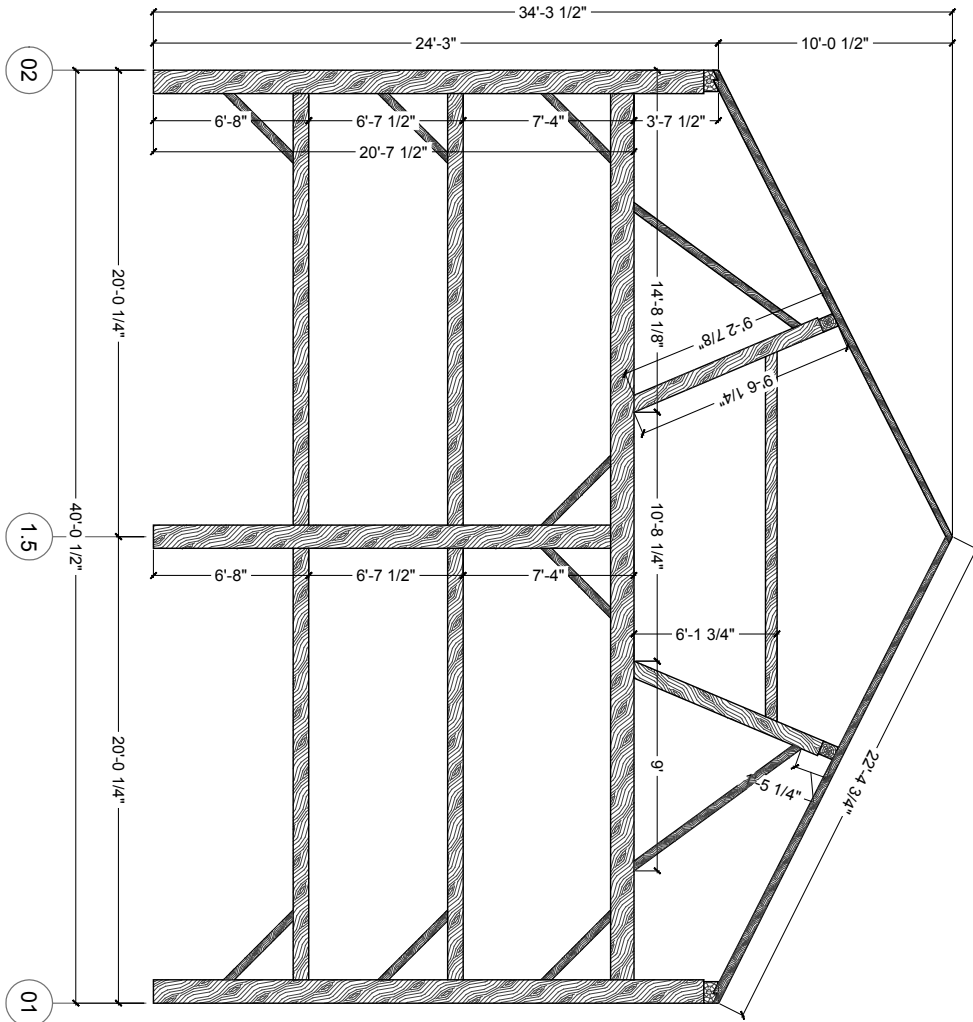

DATE	18/02/04
BY	JMK
CHECKED	
APPROVED	

REVISION	01
DESCRIPTION	

REV.	REVISION DESCRIPTION	DATE

1365 PLATTSVILLE
ONTARIO, CANADA

Heritage RESTORATIONS

317 FORT GRAHAM RD. OFF. 334 839-1170
WINDO, ON N0G1N0 FAX: 334 839-1184
www.HERITAGEBARNs.com

SIDEWALL AT GRID LINE 01 ELEVATION

SCALE: 3/16" = 1'

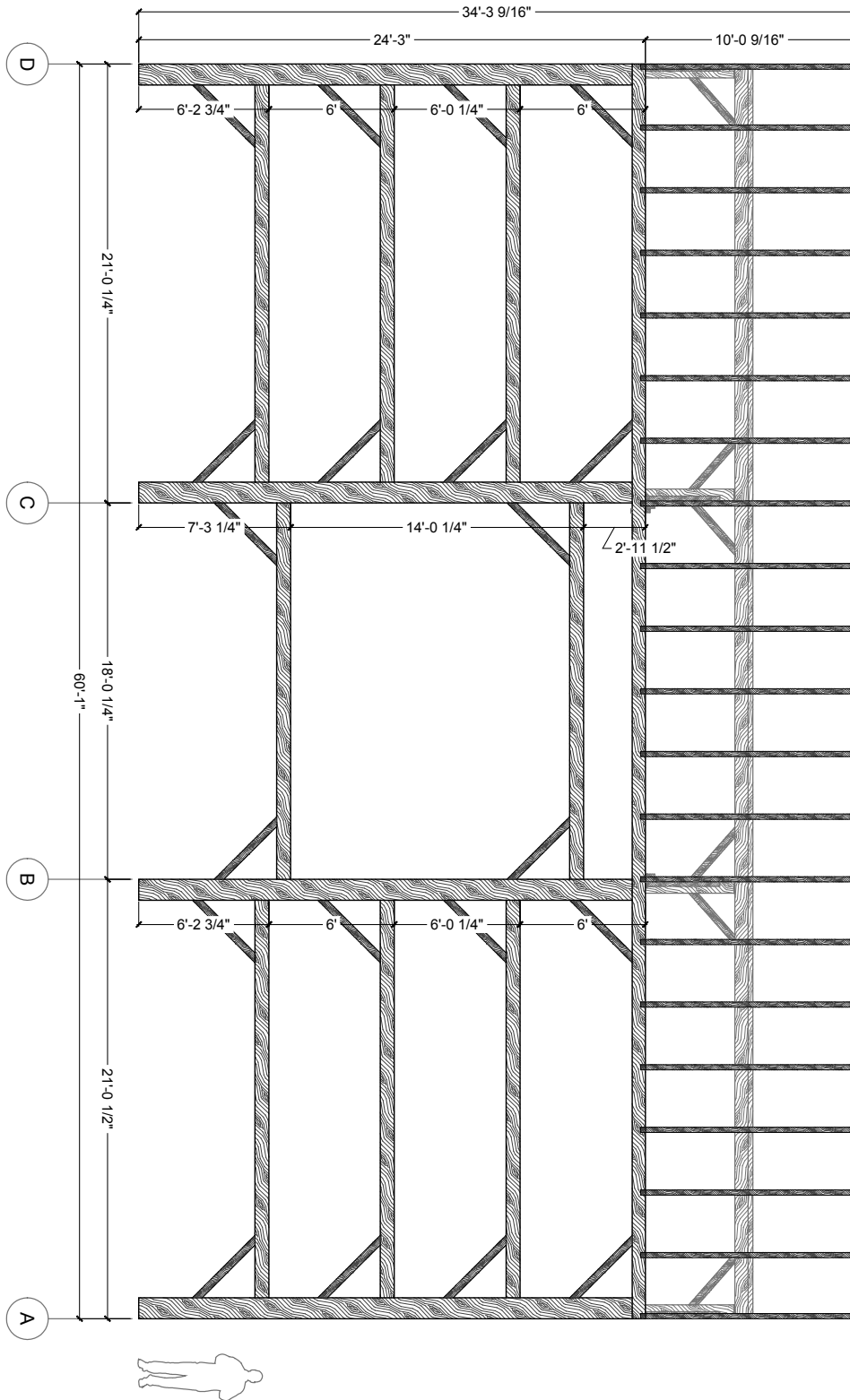

DATE	18/02/04
REVISION	01
ELEVATIONS	B205
DATE	18/02/04

REV.	REVISION DESCRIPTION	DATE

1365 PLATTSVILLE
ONTARIO, CANADA

Heritage RESTORATIONS

357 FORT GRAHAM RD. OFF. 334 839-1170
WINDO, ON L0R 1S0 FAX: 334 839-1184
www.HERITAGEBARNs.com

SIDEWALL AT GRID LINE 02 ELEVATION

SCALE: 3/16" = 1'

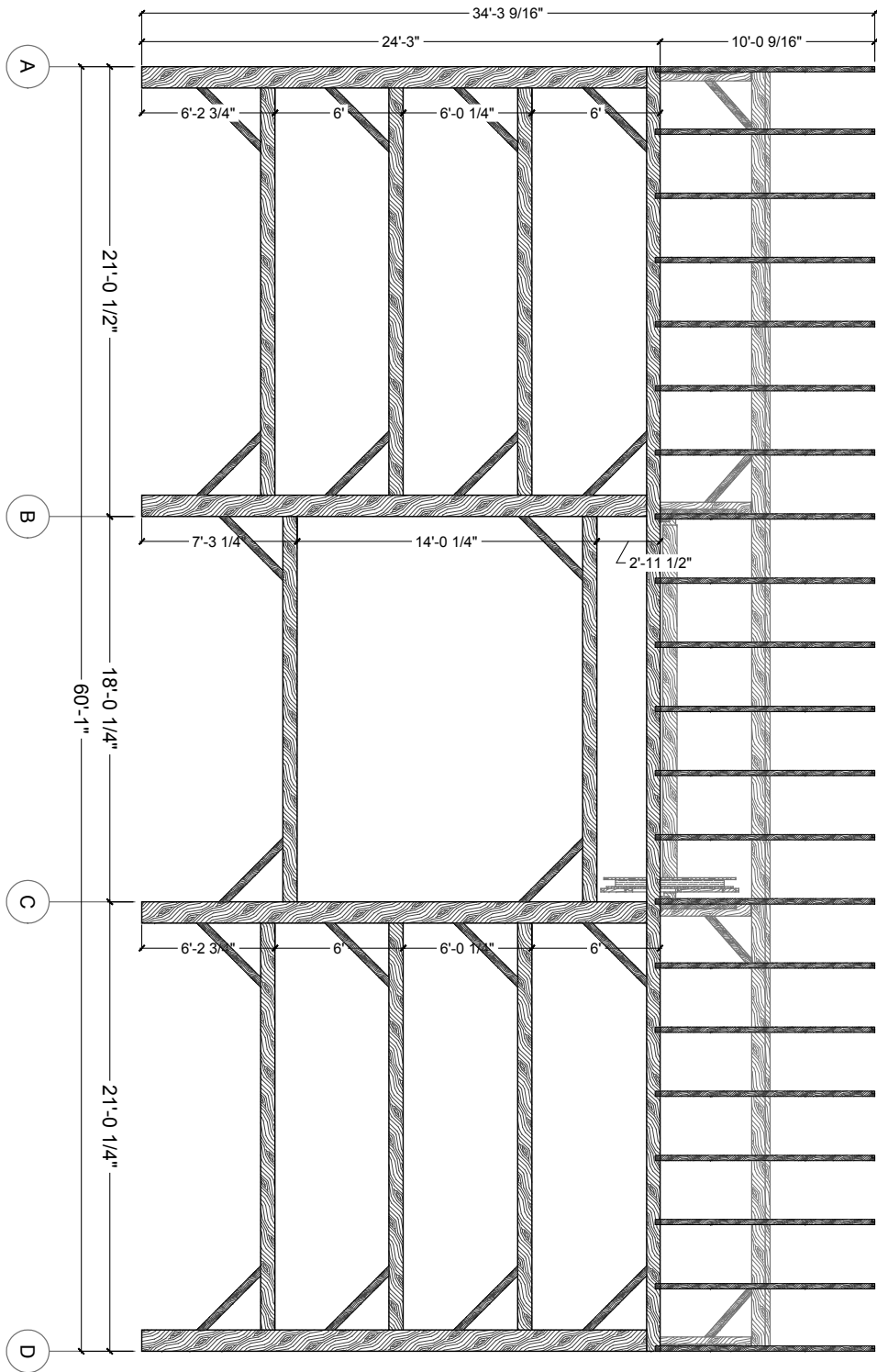

DATE	18/02/04
REVISION	01
ELEVATIONS	B206
DESIGNED BY	JAK
CHECKED BY	JAK

REV.	REVISION DESCRIPTION	DATE

1365 PLATTSVILLE
ONTARIO, CANADA

Heritage RESTORATIONS

317 FORT GRAHAM RD. OFF. 334 819-1170
WINDO, ON N0G1
HARD: 53-63-00-1244
www.HERITAGEBARNs.com

TYPICAL TIMBER DIMENSIONS

SCALE: 3/16" = 1'

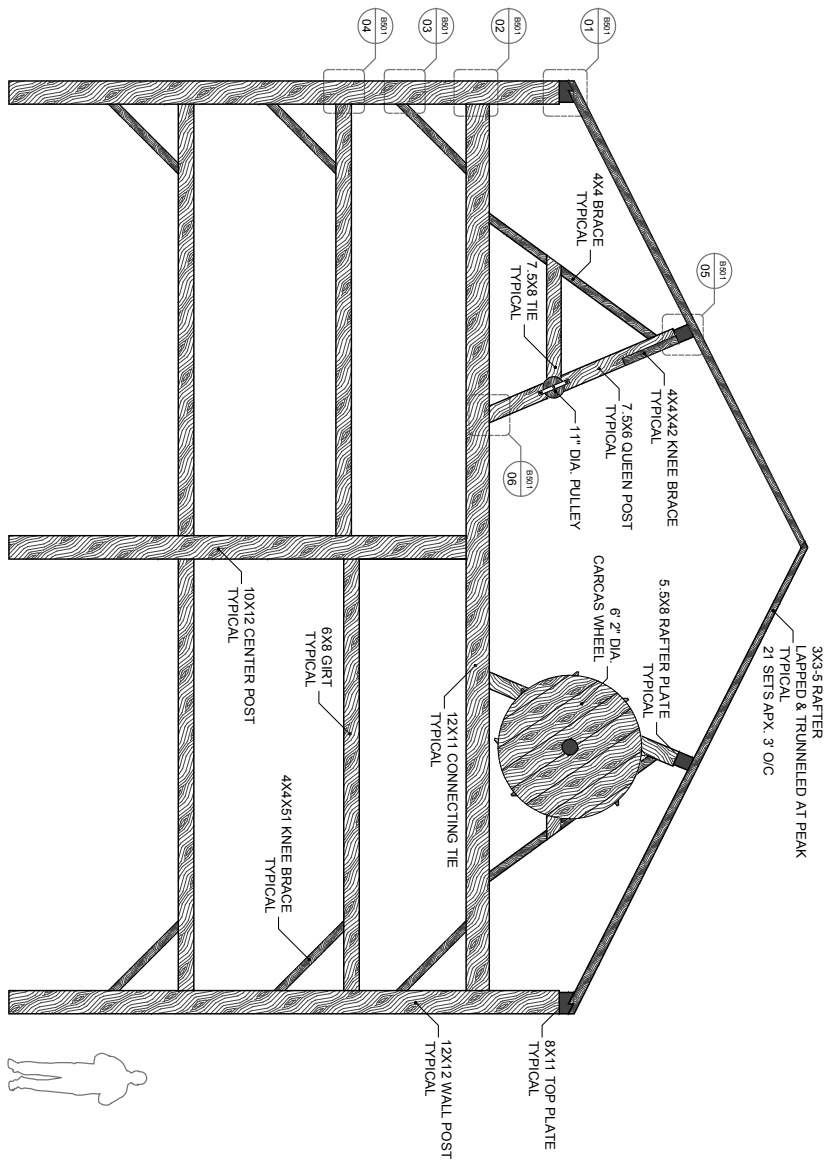

DETAILS	B500
DATE	18/02/04
REVISION	01

REV.	REVISION DESCRIPTION	DATE

1365 PLATTSVILLE
ONTARIO, CANADA

Heritage RESTORATIONS

327 FORT GRAHAM RD. OFF. 334-837-1170
WINDO, ON N0G 2W0
AND 23-6810-1244
www.HERITAGEBARNs.com

01 WALL POST TO TOP PLATE CONNECTION MORTISE AND TENON JOINT FASTENED WITH 1 1/2" OAK TRUNNEL TYPICAL

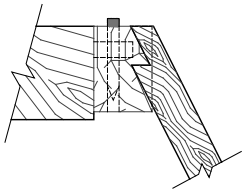

02 CONNECTING TIE TO WALL POST CONNECTION MORTISE AND TENON JOINT FASTENED WITH 1 1/2" OAK TRUNNEL TYPICAL SEE SCHEMATIC - B600

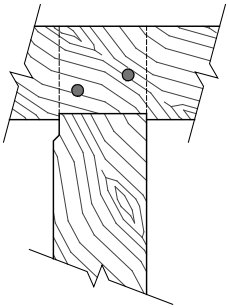

03 KNEE BRACE CONNECTION MORTISE AND TENON JOINT TYPICAL AT ALL BRACES SEE SCHEMATIC - B600

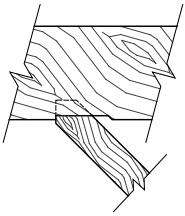

04 LATERAL GIRT TO POST CONNECTION MORTISE AND TENON JOINT FASTENED WITH 1" OAK TRUNNEL TYPICAL

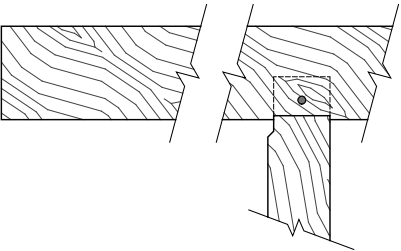

05 QUEEN POST TO RAFTER PLATE CONNECTION MORTISE AND TENON JOINT FASTENED WITH 1" OAK TRUNNEL TYPICAL

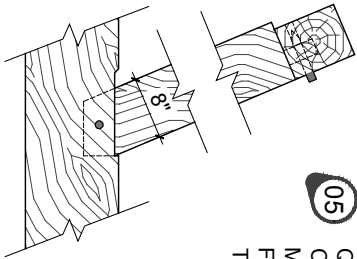

06 QUEEN POST TO CONNECTING TIE CONNECTION MORTISE AND TENON JOINT FASTENED WITH 1" OAK TRUNNEL TYPICAL

JOINERY DETAILS

SCALE: 3/4" = 1'

REV.	REVISION DESCRIPTION	DATE

REVISION
01

DATE	18/02/04
DETAILS	B501
DESIGNED BY	JAK
DRAWN BY	JAK

1365 PLATTSVILLE
ONTARIO, CANADA

Heritage RESTORATIONS

327 FORT GRAHAM RD. OFF: 334-837-1170
WINDO, TX 76798 FAX: 334-837-1184
www.HERITAGEBARNs.com

JOINERY SCHEMATIC
NOT TO SCALE

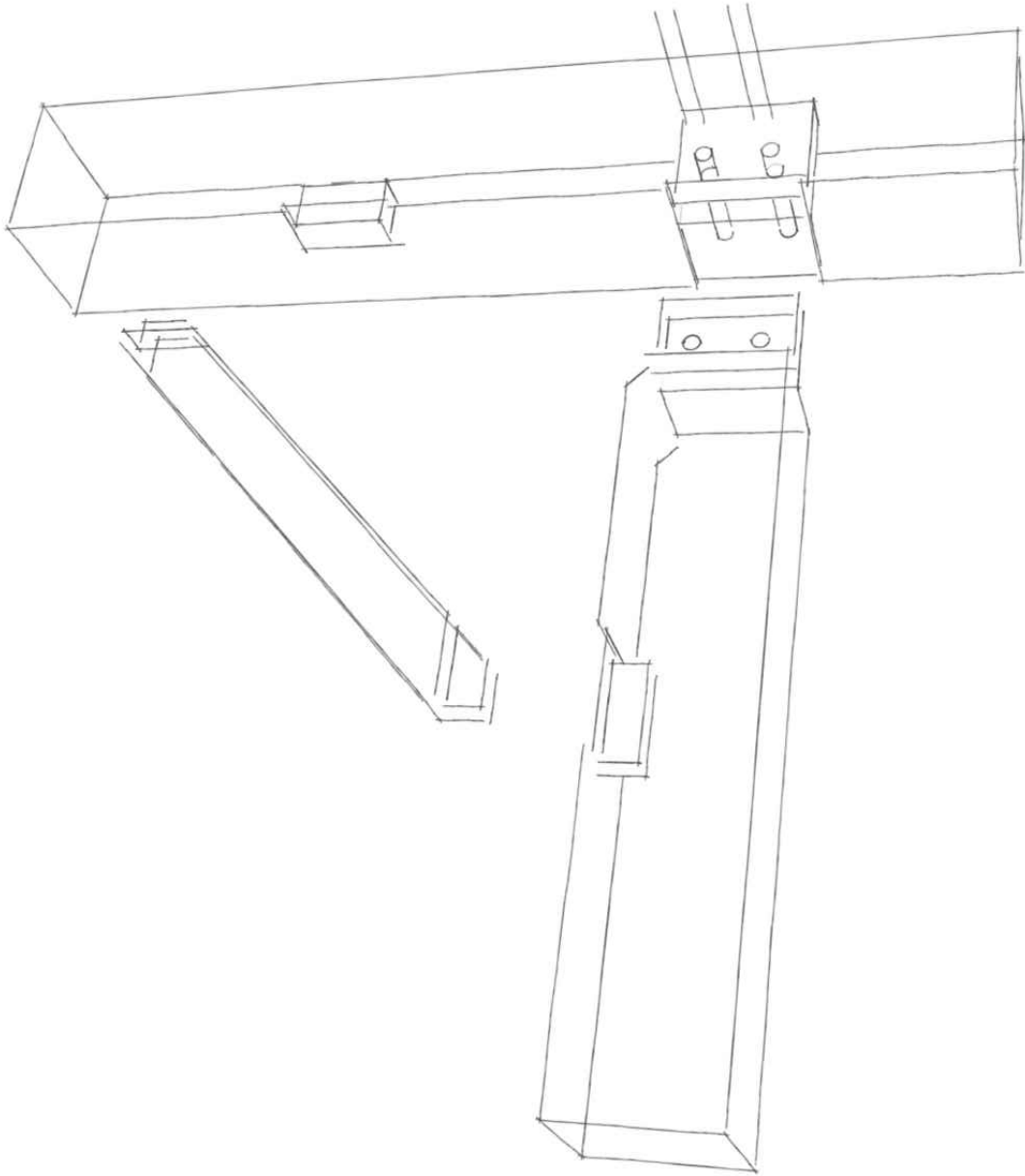

SCHEDULES
& DRAWINGS
B600
DATE: 18/02/04
DRAWN BY: JMK

REVISION
01

REV.	REVISION DESCRIPTION	DATE

1365 PLATTSVILLE
ONTARIO, CANADA

Heritage RESTORATIONS
317 FORTS GRAHAM RD. OFF: 334-8137 • 1170
 WINDO, TX 76798 FAX: 334-8130 • 1184
 WWW.HERITAGEBARN.COM