



**LUKOIL**

# **LLK-INTERNATIONAL**

LUKOIL

LUBRICANTS COMPANY

# LUKOIL GROUP

ONE OF THE LARGEST PUBLICLY TRADED, VERTICALLY INTEGRATED  
OIL AND GAS COMPANIES IN THE WORLD.

- EXPLORATION AND PRODUCTION  
IN 14 COUNTRIES OF THE WORLD
- 8 OIL REFINERIES IN RUSSIA AND EUROPE
- 5 005 FUEL STATIONS IN 19 COUNTRIES
- MORE THAN 100 THOUSAND EMPLOYEES

**1%**  
OF THE WORLD'S  
PROVEN  
RESERVES

**2%**  
OF THE GLOBAL OIL  
PRODUCTION

**92%**  
OIL PROCESSING  
DEPTH

**15%**  
SHARE IN RUSSIAN OIL  
PRODUCTION AND  
REFINING\*

\* PRODUCTION AND REFINING

**LUKOIL IS ONE OF THE LEADING  
MANUFACTURERS OF OILS,  
GREASES AND OTHER TECHNICAL  
FLUIDS**

**MORE THAN 800 THOUSAND TONS  
ANNUAL LUBRICANTS PRODUCTION VOLUME**

**THE COMPANY IS ENGAGED IN THE DEVELOPMENT,  
PRODUCTION AND DISTRIBUTION OF LUBRICANTS  
IN RUSSIA AND ABROAD**

**THE LUBRICANTS PORTFOLIO INCLUDES**

**MORE THAN 800 ITEMS**

**LUKOIL LUBRICANTS ARE USED  
IN ALL INDUSTRIAL FIELDS,  
AGRICULTURE, TRANSPORT,  
IN MARINE AND RIVER VESSELS**



# COMPANY'S HISTORY

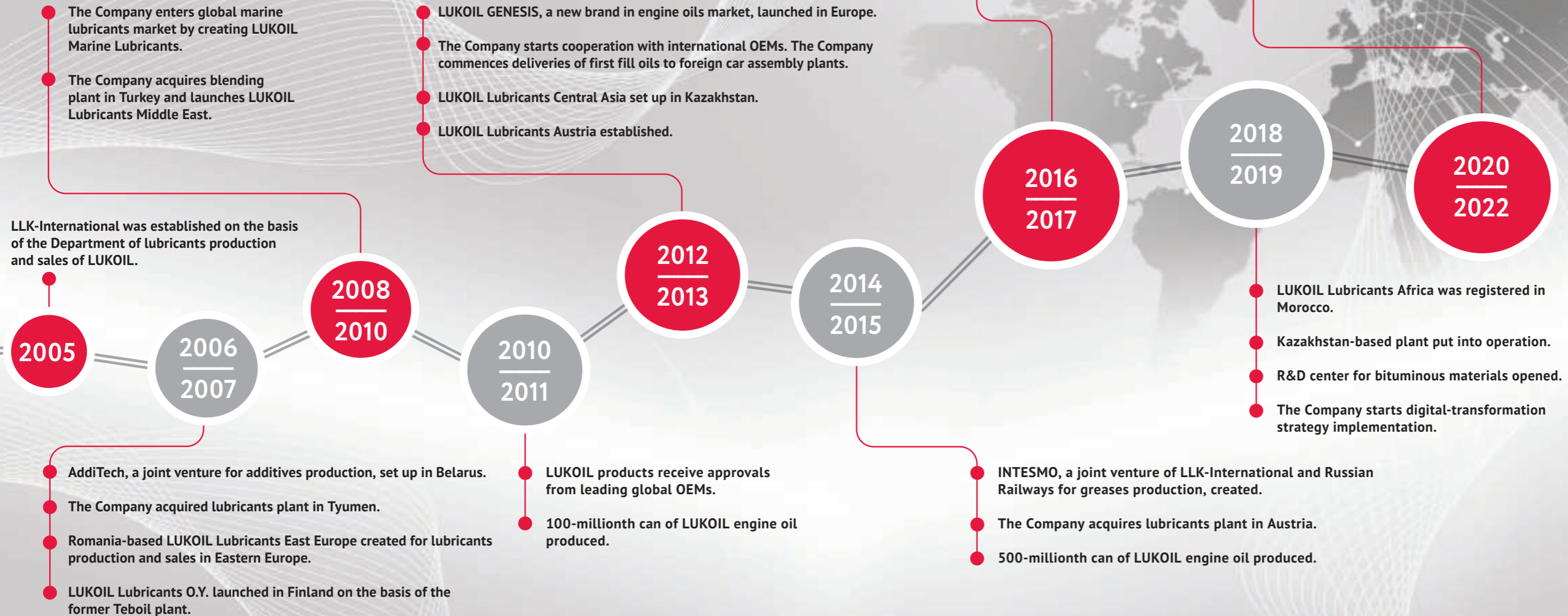

**INTESMO**  
AT THE CUTTING EDGE OF  
GREASES PRODUCTION

**ADDITECH**  
WORLD CLASS ADDITIVES

**LLK MARINE**  
REFERENCE LUBRICANTS  
FOR THE WORLD MARINE FLEET

# GLOBAL PRESENCE

**9** OWN PRODUCTION PLANTS





**2** JOINT VENTURES

**25** CONTRACTED PLANTS

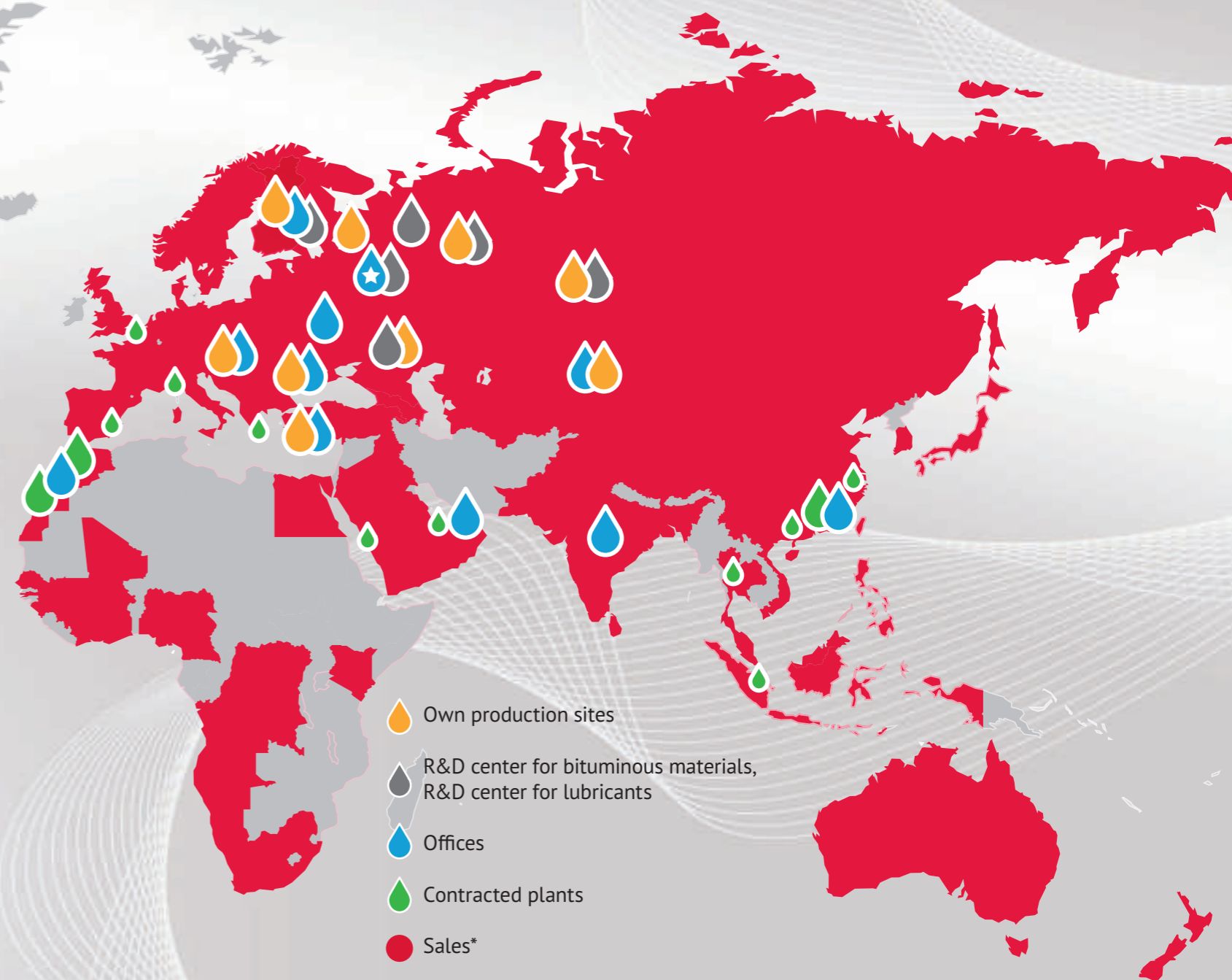

LUKOIL LUBRICANTS ARE AVAILABLE IN MORE THAN **100** COUNTRIES



-  Own production sites
-  R&D center for bituminous materials, R&D center for lubricants
-  Offices
-  Contracted plants
-  Sales\*

\* as of January 1, 2022

# PRODUCTION FACILITIES

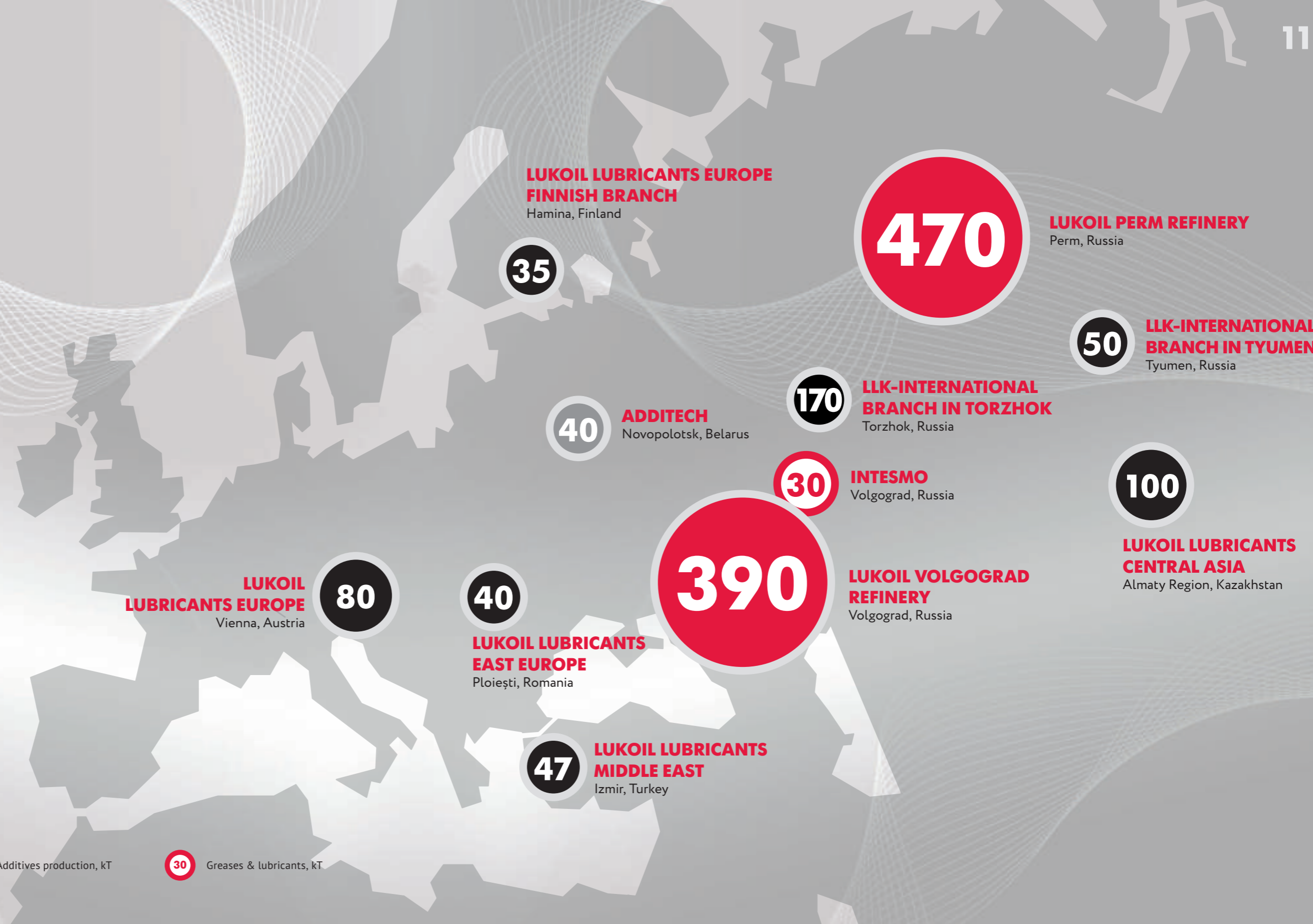

40

Blending, 40 kT

470

Full-cycle of lubricants production, kT

40

Additives production, kT

30

Greases & lubricants, kT

# LUKOIL MARINE LUBRICANTS



**One of the largest global marine lubricants supplier**

**950** ports

in more than **100** countries



# LUKOIL IS ONE OF THE WORLD'S BIGGEST BASE OIL MANUFACTURERS

Crude oil consists of over 17,000 organic and inorganic components.

In addition, oils as products of natural origin differ greatly in composition and properties. Petrochemicals, for example, raw materials for lubricants production, should, in contrast, be standardized as much as practical in order to have in a-priori known properties for safe application domestically and industrially.

The base oil production process includes several stages. At each processing stage, the content of target components in the base oil increases and undesirable hydrocarbons, which reduce its quality are removed.

LUKOIL PRODUCES  
GROUP I MINERAL OILS  
AND GROUP II+  
AND III+ OILS  
WITH VERY HIGH  
VISCOSITY INDEX

IN GROUP II+ & III+  
BASE OILS PRODUCTION,  
LUKOIL APPLIES  
INNOVATIVE  
TECHNOLOGIES

LUKOIL SUPPLIES  
BASE OILS TO THE CIS,  
EU, ASIA & AFRICA

LUKOIL BASE OILS  
ARE CERTIFIED  
ACCORDING TO  
INTERNATIONAL  
API QUALITY  
STANDARDS

# COOPERATION WITH GLOBAL OEMS

**LUKOIL IS THE FIRST RUSSIAN COMPANY TO SUPPLY LUBRICANTS FOR THE FIRST FILL & SERVICE OF FOREIGN VEHICLES IN RUSSIA AND ABROAD**

- SUPPLIES TO OEMS IN 21 COUNTRIES IN SUCH REGIONS AS EUROPE, CIS, ASIA-PACIFIC, AFRICA AND MIDDLE EAST.
- JOINTLY WITH OEMS, THE COMPANY IS DEVELOPING MODERN PRODUCTS, INCLUDING HIGHLY EFFICIENT FUEL ECONOMY ENGINE OILS.
- COMPLIANCE WITH THE REQUIREMENTS OF THE GLOBAL AUTOMOTIVE AND INDUSTRIAL OEMS ALLOW TO USE CUTTING-EDGE LUKOIL LUBRICANTS FOR ANY COMPLEXITY LEVEL OF MACHINERY AND EQUIPMENT.
- LUKOIL ENTERPRISES ARE CERTIFIED ACCORDING TO THE MAIN AUTOMOTIVE STANDARDS: IATF 16949, VDA 6.3, VW FORMEL Q (LEVEL A), GM MMOLG, RENAULT ASE5.

**MORE THAN 100 CURRENT CONTRACTS WITH INTERNATIONAL AND RUSSIAN OEMS.**



## CAR MANUFACTURERS



## INDUSTRIAL EQUIPMENT MANUFACTURERS



# R&D (LUBRICANTS)

## R&D (LUBRICANTS)

LUKOIL HAS ALL THE POTENTIAL TO DEVELOP FUTURE GENERATIONS PRODUCTS.

- 7 LABORATORIES IN RUSSIA AND EUROPE (>70 R&D SPECIALISTS).
- OWN API GROUP II+ AND III+ BASE OILS PRODUCTION.
- COOPERATION WITH INDEPENDENT LABS.

## JOINT PROJECTS WITH OEMS

JOINTLY WITH OEMS, THE COMPANY IS DEVELOPING 25 MODERN PRODUCTS, INCLUDING 16 HIGHLY EFFICIENT FUEL ECONOMY ENGINE OILS.



## FUTURE-ORIENTED PRODUCTS

THE COMPANY CLOSELY MONITORS THE AUTO MARKET TRENDS AND DEVELOPS PRODUCTS FOR LONG-TERM PERSPECTIVE.

IN 2018, THE COMPANY LAUNCHED THE PROGRAM FOR DEVELOPMENT OF SPECIAL GREASES, TRANSMISSION OILS AND METALWORKING FLUIDS FOR ELECTRIC VEHICLES.

# SERVICE SOLUTIONS

## FULL CYCLE OF TECHNICAL SUPPORT

- WAREHOUSE STORAGE ARRANGEMENT.
- COST OPTIMIZATION RECOMMENDATIONS.
- TECHNICAL SPECIALISTS SUPPORT.

## ONLINE TANK MONITORING

- MONITORING OF OIL TANKS CONDITION USING INTERNET OF THINGS (IOT) TECHNOLOGY.
- REAL-TIME INFORMATION ON OIL RESIDUES.
- FORMATION OF AN AUTOMATIC RESERVE OF PRODUCTS FOR THE NEEDS OF CUSTOMERS AND OPERATIONAL SUPPLY PLANNING.

## ON SITE EQUIPMENT MAINTENANCE

LUKOIL ENSURES SEAMLESS MAINTENANCE AT THE PRODUCTION SITE AND IN REPAIR SHOPS.

- ADVANCED STATIONARY LUBRICANTS DISTRIBUTION SYSTEMS, COOLING FLUIDS AND GREASES.
- MOBILE SERVICE STATIONS.



## INNOVATIVE LOADING CENTER

LUKOIL WAS THE FIRST IN RUSSIA TO IMPLEMENT THE FOLLOWING MODERN SOLUTIONS IN PETROLEUM PRODUCTS LOADING CENTER:

- ONLINE BOOKING OF PETROLEUM PRODUCT BATCHES.
- AUTOMATED CLIENT AUTHORIZATION SYSTEM.
- ELECTRONIC QUEUE SYSTEM.
- COMFORTABLE WAITING HALLS FOR DRIVERS.

THE PROJECT IMPLEMENTATION PROVIDED A TRANSPARENT MECHANISM FOR SHIPPING LINE AND REDUCED THE VEHICLES SERVICE DURATION AT THE PLANT.

## LUKOIL-BRANDED TANK TRUCKS

OWN TANK TRUCKS PARK FOR DELIVERY OF FIRST FILL LUBRICANTS TO THE MANUFACTURING SITES OF THE AUTOMOTIVE CONCERNS PROVIDES FOR ETALON PURITY OF FIRST FILL OILS.

# RESPONSIBILITY

## INDUSTRIAL SAFETY, LABOR AND ENVIRONMENTAL PROTECTION

- RATIONAL WATER AND LAND RESOURCES USAGE THROUGH THE INTRODUCTION OF MEASURES TO PREVENT THEIR POLLUTION.
- RECYCLABLE MATERIALS USAGE IN PRODUCTION PROCESS.
- MINIMIZATION OF INDUSTRIAL WASTE DISPOSED AT THE PRODUCTION SITES.
- FOCUS ON MEETING CUSTOMERS NEEDS AND THE CAREFUL USAGE OF RESOURCES WHILE NEW PRODUCTS ENGINEERING.
- ADVANCED SCIENTIFIC FORMULATIONS AND TECHNOLOGIES INTRODUCTION TO REDUCE THE CONSUMPTION OF NATURAL RESOURCES, MATERIALS AND ENERGY.

## SOCIAL RESPONSIBILITY

- HEALTH CARE AND SUPPORT FOR HEALTHY LIFESTYLES.
- NON-STATE PENSION PROVISION.
- CREATING OPTIMAL CONDITIONS FOR WORK AND REST.
- EDUCATION, DEVELOPMENT, WORK WITH UNIVERSITIES.



## ECO SOLUTIONS

THE COMPANY IS ACTIVELY DEVELOPING PRODUCTS AND IMPLEMENTING SERVICE SOLUTIONS AIMED AT DECREASING CARBON DIOXIDE EMISSIONS:

- FUEL-EFFICIENT LOW-VISCOSITY OILS.
- BIODEGRADABLE PRODUCTS.
- A WIDE RANGE OF SERVICE SOLUTIONS.

# CERTIFICATES



**Lloyd's Register**

**Certificate Schedule**

Location	Activities
LLK International Malaya Yamnitskaya St. 8, Moscow, 119185, Russian Federation	IATF 16949:2016 Strategic Planning, R&D, Product Design, 23000000
LUKOIL Lubricants Europe GmbH Donaukanal 103, A-1150 Vienna, Austria	IATF 16949:2016 Sales

PC 300013  
2022-04-16  
2024-04-12  
2022-04-16

## LLK-INTERNATIONAL (PERM)

- GOST R 58139-2018
- ISO 9001 : 2015
- GM MMOLG
- Ford Q1
- Renault ASES 2.0
- VW Formel Q

## LUKOIL LUBRICANTS – VIENNA

- IATF 16949 : 2016
- ISO 9001 : 2015
- VDA 6.3
- Renault ASES 2.0
- VW Formel Q level A

## LLK-INTERNATIONAL (TYUMEN)

- GOST R 58139-2018
- ISO 9001 : 2015

## LUKOIL LUBRICANTS – HAMINA

- IATF 16949 : 2016
- ISO 9001 : 2015
- GM, VW

## LLK-INTERNATIONAL (VOLGOGRAD)

- ISO 9001 : 2015
- Renault ASES 2.0

## LUKOIL LUBRICANTS – PLOESTI

- IATF 16949 : 2016
- ISO 9001:2015

## LLK-INTERNATIONAL (TORZHOK)

- ISO 9001:2015

## LUKOIL LUBRICANTS – IZMIR

- IATF 16949 : 2016
- ISO 9001 : 2015

## LUKOIL LUBRICANTS – ALMATY

- IATF 16949 : 2016
- ISO 9001 : 2015



**PRODUCT  
PORTFOLIO**

**UKOIL**

**UKOIL**

**ЛУКОЙЛ**

**UKOIL**

**ЛУКОЙЛ**

# LUKOIL GENESIS

**PASSENGER CARS IN RUSSIA ROLL OFF THE ASSEMBLY LINES FILLED WITH LUKOIL GENESIS: VOLKSWAGEN AND AVTOVAZ RENAULT-NISSAN ALLIANCE.**

GENESIS engine oil retail portfolio includes two sublines:

**GENESIS ARMORTECH** fully synthetic engine oils series designed for warranty maintenance of vehicles. These oils are officially approved by the world's leading car manufacturers and meet the requirements of international classifications (API, ACEA, ILSAC).

**GENESIS UNIVERSAL** engine oils designed for the post-warranty maintenance of motor vehicles. UNIVERSAL oils have improved detergent and neutralizing properties.

LUKOIL GENESIS ARMORTECH 5W-40  
 LUKOIL GENESIS ARMORTECH 0W-40  
 LUKOIL GENESIS ARMORTECH HK 5W-30  
 LUKOIL GENESIS ARMORTECH FD 5W-30  
 LUKOIL GENESIS ARMORTECH GC 5W-30  
 LUKOIL GENESIS ARMORTECH GC 0W-20  
 LUKOIL GENESIS ARMORTECH DIESEL 5W-30  
 LUKOIL GENESIS ARMORTECH DIESEL 5W-40  
 LUKOIL GENESIS ARMORTECH JP 5W-30

LUKOIL GENESIS ARMORTECH JP 0W-20  
 LUKOIL GENESIS ARMORTECH JP 0W-30  
 LUKOIL GENESIS ARMORTECH DX1 5W-30  
 LUKOIL GENESIS RACING 5W-50  
 LUKOIL GENESIS UNIVERSAL 10W-40  
 LUKOIL GENESIS UNIVERSAL 5W-40  
 LUKOIL GENESIS UNIVERSAL 5W-30  
 LUKOIL GENESIS UNIVERSAL DIESEL 5W-30

# GENESIS



## GLOBAL OEMS CHOICE

# LUKOIL GENESIS SPECIAL

**LUKOIL GENESIS SPECIAL LUBRICANTS ARE APPROVED BY LEADING CAR MANUFACTURERS SUCH AS MERCEDES-BENZ, FORD, VOLKSWAGEN, RENAULT, ETC.**

LUKOIL GENESIS SPECIAL engine oils for service maintenance of warranty and post-warranty cars are available at authorized workshops.

The GENESIS SPECIAL line includes products for a wide range of car brands, as well as engine oils ultimately satisfying the requirements of specific car manufacturers (Ford, General Motors, Volkswagen etc).

High efficiency of LUKOIL GENESIS SPECIAL engine oils is confirmed by leading OEM's approvals and licences of international industry organisations as well as by tests performed by independent accredited laboratories.



LUKOIL GENESIS SPECIAL 5W-40  
 LUKOIL GENESIS SPECIAL 0W-40  
 LUKOIL GENESIS SPECIAL 5W-30  
 LUKOIL GENESIS SPECIAL 0W-30  
 LUKOIL GENESIS SPECIAL A3/B4 5W-40  
 LUKOIL GENESIS SPECIAL ADVANCED 5W-40  
 LUKOIL GENESIS SPECIAL ADVANCED 10W-40  
 LUKOIL GENESIS SPECIAL RACING 10W-60  
 LUKOIL GENESIS SPECIAL A5/B5 5W-30  
 LUKOIL GENESIS SPECIAL A5/B5 0W-30  
 LUKOIL GENESIS SPECIAL A5X 5W-30  
 LUKOIL GENESIS SPECIAL ADVANCED 5W-30  
 LUKOIL GENESIS SPECIAL C1 5W-30  
 LUKOIL GENESIS SPECIAL C2 5W-30  
 LUKOIL GENESIS SPECIAL C2 0W-30  
 LUKOIL GENESIS SPECIAL FD 0W-30  
 LUKOIL GENESIS SPECIAL VN 5W-30  
 LUKOIL GENESIS SPECIAL VN 0W-30  
 LUKOIL GENESIS SPECIAL C3 5W-40  
 LUKOIL GENESIS SPECIAL C3 5W-30  
 LUKOIL GENESIS SPECIAL C3X 5W-30  
 LUKOIL GENESIS SPECIAL RN 5W-30  
 LUKOIL GENESIS SPECIAL C4 5W-30  
 LUKOIL GENESIS SPECIAL C5X 0W-20  
 LUKOIL GENESIS SPECIAL VN 0W-20  
 LUKOIL GENESIS SPECIAL VL 0W-20  
 LUKOIL GENESIS SPECIAL RN 0W-20  
 LUKOIL GENESIS SPECIAL JLR 0W-20  
 LUKOIL GENESIS SPECIAL MC 0W-20  
 LUKOIL GENESIS SPECIAL MCB 0W-20  
 LUKOIL GENESIS SPECIAL MD 0W-30

# LUKOIL LUXE

**LUKOIL LUXE OILS ARE ADAPTED FOR SEVERE OPERATING CONDITIONS AND ARE A ONE-STOP SOLUTION FOR HIGH MILEAGE MOTOR VEHICLES.**

LUKOIL LUXE products are produced using high quality hydrocracking technology base oils. They are officially approved by Russian OEMs and meet the API SL requirements.

Engine oils of this series are a good solution for high-mileage vehicles and recommended for post-warranty cars.

LUKOIL LUXE 5W-40  
 LUKOIL LUXE 5W-30  
 LUKOIL LUXE 10W-40  
 LUKOIL LUXE TURBO DIESEL 10W-40



# LUKOIL SUPER

**LUKOIL SUPER IS THE MOST POPULAR BRAND IN RUSSIA FOR OWNERS OF OLD CARS WITH HIGH MILEAGE.**

**LUKOIL SUPER** products are high-quality multigrade semi-synthetic and mineral oils for forced naturally aspirated gasoline and diesel (moderately supercharged) engines.

These products are recommended for the post-warranty passenger cars, minibuses and light commercial vehicles of 15 years and older, which require API SG/CD lubricants.

LUKOIL SUPER 5W-40  
LUKOIL SUPER 10W-40  
LUKOIL SUPER 15W-40  
LUKOIL SUPER 20W-50



# LUKOIL AVANTGARDE

**LUKOIL AVANTGARDE PROFESSIONAL XLE 5W-30 OIL IS THE FIRST PRODUCT IN THE WORLD TO PASS FIELD TESTS ON MAN TRUCKS WITH A DRAIN INTERVAL OF 160 000 KM AND TO RECEIVE MAN M 3777 APPROVAL.**

LUKOIL AVANTGARDE oils specifically developed for use in modern diesel engines of commercial vehicles operated under severe conditions. LUKOIL AVANTGARDE oils include the following ranges:

LUKOIL AVANTGARDE is a series of multipurpose, high-quality, multigrade engine oils for high-speed, four-stroke, heavy-duty atmospheric and turbocharged diesel engines of trucks and cars requiring the API CF-4 properties level.

LUKOIL AVANTGARDE EXTRA is a series of high-efficiency oils for modern diesel engines, including turbocharged ones, operated under average and severe conditions and requiring the API CH-4 properties level.

LUKOIL AVANTGARDE ULTRA is a series of high-efficiency oils for turbocharged heavy-duty diesel engines of trucks and buses required the Euro-1 to Euro 5 environmental standards and API CI-4 properties level.

LUKOIL AVANTGARDE PROFESSIONAL is a series of semi-synthetic and synthetic oils developed for last generation diesel engines required the Euro-5 and Euro-6 environmental standards and ACEA E4, E6, E9 and API CI-4, CJ-4, CK-4, FA-4 properties level.

## AVANTGARDE ENGINE PROTECTED



LUKOIL AVANTGARDE PROFESSIONAL XLA 15W-40  
 LUKOIL AVANTGARDE PROFESSIONAL XLA 10W-30  
 LUKOIL AVANTGARDE PROFESSIONAL XLE 5W-30  
 LUKOIL AVANTGARDE PROFESSIONAL XLE 10W-40  
 LUKOIL AVANTGARDE PROFESSIONAL LE 5W-30  
 LUKOIL AVANTGARDE PROFESSIONAL LE 10W-40  
 LUKOIL AVANTGARDE PROFESSIONAL LS5 10W-40  
 LUKOIL AVANTGARDE PROFESSIONAL LA 5W-30  
 LUKOIL AVANTGARDE PROFESSIONAL LA 5W-40  
 LUKOIL AVANTGARDE PROFESSIONAL LA 10W-30  
 LUKOIL AVANTGARDE PROFESSIONAL LA 10W-40  
 LUKOIL AVANTGARDE PROFESSIONAL LA 15W-40  
 LUKOIL AVANTGARDE PROFESSIONAL 5W-30  
 LUKOIL AVANTGARDE PROFESSIONAL 10W-40  
 LUKOIL AVANTGARDE PROFESSIONAL M6 10W-40  
 LUKOIL AVANTGARDE PROFESSIONAL M5 5W-30  
 LUKOIL AVANTGARDE PROFESSIONAL M5 10W-40  
 LUKOIL AVANTGARDE ULTRA M3 10W-30  
 LUKOIL AVANTGARDE ULTRA M3 15W-40

LUKOIL AVANTGARDE ULTRA PLUS 10W-40  
 LUKOIL AVANTGARDE ULTRA 5W-40  
 LUKOIL AVANTGARDE ULTRA 10W-30  
 LUKOIL AVANTGARDE ULTRA 10W-40  
 LUKOIL AVANTGARDE ULTRA 15W-40  
 LUKOIL AVANTGARDE EXTRA 10W-30  
 LUKOIL AVANTGARDE EXTRA 10W-40  
 LUKOIL AVANTGARDE EXTRA 15W-40  
 LUKOIL AVANTGARDE CNG LA 15W-40  
 LUKOIL AVANTGARDE CNG 15W-40  
 LUKOIL AVANTGARDE 10W-30  
 LUKOIL AVANTGARDE 10W-40  
 LUKOIL AVANTGARDE 15W-40  
 LUKOIL AVANTGARDE 20W-50  
 LUKOIL AVANTGARDE SAE 20  
 LUKOIL AVANTGARDE SAE 30  
 LUKOIL AVANTGARDE SAE 40  
 LUKOIL AVANTGARDE SAE 50

# TRANSMISSION OILS

**LUKOIL TRANSMISSION OILS ARE BASED ON HIGHLY PURIFIED MINERAL AND MODERN SYNTHETIC BASE OILS IN COMBINATION WITH HIGH-EFFICIENCY ADDITIVES THAT IMPROVE OPERATING FEATURES.**

**LUKOIL TRANSMISSION TM-4** are modern transmission oils for manual gearboxes that require the API GL-4 property level.

**LUKOIL TRANSMISSION TM-5** are transmission oils for differentials, hypoid gearboxes and heavy-duty axles of passenger and commercial vehicles, requiring API GL-5 oils.

**LUKOIL TRANSMISSION TM-4/5** are universal oils for manual gearboxes and axles of trucks, buses and special machinery that require the API GL-4 and GL-5 oils.

**LUKOIL ATF** are fluids for automatic gearboxes covering a wide range of vehicle manufacturers.

**LUKOIL GEYSER MM** is a series of high-quality oils for off-road motor vehicles. These oils are used for main and final gears and transmission units of heavy vehicles that must meet the CAT TO-4 and FD-1 specifications.

**LUKOIL VERSO** is a series of Universal tractor transmission oils (UTTO) specially formulated to provide the best lubrication for transmissions, hydraulic and oil-immersed brakes and other systems of agricultural machinery.

**LUKOIL VERSO MOTOR** is a series of universal highly efficient STOU (Super Tractor Oil Universal) oils.

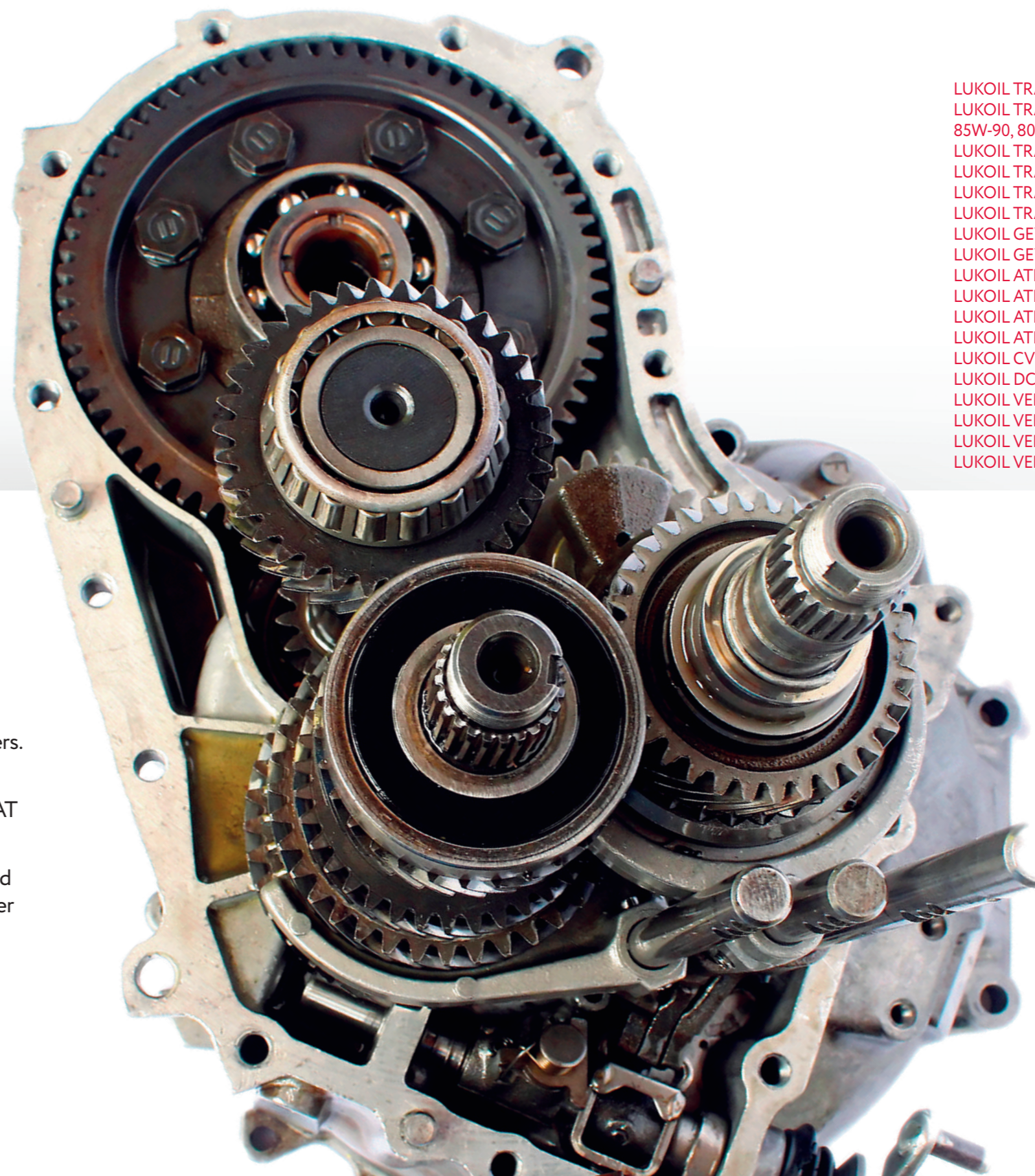

LUKOIL TRANSMISSION TM-4 75W-90, 80W-90  
 LUKOIL TRANSMISSION TM-5 75W-90, 80W-90, 85W-90, 80W-140, 85W-140  
 LUKOIL TRANSMISSION MN 75W-90  
 LUKOIL TRANSMISSION TM-4/5 75W-90  
 LUKOIL TRANSMISSION LDI 75W-80  
 LUKOIL TRANSMISSION SYNTH TM-4 75W-85  
 LUKOIL GEYSER MM 10W, 30, 50, 60  
 LUKOIL GEYSER MM SYNTH 5W-30  
 LUKOIL ATF SYNTH MULTI  
 LUKOIL ATF  
 LUKOIL ATF SYNTH ASIA  
 LUKOIL ATF SYNTH VI  
 LUKOIL CVTF  
 LUKOIL DCTF  
 LUKOIL VERSO 10W-30, 5W-30  
 LUKOIL VERSO LVX 10W-30  
 LUKOIL VERSO PLUS 10W-30  
 LUKOIL VERSO MOTOR 10W-30, 10W-40, 15W-40

# HYDRAULIC OILS

## LUKOIL HYDRAULIC OILS MEET THE MOST STRICT OEM REQUIREMENTS.

**LUKOIL GEYSER ST PLUS** hydraulic oils produced with high-viscosity index base oils with excellent antioxidant properties and increased viscosity index.

**LUKOIL GEYSER ST** is a series of industrial hydraulic oils with a high cleanliness level, perfect filterability and air separation properties.

**LUKOIL GEYSER ZF** is a series of extra-pure hydraulic oils based on zinc- and chlorine free additives with improved anti-wear properties for industrial and transport hydraulic systems.

**LUKOIL GEYSER LT** is a series of multigrade hydraulic oils for modern high-efficiency hydraulic systems of mobile logging and road-building machinery, forestry equipment, truck loaders and cranes and in the hydraulic systems of stationary equipment operated in unheated premises or on open-air platforms all year round.

**LUKOIL GEYSER LT ZF** is a series of multi grade zinc-free (ash-free) hydraulic oils with improved viscosity characteristics that ensure seamless operation of hydraulic systems in various environmental conditions.

**LUKOIL GEYSER XLT 32** premium hydraulic oil for extreme low temperature. Designed for hydraulic systems of mobile equipment, forestry equipment and other industrial equipment operating at arctic conditions.

**LUKOIL GEYSER LTD 46** multigrade hydraulic oil with improved detergent, dispersing and emulsifying properties. Designed for use in hydraulic systems, operating at wide range of temperatures and conditions with high contamination level.

**LUKOIL GEYSER UNIVERSAL** multigrade hydraulic oil with excellent viscosity and temperature characteristics.

**LUKOIL GEYSER A** hydraulic fluids for wellhead and pipeline accessories, equipped with hydraulic drives working at low and extra-low outside temperatures.

LUKOIL GEYSER ST PLUS 32, 46, 68  
 LUKOIL GEYSER ST 22, 32, 46, 68, 100  
 LUKOIL GEYSER ZF 22, 32, 46, 68, 100  
 LUKOIL GEYSER LT 32, 46, 68, 100  
 LUKOIL GEYSER LT ZF 32, 46, 68  
 LUKOIL GEYSER XLT 32  
 LUKOIL GEYSER LTD 46  
 LUKOIL GEYSER A Grade1, Grade 2, Grade 3  
 LUKOIL GEYSER 32, 46, 68, 100  
 LUKOIL GEYSER UNIVERSAL  
 LUKOIL GEYSER HFAE  
 LUKOIL GEYSER HFC  
 LUKOIL GEYSER HFDU  
 LUKOIL GEYSER UNIVERSAL XVI  
 LUKOIL GEYSER UNIVERSAL XVI ZF  
 LUKOIL GEYSER XLT AL  
 LUKOIL VMGZ (-60), LUKOIL VMGZ (-45)



# GEAR OILS

**LUKOIL GEAR OILS ARE VERY POPULAR AS THEY MAY BE USED IN A WIDE TEMPERATURE RANGE AND EXTREME LOADS.**

**LUKOIL STEELO SYNTH** fully-synthetic industrial gear oils made of high-quality polyalphaolefin (PAO) base oils with modern additive package.

**LUKOIL STEELO PLUS** premium mineral gear oils. Special additive package with friction modifier provides high protection against micropitting, elastomer compatibility, excellent protection against wear and corrosion.

**LUKOIL STEELO** is a series of high-quality gearbox oils for heavy loaded industrial gears and mechanisms requiring oils with EP properties.

**LUKOIL STEELO XLT** low-viscosity industrial gear oil with low pour point for multigrade use in pumping unit gears, straight bevel, worm, helical gears and other industrial transmissions operated at extreme low temperatures.

**LUKOIL STEELO LT 10** high-quality gear oil for all-season use in pumping unit gears, straight bevel, worm, helical gears and other industrial transmissions operated at ambient temperatures through to minus 35 °C.

LUKOIL STEELO SYNTH 68, 100, 150, 220, 320, 460, 680  
 LUKOIL STEELO PLUS 150, 220, 320, 460  
 LUKOIL STEELO 68, 100, 150, 220, 320, 460, 680  
 LUKOIL STEELO XLT  
 LUKOIL STEELO LT 10

# COMPRESSOR OILS

**LUKOIL COMPRESSOR OILS PROVIDE RELIABLE OPERATION OF EQUIPMENT THROUGHOUT EXTENDED DRAIN INTERVAL.**

**LUKOIL STABIO** is a series of high-quality mineral compressor oils for lubricating modern air and gas (screw, rotor, piston) compressors produced by world's leading manufacturers and operated under heavy conditions.

**LUKOIL STABIO PLUS** compressor oils produced on the basis of synthetic base oils characterised by high low-temperature properties and anti-oxidation stability. Intended for use in high-performance compressors operated in a wide range of temperatures.

**LUKOIL STABIO SYNTH** premium high-efficiency synthetic compressor oils produced on the basis of polyalphaolefins. Developed for air and gas compressors requiring oils with extended drain intervals.

**LUKOIL STABIO DGC** special compressor oils produced on the basis of polyalkyleneglycol and intended for oil and gas and chemical industries.

LUKOIL STABIO 46, 68, 100, 150, 220, 460, 680

LUKOIL STABIO PLUS 46, 68

LUKOIL STABIO SYNTH 46, 68, 100, 150

LUKOIL STABIO DGC 68, 100, 150



# TURBINE OILS

**LUKOIL TURBINE OILS ARE SUCCESSFULLY USED IN EQUIPMENT OF GLOBAL INDUSTRY LEADERS.**

**LUKOIL TORNADO T** synthetic oils designed in accordance to the requirements of the world's leading turbine manufacturers. The products provide reliable operation and extend drain interval in modern steam and gas turbines both geared and gearless.

**LUKOIL TORNADO M** high quality turbine oils developed for modern steam, gas and hydraulic turbines, including those equipped with gearboxes and multipliers. It has improved thermal-oxidative stability and an extended drain interval (compared to TP-22s and TP-30 oils).

**LUKOIL TORNADO S** high-efficient turbine oil produced with synthetic base oils and special additives package. Designed to provide extended drain interval and to meet the requirements of steam and gas turbines, manufactured by Mitsubishi Heavy Industries (MHI).

**LUKOIL TORNADO SNH** high-quality turbine oils specially designed for use at chemical manufacturing, including those where interaction with ammonia is possible.

**LUKOIL TORNADO GT** high-quality synthetic turbine oil for lubricating gas compressor units. High anti-oxidation stability allows increasing oil drain interval (compared to MS-8p and SGT).

LUKOIL TORNADO T 32, 46  
LUKOIL TORNADO M 32, 46  
LUKOIL TORNADO S 32  
LUKOIL TORNADO SNH 32, 46  
LUKOIL TORNADO GT

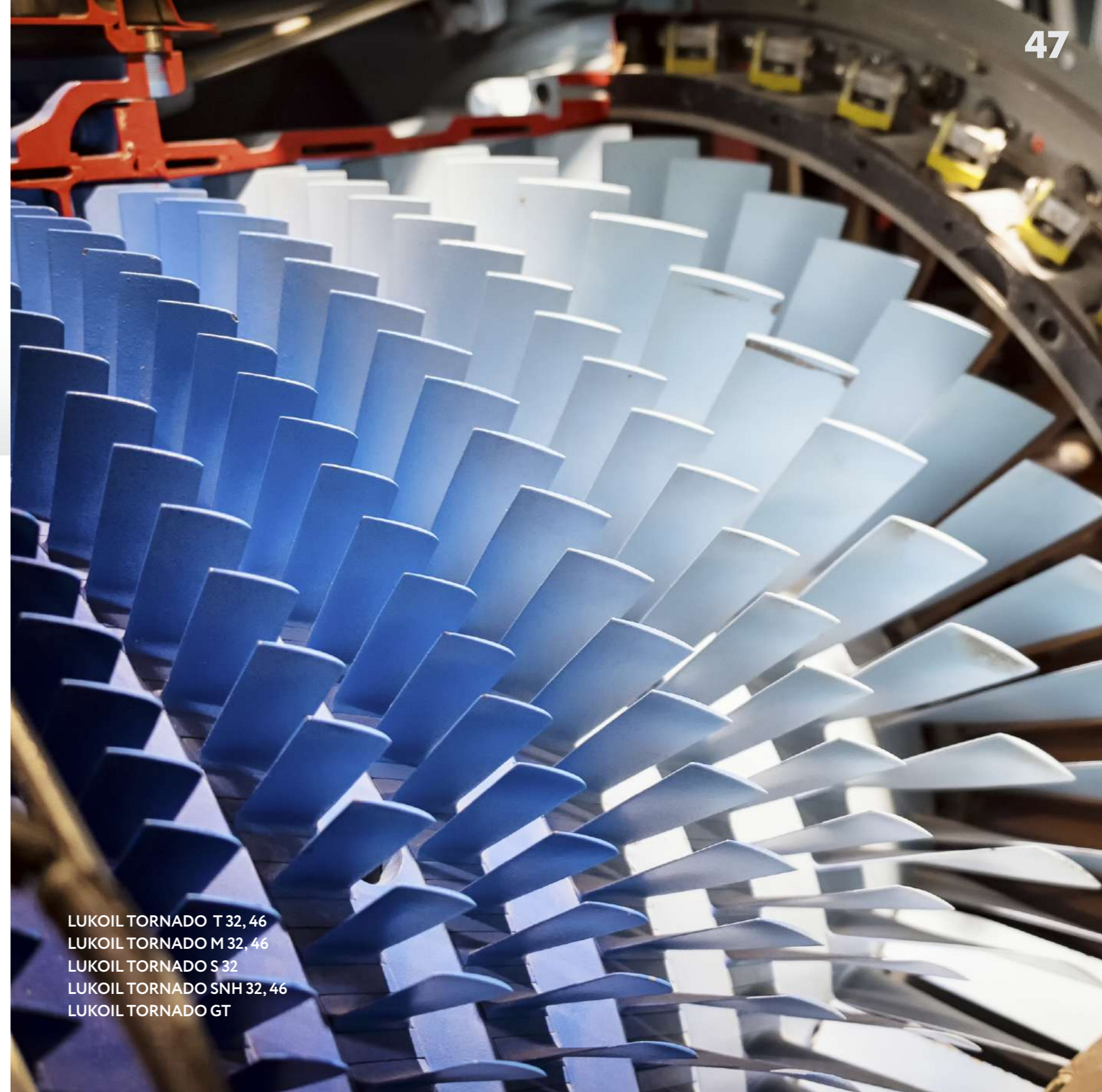

# SLIDEWAY OILS

**SPECIAL COMPONENTS OF LUKOIL SLIDO OILS ENSURE SMOOTH MOTION OF PROCESSED PARTS.**

**LUKOIL SLIDO** high quality industrial oils for horizontal and vertical slideways.

They are designed on a deeply purified high-index mineral base oils with a package of special high-efficiency additives.

The oils are suitable for hydraulic systems and drive gears.

**LUKOIL SLIDO 32, 68, 150, 220**

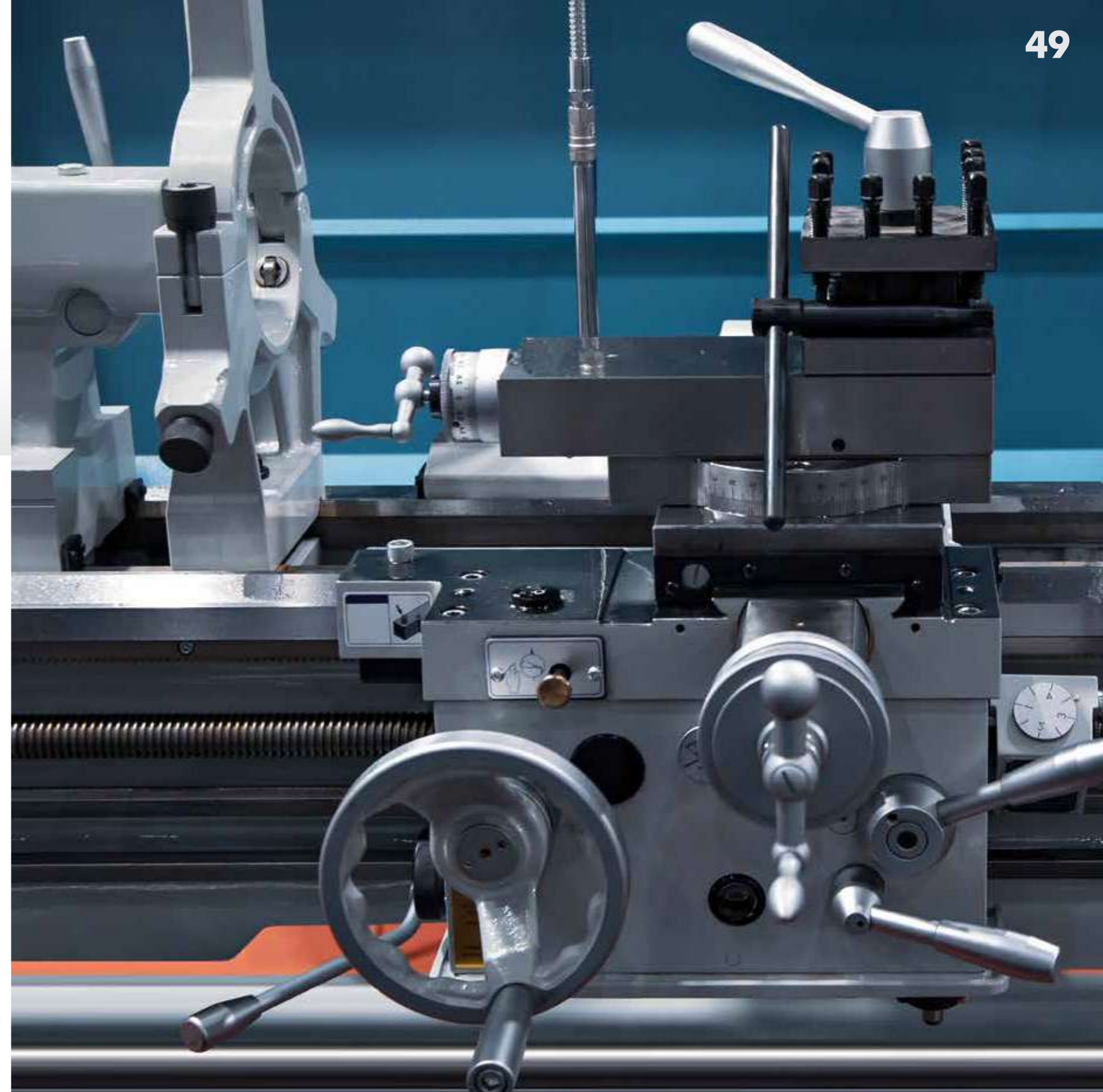

# ROLLING MILL OILS

**LUKOIL OILS HAVE PROVED TO BE SUCCESSFUL FOR MAJOR METALLURGICAL ENTERPRISES SUCH AS SEVERSTAL, NOVOLIPETSK STEEL, MAGNITOGORSK IRON AND STEEL WORKS, ETC.**

**LUKOIL INTEGO** is a series of high-quality industrial circulating oils for rolling mill oil film bearings based on deeply purified high-index base oils in combination with high-efficiency ashless additives. They are recommended for lubricating highly loaded bearings by EZTM.

**LUKOIL INTEGO PREMIUM** is a series of high-quality industrial circulation oils for bearings of rolling mills of Russian and foreign brands.

The oils comply with the SMS Group SN 180-4 (X-Roll® Oil Bearing Advanced Lubricant Specification).

LUKOIL INTEGO 46, 220, 320, 460

LUKOIL INTEGO PREMIUM 100, 150, 220, 320, 460



# CIRCULATING OILS

**LUKOIL CIRCULATING OILS COMPLY WITH THE REQUIREMENTS OF THE WORLD'S LEADING MANUFACTURERS OF INDUSTRIAL EQUIPMENT.**

**LUKOIL ADVANTO** is a series of special circulation oils for high-performance paper machines operated at high temperatures and speeds under the impact of pressurised steam. These oils are developed for lubricating rolling and sliding bearings and for toothed gears of paper machines.

**LUKOIL SUPPORTO** are industrial low-viscosity mineral oils with improved antioxidant, antiwear and anticorrosion properties. Designed for lubricating light-loaded high-speed mechanisms, including spindle blocks with friction bearings, spinning spindles, twistors, sewing, knitting and other machines, hydraulic and circulation systems of machine tool equipment.

**LUKOIL ROUND** high-performance circulating oils for wide range of applications in various industrial equipment. The oils are specially developed for replacement of IGP, IGS and I-T-D oils of appropriate viscosity grades.

LUKOIL ADVANTO 150, 220

LUKOIL SUPPORTO 5, 7, 10

LUKOIL ROUND 68, 100, 150, 220, 320, 460



# QUENCHING OILS

**LUKOIL QUENCHING OILS PROVIDE HIGH QUALITY AND CLEANNES OF SURFACES.**

**LUKOIL ASSISTO T** special oils used as a working fluid in thermal metal processing, where the technology requires oils with a high level of operating properties.

The oils are made on the basis of highly purified mineral base oils with high efficiency additive package, that improves anti-corrosion, anti-oxidation and detergent properties.

LUKOIL ASSISTO T 12, 16, 26



# GAS ENGINES OILS

**LUKOIL EFFORCE IS SPECIALLY DEVELOPED TO MEET THE REQUIREMENTS OF THE WORLD'S LEADING GAS ENGINES MANUFACTURERS SUCH AS JENBACHER, WAUKESHA, PERKINS, ROLLS ROYCE, CATERPILLAR, DEUTZ AND OTHERS.**

**LUKOIL EFFORCE** is a series of engine oils for stationary gas engines. It includes the following ranges:

**LUKOIL EFFORCE 4004** low ash mineral oil developed for lubricating high-performance atmospheric and turbocharged stationary engines running on natural, associated petroleum and other types of gases.

**LUKOIL EFFORCE XDI 4004** low-ash engine oil with an extended drain interval for lubricating 4-stroke stationary gas engines, including engines equipped with emission catalysts.

**LUKOIL EFFORCE HD 4009** medium-ash mineral engine oil for gas-piston engines operating in severe acidic conditions (biogas, landfill and sludge gas), for which the engine manufacturers prescribe oils with ash content below 1%.

**LUKOIL EFFORCE 15W-40** ashless engine oil for 2-stroke and 4-stroke gas engines and compressors running on different types of gases.

LUKOIL EFFORCE 4004  
LUKOIL EFFORCE XDI 4004

LUKOIL EFFORCE HD 4009  
LUKOIL EFFORCE 15W-40

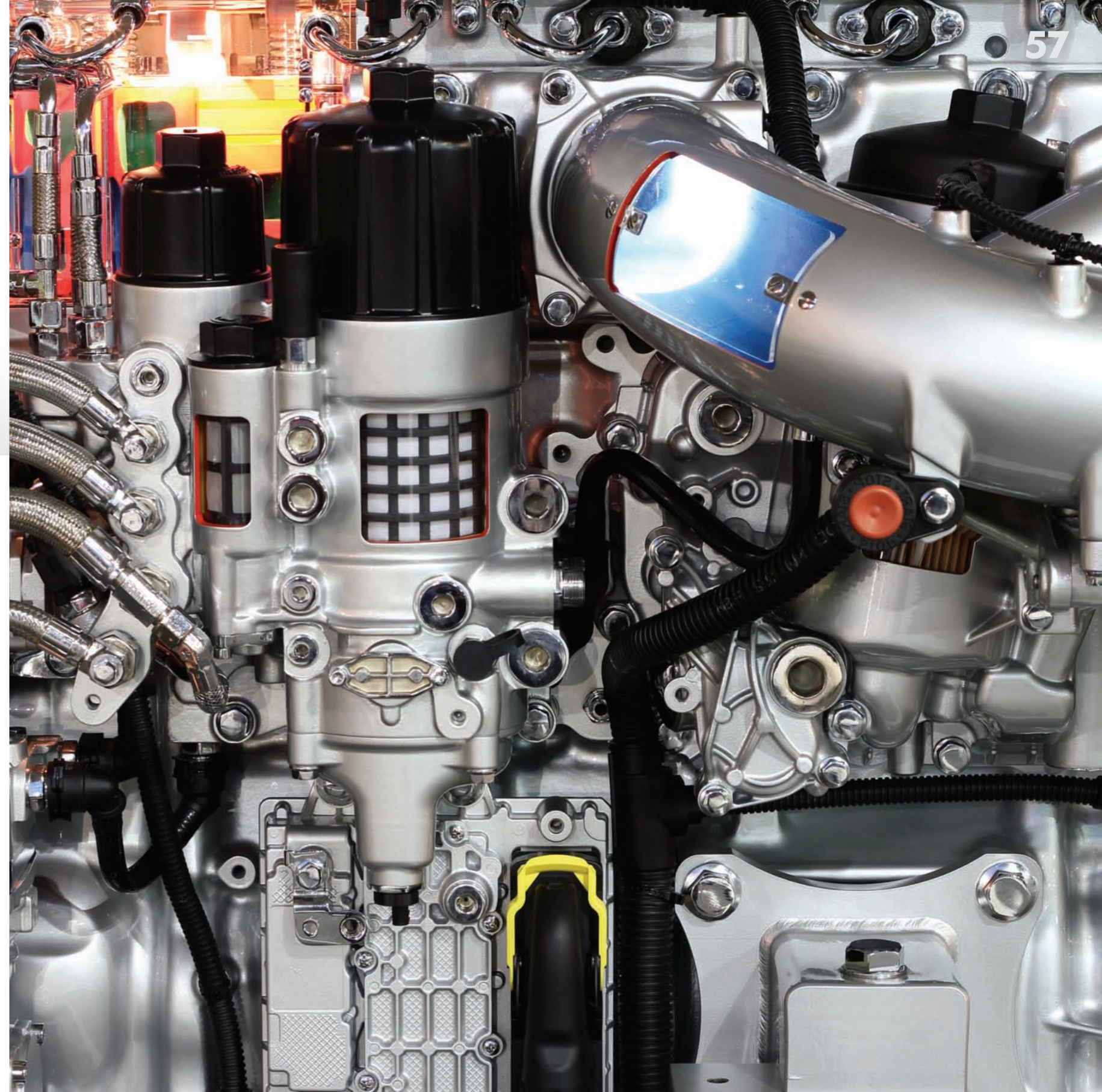

# METALWORKING FLUIDS

**SPECIAL PURPOSE LUKOIL PRODUCTS WERE DEVELOPED ON THE BASIS OF BOTH THE LEADING EUROPEAN EXPERIENCE WITH THE BEST WORLD PRACTICES AND THE UNIQUE STUDIES CONDUCTED AT ITS OWN R&D CENTER, WHICH MADE IT POSSIBLE TO UP-TO-DATE COMPOUNDING CONCEPTS FOR RUSSIAN OPERATION CONDITIONS.**

The metalworking fluids portfolio includes two product lines:

**LUKOIL FREO** water-soluble metalworking fluids manufactured with the usage of the most advanced components and additives, that ensures excellent performance characteristics of the working emulsion, namely excellent lubricating and anticorrosion properties with high resistance to biodeterioration.

LUKOIL FREO product line includes mineral, semi-synthetic and synthetic products, and various service products.

**LUKOIL INSO** neat metalworking fluids designed with highly refined base oils and top-quality additives, which ensures high performance properties of the products.

The LUKOIL INSO product line includes products with a viscosity of 5 to 32 mm<sup>2</sup>/s at 40°C, which are used for processes, such as honing, grinding, general machining, deep drilling.



# GREASES

**FLEX-SERIES GREASES HAVE HIGH PERFORMANCE CHARACTERISTICS AND PROVIDE RELIABLE PROTECTION OF EQUIPMENT COMPONENTS AGAINST WEAR AND EXTEND THE OPERATION LIFE OF EQUIPMENT.**

**LUKOIL POLYFLEX** are multipurpose lithium greases of a wide range of applications in various operating conditions. They are used in various units of medium to heavy loaded industrial and construction equipment.

**LUKOIL POLYFLEX HD** are solid-filled lithium greases that ensure safe operation of friction units under high pressure, repeated and impact loads.

**LUKOIL THERMOFLEX** are multipurpose high-quality greases based on lithium complex soap. They are used for various high-temperature friction units in the metallurgical and mining industries and for bearings of motor vehicles and electric engines. They can be used as full-service lubricants.

**LUKOIL CARBOFLEX** are special-purpose greases based on aluminum complex soap with a high content of solid lubricants. The greases have excellent adhesion to metal and an extremely high loading capacity. They are used for open gears and other equipment in the mining and cement industries.

**LUKOIL AQUAFLEX** are ultra-water-resistant high-temperature greases based on a mixture of highly refined mineral oils and complex calcium sulfonate. They have an increased loading capacity, are widely used in the metallurgical industry, for marine and river vessels, mining, paper-making and cement equipment.

**LUKOIL SYNTHOFLEX** are full-service greases based on a mixture of high-quality synthetic base oils thickened with a lithium complex soap using a special additive package. They are used for high-speed and high-temperature bearings of various equipment. They are efficient at low temperatures down to -50°C.

**LUKOIL PIPEFLEX** is a series of thread-sealing greases designed for the protection and sealing of oil and gas tubular goods. The greases have special compositions of solid lubricants that ensure high performance of pulling and running operations.

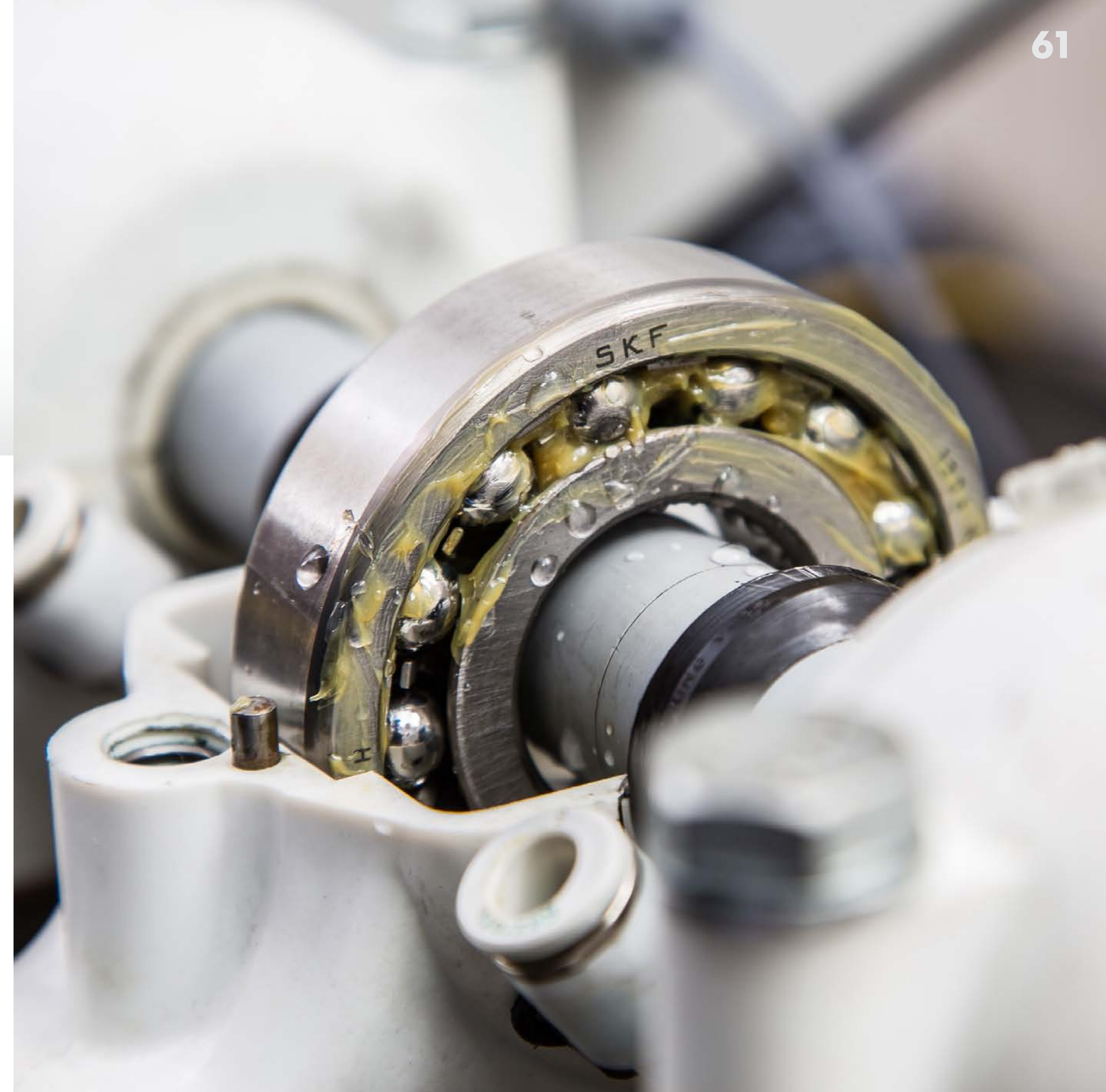

# PRODUCT PACKAGING



**1 DOUBLE CANISTER TOP**  
(polyethylene lid and special plastic insert) with a warranty ring and an aluminum insert eliminate the reuse of canisters.

**2 THREE-LAYER CANISTER WALLS**  
easily distinguishable after opening the canister. Multilayer canisters are manufactured using high-tech equipment and cannot be home-made.

**3 LABEL**  
soldered in the canister surface and protected from moisture and direct sunlight.

**4 FOILED NECK**  
eliminates oil spillage if the canister is tipped over and additionally protects it from counterfeiting.

**5 LASER MARKING**  
made on the label on the back of the canister indicates the production date and batch number of the product.

**6 UNIQUE SEQUENCE NUMBER**  
of the package is indicated on the label on the back of the canister.

## ADDITIONAL BOTTOM MARKING:

**7** ecolabel indicates that the canister is made of a recyclable material, encourages to protect the environment and return containers for recycling;

**8** designation of the used materials;

**9** month and year of production of the canister;

**10** LUKOIL trademark;

**11** number of the mold of the blowing machine.



**LUKOIL GENESIS**

Graphite canisters, black label with a metallized tape of various colors.



**LUKOIL LUXE RANGE**

Available in golden canisters with yellow label



**LUKOIL SUPER, LUKOIL STANDARD RANGES**

Available in silver canisters with red label.



**LUKOIL MOTO 2T, MOTO 4T, TRANSMISSION OILS, LUKOIL FLUSHING**

Silver canisters and the various colors labels.

**ATF SYNTH, DCTF, CVTF TRANSMISSION FLUIDS**

Graphite canisters, red label.



**LUKOIL AVANTGARDE RANGE**

Available in blue canisters with blue label and metallized tape.



# APPENDIXES

# LUBRICANTS CLASSIFICATION

## VISCOSITY GRADES (VGS) OF INDUSTRIAL LUBRICANTS ISO 3448 STANDARD

ISO VG Viscosity grade	Average kinematic viscosity at 40 °C mm <sup>2</sup> /s or cSt	Kinematic viscosity at +40 °C	
		MIN (mm <sup>2</sup> /s)	MAX (mm <sup>2</sup> /s)
2	2,2	1.98	2.42
3	3,2	2.88	3.52
5	4,6	4.14	5.06
7	6,8	6.12	7.48
10	10	9.00	11.0
15	15	13.5	16.5
22	22	19.8	24.2
32	32	28.8	35.2
46	46	41.4	50.6
68	68	61.2	74.8
100	100	90.0	110
150	150	135	165
220	220	198	242
320	320	288	352
460	460	414	506
680	680	612	748
1000	1000	900	1100
1500	1500	1350	1650
2200	2200	1980	2420
3200	3200	2880	3520

## LUBRICANT VISCOSITY GRADES AT VARIOUS TEMPERATURES

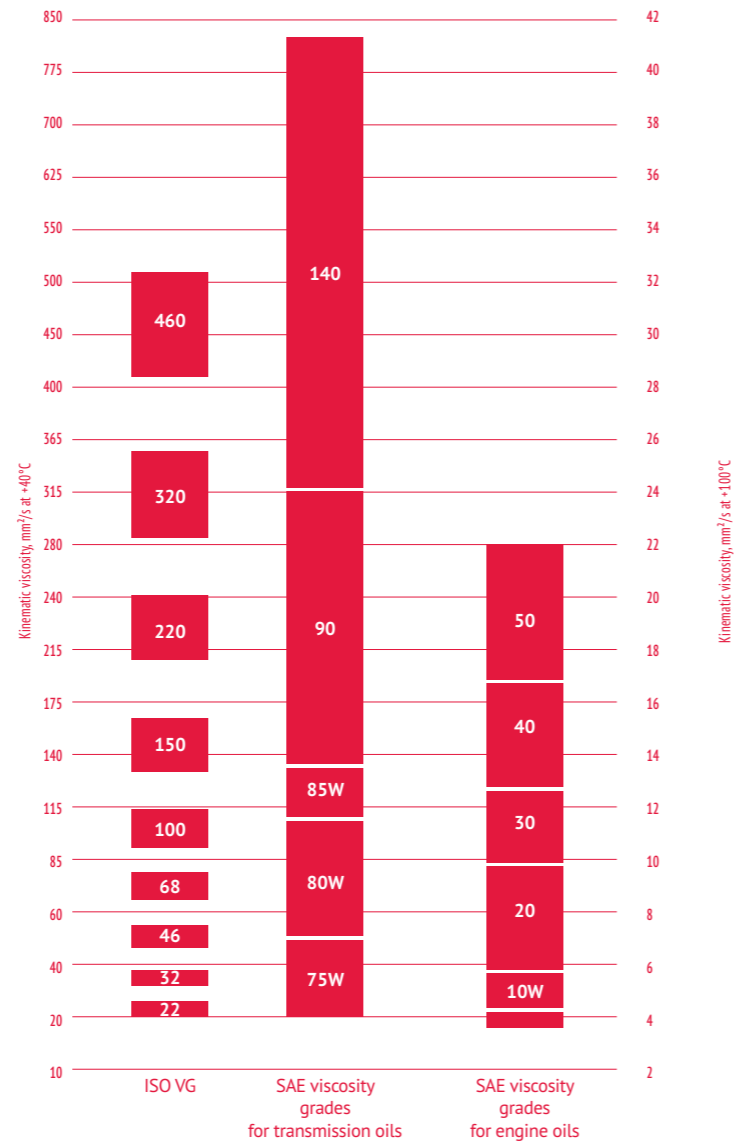

## SAE J300 ENGINE LUBRICANTS CLASSIFICATION

SAE viscosity grades	Dynamic viscosity, cP, max		Kinematic viscosity at 100°C, mm <sup>2</sup> /s		Dynamic viscosity at 150°C, cP, min
	Cold cranking simulation (CCS)	Pumpability	min	max	
0W	6200 at -35°C	60000 at -40°C	3.8		
5W	6600 at -30°C	60000 at -35°C	3.8		
10W	7000 at -25°C	60000 at -30°C	4.1		
15W	7000 at -25°C	60000 at -25°C	5.6		
20W	9500 at -15 °C	60000 at -20°C	5.6		
25W	13000 at -10°C	60000 at -15°C	9.3		
8			4	<6.1	1.7
12			5	<7.1	2
16			6.1	<8.2	2.3
20			6.9	<9.3	2.6
30			9.3	<12.5	2.9
40			12.5	<16.3	3.5 (0W-40, 5W-40, 10W-40)
40			12.5	<16.3	3.7 (15W-40, 20W-50, 25W-40, 40)
50			16.3	<21.9	3.7
60			21.9	<26.1	3.7

## OIL COMPATIBILITY

	Mineral oil	Synthetic HC (PAO)	Ethers	Polyglycols	Silicones
Mineral oil				incompatible	incompatible
Synthetic HC (PAO)				incompatible	incompatible
Ethers				incompatible	incompatible
Polyglycols	incompatible	incompatible			incompatible
Silicones	incompatible	incompatible	incompatible	incompatible	

□ compatible    ■ incompatible

# LUBRICANTS CLASSIFICATION (DIN / ISO)

**ΔKPF2P-30**

1 2 3 4 5

## 1 LUBRICANT'S CODE DIN

Base oil	Δ mineral	◇ synthetic
----------	--------------	----------------

## 2 LUBRICANT TYPE

lubricant type	lubricant type
plain and rolling bearings	K
closed gears	G
open gears	OG
rolling and sealing bearings	M
ethers	E
perfluoro hydrocarbons	FK
synthetic hydrocarbons	HC
phosphoesters	PH
polyglycols	PG
silicones	SI
other	X
additional symbols	
EP-additives	P
solid lubricants	F

## 3 NLGI LUBRICANT CLASSIFICATION

class NGLI	operating penetration in tenths of a millimeter		application
000	445 to 475	liquid lubricants	central lubrication system gearbox lubrication
00	400 to 430		
0	355 to 385		
1	310 to 340	soft lubricants	plain bearings rolling bearings
2	265 to 295		
3	220 to 250		
4	175 to 205		
5	130 to 160	solid lubricants	sealing lubricants and locking lubricants
6	85 to 115		

## 4 UPPER OPERATING TEMPERATURE

index	upper working temperature	water interaction according to DIN 51807**
C	+ 60 °C	0/40 °C or 1/40 °C
D	+ 60 °C	2/40 °C or 3/40 °C
E	+ 80 °C	0/40 °C or 1/40 °C
F	+ 80 °C	2/40 °C or 3/40 °C
G	+ 100 °C	0/90 °C or 1/90 °C
H	+ 100 °C	2/90 °C or 3/90 °C
K	+ 120 °C	0/90 °C or 1/90 °C
M	+ 120 °C	2/90 °C or 3/90 °C
N	+ 140 °C	additionally
P	+ 160 °C	
R	+ 180 °C	
S	+ 200 °C	
T	+ 220 °C	
U	+ 220 °C and higher	

\*\* 0 - no changes 1 - low changes 2 - average changes 3 - hard changes

## 5 LOWER OPERATING TEMPERATURE

additional index	lower operating temperature
- 10	- 10 °C
- 20	- 20 °C
- 30	- 30 °C
- 40	- 40 °C
- 50	- 50 °C
- 60	- 60 °C

## THICKENER COMPATIBILITY CHART

THICKENER	Aluminum complex	Barium Complex	Calcium hydride	Anhydrous calcium	Calcium Complex	Calcium sulfonate complex	Clay	Lithium	Lithium complex	Polyurea	Sodium
Aluminum complex											
Barium Complex											
Calcium hydride											
Anhydrous calcium											
Calcium Complex											
Calcium sulfonate complex											
Clay											
Lithium											
Lithium complex											
Polyurea											
Sodium											

## DISPERSION MEDIUM COMPATIBILITY CHART

Base oil	Ether	Mineral oil	Poly-alpha-olefins	Polyglycols	PFPE	Polyphenol ether	Methyl-siloxane liquids	Phenyl-siloxane liquid
Ether								
Mineral oil								
Poly-alpha-olefins								
Polyglycols								
PFPE								
Polyphenol ether								
Methyl-siloxane liquids								
Phenyl siloxane liquid								

□ compatible    ■ to be tested    ■ non compatible

**L-XBEGB 00**

1 2 3 4 5 6

## 1 ISO LUBRICANT CLASSIFICATION

## 2 LOWER OPERATING TEMPERATURE

indicator	lower operating temperature
A	0 °C
B	- 20 °C
C	- 30 °C
D	- 40 °C
E	<- 40 °C

## 3 UPPER OPERATING TEMPERATURE

indicator	lower operating temperature
A	60 °C
B	90 °C
C	120 °C
D	140 °C
E	160 °C
F	180 °C
G	>180 °C

## 4 INTERACTION WITH WATER

indicator	environment	protection
A	L	L
B	L	M
C	L	H
D	M	L
E	M	M
F	M	H
G	H	L
H	H	M
I	H	H

environment: L - dry; M - water, static; H - water, dynamic  
protection: L - no protection; M - fresh water protection; H - salt water protection

## 5 EXTREME PRESSURE PROPERTIES

A - no extreme pressure properties    B - extreme pressure properties

## 6 NGLI CLASS

LUKOIL GENESIS	28	PREMIUM ENGINE OILS
LUKOIL GENESIS SPECIAL	30	FOR SERVICE STATIONS
LUKOIL LUXE	32	ENGINE OILS
LUKOIL SUPER	34	ENGINE OILS
LUKOIL AVANTGARDE	36	FOR DIESEL ENGINES
LUKOIL TRANSMISSION	38	TRANSMISSION OILS
LUKOIL GEYSER	40	HYDRAULIC OILS
LUKOIL STEELO	42	GEAR OILS
LUKOIL STABIO	44	COMPRESSOR OILS
LUKOIL TORNADO	46	TURBINE OILS
LUKOIL SLIDO	48	SLIDEWAY OILS
LUKOIL INTEGO	50	ROLLING MILL OILS
LUKOIL ADVANTO/ SUPPORTO/ ROUND	52	CIRCULATING OILS
LUKOIL ASSISTO	54	QUENCHING OILS
LUKOIL EFFORCE	56	GAS ENGINES OILS
LUKOIL FREO / INSO	58	METALWORKING FLUIDS
LUKOIL FLEX	60	GREASES





Official online store  
**lukoil-shop.com**



[www.lukoil-masla.ru](http://www.lukoil-masla.ru)



[vk.com/lukoilmasla](https://vk.com/lukoilmasla)



[goo.gl/Ki8NdM](https://goo.gl/Ki8NdM)