

Single-Acting Low Profile Lock-Nut Cylinders - SLL

Doc. : L1046A Date : 2019/01

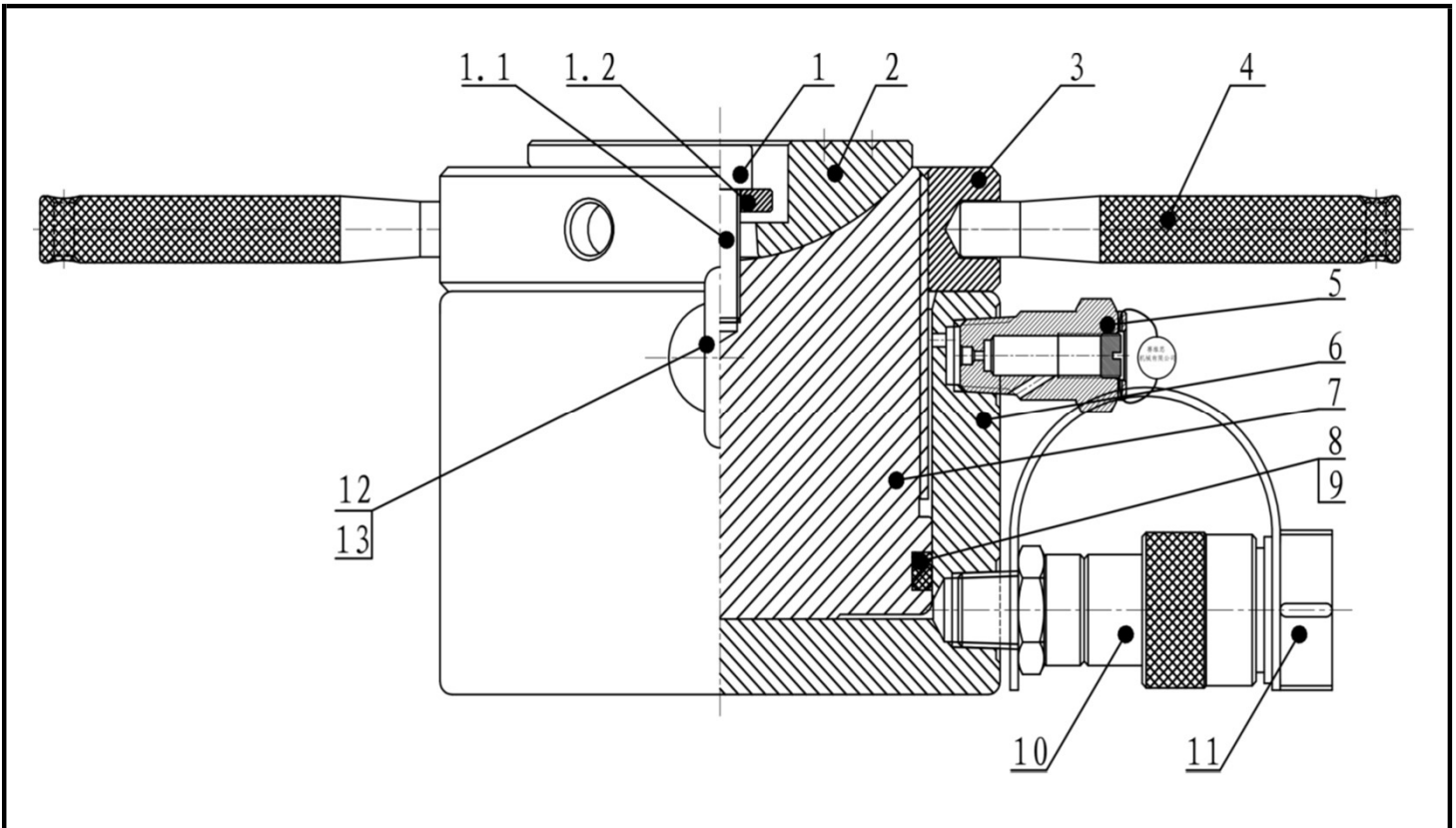

Item NO.	Description	Qty	Part NO.
			SLL200-50
1	Screw components	1	●
2	Lifting head	1	2.001.02726
3	Lock ring	1	2.001.01863
4	Handle	2	2.001.00876
5	Trip Limit valve	1	2.008.00050
6	Oil cylinder	1	2.001.01865
7	Piston rod	1	2.001.01864
8	Backup Washer	1	●
9	O - ring	1	●
10	Female connector	1	1.3.025.00004
11	Connector protective jacket for NPT3/8"	1	1.3.097.00002
12	Lifting bolt (Item #13 included)	2	1.3.009.00001
13	Hexagon nut	2	-
●	Repair kit	1	SLL200-RK