

Double-Acting High Tonnage Cylinders - DRC series

Doc. : L1016A Date : 2018/12

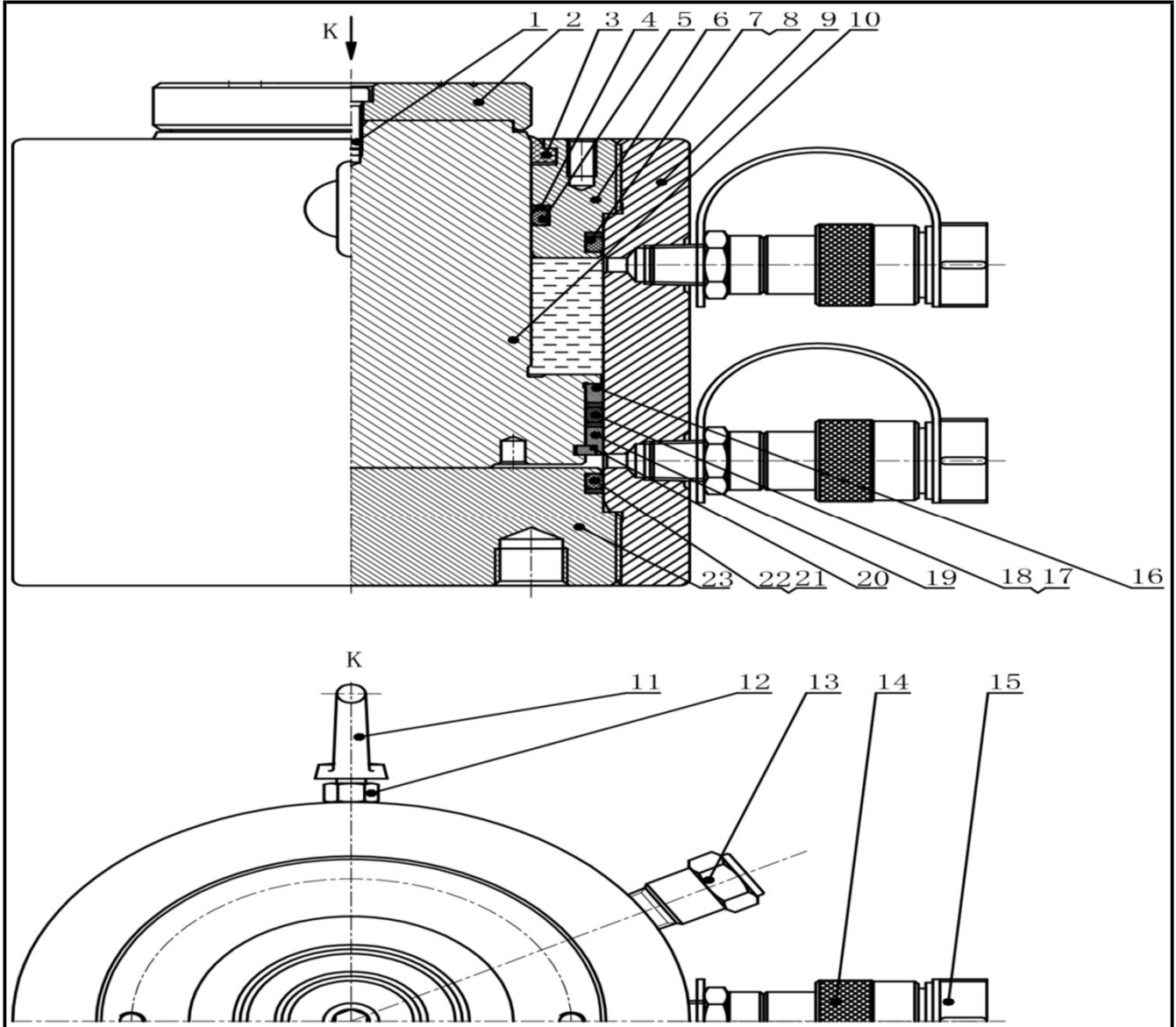

Item NO.	Description	Qty	Part NO.
			DRC400-100 DRC400-200 DRC400-300
1	Hexagon socket head cap screws	1	-
2	Lifting head (Item #1 included)	1	2.001.02750
3	J-dustband	1	•
4	Backup Washer	1	•
5	O-ring	1	•
6	Guide cap	1	2.001.02751
7	Backup washer	1	•
8	O-ring	1	•
9	Oil cylinder	1	2.001.02759 (DRC400-100)
		1	2.001.02752 (DRC400-200)
		1	2.001.02761 (DRC400-300)
10	Piston rod	1	2.001.02760 (DRC400-100)
		1	2.001.02753 (DRC400-200)
		1	2.001.02762 (DRC400-300)
11	Lifting bolt (Item #12 included)	2	1.3.009.00002
12	Hexagon nut	2	-
13	Safety valve	1	2.008.00047
14	Female connector	2	1.3.025.00004
15	Connector protective jacket for NPT3/8"	2	1.3.097.00002
16	Front guide sleeve	1	2.001.02755
17	Backup washer	2	•
18	O-ring	1	•
19	Back guide sleeve	1	2.001.02756
20	Semi-ring	1	2.001.02757
21	Backup washer	1	•
22	O-ring	1	•
23	Bottom cap	1	2.001.02758
•	Repair kit	1	DRC400-RK