



America's Favorite Garage Doors®

GARAGE DOORS THAT MAKE A STATEMENT



*Avante® / Black (Anodized) Frame with Frosted Insulated Glass
Photo Credit: @leisurehomes.ca*

PRODUCT SELECTION GUIDE



OPEN THE DOOR TO INSPIRATION

Whether it catches a neighbor's eye from the street or welcomes you home at the end of the day, a garage door often creates the first impression for your home.

It goes beyond material or function: The right garage door sets the tone.

Clopay's commitment to eye-catching, durable and reliable doors has made us North America's bestselling garage doors. If you want to complement your home's look, break the mold or simply protect the things that matter most to you, explore our wide selection of customizable designs to find a door you'll adore.

*Modern Steel™ / Modern Flush Panel Shown in Black
with Plain Long Windows in all panel locations*



EZDOOR™ VISUALIZER

TRY BEFORE YOU BUY

Clopay offers the widest range of garage door options to ensure there's a door to fit your home style. Our EZDoor™ visualizer lets you see a customized garage door directly on an image of your home — so you can be sure you love the look before committing. Scan the QR Code to get started.





IT'S EZ TO FIND A DOOR YOU ADORE

1. Upload a photo of your home or choose a stock image.
2. Browse recommended door styles to find a look you like and see it on your house.
3. Customize your door with unique colors, panel designs, windows, hardware and insulation.
4. Request a quote.

PRODUCT SELECTION TIPS



Consider maintenance and climate when choosing a construction material.

Clopay doors can be made in natural wood, steel, composite overlay, or aluminum and glass. Some materials require less surface upkeep than others over the life of the door.



Insulation matters. An energy-efficient garage door can keep your house 10–20 degrees warmer in the winter and cooler in the summer. It also reduces noise and improves durability.



Custom capabilities. Have a one-of-a-kind door in mind or trying to match a specific color scheme? We can build a door to your specifications and finish it in over 1,500 paint colors or stains.



GET STARTED
Visit EZDoor.Clopay.com

ALUMINUM & GLASS

Maximizing Indoor-Outdoor Connections

The perfect choice to modernize any home, our Avante® aluminum and glass garage doors turn an ordinary garage into a stunning architectural focal point. Fitted with tempered glass panels, the door fills the garage with natural light during the day and delivers a dramatic effect when the lights come on at night. The commercial-grade aluminum frame can be insulated and comes in a number of colors to complement your home, while a variety of glass and acrylic window options let you bring in as much or as little daylight needed without compromising privacy.





*Avante® / Bronze (Anodized) Frame with Clear Insulated Glass
Photo Credit: Andy Frame Photography*

AVANTE®

Clean lines, broad expanses of glass, and sleek, low-maintenance appeal have made the Avante® garage door a preferred choice among builders, architects and homeowners. Not just for the garage, owners are customizing this modern door in unique sizes and finishes to use as a patio, pool house or party barn door that opens up for gatherings when the weather is nice.



Model AXU

Model AX

STYLE AND CONSTRUCTION

- Aluminum frame provides a virtually maintenance-free, long-lasting door.
- Intellicore® polyurethane insulated rails and stiles. (Model AXU)
- R-value 3.8/U-Factor 0.86. (Model AXU when glazed with clear insulated glass)
- Section joint seal helps keep out air and water.
- Integral reinforcing fin provides increased strength and longevity. (Available on double car models)
- Heavy-duty steel ball bearing rollers with nylon tires provide quiet operation.

Doors wider than 14' include built-in reinforcing fin. Standard doors 12' and under do not use built-in reinforcing fin. Usage on widths 12'2" to 14' depends upon glass weight. WindCode® doors may vary.

Calculated door section R-value is in accordance with DASMA TDS-163.



DOOR DESIGNS



AX/AXU
Single car door



AX/AXU
Double car door

FRAME/SOLID PANEL COLOR OPTIONS

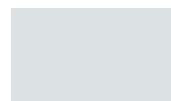

Clear Aluminum
(Anodized)

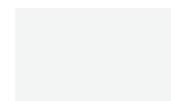

Standard White
(Painted)



Bronze
(Painted)



Chocolate
(Painted)



Bronze
(Anodized)



Black
(Anodized)



Dark Bronze
(Anodized)

Due to the anodizing process, color variation may occur. The use of "Bronze (Painted)" is recommended for a more consistent bronze finish color.

Choose a Color Blast® finish or RAL Powder Coating to create the perfect door. Model AXU not available with RAL Powder Coat finish.

modern ICON

Avante® / Black (Anodized) Frame with Frosted Tempered Glass
 Photo Credit: Andy Frème Photography

GLASS/PANEL OPTIONS



Clear Glass*



Gray Tinted Glass*



Midnight Gray Tinted Glass*



Bronze Tinted Glass*



Mirrored Glass*



Obscure Glass*



Clear Laminate Impact Rated Glass[†]



White Laminate Glass

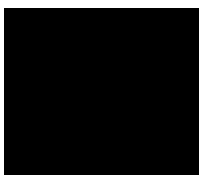

Black Laminate Glass



Clear Acrylic



Frosted Glass* (Satin Etched)



Frosted Acrylic

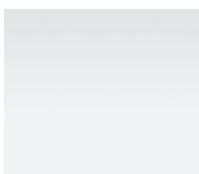

White Acrylic



Clear Polygal™

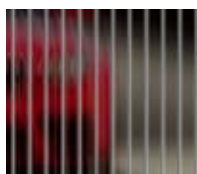

Bronze Polygal™



Clear Anodized (Color-matched to frame)

- Glass available in single pane or insulated (laminated and mirrored glass not available insulated).
- Panels can be aluminum to match the frame. Glass/acrylic panels may be combined with aluminum panels.
- Custom glass and colors available.

*Glass is tempered.

[†] 5/16" clear, white, gray and bronze laminate impact rated glass is available only on AXW8/AXUW8.

Acrylic windows require special cleaning. See care and maintenance manual.

WARRANTIES





VertiStack® Avante® / Bronze (Anodized) Frame with Midnight Gray Tinted Glass; Features Standard Black Powder-Coated Track and Guide Covers. Photo Credit: Andy Frame Photography.

COMPACT vertical STACKING door

VERTISTACK® AVANTE®

Connect to the outdoors with our VertiStack® Avante® modern aluminum and glass garage door. The unique, compact design stacks sections vertically on the wall above the opening, eliminating the need for exposed hinges, cable or overhead track for a crisp, clean look. Closed, the glass panel door lets in daylight and outdoor views. When opened, the interior footprint extends outside, creating an easy flow during gatherings.



Model VSAXU

Model VSAX

STYLE AND CONSTRUCTION

- Aluminum frame provides a virtually maintenance-free, long-lasting door.
- Intellicore® polyurethane insulated rails and stiles. (Model VSAXU)
- Section joint seal helps keep out air and water.
- Heavy-duty steel ball bearing rollers with nylon tires provide quiet operation.

DOOR DESIGNS

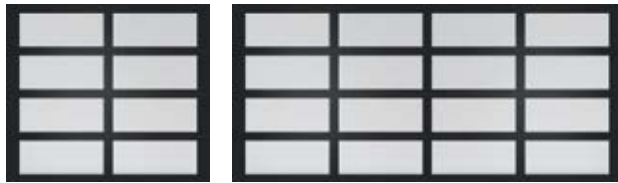

VSAX/VSAXU
Single car door

VSAX/VSAXU
Double car door

FRAME/SOLID PANEL COLOR OPTIONS



Due to the anodizing process, color variation may occur. The use of "Bronze (Painted)" is recommended for a more consistent bronze finish color.

Choose a Color Blast® finish or RAL Powder Coating to create the perfect door. Model VSAXU not available with RAL Powder Coat finish.

GLASS/PANEL OPTIONS



*Glass is tempered.

† Impacted rated glass is not available on VSAX/VSAXU models.

Glass available in single pane or insulated (laminated and mirrored glass not available insulated). Panels can be aluminum to match the frame. Glass/acrylic panels may be combined with aluminum panels. Custom glass and colors available. Acrylic windows require special cleaning. See care and maintenance manual.

OPEN CONCEPT

The stacked sections require minimal projection off of the wall, so the door doesn't interfere with mechanical, electrical or plumbing fixtures, leaving room for fans, lighting, overhead storage or extended height ceilings. The sections can even be recessed into a ceiling soffit so when the door is open, no one will know it's there.

For residential applications and interior mount only. Drawing shown with optional spring cover.

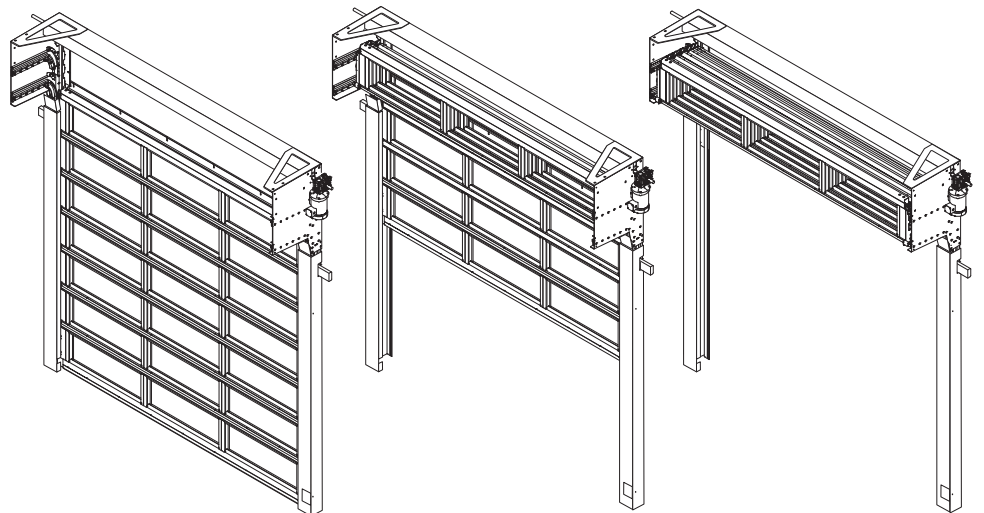

AVANTE[®] SLEEK

A departure from the standard grid-like pattern, the Avante[®] Sleek has slim horizontal windows and minimal vertical stiles for wide, unobstructed views. If you're in search of a garage door with a minimalist frame design that gives off "panoramic vibes" and lets in plenty of daylight, this is it. Customize the door in a number of painted or anodized finishes and glazing options.



Model AZ6U

Model AZ6

STYLE AND CONSTRUCTION

- Aluminum frame provides a virtually maintenance-free, long-lasting door.
- Intellicore[®] polyurethane insulated rails and stiles. (Model AZ6U)
- Section joint seal helps keep out air and water.
- Integral reinforcing fin provides increased strength and longevity. (Available on double car models)
- Heavy-duty steel ball bearing rollers with nylon tires provide quiet operation.

Doors wider than 14' include built-in reinforcing fin. Standard doors 12' and under do not use built-in reinforcing fin. Usage on widths 12'2" to 14' depends upon glass weight. WindCode[®] doors may vary.

Calculated door section R-value is in accordance with DASMA TDS-163.



DOOR DESIGNS



AZ6/AZ6U
Single car door



AZ6/AZ6U
Double car door

FRAME COLOR OPTIONS

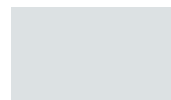

Clear Aluminum
(Anodized)

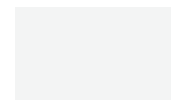

Standard White
(Painted)



Bronze
(Painted)



Chocolate
(Painted)



Bronze
(Anodized)



Black
(Anodized)



Dark Bronze
(Anodized)

Due to the anodizing process, color variation may occur. The use of "Bronze (Painted)" is recommended for a more consistent bronze finish color.

Choose a Color Blast[®] finish or RAL Powder Coating to create the perfect door. Model AZ6U not available with RAL Powder Coat finish.



EXPAND your VIEW

Avante® Sleek / Black (Anodized) Frame with Frosted Acrylic

GLASS OPTIONS



Clear Glass*



Gray Tinted Glass*



Midnight Gray
Tinted Glass*



Bronze Tinted Glass*



Mirrored Glass*



Clear Laminated Glass

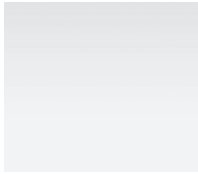

White Laminated Glass



Gray Laminated Glass



Bronze Laminated Glass



Black Laminated Glass



Clear Acrylic



Frosted Acrylic

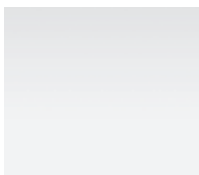

White Acrylic



Gray Acrylic



Bronze Acrylic

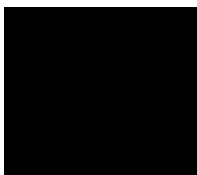

Black Acrylic

- Glass available in single pane or insulated (laminated and mirrored glass not available insulated).
- Custom glass and colors available.

*Glass is tempered.

Acrylic windows require special cleaning.
See care and maintenance manual.

WARRANTIES



STEEL

Strength and Durability That Fits Your Style

Strong and durable, steel is the backbone of almost every garage door. It also offers the most possibilities when it comes to door size, insulation, windows, pattern and color. Yes, color! If you are considering a steel door, you'll definitely want to explore our Ultra-Grain® wood-look and Lustra™ matte finishes. If you haven't looked at garage doors lately, you'll be pleasantly surprised to find endless ways to make a steel door stand out.





*Gallery® Steel / Long Panel; Shown in
Ultra-Grain® Oak Medium Finish with REC14 Windows
Photo Credit: Randi Lynne Creative, IG @randilynncreative*

GALLERY[®] STEEL

We've taken the iconic raised panel steel garage door and given it a vintage feel by adding a grooved panel design, optional windows, decorative wrought iron hardware and many unique color choices, including our Ultra-Grain[®] wood-look and Lustra[™] matte finishes. The result is classic, versatile styling and durability at a price that bridges the gap between simply being on your wish list and reality.



STYLE AND CONSTRUCTION

- 1-layer, 2-layer or 3-layer construction with short or long vertical grooved steel panels.
- Intellicore[®] polyurethane or polystyrene insulation. R-values from 6.3 to 18.4.
- Hot-dipped galvanized steel skin with a baked-on primer and top coat helps ensure durability and long-lasting beauty.
- Glass options include clear, midnight gray, frosted, seeded, rain, obscure and wrought iron designs as well as insulated. Grilles are removable for easy cleaning. See page 61 for details.
- Comes with spade lift handles and step plates. See page 62 for more options.

Calculated door section R-value is in accordance with DASMA TDS-163.



DOOR DESIGNS



Short



Long

DETAIL

Deep-embossed panels with smooth, stucco or woodgrain surface texture.



WARRANTIES

PAINT SYSTEM	PAINT SYSTEM	WINDOW	HARDWARE
LIMITED LIFE WARRANTY*	LIMITED 15YR WARRANTY*	LIMITED 10YR WARRANTY	LIMITED 3YR WARRANTY

**Lifetime Paint System warranty on most models. 15-Year Paint System warranty on 25 gauge, 1 and 2-layer models.*



VINTAGE style with updated APPEAL

COLORS



Standard White Almond Desert Tan Sandtone Bronze*



Chocolate Mocha Brown* Charcoal* Iron Ore*† Black*†



Lustra™ Black*† Lustra™ Charcoal*† Lustra™ Silver*†



Ultra-Grain® Oak Medium Finish*† Ultra-Grain® Oak Dark Finish*† Ultra-Grain® Oak Walnut Finish*† Ultra-Grain® Oak Slate Finish*†

*Not available on all models.

† Additional charges apply.

Steel surface texture will vary depending on door model.
Doors can be custom painted. See Color Blast® on page 63.
See page 25 for information about Lustra™ finishes.
Due to the printing process, colors may vary.

WINDOWS

GLASS



Plain Short

REC12

SQ22



Plain Long

REC14

SQ24



ARCH1

Vertical Grille on ARCH1

Grille on ARCH1



ARCH2

Vertical Grille on ARCH2

Grille on ARCH2

ACRYLIC



Wrought Iron Short

Wrought Iron Long

Wrought Iron Arch

Additional double width door designs available.

Acrylic windows require special cleaning. See care and maintenance manual.



enduring
SIMPLICITY

*Bridgeport™ Steel / Extended Panel;
Shown in Black with REC12 Windows
Photo Credit: This Old House*

BRIDGEPORT™ STEEL

Travel back to simpler times and symmetry found in traditional stile and rail recessed panel doors — updated in a durable, stylish steel construction. Go retro with a long panel profile or add contemporary flair to your home with a narrow vertical panel design. Available with or without insulation, Bridgeport™ Steel is virtually maintenance-free, so the first fabulous impression becomes a lasting one.



STYLE AND CONSTRUCTION

- 1-layer, 2-layer or 3-layer construction with narrow and extended, recessed steel panels.
- Intellicore® polyurethane or polystyrene insulation. R-values ranging from 6.3 to 18.4.
- Hot-dipped galvanized steel skin with a baked-on primer and top coat helps ensure durability and long-lasting beauty.
- Glass options include clear, midnight gray, frosted, seeded, rain, obscure and wrought iron designs as well as insulated. Grilles are removable for easy cleaning. See page 61 for details.
- Comes with color-matched lift handles. See page 62 for more options.

Calculated door section R-value is in accordance with DASMA TDS-163.

DOOR DESIGNS



Narrow



Extended

DETAIL

A recessed panel replicates the look of a traditional stile and rail built door.

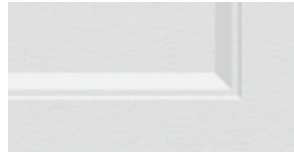

WARRANTIES

PAINT SYSTEM LIMITED LIFE WARRANTY*	PAINT SYSTEM LIMITED 15YR WARRANTY*	WINDOW LIMITED 10YR WARRANTY	HARDWARE LIMITED 3YR WARRANTY
--	--	---	--

**Lifetime Paint System warranty on most models. 15-Year Paint System warranty on 25 gauge, 1 and 2-layer models.*

COLORS



**Not available on all models.*

†Additional charges apply.

Steel surface texture will vary depending on door model.

Doors can be custom painted. See Color Blast® on page 63.

See page 25 for information about Lustra™ finishes.

Due to the printing process, colors may vary.

WINDOWS

GLASS



Plain Short



Plain Long



ARCH1



ARCH2



REC12



REC14



Vertical Grille on ARCH1



Vertical Grille on ARCH2



SQ22



SQ24



Grille on ARCH1



Grille on ARCH2

ACRYLIC



Wrought Iron Short



Wrought Iron Long



Wrought Iron Arch

Additional double width door designs available.

Acrylic windows require special cleaning. See care and maintenance manual.



BRIDGEPORT™ INLAY

Our Bridgeport™ Inlay series brings together timeless Shaker-inspired design and modern simplicity to create a look that feels both fresh and familiar. Clean, recessed panel steel doors provide lasting durability and low maintenance, while new inlay options add the warmth and character of a classic carriage house style. With a palette of 10 beautiful standard paint colors, warm Ultra-Grain® wood-look finishes, and optional decorative windows that invite in natural light, these doors are designed to elevate your home's exterior and reflect your personal style.

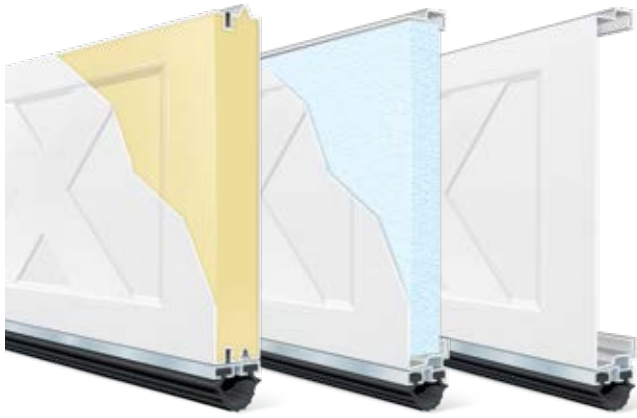

STYLE AND CONSTRUCTION

- 1-layer, 2-layer or 3-layer construction with extended recessed steel panels.
- Intellicore® polyurethane or polystyrene insulation. R-values ranging from 6.3 to 18.4.
- Hot-dipped galvanized steel skin with a baked-on primer and top coat helps ensure durability and long-lasting beauty.
- Glass options include clear, midnight gray, frosted, seeded, rain, obscure and wrought iron designs as well as insulated. Grilles are removable for easy cleaning. See page 61 for details.
- Comes with color-matched lift handles. See page 62 for more options.

Calculated door section R-value is in accordance with DASMA TDS-163.

INLAY DESIGNS



DETAIL

Inlays have a subtle, pebbled texture to complement the door's embossed stucco or woodgrain surface.



COLORS



**Not available on all models.*

†Additional charges apply.

Steel surface texture will vary depending on door model.

Doors can be custom painted. See Color Blast® on page 63.

Due to the printing process, colors may vary.

WARRANTIES

PAINT SYSTEM LIMITED LIFE WARRANTY*	PAINT SYSTEM LIMITED 15YR WARRANTY*	WINDOW LIMITED 10YR WARRANTY	HARDWARE LIMITED 3YR WARRANTY
--	--	---	--

**Lifetime Paint System warranty on most models. 15-Year Paint System warranty on 25 gauge, 1 and 2-layer models.*

WINDOWS

GLASS

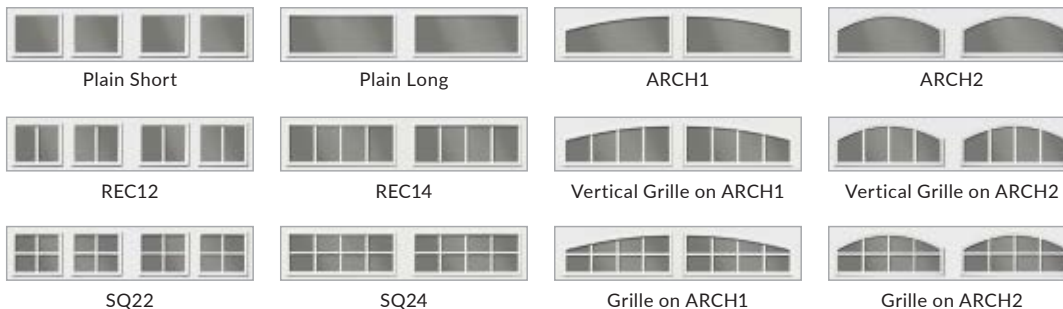

ACRYLIC

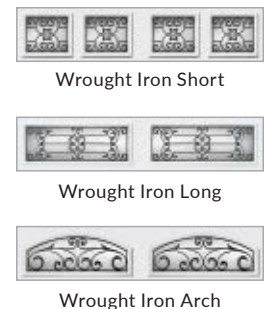

Additional double width door designs available. Acrylic windows require special cleaning. See care and maintenance manual.



clean lines with
MID-CENTURY APPEAL

*Modern Steel™ / Modern Flush Panel Shown in Black
with Plain Long Vertically Stacked Windows Down Right Side
Photo Credit: @triodevelops*

MODERN STEEL™

Whether it's a modern makeover or a retro redo, our Modern Steel™ garage doors come in many low-maintenance styles to boost your home's curb appeal. Let your creativity flow as you design a door with or without grooves, add square, rectangular or contemporary slim windows in a unique layout, or keep it sleek with a solid flush panel motif. All are available in multiple paint colors, as well as Ultra-Grain® wood-look and Lustra™ matte finishes to match the look for your home.

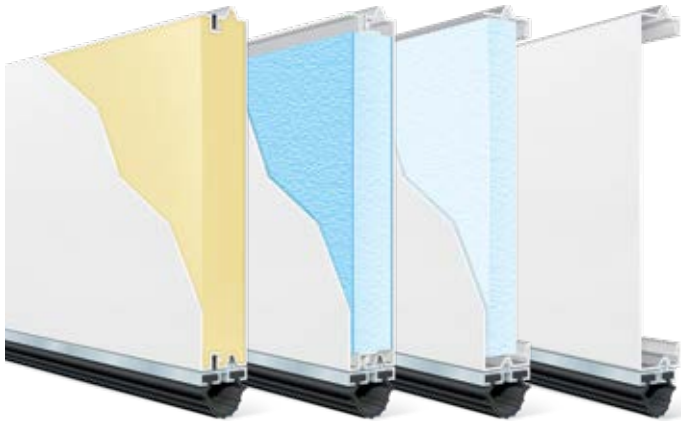

DOOR DESIGNS



Modern Flush



Modern Grooved

STYLE AND CONSTRUCTION

- Intellicore® polyurethane or polystyrene insulation with R-values ranging from 6.3 to 18.4.
- 1-layer, 2-layer or 3-layer construction. Exterior steel on Modern Flush and Grooved doors have a smooth, stucco or woodgrain texture.

Calculated door section R-value is in accordance with DASMA TDS-163.

WARRANTIES

PAINT SYSTEM LIMITED LIFE WARRANTY	WINDOW LIMITED 10YR WARRANTY	HARDWARE LIMITED 3YR WARRANTY
--	--	---

WINDOWS

See pages 30–31 for window options.

COLORS

Standard White	Almond	Desert Tan	Sandtone	Bronze*	Chocolate	Mocha Brown*	Hunter Green*
						<p><i>*Not available on all models. †Additional charges apply. Steel surface texture will vary depending on door model. Doors can be custom painted. See Color Blast® on page 63. See page 24 for more information about Lustra™ and Ultra-Grain® Plank finishes. Due to the printing process, colors may vary.</i></p>	
Charcoal*	Iron Ore*†	Black*†	Lustra™ Black*†	Lustra™ Charcoal*†	Lustra™ Silver*†		
Ultra-Grain® Plank Coastal Gray*†	Ultra-Grain® Plank Natural*†	Ultra-Grain® Plank Cedar*†	Ultra-Grain® Plank Kona*†	Ultra-Grain® Plank Barnwood*†	Ultra-Grain® Plank Espresso*†		
Ultra-Grain® Cypress Medium Finish*†	Ultra-Grain® Cypress Cherry Finish*†	Ultra-Grain® Cypress Walnut Finish*†	Ultra-Grain® Cypress Slate Finish*†				

CONTEMPORARY WINDOWS

Modern Steel™ doors offer short, long and contemporary slim windows, in many configurations including down one side and in all sections. For doors with multiple windows, the location must be the same in every section.



Short Plain Windows down one side



Long Plain Windows in all panel locations



Contemporary Slim Windows down one side

NEW FINISH CHOICES

ULTRA-GRAIN® PLANK

Rustic meets modern on this unique flush panel Modern Steel™ door design featuring digitally printed horizontal planks with a wood-look appearance. The planks vary in length with no repeating grain pattern and a nice tonal variation for visual interest.

- Complements mid-century, farmhouse, coastal cottage and transitional home styles.
- Steel surface has an embossed stucco texture.
- Window frames are painted a solid color to complement Ultra-Grain finishes or come in contrasting Silver and Black accent colors.



Coastal Gray



Natural



Cedar



Kona



Barnwood



Espresso



Modern Steel™ / Modern Flush Panel Shown in Ultra-Grain® Plank Kona Finish with Contemporary Slim Frosted Windows and Black Frames Down Left Side



*Modern Steel™ / Modern Flush Panel Shown in Lustra™ Black Finish with Contemporary Slim Frosted Windows and Black Frames Down Left/Right Side
Photo Credit: Joel Gamble/Klassick Vizion Studios LLC*

MATTE LUSTRA™ FINISH

Prefer a different look than an embossed woodgrain or stucco steel surface texture? Our Modern Steel™ garage doors also come in Lustra™, a low-gloss matte finish available in Black, Charcoal and Silver. Paired with contemporary slim windows or as a solid door, it's easy to create an eye-catching modern facade that's both energy efficient and durable.

- Available on select Gallery® Steel, Bridgeport™ Steel and Modern Steel™ garage doors. (24-gauge steel models only)
- Due to the finish texture, Lustra™ doors cannot be painted a different color.



Black



Charcoal



Silver

*Classic™ Steel / Short Elegant Panel; Shown in
Ultra-Grain® Classic Cherry Finish with Plain Short Window Design*



ENERGY SAVER
in every season

CLASSIC™ STEEL

PREMIUM

Available in a wide range of looks and colors, Clopay's Classic™ Steel Premium insulated doors complement every home so there's no sacrificing style for strength, durability and comfort. The traditional raised-panel style garage door comes in several design and construction options, allowing you to take the time-tested, classic door and make it your own. Choose from a variety of decorative window inserts and specialty glass for natural light and privacy.



STYLE AND CONSTRUCTION

- 3-layer, steel construction for energy efficiency, quiet operation and maximum durability.
- 2" or 1-3/8" Intellicore® polyurethane or bonded polystyrene insulation. R-values from 6.5 to 18.4.

Calculated door section R-value is in accordance with DASMA TDS-163.

COLORS



Standard White

Almond

Desert Tan

Sandtone

Bronze



Chocolate

Mocha Brown*

Hunter Green*

Charcoal*

Iron Ore*†

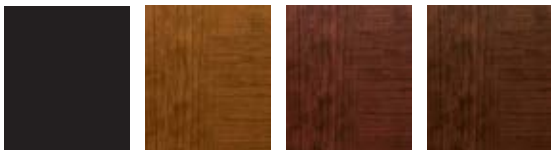

Black†

Ultra-Grain®
Classic
Medium Finish*†

Ultra-Grain®
Classic
Cherry Finish*†

Ultra-Grain®
Classic
Walnut Finish*†

*Not available on all models.

† Additional charges apply.

Doors can be custom painted. See Color Blast® on page 63.

Doors with standard colors have woodgrain-textured steel surface.

Doors with Ultra-Grain® finish have stucco-textured steel surface.

Due to the printing process, colors may vary.

DOOR DESIGNS



Short Elegant



Long Elegant

DETAIL

Decorative panel edging and natural-embossed woodgrain or stucco (Ultra-Grain only) texture.



WARRANTIES



WINDOWS

Available with insulated or non-insulated windows.

See pages 30-31 for options.



*Classic™ Steel / Short Elegant Panel;
Shown in Chocolate with Colonial 509 Window Design*



*Classic™ Steel / Short Traditional Panel;
Shown in White with Colonial 509 Window Design*

CLASSIC™ STEEL

VALUE PLUS AND VALUE

Available in 24 or 25-gauge steel with 1-5/16" polystyrene insulation, Value Plus models offer moderate insulating R-values, strength and security, as well as quiet operation and a beautiful appearance. Value garage doors are available in 24 or 25-gauge steel on a durable 2" steel frame without insulation. Choose from two panel styles with several colors and window options to enhance your home's curb appeal.



STYLE AND CONSTRUCTION

- Quality 24 or 25-gauge steel construction for durability and longevity.
- Polystyrene, vinyl-backed insulation for improved energy efficiency. 6.3 R-value.
- Woodgrain-textured short and long raised panel designs complement many home styles.

Calculated door section R-value is in accordance with DASMA TDS-163.

WARRANTIES

PAINT SYSTEM LIMITED LIFE WARRANTY	PAINT SYSTEM LIMITED 25YR WARRANTY	PAINT SYSTEM LIMITED 15YR WARRANTY	WINDOW LIMITED 10YR WARRANTY	HARDWARE LIMITED 3YR WARRANTY
24 gauge	25 gauge 2-layer	25 gauge 1-layer		

DOOR DESIGNS



Short Traditional



Long Traditional

DETAIL

Decorative panel edging and natural-embossed woodgrain texture.



COLORS

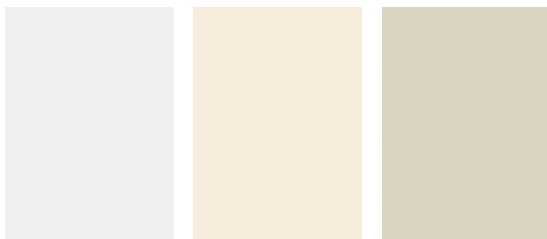

Standard White

Almond

Desert Tan



Sandtone

Chocolate

Black*†

**Not available on all models.*

† Additional charges apply.

Doors can be custom painted. See Color Blast® on page 63. Due to the printing process, colors may vary.

WINDOWS

See pages 30–31 for options.



*Classic™ Steel / Short Traditional Panel;
Shown in White with Plain Short Window Design*

WINDOWS

FOR MODERN STEEL™ AND CLASSIC™ STEEL GARAGE DOORS

DECORATIVE INSERT SERIES*

Clopay Decorative Inserts are made of tough UV-protected cellular plastic. Glass available in clear, obscure, acrylic and insulated options. Inserts are removable for easy cleaning.



Colonial 509



Charleston 508



Prairie 510



Stockton 612



Charleston 608



Prairie 610



Madison 611



Madison Arch 613



Sunset 501*
(8', 9', 12', 16', 17', 18', 20' widths only)



Sunset 502* (7', 7'6", 12' widths only)



Sunset 601*



Sunset 503* (8', 9', 16', 17', 18' widths only)



Sunset 504* (14', 15', 15'6" widths only)



Sunset 505* (16', 17', 18' widths only)



Sunset 506* (10', 20' widths only)



Sunset 603*



Sunset 605* (15', 15'6", 16', 17', 18' widths only)

Not all windows available on all models. Insulated glass available only on Modern Steel™ and Classic™ Steel Premium garage doors. Panel emboss may not align on long window with short panels.





**Sunset windows not available on Ultra-Grain® finish doors. Decorative Insert Series windows available on select Modern Steel™ garage doors.*





CONTEMPORARY/ARCHITECTURAL SERIES (GLASS)





Featuring a larger viewing area, these windows are available on 2" and 1-3/8" Modern Steel™ and Classic™ Steel Premium, Intellicore® polyurethane insulation doors. Also available on select 2" and 1-3/8" Modern Steel™ and Classic™ Steel polystyrene doors. Insulated glass is optional.

†Wrought Iron acrylic windows not available insulated. Additional double width door designs available.



PLAIN

 Plain Short
  Plain Long
  ARCH2
  ARCH1

  REC12
  REC14
  Vertical Grille on ARCH2
  Vertical Grille on ARCH1

  SQ22
  SQ24
  Grille on ARCH2
  Grille on ARCH1

ACRYLIC

 Wrought Iron Short[†]
 Wrought Iron Long[†]
 Wrought Iron Arch[†]

Acrylic windows require special cleaning. Never use products that contain ammonia or petroleum products to clean acrylic. See care and maintenance manual.

CONTEMPORARY SLIM (GLASS)

Designed to enhance the clean aesthetic common to mid-century modern architecture. Contemporary Slim windows are 37" x 8" with aluminum frames available in powder coated silver or black on select insulated 2" thick Modern Steel™ doors.



Glass is available in different designs depending on door model. Options include acrylic, clear, midnight gray, frosted, seeded, obscure and rain, as well as insulated versions for a more energy efficient door.

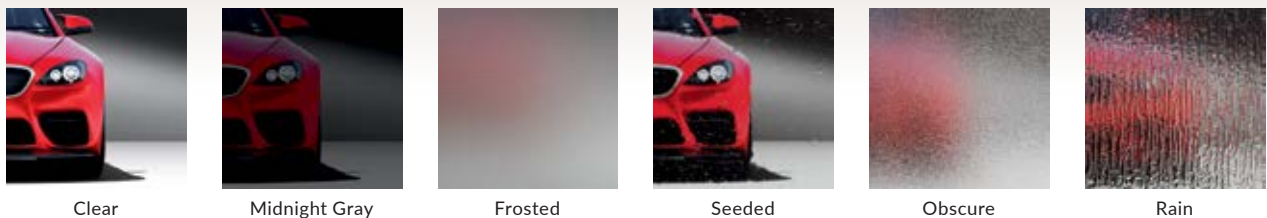

See page 61 for details.

COMPOSITE OVERLAY

The Look of Wood Without the Upkeep

For homeowners who want the look of wood without the upkeep, composite overlay doors are an excellent choice. Our faux-wood doors are constructed with an insulated steel base door for strength and durability and topped with a moisture-resistant composite overlay molded from natural wood boards. This gives the doors their realistic grain patterns and textures while keeping them low-maintenance. Like wood, the doors can be painted, and in most instances, stained, for a look that is distinctly yours.





*Canyon Ridge® / Louver, Design 52; Shown in Walnut Finish with Louver Mahogany Cladding, Mahogany Overlays and REC14 Window Design
Photo Credit: Andy Frame Photography*



faux wood
REAL BEAUTY

*Canyon Ridge® / Carriage House 5-Layer Design 13; Shown in Dark Finish
with Mahogany Cladding, Mahogany Overlays and REC13 Window Design
Photo Credit: Andy Framé Photography*

CANYON RIDGE® Carriage House

5-LAYER CONSTRUCTION

Canyon Ridge® Carriage House 5-Layer garage doors capture the charm of old-world carriage style doors in a durable, moisture-resistant construction. Composite overlays give you a low-maintenance wood alternative that looks and feels like the real thing, and the peace of mind that comes from having a superior insulated steel core construction. Choose from two species: Clear Cypress or Mahogany, and a variety of paint and stain colors to create a custom look. The result is a stunning carriage house door you will enjoy for years to come.



- 1 COMPOSITE OVERLAY
- 2 COMPOSITE CLADDING
- 3 STEEL
- 4 2" INTELLICORE® POLYURETHANE INSULATION
- 5 STEEL



STYLE AND CONSTRUCTION

- 5-layer composite faux-wood doors with Intellicore® polyurethane insulation. 20.4 R-value.
- Insulated glass styles include clear, frosted, seeded, rain and obscure. See page 61 for details.
- Removable clip-in window grilles for easy cleaning.
- Spade lift handles and step plates included. See page 62 for more options.

Calculated door section R-value is in accordance with DASMA TDS-163. Canyon Ridge® doors not applicable for new construction in California areas designated as "Fire Hazard Severity Zones".

DOOR DESIGNS

SERIES 1

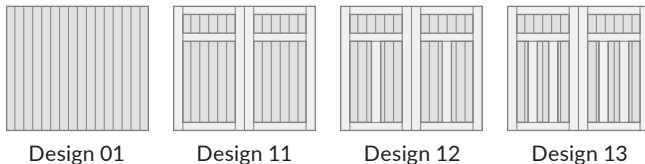

Design 01 Design 11 Design 12 Design 13

SERIES 3

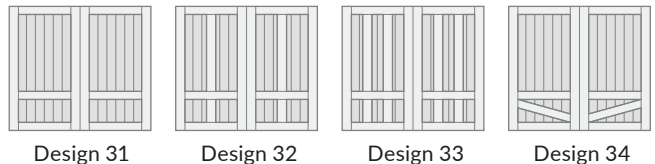

Design 31 Design 32 Design 33 Design 34

SERIES 2



Design 21 Design 22 Design 23

Design 01 does not have overlays.

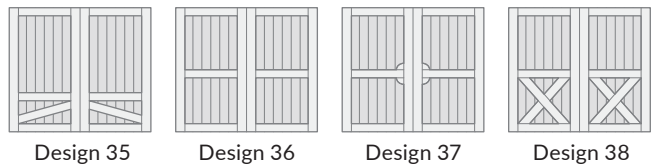

Design 35 Design 36 Design 37 Design 38

MATERIAL DESIGN OPTIONS

CLADDING



Clear Cypress (C) Mahogany (M)

OVERLAY



Clear Cypress (C) Mahogany (M)

Composite cladding and overlay material options may be mixed and matched.

COLORS



Doors can be ordered primed for custom field painting or staining. Door stain color may vary due to finishing process.

**Bronze, Charcoal, Black and White Finish available only on Mahogany cladding and overlays. Two-tone doors are available. To see all options go to ezdoor.clopay.com.*

Due to the printing process, colors may vary. Order free color samples at clopaydoor.com/requestcolorssamples.

WINDOWS/TOP SECTIONS

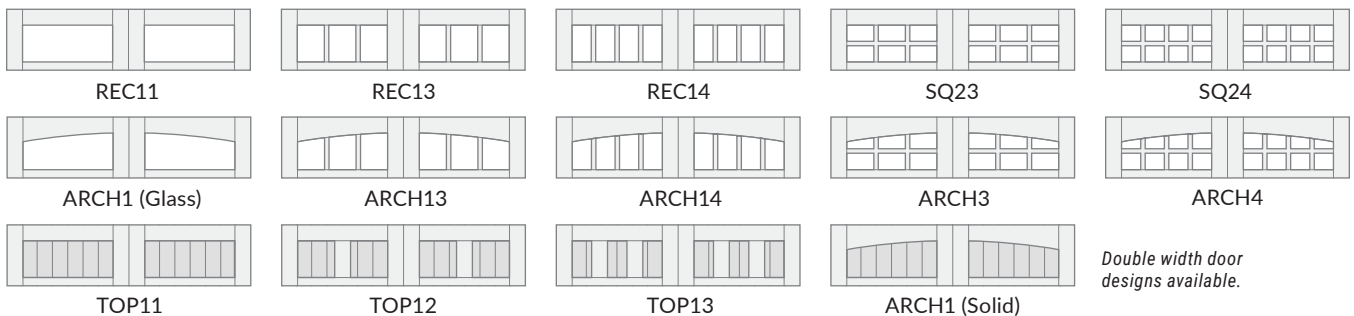

Double width door designs available.



eye-catching
PATTERN PLAY

*Canyon Ridge® / Chevron, Design 12A; Shown Custom Painted
in Sherwin-Williams SW 7746 Rushing River with
Mahogany Cladding, Mahogany Overlays and REC14 Window Design
Photo Credit: Andy Frame Photography*

CANYON RIDGE® Chevron

Love the Chevron trend? This eye-catching geometric pattern has been a favorite in textiles and flooring and is now available in a low-maintenance composite material that looks and feels like real wood. Choose from four distinct patterns to bring timeless appeal to your home. These moisture-resistant doors won't rot, warp or crack and can be painted or stained for jaw-dropping good looks that last.



- 1 COMPOSITE OVERLAY
- 2 COMPOSITE CLADDING
- 3 STEEL
- 4 2" INTELICORE® POLYURETHANE INSULATION
- 5 STEEL

COMPOSITE OVERLAY DELAMINATION
LIMITED
5YR
WARRANTY

HARDWARE
LIMITED
5YR
WARRANTY

STYLE AND CONSTRUCTION

- 5-layer chevron pattern composite faux-wood doors with Intellicore® polyurethane insulation. 20.4 R-value.
- Insulated glass styles include clear, frosted, seeded, rain and obscure. See page 61 for details.
- Removable clip-in window grilles for easy cleaning.
- Spade lift handles and step plates included. See page 62 for more options.

Calculated door section R-value is in accordance with DASMA TDS-163. Canyon Ridge® doors not applicable for new construction in California areas designated as "Fire Hazard Severity Zones".

DOOR DESIGNS

SERIES 1

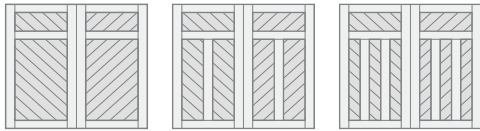

Design 11V

Design 12V

Design 13V

SERIES 3

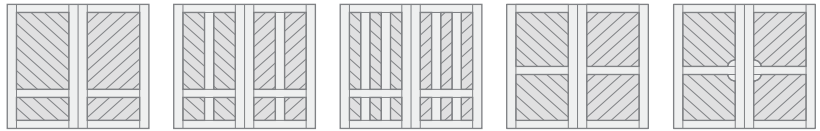

Design 31V

Design 32V

Design 33V

Design 36V

Design 37V

CLADDING DESIGN OPTIONS

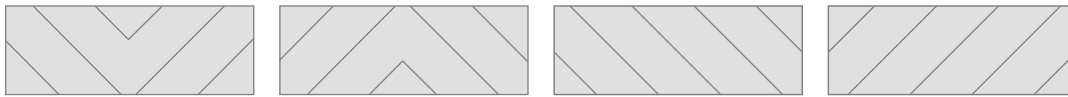

Option V

Option A

Option D

Option U

MATERIAL DESIGN OPTIONS

CLADDING



Clear Cypress (C)

Mahogany (M)

OVERLAY



Clear Cypress (C)

Mahogany (M)

Composite cladding and overlay material options may be mixed and matched.

COLORS



Doors can be ordered primed for custom field painting or staining. Door stain color may vary due to finishing process.

**Bronze, Charcoal, Black and White Finish available only on Mahogany cladding and overlays. Two-tone doors are available. To see all options go to ezdoor.clopay.com.*

Due to the printing process, colors may vary. Order free color samples at clopaydoor.com/requestcolorsamples.

WINDOWS/TOP SECTIONS

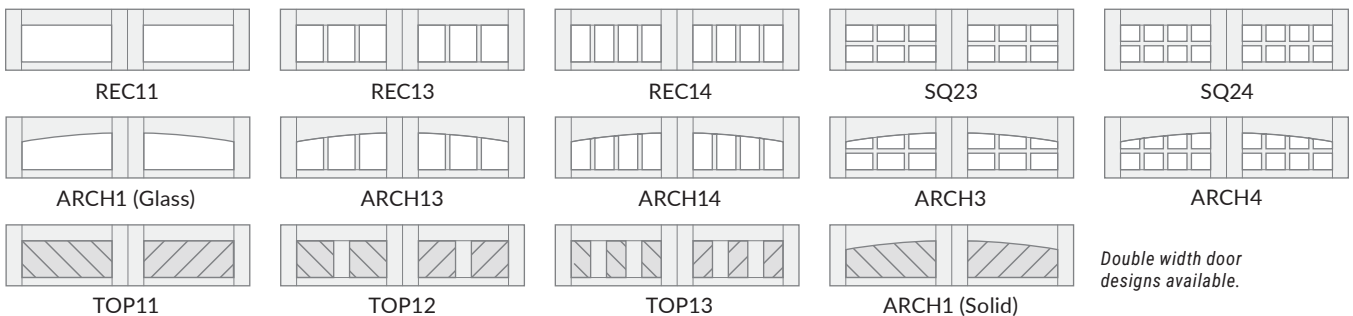

Double width door designs available.

Canyon Ridge® / Louver Design 52; Shown in Custom Painted
in Sherwin-Williams SW 2739 Charcoal Blue with
Louver Mahogany Cladding, Mahogany Overlays and REC14 Window Design
Photo Credit: Andy Frame Photography

versatile COASTAL CHARM

CANYON RIDGE® Louver

If you use more than one adjective to describe your home's style, we have the perfect transitional garage door for you. Versatile and unique, plantation style Canyon Ridge® Louver doors are a perfect complement to coastal cottages and colonial homes. They can also be a standout piece on traditional exteriors or modern farmhouses. Whatever your style, these doors add "wow" factor to your home. As with all Canyon Ridge doors, they are constructed with a durable, insulated steel core topped with horizontal faux-wood composite "slats". The result is a low-maintenance door with dimension and flair.



- 1 COMPOSITE OVERLAY
- 2 COMPOSITE CLADDING
- 3 STEEL
- 4 2" INTELLICORE® POLYURETHANE INSULATION
- 5 STEEL



STYLE AND CONSTRUCTION

- 4 or 5-layer faux-wood louver doors with Intellicore® polyurethane insulation. R-values from 18.4 to 20.4.
- Insulated glass styles include clear, frosted, seeded, rain and obscure. See page 61 for details.
- Removable clip-in window grilles for easy cleaning.
- Spade lift handles and step plates included. See page 62 for more options.

Calculated door section R-value is in accordance with DASMA TDS-163. Canyon Ridge® doors not applicable for new construction in California areas designated as "Fire Hazard Severity Zones".

DOOR DESIGNS

SERIES 4

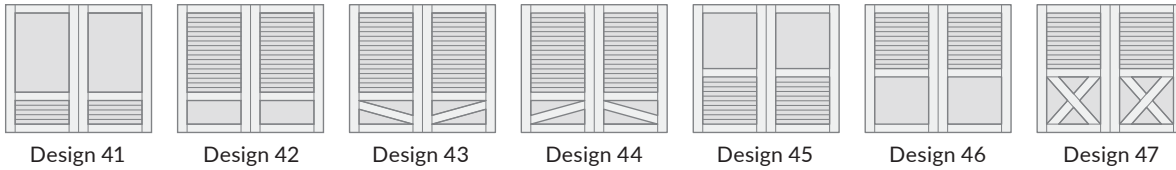

SERIES 5

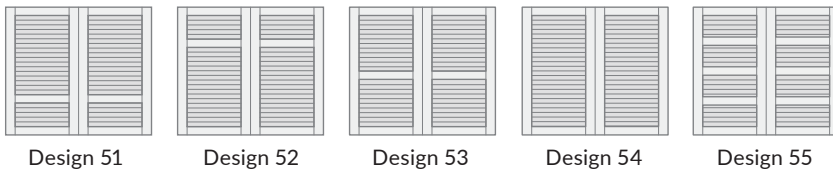

MATERIAL DESIGN OPTIONS

CLADDING/STEEL BASE

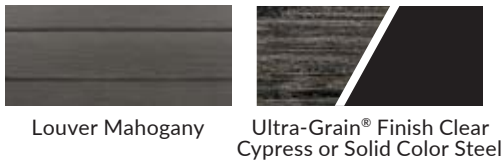

OVERLAY



Note: Composite cladding and overlay material options may be mixed and matched.

COLORS



Doors can be ordered primed for custom field painting. Note: Primed solid steel base is brown. Overlay stain color may vary due to finishing process. *Bronze, Charcoal, Black and White Finish available only on Mahogany overlays. Two-tone doors are available. To see all options go to: ezdoor.clopay.com. Steel surfaces have woodgrain texture. Due to the printing process, colors may vary. Order free color samples at clopaydoor.com/requestcolorssamples.

WINDOWS/TOP SECTIONS

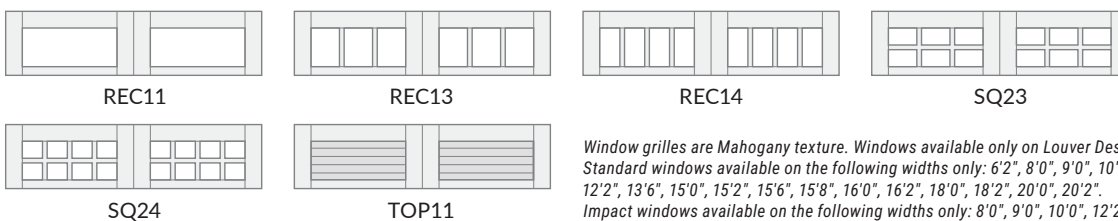

Window grilles are Mahogany texture. Windows available only on Louver Design 52. Standard windows available on the following widths only: 6'2", 8'0", 9'0", 10'0", 10'2", 12'0", 12'2", 13'6", 15'0", 15'2", 15'6", 15'8", 16'0", 16'2", 18'0", 18'2", 20'0", 20'2". Impact windows available on the following widths only: 8'0", 9'0", 10'0", 12'2", 16'2", 18'2".

Canyon Ridge® / Carriage House 4-Layer, Design 21; Shown in Ultra-Grain® Cypress Slate Finish with Clear Cypress Overlays in Slate Finish and SQ24 Window Design
Photo Credit: Living Stone Design + Build, Ryan Theede Photography



RUSTIC looks
REFINED

CANYON RIDGE® Carriage House

4-LAYER CONSTRUCTION

Another beautiful, low-maintenance alternative to real wood is the Canyon Ridge® Carriage House 4-Layer faux-wood garage door. Similar in style and construction to its 5-Layer counterpart, it also has an energy-efficient Intellicore® polyurethane insulated steel core topped with Clear Cypress composite overlays to create a carriage house design. The 4-Layer door has fully visible steel panels that can be finished in Ultra-Grain® for a stained wood-look or painted a solid color to match your home.



- 1 COMPOSITE OVERLAY
- 2 STEEL WITH ULTRA-GRAIN® FINISH (SHOWN) OR SOLID COLOR STEEL
- 3 2" INTELICORE® POLYURETHANE INSULATION
- 4 STEEL

STYLE AND CONSTRUCTION

- 4-layer, steel and composite overlay doors with Intellicore® polyurethane insulation. 18.4 R-value.
- Insulated glass options include clear, frosted, seeded, rain and obscure. See page 61 for details.
- Removable clip-in window grilles for easy cleaning.
- Spade lift handles and step plates included. See page 62 for more options.

Calculated door section R-value is in accordance with DASMA TDS-163. Canyon Ridge® doors not applicable for new construction in California areas designated as "Fire Hazard Severity Zones".

DOOR DESIGNS

SERIES 1



Design 11

Design 12

Design 13

SERIES 3

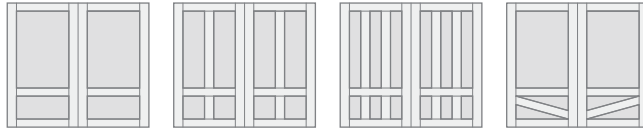

Design 31

Design 32

Design 33

Design 34

SERIES 2



Design 21

Design 22

Design 23

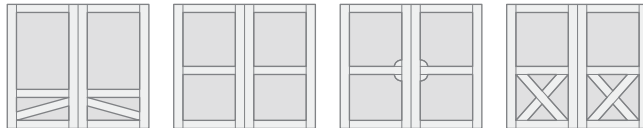

Design 35

Design 36

Design 37

Design 38

MATERIAL DESIGN OPTIONS

STEEL BASE



Ultra-Grain® Finish
Clear Cypress
or Solid Color Steel

Composite cladding is not present on Carriage House 4-Layer doors.

OVERLAY



Clear Cypress



Mahogany

COLORS



Natural Finish



Medium Finish



Dark Finish



Walnut Finish



Slate Finish



Bronze Finish*



Charcoal Finish*



Espresso Finish



Black Finish*



White Finish*



Primed (No Finish)

Doors can be ordered primed for custom field painting. Note: Primed solid steel base is brown. Overlay stain color may vary due to finishing process.

**Bronze, Charcoal, Black and White Finish available only on Mahogany overlays.*

Two-tone doors are available. To see all options go to:

ezdoor.clopay.com.

Steel surfaces have woodgrain texture.

Due to the printing process, colors may vary.

Order free color samples

at clopaydoor.com/requestcolorssamples.

WARRANTIES



WINDOWS/TOP SECTIONS

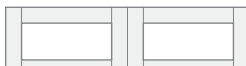

REC11



REC13



REC14



SQ23



SQ24



ARCH1 (Glass)



ARCH13



ARCH14



ARCH3



ARCH4



TOP11



TOP12



TOP13



ARCH1 (Solid)

Double width door designs available.

faux wood
REAL MODERN

*Canyon Ridge® / Modern Plank Design; Shown in Walnut Finish with Mahogany Cladding and 35" x 6" Windows Down Left and Right Side
Photo Credit: Jeffrey A. Davis Photography*

CANYON RIDGE® Modern

Statement-making and sophisticated, our Canyon Ridge® Modern faux-wood garage doors combine realistic wood textures with key elements of contemporary architecture: clean, horizontal lines with mid-century appeal, sleek windows and metallic accents. The doors are constructed in a durable, low-maintenance composite material that resists rot and weathering. An energy-efficient, polyurethane foam insulated steel core provides year-round comfort. Choose from three designs in Clear Cypress or Mahogany faux-wood cladding that can be painted or stained.



- 1 COMPOSITE OVERLAY
- 2 STEEL
- 3 2" INTELlicore® POLYURETHANE INSULATION
- 4 STEEL

STYLE AND CONSTRUCTION

- 4-layer, composite faux-wood doors with Intellicore® polyurethane insulation.
- Plank design: 20.4 R-value.
- Metal Inlay design: 18.4 R-value.
- Full-View design: 6.3 R-value.
- Multiple window configurations available for Plank doors.
- Insulated glass styles include clear, frosted, rain and obscure. See page 61 for details.

Calculated door section R-value is in accordance with DASMA TDS-163. Weighted average calculations using insulated glass windows in all sections, all panels. Canyon Ridge® doors not applicable for new construction in California areas designated as "Fire Hazard Severity Zones".

DOOR DESIGNS

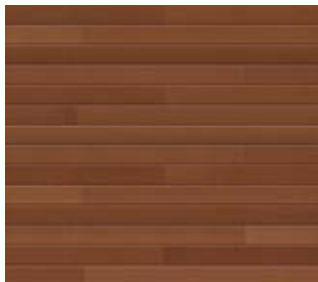

Plank Design



3" Plank



6" Plank



Metal (Aluminum) Inlay Design



Full-View Design

WINDOWS

Available only on Plank door designs.



14" × 6"



35" × 6"

Both window sizes are available on single car and double car doors.

PLANK WINDOW CONFIGURATIONS

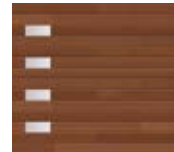

14" × 6"

Windows down right side



35" × 6"

Windows in all panel locations

Note: Configurations are illustrated from outside garage. When ordering, window locations are identified from inside garage looking out. Please keep in mind to avoid ordering windows in wrong location.

WARRANTIES



MATERIAL DESIGN OPTIONS

PLANK CLADDING



Clear Cypress (C)

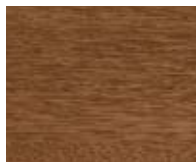

Mahogany (M)

METAL (ALUMINUM) INLAY CLADDING



Clear Cypress (C)



Mahogany (M)

FULL-VIEW OVERLAY



Clear Cypress (C)



Mahogany (M)

COLORS



Natural Finish



Medium Finish



Dark Finish



Walnut Finish



Slate Finish



Bronze Finish*



Charcoal Finish*



Espresso Finish



Black Finish*



White Finish*



Primed (No Finish)

*Doors can be ordered primed for custom field painting or staining. Door stain color may vary due to finishing process. *Bronze, Charcoal, Black and White Finish available only on Mahogany cladding and overlays. Due to the printing process, colors may vary. Order free color samples at clopaydoor.com/requestcolorssamples.*

the look of painted **WOOD**
the ease of durable **STEEL**



*Canyon Ridge® / Elements, Design 12;
Shown in Black with REC13 Window Design*

CANYON RIDGE® Elements

The introductory model in our top-selling line of faux-wood carriage house doors, Canyon Ridge® Elements pairs moisture-resistant composite overlays featuring clean, square “Shaker” edges and durable, insulated steel to give you the look of painted wood without the upkeep. Choose from 13 designs in 6 finishes including dramatic dark colors like Charcoal, Black and Bronze.



- 1 COMPOSITE OVERLAY
- 2 STEEL
- 3 BONDED POLYSTYRENE INSULATION
- 4 STEEL

STYLE AND CONSTRUCTION

- 4-layer, steel and composite overlay doors with 1-3/8" bonded polystyrene insulation. 6.5 R-value.
- Glass options include clear, frosted, seeded, rain and obscure. See page 61 for details.
- Removable clip-in window grilles for easy cleaning.
- Spade lift handles and step plates included. See page 62 for more options.

Calculated door section R-value is in accordance with DASMA TDS-163. Canyon Ridge® doors not applicable for new construction in California areas designated as "Fire Hazard Severity Zones".

DOOR DESIGNS

SERIES 1

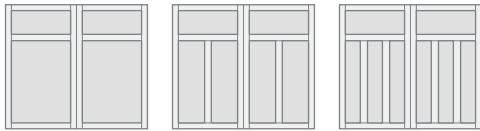

Design 11

Design 12

Design 13

SERIES 3

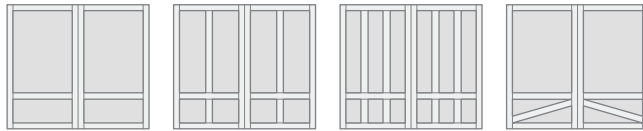

Design 31

Design 32

Design 33

Design 34

SERIES 2

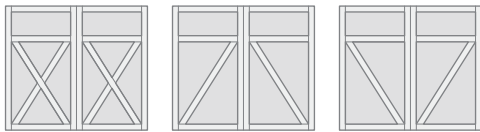

Design 21

Design 22

Design 23



Design 35

Design 36

Design 38

MATERIAL DETAIL



Woodgrain Classic surface texture on steel base and composite overlay.

COLORS



Standard White

Desert Tan

Bronze

Charcoal

Iron Ore*

Black*

WARRANTIES



**Additional charges apply.*

Two-tone doors are available. To see all options go to: ezdoor.clopay.com.

Due to the printing process, colors may vary.

Order free color samples at clopaydoor.com/requestcolorsamples.

WINDOWS/TOP SECTIONS

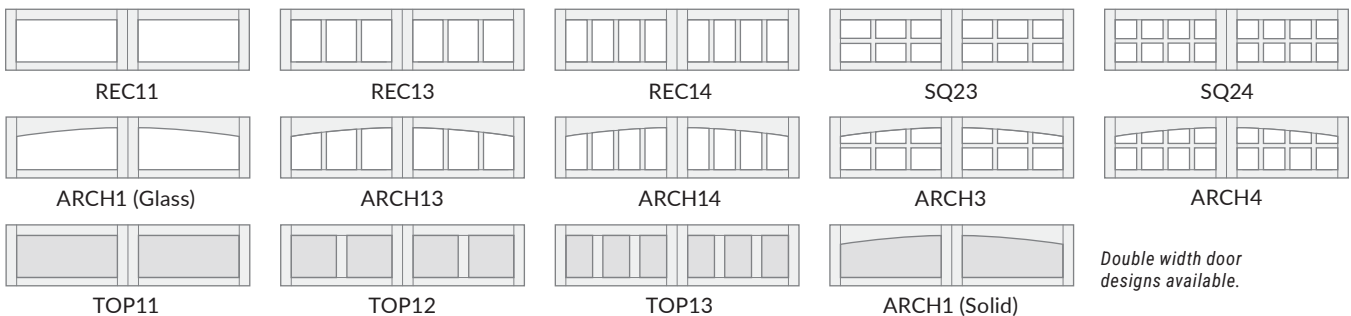

REC11

REC13

REC14

SQ23

SQ24

ARCH1 (Glass)

ARCH13

ARCH14

ARCH3

ARCH4

TOP11

TOP12

TOP13

ARCH1 (Solid)

Double width door designs available.

COACHMAN®

Both beautiful and practical, Coachman® carriage house doors feature layers of low-maintenance, insulated steel topped with textured composite overlays. Authentic details like beveled edges, a defined center groove, and decorative hardware give the look of a historic “swing-out” door, with the convenience of automatic overhead operation. Painted a variety of light colors or simply white, this door is a timeless wood-look favorite.

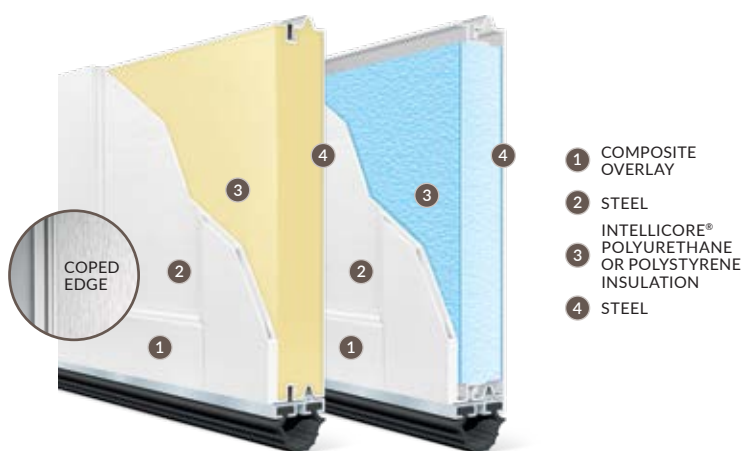

Coachman® / Design 21; Shown in White with REC13 Window Design
Photo Credit: Andy Frame Photography

STYLE AND CONSTRUCTION

- 4-layer, steel and composite overlay doors with 2" Intellicore® polyurethane, 2" or 1-3/8" bonded polystyrene insulation. R-values from 6.5 to 18.4
- Insulated glass styles include clear, frosted, seeded, rain and obscure. See page 61 for details.
- Removable clip-in window grilles for easy cleaning.
- Spade lift handles and step plates included. See page 62 for more options.

Calculated door section R-value is in accordance with DASMA TDS-163.



Complete overlay and true arch window designs provide an authentic carriage house look.

DOOR DESIGNS

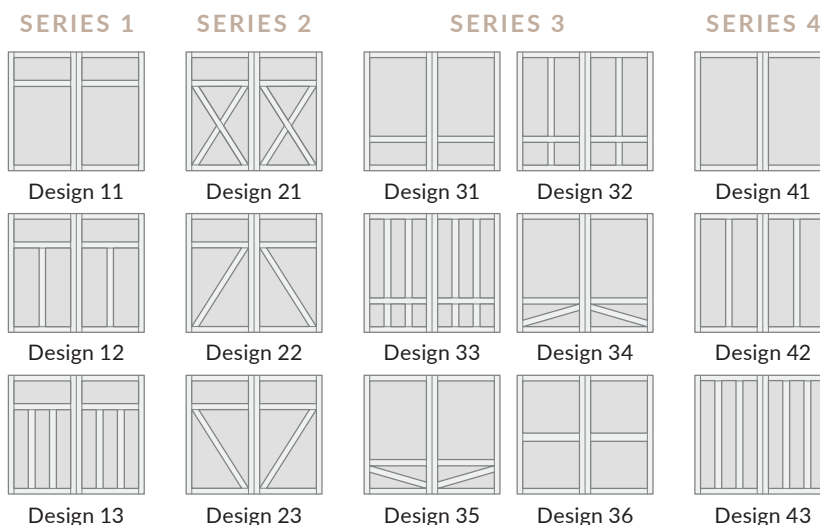

Coachman® doors can be painted using a high-quality exterior latex paint. **IMPORTANT:** Doors cannot be painted black or very dark colors having an LRV of 12 or less. Colors with an LRV of 13 to 38 require the use of tested and approved paints. A list can be found at: <http://info.garagedoors.com/lrv>.

For doors painted an LRV of 12 or less, see Canyon Ridge® Elements on page 44 as an alternative.



past inspires
PRESENT

COLORS

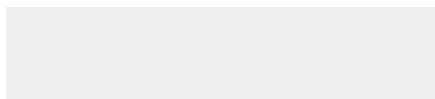

Standard White

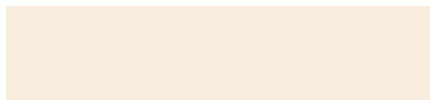

Almond

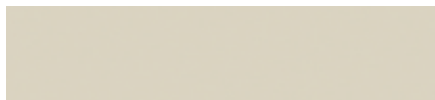

Desert Tan



Sandtone

Overlay and base colors can be mixed to achieve desired look.

Due to the printing process, colors may vary.

WINDOWS/TOP SECTIONS



REC11



ARCH1 (Glass)



TOP11



REC13



ARCH13



TOP12



REC14



ARCH14



TOP13



SQ23



ARCH3



ARCH1 (Solid)



SQ24



ARCH4

Double width door designs available.

WARRANTIES

PAINT SYSTEM
LIMITED
LIFE
WARRANTY

WINDOW & OVERLAY
DISCOLORATION
LIMITED
10YEAR
WARRANTY

OVERLAY
DELAMINATION
LIMITED
5YEAR
WARRANTY

HARDWARE
LIMITED
5YEAR
WARRANTY

WOOD

Let a Natural Wood Door Welcome You Home

Both stunning and substantial, every Reserve® Wood garage door embodies our total commitment to design, detail and craftsmanship with the warmth and character no other material can match. Design a one-of-a-kind door for your dream home with our Custom option, or select a pre-configured style from our Limited Edition, Semi-Custom and Modern garage door series.

The wood we use is harvested from sustainable and naturally fallen forestry. From sourcing the right species for your climate to building each door by hand and finishing it to our exacting standards before it leaves the shop floor, you'll appreciate the attention that goes into creating an heirloom quality door made just for you.



*Reserve® Wood / Custom Design;
Shown in Dark Oak with SQ23 Window Design
Photo Credit: Andy Frame Photography*





the STATEMENT
maker

*Reserve® Wood / Limited Edition Design 1; Shown in Cedar Finish with REC13 Window Design
Photo Credit: Caruso Builders*

RESERVE® WOOD

Limited Edition and Custom

A natural wood door is the kind of door that gets people talking — one that transforms “just another pretty façade” into a neighborhood style icon. Our Limited Edition lives up to its billing, featuring eight of our most popular insulated carriage house door styles handcrafted for exceptional beauty, durability and energy efficiency. Have something different in mind? Working with a professional drawing or even just an idea board, we can create the door you’ve imagined in woods like Knotty Alder, Spanish Cedar, White Oak, Ironwood and African Mahogany. Each custom door is crafted and finished using the material of your choice. Look at these examples for inspiration or start from scratch to create a one-of-a-kind design.

STYLE AND CONSTRUCTION

- Limited Edition and Custom doors are constructed in 4 or 5-layers with polystyrene insulation for energy efficiency. 5.9 R-value.
- All Reserve® Wood garage doors are built with a swing-out appearance and convenient upward operation.
- Custom doors feature unlimited design options and unlimited wood species.
- True divided windows are standard. Glass options include clear, obscure and insulated. See page 61 for details.
- Premium grade hardware, rollers and track assure smooth, quiet, long-lasting operation.
- Optional replaceable bottom weatherseal in a corrosion-resistant retainer helps seal out the elements.
- All doors can be factory primed, painted or stained.

Calculated door section R-value is in accordance with DASMA TDS-163.

- 1 WOOD OVERLAY
- 2 OPTIONAL BASE MATERIAL
- 3 BASE MATERIAL
- 4 POLYSTYRENE INSULATED HEMLOCK FRAME
- 5 2" LUAN INSIDE SKIN

LIMITED EDITION
LIMITED
5YR
WARRANTY

CUSTOM
LIMITED
5YR
WARRANTY

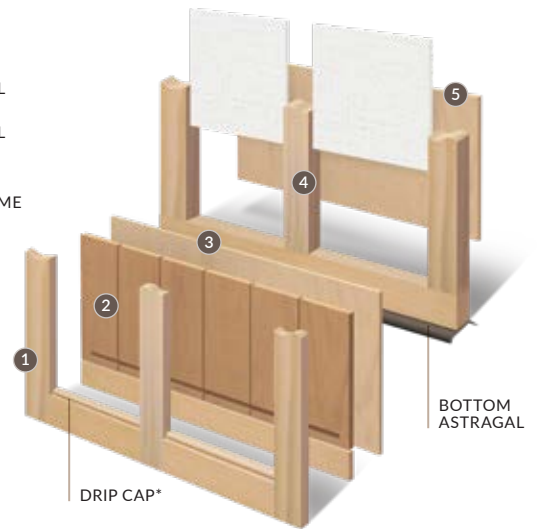

*Drip cap is available exclusively on tongue-and-groove (5-layer) and grooved Extira® wood (4-layer) configurations.

DOOR DESIGNS

All doors shown 8' wide x 7' high.



Design 1

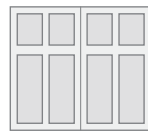

Design 2

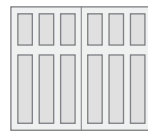

Design 3

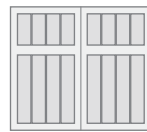

Design 4

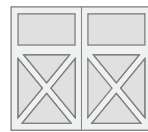

Design 5

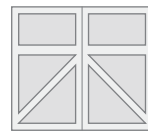

Design 6

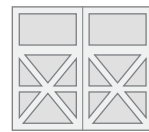

Design 7

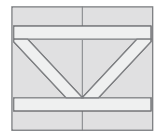

Design 8

MATERIAL OPTIONS

OVERLAYS



Meranti



Redwood



Light Cedar



Mixed Cedar



Dark Cedar



Fir



Extira®

Extira® wood base and overlays cannot be stained. On tongue-and-groove (T&G) base doors, the wood species of the tongue-and-groove must match the wood species of the overlay.

Custom configurations available for custom doors.

BASE FACE MATERIAL



T&G Meranti



T&G Redwood



T&G Light Cedar



T&G Mixed Cedar



T&G Dark Cedar



T&G Fir



Luan



Smooth Extira®

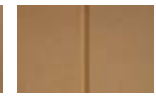

Grooved Extira®

Due to the printing process, colors may vary. Order free color samples at clopaydoor.com/requestcolorsamples.

WINDOW/TOP SECTIONS



REC13



REC14



SQ23



SQ24



ARCH3



ARCH4



ARCH13



ARCH14

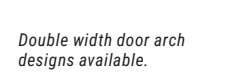

Double width door arch designs available.



TOP11



TOP12



TOP13



TOP14



ARCH1

NATURAL stand out



*Reserve® Wood / Horizontal Cladding Design 7; Factory Stain Finished in Teak
Photo Credit: Allegra Anderson*

RESERVE® WOOD Modern

Clean lines and simple forms let the beauty of natural wood stand out. Clopay's versatile Modern doors let you mix materials, shape and tone to create a stunning contemporary garage door that blends beautifully with other woods and materials on your exterior.

STYLE AND CONSTRUCTION

- Handcrafted contemporary 4-layer doors with polystyrene insulation for energy efficiency. 5.9 R-value.
- Offset window design: Features a variety of short and long windows in clear tempered glass. Other glass options include frosted and obscure. See page 61 for details.
- Accent strip design: Features contrasting decorative flush aluminum strips between horizontal plank boards to provide a beautiful contrast of materials. Design available with full or alternating length boards. Design available with full or alternating length boards.
- Horizontal cladding design: Simple plank design available with full or alternating length boards.
- Heavy-duty hinges, rollers and track provide smooth, quiet, long-lasting operation.
- Optional replaceable bottom weatherseal in a corrosion-resistant retainer helps seal out the elements.
- All doors can be factory primed, painted or stained. See page 60 for details.

Calculated door section R-value is in accordance with DASMA TDS-163.

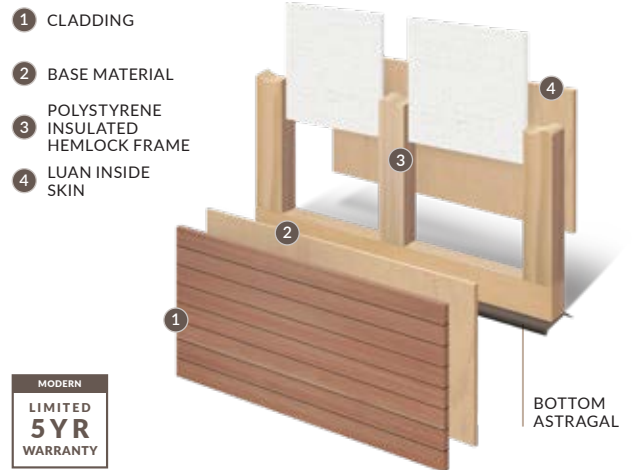

DOOR DESIGNS



*Doors shown 8' wide x 7' high.
Accent Strip and Horizontal Cladding models are available spliced and unspliced.
Unspliced models are available up to 10' wide.*

MATERIAL OPTIONS



OFFSET WINDOW CONFIGURATIONS

Note: All designs shown are illustrated from the exterior of the garage.



*Door designs must be ordered based on the view from the interior of the garage. All right-hand designs are shown. Designs 1, 3, 5 and 6 are also available left-handed.
Not available 10'1" to 13'6". Special order only.



Reserve® Wood / Horizontal Cladding Design 7; Factory Stain Finished in Dark Oak

*Reserve® Wood / Semi-Custom Design 3 in Redwood with
SQ23 Window Design; Factory Stain Finished in Dark Oak
Photo Credit: Andy Frame Photography*



building
CHARACTER

RESERVE® WOOD Semi-Custom

You may be surprised to learn that this exclusive look doesn't necessarily exclude your budget. Choose from six recessed panel designs in three wood species with optional windows and decorative hardware.

STYLE AND CONSTRUCTION

- Handcrafted, 2-layer, non-insulated wood carriage house doors.
- Available in three stain-grade wood species Redwood, Cedar or Hemlock. Paint-grade Extira® wood panels are available with Hemlock stiles and rails.
- 1/4" thick imported Luan interior backer glued to stiles and rails.
- True divided windows are standard. Glass options include clear, obscure and insulated. See page 61 for details.
- All doors can be factory primed, painted or stained. See page 60 for details.

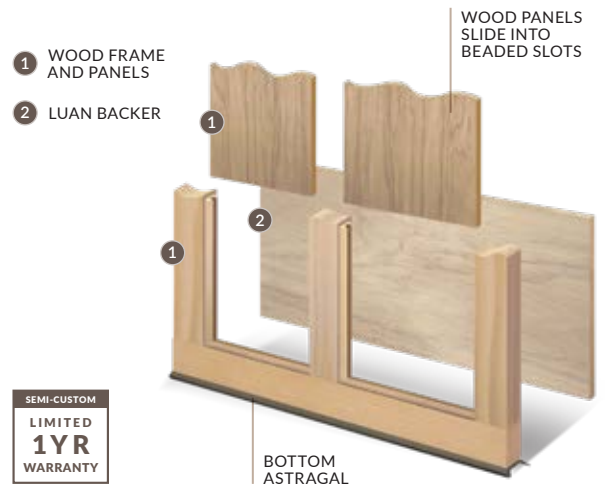

DOOR DESIGNS

All doors shown 8' wide x 7' high.

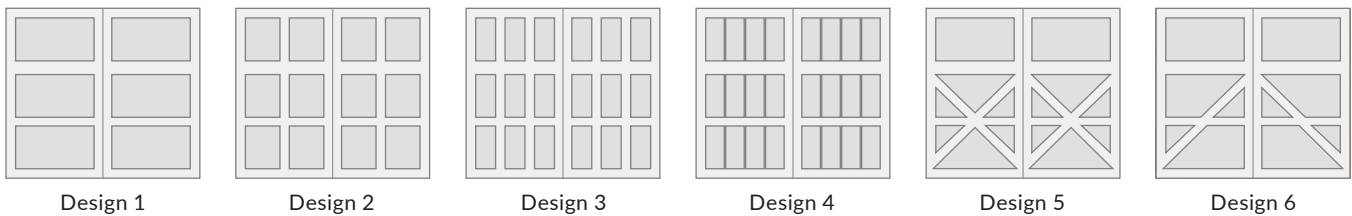

MATERIAL OPTIONS

	STAIN GRADE			PAINT GRADE	
STILE/RAILS	Redwood	Cedar	Hemlock	Hemlock	Hemlock
PANELS	Redwood	Cedar	Hemlock	Smooth Extira®	Grooved Extira®

Due to the printing process, colors may vary. Order free color samples at clopaydoor.com/requestcolorsamples.

WINDOW/TOP SECTIONS

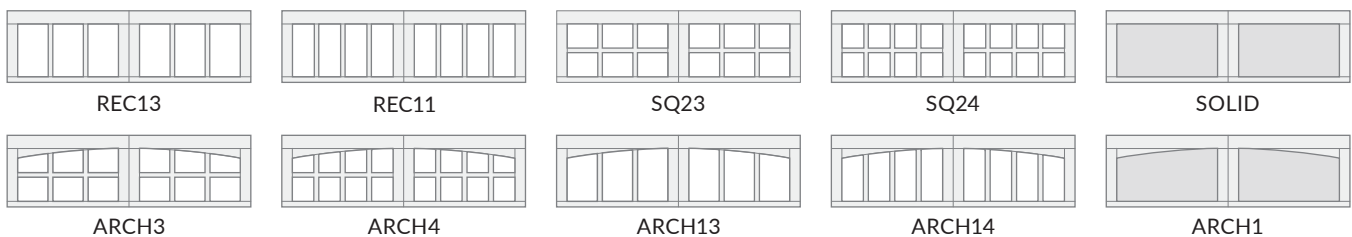

Double width door designs available.



*Reserve® Wood Extira® / Custom Design;
Shown Custom Painted
Photo Credit: Anthony Carrino*

NATURALLY eco-friendly

RESERVE® WOOD Extira®

Enjoy the natural beauty and craftsmanship of an Extira® door that delivers enduring style and performance. Extira® is an eco-friendly, paint-grade wood composite that resists moisture, rot and termites. Engineered exclusively for outdoor use, it outperforms MDF and many wood species. It carves, routs and fastens like natural wood, giving you the freedom to create a one-of-a-kind door. Choose from modern, carriage house, or classic designs or create your own. If you are a fan of using a painted insulated door as a statement piece, Extira® is a must-see.

STYLE AND CONSTRUCTION

- Handcrafted 4-layer construction featuring Hemlock frame with polystyrene insulation. 5.9 R-value.
- Durable, eco-friendly paint-grade wood composite with smooth or grooved panel styles and unlimited design options.
- Doors have a swing-out appearance with convenient overhead operation and are built in three or four sections, allowing for proportionally larger window sizes.
- Optional windows available in true divided or simulated divided designs. Glass available in clear, obscure and insulated options. See page 61 for details.
- Premium grade hardware, rollers and track assure smooth, quiet, long-lasting operation.
- Optional replaceable bottom weatherseal in a corrosion-resistant retainer helps seal out the elements.
- Factory or Custom paint finish only. Extira® cannot be stained.

Calculated door section R-value is in accordance with DASMA TDS-163.

- 1 EXTIRA® OVERLAY
- 2 EXTIRA® BASE MATERIAL
- 3 POLYSTYRENE INSULATED HEMLOCK FRAME
- 4 2" LUAN INSIDE SKIN

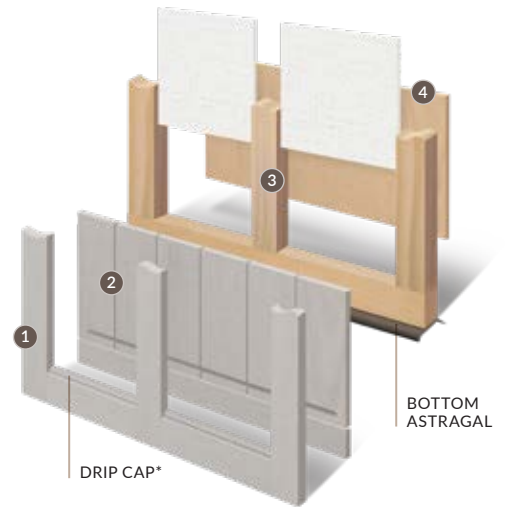

*Drip cap is available exclusively on grooved Extira® wood configurations.

PAINT GRADE MATERIAL OPTIONS



Smooth Extira®

Smooth, consistent surface free of knots and voids often seen in wood



Grooved Extira®

Smooth panel with deep "V" grooves



Reserve® Wood Extira® / Custom Design;
Shown in Sherwin Williams Roycroft Bottle Green
Photo Credit: Laurey Glenn Photography

CLASSIC™ WOOD



Model 44HC Short Raised Panel with Short Stockton Window Design

RAISED PANEL

MODEL 44

1
LAYER
CONSTRUCTION

1 WOOD FRAME
AND PANELS



MODEL **44** STYLE AND CONSTRUCTION

MODEL 44
LIMITED
1YR
WARRANTY

- 1-3/8" heavy-duty stile and rail construction.
- Handcrafted short or long raised panels in Redwood, Cedar, Hemlock (stain grade) or Extira® (paint grade).
- Doors can be factory primed, painted or stained (natural wood species only).

Note: Printed color shown here may vary from actual product colors.

MATERIAL OPTIONS

	STAIN GRADE			PAINT GRADE	
STILE/RAILS	Redwood	Cedar	Hemlock	Hemlock	
PANELS	Redwood	Cedar	Hemlock Cedar	Redwood	Smooth Extira®



RECESSED PANEL



MODEL 20

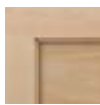

Hemlock Frame, Luan Panel. Paint or Stain Grade Available.

MODEL 10

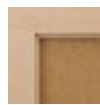

Hemlock Frame, Hardboard Panel. Paint Grade Only.

FLUSH PANEL

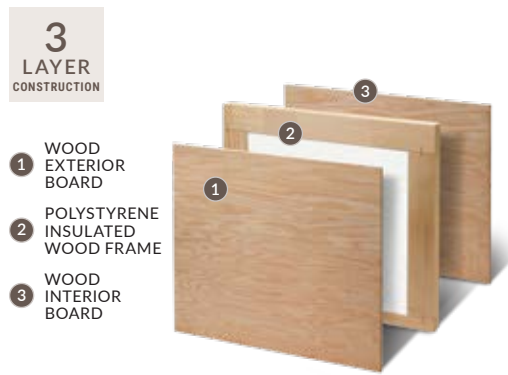

MODEL 33



Smooth Luan



Okoume



WINDOWS

MODEL 44/MODEL 20



Plain Short



Plain Long



Cathedral Short



Cathedral Long



Stockton Short



Stockton Long



Horizon



Sherwood

Designer inserts constructed of carved wood.

MODEL 33



Plain Short

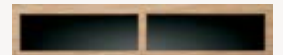

Plain Long

Windows come standard with SSB glass. Other options include DSB, acrylic or obscure.

MODEL 10

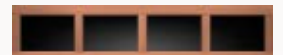

Plain Short

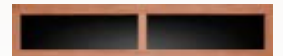

Plain Long



Cathedral Short



Sunset

Decorative inserts constructed of White ABS with UV resistant capstock.

STYLE AND CONSTRUCTION



- 1-3/8" stile and rail construction in Hemlock.
- Flat panels available in Luan, Okoume and Hardboard. Stain grade or paint grade.
- Doors can be factory primed, painted or stained.

Note: Printed color shown here may vary from actual product colors.

STYLE AND CONSTRUCTION



- 3-layer, polystyrene insulated door. 5.9 R-value.
- Heavy-duty 1-5/8" section thickness.
- Exterior wood options include smooth Luan and Okoume. Interior is Luan.
- Doors can be factory primed, painted or stained.

Note: Printed color shown here may vary from actual product colors.

Factory FINISHES

Stain-grade wood doors are available in nine beautiful finishes or can be factory-painted white. Custom colors can be requested.

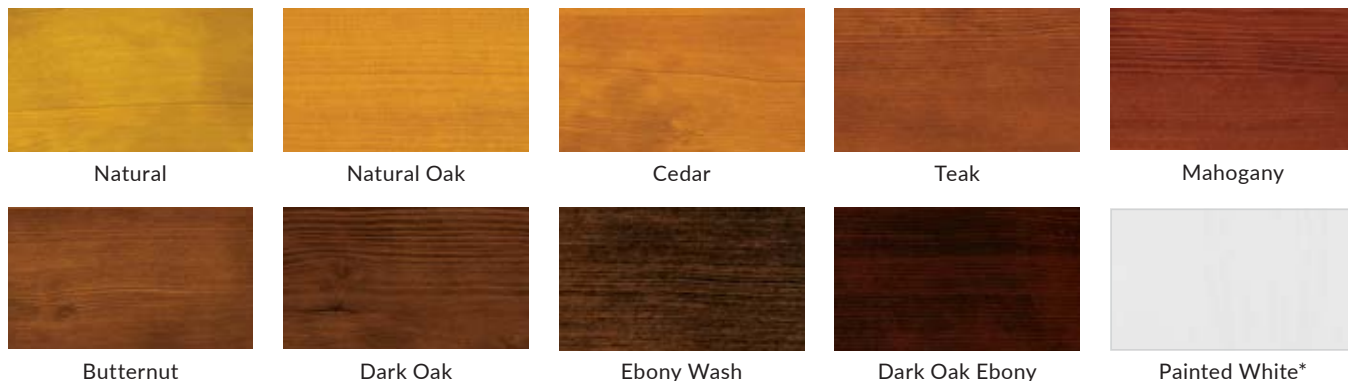

Stain colors shown on Hemlock wood. Printed colors may vary from actual door color.

*Custom colors are available.

3-LAYER STAIN PROCESS

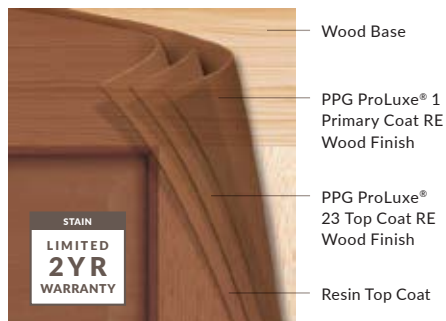

3-LAYER PAINT PROCESS



WOOD DOOR CARE

- Proper care and maintenance are imperative to the appearance, longevity and performance of all wood doors.
- Doors must be painted or stained on all six sides prior to installation. Failure to follow the installation and maintenance instructions will void the warranty.
- Go to www.clopaydoor.com for more details about installation and maintenance or see care and maintenance manual.

Specialty GLASS

CANYON RIDGE® AND COACHMAN®

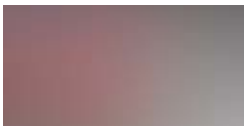

Frosted



Seeded



Obscure



Rain

GALLERY® STEEL, BRIDGEPORT™ STEEL, BRIDGEPORT™ INLAY AND CLASSIC™ STEEL



Midnight Gray

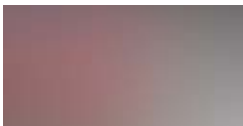

Frosted



Seeded



Obscure



Rain

MODERN STEEL™



Midnight Gray



Frosted



Obscure



Narrow Reed



Rain

RESERVE® WOOD AND CLASSIC™ WOOD

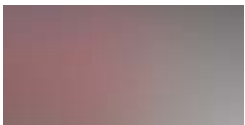

Frosted



Seeded



Obscure



Narrow Reed



Rain



Frosted Gluechip

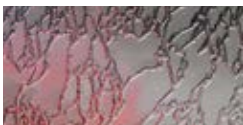

Delta Frost

Seeded not available on Canyon Ridge® Modern doors.
 Midnight Gray not available on Classic Steel Value Plus and Value doors.
 Additional charges for optional glass apply.

DECORATIVE HARDWARE

Attractive black powder coated handles and step plates come standard on select Clopay garage doors. To further enhance the design of your door, optional decorative hardware – including handles, operable L-keylocks and strap hinges – is available.

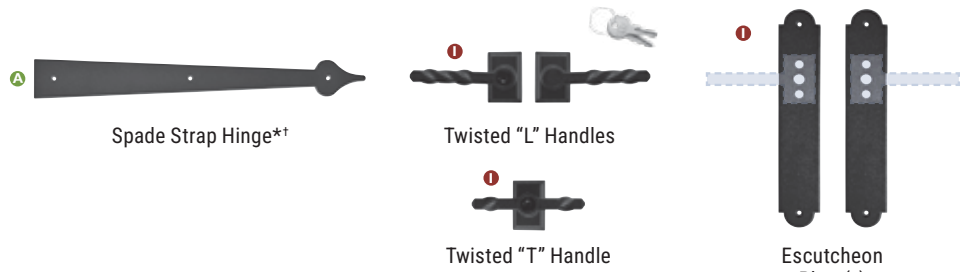
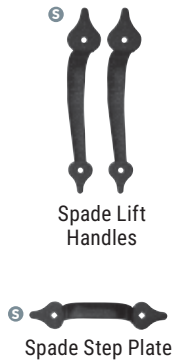

**Complements Spade Lift Handles and Spade Step Plate.*

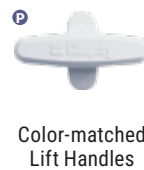
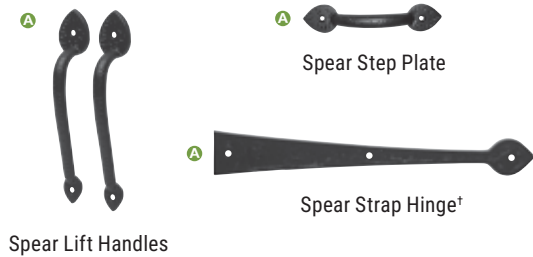

- Ⓐ = Steel Construction
- Ⓛ = Cast Iron Construction
- Ⓐ = Aluminum Construction
- Ⓟ = Color-matched Plastic Construction

[†]Door may not open properly if installed near the top depending on opening dimensions and lift type. See your Clopay Dealer for more details and/or hardware dimensions.

ELEVATE YOUR DOOR



HIGH R-VALUES

Delivering high R-values, our proprietary Intellicore® polyurethane foam insulated doors are stronger, quieter and save on energy use year-round. Your garage will feel 10–20 degrees warmer in the winter and cooler in the summer.



ENERGY EFFICIENCY
Provides year-round comfort

THERMAL BREAK
Separates steel skins to improve energy efficiency

20.4 R-VALUE
Highest R-value in its class

DURABILITY
Enhanced strength reduces dents

NOISE LEVEL
Dense insulation reduces operating noise

RUST PREVENTION
Layered coating system helps protect steel finish



CUSTOM PAINT PROGRAM

Color Blast® offers more than 1,500 Sherwin-Williams® color options to complement your home. Clopay's durable two-part paint system has been thoroughly tested and is backed by a five-year warranty.

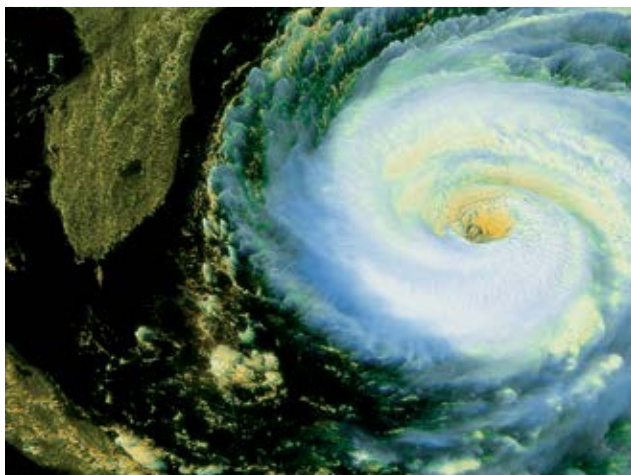

STORM READY GARAGE DOORS

Built-in windload reinforcement and impact-rated materials protect your home during a hurricane. From research and development to design assistance, we are your trusted source for WindCode® garage doors in many different sizes and pressure ratings that meet Florida, Miami-Dade, Texas (TDI) and the International Building Code.





Scan the QR code to explore our lookbook and get product specifications, code requirements, certifications and more.



*Gallery® Steel / Long Panel;
Shown in Charcoal with REC14 Windows
Photo Credit: Laurey Glenn Photography*



1-800-225-6729 | ClopayDoor.com | Follow us on

 **MADE IN USA** | © 2026 Clopay Corporation. All rights reserved.



RSDR-PRODUCTSELECT-23_REV0126