

# GAR<sub>EX</sub>

# PERFORMANCE MADE SIMPLE



Urban MR

## GARAGE DOORS | GX SERIES

COMMERCIAL, INDUSTRIAL, AGRICULTURAL

WELL DESIGNED  
EASY TO CUSTOMIZE  
QUICK TO INSTALL



# Door components

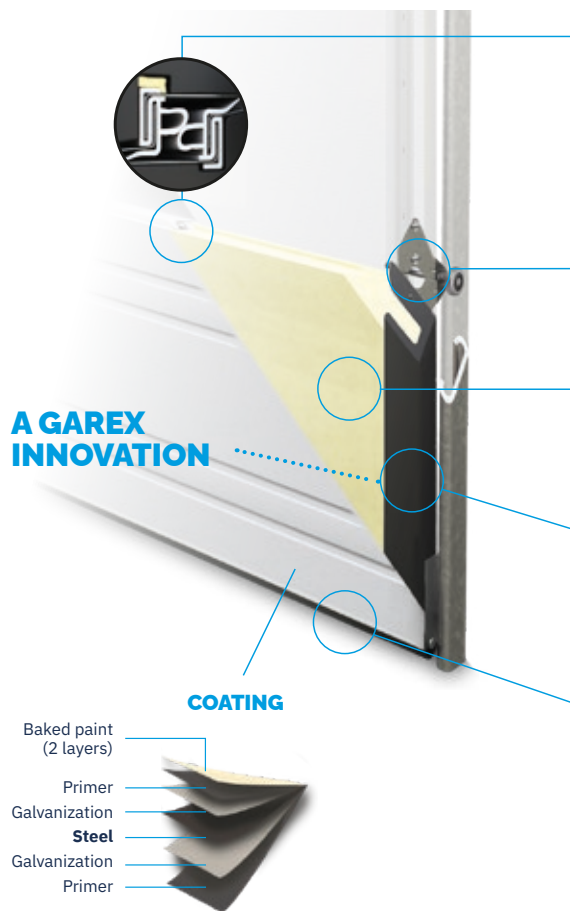

## PERFECT SEALING

Prevents water and air infiltration between panel sections with joint seals, reducing thermal break and preventing heat transfer between the inside and outside of your garage.

## QUALITY HARDWARE

The hardware is determined by the door's dimensions, clearance, and weight.

## INSULATED HEAVY-DUTY PANEL

High density polyurethane core, meeting Canada's strictest environmental standards.

## COMPOSITE END BLOCKS

A Garex exclusivity, made from 100% recycled materials. It provides superior mechanical strength (with screw pull-out resistance higher than wood and steel) and optimal protection against corrosion and rot, according to an independent report.

## WATERTIGHT WEATHER SEAL

Arctic-grade, TPE ultra-durable U-shaped weather seal inserted into the bottom panel. It remains flexible at low temperatures and forms a perfect seal against your floor for maximum weather resistance.

## HARDWARE

At Garex, every hardware component is meticulously calibrated to match the specific width and required usage of your doors. This precise customization ensures peak performance that meets your specific needs and assures the durability of your installation.

## Features

Door Weight	Category	Specification	Shaft	Further information
Less than 400 lb (181 kg)	Light commercial	2" Tracks	Tube keyed	<ul style="list-style-type: none"> <li>• Tracks made of 13 or 12 gauge steel;</li> <li>• Steel hinges of 14, 13, 11 gauge;</li> <li>• Double hinges for doors of more than 12 ft (3.66 m);</li> <li>• Reinforcement on doors of 13 ft (3.96 m) and more.</li> </ul>
400 lb to 599 lb (181 kg to 271 kg)	Heavy-Duty Commercial	Reinforced 2" Tracks	Solid shaft	
More than 600 lb (272 kg)	Industrial	3" Tracks	Solid shaft	

# Discover what suits you best

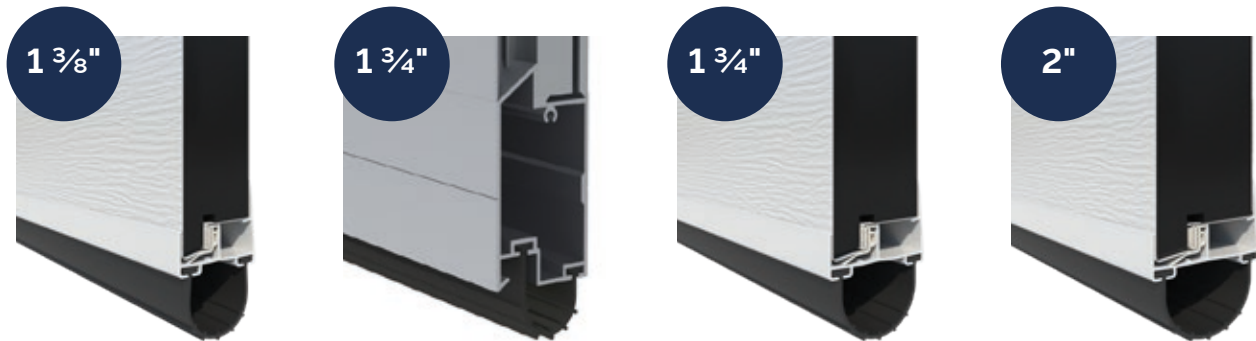

	<b>GX-138</b> Light Commercial	<b>GX-175-FV</b> Full View	<b>GX-175</b> Commercial/Industrial/Agricultural		<b>GX-200</b>
Door thickness	1 3/8"	1 3/4"	1 3/4"		2"
Materials	Steel	Aluminum	Steel	20 GA Steel	Steel
Composite End Blocks (100% recycled materials)	✓		✓	✓	✓
Steel End Caps (Reinforcement option)	✓		✓	✓	✓
Texture	Woodgrain	Smooth	Woodgrain	Woodgrain	Woodgrain
Grooved model	✓		✓	✓	✓
Multi-Groove model			✓		✓
Urban MR model	✓		✓		✓
Woodgrain model	✓		✓	✓	✓
Base colors	Pure White 138, White, Black, Silver, Pebble, Sable, Slate, Commercial Brown, Iron Ore	White, Black, Clear Anodized	White, Black, Silver, Pebble, Sable, Slate, Dark Oak, Commercial Brown, Iron Ore	White	White, Black, Silver, Pebble, Sable, Slate, Commercial Brown, Iron Ore
Custom colors	✓	✓	✓	✓	✓
Insulation factor	R-12	N.I.	R-16	R-16	R-18
Maximum width	18'	24'	30'	20'	24'
Maximum height	14'	18'	32'	24'	32'
Technical specifications	<a href="http://garex.com/en/documentation/">garex.com/en/documentation/</a>				



**DURABLE & SOLID**

Multi-Groove

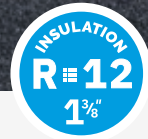

# GX-175 / 138 / 200 Series



**GROOVED**  
GX-175-G  
GX-138-G  
GX-200-G

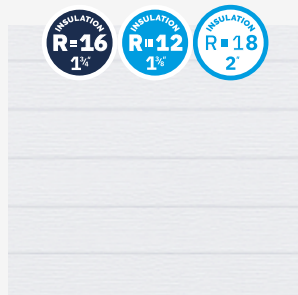

**URBAN MR**  
(THIN GROOVES)  
GX-175-MR  
GX-138-MR  
GX-200-MR

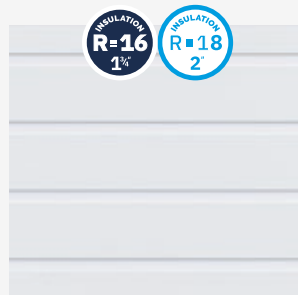

**MULTI-GROOVE**  
GX-175-MG  
GX-200-MG



**WOODGRAIN**  
(WITHOUT GROOVES)  
GX-175-W  
GX-138-W  
GX-200-W

# Available Configurations

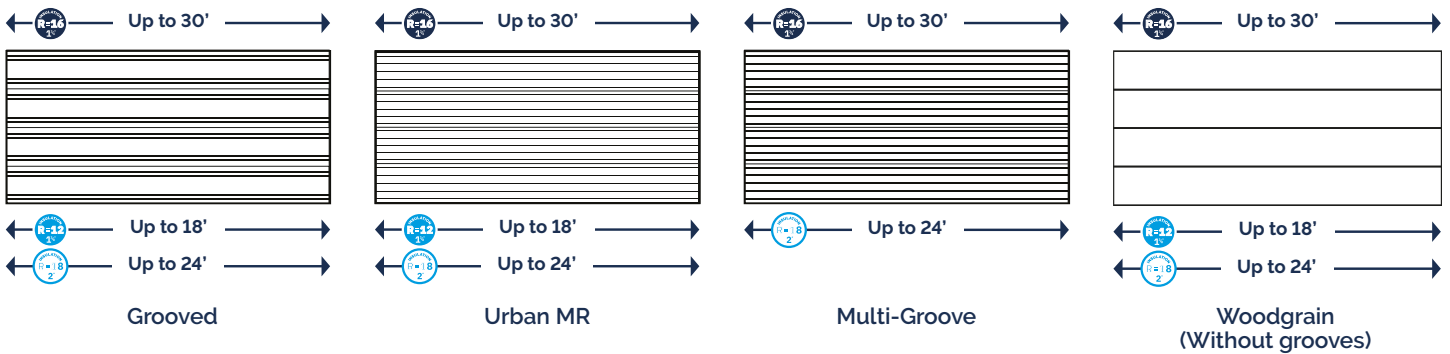

# Examples



# Technical Information

Panel height	18, 21 and 24 inches (45, 53 and 60 cm)
Panel width	1 3/4" (R-12): Up to 18 feet (5.48 m) 1 3/4" (R-16): Up to 30 feet (9.14 m) 2" (R-18): Up to 24 feet (7.32 m)
Door Thickness	1 3/4" (R-12) (34,93 mm) / RSI 2.11 1 3/4" (R-16) (44,45 mm) / RSI 2.81 2" (R-18) (50,8 mm) / RSI 3.16
Door Weight	1 3/4" (R-12) 1.65 lb/ft <sup>2</sup> Max of 2200 lb (998 kg) 1 3/4" (R-16) 1.85 lb/ft <sup>2</sup> Max of 2200 lb (998 kg) 2" (R-18) 1.95 lb/ft <sup>2</sup> Max 2200 lb (998 kg)
Steel End Caps	On doors that are 28 feet or wider (or 400 ft <sup>2</sup> )
Windows	20 X 14, 25 X 13, 41 X 13 or custom sizes
Metal thickness	26 ga Galvanized Steel : 0.0185 in (0.47 mm)
Insulation	High-density polyurethane (2.5 lb/ft <sup>3</sup> )
End Blocks	Made of 100% recycled materials - A Garex exclusivity
Paint	Baked Polyester (2 layers)
Texture	Woodgrain

# Available Colors

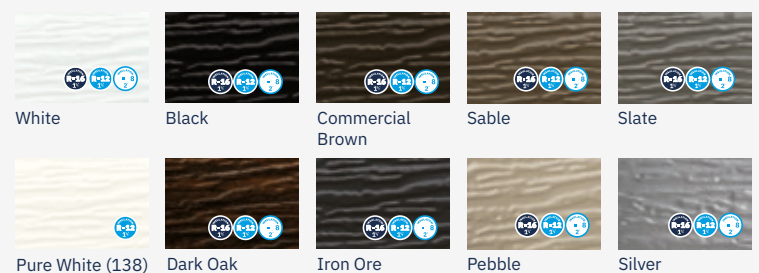

Please note that the colors shown in the photo may slightly differ from the actual color of the door.



**GENTEK**

Available in the color of your choice.  
\*Additional charges apply.

\*Maximum height of 14 feet for 1 3/4" doors (R-12).  
\*Some models are not available with 18-inch panels.  
\*1 3/4" (R-12) and 2" (R-18) doors cannot include a full view section.



RIGID AND RESISTANT

Grooved



# GX-175-20 Series

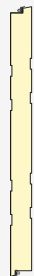

**GROOVED**  
GX-175-20-G

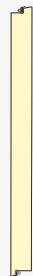

**WOODGRAIN**  
(WITHOUT GROOVES)  
GX-175-20-W

## Available Configurations

← **R-16** → Up to 20'

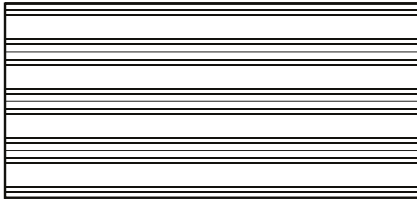

Grooved

← **R-16** → Up to 20'

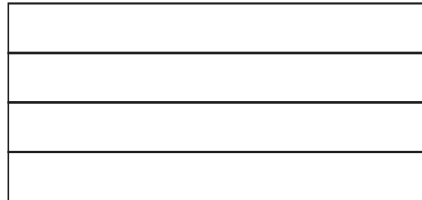

Woodgrain  
(Without grooves)

### COATING

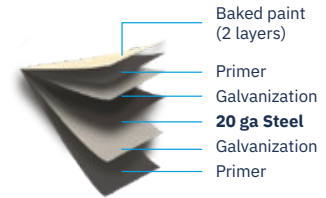

## Examples



**Composite end blocks**  
Superior mechanical strength  
and optimal protection  
against corrosion and rot.



Woodgrain

## Technical Information

Panel height	18, 21 and 24 inches (45, 53 and 60 cm)
Panel width	Up to 20 feet (6.10 m)
Door Thickness	1 3/4" (R-16) (44.45 mm) / RSI 2.81
Door Weight	3.37 lb/ft <sup>2</sup> - Max of 2200 lb (998 kg)
Windows	20 X 14, 25 X 13, 41 X 13 or custom sizes
Metal thickness	20 ga Galvanized Steel : 0.035 in (0.89 mm)
Insulation	High-density polyurethane (2.5 lb/ft <sup>3</sup> )
End Blocks	Made of 100% recycled materials - A Garex exclusivity.
Paint	Baked Polyester (2 layers)
Texture	Woodgrain

## Available Colors



White

*Please note that the colors shown in the photo may slightly differ from the actual color of the door.*



**GENTEK**

Available in the color of your choice.  
\*Additional charges apply.



**BRIGHT & ELEGANT**

# GX-175-FV Full view

---

Door of 8'

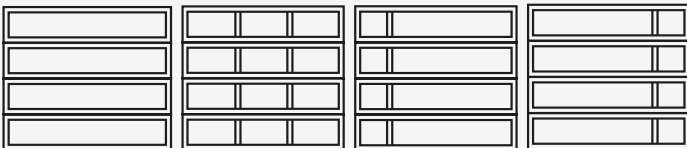

Door of 9' to 12' 2"



Door of 12' 3" to 16' 2"



## Door components

### SIDE VIEW

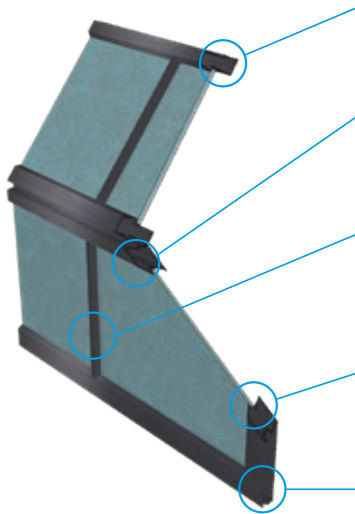

#### FRAME

Lightweight and robust aluminum frame.

#### HORIZONTAL JOINT

Provides better sealing. Prevents air and water infiltration between panel sections.

#### VERTICAL MULLION

Location of the vertical mullion may be modified to match the desired architectural appearance.

#### GLAZING BEAD

Assembled at 90 degrees, these PVC moldings frame the glass, making glass replacement simpler and faster. The glazing bead ensures that the glass is held firmly against a sealant, creating a durable, watertight barrier that prevents air and water infiltration.

#### WEATHER SEAL

Arctic-grade, TPE ultra-durable U-shaped weather seal inserted into the bottom panel. It remains flexible at low temperatures and forms a perfect seal against your floor for maximum weather resistance.

## Available options

### KICK-PROOF PANEL



### GLASS SELECTION

Clear      Opaque satin      Dark tinted

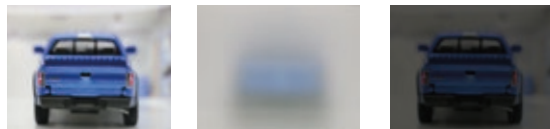

Different glass and polycarbonate options are available on the next page.



## Technical Information

Panel height	Nominal values: 18, 21 and 24 inches (45, 53 and 60 cm)
Panel width	Up to 24 feet (7.32 m)
Thickness	44.45 mm (1 3/4")
Metal thickness	1.73 mm (0.068") Aluminum - Alloy 6063 T5
Paint	Duracron LG black (K90212) or white (K1285) Clear anodize
Texture	Smooth
Weight	Varies depending on the selected glass
Mullion width	40.64 mm (1.6")
Thermos thickness	17.5 mm (0.69")
Reinforcement Moulding	Doors 14' and above (4.26 m)
Double hinge	Doors 14' and above (4.26 m)
Double top and bottom	Doors 15' and above (4.57 m)
T-Reinforcement	Doors 17' and above (5.18 m)

## Available Colors

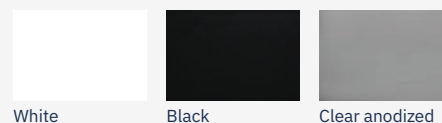

Since anodizing is not an exact science, variations in shade may occur.

Please note that the colors shown in the photo may slightly differ from the actual color of the door.



**GENTEK**

Available in the color of your choice.  
\*Additional charges apply.

# WINDOWS

With its modern and contemporary design, the **NEO** frame is an aesthetically pleasing choice that is both subtle and refined. It will enhance the overall look of your projects while seamlessly blending with a variety of architectural styles.



25 X 13  
41 X 13  
20 X 14

URBAN FRAME  
For custom sizes



Available in our standard colors or in custom colors.



# GLASS SELECTION

## TYPE OF GLASS



THERMOS



LOW-E THERMOS



SINGLE PAIN

## POLYCARBONATE



TRIPLE CLEAR

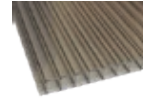

TRIPLE BRONZE

Available for the full view door only.

<p><b>3 MM</b></p> <p><b>CLEAR</b></p> <p>Privacy 0%</p>	<p><b>3 MM</b></p> <p><b>GRAY</b></p> <p>Privacy 20%</p>	<p><b>3 MM</b></p> <p><b>BRONZE</b></p> <p>Privacy 20%</p>	<p><b>3 MM</b></p> <p><b>PIN HEAD</b></p> <p>Privacy 80%</p>
<p><b>3 MM</b></p> <p><b>OPAQUE SATIN</b></p> <p>Privacy 80%</p>	<p><b>3 MM</b>   <b>4 MM</b></p> <p><b>BLACK SATIN</b></p> <p>Privacy 80%</p>	<p><b>4 MM</b></p> <p><b>DARK TINTED</b></p> <p>Privacy 40%</p>	<p><b>5 MM</b></p> <p><b>GLUE CHIP</b></p> <p>Privacy 60%</p>
<p><b>6 MM</b></p> <p><b>MIRROPANE GRAY</b> <small>*(Mirror)</small></p> <p>Privacy 90%</p>	<p><b>6 MM</b></p> <p><b>BRONZE</b></p> <p>Privacy 40%</p>	<p><b>6 MM</b></p> <p><b>SUPERGRAY</b> <small>*(Available in tempered glass only)</small></p> <p>Privacy 80%</p>	<p><b>6 MM</b></p> <p><b>GRAY</b></p> <p>Privacy 40%</p>

Photos may differ slightly from actual glass tints. Several other glass options available.

# WEATHER SEALS

Weather seals minimize air loss and prevent water infiltration, which improves energy efficiency.

## COMMERCIAL



Made of natural aluminum, rigid and durable, with a high-quality arctic-grade dual flexible blade, it is the top choice for commercial, industrial, and agricultural projects. Easy to install, it provides effective weather protection and a raw industrial look.

Dual flexible blade available in black or white. The aluminum can be painted in custom colors.



## PVC

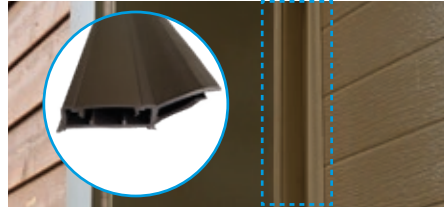

This rigid PVC weather seal, featuring a dual arctic-grade flexible blade, provides excellent protection against the elements, while its availability in multiple colors ensures a seamless finish with your garage door.

Available in white, black, commercial brown, slate, pebble, sand, or in custom colors.



## HYBRID

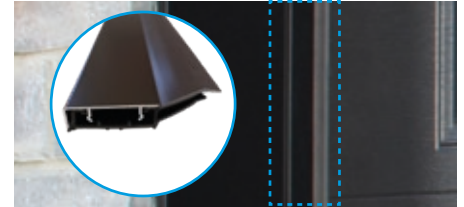

Featuring a rigid PVC base, an arctic-grade dual flexible blade, and a matching aluminum cover, it offers excellent resistance to heat-induced warping, while adding an elegant, high-end touch to your project.

Available in white, black, commercial brown, slate, iron ore, or in custom colors.



# OPERATORS

No matter your project, we offer a wide range of commercial operators designed to meet your needs. The choice of operators mainly depends on the opening frequency and surface area of the door.

- All our operators are **UL 325 certified** for optimal safety.
- Available in various power levels and voltages, with optional remote control.
- All our operators are covered by the manufacturer's warranty.



# TRACK CONFIGURATION

Whatever the available space, we have the right system adapted to your application.



Standard



Sloped roof



High lift

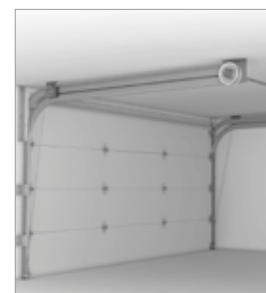

Low headroom

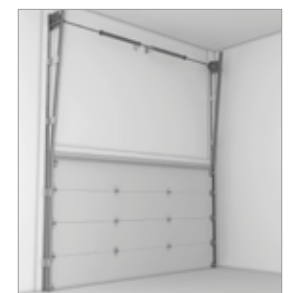

Full vertical lift



BUILT FOR STRENGTH  
CREATED TO PERFORM



Multi-Groove

**GARAGE DOOR MANUFACTURER**  
**PERFORMANCE MADE SIMPLE**

**DISCOVER MORE INFORMATION**  
**WITH OUR DOCUMENTATION CENTER**

**HEAD OFFICE - FACTORY**  
610, Principale St  
Val-Alain (QC)  
G0S 3H0

**FACTORY (NB)**  
62, Saint-André Rd  
Saint-André (NB)  
E3Y 3S9

**DISTRIBUTION CENTER**  
10020, Mirabeau St  
Anjou (QC)  
H1J 1T6

**FACTORY (ON)**  
1430 Tessier St  
Hawkesbury (ON)  
K6A 3W5



**GAREX.COM**

**CONTACT US**  
1 800 748-3317  
info@garex.com



**SCAN ME!**  
WITH YOUR CAMERA



FOLLOW US!